

NUCLEAR PHYSICS

BY
DR. UPAKUL MAHANTA,

Asst.Prof., Department of Physics,
Bhattadev University



BSc. 6th Semester Class notes

Contents

Dr. Upakul Mahanta, Department of Physics, Bhattadev University

Chapter 1

Nuclear Forces and Stability of Nuclei

Teacher: Any co-curricular activities?

Student: Sir, "Dramatics"

Teacher: Really...! What did you do?

Student: Sir, acted like I understand NUCLEAR PHYSICS.....

1.1 Introduction

Everything we can see in the night time sky is made of nuclear matter. Nuclear physics describes how the Sun generates the energy we need for life on Earth, how all the atoms in your body were made in stars and what happens in stars when they die. Nuclear physics research tries to answer the fundamental questions:

Where Do We Come From? What Are We? Where Are We Going?

Nuclear physics is the field of physics that studies atomic nuclei and their constituents and interactions. Other forms of nuclear matter are also studied. Nuclear physics should not be confused with atomic physics, which studies the atom as a whole, including its electrons. The history of nuclear physics as a discipline starts with the discovery of radioactivity by Henri Becquerel in 1896 while investigating phosphorescence in uranium salts. In the years that followed, radioactivity was extensively investigated, notably by Marie and Pierre Curie as well as by Ernest Rutherford and his collaborators. By the turn of the century physicists had also discovered three types of radiation emanating from atoms, which they named alpha, beta, and gamma radiation. The 1903 Nobel Prize in Physics was awarded jointly to Becquerel for his discovery and to Marie and Pierre Curie for their subsequent research into radioactivity. Rutherford was awarded the Nobel Prize in Chemistry in 1908 for his "investigations into the disintegration of the elements and the chemistry of radioactive substances". The key experiment behind this announcement was performed in 1910 at the University of Manchester: Ernest Rutherford's team performed a remarkable experiment in which Geiger and Marsden under Rutherford's supervision fired alpha particles (helium nuclei) at a thin film of gold foil. Rutherford's analysis of the data in 1911, led to the Rutherford model of the atom, in which the atom had a very small, very dense nucleus containing most of its mass, and consisting of heavy positively charged particles with embedded electrons in order to balance out the charge. That's where the entire things start developing out.

1.2 Fundamental Forces of Nature:

As you sit on your chair, reading this article, with your laptop or desktop and your android phone nearby, you may be unaware of the many forces acting upon you. A force is defined as a push or pull that changes an object's state of motion or causes the object to deform. Newton defined a force as anything that caused an object to accelerate according to $F = ma$, where F is force, m is mass and a is acceleration. The familiar force of gravity pulls you down into your seat, toward the Earth's center. You feel it as your weight. Why don't you fall through your seat? Well, another force, electromagnetism, holds the atoms of your seat together, preventing your atoms from intruding on those of your seat. The remaining two forces work at the atomic level, which we never feel, despite being made of atoms. The strong force holds the nucleus together. Lastly, the weak force is responsible for radioactive decay, specifically, beta decay where a neutron within the nucleus changes into a proton and an electron, which is ejected from the nucleus. Thus there are four fundamental forces present in nature. Let's now become a bit more technical about these forces

1. Strong force (also known as strong nuclear force:)

The strong interaction is very strong, but very short-ranged (order is 10^{-15} m). It is responsible for holding the nuclei of atoms together. It is basically attractive, but can be effectively repulsive in some circumstances. Mesons are the force carrier for it in case of nucleon (ie protons and neutrons) and Gluons are the force carrier in the case of quarks.

Thus even the quarks inside of the protons and neutrons are bound together by the exchange of the strong nuclear force. The relative strength is 1. Time frame for them is 10^{-23} sec. It obeys all the conservation rules. Isospin (a hypothetical concept) is responsible for this force. This force is charge independent, then spin dependent and also it always saturates.

2. Electro-magnetic force:

The electromagnetic force causes electric and magnetic effects such as the repulsion between like electrical charges or the interaction of bar magnets. It is long-ranged, but much weaker than the strong force. It can be attractive or repulsive, and acts only between pieces of matter carrying electrical charge. Electricity, magnetism, and light are all produced by this force. Relative strength is in the order of 0.01. Time frame for this is 10^{-16} to 10^{-21} sec. All conservation rule are obeyed except the isospin. Charge is responsible for this force. Photons are the force carriers.

3. Weak force:

The weak force is responsible for radioactive decay and neutrino interactions. It has a very short range and. As its name indicates, it is very weak. The weak force causes Beta decay ie. the conversion of a neutron into a proton, an electron and an antineutrino. Relative strength is in the order of 10^{-10} . Time frame for interaction is 10^{-7} to 10^{-10} sec. Many conservation rule is violated. Spin is responsible for this force. Vector bosons (Z^0, W^+, W^-) are the force carriers.

4. Gravitational force:

The gravitational force is weak, but very long ranged. Furthermore, it is always attractive. It acts between any two pieces of matter in the Universe since mass is responsible for this force. Relative strength is 10^{-40} . Force is mediated by a hypothetical graviton (a spin 2 particle).

1.3 Nuclear terminology:

Nuclei are specified by:

Z: - atomic number that is the number of protons,

N: - neutron number that is the number of neutrons,

A: - mass number that is the number of nucleons, so that A is $Z + N$. We will also refer to A as the nucleon number. The charge on the nucleus is Ze , where e is the absolute value of the electric charge on the electron. Nuclei with combinations of these three numbers are also called nuclides and are written ${}_Z X^A$ where X is the chemical symbol for the element. Some other common nomenclature is:

Table 1.1: Nuclear terminologies

| Word | Definition | Example |
|---------|--------------------------------------------------------------------------|---------------------------------|
| Nuclide | A nuclear species | |
| Isotope | Nuclei with same number of protons | ${}_6 C^{12}$ & ${}_6 C^{13}$ |
| Isotone | Nuclei with same number of neutrons | ${}_6 C^{12}$ & ${}_7 N^{13}$ |
| Isobar | Nuclei with same mass number | ${}_6 C^{14}$ & ${}_7 N^{14}$ |
| Isomer | Nuclei with same number of protons & neutons but with different energies | ${}_9 F^{19}$ & $[_9 F^{19}]^*$ |

See the star (★) mark actually shows that particular nucleus is at higher energy level than the other.

NOTE: If you people are finding it difficult to memorize here is a trick. **Isotope**. See **p** for proton. Thus same number of protons. Similarly **Isotone**. **n** is for neutron, same number of neutrons. **Isobar**. **a** is for A (mass number) nuclei with same mass numbers. However for **Isomer**, **e** is for energy but here the energy of the nuclei is different (not same like earlier cases).

• Some other important terms:

• **Atomic Mass Unit (amu):** An atomic mass unit is defined as precisely $\frac{1}{12}$ th the mass of an atom of ${}_6 C^{12}$. In imprecise terms, one amu is the average of the proton rest mass and the neutron rest mass (Rest Mass! Go back to your 4th semester's special relativity classes). This is approximately 1.67377×10^{-27} kilogram (kg).

$$1 \text{ amu} = 1.66054 \times 10^{-27} \text{ kg}$$

Now two basic data (! Always remember these two.)

Mass of proton= 1.007276 amu

Mass of neutron= 1.008665 amu

Mass of electron= 0.00055 amu

• **Mass Defect:** Mass defect refers to the difference in mass between of a nucleus and the sum of the masses of the protons, neutrons that is its constituent particles. Another alternative way of saying the same thing is the difference between the mass of an isotope and its mass number. Well to be honest and in simple terms what you will found is that the actual mass of the nucleus is always going to be different than the sum of the individual mass of the total number of neutrons and protons. To put in a mathematical way

$$\Delta m = (n_{prot}m_{prot} + n_{neut}m_{neut}) - M$$

where 'n's are numbers, 'm's are masses and M is mass of the formed nucleus.

• **Binding energy:** Nuclear binding energy is the minimum energy that would be required to disassemble the nucleus into its component parts. These component parts are ofcourse neutrons and protons. The binding energy is always a positive number, and thus we need to spend energy in moving the nucleons away from each other (attracted by nuclear force). Other way of saying the same thing is that it's the amount of energy that has got utilised while holding the nucleons together inside the nucleus. Now where does this energy come from? Our authority Albert Einstein had the last laugh. His simple innocent looking formula $E = mc^2$, describing the equivalence of energy and mass says that adding energy increases the mass (both weight and inertia), whereas removing energy decreases the mass. It is not advisable to talk about mass being converted to energy or similar expressions. It is better to say that, in measuring an objects mass, we are determining its energy. Suddenly people pointed their fingers towards the mass defect. They said the mass defect times c squared is the energy that holds the nucleus which is nothing but the binding energy. Mathematically

$$\Delta E = \Delta m \times c^2$$

Let's now find how much 1 amu does in MeV corresponds to. This oftens comes in your exam with 2 marks. Here is how we do it. Well obviously using Einstein's formula $E = mc^2$

$$\begin{aligned} E &= mc^2 \\ &= 1.6605 \times 10^{-27} \text{ kg} \times (2.9979 \times 10^8)^2 \text{ (m/sec)}^2 \\ &= 15.0639 \times 10^{-11} \text{ J} \\ &= \frac{15.0639 \times 10^{-11} \text{ J}}{1.6022 \times 10^{-13} \frac{\text{J}}{\text{MeV}}} \\ &= 931.5 \text{ MeV} \end{aligned}$$

As we know that $1.6022 \times 10^{-19} \text{ J} = 1\text{eV}$. Now paste this in your memory chip.

$$\boxed{1 \text{ amu} = 931.5 \text{ MeV}}$$

Let us take an example for the α -particle which is the ${}_2\text{He}^4$ nucleus. This nucleus contains 2 protons and 2 neutrons. Now sum of the masses of the indivisual constituents can be calculated as follows

$$\begin{aligned} M' &= 2 \times 1.007276 \text{ amu} + 2 \times 1.008665 \text{ amu} \\ &= 4.031882 \text{ amu} \end{aligned}$$

And the mass (M) of the α -particle is 4.001506 amu. That means we are in a position to calculate the mass defect of the nucleus which is

$$\begin{aligned} \Delta m &= 4.031882 \text{ amu} - 4.001506 \text{ amu} \\ &= 0.030376 \text{ amu} \end{aligned}$$

Hence the binding energy will be

$$\begin{aligned} \Delta E &= \Delta m \times 931.5 \text{ MeV/amu} \\ &= 0.030376 \text{ amu} \times 931.5 \text{ MeV/amu} \\ &= 28.29 \text{ MeV} \end{aligned}$$

Well this is the amount of energy gets released from one single He^4 nucleus. Now if I take 4 gms of He^4 it will contain Avogadro's number of nuclei. Then the release of energy will be $28.29 \text{ MeV} \times 6.023 \times 10^{23} \text{ Mol}^{-1}$ which is almost, after doing a little bit of algebra, 2.56×10^6 mega joules of energy. How tremendous this energy is? Well, it will heat up about 3 million gallons of water from room temperature to boiling point. Can you imagine just about 4 gms of He^4 has the ability to heat up about 2 million gallons of water? Pretty impressive, right?

1.4 Nuclear stability:

Nuclear Stability is a concept that helps to identify the stability of a nuclear species. For example two isotope can have different abundance means their stability is different in different ways. But before we move on let us think about the following question.

Why does every nucleus wants to get stability? Think of yourself when you are tired and ready for sleep. In this case you will most likely just stay put and not do anything as if you don't have anything to spare. The major underlying reason is: "Nature seeks the lowest energy stat". In the lowest energy state, things are most stable and less likely to change. One way to view this is that energy makes things happen. If a nucleus is at its lowest energy state, it has no energy to spare to make a change occur. The following information that talks about stability is all based on the nucleus tending towards the lowest energy state. Unstable nuclei will try and become stable by getting to a lower energy state. They will typically do this by emitting some form of radioactivity and change in the process.

The main factors that determine nuclear stability are

1. the neutron-proton ratio
2. the packing fraction of the nucleus.
3. the binding energy per unit nucleon

Let us have some basic ideas about what these are actually.

• The neutron-proton ratio:

The neutron-proton ratio (N/Z ratio or nuclear ratio) of an atomic nucleus is the ratio of its number of neutrons to its number of protons which is a principal factor for determining whether a nucleus is stable. Elements with (Z < 20) are lighter and these elements' nuclei and have a ratio of 1:1 and prefer to have the same amount of protons and neutrons amongst stable and naturally occurring nuclei. But for heavier nuclei this ratio generally increases as the atomic number increases. This is because electrical repulsive forces between protons scale with distance differently than strong nuclear force attractions. In particular, most pairs of protons in large nuclei are far enough, then the electrical repulsion dominates over the strong nuclear force, and thus instability increases. This means if the nucleus has to be still holding up then more number of neutrons will be needed just to give more number of attractive forces in the nuclear core as the neutrons are chargeless. Thus N/Z ratio will become more than 1 for heavier nuclei. The graph in the right side is what I am saying

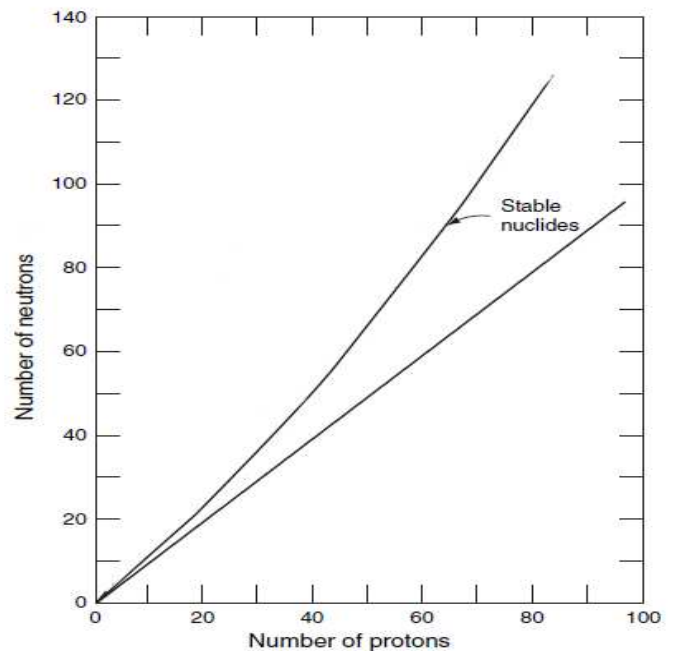

• Packing Fraction:

It is defined as mass defect per unit nucleon. The value of packing fraction depends upon the manner of packing of the nucleons with in the nucleus. It's value can be negative, positive or even zero. A positive packing fraction describes a tendency towards instability. A negative packing fraction means isotopic mass is less than actual mass number indicates stability of the nucleus. From the figure it is clear that the packing fraction beyond mass number 200 becomes positive and increases with increase in mass number. In general, lower the packing fraction, greater is the binding energy per nucleon and hence greater is the stability. Mathematically it is defined as

$$p_f = \frac{\text{IsotopicMass} - \text{MassNumber}}{\text{MassNumber}} \times 10^4$$

• Binding Energy per unit nucleon:

Well the binding energy curve is obtained by dividing the total nuclear binding energy by the number of nucleons. As

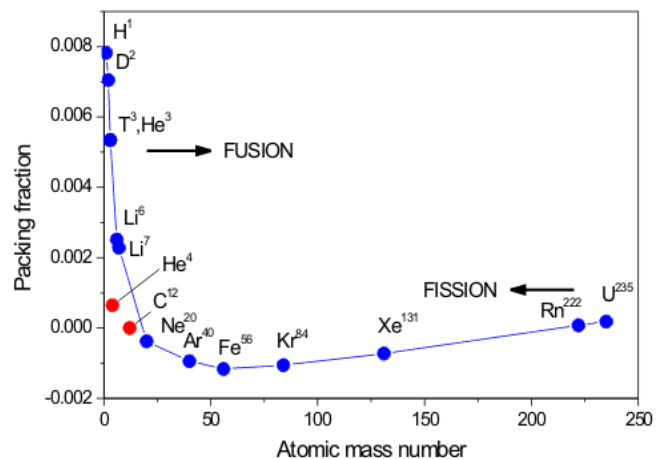

simple as that! However the term binding energy, a rather confusing because you might have often thought that this means that energy is required to bind nucleons together. As with chemical bonds, this is the opposite of the truth. Energy is needed to break bonds. But for us it is actually the measure of stability of the nucleus. Larger the binding energy per nucleon, the more stable the nucleus is and the greater the work that must be done to remove the nucleon from the nucleus. The next graph shows the pattern of BE/A for all the nuclei sitting in the periodic table.

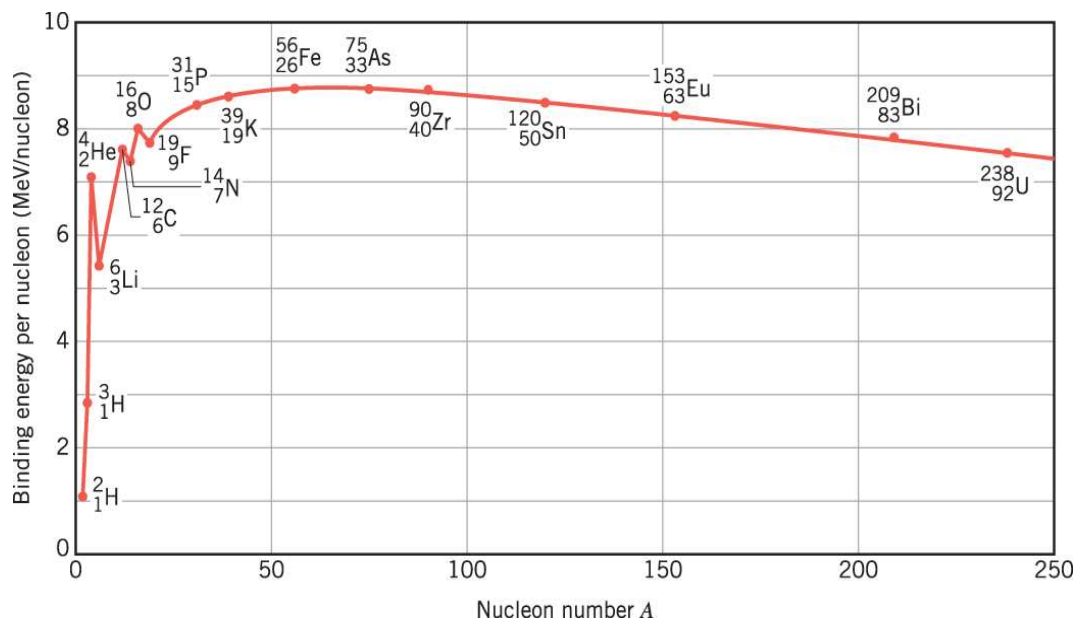

Figure 1.1: Graph of Binding energy per unit nucleon vs mass number.

Important features of the graph:

Few things we can interpret from the above graph which are indeed very important observation. Following are those

1. Excluding the lighter nuclei, the average binding energy per nucleon is about 8 MeV.
2. The maximum binding energy per nucleon occurs at around mass number $A = 50$, and corresponds to the most stable nuclei. Iron nucleus Fe^{56} is located close to the peak with a binding energy per nucleon value of approximately 8.8 MeV. Its one of the most stable nuclides that exist.
3. Nuclei with very low or very high mass numbers have lesser binding energy per nucleon and are less stable because the lesser the binding energy per nucleon, the easier it is to separate the nucleus into its constituent nucleons.

Q. Explain nuclear fusion from the binding energy curve? (Often comes in your final exam)

Answer:

The fact that there is a peak in the binding energy curve in the region of stability near iron means that nuclei with low mass numbers may undergo nuclear fusion, where light nuclei are joined together under certain conditions so that the final product may have a greater binding energy per nucleon. Let's have an idea what I mean by that of course with an example.

H^2 has a binding energy of roughly 1.12 MeV per nucleon. Since the reactants in our equation have a total mass of 4 amu, the total binding energy for two H^2 nuclei is: $4 \times 1.12 \text{ MeV} = 4.48 \text{ MeV}$. The product of the reaction, He^4 , has a binding energy of roughly 7.08 MeV per nucleon. This gives us a total binding energy of: $4 \times 7.08 \text{ MeV} = 28.32 \text{ MeV}$. Subtracting the initial binding energy from the final binding energy give us: $28.32 \text{ MeV} - 4.48 \text{ MeV} = 23.84 \text{ MeV}$ which is the amount of energy given off in the fusion. A very destructive indeed....!

Q. Explain nuclear fission from the binding energy curve? (Also comes in your final exam)

Answer:

Nuclei with high mass numbers may undergo nuclear fission, where the nucleus split to give two daughter nuclei with the release of neutrons. Remember the splitting of Uranium to Barium and Krypton and another three neutrons (HS 2nd year). The daughter nuclei (ie Ba & Kr) will possess a greater binding energy per nucleon as their position will be towards the left of the binding energy curve close to Fe^{56} . Thus fission also increases the binding energies of daughter nuclei.

1.4.1 Odd-Even rule of nuclear stability:

We want to know why there is a radioactivity. What makes the nucleus a stable one? There are no concrete theories to explain this, but there are only general observations based on the available stable isotopes. It appears that neutron to proton (N/Z) ratio is the dominant factor in nuclear stability. This ratio is close to 1 for atoms of elements with low atomic number and increases as the atomic number increases. Then how do we predict the nuclear stability? One of

the simplest ways of predicting the nuclear stability is based on whether nucleus contains odd/even number of protons and neutrons:

Table 1.2: Odd-Even rule of nuclear stability

| Protons | Neutrons | No. of Stable Nuclides | Stability |
|---------|----------|------------------------|--------------|
| Odd | Odd | 4 | least stable |
| Odd | Even | 50 | ↓ |
| Even | Odd | 57 | ↓ |
| Even | Even | 168 | most stable |

catch of this table:

- Nuclides containing odd numbers of both protons and neutrons are the least stable means more radioactive.
- Nuclides containing even numbers of both protons and neutrons are most stable means less radioactive.
- Nuclides contain odd numbers of protons and even numbers of neutrons are less stable than nuclides containing even numbers of protons and odd numbers of neutrons.

Q. Based on the even-odd rule presented above, predict which one would you expect to be radioactive in each pair?

- (a) ${}_8O^{16}$ & ${}_8O^{17}$ (b) ${}_{17}Cl^{35}$ & ${}_{17}Cl^{36}$ (c) ${}_{10}Ne^{20}$ & ${}_{10}Ne^{17}$ (d) ${}_{20}Ca^{40}$ & ${}_{20}Ca^{45}$ (e) ${}_{80}Hg^{195}$ & ${}_{80}Hg^{196}$

Answer:

(a) The ${}_8O^{16}$ contains 8 protons and 8 neutrons (even-even) and the ${}_8O^{17}$ contains 8 protons and 9 neutrons (even-odd). Therefore, ${}_8O^{17}$ is radioactive.

(b) The ${}_{17}Cl^{35}$ has 17 protons and 18 neutrons (odd-even) and the ${}_{17}Cl^{36}$ has 17 protons and 19 neutrons (odd-odd). Hence, ${}_{17}Cl^{36}$ is radioactive.

(c) The ${}_{10}Ne^{20}$ contains 10 protons and 10 neutrons (even-even) and the ${}_{10}Ne^{17}$ contains 10 protons and 7 neutrons (even-odd). Therefore, ${}_{10}Ne^{17}$ is radioactive.

(d) The ${}_{20}Ca^{40}$ has even-even situation and ${}_{20}Ca^{45}$ has even-odd situation. Thus, ${}_{20}Ca^{45}$ is radioactive.

(e) The ${}_{80}Hg^{195}$ has even number of protons and odd number of neutrons and the ${}_{80}Hg^{196}$ has even number of protons and even number of neutrons. Therefore, ${}_{80}Hg^{195}$ is radioactive.

1.5 Nuclear Structure and Dimensions:

The radius of a nucleus is not well defined, since we cannot describe a nucleus as a rigid sphere with a given radius. However, we can still have a practical definition for the range at which the density of the nucleons inside a nucleus approximate our simple model of a sphere for many experimental situations (e.g. in scattering experiments). A simple formula that links the nucleus radius to the mass number is the *empirical radius formula*

$$R = R_0 A^{\frac{1}{3}}$$

where $R_0 = 1.12 \text{ fm}$ and $1 \text{ fm} = 10^{-15} \text{ m}$. But from this we actually arrive at a very fundamental conclusion which may also come in your exam with 2 marks.

Q. Show that nuclear density is constant for all nuclei? (Also comes in your final exam)

Answer:

We know that

$$R = R_0 A^{\frac{1}{3}}$$

$$\frac{4}{3} \pi R^3 = \frac{4}{3} \pi R_0^3 A$$

$$Vol. = \frac{4}{3} \pi R_0^3 A$$

Therefore density ρ is

$$\rho = \frac{A}{\frac{4}{3} \pi R_0^3 A} = \frac{1}{\frac{4}{3} \pi R_0^3}$$

which is constant term. Thus it can be shown that the nuclear density is constant for all nuclei.

1.6 Yukawa's meson theory:

"The window of my little world opened out only to the garden of science, but from that window, enough light streamed in." Heidiki Yukawa.

During 1934, Yukawa often lay awake at night thinking about this problem. He had a notebook at the side of his bed, so that he could record any thoughts that he might have. Sometimes he believed that he was close to a solution, but when he thought through his ideas in the morning, they proved to be worthless. One night, however, an insight came to him -there must be a relationship between the intensity of the force and the mass of the binding particle. That makes Yukawa to put forward the following proposals

- The nuclear binding force is transmitted by the exchange of massive charged particles (the heavy quanta).
- The range of the force is inversely proportional to the mass of the quantum.
- The heavy quanta are unstable, decaying via the weak interaction.

On the basis of this idea, Yukawa calculated that this binding particle would have a mass 200 times that of an electron. Shortly after Yukawa's prediction a particle with almost precisely this mass was discovered in cosmic ray phenomena. It looked at first that Yukawa had been uncannily accurate, but there were problems with the particle found in the cosmic ray records. Although its mass was 207 times that of an electron, it was a fermion with half-integral spin rather than a boson of integral spin as Yukawa predicted for the carrier of the strong nuclear force. It turned out that the cosmic ray particle was not the particle Yukawa was talking about. Later three particles with masses approximately 270 times that of an electron were found. These did have the properties that Yukawa had predicted. One was of positive charge, one of negative charge and one was neutral. He called this particle a **meson**. He was the first person to theorize that the strong nuclear force between protons and neutrons was mediated by mesons, specifically the pion. The discovery of the pion in 1947 resulted in a Nobel Prize for Yukawa in 1949.

According to the Yukawa's theory every nucleon emits and reabsorbs pions continuously. There are three types of pions. Namely charged pions (π^+ , π^-) and neutral pion (π^0). Since these are massive quanta they carry momentum with them. The associated transfer of momentum is equivalent to an action of a force. Left figure below shows a proton sends a neutral pion to another proton and thus the repulsive information gets carried out. Middle figure shows neutron sends a neutral pion to another neutron and thus the attractive information gets carried out and the right figure a proton sends a +ve pion and itself becomes a neutron. If a nearby neutron absorbs that pion then it becomes a proton. Then that proton can do the same thing. Then that proton can do the same thing. An exchange of -ve pion is not possible. This exchange can be likened to constantly hitting a ping-pong ball or a tennis ball back and forth between two people. As long as this meson exchange can happen, the strong force is able to hold the participating nucleons. But the nucleons must be extremely close together in order for this exchange to happen.

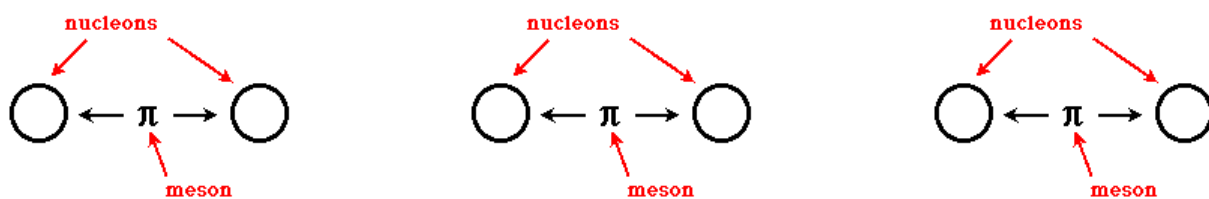

Q. Write a short note on Yukawa's meson theory. 3 marks

Chapter 2

Radioactivity: α , β and γ -decay

In Japan, radiation created monsters (Godzilla), in America radiation created superheros (Superman), here nothing, we are cool..!

2.1 Introduction

In the last chapter we spoke about stability of nuclei. But not all the nuclei are stable. What does that lead to? This chapter will focus on what the unstable nuclei will do? Well it's just simple. They will decay.

Because the nucleus experiences the intense conflict between the two strongest forces in nature, it should not be surprising that there are many nuclear isotopes which are unstable and emit some kind of radiation. Radioactive decay (also known as **nuclear decay** or **radioactivity**) is the process by which an unstable atomic nucleus loses energy by emitting radiation, such as an α particle, β particle or γ particle. To put it in another way the atomic nuclei that dont have enough binding energy to hold the nucleus together due to an excess of either protons or neutrons are going to disintegrate.

Let's have some history. Radioactivity was discovered in 1896 by the French scientist Henri Becquerel, while working with phosphorescent materials. These materials glow in the dark after exposure to light, and he suspected that the glow produced in cathode ray tubes by X-rays might be associated with phosphorescence. He wrapped a photographic plate in black paper and placed various phosphorescent salts on it. All results were negative until he used uranium salts. The uranium salts caused a blackening of the plate in spite of the plate being wrapped in black paper. It soon became clear that the blackening was also produced by non-phosphorescent salts of uranium and metallic uranium. These radiations were given the name "**Becquerel Rays**".

2.2 Properties of Radioactivity:

The modes and characteristic energies that comprise the decay scheme for each radioisotope are specific. If instrumentation is sufficiently sensitive, it is possible to identify which isotopes are present in a sample. But that will cost lot of your money. Radioactive decay will change one nucleus to another if the product nucleus has a greater nuclear binding energy than the initial decaying nucleus. The difference in binding energy (comparing the before and after states) determines which decays are energetically possible and which are not. But let me put all the information about radioactivity in a straight forward form.

- It is entirely a nuclear phenomenon is due to the instability of the nucleus. (*Remember the N/Z ratio*)
- It is a spontaneous and irreversible process. (*Well that's obviously the thing going to be, once it's emitted it's emitted, you can never rerun it back.*)
- It is independent of external factors such as pressure, temperature, state of substance, electrical field, magnetic field, catalyst etc. (*Take a sample, push it, shake it do anything you want to do! The nucleus will show extreme disrespect to your activity*)
- A radioactive element emits α , β or γ radiations which probabilistic in nature and does not depend on the age of the nucleus or how it was created. (*You never can predict when a certain nuclei is going to emit a particle.*)
- A radioactive element does not emit α and β particles simultaneously. (*Two bullets are fired from a gun simultaneously right! Well that's impossible. Common sense.*)
- The original radioactive nucleus or element is called a parent element and the new element formed is known as daughter element. (*That's the terminology we use*)
- It's a first order reaction. (*means it will need infinite time to finish*)
- The physical and chemical properties of daughter element are different than that of the parent element. (*I will tell you later why this is so*).

2.2.1 Artificial and Natural Radioactivity

The harsh reality is that radioactivity has not been invented by man; it has been there, existing in the universe since time immemorial. The of nuclei which takes place in nature, is called natural radioactivity. However there are elements beyond uranium which have been artificially made. They are called the transuranium elements which can be made to disintegrate into other nuclei by colliding with slow moving neutrons. This is called artificial radioactivity. Thus it is customary to check the difference between these two types.

Table 2.1: Difference between Artificial and Natural Radioactivity

| Natural Radioactivity | Artificial Radioactivity |
|----------------------------------------------------------|-----------------------------------------------------------------|
| 1. Radioactivity that takes place on its own in nature | 1. It is induced by man in laboratories |
| 2. Occurs in elements with atomic number greater than 82 | 2. Can be induced in elements with low atomic numbers |
| 3. It usually have long half life. | 3. This usually have short half life. |
| 4. Decay particles are α , β & γ | 4. Decay particles are α , β , $-\beta$ & γ |

Well there hasn't been a question in your exam from this table. But I request you to remember these as this is also probabilistic in nature...may or may not come in your exam.

2.2.2 Properties of α , β & γ -decay

In radioactive processes, particles or electromagnetic radiation are emitted from the nucleus. The most common forms of radiation emitted have been traditionally classified as α , β , and γ radiation. Let's now inspect the characteristics of them.

• Characteristics of α -decay

- 1 These particles are helium nuclei ${}^2_2\text{He}^4$. (*Alpha rays consist of stream of positively charged particles carrying charge of +2 units and a mass almost equal to 4 amu*)
- 2 They affect photographic plate
- 3 They are deflected only slightly towards the negative plate in electric field. They are also deflected by magnetic field. (*see they are charged and hence Lorentz force is in action*)
- 4 These particles can ionize gases. Alpha rays have maximum ionizing power. (*Again because these particles will interact with the medium as they are charged*)
- 5 They have a velocity of the order of $1 \times 10^7 \text{ms}^{-1}$.
- 6 They have very little penetrating power. (*mass is the culprit in this case*)

• Characteristics of β -decay

- 1 Beta rays are electrons ${}_{-1}e^0$. (*these rays are made up of streams of negatively charged particles with a negligible mass.*)
- 2 They affect photographic plate.
- 3 They get deflected to the maximum extent towards the positive plate in electric field. They are also deflected by magnetic field. (*Again Lorentz force*)
- 4 Their ionising power is less than that of α - rays. (*It is about one hundredth of α - particles*).
- 5 Their velocity varies with the source sometimes reaches $2.7 \times 10^8 \text{ms}^{-1}$.
- 6 Their penetration power is about 100 times more than that of α - particles. (*Since mass is too small*).

• Characteristics of γ -decay

- 1 They are electromagnetic radiations (photons) like X-rays having very short wavelength, in the range of 10^{-10} m to 10^{-13} m.
- 2 They affect photographic plate.
- 3 They are unaffected by electric and magnetic fields. (*No charge no Lorentz force*)
- 4 Their ionizing power is low, and is about one hundredth of β - particles. (*No charge no ionisation*)
- 5 Their velocity is same as that of light.
- 6 Their penetrating power is very high, about 100 times more than that of β - particles. (*since they donot interact they keep on moving moving... and moving*)

In addition, there are a couple of less common types of radioactive decay, these are as follows:

• Positron emission

Although positron emission doesnt occur with naturally occurring radioactive isotopes, it does occur naturally in a few man-made ones. A positron is essentially an electron that has a positive charge instead of a negative charge. A positron is formed when a proton in the nucleus decays into a neutron and a positively charged electron. The positron is then emitted from the nucleus.

• **Electron capture or K-capture**

Electron capture is a rare type of nuclear decay in which an electron from the innermost energy level is captured by the nucleus. This electron combines with a proton to form a neutron. The atomic number decreases by one, but the mass number stays the same. The capture of the 1s electron leaves a vacancy in the 1s orbitals. Electrons drop down to fill the vacancy, releasing energy in the X-ray portion of the electromagnetic spectrum.

2.3 Radioactive decay law:

Let's now make things quantitative. All we want to put it in a mathematical way. Calculations of the decay of radioactive nuclei are relatively straightforward, owing to the fact that there is only one fundamental law governing all decay process. This law states that the probability per unit time that a nucleus will decay is a constant, independent of time. It's a brilliant one indeed! In a radioactive material, what people have found is that the radioactive decays per unit time are directly proportional to the total number of nuclei of radioactive compounds in the sample. Through this, we can mathematically quantify the rate of radioactive decay.

$$\begin{aligned} \frac{dN}{dt} &\propto -N \\ &= -\lambda N \end{aligned}$$

where $\lambda (> 0)$ is the decay constant, of the related to the nuclei present in the sample which gives us the probability of decay per unit interval of time. Also, the number of radioactive decays dN is reducing the total number present in the sample. Convention tells us that this should be termed negative. Hence the minus sign. But here is a tricky thing. We have taken dN is the no of parent nuclei that decay between t and $t + dt$ and we have taken N as continuous variable. Thus we can rearranging the last equation as

$$\frac{dN}{N} = -\lambda dt$$

Integration of both sides then results in,

$$\int_{N_0}^N \frac{dN}{N} = - \int_0^t \lambda dt$$

As we know that if the differentiation of denominator is equal the numerator then the value of integral will be log of the denominator. Hence the last equation will yield

$$\begin{aligned} \ln \left(\frac{N}{N_0} \right) &= -\lambda t \\ \frac{N}{N_0} &= e^{-\lambda t} \\ \boxed{N} &= \boxed{N_0 e^{-\lambda t}} \end{aligned}$$

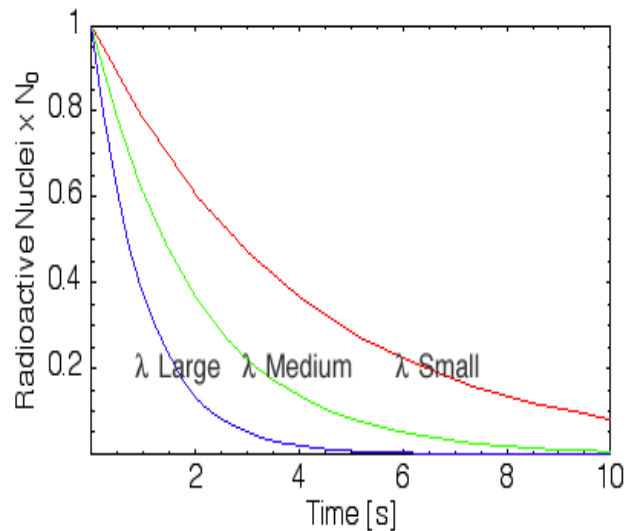

One thing we must address here is that radioactive decay is exponential. Because the mass in an isotope sample is directly related to the total number of atoms in the sample, the total mass of an isotope also decays exponentially with the same decay constant, $M(t) = M_0 e^{-\lambda t}$. Because of conservation of mass, as the total amount of the isotope decreases the total mass of produced decay products increases. One funny property of exponential decay is that the total mass of radioactive isotopes never actually reaches zero. The mass just keeps getting closer and closer to zero as the amount of time for the isotope to decay gets larger and larger. Realistically, there are only a fixed number of atoms in a radioactive sample, and so the mass of an isotope will eventually reach zero as all the nuclei decay into another element.

2.3.1 Half-life of a radioactive nucleus

As I have told you earlier that it is not possible to predict when an individual atom might decay. But it is possible to measure how long it takes for half the nuclei of a piece of radioactive material to decay. The half-life of a radioactive nucleus is one of its main features with the nature of radiations it emits. It determines how quickly it will decay and for how long we need to worry about its radiations. Half-lives can range from a fraction of a second to billions of years. For example, the half-life of carbon-14 is 5,715 years, but the half-life of francium-223 is just 20 minutes. There are two definitions of half-life, but they mean essentially the same thing. Half-life is the time taken for:

1. The number of nuclei of the radioactive isotope in a sample to halve.

2. The count rate from a sample containing the radioactive isotope to fall to half its starting level.

Either way you are correct if write in your exam. Since half-life is kind of stability in the time frame that indicates we must have some connection between the decay constant and half-life. Let's now investigate this on a mathematical ground. (*go back to your HS 2nd year book.*)

Now with a bit reorientation of the last mathematical expression we obtain

$$\ln \left(\frac{N}{N_0} \right) = -\lambda t$$

$$2.303 \log \left(\frac{N}{N_0} \right) = -\lambda t$$

using the definition of half-life at $t = T_{\frac{1}{2}}$ the initial number N_0 will be $\frac{N_0}{2}$ which is the number nuclei present at that instant. On substitution we get

$$2.303 \log \left(\frac{\frac{N_0}{2}}{N_0} \right) = -\lambda T_{\frac{1}{2}}$$

$$2.303 \log \left(\frac{1}{2} \right) = -\lambda T_{\frac{1}{2}}$$

$$-2.303 \times 0.3010 = -\lambda T_{\frac{1}{2}}$$

$$\boxed{T_{\frac{1}{2}} = \frac{0.693}{\lambda}}$$

The longer the half-life of a nucleus, the lower the radioactive activity. A nucleus with a half-life that is a million times greater than another will be a million times less radioactive. Thus half-life is a convenient way to assess the rapidity of a decay, but it should not be confused with the average life span of a radioactive nucleus.

2.3.2 Average life of a radioactive nucleus

Radioactive atoms disintegrate spontaneously and it is not possible to predict which atom is going to disintegrate next which I have told you n number of times. The practical way is you take a sample of the radioactive atoms and wait for all of them to decay away, and keep track of how long each atom lasts. The atom which disintegrates at first is said to have zero (0) life and the atom which disintegrate last is said to have infinite life. That means what is the mean life of all that nuclei becomes a legitimate question. Thus the sum of all the lifetimes of the atoms, divided by the original number of nuclei, is the mean lifetime. In other words, the mean lifetime is simply the arithmetic average of the lifetimes of the individual nuclei. Thus we can put it in a mathematical way T_{avg} will be

$$T_{avg} = \frac{\int_0^{\infty} t N dt}{\int_0^{\infty} N dt}$$

You can think this as follows. Say in sample of 100 nuclei 5 lived for 1 sec, 15 lived for 2 secs, 25 lived 10 sec like that. So the event 1 sec occurred 5 times, the event 2 sec occurred 15 times and like that. Thus the number times the life-time will give the numerator and ofcourse integrated over 0 to ∞ will cover all possible values of time. Which then is getting divided by the number of nuclei present at that time. Thus we can rewrite it as

$$= \frac{\int_0^{\infty} t N_0 e^{-\lambda t} dt}{\int_0^{\infty} N_0 e^{-\lambda t} dt}$$

$$= \frac{\int_0^{\infty} t e^{-\lambda t} dt}{\int_0^{\infty} e^{-\lambda t} dt}$$

Now method of substitution we give if we replace $\lambda t = x$ then $\lambda dt = dx$ and $t = \frac{x}{\lambda}$ without effecting the limits of the integral.

$$T_{avg} = \frac{\int_0^{\infty} \frac{x}{\lambda} e^{-x} \frac{dx}{\lambda}}{\int_0^{\infty} e^{-x} \frac{dx}{\lambda}}$$

$$= \frac{1}{\lambda} \frac{\int_0^{\infty} x e^{-x} dx}{\int_0^{\infty} e^{-x} dx}$$

Do you remember Γ -function which we learned in our 2nd semester. That was $\Gamma(n) = \int_0^{\infty} x^{n-1} e^{-x} dx$. Now compare the last equation with Γ -function. Immediately you will realise that the numerator is $\Gamma(2)$ and denominator is $\Gamma(1)$ which is simply 1. Thus we get

$$\boxed{T_{avg} = \frac{1}{\lambda}}$$

• Relationship between Half-life & Average life of a radioactive nucleus

Well it's straight forward. We have

$$T_{\frac{1}{2}} = \frac{0.693}{\lambda} \quad \text{and} \quad T_{avg} = \frac{1}{\lambda}$$

Now divide on by the other you will have your answer as $T_{\frac{1}{2}} = 0.693 \times T_{avg}$. Thus the average life time is more than the half-life. Now you may think why is the difference in terms of physics. Let me put in this way. Imagine that you put 100 radioactive atoms in a box and observe them decay, one by one, until they are all gone. If you add up the lifetimes of the 100 individual atoms and divide the sum by 100, you get the average lifetime. On the other hand, the half-life is a kind of median lifetime. Half of the atoms live longer and half live shorter than this time. This is the time at which 50 of the nuclei have decayed and 50 remain in the box. Well, there are always a few Methuselah nuclei that live much longer than usual, purely by chance. Methuselah....! Don't worry just a fancy word! (*Methuselah is the man reported to have lived the longest according to the Hebrew Bible. It's also a name of a wine bottle of eight times the standard size. A full wine bottle is 750 ml I guess. Thus all I wanted say it's mnemonic for larger, bigger, longer etc....*). These nuclei pull up the average, but they have no effect on the median. Meanwhile, the shortest time that a nuclei can live is zero. There are no nuclei with negative lifetimes that could pull the average down. So the average lifetime is somewhat longer than the half life.

- Q. Derive an expression for radioactive decay law.
 - Q. Derive an expression for half life of a radioactive substance/nucleus/sample etc.
 - Q. Derive an expression for average life of a radioactive substance/nucleus/sample etc.
 - Q. Derive a relationship between half life and average life of a radioactive substance/nucleus/sample etc.
- (In this first you have derive the expression for these half and average life and then you divide. Remember that.!)

2.4 Gamow's theory of α -decay:

In the middle of 1928 a Russian theoretical physicist, Gamow, published a reinterpretation of the Geiger-Nuttall law. (I will tell you later on in details what this law is all about. In brief this law, proposed in 1912, relates the range of an alpha-particle to the half-life of the radioactive nucleus which emits it. The shorter the half-life was, the longer the range of the emitted particle.) Alpha-particles are held in the nucleus by an energy barrier and physicists had thought this barrier had to be overcome for an alpha-particle to be emitted. Gamow's interpretation involved wave mechanics to suggest the alpha-particle could 'tunnel' through the energy barrier, and that this chance of escaping was greater for higher energy particles. Hence the reason alpha decay occurs is because the nucleus has too many protons which cause excessive repulsion. In an attempt to reduce the repulsion, a Helium nucleus is emitted. The way it works is that the Helium nuclei are in constant collision with the walls of the nucleus and because of its energy and mass, there exists a nonzero probability of transmission. That is, an α -particle will tunnel out of

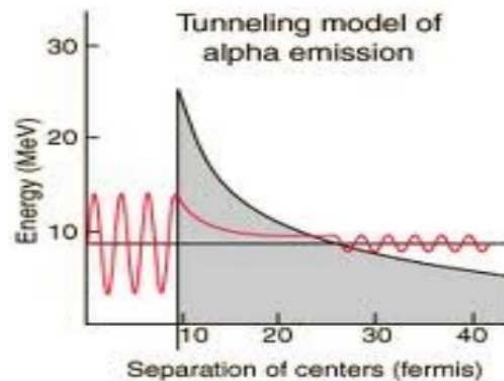
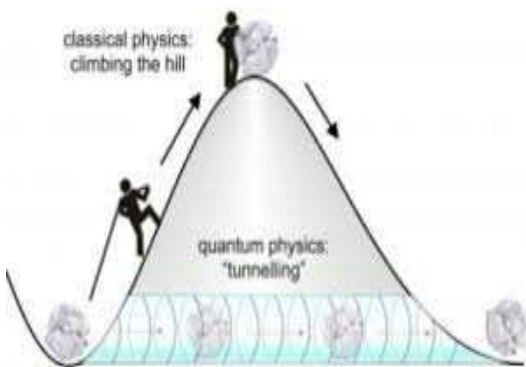

The basic assumptions made in deriving the theory is:

1. The α -particle may exist as an entity within the nucleus.
 2. Inside the nucleus the energy of the α -particle is entirely kinetic and held in the nucleus by a potential barrier.
 3. Hence a finite likelihood is always there of making a tunnel through the nucleus each time a collision occurs.
- The word in the last assumption "likelihood" has made the entire event a probabilistic one. What can be interpreted is that the α -particle constantly keeps on colliding the nuclear wall and in the it gets a chance to leak through it. To be more mathematical

If T = transmission probability of the α -particle in tunneling and ν = number of times per second the α -particle strikes the potential barrier then the decay probability per unit time (λ) is given by

$$\lambda = \nu T$$

Now this ν can be written down as

$$\nu = \frac{v}{2R_0}$$

where v is the vel. of the α -particle and R_0 is nuclear range. Now putting this value of ν in the earlier equation we get

$$\lambda = \frac{v}{2R_0} T$$

And here we will take logarithm (*why? you might ask for. Well all I can say is that we are drastically reducing our scale*) to get

$$\ln \lambda = \ln \frac{v}{2R_0} + \ln T \tag{2.1}$$

Upto here simple physics and all our problem boils down to find an expression for $\ln T$. So things will become somewhat creepy with the arise of quantum mechanics here onwards. The time independent Schrodinger equation (TISE) for a region where there is no potential (ie $V=0$) is

$$\begin{aligned} \nabla^2 \Psi_1 + \frac{\sqrt{2mE}}{\hbar} \Psi_1 &= 0 \\ \nabla^2 \Psi_1 + k_1 \Psi_1 &= 0 \end{aligned}$$

where $k_1 = \frac{\sqrt{2mE}}{\hbar}$. For 1D case ∇^2 will be $\frac{d^2}{dx^2}$ and Ψ will be function of position ie x only. Then the solutions for the above differential equation for the region 1 will be

$$\Psi_1(x) = Ae^{-ik_1x} + Be^{ik_1x}$$

For region 2 where there is a potential the TISE is given by

$$\begin{aligned} \nabla^2 \Psi_2 - \frac{\sqrt{2m(V-E)}}{\hbar} \Psi_2 &= 0 \\ \nabla^2 \Psi_2 + k_2 \Psi_2 &= 0 \end{aligned}$$

where $k_2 = \frac{\sqrt{2m(V-E)}}{\hbar}$. Hence the solution will be

$$\Psi_2(x) = Ce^{-k_2x} + De^{k_2x}$$

Again for region 3, where there is no potential the TISE is given by

$$\begin{aligned} \nabla^2 \Psi_3 + \frac{\sqrt{2mE}}{\hbar} \Psi_3 &= 0 \\ \nabla^2 \Psi_3 + k_1 \Psi_3 &= 0 \end{aligned}$$

where $k_1 = \frac{\sqrt{2mE}}{\hbar}$. Then the solutions for the above differential equation for the region 3 will be

$$\Psi_3(x) = Fe^{-ik_1x} + He^{ik_1x}$$

Well, here is a catch. Whenever you get $E > V$ in quantum mechanics the solutions of the Schrodinger's equation will be always oscillatory (Region 1 and 3) and if $E < V$ the solutions will be always exponential (Region 2). Remember that for future.

Now using the boundary condition and continuity relationship between these region for the wave-function of the α -particle we get the actual transmission probability as the following (*I am making it quiet fast. Check your notes from 5th Sem about tunneling once again.*)

$$T = \frac{\text{transmitted probability}}{\text{incident probability}} = \frac{FF^*}{AA^*} = \frac{16 e^{-2k_2 L}}{4 + \frac{K_2^2}{K_1^2}} \approx e^{-2k_2 L}$$

That's my transmission probability is a nonzero quantity. Meaning the α -particle leakage is quiet possible. *In nature, nuclear fusion in stars is possible because of quantum tunnelling. Temperature and pressure in the core of stars are insufficient for nuclei to overcome the Coulomb barrier in order to achieve a thermonuclear fusion. However, there is some probability to penetrate the barrier due to quantum tunnelling. Though the probability is very low, the extreme*

number of nuclei in a star generates a steady fusion reaction over millions or even billions of years. Now taking the logarithm in the last expression we get

$$\ln T = -2 k_2 L$$

Thus we get the 2nd part of the equation (2.1). But the L appearing in the expression is for a particle in box with dimension L . However in the case of nucleus L is not going to be. It's obvious. See the α -particle coming out of the nucleus will go forever upto where nobody knows. So I can't put it as limit like L . Hence what I will do is to integrate over a range. Thus the last expression gets modified to

$$\ln T = -2 \int_R^{R_0} k_2(r) dr \tag{2.2}$$

Now remember my k_2 was $\frac{\sqrt{2m(V-E)}}{\hbar}$ more accurately $k_2(r) = \frac{\sqrt{2m[V(r)-E]}}{\hbar}$. So all our problem lies now for figuring out the expression of $V(r)$. Now this $V(r)$ can be written down as the following

$$\begin{aligned} V(r) &= 0 & r < R_0 \\ &= \frac{2Ze^2}{4\pi\epsilon r} & r > R_0 \end{aligned}$$

where R_0 is the nuclear dimension and one thing you note that I have written here is ϵ , not ϵ_0 . Well nucleus is not empty space right! Again from diagram it is seen that at $r = R$, $V(r) = E$. See that wavy line is cutting the exponential line. That distance is my $r = R$ means we can safely write $E = \frac{2Ze^2}{4\pi\epsilon R}$ or $ER = \frac{2Ze^2}{4\pi\epsilon}$. Now we are in a position to rewrite my $k_2(r)$ as follows

$$\begin{aligned} k_2(r) &= \frac{\sqrt{2m}}{\hbar} \sqrt{\frac{2Ze^2}{4\pi\epsilon r} - E} \\ &= \frac{\sqrt{2m}}{\hbar} \sqrt{\frac{ER}{r} - E} \\ &= \frac{\sqrt{2mE}}{\hbar} \sqrt{\frac{R}{r} - 1} \end{aligned}$$

With this equation(2.2) will take shape as

$$\ln T = -2 \int_R^{R_0} \frac{\sqrt{2mE}}{\hbar} \sqrt{\frac{R}{r} - 1} dr \tag{2.3}$$

Here now we will use the method of substitution. So what Gamow did was the following. He substituted $r = R \cos^2\theta$. And hence the other things like the variables becomes as

$$\begin{aligned} r &= R \cos^2\theta \\ dr &= -2 R \cos\theta \sin\theta d\theta \end{aligned}$$

and limits of integration becomes at $r = R$, $\theta = \cos^{-1}1(c^{-1}1)$ and at $r = R_0$, $\theta = \cos^{-1}\sqrt{\frac{R_0}{R}}$ ($c^{-1}\sqrt{\frac{R_0}{R}}$). On substituting all these in equation (2.3) we get

$$\begin{aligned} \ln T &= -2 \int_{c^{-1}1}^{c^{-1}\sqrt{\frac{R_0}{R}}} \frac{\sqrt{2mE}}{\hbar} \sqrt{\sec^2\theta - 1} - 2 R \cos\theta \sin\theta d\theta \\ &= 2 \frac{\sqrt{2mE}}{\hbar} R \int_{c^{-1}1}^{c^{-1}\sqrt{\frac{R_0}{R}}} \tan\theta 2 \cos\theta \sin\theta d\theta \\ &= 2 \frac{\sqrt{2mE}}{\hbar} R \int_{c^{-1}1}^{c^{-1}\sqrt{\frac{R_0}{R}}} 2 \sin^2\theta d\theta \\ &= 2 \frac{\sqrt{2mE}}{\hbar} R \int_{c^{-1}1}^{c^{-1}\sqrt{\frac{R_0}{R}}} (1 - \cos 2\theta) d\theta \\ &= 2 \frac{\sqrt{2mE}}{\hbar} R \int_{c^{-1}1}^{c^{-1}\sqrt{\frac{R_0}{R}}} (d\theta - \cos 2\theta d\theta) \\ &= 2 \frac{\sqrt{2mE}}{\hbar} R (\theta - \cos\theta \sin\theta) \Big|_{c^{-1}1}^{c^{-1}\sqrt{\frac{R_0}{R}}} \\ &= 2 \frac{\sqrt{2mE}}{\hbar} R \left[\cos^{-1}\sqrt{\frac{R_0}{R}} - \cos \left(\cos^{-1}\sqrt{\frac{R_0}{R}} \right) \sqrt{1 - \cos^2\theta} \right] - 2 \frac{\sqrt{2mE}}{\hbar} (0 - 0 \sin\theta) \end{aligned}$$

$$\begin{aligned} \ln T &= 2 \frac{\sqrt{2mE}}{\hbar} R \left[\cos^{-1} \sqrt{\frac{R_0}{R}} - \cos \left(\cos^{-1} \sqrt{\frac{R_0}{R}} \right) \sqrt{1 - \cos \left(\cos^{-1} \sqrt{\frac{R_0}{R}} \right) \cos \left(\cos^{-1} \sqrt{\frac{R_0}{R}} \right)} \right] \\ &= 2 \frac{\sqrt{2mE}}{\hbar} R \left[\cos^{-1} \sqrt{\frac{R_0}{R}} - \sqrt{\frac{R_0}{R}} \sqrt{1 - \frac{R_0}{R}} \right] \end{aligned}$$

As the potential barrier is very very large as compared to the nuclear dimension ie RR_0 the last expression becomes drastically simplified. First $\sqrt{1 - \frac{R_0}{R}} \approx 1$ and second $\cos^{-1} \sqrt{\frac{R_0}{R}} \approx \frac{\pi}{2} - \frac{R_0}{R}$. The second one is bit tricky. Let's see how that has been achieved.

$$\begin{aligned} \cos \left(\frac{\pi}{2} - \sqrt{\frac{R_0}{R}} \right) &= \cos \left(\frac{\pi}{2} \right) \cos \left(\sqrt{\frac{R_0}{R}} \right) + \sin \left(\frac{\pi}{2} \right) \sin \left(\sqrt{\frac{R_0}{R}} \right) \\ &= 0 + 1 \times \sin \left(\sqrt{\frac{R_0}{R}} \right) \\ &= \sqrt{\frac{R_0}{R}} \\ \frac{\pi}{2} - \sqrt{\frac{R_0}{R}} &= \cos^{-1} \left(\sqrt{\frac{R_0}{R}} \right) \end{aligned}$$

Now replacing all these we get

$$\begin{aligned} \ln T &= 2 \frac{\sqrt{2mE}}{\hbar} R \left[\frac{\pi}{2} - \sqrt{\frac{R_0}{R}} - \sqrt{\frac{R_0}{R}} \times 1 \right] \\ &= 2 \frac{\sqrt{2mE}}{\hbar} R \left[\frac{\pi}{2} - 2\sqrt{\frac{R_0}{R}} \right] \\ &= 2 \frac{\sqrt{2mE}}{\hbar} \frac{2Ze^2}{4\pi\epsilon E} \left[\frac{\pi}{2} - 2\sqrt{\frac{R_0}{\frac{2Ze^2}{4\pi\epsilon E}}} \right] \\ &= \frac{\sqrt{2m}}{\hbar} \frac{Ze^2}{\pi\epsilon\sqrt{E}} \left[\frac{\pi}{2} - 2\sqrt{\frac{2\pi\epsilon E R_0}{Ze^2}} \right] \\ &= \frac{\sqrt{2m}}{\hbar} \frac{Ze^2}{\pi\epsilon\sqrt{E}} \frac{\pi}{2} - \frac{\sqrt{2m}}{\hbar} \frac{Ze^2}{\pi\epsilon\sqrt{E}} 2\sqrt{\frac{2\pi\epsilon E R_0}{Ze^2}} \\ &= \frac{\sqrt{m}}{\sqrt{2}\hbar\epsilon} Ze^2\sqrt{E} - 4 \frac{e}{\hbar} \sqrt{\frac{mZR_0}{\pi\epsilon}} \end{aligned}$$

Now putting the last expression in equation (2.1) we get

$$\ln \lambda = \ln \frac{v}{2R_0} + \frac{\sqrt{m}}{\sqrt{2}\hbar\epsilon} Ze^2\sqrt{E} - 4 \frac{e}{\hbar} \sqrt{\frac{mZR_0}{\pi\epsilon}} \quad (2.4)$$

And that's the Gamow theory for us. Well that's hell lot of a mathematics. But it's simple if you able to keep a track on it. In your exam I doubt that this will come. All I am engaged in doing my duty.

2.5 Geiger-Nuttall Law:

In Gamow's theory of α -decay we have considered an alpha particle in a nucleus as a particle in a box. The particle is in a bound state because of the presence of the strong interaction potential. It will constantly bounce from one side to the other, and due to the possibility of quantum tunneling by the wave through the potential barrier, each time it bounces, there will be a small likelihood for it to escape. But once it comes out of the nucleus how far will it travel before getting detected. Or in a way where should we place our detector so that we can have an α -particle detection. See in the Gamow's theory the disintegration constant depends on the energy of the α -particle meaning it's the energy content of α -particle because of which it will travel. Geiger and Nuttall made experimental study between the decay constant (λ) and the range of the α -particle (R_α) for different α -emitters. What they have found is the following.

For an α -emitting radioactive substance the logarithm of the decay constant (λ) and the logarithm of

the range of the α -particle (R_α) in air are in linear relation to each other.

To put it in a mathematical way

$$\log \lambda = c_1 \log R_\alpha + c_2$$

where C_1, C_2 are constants. But the above expression is an empirical one. Then again they have also showed that the range of the α -particle (R_α) also depends upon the velocity of the α -particle in air and in fact they have found it is proportional to the cubed of the velocity of the α -particle.

$$\begin{aligned} R_\alpha &\propto v^3 \\ &= k v^3 \end{aligned}$$

k is proportionality constant. Again

$$\begin{aligned} E_\alpha &= \frac{1}{2} m v^2 \\ v &= \left(\frac{2 E_\alpha}{m} \right)^{\frac{1}{2}} \\ v^3 &= \left(\frac{2 E_\alpha}{m} \right)^{\frac{3}{2}} \\ k v^3 &= k \left(\frac{2 E_\alpha}{m} \right)^{\frac{3}{2}} \\ R_\alpha &= k \left(\frac{2 E_\alpha}{m} \right)^{\frac{3}{2}} \\ \log R_\alpha &= \log \left(\frac{2k}{m} \sqrt{\frac{2k}{m}} \right) + \log E_\alpha^{\frac{3}{2}} \\ \log R_\alpha &= b_1 + \frac{3}{2} \log E_\alpha \\ c_1 \log R_\alpha + c_2 &= c_1 B_1 + c_1 \frac{3}{2} \log E_\alpha + c_2 \\ \boxed{\log \lambda} &= \boxed{A \log E_\alpha + B} \end{aligned}$$

which is the Geiger-Nuttall Law in terms of energy with the assumption that $c_1 \frac{3}{2} = A$ and $c_1 B_1 + c_2 = B$. Thus the GeigerNuttall law also relates the decay constant of a radioactive isotope with the energy of the α -particles emitted. And the thumb rule is that the short-lived nuclei emit more energetic alpha particles than long-lived ones.

2.6 Theory of β -decay

β -particles are either electrons or positrons that are emitted through a certain class of nuclear decay associated with the weak force which is characterized by relatively lengthy decay times. The name β , followed naturally as the next letter in the Greek alphabet after α , α -particles having already been discovered and named by Rutherford. But as we know that the radioactivity is entirely a nuclear phenomenon then where does this e^- come from? But can you remember that the neutron has a larger mass than the proton and is thus unstable with respect to the combination of a proton and an electron. So consider the following

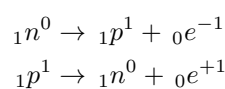

Thus inside the nucleus if these things happens it will result in a production of an e^- . Aha..! We now know that there can be an e^- production. But then again **why does that produced e^- comes out of the nucleus. I mean why it can't stay inside the nucleus?** To answer this we need to do a little bit of algebra using some celebrated principles of physics. Next is how we can show that.

We know the Heisenberg's uncertainty principle as $\Delta x \Delta p \geq \frac{h}{2\pi}$. Take Δx as positional uncertainty which is equal the to typical nuclear dimension means the e^- can be anywhere inside the nucleus. Thus $\Delta x = 10^{-15}\text{m}$. Mass of the

$e^- = 9.1 \times 10^{-31} \text{kg}$. Now do a calculation.

$$\begin{aligned}\Delta x \Delta p &= \frac{h}{2\pi} \\ \Delta x m \Delta v &= \frac{h}{2\pi} \\ \Delta v &= \frac{h}{2\pi m \Delta x} \\ &= \frac{6.63 \times 10^{-34}}{2 \times 3.1415 \times 9.1 \times 10^{-31} \times 10^{-15}} \\ &= 1.2 \times 10^{11} \text{ m sec}^{-1}\end{aligned}$$

That's velocity at which the e^- has to stay inside the nucleus which is straightway violating the Special Theory of Relativity according to which nothing can have a velocity greater the velocity of light. Thus Heisenberg's uncertainty principle along with STR will speak about why can't an e^- reside inside nucleus. Hence the e^- has to come out of course.

2.6.1 Energy release in β -decay

Take the following nuclear transmutation

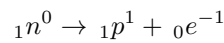

The energy release is given by the following equation

$$\begin{aligned}{}_1n^0 &\rightarrow {}_1p^1 + {}_0e^{-1} \\ Q &= [m_n - (m_p + m_{e^-})] \times 931.5 \text{ MeV} \\ &= [1.0086 - (1.0072 + 0.00055)] \times 931.5 \text{ MeV} \\ &= 0.8384 \text{ MeV}\end{aligned}$$

This is the amount of energy with which the e^- comes out of the nucleus. But to big surprise nuclear physicists have found that everytime a nucleus of the same atom undergoes a β -decay the the energy of the e^- is not the same. There is a variation of the energy of the e^- which extends from a maximum at the Q-value down to zero. What happened to the law of conservation of energy for β -decay? This observation has made the physicist to point finger to the principle conservation of energy. They even thought that the principle conservation of energy is a bogus statement or this principle is not valid at least in case of β -decay. A mortal sin for a physicist.

2.6.2 Pauli's neutrino hypothesis

Wolfgang Pauli came with a bold statement in order to save the law of conservation of energy, that ${}_1n^0 \rightarrow {}_1p^1 + {}_0e^{-1}$ is wrong transmutation equation. He argued on the basis of spin conservation which is a quantum number. What he said is the following

All the three particles in this equation are fermions with intrinsic spins $s = \pm \frac{1}{2}$. The spins of the proton and the electron can be coupled to either 0 or 1 or -1 . This simple spin algebra will never yield the half integral value on the left hand side of the equation. Therefore, we cannot balance the angular momentum in the reaction as written. So the conclusion is another fermion must be present among the products with zero charge and zero mass, a third body could then take away whatever energy was not given to the beta particle; solving that most vexing of issues. Pauli first proposed this hypothesis in a humorous letter to his colleagues Lise Meitner and Hans Geiger. But Enrico Fermi, the great Italian physicist, was immediately convinced and gave a name "neutrino" (meaning a neutral little one in Italian). At the Solvay Conference on October 1933, he proposed the theory of β -decay based on a hypothesis that an electron-neutrino pair is spontaneously produced by a nucleus in the same way that photons can spontaneously be emitted by excited atoms. The neutrino remained a hypothetical particle until evidence for its existence was brought forward by Reines and Cowan in 1956 in the project which was named as *Poltergeist* because of its illusive properties. Their experimental set up was like the following

- Uranium fission reactor 1000 MW
- Two tanks of diluted cadmium chloride (CdCl_2) in water sandwiched between
- Three tanks of liquid scintillator, $183 \times 132 \times 56 \text{ cm}^3$ each
- The apparatus surrounded with thick layer of earth and metal (scrap metal from an old battle ship) to shield it from other particles coming from the reactor and cosmic rays
- The first series of measurements: 200 hours, 567 events, ~ 200 estimated to be from background
- Counting rate of ~ 3 events per hour

In 1995 Reines receives the Nobel Prize (However Cowan deceased by that time). *One can only wonder why it took them so long.....* Thus the equation for β -decay becomes

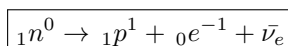

Ok! So here we go. A third particle is also emitted in the β -decay process as the neutrino which is of course difficult to detect. But then that particle rescued the conservation of energy from breaking down. At the same time people now have understood why everytime the β -particle comes out with different energies. There has been a sharing of energy between these two. If the e^- is detected to have high energy than the neutrino is going to take away less energy and vice versa. And the curve in your right side is readily explained. But physicists have introduced a technical term. The **End point energy** which is defined as the maximum energy carried out by the emitted e^- .

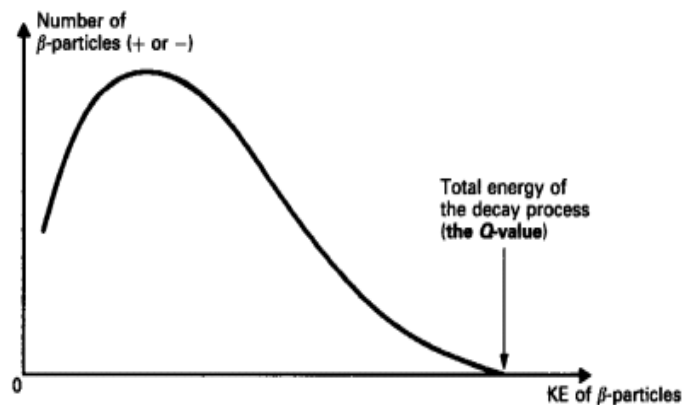

2.7 Three forms of β -decay and their conditions for occurring:

Proton decay, neutron decay, and electron capture are three ways in which protons can be changed into neutrons or vice-versa; in each decay there is a change in the atomic number, so that the parent and daughter nuclei are different. In all three processes, the number A of nucleons remains the same, while both proton number, Z, and neutron number, N, increase or decrease by 1. So far so good! Now let's get somewhat detailed into that.

• β^- - decay:

In β^- - decay, the weak interaction converts an atomic nucleus into a nucleus with atomic number increased by one, while emitting an electron (e^-) and an electron antineutrino ($\bar{\nu}_e$). β^- - decay generally occurs in neutron-rich nuclei. The generic equation is:

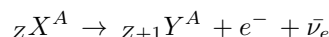

where A and Z are the mass number and atomic number of the decaying nucleus, and X and Y are the initial and final elements, respectively. Inside the nucleus following is what that has happened.

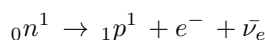

2.7.1 Condition for occurrence of β^- - decay:

In β^- - decay, the mass difference between the parent and daughter particles is converted to the kinetic energy of the daughter particles. This kinetic energy is of course coming from masses of atoms involved in process. Though the atomic mass is almost comparable with the nuclei but still there is minute difference since in case atom the electrons have to also taken into account and they also contribute to the mass. So we must concentrate the nuclear mass rather than the atomic mass. Since neutrinos are massless therefore neglecting it in the equation

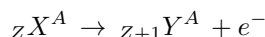

the disintegration energy Q can be written down as

$$\begin{aligned} Q &= [\text{Nuclear mass}(X)] - [\text{Nuclear mass}(Y) + m_{e^-}] \times c^2 \\ &= [\text{Atomic mass}(X) - Zm_{e^-}] - [\text{Atomic mass}(Y) - (Z+1)m_{e^-} + m_{e^-}] \times c^2 \\ &= [M_X - Zm_{e^-} - M_Y + Zm_{e^-} + m_{e^-} - m_{e^-}] \times c^2 \\ &= [M_X - M_Y] \text{ in energy units} \end{aligned}$$

Thus for $Q > 0$ you must have $M_X > M_Y$. Or to put it in a sentence "for β^- -decay to occur the mass of parent atom must be greater than that of the daughter atom."

• β^+ - decay:

In β^+ - decay, the weak interaction converts an atomic nucleus into a nucleus with atomic number decreased by one, while emitting a positron (e^+) and a electron neutrino (ν_e). β^+ - decay generally occurs in neutron-rich nuclei. The generic equation is:

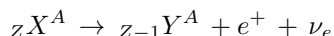

where A and Z are the mass number and atomic number of the decaying nucleus, and X and Y are the initial and final elements, respectively. Inside the nucleus following is what that has happened.

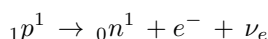

2.7.2 Condition for occurrence of β^+ - decay:

Similar treatment I am going to use. We will see the disintegration energy pertaining to this decay. And will find out the condition. Hence in the equation

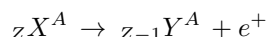

the Q value of the reaction is

$$\begin{aligned} Q &= [\text{Nuclear mass}(X)] - [\text{Nuclear mass}(Y) + m_{e^-}] \times c^2 \\ &= [\text{Atomic mass}(X) - Zm_{e^-}] - [\text{Atomic mass}(Y) - (Z-1)m_{e^-} + m_{e^-}] \times c^2 \\ &= [M_X - Zm_{e^-} - M_Y + Zm_{e^-} - m_{e^-} - m_{e^-}] \times c^2 \\ &= [M_X - M_Y - 2m_{e^-}] \text{ in energy units} \end{aligned}$$

Thus for $Q > 0$ you must have $M_X > M_Y + 2m_{e^-}$. Or to put it in a sentence “for β^- -decay to occur the mass of parent atom must be greater than that of the daughter atom by at least twice the electronic mass.”

• K-capture:

This is a process during which a nucleus captures one of its atomic electrons, resulting in the emission of a neutrino. Most commonly the electron is captured from the innermost, or K, shell of electrons around the atom; for this reason, the process often is called K-capture. Here the atomic number decreases by one unit, and the mass number remains the same like positron emission. The generic equation is:

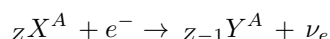

where A and Z are the mass number and atomic number of the decaying nucleus, and X and Y are the initial and final elements, respectively.

2.7.3 Condition for occurrence of K-capture:

Here also the process is going to be same. But one thing is different in this case. See the electron was orbiting before it was getting captured by the nucleus. So it was as if pulled working against the binding energy of the electron in the orbit. So that energy has to be taken into account. The Q value of the reaction is

$$\begin{aligned} Q &= [\text{Nuclear mass}(X) + m_{e^-}] - [\text{Nuclear mass}(Y)] \times c^2 - B_e \\ &= [\text{Atomic mass}(X) - Zm_{e^-} + m_{e^-}] - [\text{Atomic mass}(Y) - (Z-1)m_{e^-}] \times c^2 - B_e \\ &= [M_X - Zm_{e^-} + m_{e^-} - M_Y + Zm_{e^-} - m_{e^-}] \times c^2 - B_e \\ &= [M_X - M_Y] \times c^2 - B_e \end{aligned}$$

Thus for $Q > 0$ you must have $M_X > M_Y + B_e$. Or to put it in a sentence “for K-capture to occur the mass of parent atom must be greater than that of the daughter atom by at least the binding energy of the electron.”

2.8 Theory of γ -decay

γ decay is one type of radioactive decay that a nucleus can undergo. What separates this type of decay process from α or β decay is that no particles are ejected from the nucleus when it undergoes this type of decay. Instead, a high energy form of electromagnetic radiation - a γ -ray photon - is released. γ rays are simply photons that have extremely high energies which are highly ionizing. As well, γ radiation is unique in the sense that undergoing gamma decay does not change the structure or composition of the atom. Instead, it only changes the energy of the atom since the γ -ray carries no charge nor does it have an associated mass. In order for a nucleus to undergo γ decay, it must be in some sort of excited energetic state. Experiments have shown that protons and neutrons are located in discrete energy states within the nucleus, not too different from the excited states that electrons can occupy in atoms. Thus if a proton or a neutron inside of the nucleus jumps up to an excited state - generally following an α or β decay - the new daughter nucleus must somehow release energy to allow the proton or neutron to relax back down to ground state. When the nucleon makes this transition from a high to a low energy state, a gamma photon is emitted. The general equation that represents this process is:

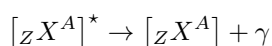

Knowing that an atom undergoes gamma radiation is important, but it is also possible to determine the frequency of the released gamma radiation if the initial and final states of the nucleon inside the nucleus are known. The equation representing the frequency of the gamma radiation is

$$E_i - E_f = h\nu$$

where E_i and E_f are the initial and the final energies of the nucleus and ν is the frequency of the emitted photon.

2.9 Soddy-Fajans Group Displacement Law

Soddy and Kasimir Fajans independently unraveled the pattern of transformations that accompanied α and β radioactive decay. They gave a law, to know the position of new element formed after the emission of α & β -particle. According to the Group displacement law...

- If an α -particle is emitted by a radio active element from its nucleus, the atomic no.(Z) of new element or daughter element formed is decreased by 2 units & the mass number (A) is decreased by 4 units. Therefore the position of new element formed is displaced by two groups towards the left in the periodic table.
- If a β -particle is emitted by a radioactive element, the atomic number of daughter element or new element is increased by one unit. Therefore the position of new element is displaced by one group towards the right in periodic table.
- If an α -particle is emitted from the nucleus of radioactive element and then 2 β -particles are emitted in next two transformations, the daughter element is an isotope of parent element. The daughter & parent element have the same atomic number. Hence according to Group displacement law position of daughter & parent element in the periodic table will remain same.
- Group displacement law is not applicable to lanthanides & actinides. (ie for f-block elements).

Chapter 3

Nuclear Models

I can never satisfy myself until I can make a mechanical model of a thing. If I can, then I can understand it..... Lord Kelvin

3.1 Introduction

See, the structure of atoms is now well understood (*Bohr's theory for mono-electronic atom and Hartree-Fock or Sommerfeld's theory for poly-electronic atoms*): quantum physics governs all; the electromagnetic force is the main force; each atom contains a massive central force (the nucleus) that dominates. But in case of the nucleus quantum mechanics still governs its behavior, but

- The forces are complicated and there is no exact mathematical expression that accounts for the nuclear force, in fact, can't be written down explicitly in full detail like electromagnetic or gravitational force.
- The nucleus is actually a many-body problem of great complexity and there is no mathematical solution to the many-body problem.

So, in the absence of a comprehensive nuclear theory, we turn to the construction of nuclear models. Thus nuclear models, are amongst the several theoretical descriptions of the structure and function of atomic nuclei or in other words it is simply a way of looking at the nucleus that gives a physical insight into as wide a range of its properties as possible. The usefulness of a model is tested by its ability to provide predictions that can be verified experimentally in the laboratory. It should be mentioned that each of the models is based on a plausible analogy that correlates a large amount of information and enables predictions of the properties of nuclei. What is that mean is the following.. You observe some properties of a nucleus and as according to that you devise a model which will only describe those behaviour. You prepare a different model to explain some other properties. Well the former model is inadequate to describe the properties explained by the later one and like that.

Nuclear models can be classified into two main groups. In those of the first group, called **strong-interaction, or statistical models**, the main assumption is that the protons and neutrons are mutually coupled to each other and behave cooperatively in a way that reflects the short-ranged strong nuclear force between them. The **liquid-drop model and compound-nucleus model** are examples of this group. In the second group, called **independent-particle models**, the main assumption is that little or no interaction occurs between the individual particles that constitute nuclei; each proton and neutron moves in its own orbit and behaves as if the other nuclear particles were passive participants. The **shell model** and its variations fall into this group. Other nuclear models incorporate aspects of both groups, such as the **collective model** put forwarded by Aage Bohr (son of Neils Bohr), which is a combination of the shell model and the liquid-drop model. The **Optical model** is however one specific model however where the nucleus is assumed as a medium having complex refractive index.

As far as your syllabus is concerned we will mainly look at **liquid-drop** and **shell model** of the nucleus.

3.2 Liquid Drop model of the nucleus

The liquid drop model in nuclear physics treats the nucleus as a drop of incompressible nuclear fluid of very high density. It was first proposed by George Gamow along with Weizsacher in 1935 who have recognized some experimental evidences and found resemblance of nucleus with a liquid drop and then developed by Niels Bohr and John Wheeler later on. What they have justified in favour of this model are the following

- Like the molecules in a drop of liquid, the nucleons are imagined to interact strongly with each other.
- Just like liquid molecules can collide with each other due to thermal agitation but then well inside the drop, a given nucleon collides frequently with other nucleons in the nuclear interior, its mean free path as it moves about being substantially less than the nuclear radius.

- The liquid drop is assumed as incompressible meaning its density can't be changed similar is the case for nucleus also where the density of the nucleus is constant for all the nuclei.
- The liquid drop is spherical because of surface tension similarly the nucleus is spherical because of the strong nuclear force.
- In case of the liquid drop the cohesive force always saturates just like the nuclear force which also saturates.
- The heat of vaporization which represents the amount of energy required to convert molecules from liquid phase to gas phase or rather more specifically the latent heat of vaporisation is proportional to the number of molecules in the liquid just like the binding energy of nucleus is also proportional to number of nucleon.

However there are some differences too which are as follows

- The nucleus has a limited number of particles (< 270) compared to chemical systems ($\approx 10^{23}$). The net result is that there is a much larger fraction of nucleons on the surface relative to those in the bulk for nuclei compared to chemical systems.
- The nucleus is a two-component system composed of neutrons and protons whereas in a liquid drop number of components may be more or less.

This is a crude model that does not explain all the properties of the nucleus, but does predict the nuclear binding energy. As the model justifies the similarities between a liquid drop and a nucleus one can then construct a semi-empirical model (half theory/half data) also known as **Bethe-Weizacker Semi-empirical Mass Formula** to account for the total nuclear binding energy, the most basic of nuclear properties.

The Model : Bethe-Weizacker Semi-empirical Mass Formula (SEMF)

Mathematical analysis of the theory delivers an equation which attempts to predict the binding energy of a nucleus in terms of the numbers of protons and neutrons it contains. There are five factors that contribute to the binding energy of nuclei. Let us now discuss them one by one.

• Volume energy:

When an assembly of spheres of the same size is packed together into the smallest volume, as we suppose is the case of nucleons within a nucleus, each interior sphere has 12 other spheres in contact with it. This term illustrates the idea that each nucleon only interacts with its nearest neighbors and binds to the nucleus at a specific binding energy. This is the dominant attractive term and will come with a +ve sign. Mathematical treatment is also very simple. Let's look at that. I have already told you the following

$$R = R_0 A^{\frac{1}{3}}$$

$$\frac{4}{3}\pi R^3 = \frac{4}{3}\pi R_0^3 A$$

Each nucleon has a binding energy which binds it to the nucleus. If U_v is binding energy per unit vol. of the nucleus then the total energy will be the following

$$E_V = \frac{4}{3}\pi R_0^3 A U_v$$

$$= a_v A$$

Therefore we get a term contributing to the energy proportional to A .

• Surface energy:

This term is a correction to the first term. The nucleons on the surface of the nucleus have fewer near neighbors, thus fewer interactions, than those in the interior of the nucleus. The effect is analogous to the surface tension of a liquid drop. Hence its binding energy is less. This surface energy takes that into account and is therefore negative. That is more is the surface area of a nucleus unstable the nucleus is going to be. Mathematical treatment is also very simple too here.

$$R = R_0 A^{\frac{1}{3}}$$

$$4\pi R^2 = 4\pi R_0^2 A^{\frac{2}{3}}$$

If U_s is binding energy per unit area of the nucleus then the total reduction in the energy will be the following

$$E_S = -4\pi R_0^2 A^{\frac{2}{3}} U_s$$

$$= -a_s A^{\frac{2}{3}}$$

Therefore we get a term proportional to $A^{\frac{2}{3}}$.

• Coulomb energy:

The Coulomb term represents the electrostatic repulsion between protons in a nucleus. The electric repulsion between

each pair of protons in a nucleus also contributes toward decreasing its binding energy. The coulomb energy of a nucleus is equal to the work that must be done to bring together the protons from infinity into a spherical aggregate the size of the nucleus. The coulomb energy is negative because it arises from an effect that opposes nuclear stability. Mathematical treatment is also very simple but somewhat logical. The potential energy between a pair of protons is given by

$$V = -\frac{e^2}{4\pi\epsilon R}$$

If there are Z numbers of protons in the nucleus then $\frac{Z(Z-1)}{2}$ numbers of pairs of protons will be there ie taking two protons together since for the repulsive force to develop there must be atleast two protons which is nothing but $\frac{Z(Z-1)}{2}$ numbers of pairs. Hence the coulomb energy will be the following

$$\begin{aligned} E_C &= -\frac{Z(Z-1)}{2} V \\ &= -\frac{Z(Z-1)}{2} \frac{e^2}{4\pi\epsilon R} \\ &= -\frac{Z(Z-1)e^2}{8\pi\epsilon R_0 A^{\frac{1}{3}}} \\ &= -a_c \frac{Z(Z-1)}{A^{\frac{1}{3}}} \end{aligned}$$

Thus we get a term proportional to $\frac{Z(Z-1)}{A^{\frac{1}{3}}}$.

• **Asymmetry energy:**

This term is very ugly, I must say! Think about little bit of chemistry may be from your general course or even from higher secondary. Raoult's law! According to Raoult's Law, in any two-component liquid with nonpolar attractive forces, the minimum in energy occurs when the two components occur in equal concentrations which will in turn generate a minimum in the vapor pressure and that will correspond to a maximum binding energy in the system. For nuclei with equal numbers of protons and neutrons, the nucleus is symmetric and it will be very stable. But what if the number of neutrons is greater than the number of protons. This energy associated as a correction in types of nuclei. This is a quantum effect arising from Pauli's exclusion principle which only allows two protons or two neutrons (with opposite spin direction) in each energy state. If a nucleus contains the same number of protons and neutrons then all the protons and neutrons will be filled up to the same maximum energy level. If, on the other hand, we exchange one of the neutrons by a proton then that proton would be guided by the exclusion principle to occupy a higher energy state, since all the below level states are already occupied. Well you can think of it this way too. Two different "pools" of states, one for protons and one for neutrons. Now, for example, if there are significantly more neutrons than protons in a nucleus, some of the neutrons will be higher in energy than the available states in the proton pool. If we could move some particles from the neutron pool to the proton pool, in other words change some neutrons into protons, we would significantly decrease the energy. The imbalance between the number of protons and neutrons causes the energy to be higher than it needs to be, for a given number of nucleons. This is the basis for the asymmetry term. Thus the asymmetry term accounts for the difference in the number of protons and neutrons in the nuclear matter.

Look at this figure. The left-side two U shaped structures is a nucleus and is a symmetric one having equal nos. of protons and neutrons. Now what we want is that we should have a nucleus with the same mass number ie A. So that can be achieved by either changing protons into neutrons or vice versa which is in a way the nucleus is as if decaying via $\pm\beta$ -decay. Now count the number of circles in the two U shape from the right. What have you got? Same value of A. But look at the positions of the neutrons, now they are occupying higher levels than before. Now compare with the original symmetric one. you will see that the energy levels are quite different now leading to a different energy of the nucleus all together. Now the nucleus has also lost its symmetry as it doesn't have same numbers of protons and neutrons even with the same value of A. Now the calculation of this energy is also somewhat simple.

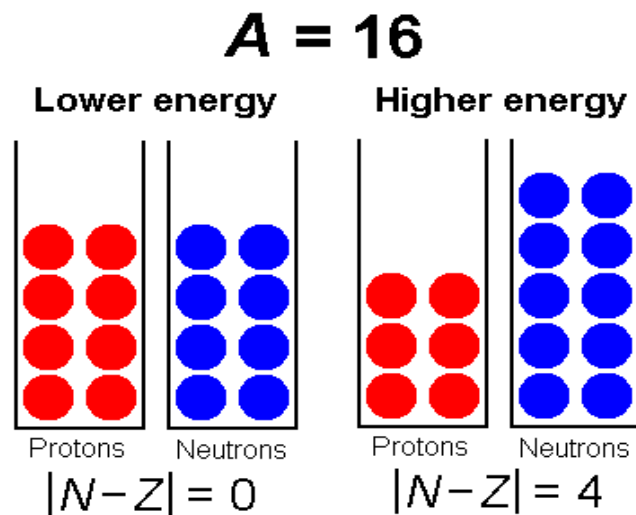

If ϵ is energy per nucleonic level then the new neutron will occupy level higher in the energy by

$$\begin{aligned}\Delta E &= \text{number of new neutrons} \times \frac{\text{energy increased}}{\text{new neutrons}} \\ &= \frac{1}{2}(N - Z) \times \frac{1}{2}(N - Z) \frac{\epsilon}{2} \\ &= \frac{(N - Z)^2 \epsilon}{8}\end{aligned}$$

Again it happens that greater is number of nucleons smaller will be the energy spacing hence ϵ will be inversely proportional to A . Hence

$$\begin{aligned}\Delta E &= \frac{(N - Z)^2}{8A} \\ &= -a_a \frac{(A - 2Z)^2}{A}\end{aligned}$$

Thus we have a term proportional to $\frac{(A-2Z)^2}{A}$.

• **Pairing energy:**

Finally, there is one more ingredient to our binding energy recipe. The pairing energy it is called. This is again a correction term that arises from the tendency of proton pairs and neutron pairs to occur which actually occurs because of the different overlap of wavefunctions for pairs of nucleons in various states. In order to account for the binding energy, if number of protons and number of neutrons are both even the pairing energy is +ve, we subtract the same term if these are both odd, and do nothing if one is odd and the other is even. Experimentally it has been found that the pairing energy goes inversely as

$$E_p \propto \frac{1}{A^{\frac{3}{4}}}$$

Thus mathematically it can be written as

$$\begin{aligned}E_p &= \frac{a_p}{A^{\frac{3}{4}}} && \text{even - even} \\ &= 0 && \text{even - odd or odd - even} \\ &= -\frac{a_p}{A^{\frac{3}{4}}} && \text{odd - odd}\end{aligned}$$

Hence collecting all the energy term we get the Bethe-Weisacker's SEMF as

$$E_B = a_v A - a_s A^{\frac{2}{3}} - a_c \frac{Z(Z-1)}{A^{\frac{1}{3}}} - a_a \frac{(A-2Z)^2}{A} \pm \frac{a_p}{A^{\frac{3}{4}}}, 0$$

Now it's time to get the values of the constants appearing before each of the individual terms. I urge you to remember these.

$$a_v = 14.1 \text{ MeV}, \quad a_s = 13.0 \text{ MeV}, \quad a_c = 0.595 \text{ MeV}, \quad a_a = 19.0 \text{ MeV}, \quad a_p = 33.5 \text{ MeV}.$$

Q. The atomic mass of Zn isotope ${}_{30}\text{Zn}^{64}$ is 63.929 amu. Compare the binding energy from nuclear composition and predicted by SEMF? (May come in your final exam)

Answer: So Zn has 30 protons and 34 neutrons. Therefore using the equation

$$\begin{aligned}E &= [(n_{\text{prot}}m_{\text{prot}} + n_{\text{neut}}m_{\text{neut}}) - M] \times 931.5 \text{ MeV} \\ &= [(30 \times 1.0072 + 34 \times 1.0086) - 63.929] \times 931.5 \text{ MeV} \\ &= 559.1 \text{ MeV}\end{aligned}$$

Now using SEMF, well we will only replace the mass numbers (As) by 64 and the atomic numbers (Zs) by 30 and replace the constants by their respective values, we get

$$\begin{aligned}E &= a_v A - a_s A^{\frac{2}{3}} - a_c \frac{Z(Z-1)}{A^{\frac{1}{3}}} - a_a \frac{(A-2Z)^2}{A} + \frac{a_p}{A^{\frac{3}{4}}} \text{ MeV} \\ &= 14.1 \times 64 - 13.0 \times 64^{\frac{2}{3}} - 0.595 \times \frac{30(30-1)}{64^{\frac{1}{3}}} - 19.0 \times \frac{(64-2 \times 30)^2}{64} + \frac{33.5}{64^{\frac{3}{4}}} \text{ MeV} \\ &= 561.7 \text{ MeV} \quad (\text{do your calculation})\end{aligned}$$

Now the difference between these two is less than 0.5%. And the plus sign in the pairing energy is because ${}_{30}\text{Zn}^{64}$ is an even-even nucleus.

Q. Derive a formula for the atomic number of the most stable isotope isobar of a given A and use it to find the most stable isobar of A = 25 (May come in your exam too.)

Answer: Well this we will handle using differentials. We know that for maxima or minima we do the first derivative find the value of x, then we do the second derivative put the value of x and see whether it is coming positive or negative. If negative it is maxima else minima.

Thus for maximum stability we must have

$$\frac{dE}{dZ} = 0$$

Hence following this we have and we will take partial instead of total (well it doesn't make any difference)

$$\begin{aligned} \frac{\delta E}{\delta Z} &= \frac{\delta}{\delta Z} \left[a_v A - a_s A^{\frac{2}{3}} - a_c \frac{Z(Z-1)}{A^{\frac{1}{3}}} - a_a \frac{(A-2Z)^2}{A} \pm \frac{a_p}{A^{\frac{3}{4}}}, 0 \right] \\ &= 0 + 0 - \frac{a_c}{A^{\frac{1}{3}}}(2Z-1) + \frac{4a_a}{A}(A-2Z) + 0 \end{aligned}$$

Thus

$$\begin{aligned} -\frac{a_c}{A^{\frac{1}{3}}}(2Z-1) + \frac{4a_a}{A}(A-2Z) &= 0 \\ Z &= \frac{a_c A^{-\frac{1}{3}} + 4a_a}{2a_c A^{-\frac{1}{3}} + 8a_a A^{-1}} \\ &= \frac{0.595 A^{-\frac{1}{3}} + 76}{1.19 A^{-\frac{1}{3}} + 152 A^{-1}} \\ &= \frac{0.595 \times 25^{-\frac{1}{3}} + 76}{1.19 \times 25^{-\frac{1}{3}} + 152 \times 25^{-1}} \\ &\approx 12 \end{aligned}$$

Thus we can conclude that a nucleus with Z= 12 and A= 25 is going to be most stable amongst the isobars.

Q. Predict which one is the most stable nucleus amongst ${}_8O^{16}$, ${}_8O^{17}$ and ${}_8O^{18}$ (typical for your exam)

Answer: Similar treatment like the above. But in this case you have differentiate w.r.to A. See A is the variable in the isotopic family. Then find the value of A. And see which value does this A close to. Say if you get A= 15.8 then it is close to 16 or even say 16.4 then it is also 16. 17 is too far right. Solve it. Good luck.

• Explanation of Nuclear Fission on the basis of Liquid Drop Model

By this time we have come to know that the atomic nucleus behaves like the molecules in a drop of liquid. But in this nuclear scale, the fluid is made of nucleons (protons and neutrons), which are held together by the strong nuclear force. The interior nucleons are completely surrounded by other attracting nucleons just like molecules did in case of a liquid drop. In the ground state the nucleus is spherical. If the sufficient kinetic or binding energy is added, this spherical nucleus may be distorted into a dumbbell shape and due to positive charge repulsion on the two ends splits into two fragments hence, forming daughter two nuclei. This process is what we call nuclear fission.

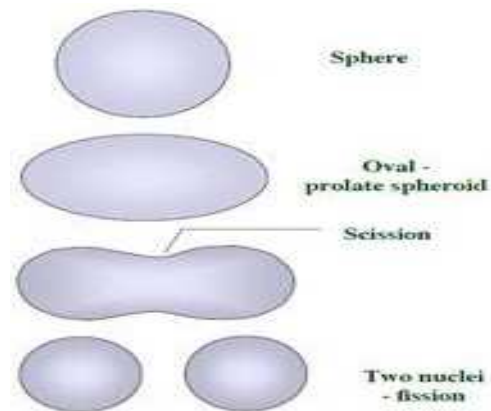

• Achievements of this model:

1. It predicts the atomic masses and binding energies of various nuclei to a larger accuracy.
2. It predicts emission of alpha and beta particles in radioactivity.
3. The theory of compound nucleus, which is based on this model, explains the basic features of the nuclear fission process.

• **Failures of this model:**

1. It fails to explain the extra stability of certain nuclei, with the numbers of protons or neutrons are 2, 8, 20, 28, 50, 82 or 126 etc
2. It fails to explain the measured magnetic moments of many nuclei.
3. It also fails to explain the spin and parity (explained later on) of nuclei.
4. It is also not successful in explaining the excited states in most of the nuclei.

3.3 Shell model of the nucleus

The basic assumption of the liquid drop model is that each nucleon interacts only with its nearest neighbour. Though it explains nuclear fission, sphericity of the nucleus and binding energy of the nuclei to a large extent but few significant things it fails to explain. Which are

- There are some peaks or kinks in the binding energy/nucleon curve (see fig. 1.1)
- It underestimate the actual binding energies of some **magic nuclei** for which either the number of neutrons $N = (A - Z)$ or the number of protons, Z is equal to one of the **magic numbers** (a fancy term used by the nuclear physicist) which are 2, 8, 20, 28, 50, 82 etc. These numbers are exceptional in the sense that any nucleus which possesses any of these values in terms of neutrons or protons or sum of these two are highly stable nuclei. For example for ${}_{28}Ni^{56}$ the Liquid Drop Model predicts a binding energy of 477.7 MeV, whereas the measured value is 484.0 MeV. Likewise for ${}_{50}Sn^{132}$ the Liquid Drop model predicts a binding energy of 1084 MeV, whereas the measured value is 1110 MeV. You know that an α -particle is exceptionally stable because its proton number and neutron number are both equal to 2, a magic number. An α -particle is therefore said to be doubly magic because they contain filled shells of both protons and neutrons.
- Changes in separation energies (the energy required to remove the last neutron (or proton)) for certain numbers of neutron and protons.
- If N is magic number then the cross-section for neutron absorption is much lower than for other nuclides.

The shell model is an attempt to solve these ambiguities which a model of the nucleus that uses the Pauli exclusion principle to describe the structure of the nucleus in terms of energy levels. The shell model is partly analogous to the atomic shell model which describes the arrangement of electrons in an atom, in that a filled shell results in greater stability. In the Shell Model it is assumed that each nucleon in the nucleus moves in a net attractive potential that represents the avg. effect of its interaction. The potential has a constant depth inside the nucleus and outside the nucleus it goes to zero within a distance equal to the range of the nuclear force. It almost like a 3D potential with round edges. And in the ground state of the nucleus the nucleons are filled without violating the Pauli's exclusion principle. And that immediately excludes the possibility of nucleon-nucleon collision. But two nucleons can exchange their quantum states which will be indistinguishable. Hence all the nucleons that constitute the nucleus can move freely inside the ground state nucleus. So, this model is also called as independent particle model. And the behaviour of each nucleon can be understood by solving the Schrodinger equation for that potential. This Shell Model plays the same role in nuclear physics as Hartree-Fock theory in atomic physics. However there are some similarities and differences between these two. Let's have a look at it.

Table 3.1: Similarities between Shell Model and Hartree-Fock Theory

| Shell Model | Hartree-Fock Theory |
|----------------------------------------------------|---------------------------------------------------|
| 1. Nucleons move in an attractive potential | 1. Electrons move in an attractive potential |
| 2. Nucleons obey Pauli's exclusion principle | 2. Electrons obey Pauli's exclusion principle |
| 3. Nuclear potential $V(r)$ depends on n and l | 3. Atomic potential $V(r)$ depends on n and l |
| 4. Nuclear spin-orbit interaction is present | 4. Atomic spin-orbit interaction is present |

Table 3.2: Differences between Shell Model and Hartree-Fock Theory

| Shell Model | Hartree-Fock Theory |
|---------------------------------------------------------------------------------------------------------------------------------------------------|-------------------------------------------------|
| 1. Potential $V(r)$ is square well with round edge | 1. Potential $V(r)$ is spherically symmetric |
| 2. n = radial node quantum number ($n_{principal} = n_{radial} + 1$) | 2. n = principal quantum number |
| 3. No upper limit for l | 3. There is an upper limit for l |
| 4. Strong inverted spin-orbit interaction ($S \bullet L$) ($S \bullet L$) _{nuclear} = $20 \times (L \bullet S)$ _{atomic} | 4. Spin-orbit interaction ($L \bullet S$) |
| 5. Spin-orbit interaction is not magnetic in origin | 5. Spin-orbit interaction is magnetic in origin |

Keeping these things in mind if one proceeds to fill up the various states then in case of atomic physics you have **Aufbau Principle** as e^- s have to be filled in various orbitals as increasing order of their energies. Right!

Here in the case of nucleus I can't give you an Aufbau Principle. But I can give you a mnemonic which in German as follows

spuds if pug dish of pig

Its means "eat potatos if the pork is bad ". But we have nothing to do with eating. But here is what you should remember. **Delete all the vowels except the last one** in the above sentence or what. If you do that you will be left with the following

s p d s f p g d s h f p i g

Yes exactly. These are my orbitals where I am going to put my nucleons. Let's then do the final job. The nuclear energy levels going to be filled up by the nucleons in various shells.

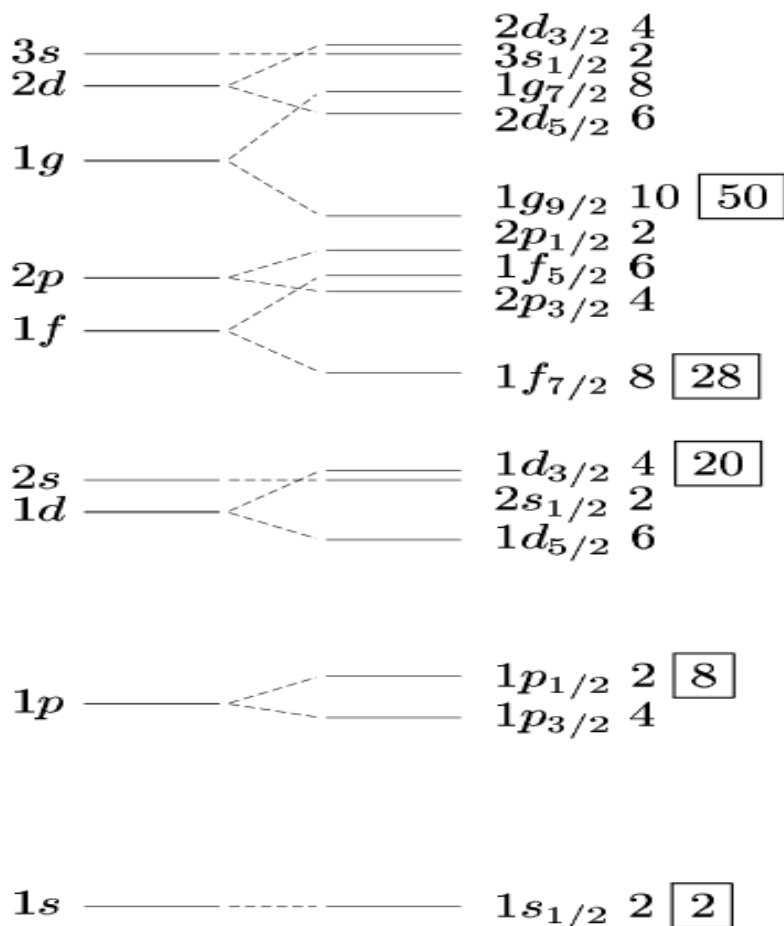

without S • L

with S • L

$2j + 1$ Magic Numbers

- The construction of this figure:

Well how have I constructed this or what are the key features? Following are the points that you should remember.

- Without S • L coupling there would not have been any splitting in the energies. Thus the first vertical construction.
- But since there has been S • L coupling the energy levels gets splitted out. Now the splitting is similar to the atomic case. It depends on values of azimuthal quantum number l and spin quantum number s. For instance for s orbital l value is 0. Hence no splitting. Then for p orbital l value is 1 and s value is $\pm\frac{1}{2}$. Thus the total angular momentum, j will be $|l + s| = \frac{3}{2}$ and $|l - s| = \frac{1}{2}$. Now see the energy level diagram. You will see the term symbol like $1p_{\frac{1}{2}}$ lying up and $1p_{\frac{3}{2}}$ lying down which is exactly opposite to the case of atomics. In atomic case it would have been $1p_{\frac{1}{2}}$ lying down and $1p_{\frac{3}{2}}$ lying up. Can you imagine why this is so? Well here we have S • L coupling which is opposite to L • S coupling in atomic physics. Similar arguments for d, f orbitals etc too.

- Now number of nucleons to be put in each orbital will be equal to $2j + 1$ similar to atomic physics. Thus in s orbital $2 \times \frac{1}{2} + 1 = 2$ numbers of nucleon can be placed. In $1p_{\frac{3}{2}}$, $2 \times \frac{3}{2} + 1 = 4$ numbers of nucleon can occupy that orbital. And likewise.

- Here is the catch of giving the digits before the s, p, d etc orbitals. Whenever the first appearance of the orbitals come it is given 1 second appearances are given 2 and similarly others.

- This diagram has to be filled up by both neutrons and protons independently.

- The gap in the energy levels are subsequently decreasing in the vertical direction. Did you see that.

• Prediction of Nuclear Spin on the basis of Shell Model

As I have said that both neutrons and protons have to be filled independently that means you need to have two such figures. Now from the nucleus find out how many number of neutrons and protons are there. Once that is done keep on filling all the neutrons and protons as according to the $2j + 1$ values in various orbitals of course obeying Pauli's exclusion principle. ie say in $1s_{\frac{1}{2}}$ orbital one up and one down, in $1p_{\frac{1}{2}}$ orbital one up and one down and in $1p_{\frac{3}{2}}$ orbital one up, one down, one up the last one down, a total of 4 protons and 4 neutrons and similarly for others as well. Once all the nucleons are used up then go to top level, the last occupied state and look how they are arranged. If there is any unpaired nucleon remaining, the spin of the nucleus will be the value of the angular momentum of that state. And if cases like one proton and one neutron is remaining unpaired than spin of the nucleus will be the algebraic sum of the angular momentums of those two states. I will show you in the class. It's very easy to understand. But remember by default we will always take the up spin as +ve values and down spin as -ve values and also we will always fill the up spin first.

• Prediction of Nuclear parity on the basis of Shell Model

You might not have heard about parity. But it's a day to day business though not we perceive it mathematically. When you comb your hair in front the looking glass and raise your right hand the mirror image will raise the left hand if turn your back. That means you and your image share odd parity. Mathematically speaking, the behaviour of the wave function under the reflection of space coordinates through the origin determines the parity of the system. Under reflection of space coordinates, the wave function may change sign or may remain unchanged. In case the wave function does not change sign upon reflection of space coordinates, its parity is even and if it changes sign its parity is odd. ie $\psi(-r) = \psi(r)$ than the parity is even and if $\psi(-r) = -\psi(r)$ than the parity is odd. That is it is mere coming of a minus sign.

To find the parity of the nucleus we also, here, keep on filling all the neutrons and protons, separately, as according to the $2j + 1$ values in various orbitals obeying Pauli's exclusion principle. And once that is done go to top level and count how many protons and neutrons are occupied that level along with the value of the azimuthal quantum number, l for that occupied orbital. From atomic physics you know that for s orbital the value of l is 0, for p orbital it is 1, for d orbital it is 2 and likewise for the others. So finally the parity, P of the nucleus will be

$$P = (-1)^{\sum l_p + \sum l_n}$$

where $\sum l_p$ is the total l value with the contribution coming from all the last level occupying protons. For instance in 3 protons stands last in the $1p_{\frac{3}{2}}$ orbital then $\sum l_p$ will be $1 + 1 + 1 = 3$. If 2 protons occupies $1f_{\frac{7}{2}}$ then $\sum l_p$ will be $3 + 3 = 6$. Similarly for the neutrons too, ie the $\sum l_n$. And then finally we will raise -1 to the powered sum of $\sum l_p$ and $\sum l_n$.

Q. Predict the spin and parity of the following nuclei (May come in your exam too.)

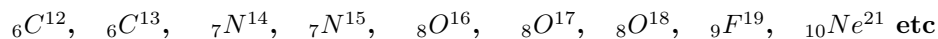

• Achievements of this model:

1. It Explains nuclear spin and parity.
2. It also explains magnetic moments for lighter nuclei.
3. It also speaks about excited states of nuclei.

• Failures of this model:

1. For heavier nuclei it fails to predict magnetic dipole moments or the spectra of excited states very well.
2. The Shell Model also does not give predictions of electric quadrupole moments of the nuclei.

Chapter 4

Nuclear Reactions

Stars can't shine without darkness nuclear reaction..... Anonymous

4.1 The compound nuclear theory

It's a description of atomic nuclei proposed (1936) by the Danish physicist Niels Bohr to explain nuclear reactions as a two-stage process comprising the formation of a relatively long-lived intermediate nucleus and its subsequent decay. However the compound nucleus absolutely forgets about its past while it gets formed. Few properties are defined in case of compound nuclear theory

- A bombarding particle loses all its energy to the target nucleus and becomes an integral part of a new, highly excited, unstable nucleus, called a compound nucleus.
- The formation stage takes a period of time approximately equal to the time interval for the bombarding particle to travel across the diameter of the target nucleus (about 10^{-21} second).
- After a relatively long period of time (typically from 10^{-19} to 10^{-15} second) and independent of the properties of the reactants, the compound nucleus disintegrates, usually into an ejected small particle and a product nucleus. Symbolically it can be written as the following

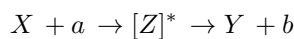

where $[Z]^*$ is the compound nucleus. The formation of the compound nucleus will guarantee the production of other nuclei. But what will form that will be governed by some certain conservation rules. These have to be kept in mind always. Let's now take a glimpse of those in the following nuclear reaction.

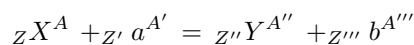

Target nucleus X + projectile a → Product nucleus Y + ejectile b

In order to get this reaction some conservation laws have to be followed for sure. These are just below

• Conservation of Mass Number:

It demands the sum of reactants' mass number must be same as sum of products' mass number.

$$\sum A_{react} = \sum A_{prod}$$

• Conservation of Atomic Number:

It demands the sum of reactants' total charge must be same as sum of products' total charge.

$$\sum Z_{react} = \sum Z_{prod}$$

• Conservation of Energy:

It demands the total energy of reactants' must be equal to the total energy of the products. By total energy I mean the sum of rest mass energy and the kinetic energy of the nuclei. Or equally you can say the total relativistic energy always remains the same.

$$\sum E_{react}(rest + kinetic) = \sum E_{prod}(rest + kinetic)$$

- **Conservation of Linear Momentum:**

It demands the total vector sum of reactants' linear momentum must also remain the same as that of the products'.

$$\sum \vec{p}_{reac} = \sum \vec{p}_{prod}$$

- **Conservation of Angular Momentum:**

It demands the total vector sum of reactants' angular momentum must also remain the same as that of the products'. Here you all know that angular momentum is nothing but the spin of the involved nuclei in the reaction. (The spins will be calculated from Shell Model)

$$\sum \vec{L}_{reac} = \sum \vec{L}_{prod}$$

- **Conservation of Isospin:**

It demands the total vector sum of reactants' angular momentum must also remain the same as that of the products'. *This isospin is similar to that of spin but it's not a physically interpretable thing. You need not need to know what this crap is all about. Just remember it. Hopefully in MSc you will learn a lot about this if you take specialisation in High Energy Physics.*

$$\sum \vec{T}_{reac} = \sum \vec{T}_{prod}$$

4.2 Various types of Nuclear reactions

- **Elastic scattering**

It occurs, when no energy is transferred between the target nucleus and the incident particle. for example

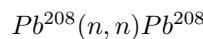

- **Inelastic scattering**

It occurs, when energy is transferred to the product. The difference of kinetic energies is saved in excited nucleus.

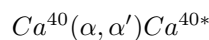

- **Capture reactions**

Both charged and neutral particles can be captured by nuclei. This is accompanied by the emission of γ -rays. Neutron capture reaction produces radioactive nuclides.

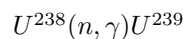

- **Transfer Reactions**

The absorption of a particle accompanied by the emission of one or more particles is called the transfer reaction.

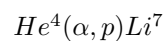

- **Fission reactions**

Nuclear fission is a nuclear reaction in which the nucleus of an atom splits into smaller parts (lighter nuclei). The fission process often produces free neutrons and photons (in the form of gamma rays), and releases a large amount of energy.



- **Fusion reactions**

It Occurs when, two or more atomic nuclei collide at a very high speed and join to form a new type of atomic nucleus.

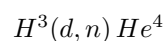

- **Spallation reactions**

It occurs, when a nucleus is hit by a particle with sufficient energy and momentum to knock out several small fragments or, smash it into many fragments.

4.3 Q-value of a nuclear reaction

In nuclear physics, the Q value for a reaction is the amount of energy released or absorbed by that reaction. So basically it is the energy balance term in a nuclear reaction. The energy conservation relation, enables the general definition of Q based on mass-energy equivalence. To calculate the Q-value look at the following calculation

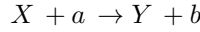

So conservation of demands

$$\begin{aligned} TE_X + TE_a &= TE_Y + TE_b \\ (kinetic + rest)_X + (kinetic + rest)_a &= (kinetic + rest)_Y + (kinetic + rest)_b \\ (KE_X + M_{0X}c^2) + (KE_a + M_{0a}c^2) &= (KE_Y + M_{0Y}c^2) + (KE_b + M_{0b}c^2) \end{aligned}$$

Here KE stands for kinetic and $rest$ stands for rest mass energy respectively and M, m s are masses of the involved particles. Now if you take the target nucleus to be at rest then $KE_X = 0$. In that case the last expression becomes

$$M_{0X}c^2 + (KE_a + m_{0a}c^2) = (KE_Y + M_{0Y}c^2) + (KE_b + m_{0b}c^2)$$

Now the Q-value is

$$\begin{aligned} Q &= TE_{final} - TE_{initial} \\ &= (E_Y + E_b) - E_a \\ &= (M_{0X} + m_{0a}) - (M_{0Y} + m_{0b}) \times c^2 \\ &= \Delta m \times 931.5 \text{ MeV} \end{aligned}$$

This Δm will be coming in amu s. So multiplying with 931.5 will give you the energy released.

• Cases for Q-value

1. $(M_{0X} + m_{0a}) > (M_{0Y} + m_{0b})$ will imply $Q > 0$, is termed as *exoenergetic reaction*
2. $(M_{0X} + m_{0a}) < (M_{0Y} + m_{0b})$ will imply $Q < 0$, is termed as *endoenergetic reaction*
3. $(M_{0X} + m_{0a}) = (M_{0Y} + m_{0b})$ will imply $Q = 0$, is termed as *elastic reaction*

So, in principle you can calculate the Q-value of the nuclear reaction if the masses are given. Thus the final definition **Q-value of the reaction is defined as the difference between the sum of the masses of the initial reactants and the sum of the masses of the final products, in energy units.**

4.3.1 Nuclear reaction kinematics

What if you don't know the mass of target nucleus. In general the particle with whom you are going to bombard the target nucleus is generally known. And whatever are particles going to get produced, you have the desire to know the masses of them. So in principle you are going to have three known masses and an unknown. So can it be a way to determine the Q-value in such cases. And the answer is YES. But what we are going to compensate for that is the introduction of a scattering angle in the equation and this is going to be performed in laboratory frame of course. Let's now look at the calculations for that.

Consider a reaction in which the bombarding particle strikes a target at rest. After the collision the product nucleus

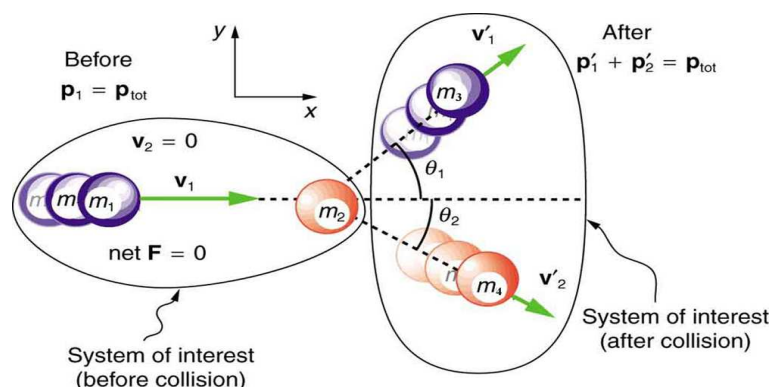

goes in a direction θ_2 and the ejectile in a direction θ_1 w. r. to the x-axis ie with the incoming direction of the projectile. In the fig.

$$\begin{aligned} m_1 &= m_a = \text{mass of the projectile} \\ m_2 &= m_X = \text{mass of the target nucleus} \\ m_3 &= m_Y = \text{mass of the ejectile} \\ m_4 &= m_b = \text{mass of the product nucleus} \end{aligned}$$

Now conservation of momentum demands that x-axis momentum and y-axis momentum have to equal before and after collision. Since momentum is a vector quantity therefore you have treat it vectorially. Thus x-axis momentum

$$\begin{aligned} \vec{p}_x(\text{ before collision}) &= \vec{p}_x(\text{after collision}) \\ \vec{p}_a &= \vec{p}_Y \cos\theta_2 + \vec{p}_b \cos\theta_1 \\ \vec{p}_Y \cos\theta_2 &= -(\vec{p}_b \cos\theta_1 - \vec{p}_a) \end{aligned} \quad (4.1)$$

Similarly the y-axis momentum

$$\begin{aligned} \vec{p}_y(\text{before collision}) &= \vec{p}_y(\text{after collision}) \\ 0 &= \vec{p}_Y \sin\theta_2 - \vec{p}_b \sin\theta_1 \\ \vec{p}_Y \sin\theta_2 &= \vec{p}_b \sin\theta_1 \end{aligned} \quad (4.2)$$

Now squaring and adding the last two numbered equation we get

$$\begin{aligned} p_Y^2 \cos^2\theta_2 + p_Y^2 \sin^2\theta_2 &= [-(p_b \cos\theta_1 - p_a)]^2 + p_b^2 \sin^2\theta_1 \\ p_Y^2 [\cos^2\theta_2 + \sin^2\theta_2] &= p_b^2 \cos^2\theta_1 - 2 p_b \cos\theta_1 p_a + p_a^2 + p_b^2 \sin^2\theta_1 \\ p_Y^2 &= p_b^2 + p_a^2 - 2 p_a p_b \cos\theta_1 \\ 2 M_Y E_Y &= 2 m_b E_b + 2 m_a E_a - 2\sqrt{2 m_b E_b 2 m_a E_a} \cos\theta_1 & \text{since } \frac{p^2}{2m} = E \\ M_Y E_Y &= m_b E_b + m_a E_a - 2\sqrt{m_b E_b m_a E_a} \cos\theta_1 \\ E_Y &= \frac{m_b}{M_Y} E_b + \frac{m_a}{M_Y} E_a - \frac{2}{M_Y} \sqrt{m_a m_b E_a E_b} \cos\theta_1 \end{aligned}$$

From the last section we have known that

$$Q = (E_Y + E_b) - E_a$$

Now substituting the value of E_Y in the last equation we get

$$\begin{aligned} Q &= (E_Y + E_b) - E_a \\ &= \left(\frac{m_b}{M_Y} E_b + \frac{m_a}{M_Y} E_a - \frac{2}{M_Y} \sqrt{m_a m_b E_a E_b} \cos\theta_1 + E_b\right) - E_a \\ Q &= \left[1 - \frac{m_a}{M_Y}\right] E_a + \left[1 + \frac{m_b}{M_Y}\right] E_b - \frac{2}{M_Y} \sqrt{m_a m_b E_a E_b} \cos\theta_1 \end{aligned}$$

Thus all you have to do is to measure the scattering angle and the masses of the projectile and the product nucleus to get to the Q-value.

4.4 Nuclear Cross-Section

So far we have learnt that a particle is going to interact with a static nucleus to produce something else. That incoming particle is a going to a part of a beam shooting at the target. Imagine that bullets coming out a machine gun. Each bullet is a particle of the round of fire acting as the beam. But not always the bullets are going to hit the target. So let's open up this section with the following questions

Q. What fraction of particles in a beam incident on a target nucleus participates in a particular nuclear reaction?

Ans. In microscopic physics we can not predict "certainties, rather "probabilities.

Q. Likelihood (probability) of an arrow hitting a circular board in an olympic archery?

Ans. Proportional to the (perpendicular) area of the board (its cross sectional area).

Similarly in nuclear physics the probability of a projectile to hit a target nucleus (i.e. interact with it) may be described by an analogous cross section (but not the actual, physical cross sectional area of the nucleus). Cross section measurements are some of the most important (and most common?) measurements made in a nuclear physics lab. However it has few properties as follows

- This cross section is the likelihood of whether a certain nuclear reaction is going to occur or not.
- Different processes (reaction channels) possible for a given particle incident on a nucleus have different cross sections.
- Cross sections depend on a variety of reaction variables.

The last three bullets (above) describes the essence of doing science.

4.4.1 Formal definition and Calculation of Nuclear Cross section

Consider a beam of particles incident on a thin sheet of material (of n nuclei per unit volume, thickness x , area A hit the beam). There is a probability that, in passing through, some certain reaction will take place if the particle gets close enough to a nucleus. Thus one can think of a situation like if one particle interacts only once the dN number of particles may be thought of as being removed from the beam passing through the slab of thickness dx . Let σ be the effective area of the nucleus for this particular reaction, i.e. if particle falls within this area, this particular reaction will take place.

$$\begin{aligned} \text{Total number of nuclei present} &= (n/\text{cm}^3) dx(\text{cm}) A(\text{cm}^2) \\ \text{Effective area available for this reaction} &= (ndx A)\sigma(\text{cm}^2) \end{aligned}$$

$$\begin{aligned} \frac{\text{Interacting particles}}{\text{Incident particles}} &= \frac{\text{Aggregate cross section}}{\text{Target Area}} \\ \frac{dN}{N} &= \frac{n A \sigma dx}{A} \\ &= n \sigma dx \end{aligned}$$

As I said *particles may be thought of as being removed...*, that demands a -ve sign in the above expression. So incorporating the minus sign we have

$$\begin{aligned} \frac{dN}{N} &= -n \sigma dx \\ \int_{N_0}^N \frac{dN}{N} &= - \int_0^x n \sigma dx \\ \ln \left(\frac{N}{N_0} \right) &= -n \sigma x \\ \frac{N}{N_0} &= e^{-n \sigma x} \\ \boxed{N} &= \boxed{N_0 e^{-n \sigma x}} \end{aligned}$$

This is the number of surviving particles which decreases exponentially with the slab thickness. This unit of the nuclear cross section is not expressed as m^2 or cm^2 because these are huge units. It is generally expressed as **barn**.

$$1 \text{ barn} = 1 \text{ b} = 10^{-28} \text{ m}^2 = 100 \text{ fm}^2$$

4.5 Nuclear Fission

Nuclear fission, subdivision of a heavy atomic nucleus, such as that of uranium or plutonium, into two fragments of roughly equal mass. The process is accompanied by the release of a large amount of energy. The process may take place spontaneously in some cases or may be induced by the excitation of the nucleus with a variety of particles (e.g., neutrons, protons, deuterons, or α particles) or with electromagnetic radiation in the form of gamma rays. In the fission process, a large quantity of energy is released, radioactive products are formed, and several neutrons are emitted. These neutrons can induce fission in a nearby nucleus of fissionable material and release more neutrons that can repeat the sequence, causing a chain reaction in which a large number of nuclei undergo fission and an enormous amount of energy is released. If controlled in a nuclear reactor, such a chain reaction can provide power for society's benefit. If uncontrolled, as in the case of the so-called atomic bomb, it can lead to an explosion of awesome destructive force.

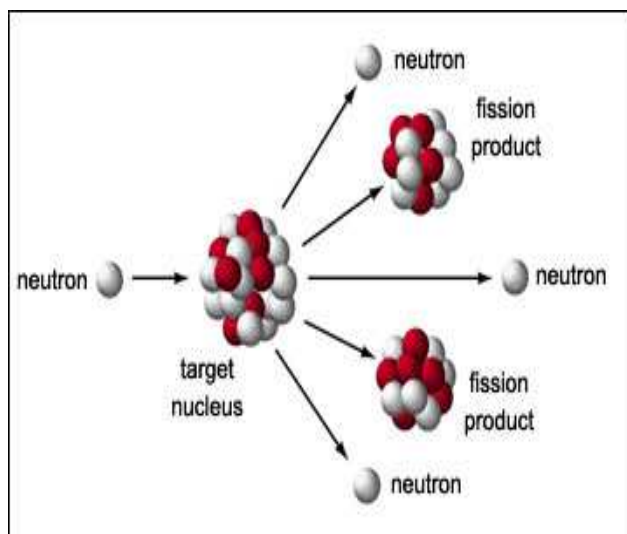

4.5.1 Controlled Thermonuclear Fission

As you might have guessed that the emission of several neutrons in the fission process leads to the possibility of a chain reaction if at least one of the fission neutrons induces fission in another fissile nucleus, which in turn fissions and emits neutrons to continue the chain. If more than one neutron is effective in inducing fission in other nuclei, the chain multiplies more rapidly. To maintain a sustained controlled nuclear reaction, for every 2 or 3 neutrons released, only one must be allowed to strike another nucleus. To realise all these nuclear engineer have devised a parameter to explain it mathematically. It's called as the **effective neutron multiplication factor**.

Definition:

The effective neutron multiplication factor is the ratio of number of neutrons produced by fission in one generation to the number of neutrons produced by fission in the preceding generation. In other words it is the average number of neutrons from one fission that cause another fission. Mathematically

$$k_{eff} = \frac{\text{no. of neutron produced in one generation}}{\text{no. of neutron produced in the preceding generation}}$$

The value of k_{eff} determines how a nuclear chain reaction proceeds:

- $k_{eff} < 1$ (**subcritical**): The system cannot sustain a chain reaction, and any beginning of a chain reaction dies out over time.
- $k_{eff} = 1$ (**critical**): Every fission causes an average of one more fission, leading to a fission then one more and one more. So the reaction is going to be sustained.
- $k_{eff} > 1$ (**supercritical**): The result is that the number of fission reactions increases exponentially leading to an explosion. Thus it is case of a bomb. Remember Hiroshima and Nagasaki! Those were the cases of supercriticality.

4.5.2 The four factor formula

These are the factors which are going to influence the k_{eff} value. These are as follows

- **The Reproduction factor, η :**

It is the ratio of neutrons produced from fission to the neutron absorption in fuel.

- **The Thermal utilisation factor, f :**

All the neutrons released during a fission event are fast neutrons. There are slowed down by elastic collision before they induce fission. A fraction of neutrons released that is thermalized can induce fission while the other fraction is captured. Thus it is the ratio of thermal neutrons absorbed by fuel to total thermal neutrons absorbed anywhere.

- **The Resonance Escape probability, p :**

Due to collision already few neutrons will attain the thermal energy and few other fast neutrons that starts to slow down to attain the thermal energy. Thus not all of the neutrons will reach the thermal energy simultaneously. Thus this factor is defined as the ratio of fission neutrons slowed to thermal energies without absorption to the total fission neutrons.

- **The Fast Fission Factor, ϵ :**

Still not all of the neutrons are going to get slowed down. Some of them may miss. They will still remain as fast and can break nucleus apart. So their contribution have to be also taken into account. Thus this factor is defined as the ratio of total fission neutrons from thermal and fast fission to fission neutrons from thermal fission.

Thus k_{eff} becomes

$$k_{eff} = \eta f p \epsilon$$

4.6 Controlled nuclear fission lab: The Nuclear Reactor

A nuclear reactor is a system that contains and controls sustained nuclear chain reactions. Reactors are used for generating electricity, moving aircraft carriers and submarines, producing medical isotopes for imaging and cancer treatment, and for conducting research. Well quite a large applicability! They are, however, differentiated either by their purpose or by their design features. The two main types of classification are

- **Research reactors**
- **Power reactors**

- Research reactors

These reactor are operated at universities and research centres in many countries. These reactors generate neutrons for multiple purposes, including producing radiopharmaceuticals for therapy, testing materials and conducting basic research.

- Power reactors

They are usually found in nuclear power plants. Dedicated to produce thermal energy that can be used for its own sake or converted into mechanical energy and ultimately, in the vast majority of cases, into electrical energy. These reactors are just exotic heat sources.

However these two reactors have entirely different designs. But we will only discuss the Power reactor as per the instruction of the course.

Design and construction of a power reactor

Although the basic principles appear simple, the process is fairly complex. The only natural element currently used for nuclear fission in reactors is uranium. Natural uranium is a highly energetic substance: one kilogram of it can generate as much energy as 10 tonnes of petrol. Naturally occurring uranium comprises, almost entirely, two isotopes: U^{238} (99.283%) and U^{235} (0.711%). But U^{238} does not undergo fission easily because energy required for the neutron is in the order of 0.001-0.01 MeV whereas U^{235} does even with a collision by thermal neutron, energy in the order of 0.04 eV. If you break apart an U^{235} by neutron following results

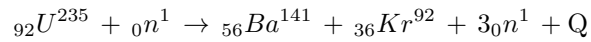

All you need to do is to absorb two of the liberated neutrons so that you get a critical value ($k_{eff} = 1$) to have sustained fission reaction and the remaining one neutron is to be made thermal. So to understand it better a reactor can be divided into various components. Let us discuss these one by one.

1. Neutron source:

Where does this first neutron come to collide with U^{235} ? Startup neutron comes from a neutron source used for stable and reliable initiation of nuclear chain reaction in nuclear reactors. Most commonly used is a small Cf^{252} -Be (Californium-Berillium) source. In these sources, an α -particle hits the Be nucleus and causes an exothermic reaction (α, n) producing a neutron and carbon nuclide.

2. Fuel:

To run the reactors it requires the use of nuclear fuels, elements that can be readily altered and will release thermal energy. Uranium is the most common element used as a nuclear fuel, although Plutonium, Thorium are also possible. The fuel is manufactured into small fuel pellets and are packed into fuel rods and surrounded by cladding to avoid leaking. These fuel rods can be further assembled into a fuel bundle depending upon the need.

3. Moderator:

The three produced neutrons are generally fast moving neutrons which are not going to break any nucleus apart. So they have to be made thermal. This reduction of energy is done by making collision with Deuterium oxide (D_2O , heavy water) or with graphite. These two are called as moderators.

4. Absorber:

As I have said earlier that for sustained nuclear fission $k_{eff} = 1$ therefore the production of excess neutrons have to be reduced. And that is done by absorbing the excess neutrons by Cd (Cadmium) rods. These rods are inserted into reactor chamber and the neutrons are got absorbed. These rods are also called as control rods.

5. Coolant:

The coolant, as its name implies, is used to remove heat from the core and move it to somewhere that it is useful. This keeps the fuel from overheating and melting down, at the same time as transferring the heat to water to make steam. Water (H_2O), and various gases are the most common coolants for nuclear reactors.

6. Protective Shield:

In a nuclear reactor there may be lots of harmful radiations and radioactive materials created. So the reactor is kept inside a protective shield to prevent radioactive material from being released so that no damage is done to the environment. The shields are usually dome-shaped constructions, made of high-density, steel-reinforced concretes.

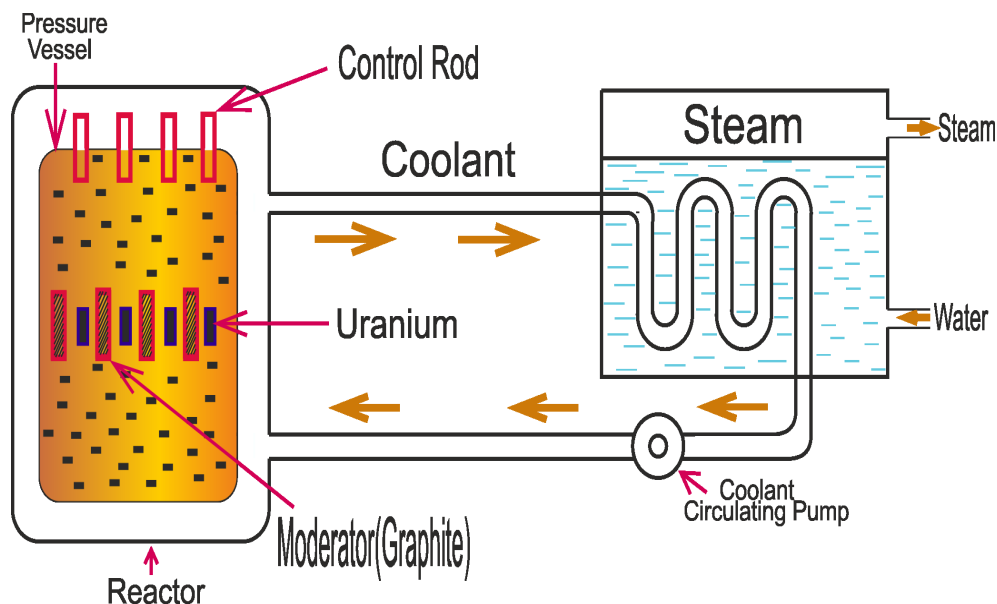

4.7 Nuclear Fusion

In nuclear physics, nuclear fusion is a nuclear reaction in which two or more nuclei collide at a very high energy and fuse together into a new nucleus, e.g. helium. If light nuclei are forced together, they will fuse with a yield of energy because the mass of the combination will be less than the sum of the masses of the individual nuclei. Fusion reactions have an energy density many times greater than nuclear fission and fusion reactions are themselves millions of times more energetic than chemical reactions. (*Remember the explanation of fusion from binding energy curve*).

The Sun is a hot star. Really hot star. However in astrophysical language it's an ordinary star. But all of the heat and light coming from the Sun comes from the fusion reactions happening inside the core of the Sun. Inside the Sun, the pressure is million of times more than the surface of the Earth, and the temperature reaches more than 15 million Kelvin. Massive gravitational forces create the these conditions for nuclear fusion. The primary source of solar energy, and similar size stars, is the fusion of hydrogen to form helium (the proton-proton chain reaction), which occurs at a solar-core temperature of around 15 million kelvin. The net result is the fusion of four protons into one α particle, with the release of two positrons and two neutrinos, and energy. Let's now see what is this pp-cycle (*Already we have did in the last semester's astrophysics paper*).

- **PP-cycle:**

The first step involves the fusion of two H nuclei (protons) into deuterium, releasing a positron and a neutrino as one proton changes into a neutron. It is a two-stage process; first, two protons fuse to form a diproton.

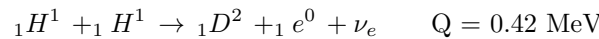

This first step is extremely slow, because the beta-plus decay of the diproton to deuterium is extremely rare (the vast majority of the time, it decays back into hydrogen-1 through proton emission). The positron immediately annihilates with an electron, and their mass energy, as well as their kinetic energy, is carried off by two gamma ray photons.



After this, the deuterium produced in the first stage can fuse with another proton to produce a light isotope of helium, He:

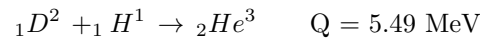

These onwards there are many possibilities.

PP-I

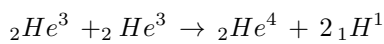

PP-II

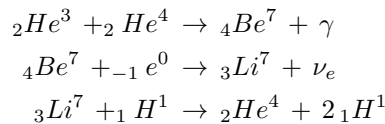

PP-III

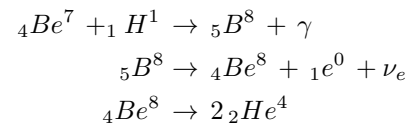

So the energy available to the other final state particles, both as rest energy and kinetic energy, is

$$\begin{aligned} \Delta m &= [4 \times 1.0078 - 4.0026] = 0.0287 \text{ amu, or} \\ \Delta E &= (0.0287 \times 931.5) \text{ MeV/amu} = 27 \text{ MeV.} \end{aligned}$$

The positron rest mass will be available for kinetic energy, too, since it will annihilate with an ambient electron. So except for the energy given to the neutrinos, which exit the star without depositing any energy, the 27 MeV is available to provide the solar luminosity. We note that the first step of the PP chain, the p-p interaction, provides only about 0.4 MeV of kinetic energy. So for each PP-I reaction (i.e. for every 4 protons), the fraction of stellar mass which is converted to energy luminosity is (except for the neutrinos) = $0.0287/4.0313 \sim 7 \times 10^{-3}$. Hence, the available hydrogen mass can be eventually converted into energy with an efficiency of 0.7%. *That's hell of a statistics. But interesting.!*

Chapter 5

Particle accelerators

Sometimes I think the tower of Pisa as the first particle accelerator a (nearly) vertical linear accelerator that Galileo used in his studies.... Leon Lederman

5.1 Introduction

You have probably read about or heard of particle accelerators in numerous scientific discussions, especially those pertaining to particle physics. For the record, they deserve more attention than they get! For example, the Large Hadron Collider (LHC) a particle accelerator is the single largest machine ever built by mankind. That staggering fact might make you wonder what is it actually? And perhaps more importantly, why should I care what it does? Let me put it this way. Did you know that you have a type of particle accelerator in your house right now? The cathode ray tube (CRT) of any TV or computer monitor is really a particle accelerator. *But now a days LCD monitors are in the market. See old days are gone.* The CRT takes particles (electrons) from the cathode, speeds them up and changes their direction using electromagnets in a vacuum and then smashes them into phosphor molecules on the screen. The collision results in a lighted spot, or pixel, on your TV or computer monitor. A particle accelerator works the same way, except that they are much bigger, the particles move much faster (near the speed of light) and the collision results in more subatomic particles and various types of nuclear radiation. Particles are accelerated by electromagnetic waves inside the device, in much the same way as a surfer gets pushed along by the wave. The more energetic we can make the particles, the better we can see the structure of matter. It's like breaking the rack in a billiards game. *Think about your 8 ball pool installed in your android phone.* When the cue (the white) ball (energized particle) speeds up, it receives more energy and so can better scatter the rack of balls (release more particles).

The formal Definition:

A particle accelerator is a machine that accelerates elementary particles, such as electrons or protons, to very high energies. On a basic level, particle accelerators produce beams of charged particles that can be used for a variety of research purposes.

5.1.1 Types of accelerators

Particle accelerators come in two basic types:

- **Circular** - Particles travel around in a circle until they collide with the target.
- **Linear** - Particles travel down a long, straight track and collide with the target.

5.2 The Cyclotron

Let's now discuss one of the most fundamental and earliest of accelerators, the cyclotron which is still used as the first stage of some large multi-stage particle accelerators. It is a device used to accelerate charged particles like protons, deuterons, α -particles, etc, to very high energies. It was invented by **Ernest O. Lawrence** in 1929-1930 at the University of California, Berkeley and patented in 1932. Lawrence received the 1939 Nobel prize in physics for this work.

5.2.1 Principle

A charged particle can be accelerated to very high energies by making it pass through an electric field a number of times. *So if question comes whether a neutron can be accelerated or not and the answer is "no" since neutron is chargeless.* This can be done with the help of a perpendicular magnetic field which throws the charged particle into a

circular motion, the frequency of which does not depend on the speed of the particle and the radius of the circular orbit. Thus electric field is used to accelerate in a translational manner and magnetic field is it used to make the charge particle to go it in a circular path. Below are the two figures of it. Left is a schematic diagram and right is 60-inch cyclotron at Berkeley's Rad Lab. Ernest Lawrence is second from the left if you can figure him out.

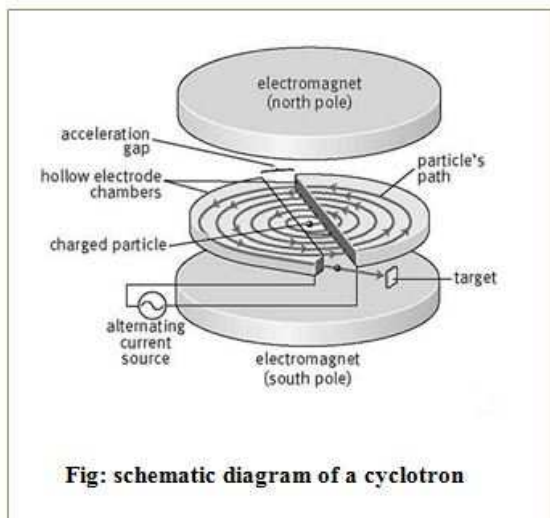

5.2.2 Construction

- It consists of two small, hollow, metallic half-cylinders D_1 and D_2 called dees as they are in the shape of D which are put back to back. (like your bicycle chain ring of the pedal)
- They are mounted inside a vacuum chamber (the whole device is in high vacuum (pressure $\sim 10^{-6}$ mm of Hg) so that the air molecules may not collide with the charged particles) between the poles of a powerful electromagnet.
- The dees are connected to the source of high frequency alternating voltage of few hundred kVs (depending upon your need). Thus these dees are acting as electrodes.
- The beam of charged particles to be accelerated is injected into the dees near their centre, in a plane perpendicular to the magnetic field.
- The charged particles are pulled out of the dees by a deflecting plate through a window to collide with the target.

5.2.3 Theory

Suppose a positive ion, say a proton, enters the gap between the two dees and finds dee D_1 to be negative. It gets accelerated towards dee D_1 . As it enters the dee D_1 , it does not experience any electric field due to shielding effect of the metallic dee. The perpendicular magnetic field throws it into a circular path. At the instant the proton comes out of dee D_1 , it finds dee D_1 positive and dee D_2 . It moves faster through D_2 describing a larger semicircle than before. Thus if the frequency of the applied voltage is kept exactly the same as the frequency of revolution of the proton, then every time the proton reaches the gap between the two dees, the electric field is reversed and proton receives a push and finally it acquires very high energy. This is called the cyclotrons resonance condition. The proton follows a spiral path. The accelerated proton is ejected through a window by a deflecting voltage and hits the target.

Let a particle of charge q and mass m enter a region of magnetic field \vec{B} with a velocity \vec{v} normal to the field \vec{B} . The particle follows a circular path of radius r , the necessary centripetal force being provided by the magnetic field. Therefore,

$$\text{Centripetal force on charge } q = \text{Magnetic force on charge } q$$

$$\frac{m v^2}{r} = B q v$$

$$\frac{m v}{r} = B q$$

$$\frac{v}{r} = \frac{B q}{m}$$

$$\omega = \frac{B q}{m}$$

$$\nu = \frac{B q}{2 \pi m}$$

Clearly, this frequency is independent of both the velocity of the particle and the radius of the orbit and is called **cyclotron frequency** or **magnetic resonance frequency**. This is the key fact which is made use of in the operation

of a cyclotron. Thus as the beam spirals out, the frequency doesn't decrease and it must continue to accelerate as it is travelling more and more distance at the same time. As the beam spirals out and thus acquiring higher and higher velocities just before coming out the dees it attains the maximum velocity and thus with maximum kinetic energy. Hence

$$\frac{m v_{max}^2}{r_{max}} = B q v_{max}$$

$$v_{max} = \frac{B q r_{max}}{m}$$

$$\frac{1}{2} m v_{max}^2 = \frac{1}{2} m \frac{B^2 q^2 r_{max}^2}{m^2}$$

$$KE_{max} = \frac{B^2 q^2 r_{max}^2}{2m}$$

5.2.4 Utility

- The high energy particles produced in a cylinder are used to bombard nuclei and study the resulting nuclear reactions and hence investigate nuclear structure.
- It is used to implant ions into solids and modify their properties or even synthesis new materials.
- It is used to produce radioactive isotopes which are used in hospitals for diagnosis and treatment.

5.2.5 Drawbacks

- The significant drawback that the cyclotron suffers is from the effect of relativistic mass. According to the Einsteins special theory of relativity, the mass of a particle increases with the increase in its velocity as

$$m = \frac{m_0}{\sqrt{1 - \frac{v^2}{c^2}}}$$

Where m_0 is the rest mass of the particle. At high velocities, the cyclotron frequency will decrease due to increase in mass. This will throw the particles out of resonance with the oscillating field. That is, as the ions reach the gap between the dees, the polarity of the dees is not reversed at that instant. Consequently the ions are not accelerated further. That's a serious thing people are concerned with.

- Electrons cannot be accelerated in a cyclotron. A large increase in their energy increases their velocity to a very large extent. This throws the electrons out of step with the oscillating field.

5.3 The Linear Accelerator : LINAC

In 1924 Gustaf Ising, a Swedish physicist, proposed accelerating particles using alternating electric fields, with drift tubes positioned at appropriate intervals to shield the particles during the half-cycle when the field is in the wrong direction for acceleration. Four years later, the Norwegian engineer Rolf Wideroe built the first machine of this kind, successfully accelerating potassium ions to an energy of 50,000 electron volts (50 keV).

5.3.1 Principle

This type of particle accelerator that imparts a series of relatively small increases in energy to subatomic particles as they pass through a sequence of alternating electric fields set up in some hollow tubes of variable lengths arranged in a linear manner. The small accelerations acquired by particles gets added together each time they come out of the tube to give rise to a greater energy than could be achieved by the voltage used in one tube alone.

5.3.2 Construction

The exact design of a LINAC depends on the type of the particle that is being accelerated: electrons, protons or ions. But the basic necessities are the following

- A **particle gun** is located at the left in the drawing. If the particle is e^- then a cold cathode or a hot cathode or a photodiode is placed. For protons an ion source is needed. If heavier particles are to be accelerated (e.g. Uranium ions) a specialised ion source is placed.
- A **high voltage source** is required to emit particles out of the particle gun ie for initial injection of particles.
- **Hollow evacuated cylindrical tubes**, also called as **drift tubes** are used to accelerate the particles which are coming out of the particle gun and also pack them into bunches. Thus these tubes are also sometimes called as

buncher. However the lengths will vary with the application.

- A **radio frequency energy source** is needed to energize the cylindrical tubes which will then behave as electrodes so that particles can accelerate.

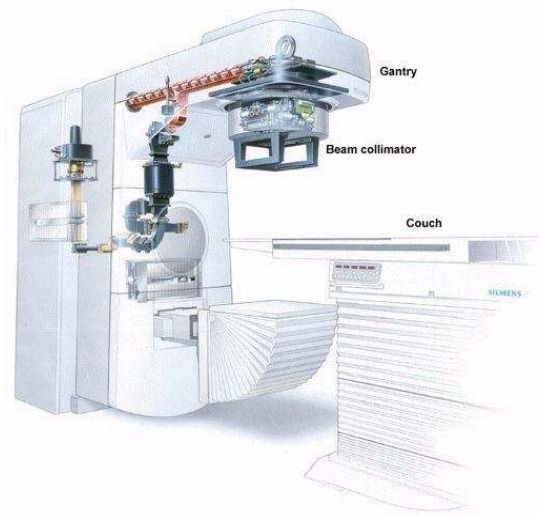
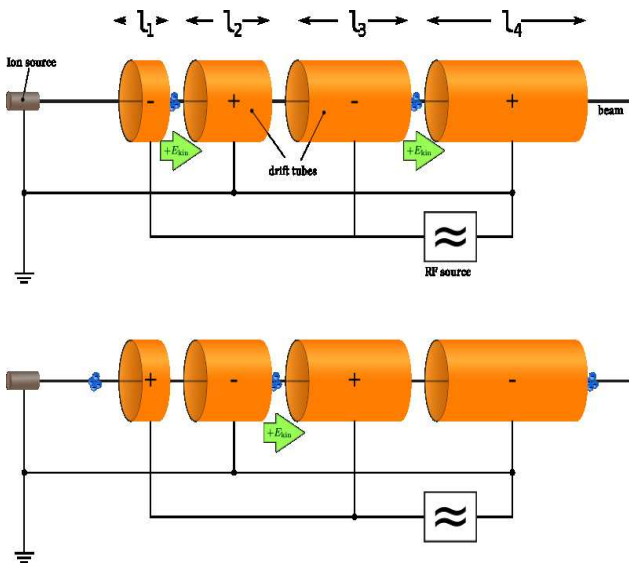

5.3.3 Theory

As the theme is accelerating charge particle therefore particles are kicked by a radio-frequency alternating electric fields that are applied over short distances which is applied between the drift tubes (across the gap between them). As the particles leave a tube there must be an accelerating field across the gap so the tube it is in must be of the same potential as the particle's charge (repelling it away from where it has come from) and the one it is about to enter be of the opposite potential (attracting it towards the next tube). However inside the tube the particles do not feel any force because of effect called as **Faraday's cage** which states that electric charge on a conductor sits on the outer surface of it or electric field inside a conductor is always zero. (*That's why you should not come out of car while driving during thunderstorm*). The passage of the particle between drift tubes is synchronized with the phase of the accelerating field - the particle is only subjected to the field when it is in the part of the cycle that accelerates it. In other words the time required for particles to pass through any tube is exactly made equal with frequency of the polarity reversal of the field.

Let a particle of charge q and mass m enter a region of electric field where the particle is accelerated by a potential V . Now the kinetic energy acquired by the particle is

$$\frac{1}{2} m v^2 = V q$$

But this amount of KE will be attained only in gaps between the tubes. Inside the tube the KE will remain fixed as the tube will serve as Faraday's cage. If there are n numbers of such tubes between each gap that much amount of KE will be added everytime. Thus after passing through n tubes the KE will increase to a larger extent. Let v_n is the vel. after the n th tube. Then

$$\begin{aligned} \frac{1}{2} m v_n^2 &= n V q \\ v_n &= \sqrt{\frac{2 n V q}{m}} \end{aligned}$$

Thus the velocities after coming out of each tube are in the ratio of $v_1 : v_2 : v_3 : v_4 : \dots = 1 : \sqrt{2} : \sqrt{3} : \sqrt{4} : \dots$

If L_n is the length of such n th tube and the particles need a time t to cross that then

$$\begin{aligned} L_n &= v_n t \\ &= v_n \frac{1}{2\nu} \quad \text{where } \nu \text{ is the frequency of the oscillator} \\ &= \sqrt{\frac{2 n V q}{m}} \frac{1}{2\nu} \end{aligned}$$

Thus you can also see that the length of the tubes are also in the ratio of $L_1 : L_2 : L_3 : L_4 : \dots = 1 : \sqrt{2} : \sqrt{3} : \sqrt{4} : \dots$

5.3.4 Utility

- In the linac, the particles are accelerated multiple times by the applied voltage and hence used to study matter-antimatter annihilation and in production of radio-isotope used in medical purposes.
- Linac-based radiation therapy is used in cancer therapy and in treatment of benign and malignant disease.

5.3.5 Drawbacks

- The device length limits the locations where one may be placed.
- A great number of devices and their associated power supplies are required, increasing the construction and maintenance expense of this portion.

5.4 LINAC vs Cyclotron

Let me put it straight in a tabular form.

Table 5.1: Differences between LINAC and Cyclotron

| LINAC | Cyclotron |
|-----------------------------------|--------------------------------|
| Large space requirement but light | Compact but heavy |
| Very Expensive | Relatively Cheaper |
| Upgradable in energy | Difficult to upgrade in energy |
| Straightforward beam extraction | Difficult extraction of beam |

Chapter 6

Nuclear Detectors

The awkward moment when Logan (Wolverine) walked through a metal detector and the detector starts beeping.. One of the sequels of X-Men

6.1 Introduction

Nuclear radiation detectors serve to determine the composition and measure the intensity of radiation, to measure the energy spectra of particles, to study the processes of interaction between fast particles and atomic nuclei, and to study the decay processes of unstable particles. Interactions of α , β and γ radiations with matter may produce positively charged ions and electrons. The detectors are devices that measure this ionisation and produce and produce an observable output. Early detectors used photographic plates to detect "tracks" left by nuclear interactions. Advances in electronics, particularly the invention of the transistor, allowed the development of electronic detectors. Advances in materials, particularly ultra-pure materials, and methods of fabrication have been critical to the creation of new and better detectors. All of these have increased the accuracy of measurements and also the efficiency of detectors.

6.1.1 Classification of detectors

We may conveniently classify the detectors into two classes

- Electrical detectors
- Optical detectors

Table 6.1: Classification of detectors with examples

| Electrical | Optical |
|-------------------------|-----------------------|
| Ionization Chamber | Cloud Chamber |
| Proportional Counter | Bubble Chamber |
| Geiger-Muller Counter | Spark Chamber |
| Scintillation Counter | Photographic Emulsion |
| Cerenkov Counter | |
| Semi-conductor detector | |

6.1.2 Efficiency of detectors

An important characteristic of nuclear radiation detectors that register individual particles is their efficiency - the probability of the registration of a particle upon entry into the effective volume of the detector. Efficiency is a function of the design of the detector and the properties of the working medium. However according to Hofstadter a perfect detector might have the following characteristics

- 100% detection efficiency. (*No events should be missed out*)
- High-speed counting (*More quickly it detects, better for us*)
- Good energy resolution (*Two events even with small energy differences should be measured. That means they have to counted two instead of one.*)
- Linearity of response (*More radiation produced more should be the detection*)
- Application to virtually to all types of particles and radiations (*One single detector should capable of detecting all types of particles. Though it's not possible.*)
- Virtually no limit to the highest energy detectable (*This is also highly anticipated for. It will be very nice to design a detector which can detect particles even in GeV range or higher*)

- Reasonably large solid angles of acceptance (*The detector should be rotated in all possible direction so that no event gets missed.*)
- Discrimination between types of particles. (*All particles should be classified once it detected.*)
- Picturization of the event. (*A photo will be a nice thing to upload in facebook.*)

6.2 Cloud Chamber

6.2.1 Introduction

A cloud chamber makes the invisible visible, allowing us to see delicate, wispy proof that there are tiny particles whose story starts in outer space shooting through all of us, every minute of every day. It's a unique device for detection and measurement of elementary particles and other ionizing radiation. Also known as a Wilson Cloud Chamber after the name of inventor C.T.R. Wilson in 1911. In particular, the discoveries of the positron in 1932 and the muon in 1936, both by Carl Anderson (awarded a Nobel Prize in Physics in 1936), used cloud chambers. Discovery of the kaon by George Rochester and Clifford Charles Butler in 1947, also was made using a cloud chamber as the detector.

6.2.2 Construction

The construction of the cloud chamber is very simple and naive one. You can make it in your home also. (*But I doubt if you could detect a particle in that*) Here is what you need to construct it

- A closed chamber. (*Say a fish tank ie an aquarium of any shape*)
- Some alcohol (*Go to the chemistry department. I never said to go to a wine shop.*)
- Some dry ice. (*Go to the daily bazaar and ask in the fish seller.*)
- A perforated substance. (*Again chemistry department. One iron net like that net which you use while heating something in Bunsen burner.*)
- One piece of cloth to put alcohol.
- A hot source. (*A hot water bag will also work*)
- One black piece of cloth to cover up the entire set up.
- One light source (*A simple torch. Don't use mobile phone light. You will need some brightness.*)

All you have to maintain inside the chamber a temperature gradient and a supersaturated environment. Temperature gradient from top to bottom. So bottom of the chamber is to be kept cool and top of the chamber is to be kept hot. This is why the dry ice is kept at the bottom of the chamber the hot source is placed is placed at the top. But just below the hot source the perforated substance is kept upon which there lies the piece of cloth and over that piece of cloth plenty of alcohol is poured. This hot source will evaporate the alcohol inside the chamber since alcohol is a volatile substance. As the vapour falls, it cools rapidly due to the dry ice and the air becomes supersaturated and after a while the entire chamber will become supersaturated with alcohol vapour.

6.2.3 Working Principle

Now let us consider a charged particle (such as α radiation from a chunk of radioactive ore) zips through the chamber at high speed. It bumps into alcohol molecules and ionizes them - it creates a trail of ionized molecules marking its path. Now, the vapours are such that they really want to produce mist; The trail of ionized molecules is enough to do that - the ions attract a bunch of molecules, the resulting clumps attract even more, and before you know it a droplet of alcohol is formed, then another, and another. Well, a trail of mist follows the particle. However, these droplets are visible as a "cloud" track that persist for several seconds while the droplets fall through the vapor which can be better seen by a tangential application of a light source. Then how identify which particle's tract they are? Well, the tracks have characteristic shapes. For example, an α particle track is thick and straight, while an electron track is wispy and shows more evidence of deflections by collisions.

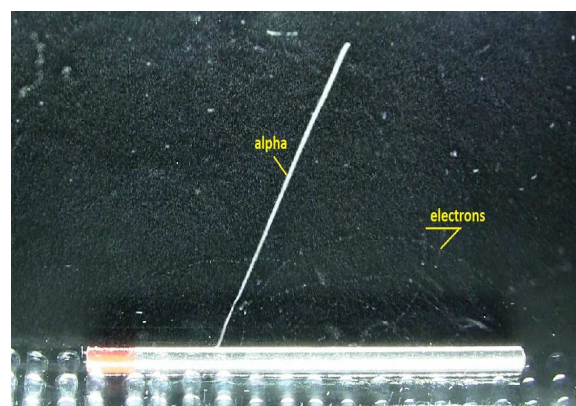
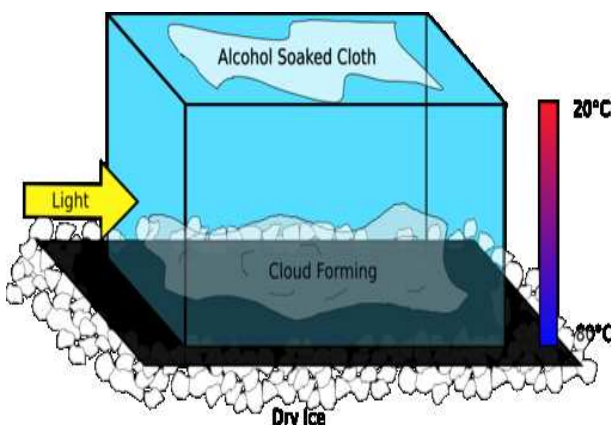

6.3 Ionisation Chamber

6.3.1 Introduction

The ionization chamber is the simplest of all gas-filled radiation detectors, and is widely used for the detection and measurement of certain types of ionizing radiation; X-rays, γ rays, and β particles. The term "ionization chamber" is used exclusively to describe those detectors which collect all the charges created (ie the current) by direct ionization within the gas through the application of an electric field. In an ideal case, the amount of electric current generated in an ionization chamber is directly proportional to the intensity of the radiation field. Thus the ionisation chambers have a good uniform response to radiation over a wide range of energies and hence finds application in the nuclear power industry, research labs, radiography, radiobiology, and environmental monitoring.

6.3.2 Construction

It's construction is also very simple but vastly modified as compared to cloud chamber. Following are the basic needs to construct an ionisation chamber.

- Two collecting electrodes: the anode and cathode (the anode is positively charged with respect to the cathode). In most cases, the outer chamber wall serves as the cathode. The electrodes may be in the form of parallel plates (Parallel Plate Ionization Chambers: PPIC), or a cylinder arrangement with a coaxially located internal anode wire. (*Just think of this you have a bottle of cold drink behaving as cathode and you insert the straw to suck the drinks behaving as the anode*)
- A voltage source (*This will create an electric field between the electrodes*)
- An electrometer circuit (*This is capable of measuring the very small output current which is in the region of femtoamperes to picoamperes*)

6.3.3 Working Principle

First the potential difference between the anode and cathode is often in the 100 to 500 volt range. The most appropriate voltage depends on a number of things such as the chamber size (the larger the chamber, the higher the required voltage). When an ionising radiation or a charged particle enters the chamber, it converts some of the gas molecules to positive ions and electrons; under the influence of the electric field, these particles migrate to the wall and the wire, respectively, and cause an observable current to flow through the circuit. This accumulated charge is proportional to the number of ion pairs created, and hence implies the strength the radiation dose which is a measure of the total ionizing dose entering the chamber. However there is one problem with this set up. As the produced electrons move toward the anode, on its journey it may recombine with other ions to produce a neutral element. Thus there is possibility that the ion current will diminish due to recombination. Thus it can be seen that in the "ion chamber" operating region the collection of ion pairs is either effectively constant or less than the expected value over a range of applied voltage, as due to its relatively low electric field strength.

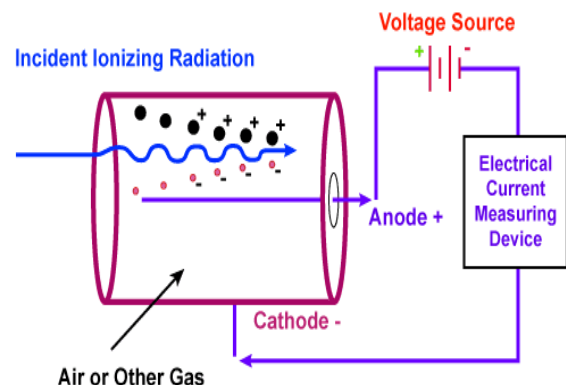
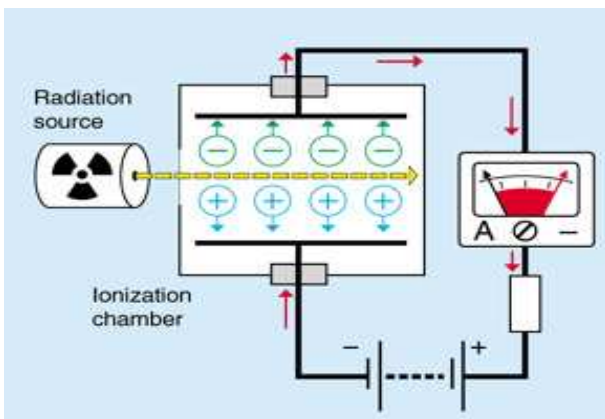

6.4 Proportional Counter

6.4.1 Introduction

The proportional counter is a type of gaseous ionization detector device used to measure particles of ionizing radiation. The key feature is its ability to measure the energy of incident radiation, by producing a detector output pulse that is proportional to the radiation energy absorbed by the detector due to an ionizing event, hence the detector's name. It is widely used where discrimination between radiation types is required, such as between alpha and beta particles.

6.4.2 Construction

A proportional counter is much advanced version of an ionisation chamber, and operates in a voltage region more than ionisation chamber.

- The anodes are usually thin metal wires, and their electric field causes the electrons to drift towards the anodes where the field strength is highest. Anodes in the detector volume are held at a positive potential with respect to the rest of the detector.
- The cathode is cylinder arranged in a co-axial manner. The metal wire is at the center surrounding that the cathode cylinder.
- A voltage source (*This will create an electric field between the electrodes*)
- An electrometer circuit (*This is capable of measuring the very small output current which is in the region of femtoamperes to picoamperes*)

6.4.3 Working Principle

In a proportional counter the fill gas of the chamber is an inert gas which is ionised by incident radiation. An ionizing particle entering the gas collides with a molecule of the inert gas and ionises it to produce an electron and a positively charged atom, commonly known as an "ion pair". As the charged particle travels through the chamber it leaves a trail of ion pairs along its trajectory, the number of which is proportional to the energy of the particle if it is fully stopped within the gas. The chamber geometry and the applied voltage is such that in most of the chamber the electric field strength is strong enough to prevent re-combination of the ion pairs and causes positive ions to drift towards the cathode and electrons towards the anode. This is the "ion drift" region. In the immediate vicinity of the anode wire, the field strength becomes large enough to produce Townsend avalanches. This avalanche region occurs only fractions of a millimeter from the anode wire, which itself is of a very small diameter. The purpose of this is to use the multiplication effect of the avalanche produced by each ion pair. This is the "avalanche" region. Therefore it can be said that the proportional counter has the key design feature of two distinct ionisation regions:

- *Ion drift region:* in the outer volume of the chamber - creation of number ion pairs proportional to incident radiation energy.
- *Avalanche region:* in the immediate vicinity of the anode - Charge amplification of ion pair currents, while maintaining localised avalanches.

In summary, the proportional counter is an ingenious combination of two ionisation mechanisms in the one chamber which greatly improves the signal-to-noise ratio of the detector and hence finds wide practical use.

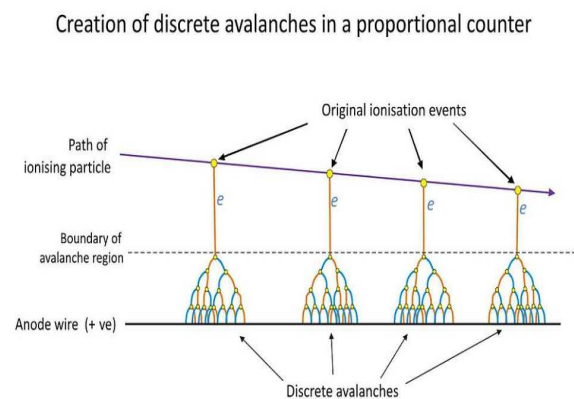
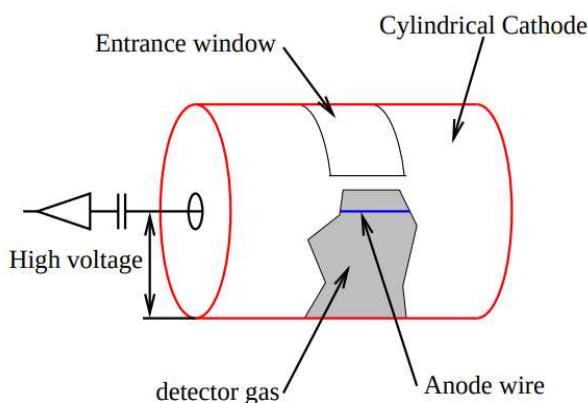

6.5 Geiger-Muller Counter, (GM counter)

6.5.1 Introduction

It is an instrument used for detecting and measuring ionizing radiation, α , β and γ radiation. The principle of working remains the same as that of proportional counter, charged particles ionize the gas through which they pass, the electrons so produced during ionization get accelerated under high potential and further produce ionization. The main advantages are that they are relatively inexpensive, durable and easily portable. But they have very low efficiency in determining the exact energy of the detected radiation.

6.5.2 Construction

The construction of the GM counter is exactly similar to that of the proportional counter. A Geiger tube which is nothing but a charged capacitor with a region between them occupied by a gas. The apparatus consists of two parts, the tube and the (counter + power supply). The Geiger-Mueller tube is usually cylindrical, with a wire down the center. The (counter + power supply) have voltage controls and timer options. A high voltage is established across the cylinder and the wire.

- The anodes are usually thin metal wires, which are held at a positive potential with respect to the rest of the detector.
- The cathode is cylinder arranged in a co-axial manner. The metal wire is at the center surrounding that the cathode cylinder.
- A voltage source (*This will create an electric field between the electrodes*)
- An electrometer circuit (*This is capable of measuring the very small output current which is in the region of femtoamperes to picoamperes*)

6.5.3 Working Principle

When ionizing radiation such as an α , β or γ particle enters the tube, it can ionize some of the gas molecules in the tube. From these ionized atoms, an electron is knocked out of the atom, and the remaining atom is positively charged. The high voltage in the tube produces an electric field inside the tube. The electrons that were knocked out of the atom are attracted to the positive electrode, and the positively charged ions are attracted to the negative electrode. This produces a pulse of current in the wires connecting the electrodes, and this pulse is counted. After the pulse is counted, the charged ions become neutralized, and the Geiger counter is ready to record another pulse. In order for the Geiger counter tube to restore itself quickly to its original state after radiation has entered, a gas is added to the tube. This gas is called as a quench gas to ensure each pulse discharge terminates; a common mixture is 90% argon, 10% methane. For low voltages, no counts are recorded. This is because the electric field is too weak for even one pulse to be recorded. As the voltage is increased, eventually one obtains a counting rate. The voltage at which the G-M tube just begins to count is called the starting potential. The counting rate quickly rises as the voltage is increased. The rise is so fast, that the graph looks like a step potential. After the quick rise, the counting rate levels off. This range of voltages is termed the plateau region. Eventually, the voltage becomes too high and we have continuous discharge. The threshold voltage is the voltage where the plateau region begins. Proper operation is when the voltage is in the plateau region of the curve.

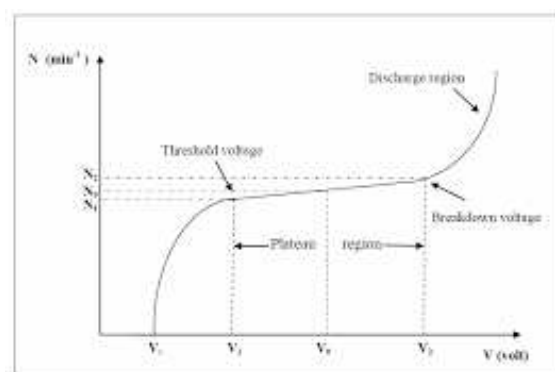
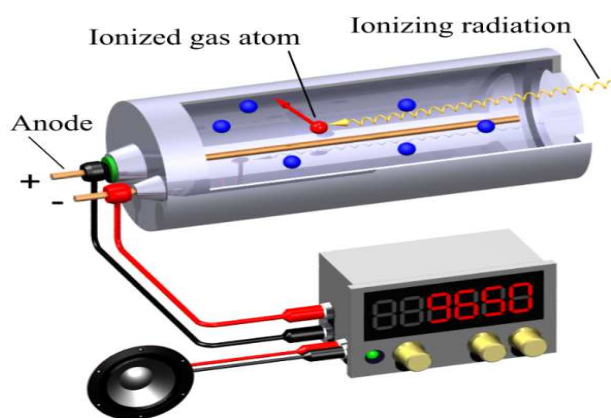

Fig.1

- **Dead Time:** After a count has been recorded, it takes the G-M tube a certain amount of time to reset itself to be ready to record the next count. The resolving time or dead time, T , of a detector is the time it takes for the detector to reset itself. Since the detector is not operating while it is being reset, the measured activity is not the true activity of the sample. If the counting rate is high, then the effect of dead time is very important.