

# Three Level NPC Q2Pack Module

## NXH400N100H4Q2F2PG, NXH400N100H4Q2F2SG, NXH400N100H4Q2F2SG-R

This high-density, integrated power module combines high-performance IGBTs with rugged anti-parallel diodes.

### Features

- Extremely Efficient Trench with Field Stop Technology
- Low Switching Loss Reduces System Power Dissipation
- Module Design Offers High Power Density
- Low Inductive Layout
- Low Package Height
- These Devices are Pb-Free, Halogen Free/BFR Free and are RoHS Compliant

### Typical Applications

- Solar Inverters
- Uninterruptable Power Supplies Systems

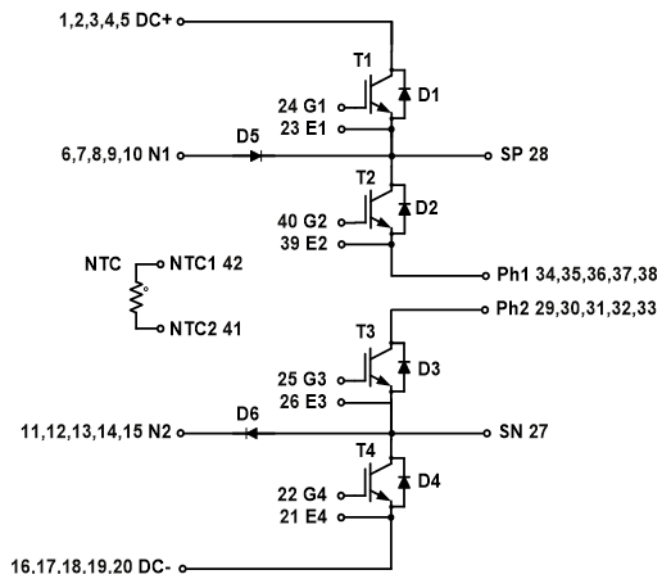
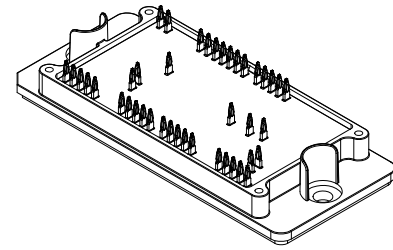
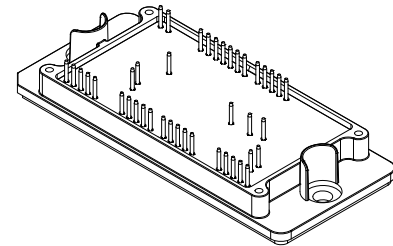

Figure 1. NXH400N100H4Q2F2PG/SG/SG-R Schematic Diagram



Q2PACK INPC PRESS FIT PINS  
PIM42, 93x47 (PRESSFIT)  
CASE 180BH



Q2PACK INPC SOLDER PINS  
PIM44, 93x47 (SOLDER PIN)  
CASE 180BS

### MARKING DIAGRAM

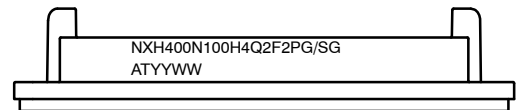

NXH400N100H4Q2F2PG/SG = Specific Device Code  
G = Pb-Free Package  
AT = Assembly & Test Site Code  
YYWW = Year and Work Week Code

### PIN CONNECTIONS

See details pin connections on page 2 of this data sheet.

### ORDERING INFORMATION

See detailed ordering and shipping information on page 6 of this data sheet.

PIN CONNECTIONS

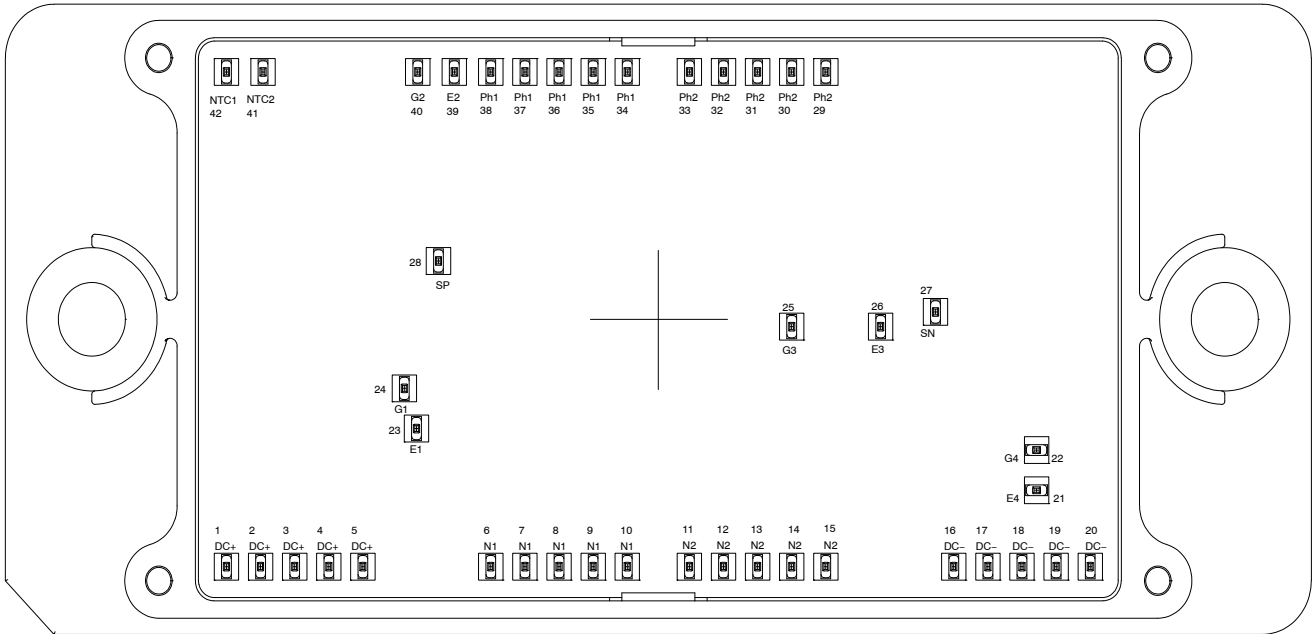

Figure 2. Pin Connections

**ABSOLUTE MAXIMUM RATINGS** ( $T_J = 25^\circ\text{C}$  unless otherwise noted)

| Rating | Symbol | Value | Unit |
|--------|--------|-------|------|
|--------|--------|-------|------|

**OUTER IGBT (T1, T4)**

|  |                |                |                  |
|--|----------------|----------------|------------------|
| Collector-Emitter Voltage  | $V_{CES}$      | 1000           | V                |
| Gate-Emitter Voltage<br>Positive Transient Gate-Emitter Voltage ( $T_{pulse} = 5 \mu\text{s}$ , $D < 0.10$ ) | $V_{GE}$       | $\pm 20$<br>30 | V                |
| Continuous Collector Current @ $T_C = 80^\circ\text{C}$  | $I_C$          | 409            | A                |
| Pulsed Peak Collector Current @ $T_C = 80^\circ\text{C}$ ( $T_J = 150^\circ\text{C}$ )                       | $I_{C(Pulse)}$ | 1227           | A                |
| Maximum Power Dissipation ( $T_J = 150^\circ\text{C}$ )  | $P_{tot}$      | 959            | W                |
| Minimum Operating Junction Temperature   | $T_{JMIN}$     | -40            | $^\circ\text{C}$ |
| Maximum Operating Junction Temperature   | $T_{JMAX}$     | 175            | $^\circ\text{C}$ |

**INNER IGBT (T2, T3)**

|  |                |                |                  |
|--|----------------|----------------|------------------|
| Collector-Emitter Voltage  | $V_{CES}$      | 1000           | V                |
| Gate-Emitter Voltage<br>Positive Transient Gate-Emitter Voltage ( $T_{pulse} = 5 \mu\text{s}$ , $D < 0.10$ ) | $V_{GE}$       | $\pm 20$<br>30 | V                |
| Continuous Collector Current @ $T_C = 80^\circ\text{C}$  | $I_C$          | 360            | A                |
| Pulsed Peak Collector Current @ $T_C = 80^\circ\text{C}$ ( $T_J = 150^\circ\text{C}$ )                       | $I_{C(Pulse)}$ | 1080           | A                |
| Maximum Power Dissipation ( $T_J = 175^\circ\text{C}$ )  | $P_{tot}$      | 805            | W                |
| Minimum Operating Junction Temperature   | $T_{JMIN}$     | -40            | $^\circ\text{C}$ |
| Maximum Operating Junction Temperature   | $T_{JMAX}$     | 175            | $^\circ\text{C}$ |

**IGBT INVERSE DIODE (D1, D2, D3, D4)**

|   |           |      |   |
|---|-----------|------|---|
| Peak Repetitive Reverse Voltage                               | $V_{RRM}$ | 1000 | V |
| Continuous Forward Current @ $T_C = 80^\circ\text{C}$         | $I_F$     | 192  | A |
| Repetitive Peak Forward Current ( $T_J = 175^\circ\text{C}$ ) | $I_{FRM}$ | 576  | A |

# NXH400N100H4Q2F2PG, NXH400N100H4Q2F2SG, NXH400N100H4Q2F2SG-R

## ABSOLUTE MAXIMUM RATINGS ( $T_J = 25^\circ\text{C}$ unless otherwise noted) (continued)

| Rating | Symbol | Value | Unit |
|--------|--------|-------|------|
|--------|--------|-------|------|

### IGBT INVERSE DIODE (D1, D2, D3, D4)

|   |                   |     |                  |
|---|-------------------|-----|------------------|
| Maximum Power Dissipation ( $T_J = 175^\circ\text{C}$ ) | $P_{\text{tot}}$  | 482 | W                |
| Minimum Operating Junction Temperature                  | $T_{\text{JMIN}}$ | -40 | $^\circ\text{C}$ |
| Maximum Operating Junction Temperature                  | $T_{\text{JMAX}}$ | 175 | $^\circ\text{C}$ |

### NEUTRAL POINT DIODE (D5, D6)

|   |                   |      |                  |
|---|-------------------|------|------------------|
| Peak Repetitive Reverse Voltage                               | $V_{\text{RRM}}$  | 1200 | V                |
| Continuous Forward Current @ $T_C = 80^\circ\text{C}$         | $I_F$             | 140  | A                |
| Repetitive Peak Forward Current ( $T_J = 175^\circ\text{C}$ ) | $I_{\text{FRM}}$  | 420  | A                |
| Maximum Power Dissipation ( $T_J = 175^\circ\text{C}$ )       | $P_{\text{tot}}$  | 401  | W                |
| Minimum Operating Junction Temperature                        | $T_{\text{JMIN}}$ | -40  | $^\circ\text{C}$ |
| Maximum Operating Junction Temperature                        | $T_{\text{JMAX}}$ | 175  | $^\circ\text{C}$ |

Stresses exceeding those listed in the Maximum Ratings table may damage the device. If any of these limits are exceeded, device functionality should not be assumed, damage may occur and reliability may be affected.

1. Refer to [ELECTRICAL CHARACTERISTICS](#) and/or APPLICATION INFORMATION for Safe Operating parameters.

## THERMAL AND INSULATION PROPERTIES ( $T_J = 25^\circ\text{C}$ unless otherwise noted)

| Rating | Symbol | Value | Unit |
|--------|--------|-------|------|
|--------|--------|-------|------|

### THERMAL PROPERTIES

|   |                   |            |                  |
|---|-------------------|------------|------------------|
| Operating Temperature under Switching Condition | $T_{\text{VJOP}}$ | -40 to 150 | $^\circ\text{C}$ |
| Storage Temperature Range                       | $T_{\text{stg}}$  | -40 to 125 | $^\circ\text{C}$ |

### INSULATION PROPERTIES

|   |                 |      |                  |
|---|-----------------|------|------------------|
| Isolation Test Voltage, $t = 2$ s, 50 Hz (Note 3) | $V_{\text{is}}$ | 4000 | $V_{\text{RMS}}$ |
| Creepage Distance                                 |                 | 12.7 | mm               |
| Comparative Tracking Index                        | CTI             | >600 |                  |

Stresses exceeding those listed in the Maximum Ratings table may damage the device. If any of these limits are exceeded, device functionality should not be assumed, damage may occur and reliability may be affected.

2. Refer to [ELECTRICAL CHARACTERISTICS](#) and/or APPLICATION INFORMATION for Safe Operating parameters.
3. 4000  $V_{\text{ACRMS}}$  for 1 second duration is equivalent to 3333  $V_{\text{ACRMS}}$  for 1 minute duration.

# NXH400N100H4Q2F2PG, NXH400N100H4Q2F2SG, NXH400N100H4Q2F2SG-R

## ELECTRICAL CHARACTERISTICS (T<sub>J</sub> = 25°C unless otherwise specified)

| Characteristic | Test Conditions | Symbol | Min | Typ | Max | Unit |
|----------------|-----------------|--------|-----|-----|-----|------|
|----------------|-----------------|--------|-----|-----|-----|------|

### OUTER IGBT (T1, T4) CHARACTERISTICS

|                                       |  |                      |     |       |       |     |
|---------------------------------------|--|----------------------|-----|-------|-------|-----|
| Collector-Emitter Cutoff Current      | V <sub>GE</sub> = 0 V, V <sub>CE</sub> = 1000 V  | I <sub>CES</sub>     | –   | –     | 500   | μA  |
| Collector-Emitter Saturation Voltage  | V <sub>GE</sub> = 15 V, I <sub>C</sub> = 400 A, T <sub>J</sub> = 25°C  | V <sub>CE(sat)</sub> | –   | 1.77  | 2.3   | V   |
|                                       | V <sub>GE</sub> = 15 V, I <sub>C</sub> = 400 A, T <sub>J</sub> = 150°C   |                      | –   | 2.11  | –     |     |
| Gate-Emitter Threshold Voltage        | V <sub>GE</sub> = V <sub>CE</sub> , I <sub>C</sub> = 400 mA  | V <sub>GE(TH)</sub>  | 4.1 | 5.1   | 6.1   | V   |
| Gate Leakage Current                  | V <sub>GE</sub> = ±20 V, V <sub>CE</sub> = 0 V   | I <sub>GES</sub>     | –   | –     | ±2000 | nA  |
| Internal Gate Resistor                |  | R <sub>G</sub>       | –   | 1.44  | –     | Ω   |
| Turn-on Delay Time                    | T <sub>J</sub> = 25°C<br>V <sub>CE</sub> = 600 V, I <sub>C</sub> = 150 A<br>V <sub>GE</sub> = -8 V, 15 V, R <sub>Gon</sub> = 6 Ω,<br>R <sub>Goff</sub> = 11 Ω  | t <sub>d(on)</sub>   | –   | 151   | –     | ns  |
| Rise Time                             |  | t <sub>r</sub>       | –   | 35    | –     |     |
| Turn-off Delay Time                   |  | t <sub>d(off)</sub>  | –   | 551   | –     |     |
| Fall Time                             |  | t <sub>f</sub>       | –   | 68    | –     | μJ  |
| Turn-on Switching Loss per Pulse      |  | E <sub>on</sub>      | –   | 3270  | –     |     |
| Turn-off Switching Loss per Pulse     |  | E <sub>off</sub>     | –   | 5100  | –     |     |
| Turn-on Delay Time                    | T <sub>J</sub> = 125°C<br>V <sub>CE</sub> = 600 V, I <sub>C</sub> = 150 A<br>V <sub>GE</sub> = -8 V, 15 V, R <sub>Gon</sub> = 6 Ω,<br>R <sub>Goff</sub> = 11 Ω | t <sub>d(on)</sub>   | –   | 146   | –     | ns  |
| Rise Time                             |  | t <sub>r</sub>       | –   | 40    | –     |     |
| Turn-off Delay Time                   |  | t <sub>d(off)</sub>  | –   | 626   | –     |     |
| Fall Time                             |  | t <sub>f</sub>       | –   | 88    | –     | μJ  |
| Turn-on Switching Loss per Pulse      |  | E <sub>on</sub>      | –   | 4165  | –     |     |
| Turn-off Switching Loss per Pulse     |  | E <sub>off</sub>     | –   | 8420  | –     |     |
| Input Capacitance                     | V <sub>CE</sub> = 20 V, V <sub>GE</sub> = 0 V, f = 1 MHz   | C <sub>ies</sub>     | –   | 26093 | –     | pF  |
| Output Capacitance                    |  | C <sub>oes</sub>     | –   | 1012  | –     |     |
| Reverse Transfer Capacitance          |  | C <sub>res</sub>     | –   | 104   | –     |     |
| Total Gate Charge                     | V <sub>CE</sub> = 600 V, I <sub>C</sub> = 300 A,<br>V <sub>GE</sub> = -15 V~15 V   | Q <sub>g</sub>       | –   | 1304  | –     | nC  |
| Thermal Resistance – Chip-to-Heatsink | Thermal grease,<br>Thickness = 2.1 Mil ±2%<br>λ = 2.9 W/mK   | R <sub>thJH</sub>    | –   | 0.181 | –     | K/W |
| Thermal Resistance – Chip-to-Case     |  | R <sub>thJC</sub>    | –   | 0.073 | –     | K/W |

### NEUTRAL POINT DIODE (D5, D6) CHARACTERISTICS

|                                       |  |   |                   |       |       |      |
|---------------------------------------|--|---|-------------------|-------|-------|------|
| Diode Forward Voltage                 | I <sub>F</sub> = 100 A, T <sub>J</sub> = 25°C  | V <sub>F</sub>  | –                 | 1.50  | 1.85  | V    |
|                                       | I <sub>F</sub> = 100 A, T <sub>J</sub> = 150°C   |   | –                 | 2.07  | –     |      |
| Reverse Recovery Time                 | T <sub>J</sub> = 25°C<br>V <sub>CE</sub> = 600 V, I <sub>C</sub> = 150 A<br>V <sub>GE</sub> = -8 V, 15 V, R <sub>G</sub> = 6 Ω | t <sub>rr</sub>   | –                 | 19    | –     | ns   |
| Reverse Recovery Charge               |  | Q <sub>rr</sub>   | –                 | 229   | –     | nC   |
| Peak Reverse Recovery Current         |  | I <sub>RRM</sub>  | –                 | 19    | –     | A    |
| Peak Rate of Fall of Recovery Current |  | di/dt   | –                 | 6053  | –     | A/μs |
| Reverse Recovery Energy               |  | E <sub>rr</sub>   | –                 | 164   | –     | μJ   |
| Reverse Recovery Time                 |  | T <sub>J</sub> = 125°C<br>V <sub>CE</sub> = 600 V, I <sub>C</sub> = 150 A<br>V <sub>GE</sub> = -8 V, 15 V, R <sub>G</sub> = 6 Ω | t <sub>rr</sub>   | –     | 34    | –    |
| Reverse Recovery Charge               | Q <sub>rr</sub>  |   | –                 | 359   | –     | nC   |
| Peak Reverse Recovery Current         | I <sub>RRM</sub>   |   | –                 | 17    | –     | A    |
| Peak Rate of Fall of Recovery Current | di/dt  |   | –                 | 4621  | –     | A/μs |
| Reverse Recovery Energy               | E <sub>rr</sub>  |   | –                 | 211   | –     | μJ   |
| Thermal Resistance – Chip-to-Heatsink | Thermal grease,<br>Thickness = 2.1 Mil ±2%<br>λ = 2.9 W/mK   |   | R <sub>thJH</sub> | –     | 0.364 | –    |
| Thermal Resistance – Chip-to-Case     |  | R <sub>thJC</sub>   | –                 | 0.237 | –     | K/W  |

# NXH400N100H4Q2F2PG, NXH400N100H4Q2F2SG, NXH400N100H4Q2F2SG-R

## ELECTRICAL CHARACTERISTICS ( $T_J = 25^\circ\text{C}$ unless otherwise specified) (continued)

| Characteristic                             | Test Conditions  | Symbol        | Min | Typ   | Max        | Unit          |
|--|--|---------------|-----|-------|------------|---------------|
| <b>INNER IGBT (T2, T3) CHARACTERISTICS</b> |  |               |     |       |            |               |
| Collector-Emitter Cutoff Current           | $V_{GE} = 0\text{ V}, V_{CE} = 1000\text{ V}$  | $I_{CES}$     | –   | –     | 500        | $\mu\text{A}$ |
| Collector-Emitter Saturation Voltage       | $V_{GE} = 15\text{ V}, I_C = 400\text{ A}, T_J = 25^\circ\text{C}$   | $V_{CE(sat)}$ | –   | 1.77  | 2.3        | V             |
|  | $V_{GE} = 15\text{ V}, I_C = 400\text{ A}, T_J = 150^\circ\text{C}$  |               | –   | 2.11  | –          |               |
| Gate-Emitter Threshold Voltage             | $V_{GE} = V_{CE}, I_C = 400\text{ mA}$   | $V_{GE(TH)}$  | 4.1 | 5.1   | 6.1        | V             |
| Gate Leakage Current                       | $V_{GE} = \pm 20\text{ V}, V_{CE} = 0\text{ V}$  | $I_{GES}$     | –   | –     | $\pm 2000$ | nA            |
| Internal Gate Resistor                     |  | $R_G$         | –   | 1.44  | –          | $\Omega$      |
| Turn-on Delay Time                         | $T_J = 25^\circ\text{C}$<br>$V_{CE} = 600\text{ V}, I_C = 150\text{ A}$<br>$V_{GE} = -8\text{ V}, 15\text{ V}, R_{Gon} = 6\ \Omega,$<br>$R_{Goff} = 23\ \Omega$  | $t_{d(on)}$   | –   | 149   | –          | ns            |
| Rise Time                                  |  | $t_r$         | –   | 37    | –          |               |
| Turn-off Delay Time                        |  | $t_{d(off)}$  | –   | 882   | –          |               |
| Fall Time                                  |  | $t_f$         | –   | 35    | –          | $\mu\text{J}$ |
| Turn-on Switching Loss per Pulse           |  | $E_{on}$      | –   | 4970  | –          |               |
| Turn-off Switching Loss per Pulse          |  | $E_{off}$     | –   | 6010  | –          |               |
| Turn-on Delay Time                         | $T_J = 125^\circ\text{C}$<br>$V_{CE} = 600\text{ V}, I_C = 150\text{ A}$<br>$V_{GE} = -8\text{ V}, 15\text{ V}, R_{Gon} = 6\ \Omega,$<br>$R_{Goff} = 23\ \Omega$ | $t_{d(on)}$   | –   | 146   | –          | ns            |
| Rise Time                                  |  | $t_r$         | –   | 42    | –          |               |
| Turn-off Delay Time                        |  | $t_{d(off)}$  | –   | 977   | –          |               |
| Fall Time                                  |  | $t_f$         | –   | 12    | –          | $\mu\text{J}$ |
| Turn-on Switching Loss per Pulse           |  | $E_{on}$      | –   | 7790  | –          |               |
| Turn-off Switching Loss per Pulse          |  | $E_{off}$     | –   | 8530  | –          |               |
| Input Capacitance                          | $V_{CE} = 20\text{ V}, V_{GE} = 0\text{ V}, f = 1\text{ MHz}$  | $C_{ies}$     | –   | 26093 | –          | pF            |
| Output Capacitance                         |  | $C_{oes}$     | –   | 1012  | –          |               |
| Reverse Transfer Capacitance               |  | $C_{res}$     | –   | 104   | –          |               |
| Total Gate Charge                          | $V_{CE} = 600\text{ V}, I_C = 300\text{ A},$<br>$V_{GE} = 15\text{ V}$   | $Q_g$         | –   | 1304  | –          | nC            |
| Thermal Resistance – Chip-to-Heatsink      | Thermal grease,<br>Thickness = 2.1 Mil $\pm 2\%$<br>$\lambda = 2.9\text{ W/mK}$  | $R_{thJH}$    | –   | 0.207 | –          | K/W           |
| Thermal Resistance – Chip-to-Case          |  | $R_{thJC}$    | –   | 0.087 | –          | K/W           |

## IGBT INVERSE DIODE (D1, D2, D3, D4) CHARACTERISTICS

|                                       |   |  |            |       |       |                  |
|---------------------------------------|---|--|------------|-------|-------|------------------|
| Diode Forward Voltage                 | $I_F = 150\text{ A}, T_J = 25^\circ\text{C}$  | $V_F$  | –          | 2.0   | 2.6   | V                |
|                                       | $I_F = 150\text{ A}, T_J = 150^\circ\text{C}$   |  | –          | 1.77  | –     |                  |
| Reverse Recovery Time                 | $T_J = 25^\circ\text{C}$<br>$V_{CE} = 600\text{ V}, I_C = 150\text{ A}$<br>$V_{GE} = -8\text{ V}, 15\text{ V}, R_G = 6\ \Omega$ | $t_{rr}$   | –          | 105   | –     | ns               |
| Reverse Recovery Charge               |   | $Q_{rr}$   | –          | 4179  | –     | nC               |
| Peak Reverse Recovery Current         |   | $I_{RRM}$  | –          | 97    | –     | A                |
| Peak Rate of Fall of Recovery Current |   | $di/dt$  | –          | 4571  | –     | A/ $\mu\text{s}$ |
| Reverse Recovery Energy               |   | $E_{rr}$   | –          | 950   | –     | $\mu\text{J}$    |
| Reverse Recovery Time                 |   | $T_J = 125^\circ\text{C}$<br>$V_{CE} = 600\text{ V}, I_C = 150\text{ A}$<br>$V_{GE} = -8\text{ V}, 15\text{ V}, R_G = 6\ \Omega$ | $t_{rr}$   | –     | 179   | –                |
| Reverse Recovery Charge               | $Q_{rr}$  |  | –          | 11900 | –     | nC               |
| Peak Reverse Recovery Current         | $I_{RRM}$   |  | –          | 132   | –     | A                |
| Peak Rate of Fall of Recovery Current | $di/dt$   |  | –          | 4167  | –     | A/ $\mu\text{s}$ |
| Reverse Recovery Energy               | $E_{rr}$  |  | –          | 3750  | –     | $\mu\text{J}$    |
| Thermal Resistance – Chip-to-Heatsink | Thermal grease,<br>Thickness = 2.1 Mil $\pm 2\%$<br>$\lambda = 2.9\text{ W/mK}$   |  | $R_{thJH}$ | –     | 0.316 | –                |
| Thermal Resistance – Chip-to-Case     |   | $R_{thJC}$   | –          | 0.197 | –     | K/W              |

# NXH400N100H4Q2F2PG, NXH400N100H4Q2F2SG, NXH400N100H4Q2F2SG-R

## ELECTRICAL CHARACTERISTICS ( $T_J = 25^\circ\text{C}$ unless otherwise specified) (continued)

| Characteristic | Test Conditions | Symbol | Min | Typ | Max | Unit |
|----------------|-----------------|--------|-----|-----|-----|------|
|----------------|-----------------|--------|-----|-----|-----|------|

### THERMISTOR CHARACTERISTICS

|                            |                                 |              |    |      |   |                  |
|----------------------------|---------------------------------|--------------|----|------|---|------------------|
| Nominal Resistance         | $T = 25^\circ\text{C}$          | $R_{25}$     | –  | 22   | – | $\text{k}\Omega$ |
| Nominal Resistance         | $T = 100^\circ\text{C}$         | $R_{100}$    | –  | 1486 | – | $\Omega$         |
| Deviation of $R_{25}$      |                                 | $\Delta R/R$ | -5 | –    | 5 | %                |
| Power Dissipation          |                                 | $P_D$        | –  | 200  | – | mW               |
| Power Dissipation Constant |                                 |              | –  | 2    | – | mW/K             |
| B-value                    | B (25/50), tolerance $\pm 3\%$  |              | –  | 3950 | – | K                |
| B-value                    | B (25/100), tolerance $\pm 3\%$ |              | –  | 3998 | – | K                |

Product parametric performance is indicated in the Electrical Characteristics for the listed test conditions, unless otherwise noted. Product performance may not be indicated by the Electrical Characteristics if operated under different conditions.

### ORDERING INFORMATION

| Part Number  | Marking                                     | Package  | Shipping                |
|--|---|--|-------------------------|
| NXH400N100H4Q2F2PG<br>PRESS FIT PINS                       | NXH400N100H4Q2F2PG                          | PIM42, 93x47 (PRESSFIT)<br>(Pb-Free/Halide-Free)   | 12 Units / Blister Tray |
| NXH400N100H4Q2F2SG,<br>NXH400N100H4Q2F2SG-R<br>SOLDER PINS | NXH400N100H4Q2F2SG,<br>NXH400N100H4Q2F2SG-R | PIM44, 93x47 (SOLDER PIN)<br>(Pb-Free/Halide-Free) | 12 Units / Blister Tray |

TYPICAL CHARACTERISTICS – IGBT, INVERSE DIODE AND NEUTRAL POINT DIODE

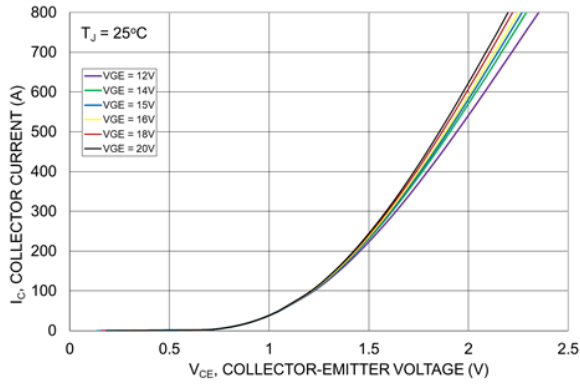

Figure 3. Typical Output Characteristics – Inner IGBT

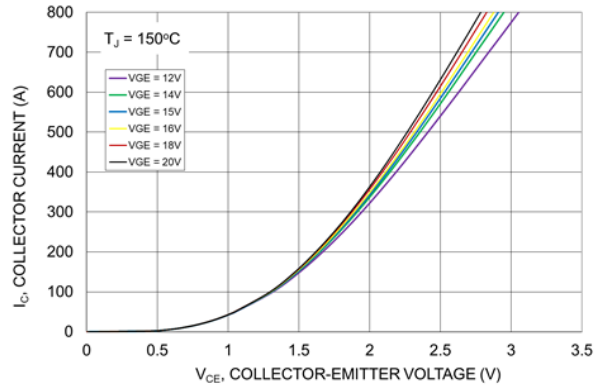

Figure 4. Typical Output Characteristics – Inner IGBT

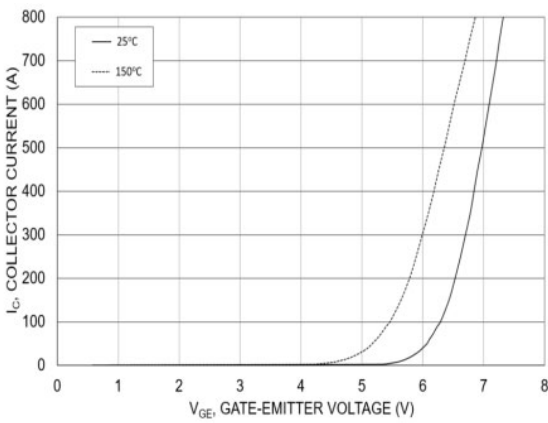

Figure 5. Transfer Characteristics – Inner IGBT

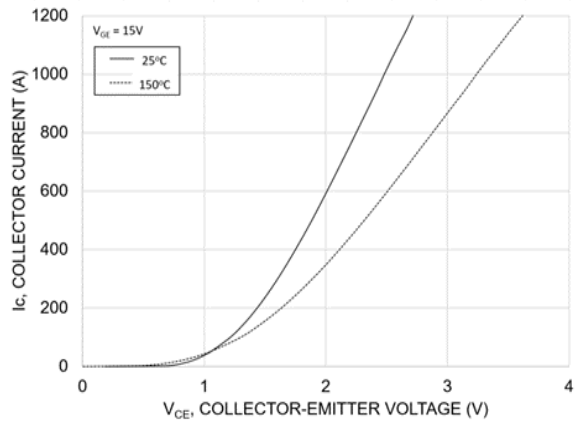

Figure 6. Saturation Voltage Characteristic

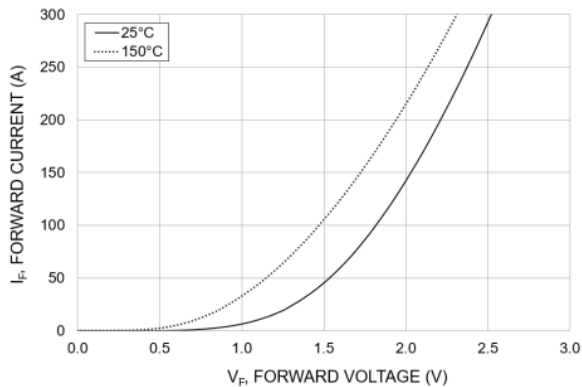

Figure 7. Inverse Diode Forward Characteristics

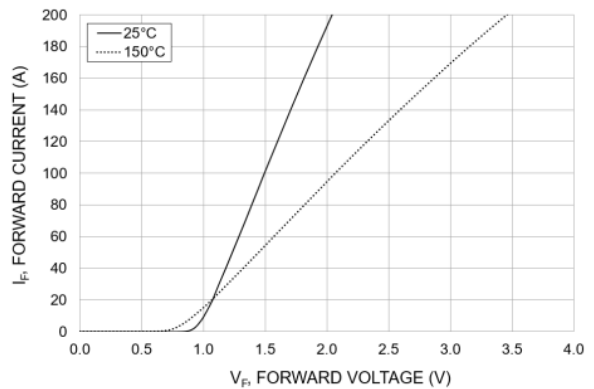

Figure 8. Buck Diode Forward Characteristics

TYPICAL CHARACTERISTICS – OUTER IGBT

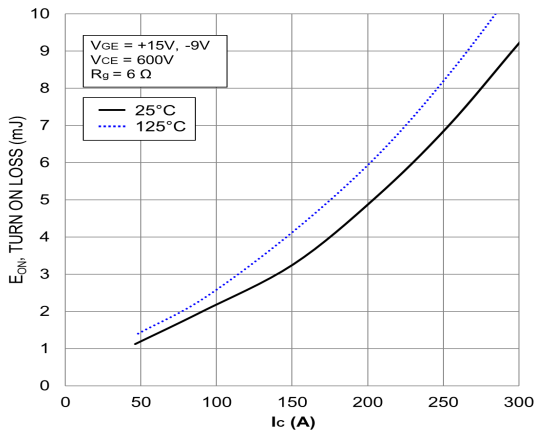

Figure 9. Typical Turn ON Loss vs. IC

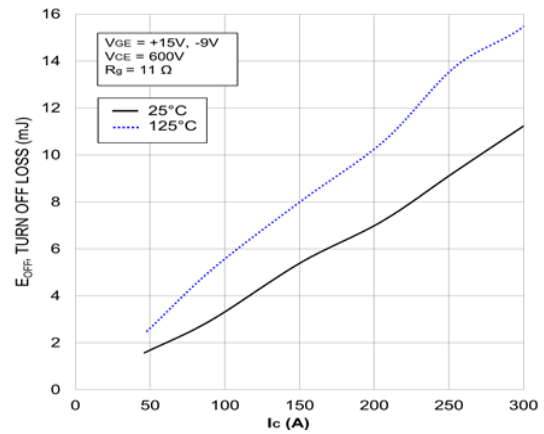

Figure 10. Typical Turn OFF Loss vs. IC

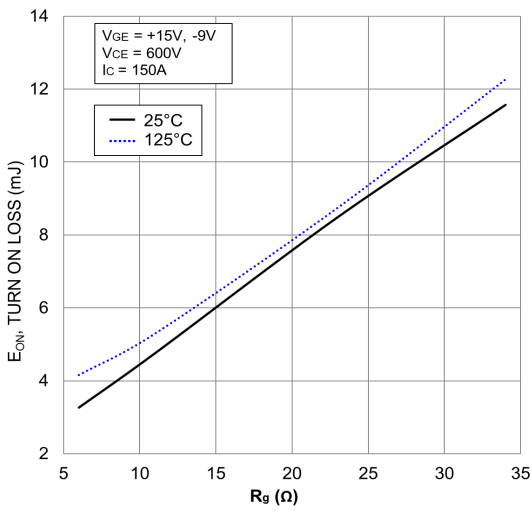

Figure 11. Typical Turn On Loss vs.  $R_g$

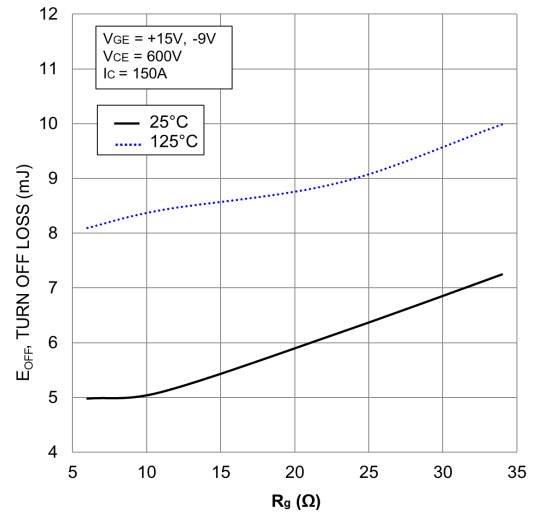

Figure 12. Typical Turn Off Loss vs.  $R_g$

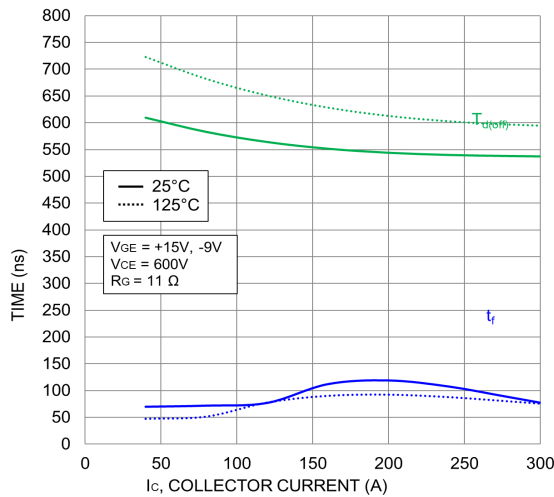

Figure 13. Typical Turn-Off Switching Time vs. IC

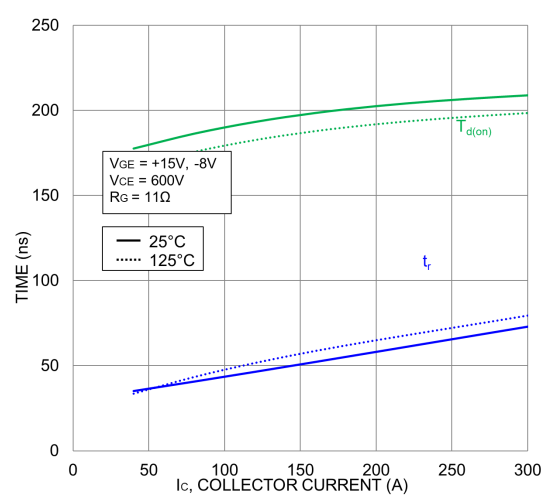

Figure 14. Typical Turn-On Switching Time vs. IC



TYPICAL CHARACTERISTICS – OUTER IGBT (continued)

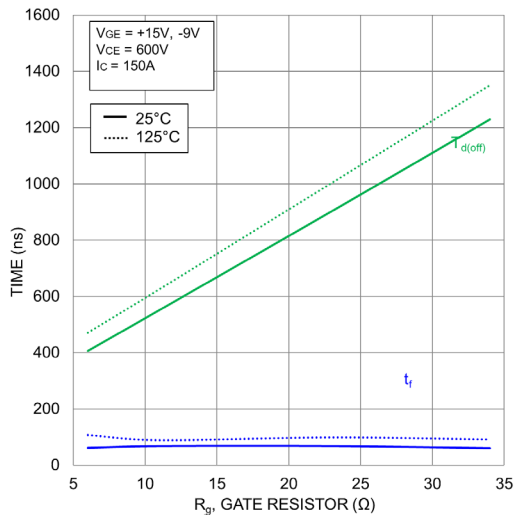

Figure 15. Typical Turn-Off Switching Time vs.  $R_g$

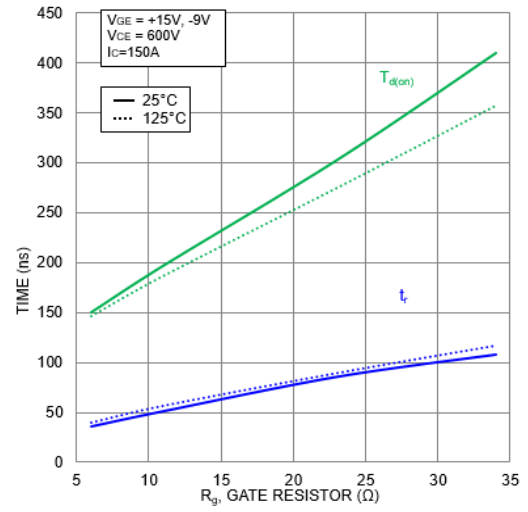

Figure 16. Typical Turn-On Switching Time vs.  $R_g$

TYPICAL CHARACTERISTICS – INNER IGBT

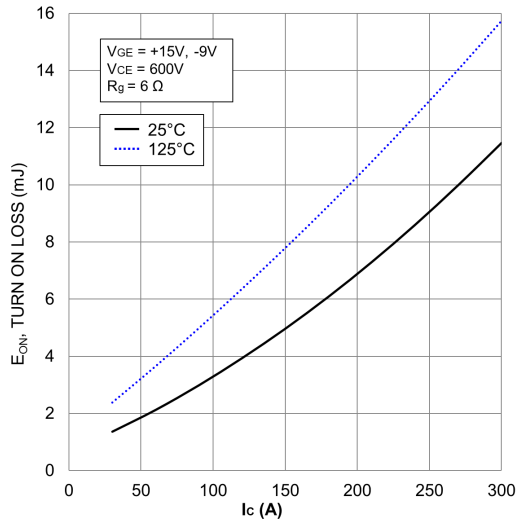

Figure 17. Typical Turn On Switching Time vs.  $I_C$

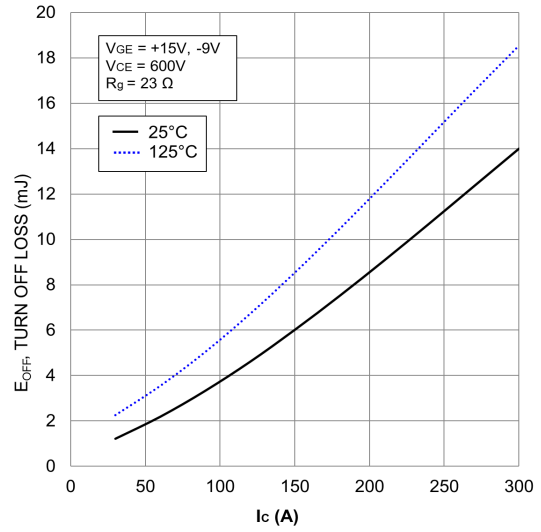

Figure 18. Typical Turn Off Switching Time vs.  $I_C$

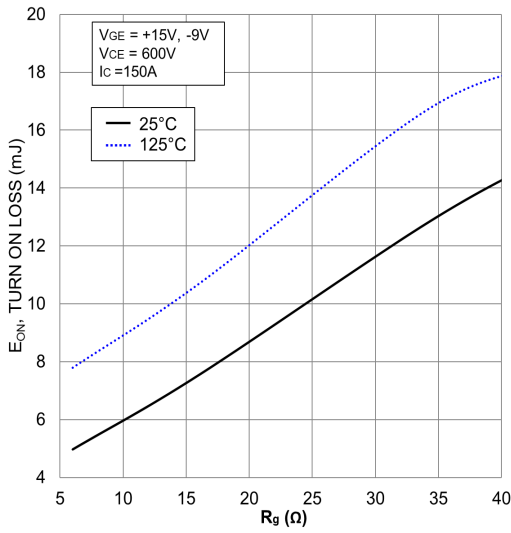

Figure 19. Typical Turn On Switching Time vs.  $R_G$

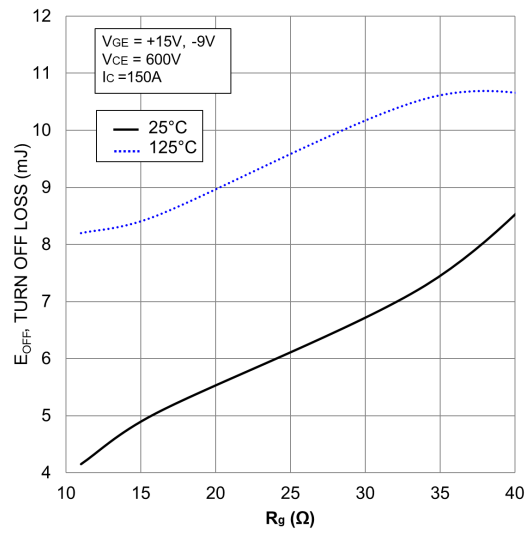

Figure 20. Typical Turn Off Switching Time vs.  $R_G$

TYPICAL CHARACTERISTICS – INNER IGBT (continued)

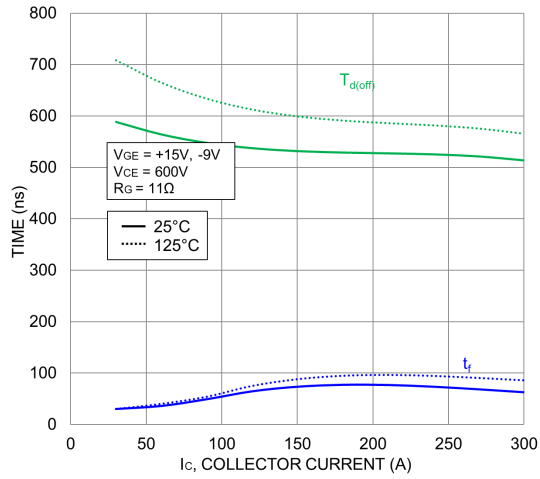

Figure 23. Typical Turn-Off Switching Time vs.  $I_c$

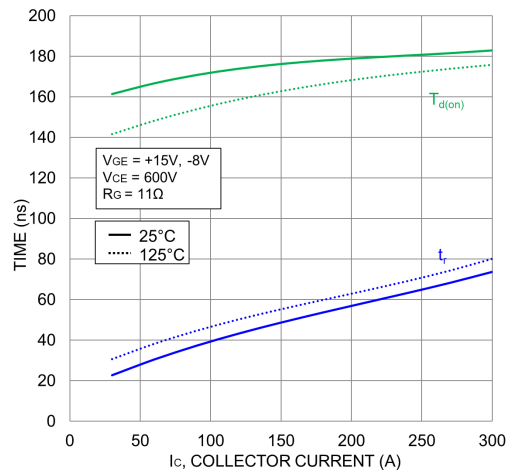

Figure 24. Typical Turn-On Switching Time vs.  $I_c$

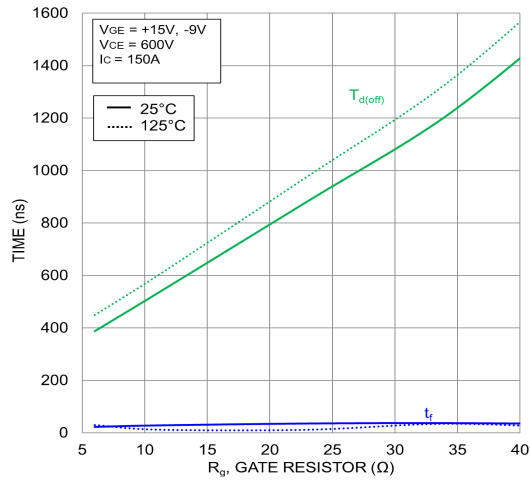

Figure 21. Typical Turn-Off Switching Time vs.  $R_g$

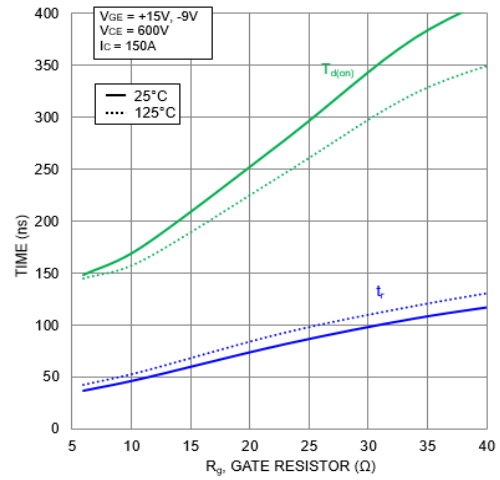

Figure 22. Typical Turn-On Switching Time vs.  $R_g$

TYPICAL SWITCHING CHARACTERISTICS – NEUTRAL POINT DIODE

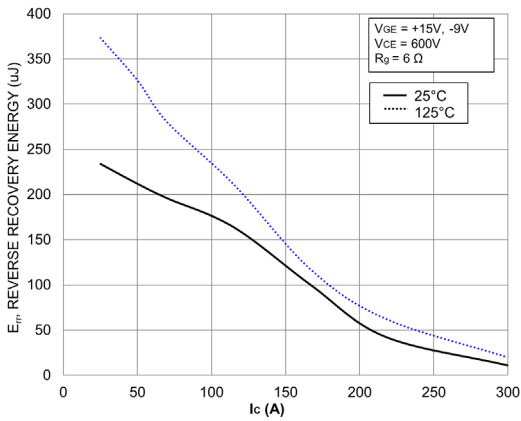

Figure 25. Typical Reverse Recovery Energy Loss vs.  $I_c$

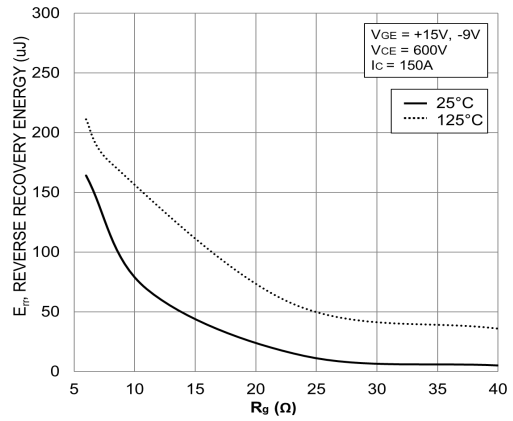

Figure 26. Typical Reverse Recovery Energy Loss vs.  $R_g$

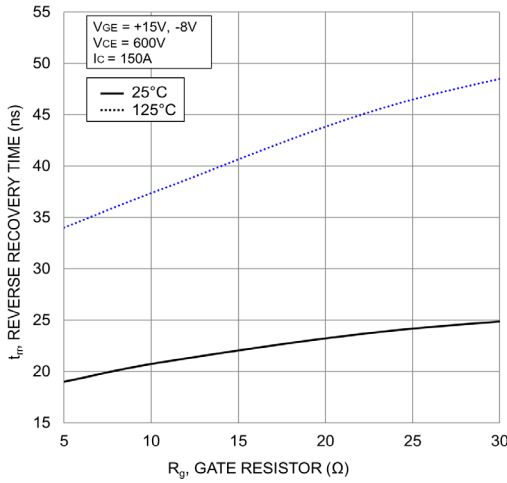

Figure 27. Typical Reverse Recovery Time vs.  $R_g$

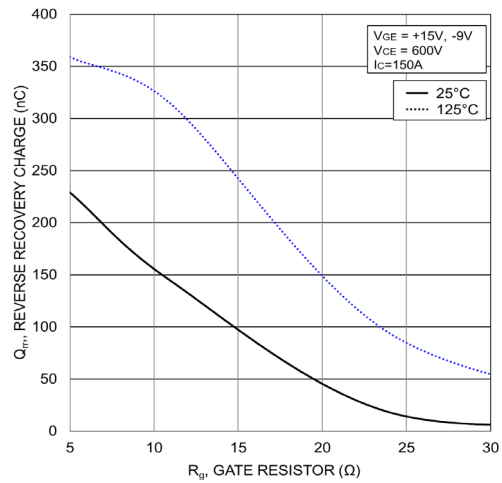

Figure 28. Typical Reverse Recovery Charge vs.  $R_g$

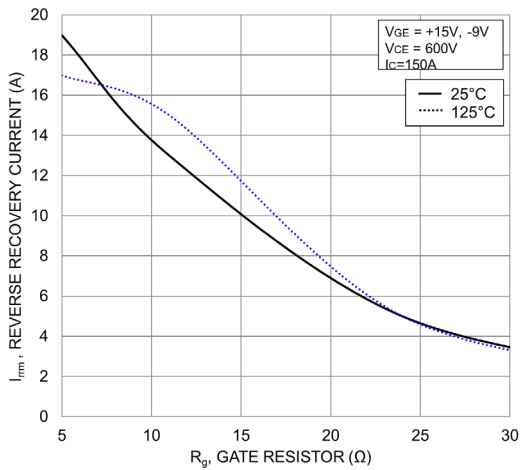

Figure 29. Typical Reverse Recovery Peak Current vs.  $R_g$

TYPICAL CHARACTERISTICS – INVERSE DIODE

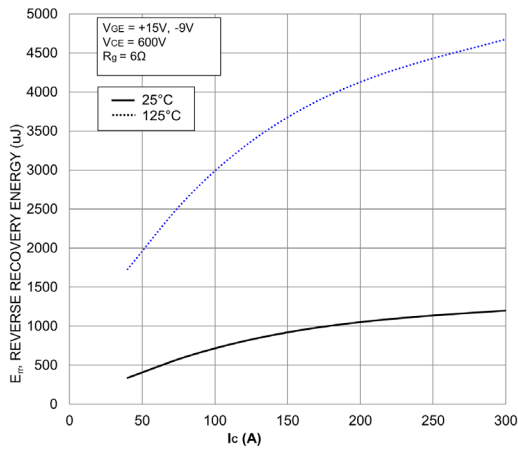

Figure 30. Typical Reverse Recovery Energy Loss vs.  $I_C$

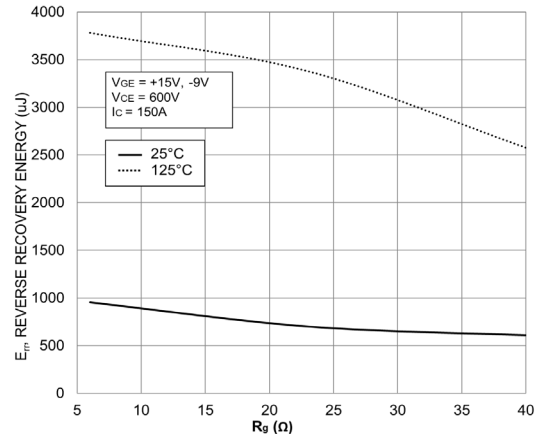

Figure 31. Typical Reverse Recovery Energy Loss vs.  $R_g$

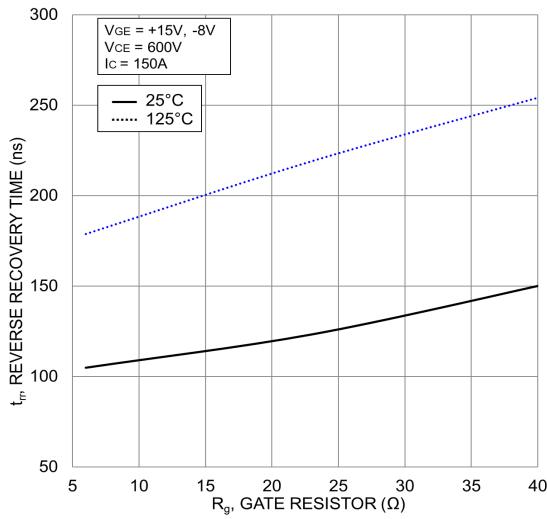

Figure 32. Typical Reverse Recovery Time vs.  $R_g$

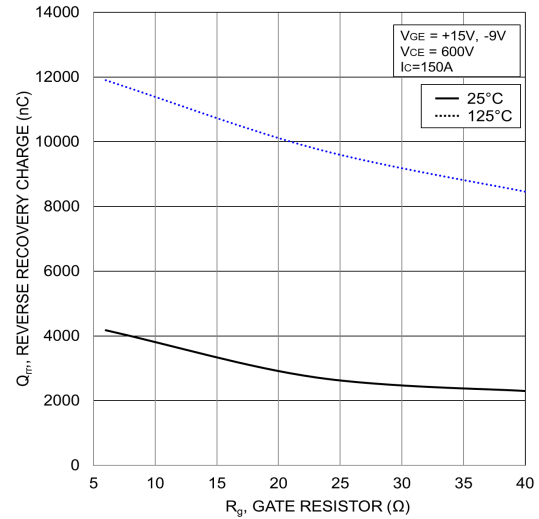

Figure 33. Typical Reverse Recovery Charge vs.  $R_g$

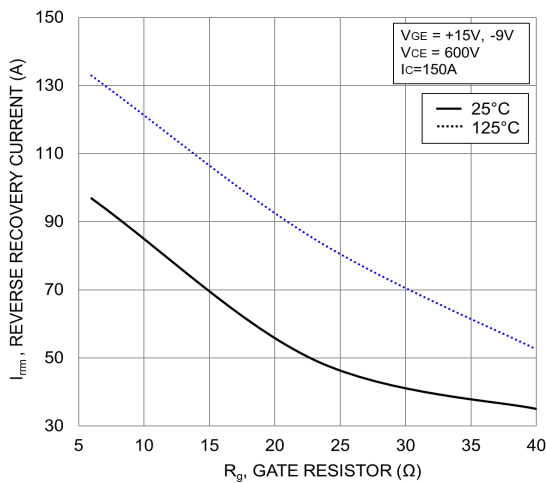

Figure 34. Typical Reverse Recovery Peak Current vs.  $R_g$

TYPICAL CHARACTERISTICS – IGBT, INVERSE DIODE AND NEUTRAL POINT DIODE

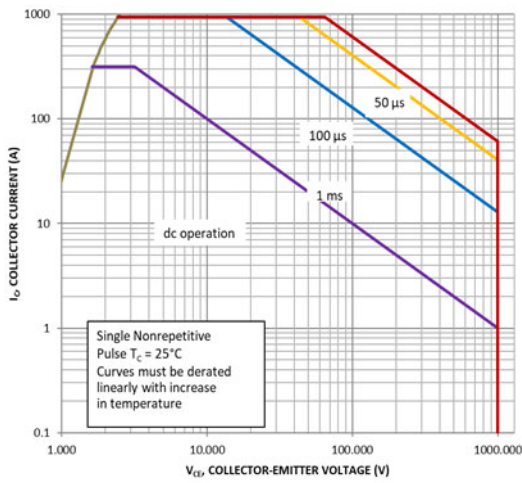

Figure 35. FBSOA – Outer IGBT

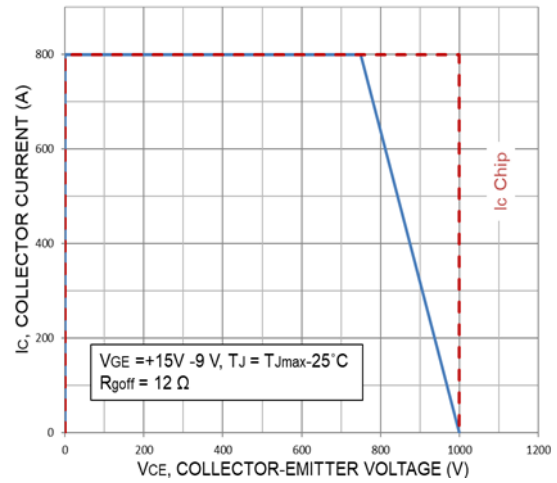

Figure 36. RBSOA – Outer IGBT

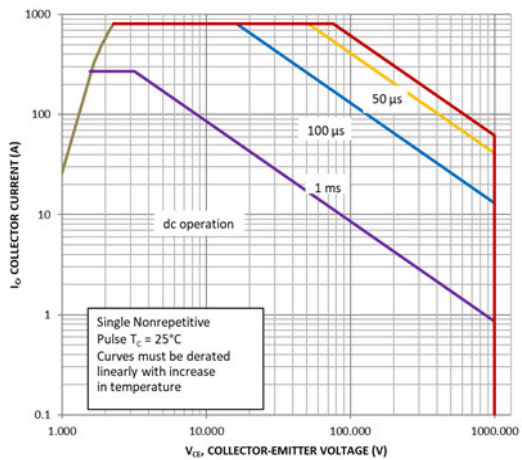

Figure 37. FBSOA – Inner IGBT

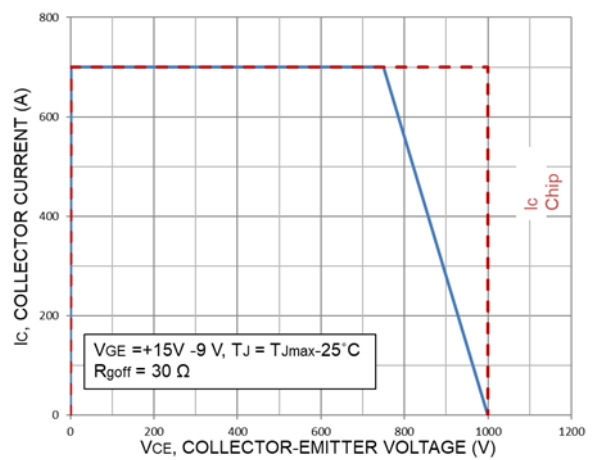

Figure 38. RBSOA – Inner IGBT

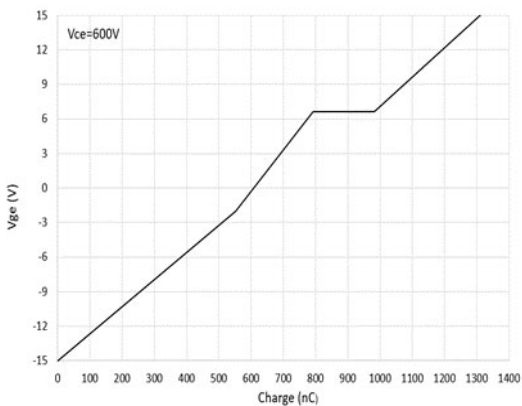

Figure 39. Gate Voltage vs. Gate Charge

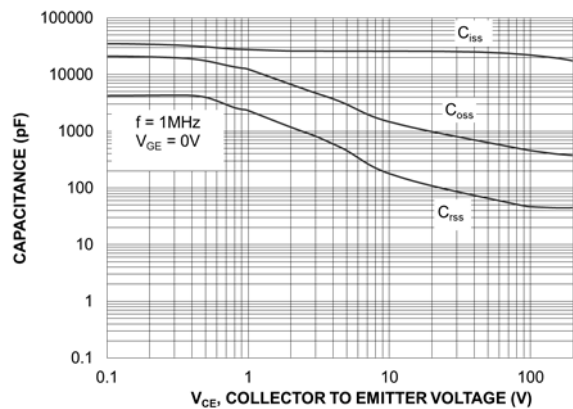

Figure 40. Capacitance Charge

TYPICAL CHARACTERISTICS – IGBT, INVERSE DIODE AND NEUTRAL POINT DIODE (continued)

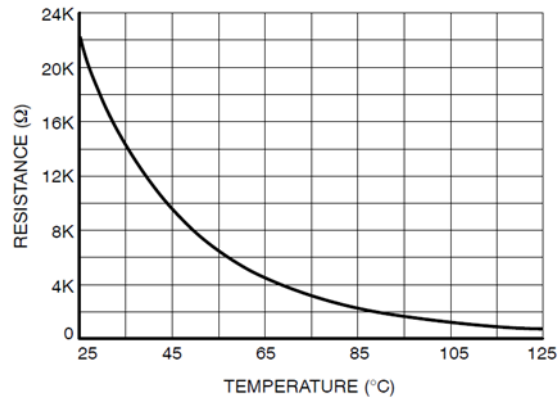

Figure 41. Thermistor Characteristics

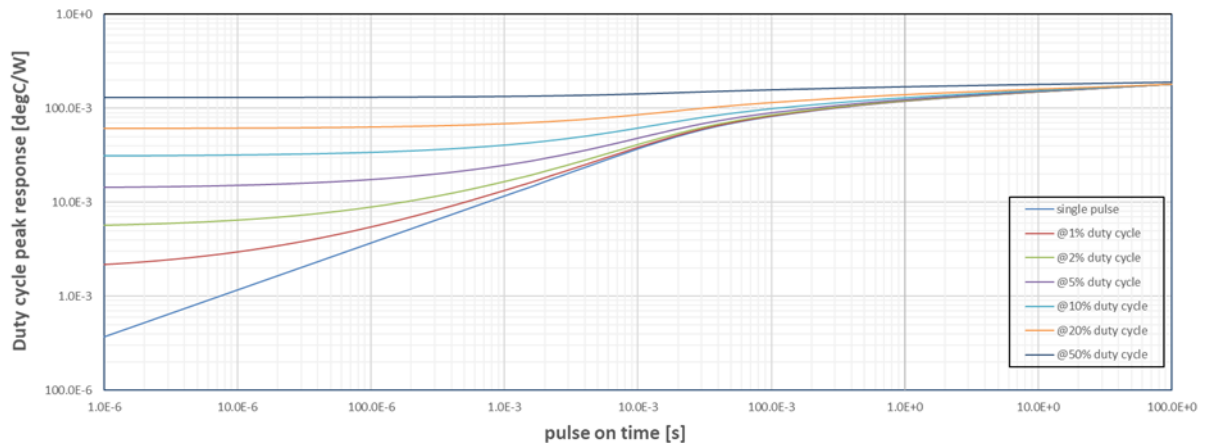

Figure 42. Transient Thermal Impedance – Outer IGBT

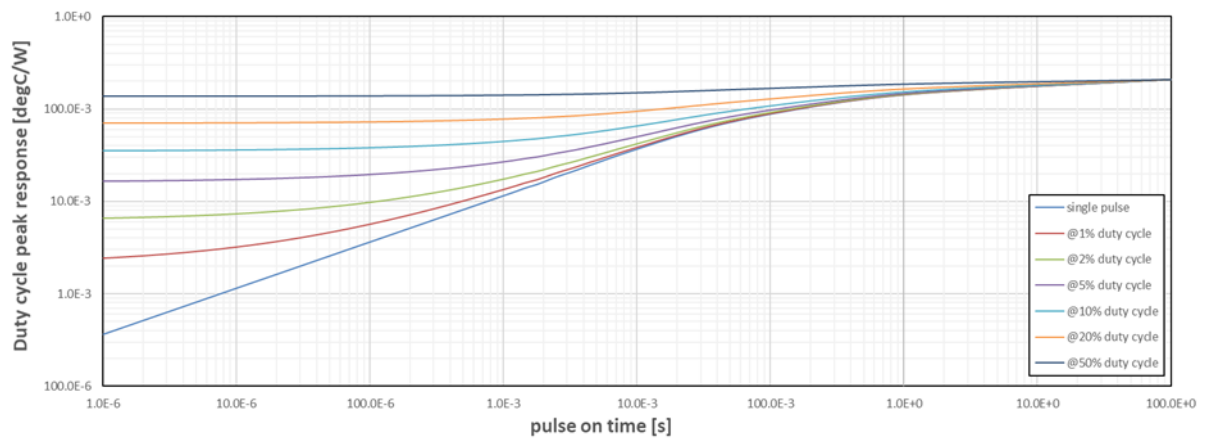

Figure 43. Transient Thermal Impedance – Inner IGBT

TYPICAL CHARACTERISTICS – IGBT, INVERSE DIODE AND NEUTRAL POINT DIODE (continued)

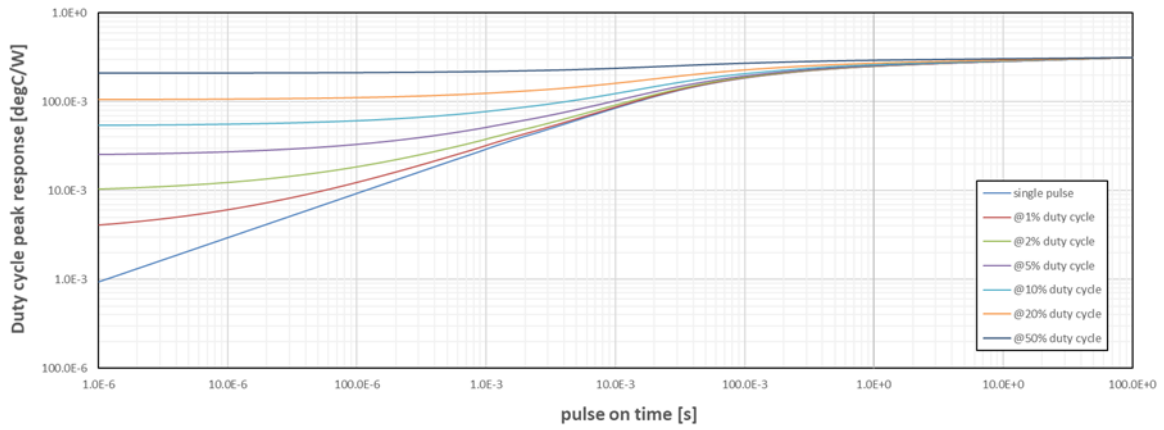

Figure 44. Transient Thermal Impedance – Inverse Diode

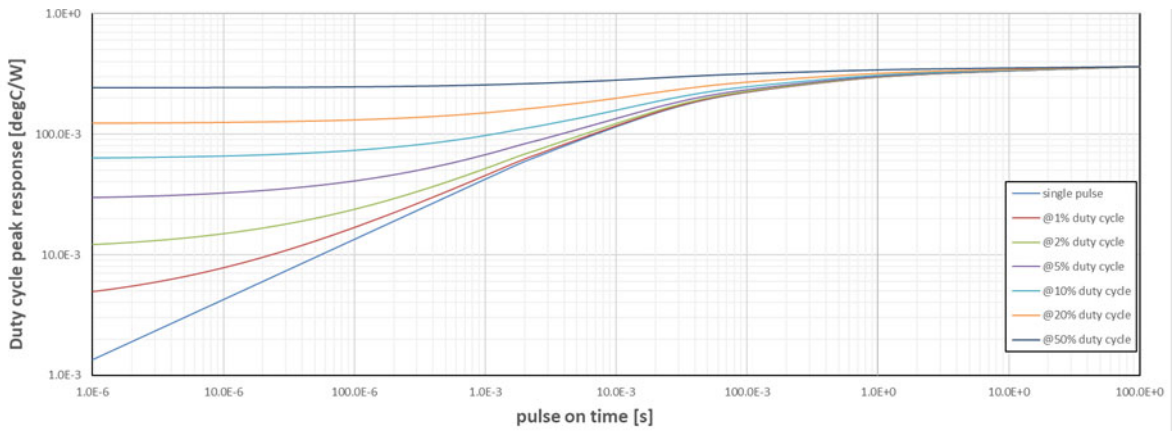

Figure 45. Transient Thermal Impedance – Neutral Point Diode



# MECHANICAL CASE OUTLINE PACKAGE DIMENSIONS

ON Semiconductor®



## PIM42, 93x47 (PRESSFIT) CASE 180BH ISSUE O

DATE 06 AUG 2019

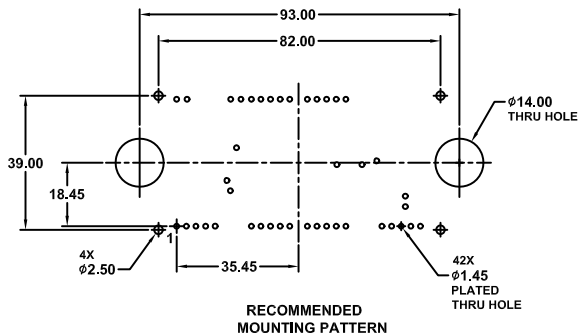
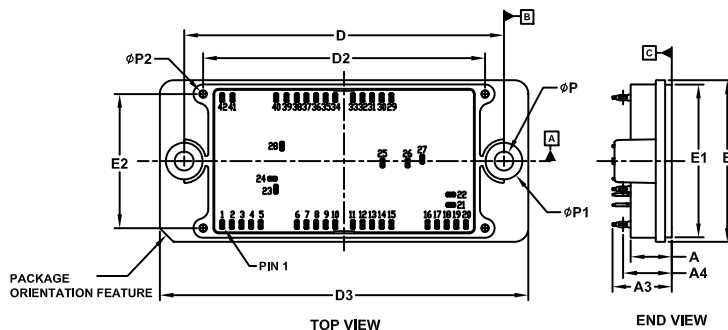
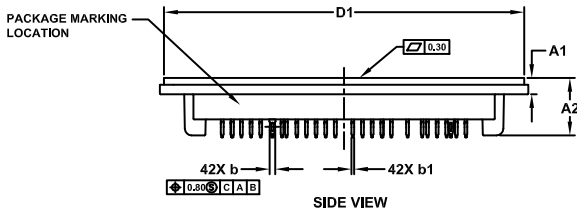
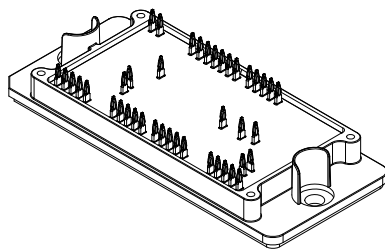

NOTES:

1. DIMENSIONING AND TOLERANCING PER ASME Y14.5M, 2009.
2. CONTROLLING DIMENSION: MILLIMETERS
3. DIMENSIONS b AND b1 APPLY TO THE PLATED TERMINALS AND ARE MEASURED AT DIMENSION A4.
4. POSITION OF THE CENTER OF THE TERMINALS IS DETERMINED FROM DATUM B THE CENTER OF DIMENSION D, X DIRECTION, AND FROM DATUM A, Y DIRECTION. POSITIONAL TOLERANCE, AS NOTED IN DRAWING, APPLIES TO EACH TERMINAL IN BOTH DIRECTIONS.
5. PACKAGE MARKING IS LOCATED AS SHOWN ON THE SIDE OPPOSITE THE PACKAGE ORIENTATION FEATURES.

| DIM | MILLIMETERS |        |        | PIN POSITION |       | PIN POSITION |    |       |       |
|-----|-------------|--------|--------|--------------|-------|--------------|----|-------|-------|
|     | MIN.        | NOM.   | MAX.   | X            | Y     | PIN          | X  | Y     |       |
| A   | 11.70       | 12.00  | 12.30  | 1            | 0.00  | 0.00         | 22 | 66.50 | 8.70  |
| A1  | 4.40        | 4.70   | 5.00   | 2            | 2.80  | 0.00         | 23 | 15.60 | 10.30 |
| A2  | 16.40       | 16.70  | 17.00  | 3            | 5.60  | 0.00         | 24 | 14.60 | 13.30 |
| A3  | 16.90       | 17.30  | 17.70  | 4            | 8.40  | 0.00         | 25 | 46.60 | 17.90 |
| A4  | 13.97       | 14.18  | 14.39  | 5            | 11.20 | 0.00         | 26 | 53.90 | 17.90 |
| b   | 1.61        | 1.66   | 1.71   | 6            | 21.70 | 0.00         | 27 | 58.20 | 19.00 |
| b1  | 0.75        | 0.80   | 0.85   | 7            | 24.50 | 0.00         | 28 | 17.40 | 22.80 |
| D   | 92.90       | 93.00  | 93.10  | 8            | 27.30 | 0.00         | 29 | 49.20 | 36.90 |
| D1  | 104.45      | 104.75 | 105.05 | 9            | 30.10 | 0.00         | 30 | 46.40 | 36.90 |
| D2  | 81.80       | 82.00  | 82.20  | 10           | 32.90 | 0.00         | 31 | 43.60 | 36.90 |
| D3  | 106.90      | 107.20 | 107.50 | 11           | 38.00 | 0.00         | 32 | 40.80 | 36.90 |
| E   | 46.70       | 47.00  | 47.30  | 12           | 40.80 | 0.00         | 33 | 38.00 | 36.90 |
| E1  | 44.10       | 44.40  | 44.70  | 13           | 43.60 | 0.00         | 34 | 32.90 | 36.90 |
| E2  | 38.80       | 39.00  | 39.10  | 14           | 46.40 | 0.00         | 35 | 30.10 | 36.90 |
| P   | 5.40        | 5.50   | 5.60   | 15           | 49.20 | 0.00         | 36 | 27.30 | 36.90 |
| P1  | 10.60       | 10.70  | 10.80  | 16           | 59.70 | 0.00         | 37 | 24.50 | 36.90 |
| P2  | 1.80        | 2.00   | 2.20   | 17           | 62.50 | 0.00         | 38 | 21.70 | 36.90 |
|     |             |        |        | 18           | 65.30 | 0.00         | 39 | 18.70 | 36.90 |
|     |             |        |        | 19           | 68.10 | 0.00         | 40 | 15.70 | 36.90 |
|     |             |        |        | 20           | 70.90 | 0.00         | 41 | 3.00  | 36.90 |
|     |             |        |        | 21           | 66.50 | 5.70         | 42 | 0.00  | 36.90 |

### GENERIC MARKING DIAGRAM\*

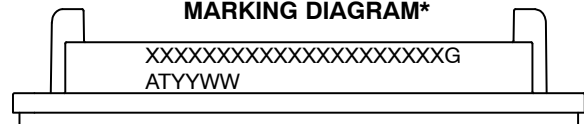

XXXXX = Specific Device Code  
G = Pb-Free Package  
AT = Assembly & Test Site Code  
YYWW = Year and Work Week Code

\*This information is generic. Please refer to device data sheet for actual part marking. Pb-Free indicator, "G" or microdot "μ", may or may not be present. Some products may not follow the Generic Marking.

|                  |                         |  |
|------------------|-------------------------|--|
| DOCUMENT NUMBER: | 98AON09951H             | Electronic versions are uncontrolled except when accessed directly from the Document Repository. Printed versions are uncontrolled except when stamped "CONTROLLED COPY" in red. |
| DESCRIPTION:     | PIM42 93X47 (PRESS FIT) | PAGE 1 OF 1  |

ON Semiconductor and are trademarks of Semiconductor Components Industries, LLC dba ON Semiconductor or its subsidiaries in the United States and/or other countries. ON Semiconductor reserves the right to make changes without further notice to any products herein. ON Semiconductor makes no warranty, representation or guarantee regarding the suitability of its products for any particular purpose, nor does ON Semiconductor assume any liability arising out of the application or use of any product or circuit, and specifically disclaims any and all liability, including without limitation special, consequential or incidental damages. ON Semiconductor does not convey any license under its patent rights nor the rights of others.

# MECHANICAL CASE OUTLINE

## PACKAGE DIMENSIONS

ON Semiconductor®

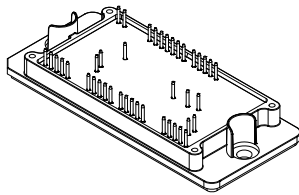

**PIM42, 93x47 (SOLDER PIN)**  
CASE 180BS  
ISSUE O

DATE 03 DEC 2019

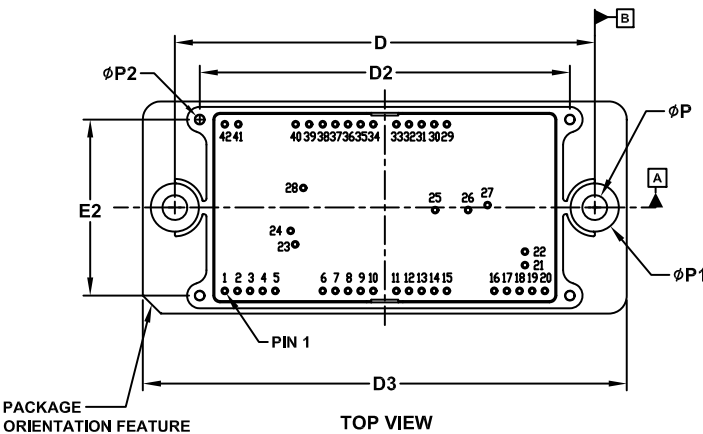
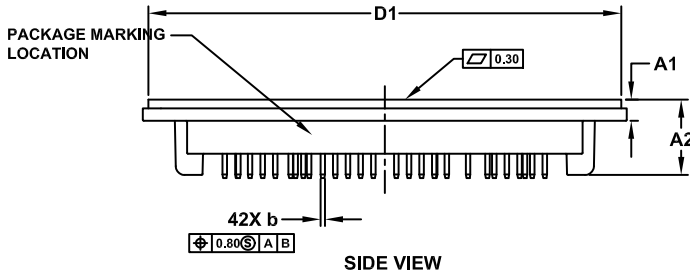

**NOTES:**

1. DIMENSIONING AND TOLERANCING PER ASME Y14.5M, 2009.
2. CONTROLLING DIMENSION: MILLIMETERS
3. DIMENSIONS b AND b1 APPLY TO THE PLATED TERMINALS AND ARE MEASURED AT DIMENSION A4.
4. POSITION OF THE CENTER OF THE TERMINALS IS DETERMINED FROM DATUM B THE CENTER OF DIMENSION D, X DIRECTION, AND FROM DATUM A, Y DIRECTION. POSITIONAL TOLERANCE, AS NOTED IN DRAWING, APPLIES TO EACH TERMINAL IN BOTH DIRECTIONS.
5. PACKAGE MARKING IS LOCATED AS SHOWN ON THE SIDE OPPOSITE THE PACKAGE ORIENTATION FEATURES.

| DIM | MILLIMETERS |        |        |
|-----|-------------|--------|--------|
|     | MIN.        | NOM.   | MAX.   |
| A   | 11.70       | 12.00  | 12.30  |
| A1  | 4.40        | 4.70   | 5.00   |
| A2  | 16.40       | 16.70  | 17.00  |
| A3  | 16.80       | 17.20  | 17.60  |
| b   | 0.95        | 1.00   | 1.05   |
| D   | 92.90       | 93.00  | 93.10  |
| D1  | 104.45      | 104.75 | 105.05 |
| D2  | 81.80       | 82.00  | 82.20  |
| D3  | 106.90      | 107.20 | 107.50 |
| E   | 46.70       | 47.00  | 47.30  |
| E1  | 44.10       | 44.40  | 44.70  |
| E2  | 38.80       | 39.00  | 39.10  |
| P   | 5.40        | 5.50   | 5.60   |
| P1  | 10.60       | 10.70  | 10.80  |
| P2  | 1.80        | 2.00   | 2.20   |

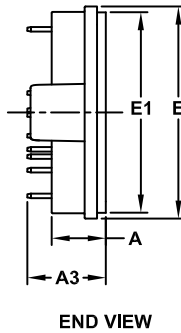

**NOTE 4**

| PIN | PIN POSITION |      | PIN | PIN POSITION |       |
|-----|--------------|------|-----|--------------|-------|
|     | X            | Y    |     | X            | Y     |
| 1   | 0.00         | 0.00 | 22  | 66.50        | 8.70  |
| 2   | 2.80         | 0.00 | 23  | 15.60        | 10.30 |
| 3   | 5.60         | 0.00 | 24  | 14.60        | 13.30 |
| 4   | 8.40         | 0.00 | 25  | 46.60        | 17.90 |
| 5   | 11.20        | 0.00 | 26  | 53.90        | 17.90 |
| 6   | 21.70        | 0.00 | 27  | 58.20        | 19.00 |
| 7   | 24.50        | 0.00 | 28  | 17.40        | 22.80 |
| 8   | 27.30        | 0.00 | 29  | 49.20        | 36.90 |
| 9   | 30.10        | 0.00 | 30  | 46.40        | 36.90 |
| 10  | 32.90        | 0.00 | 31  | 43.60        | 36.90 |
| 11  | 38.00        | 0.00 | 32  | 40.80        | 36.90 |
| 12  | 40.80        | 0.00 | 33  | 38.00        | 36.90 |
| 13  | 43.60        | 0.00 | 34  | 32.90        | 36.90 |
| 14  | 46.40        | 0.00 | 35  | 30.10        | 36.90 |
| 15  | 49.20        | 0.00 | 36  | 27.30        | 36.90 |
| 16  | 59.70        | 0.00 | 37  | 24.50        | 36.90 |
| 17  | 62.50        | 0.00 | 38  | 21.70        | 36.90 |
| 18  | 65.30        | 0.00 | 39  | 18.70        | 36.90 |
| 19  | 68.10        | 0.00 | 40  | 15.70        | 36.90 |
| 20  | 70.90        | 0.00 | 41  | 3.00         | 36.90 |
| 21  | 66.50        | 5.70 | 42  | 0.00         | 36.90 |

**GENERIC MARKING DIAGRAM\***

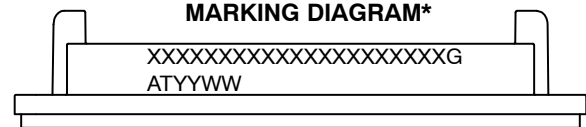

XXXXX = Specific Device Code  
G = Pb-Free Package  
AT = Assembly & Test Site Code  
YYWW = Year and Work Week Code

\*This information is generic. Please refer to device data sheet for actual part marking. Pb-Free indicator, "G" or microdot "•", may or may not be present. Some products may not follow the Generic Marking.

|                         |                                 |  |
|-------------------------|---------------------------------|--|
| <b>DOCUMENT NUMBER:</b> | <b>98AON15232H</b>              | Electronic versions are uncontrolled except when accessed directly from the Document Repository. Printed versions are uncontrolled except when stamped "CONTROLLED COPY" in red. |
| <b>DESCRIPTION:</b>     | <b>PIM42 93X47 (SOLDER PIN)</b> | <b>PAGE 1 OF 1</b>   |

ON Semiconductor and ON are trademarks of Semiconductor Components Industries, LLC dba ON Semiconductor or its subsidiaries in the United States and/or other countries. ON Semiconductor reserves the right to make changes without further notice to any products herein. ON Semiconductor makes no warranty, representation or guarantee regarding the suitability of its products for any particular purpose, nor does ON Semiconductor assume any liability arising out of the application or use of any product or circuit, and specifically disclaims any and all liability, including without limitation special, consequential or incidental damages. ON Semiconductor does not convey any license under its patent rights nor the rights of others.

**onsemi**, **Onsemi**, and other names, marks, and brands are registered and/or common law trademarks of Semiconductor Components Industries, LLC dba "**onsemi**" or its affiliates and/or subsidiaries in the United States and/or other countries. **onsemi** owns the rights to a number of patents, trademarks, copyrights, trade secrets, and other intellectual property. A listing of **onsemi**'s product/patent coverage may be accessed at [www.onsemi.com/site/pdf/Patent-Marking.pdf](http://www.onsemi.com/site/pdf/Patent-Marking.pdf). **onsemi** reserves the right to make changes at any time to any products or information herein, without notice. The information herein is provided "as-is" and **onsemi** makes no warranty, representation or guarantee regarding the accuracy of the information, product features, availability, functionality, or suitability of its products for any particular purpose, nor does **onsemi** assume any liability arising out of the application or use of any product or circuit, and specifically disclaims any and all liability, including without limitation special, consequential or incidental damages. Buyer is responsible for its products and applications using **onsemi** products, including compliance with all laws, regulations and safety requirements or standards, regardless of any support or applications information provided by **onsemi**. "Typical" parameters which may be provided in **onsemi** data sheets and/or specifications can and do vary in different applications and actual performance may vary over time. All operating parameters, including "Typicals" must be validated for each customer application by customer's technical experts. **onsemi** does not convey any license under any of its intellectual property rights nor the rights of others. **onsemi** products are not designed, intended, or authorized for use as a critical component in life support systems or any FDA Class 3 medical devices or medical devices with a same or similar classification in a foreign jurisdiction or any devices intended for implantation in the human body. Should Buyer purchase or use **onsemi** products for any such unintended or unauthorized application, Buyer shall indemnify and hold **onsemi** and its officers, employees, subsidiaries, affiliates, and distributors harmless against all claims, costs, damages, and expenses, and reasonable attorney fees arising out of, directly or indirectly, any claim of personal injury or death associated with such unintended or unauthorized use, even if such claim alleges that **onsemi** was negligent regarding the design or manufacture of the part. **onsemi** is an Equal Opportunity/Affirmative Action Employer. This literature is subject to all applicable copyright laws and is not for resale in any manner.

## PUBLICATION ORDERING INFORMATION

### LITERATURE FULFILLMENT:

Email Requests to: [orderlit@onsemi.com](mailto:orderlit@onsemi.com)

**onsemi Website:** [www.onsemi.com](http://www.onsemi.com)

### TECHNICAL SUPPORT

**North American Technical Support:**

Voice Mail: 1 800-282-9855 Toll Free USA/Canada

Phone: 011 421 33 790 2910

**Europe, Middle East and Africa Technical Support:**

Phone: 00421 33 790 2910

For additional information, please contact your local Sales Representative