

CARLISLE[®]

INTERCONNECT TECHNOLOGIES



Octax[®] Ultra High-Speed
Interconnect Solutions

Introduction

Octax® Ultra High-Speed Ethernet Interconnect Solutions are capable of operating in data transmission speeds of 10 Gigabits/sec (Gb/S) or higher. Octax is an innovative, lightweight and cost-effective alternative to satisfy the ever-increasing high-speed data needs of the commercial and military aerospace market.

The patented Octax Ultra High-Speed Ethernet Interconnect Solutions encompass a newly designed custom cable configuration along with a connector that is compliant with TIA/EIA and ISO CAT6A, and CAT7 standards. The Octax connector utilizes innovative inserts to isolate each twisted pair and contact. Shielding and twisting is able to be maintained extremely close to the contacts to minimize characteristic impedance mismatch and each insert serves as an isolated cell to virtually eliminate near-end crosstalk. The scalable Octax connectivity solution is future-proofed to meet the upcoming data and bandwidth demands.

The Octax high-speed family of connectors offers single and multiple port circular, rectangular and custom connector interfaces enabling design engineers to achieve the highest performance in any connector package. Exceeding ANSI/TIA/EIA-568-B.2 Category 6 and Category 7 specifications, CarlisleIT's high-speed cable and connector solutions are the highest performance, harsh environment interconnect systems available for Ethernet and other high speed protocols.

PROPERTIES

- » Compliant with TIA/EIA and ISO CAT6A or CAT7 testing standards
- » Capable of operating in the data transfer speed of 10 Gigabits/sec or higher
- » Lightweight and compact allowing for greater density
- » Field serviceable
- » Excellent EMI shielding
- » Environmentally sealed
- » Corrosion resistant
- » Capable of operating in high temperature environments
- » RoHS compliant
- » Custom dielectric inserts maintain 100 ohm impedance through the connector
- » Uses standard M39029 crimp contacts
- » Optimized for use with CarlisleIT's Gigabit series cables
- » Compatible with both 24 and 26 AWG conductor cables
- » Patented

QUALIFICATION TEST DATA

The Octax high-speed family of connectors is tested to real-life mechanical and environmental performance requirements, as well as emerging industry standards. The connectors offer system designers and engineers assurance of the highest performance in the most demanding applications.

Test Scope	Per Specification	Notes
Vibration - Random, Sine and Gunfire	EIA-364-28, MIL-STD-202, MIL-STD-810	
Shock	EIA-364-27	300G
Acceleration	MIL-STD-1344, MIL-STD-202	50 G
Temperature Life	CarlisleIT Specification	1000 hours at 175°C, 2A in series
IR - Ambient, Elevated Temperature and Humidity	EIA-364-21 for IR, EIA-364-31 for Humidity	500VDC, 5000 MΩ, 175°C, 90-98% RH
DWV - Sea Level and at Altitude	EIA-364-20	70,000 ft., 500 VRMS
Low Temperature at Altitude	EIA-364-105, EIA-364-20	70,000 ft., -65°C, 625 VRMS
Altitude Immersion	EIA-364-03	70,000 ft.
Immersion	MIL-STD-810	1 meter
Durability	MIL-DTL-38999	500 mate/unmate cycles
Fungus	MIL-STD-810	
Contamination by Fluids	MIL-STD-810	
Sand and Dust	MIL-STD-810	
Thermal Shock	EIA-364-32	-65°C to 175°C
Corrosion Resistance	EIA-364-26, Condition A	
Operating Temperature	EIA-568 CAT5E, CAT6A	-65°C to 175°C

OCTAX®-SOLO 10Gb/S Ethernet Interconnect System

CarlisleIT (Carlisle Interconnect Technologies) Octax®-Solo 10Gb/s Ethernet connector is a single port standalone connector. The Octax connector utilizes innovative inserts to isolate each twisted pair and contact. Shielding and twisting is able to be maintained extremely close to the contacts to minimize characteristic impedance mismatch and each insert serves as an isolated cell to virtually eliminate near-end crosstalk. Our connectors are capable of operating in data transmission speeds of 10 Gigabits/sec (Gb/S) or higher. By comparison to a Quadrax system, this equals 10 x the transmission speed (10Gb/s signal), and 2 x the density. The Octax standard M39029 crimp contacts reduce manufacturing installation time and provide a field repairable solution with ease.

Part Number	Description
OCTAX-SOLO-FM-PCB*	Straight PCB, flange mount
OCTAX-SOLO-FMR*	Flange mount receptacle connector
OCTAX-SOLO-P	Plug connector

*In-line and jam nut designs also available

MECHANICAL

- » Mating Cycles: >500
- » Coupling Torque: 6.0 in-lb Max, 1.0 in-lb Min.
- » Contact Retaining Force: >6 lbs (>26.7 newton)

PHYSICAL

- » Operating Temperature Range: -65°C to 175°C
- » Please see Diagrams to match dimensions:

OCTAX-SOLO-FM-PCB

- » A: 0.70"
- » B: 0.70"
- » C: 0.49"
- » 3 grams (ref)

OCTAX-SOLO-FMR

- » A: 0.70"
- » B: 0.70"
- » C: 0.947"
- » 4.5 grams (ref)

OCTAX-SOLO-P

- » A: N/A
- » B: 0.51" dia.
- » C: 0.879"
- » 5 grams (ref)

ELECTRICAL

- » Dielectric Withstand Voltage: 500 VRMS
- » Current and Voltage Rating: 4 amps and 115 VAC
- » Shell-to-Shell Contact Resistance: <3.0 milliohms
- » Insulation Resistance of Inserts: >5.0x10⁹ ohms

Flange Mount PC Tail Receptacle Connector

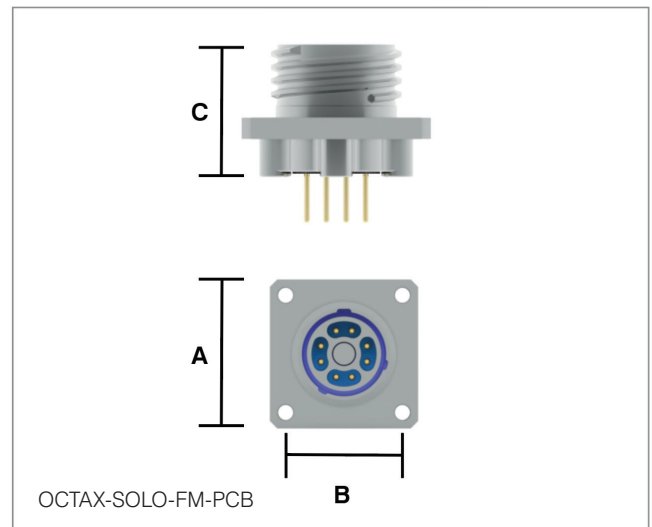

Flange Mount Receptacle Connector

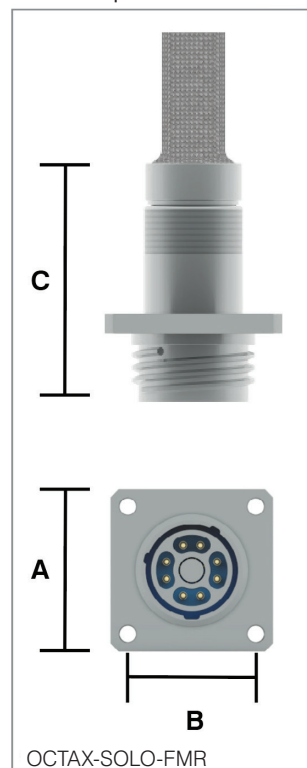

Plug Connector

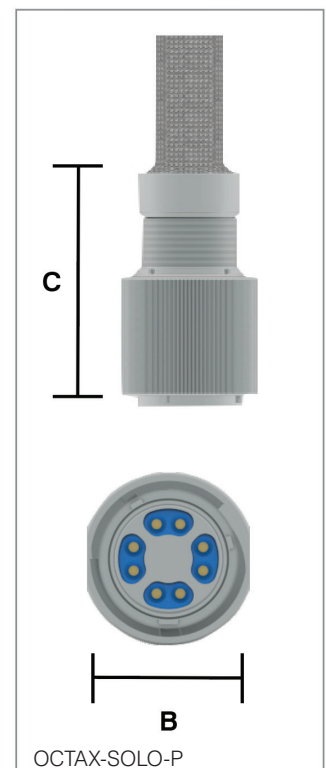

OCTAX[®] M38999 Style Circular Solutions

- » Meets the environmental requirements of D38999 Series III
- » Available in nickel or cadmium plating
- » Environmentally sealed
- » EMI shielded

SIZE VARIATIONS

Size 11

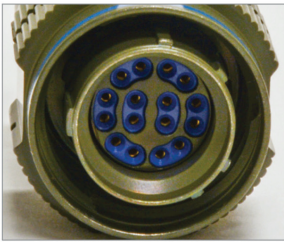

Octax[®] M38999 Style Circular Soltuions Size 11

Size 19



Octax[®] M38999 Style Circular Soltuions Size 19

Size 25

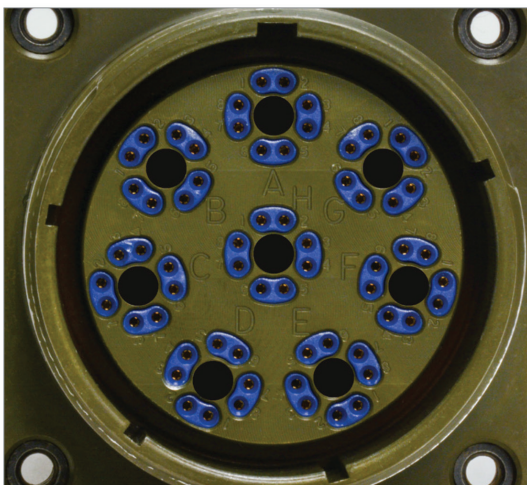

Octax[®] M38999 Style Circular Soltuions Size 25

OCTAX® D38999 Accessories



Replacement Braid Assemblies

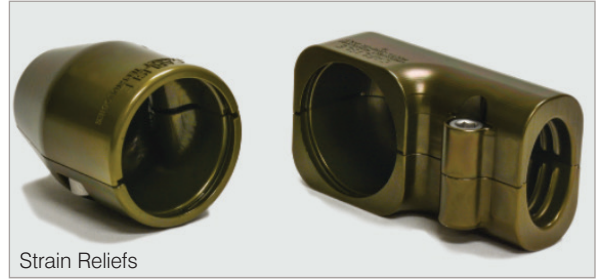

Strain Reliefs

Part Number	Description
HOCTAX38XX-BSIRT	Braid sleeve retention & installation tool
HOCTAX3811-02-PC	Protective installation cap, size 11
HOCTAX3819-04-PC	Protective installation cap, size 19
HOCTAX3825-08-PC	Protective installation cap, size 25
HOCTAX3811-02-BSA	Size 11 replacement braid assembly
AA59569R36T0250-8.5	Size 19 & 25 replacement braid
HOCTAX3811-SRW90	Size 11 38999 90° strain relief, cadmium finish
HOCTAX3811-SRWS	Size 11 38999 Straight strain relief, cadmium finish
HOCTAX3819-SRW90LP	Size 19 38999 Low profile 90° strain relief, cadmium finish
HOCTAX3819-SRWS	Size 19 38999 Straight strain relief, cadmium finish
HOCTAX3825-SRW90LP	Size 25 38999 Low profile 90° strain relief, cadmium finish
HOCTAX3825-SRWS	Size 25 38999 Straight strain relief, cadmium finish

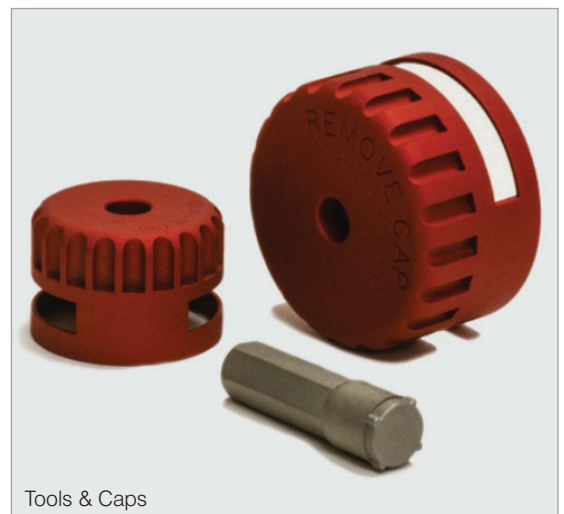

Tools & Caps

Please contact sales for more information on strain relief replacement hardware

Complete Solutions and Cable Assembly

CarlisleIT offers 35 years of custom cable assembly experience. We offer engineering support for build-to-print or design capabilities for a complete solution.

- » Built-to-print and custom cable assembly manufacturing
- » Discrete copper assemblies – ranging from single-end terminated to multi-breakout harnesses; one wire to over 1,000 wires
- » Rack and panel assemblies
- » Box build capability including complete turnkey electromechanical solution
- » Fully automated wire harness testing
- » Complete cable assembly design (when required) – 3D modeling, design verification & validation, documentation package
- » Design for manufacturability review (customer supplied designs) – component recommendations, component compatibility check, redline drawing support



Octax®-Solo

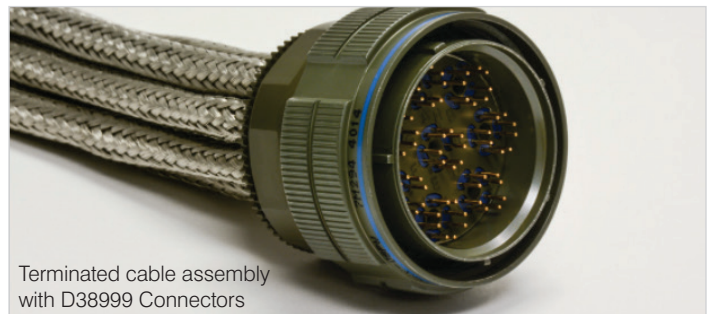

Terminated cable assembly with D38999 Connectors

Gigabit Series Cables Paired with OCTAX®

CarlisleIT offers several twisted pair 100 ohm cables that are compatible with the Octax® connector series. By matching our cables and connectors, our customers can feel confident that they have the optimal high-speed data solution.

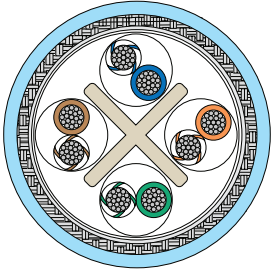
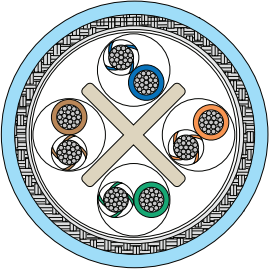
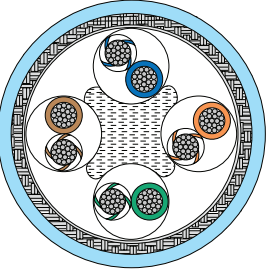
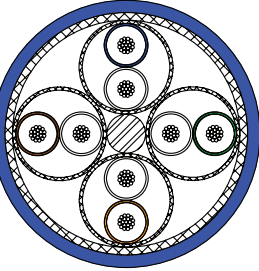
		Gigabit-10HP™	Gigabit-Plus™		Gigabit-Flexx™		Gigabit-STP™
							
		24 AWG	24 AWG	26 AWG	24 AWG	26 AWG	26 AWG
Part Number		MX10G-24HP	MX10G-24	MX10G-26	MX10G-24FLX	MX10G-26FLX	NF26-GBSTP-100
Impedance (ohms)		100	100		100		100
DC Resistance (100 ft)		2.76 ohms	2.76 ohms	4.38 ohms	2.76 ohms	4.38 ohms	4.38 ohms
Velocity of Propagation		70%	70%		70%		77%
Attenuation (100m)	100 MHz	22.0 dB	24.0 dB	29.0 dB	26.4 dB	31.6 dB	38.0 dB
	250 MHz	32.0 dB	40.0 dB	48.0 dB	-	-	62.0 dB
	500 MHz	48.0 dB	-	-	-	-	90.6 dB
Weight: lbs/1000 ft (Kg/1000 ft)		55 (82)	50 (74)	35 (52)	35 (52)	28 (42)	50 (74)
Size: in. (mm)		0.290 (7.36)	0.270 (6.86)	0.220 (5.59)	0.245 (6.22)	0.195 (4.95)	0.300 (7.62)
Min. Bend Radius: in. (mm)		0.50 (12.70)	2.00 (50.80)	1.75 (44.45)	1.00 (25.40)	0.75 (19.05)	3.00 (76.20)
Operating Temperature		-55 to 150°C	-55 to 150°C		-55 to 200°C		-55 to 150°C
Other		RoHS Compliant	RoHS Compliant		RoHS Compliant		RoHS Compliant
		Meets FAR 25.853 and Boeing/Airbus Smoke and Toxicity	Meets FAR 25.853 and Boeing/Airbus Smoke and Toxicity		Meets FAR 25.853 and Boeing/Airbus Smoke and Toxicity		Meets FAR 25.853 and Boeing/Airbus Smoke and Toxicity

Terminated Test Data

CAT6A testing: conducted with MX10G-24 cable terminated to in-line connectors. Tested on Fluke DTX-1800.

CAT7 testing: conducted with 25' + 50' + 50' + 25' NF26-GBSTP-100 cable terminated to in-line connectors. Tested with DTX-1800.

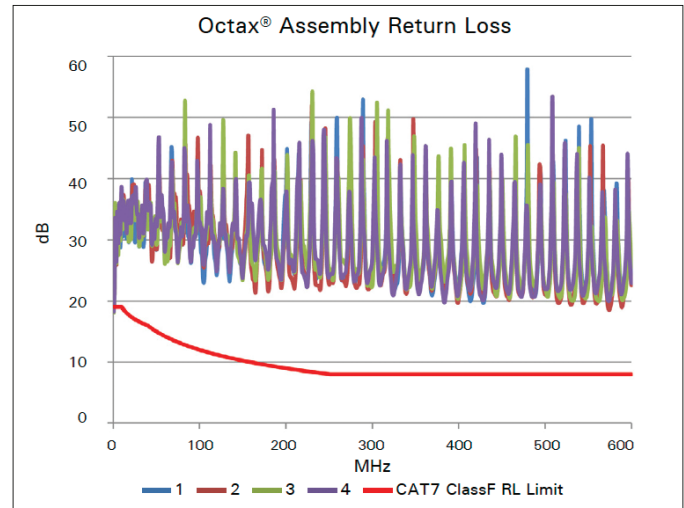
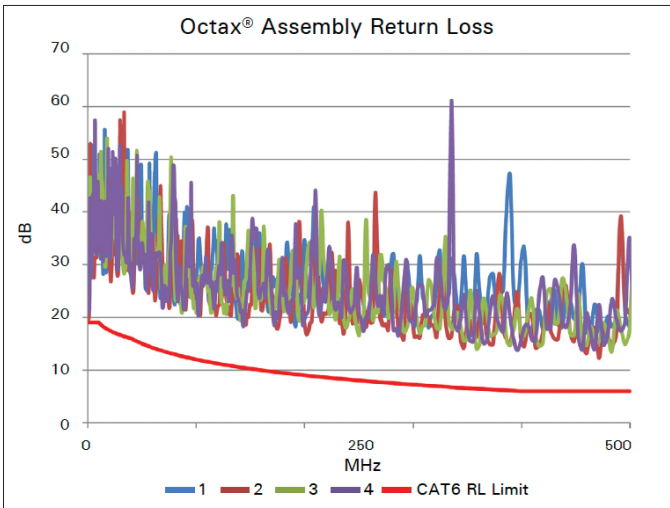
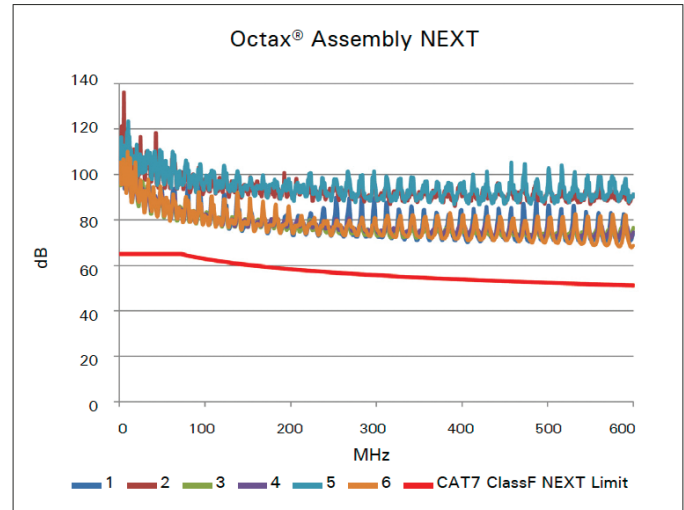
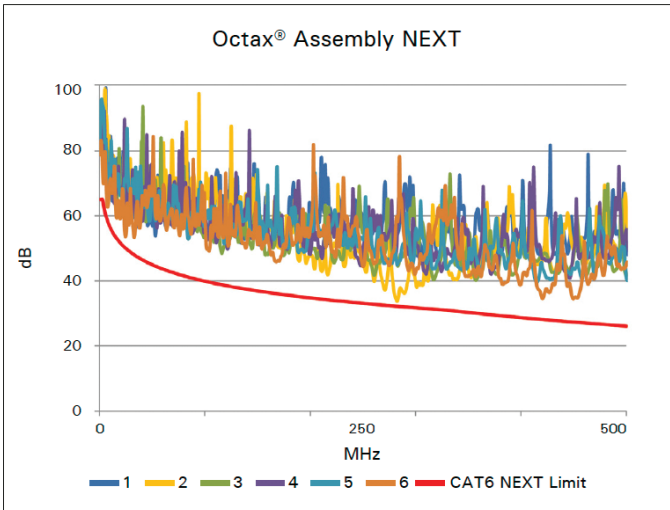
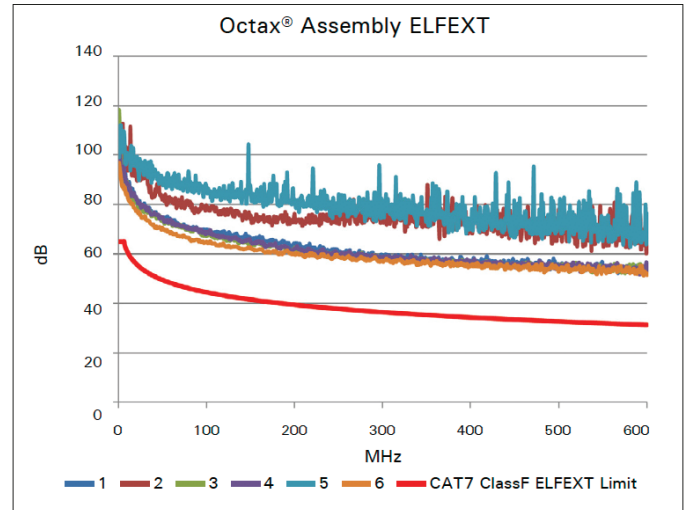
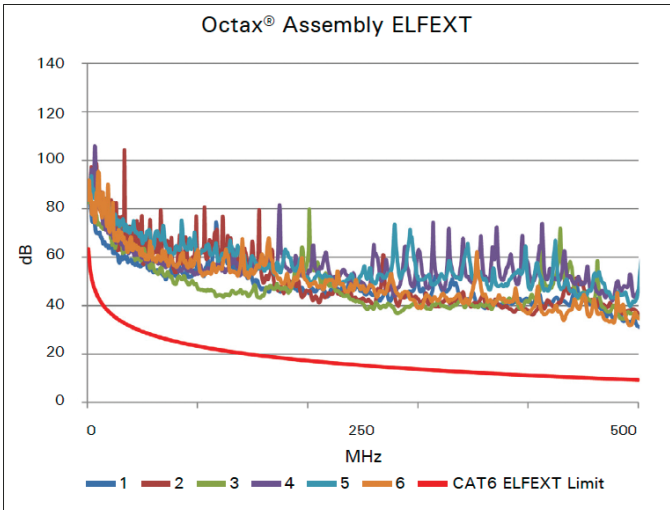



See CarlisleIT's line of Connectors & Accessories at:
[CarlisleIT.com/products/connectors-accessories](https://www.carlisleit.com/products/connectors-accessories)

+1 (800) 458.9960
Sales@CarlisleIT.com