

Offshore Electrical Cable Burial for Wind Farms: State of the Art, Standards and Guidance & Acceptable Burial Depths, Separation Distances and Sand Wave Effect



Project No. 671, Contract M10PC00102

Prepared for:

Bureau of Ocean Energy Management, Regulation & Enforcement - Department of the Interior

This report has been reviewed by the Minerals Management Service and approved for publication. Approval does not signify that the contents necessarily reflect the views and policies of the Service, nor does mention of trade names or commercial products constitute endorsement or recommendation for use.

November 2011

Malcolm Sharples, P.E.

Bureau of Ocean Energy Management, Regulation and Enforcement

Offshore Electrical Cable Burial for Offshore Wind Farms on the OCS

Front Page Acknowledgement
[Courtesy ABB]

REPORT AVAILABILITY

A complete copy of this report may be downloaded from the BOEMRE Technology Assessment & Research (TA&R) Program's website at <http://www.boemre.gov/tarprojects>. This project is numbered as TA&R project 671.

ACKNOWLEDGMENTS

The authors wish to thank the Bureau of Ocean Energy Management, Enforcement and Regulation Technology Assessment and Research Branch for funding this study and Lori Medley, and John Cushing for critical and insightful comments associated with the work.

AUTHORS' NOTE, DISCLAIMER AND INVITATION:

This document has been written by engineers experienced in the offshore oil and gas industry although much information, advice and comment has been provided by those with years of experience in various aspects of the wind turbine industry. Many of the points made in this report may be subject to a different interpretation, and the facts may differ from the information relied upon which is believed to be factual. This report has been written without prejudice to the interests of any parties mentioned or concerned and the Company and authors shall not in any circumstances be responsible or liable for any act, omission, default, or negligence whatsoever.

While we have used our best efforts to provide an impartial report, errors of fact or interpretation may have resulted: consequently, an invitation is issued to any readers to provide written comment for a limited period of time which will be reviewed for possible inclusion in an addendum to this report. Comments may be sent by email to msharples@offshore-risk.net.

Table of Contents

ABBREVIATIONS

EXECUTIVE SUMMARY.....	2
1. INTRODUCTION.....	6
1.1 Planning Overview.....	6
1.2 Cable Selection on Wind Farm Submarine Cables to Date.....	9
1.3 References.....	15
2. REGULATIONS AND REGULATORY ISSUES.....	16
2.1 Regulatory Requirements of 30 CFR 285 on Subsea Power Cables.....	16
2.2 Cables and Mariners/ Fishermen.....	16
2.3 Legal Restrictions to Cable Vessel Operations and the Jones Act.....	17
2.4 USCG and Customs & Border Protection.....	18
2.5 United States Army Corps of Engineers (USACE) Viewpoint.....	19
2.6 References.....	20
3.0 HISTORICAL INCIDENTS WITH CABLES.....	22
3.1 References.....	23
4.0 CABLE TYPE SELECTION & INSTALLATION CONSIDERATIONS IN CABLE DESIGN.....	27
4.1 Types and Manufacture.....	35
4.1.1 Basic Information on Cable Construction.....	35
4.1.2 Conductors.....	36
4.1.3 Insulation.....	37
4.1.4 Screening.....	38
4.1.5 Bending Radius.....	38
4.1.6 Sheathing.....	38
4.1.7 Armoring.....	38
4.1.8 Jacket.....	39
4.1.9 Fiber Optic Cables.....	39
4.1.10 Cable Joints.....	40
4.2 Cables and Heat.....	40
4.3 Electromagnetic Fields (EMF).....	47
4.3.1 EMF and Alternating current.....	47
4.3.2 EMF and Direct current.....	48
4.3.3 Further Explanations of EMF.....	48
4.4 Cables for Floating Wind Turbine Application.....	50
4.5 Cable Type Selection Summary.....	51
4.6 References.....	51
5. SPECIAL CONSIDERATIONS.....	53
5.1 Installations in Seismically Active Areas.....	53

5.1.1 Newfoundland 1929	53
5.1.2 Hengchun Earthquake near Taiwan 2006	54
5.1.3 Other Seismic Events and Discussion of Potential Effects on Submarine Cables	54
5.1.4 Historical Seismic Events in the US	55
5.1.5 Seismic Design Considerations	56
5.1.6 Seismic Areas of United States	57
5.1.7 Mitigating Actions for Seismic Areas	59
5.1.8 References	60
5.2 Sand Wave Effects on Route Selection	62
5.2.1 Overview of Sand Wave Issue	62
5.2.2 Installation Issues in Sand Waves	63
5.2.3 Mitigating Actions for Sand Waves	64
5.2.4 References	64
5.3 Separation Distances	65
5.3.1 Vertical Separation	65
5.3.2 Cable Protection at Vertical Crossings	67
5.3.2 Horizontal Separation	69
5.3.3 Non-Technical Issues	69
5.3.4 Separation Distance Recommendations	70
5.3.5 References	70
6. ROUTE SELECTION	72
6.1 Desktop Study	75
6.2 Metocean Information	76
6.3 Route Assessment Field Survey	76
6.4 Burial Assessment Survey	78
6.4.1 Burial Assessment Survey by Pulling the Plow	78
6.4.2 Burial Assessment Survey with Instrumented Sled	79
6.5 Route Selection Summary	85
6.6 References	85
7. NAVIGATION RISK ASSESSMENT	87
7.1 Information Needed	87
7.2 Sources of Information	88
7.3 Recreational Vessels	92
7.4 Fishing Gear	92
7.5 Construction Vessels	94
7.6 Ship Anchors: Depth of Potential Damage from Anchor Release	94
7.7 Quantitative Risk Analysis : Step-by-Step Method	99
7.8 Qualitative Risk Analysis: Step-by-Step Method	102
7.9 Effects of Cables on Marine Navigation	106
7.10 Assumptions of Due Diligence	106
7.11 Acceptance of Risk	106
7.12 Mitigation of Risk	106
7.12.1 Mitigation by Exclusion Zones	106

7.12.2 Mitigations Available from Signs, Beacons and Potential Exclusion Zones	107
7.13 References	109
8. CABLE PROTECTION	111
8.1 Burial Protection Index	115
8.1.1 A Simulation Model: Building on the BPI Index Concept.....	119
8.2 Repair and Armoring Issues.....	119
8.3 Decommissioning of Cable	119
8.4 Protection at the Shore Landing.....	120
8.5 Protection from Ice Rafting: Offshore Maine and Alaska	120
8.6 Rock Dumping and Plastic Sheaths.....	120
8.7 Scour Protection.....	122
8.8 Post Installation Survey	124
8.9 In-Service Inspection Plan	124
8.10 References	125
9.0 INSTALLATION CONSIDERATIONS.....	126
9.1 Installation Vessels	126
9.2 Trenching and Burial Equipment.....	129
9.2.1 Mechanical Plows.....	130
9.2.2 Jet Plows.....	133
9.2.3 Rock Saw	136
9.2.4 Dredging.....	137
9.2.5 Horizontal Directional Drilling.....	137
9.2.6 Interface at the Turbine	138
9.2.7 Vessel Functions to Deploy Inter-Array Cables.....	141
9.2.8 Activities to Deploy Shore Connections.....	142
9.4 References	143
10. DOCUMENTATION.....	145
11. RECOMMENDATIONS	146
11.1 Specific Information Recommended for Inclusion in the Facility Design Report.....	146
11.2 Recommendations for Research Topics	147
11.3 Other Recommendations	148
APPENDIX A: HISTORICAL CABLE INCIDENT DETAILS AND REFERENCES.....	149
A.1 Arklow Bank	149
A.2 Barrow	149
A.3 Blyth	149
A.4 Bockstigen	150
A.5 Burbo Bank	151
A.6 Horns Rev.....	151
A.7 Kentish Flats.....	152
A.8 Lynn and Inner Dowsing.....	152
A.9 Middelgrunden	152

A.10 Nysted.....	152
A.11 Robin Rigg	152
A.12 Scroby Sands.....	153
A.13 Skegness Offshore Wind Farm	155
A.14 Teeside Offshore Wind farm.....	155
A.15 Utgrunden.....	155
A.16 Oil & Gas Platform “Hogan”, Offshore California – Repair/Replacement Cable.	155
A.17 General Review of Historical Experience	157
A.18 For Further Reading.....	163
A.19 Germanischer Lloyd Advice	163
APPENDIX B DESIGN OF, REPAIR OF, and LIFE OF SUBMARINE CABLES	165
B.1 Design Issues	165
B.2 Repairing Cables	169
B.2.1 Contingency Cable Lengths	171
B.2.2 Issues for Repair	171
B.2.3 Repair Costs	172
B.3 Life of Cable & Maintenance.....	173
B.4 References	174
APPENDIX C: TOOLS TO DETERMINE SUITABILITY OF ROUTE.....	175
C.1 Bottom Profile	175
C.2 Side Scan Sonar.....	177
C.3 Remote Operated Vehicle – Camera.....	179
C.4 Geophysical Survey on Site.....	179
C.4.1 Sub Bottom Profiler.....	179
C.4.2 Magnetometer	180
C.5 Soil Surveys in the Field.....	181
C.5.1 Cone Penetrometer Test (CPT).....	182
C.5.2 Thermal Conductivity Probe.....	184
C.5.3 Soil Samples	186
C.5.4 Vane Shear Test	186
C.5.5 Soil Testing	187
C.6 Report on Soils & Bottom Conditions.....	189
C.7 References	191
APPENDIX D: TYPICAL INSTALLATION VESSELS USED TO DATE.....	192
APPENDIX E: SUBMARINE CABLE INSTALLATION EXAMPLE OFFSHORE WIND FARM- BLYTH.....	203
E.1 Overview.....	203
E.2 Beach Preparatory Work.....	205
E.3 Cable Landing at the Turbines.....	205
E.4 Diving Operations	205
E.5 Cable Lay Operations between the Northern & Southern Turbines	206

E.6 Cable Lay Operations Across the River Blyth206

Table of Figures

Figure 4.1: Horns Rev Export Cable 170 kV 3 _____ 29

Figure 4.2: Subsea Cable details of Cross Section _____ 30

Figure 4.3: Sheringham Shoal, Lincs & London Array (Courtesy Nexans) _____ 30

Figure 4.4: Cross Section of 70 Sq. mm Double Armor with 16 fibers Optic Package _____ 31

Figure 4.5: Cable Terminations at Horns Rev 2 (Courtesy Nexans) _____ 31

Figure 4.6: Accessory Hangoffs (Courtesy Nexans) _____ 32

Figure 4.7: Hangoff and Termination – London Array (Courtesy JDR). _____ 32

Figure 4.8: Typical 3 Phase AC Cable bundled with Fiber optic and Single Cable _____ 35

Figure 4.9: Nominal Power for 2 applications of HVDC and various Conductor Cross-sections _____ 37

Figure 4.10: Rocky Terrain Offshore Maine – _____ 39

Figure 4.11: Temperature contours around a pair of submarine HVDC cables. _____ 42

Figure 4.12: Temperature contours around a pair of submarine cables on the left and a pipeline on the right with a 50° C surface temperature. _____ 43

Figure 4.13: Temperature rise at -0.2m and -0.3m below the sea floor. _____ 44

Figure 4.14: Temperature as a function of time and burial depth in meters. _____ 45

Figure 4.15: Temperature profile in a single-core cable and surrounding soil _____ 45

Figure 4.16: Current Rating as a Function of Burial Depth (Example) _____ 46

Figure 4.17: Magnetic field around a parallel bipolar cable (left), with currents in opposite directions. _____ 49

and around a co-axial cable (right), with opposite currents in the inner and outer conductors. _____ 49

Figure 4.18: Floating Power Plant www.floatingpowerplant.com potentially proposed offshore Oregon. _____ 50

Figure 5.1: Map of Taiwan area Illustrating the Cable Break Issue _____ 54

Figure 5.2: The largest landslide in Anchorage occurred along Knik Arm between Point Woronzof and Fish Creek, _____ 55

Figure 5.3: International Offshore Cable Routes (from Global Marine Systems Ltd.) currently in use. _____ 56

Figure 5.4 (a): 5% damped Spectral Response Accelerations for offshore North America _____ 57

Figure 5.4 (b): 5% damped Spectral Response Accelerations for offshore North America _____ 58

Figure 5.5: Seismic Risk in U.S. Coastal Waters (0 is low, 5 is high) _____ 59

Figure 5.6: Diagram showing the relationship between stream velocity and ability to transport material of varying sizes. _____ 63

Figure 5.7: ROV deployment of concrete protection _____ 68

Figure 5.8: Concrete mattress in place protecting pipeline from cable laid above it.

Figure 5.9: Concrete Bags Protection _____

Figure 5.10: Mattress Protection _____ 68

Figure 6.1: Cartoon examples of various geohazards. _____ 73

Figure 6.2: Four Alternates Routes form one location to another as a function of topography. _____ 75

Figure 6.3: Mini-Plow _____ 79

Figure 6.4: Basic Assessment Plow _____ 79

Figure 6.5: Typical Burial Assessment Survey Sled _____ 81

Figure 6.6: GAMBAS – Tow Sled for Seismic Refraction [Ref. 6.14] _____ 83

Figure 6.7: Progress rate as a function of undrained shear strength for 2 jet pressures. _____ 83

Figure 6.8: Burial Assessment Example Graphic Final Product _____ 85

Figure 7.1: Screen Shot of East Coast Ports March 12, 2011 6:30 pm. _____ 91

Figure 7.2: Showing the Load Line on a ship: _____ 92

Figure 7.3: Relationship between Trawl Door Penetration and Soil Shear Strength _____ 94

Figure 7.4 Fluke Angle of Typical Ship Anchor _____ 97

Figure 7.5: Frequency vs Consequence Matrix _____ 103

Figure 7.6: Risk Analysis Matrix _____ 104

Figure 7.7: Cable protection zone New Zealand	107
Figure 7.8: Legends from a NOAA Chart describing the Cable symbols.	108
Figure 8.1: Cross Section of Cable with Single Armor Layer.	112
Figure 8.2: Typical Ship Drag Embedment Anchors	114
Figure 8.3: Typical Offshore Rig Anchors	114
Figure 8.4: Illustration of Burial Protection Index.	115
Figure 8.5: Depth of Penetration of Trawl against the Soil shear Strength in Clay.	117
Figure 8.6: The variation in burial depth with Clay Strength for use with BPI.	117
Figure 8.7: Variation in Burial Depth with Relative Density of Sand	118
Figure 8.8: Illustration of Rock Dumping	121
Figure 8.9: Cartoon of Rock dumping	121
Figure 8.10: Proprietary system to protect the Export cables to London Array (Courtesy Cicor International)	121
Figure 8.11: Scour Illustration from DNV OS J 101 2007 [Ref. 8.9]	122
Figure 8.12 BOEMRE Report Figure 5-2	123
Figure 9.1: Cable laying within a wind farm (Courtesy Nexans)	128
Figure 9.2: shows a plow as per Figure 9.3, providing a better view of the details of the “share”.	130
Figure 9.3: Plow showing forces in Cartoon (above) and plow below:	131
Figure 9.4: Pipeline Plow	132
Figure 9.5: Sea Stallion 4 Cable Plow Burying North Hoyle Export Cables up the Beach	133
Figure 9.6: Cable Jetting device. The sword carrying water nozzles is visible and working.	134
Figure 9.7: Jet Plow - Perry Slingsby.	135
Figure 9.8: Oceanteam Vertical 30m Jetting Tool	136
Figure 9.9: Wheel cutter for rocky sea floor	136
Figure 9.10: Rock saw can reach down 4 meters in soft rock	137
Figure 9.11: J –Tube assembly.	138
Figure 9.12: J-tube laid on side during construction	139
Figure 9.13: Photos of the Installation process	140
Figure 9.14: TEKLINK® Cable Protection System.	141
Figure 9.15: Buoyed Line with cable being brought ashore.	142
Figure 9.16: showing a connection made in a cofferdam at the beach (Netherlands)	143
Figure A.1: Scroby Sands Illustration of Scour	154
Figure A.2: Fledermaus image showing the survey of February 2005 from the Scroby Sands Offshore Wind Farm.	154
Figure A.5: D/B JC Freese 30 ton crane,	
Figure A.6: Splicing with the expert Jointers	156
Figure A.7: Splice box being filled with No-Void	
Figure A.8: Splice box rigged and ready	156
Figure A.9: Pulling cable	156
Figure A.10: Damage from 2,162 records spanning 1959–2006. Source: Tyco [Ref. 3.37]	159
Figure A.11: Clearing debris off the seabed	161
Figure A.12: Ensuring there are no kinks in the line	161
Figure A.13: Sources of External aggression from a Recent Paper on Cable Faults	162
Figure A.14: Dropped Object (courtesy Nexans)	
Figure A.15: Anchoring (courtesy Nexans)	163
Figure B.1: Typical HVAC Submarine Power Cable: 3 Phase Bundled with Fiber-Optic Elements (Courtesy NSW)	167
Figure B.2: Voltage drop characteristics	
Figure B.3: Kilowatt (kW) loss characteristics	168
Figure B.4: 2007 Cable Ships by Market	170
Figure B.5: Tinsley Survey System	
Figure B.6: Ocean scan – survey system	171
Figure C.1: Single Beam and multiple single beam echo sounder.	176

Figure C.2: Multi-beam Echo sounder	176
Figure C.3: Artist’s Rendition of Lidar Survey	177
Figure C.4: Side Scan Sonar – how it works, and view of the resulting image viewed with side scan sonar	178
Figure C.5: View of a survey processed with advance route planning techniques	178
Figure C.6: Sub Bottom Profiler showing survey Interpretations	179
Figure C.7: Sub Bottom Profile Results after identification	180
Figure C.8: Unexploded Ordinance from Magnetometer survey	181
Figure C.9: CPT Skid	182
Figure C.10: The SEAROBIN is one of the widely used CPT units for determining the soil for the route assessment.	182
Figure C.11: PCPT Instrument	183
Figure C.12: Pore Pressure Probe	183
Figure C.13: Temperature Probe	183
Figure C.14: Example of a complete system for measurement of soil thermal conductivity	185
Figure C.15: Thermal property characteristics of Various soils	185
Figure C.16: Vane Shear Test Instrument	186
Figure D.1: Oceanteam Installer – a flat bottom barge (Courtesy of Oceanteam Power and Umbilicals).	192
Figures D.2: Henry P. Lading.	193
Figure D.3: AMT Discoverer was the cable laying vessel for Rhyl Flats for the inter turbine cables.	194
Figures D.4: AMT Explorer	194
Figure D.5: Global Marine Systems C.S. Sovereign	195
Figure D.6: Pontra Maris	195
Figure D.7: Normand Mermaid	196
Figure D.8: UR101 Beached at Lynn and Inner Dowsing,	196
Figure D.9: Polar Prince	197
Figure D.10: Coiling Submarine Cable prior to Deployment	199
Figure D.11: Protective Plastic shells	199
Figure D.12: Installation Vessel installing the cable (Courtesy ABB).	200
Figure E.1: Coastal Explorer	203
Figure E.2: Coastal Explorer laying the inter-array Cables	203
Figure E.3: Cross Section of 70 Sq. mm Double Armor with 16 fibers Optic Package	204
Figure E.4: Shore Connection dug into the Rocks (Source: Figure 12 www.berr.gov.uk/files/file_18014.pdf)	206
Figure E.5: Dredger Operation with Pontoon alongside.	207

Table of Tables

Table 1.2 Cable Selection on Wind Farm Submarine Cables to Date.....	11
Table 2.1 Sample of USACE Burial Depths for Various Submerged Power Cables.....	20
Table 4.1 Comparison of Features of Various Cables.....	33
Table 4.2 Typical Cable Characteristics of AC Cable.....	37
Table 7.1 Penetration of fishing gear in various soil types [Modified from Ref. 7.17].	93
Table 7.2: Example of Ship Types, DWT, Anchor Sizes and Estimated Penetrations.....	96
Table 7.3 Mitigation Measures (Risk Reduction).....	105
Table 8.1 Burial Depths – Borkum West	115
Table A.1 Failure Statistics	158
Table B.1 Estimated Cost of Repair	173
Table B.2 Estimated Total Cost of Repair.....	173
Table C.1 GL Noble Denton Criteria for Seabed and Sub-Seabed Data Required for Approval of MOUs (Mobile Offshore Units)	187
Table C.2 Basic Soil Parameters Required for Cable Route	188

Table C.3 Additional Soil Parameters for Specific Cable Problems 189
Table D.1 Offshore Wind Farm and Installation Vessels believed to have been on site. 202

ABBREVIATIONS

ABS	American Bureau of Shipping
AC	Alternating Current
AIS	Automatic Identification System
API	American Petroleum Institute
BSH	Bundesamt für Seeschifffahrt und Hydrographie (Federal Maritime and Hydrographic Agency)
CFR	Code of Federal Regulation
CIGRE	International Council on Large Electric Systems
CBP	Customs and Border Protection
CPT	Cone Penetrometer Test
CVA	Certified Verification Agent (of the BOEMRE, now BSEE)
DC	Direct Current
DNV	Det Norske Veritas (Classification Society)
EMF	Electro Magnetic Field
EPR	Ethylene Propylene Rubber (Cable)
GL	Germanischer Lloyd (Classification Society)
GPS	Global Positioning System
HVAC	High Voltage Alternating Current
HVDC	High Voltage Direct Current
ICPC	International Cable Protection Committee
IEC	International Electrotechnical Committee
IEEE	Institute of Electrical and Electronic Engineers
IMCA	International Marine Contractors Association
ISO	International Standards Organization
km	kilometers
kPa	kilo Pascals
kV	kilo Volts
m or m.	meters
MW	megawatts
NOAA	National Oceanic and Atmospheric Administration
NTL	Notices to Lessees - a method of distributing notices used by BOEMRE
NVIC	Navigation and Vessel Inspection Circular
OCS	Outer Continental Shelf
SOLAS	Safety of Life At Sea
USACE	United States Army Corps of Engineers
USCG	United States Coast Guard
XLPE	Cross-Linked Polyethylene (Cable)

EXECUTIVE SUMMARY

The challenge of ensuring the integrity of the submarine power cables: getting the power back to shore is the subject of this Report. Some 70% of insurance claims for offshore wind farms come from the submarine cables. Loss of power, for an extended period may lead to further damages to the turbine equipment/structure.

The Introduction gives an overview of the purpose of the study to:

- Establish general electrical cable burial guidance that is based on expected vessel traffic, potential anchor types and drag depths, and recreational usage for the area. This guidance will include issues involved in selecting the optimum route for cables; cable type selection; installation considerations; and cable protection options.
- Establish guidance to determine acceptable separation distances and potential protection methods for instances where electrical cables cross other electrical cables, communication cables, etc.
- Establish special considerations for cable installations in seismically active areas and areas with significant sand waves.

...and presents in tabular form the available information on the cable type and other parameters of the submarine cables installed to date.

The Planning Overview describes the inter-dependence of the geotechnical surveys, cable design, communications and monitoring system selected, installation vessel selection and optimal cable protections including burial depth, in order to plan the route and design the cable. Cable supply is currently is backlogged about 2 years and thus late changes in cable design can become a major problem.

A Regulatory Section 2 summarizes and comments on the BOEMRE requirements 30 CFR 285 on Submarine Power Cables noting the narrow rights-of-way in the US compared to Europe, and discusses cable laying vessels working in US waters. Historical requirements of the US Army Corps of Engineers for burial depths are explored chronicling the requirements for other submarine electrical cable projects.

Results of research on historical incidents with submarine power cables on offshore wind farms is presented in a "Historical" Section 3 related to 16 incidents, including MMS's experience with the submarine cables for Platform "Hogan". Appendix A contains some details of the source information.

Cable Type Selection and related Installation Considerations, Section 4, outlines the many variables that need to be taken into account. More detail on the design and repair issues, and life of the cable are given in Appendix B. It is most likely that the cable selected for Offshore Wind Farms on the OCS will involve 36 kV cables in-field and initially to shore when close in. As the fields move further offshore a gathering platform (transformer platform), will step up the voltage to HVAC and export cable(s) will transport the electricity to shore. As offshore wind farms move yet further offshore and HVDC equipment becomes cheaper the gathering platform will step up the voltage and also change to HVDC to transmit the electricity a greater distance to shore. Since armoring protects the cable from damages of recreational vessels, interaction in rocky areas, as well as provides the

tension resistance for cable laying, a section describes its function. Cable handling is also commented on since how the cable is to be handled during installation determines the design lay of the cable: whether the armoring is laid in a spiral S-lay or a spiral Z-lay. The subject on cable joints is discussed both in factory and for repair or jointing in the field.

Section 4 also discusses the reaction of cables to heat and how burial depth, temperature variations with season, salinity, soil types and other factors that are recommended to be calculated in order to determine the temperature of the cable which factor into the cable(s') life expectancy. While anecdotal information during our research indicates that the analysis of temperatures may not be carried out as robustly as computer programs now allow, this outlines the best practices for consideration. .

From cable design considerations, the burial depth of a minimum of 1 meter was determined from a number of requirements (mainly one of heat dissipation) extending to possibly 2 meters+ for HVDC cable, and beyond this value increased burial is not recommended, considering the cable issues alone, since the current capacity continues to degrade with depth.

A summary of research on electromagnetic fields (EMF) is presented concluding that monopolar DC cables are to be avoided, and other arrangements are acceptable. Finally for floating wind turbines some points for consideration are offered.

Guidance is offered in Section 5.1 for special considerations for cable installations in seismically active areas. Earthquakes have been a significant feature in telecommunications cables but electrical cables are more robust and situated in circumstances where damage is much less likely, e.g. avoiding mudslide areas. It is concluded that extreme earthquakes where ground upheaval is significant there are no reasonable mitigations that can completely avoid damage. For smaller quakes where ground displacement is an issue then the mitigation of laying spare cable parallel to the direction of the fault line can minimize the probability of damage.

Sand Wave Effects are discussed in Section 5.2 describing the relationship which form sand waves, outlining installation issues and outlining mitigation methods which include burial depth under the trough, protection with rock, and frequent inspection and remediation.

Vertical and Horizontal Separation Distances are discussed in Section 5.3 concluding that a 12 inch vertical separation is generally sufficient but that calculations should be carried out to determine any detrimental effect of heat between the wind farm submarine cable and other cables/pipelines. Protection in the vertical plane in the form of concrete mats etc. is noted. The horizontal separation distance to avoid interference during repairs is recommended at a minimum of 20 ft. and the separation when providing two cables to avoid damage from ship anchors while very site-specific and determined by a Navigation Risk Assessment a basic separation distance of 200 yards is recommended.

Section 6 discusses the Route Selection for the submarine cable outlining the required considerations for water depth, rocky shores, scour, boulder fields, marine slope instability, and soil properties mentioning the importance of avoiding incompetent soils such as those with a heavy organic content. The Tools for carrying out the determination of Route Selection are found in Appendix C including information on detailed survey equipment available and typical laboratory tests to be carried out. The optimum route minimizes the distance for the cable(s) to be laid with consideration of deviations to mitigate potential hazards along the route. A Desktop Survey is first performed, then a more detailed

Route Assessment Field Survey and finally a Burial Assessment Survey. This information is sufficient to determine the likely route from “internal” issues, meaning from all but the external aggression dealt with in the Navigation Risk Assessment, Section 7. The information developed by the techniques described both in the Route Assessment Field Survey and the Burial Assessment Survey provide input to design of cables and armoring, for confirmation of the potential burial depth, subject to accounting for external aggression. The information also provides sufficient data to determine the speed with which the cable can be laid and the selection of burial equipment.

The Navigation Risk Assessment, Section 7, lays out the sources and techniques for determining the expected vessel traffic and threats to a buried cable in order to determine both the route and recommended burial depths from this variable. This section discusses potential anchor types but research carried out for purposes of determining the penetration of anchors suggests that the principal variable is fluke angle of the anchor which is more important than anchor size, weight or type. Quantitative risk analysis or qualitative risk analysis are the methods of typically used for rationalizing the burial depth based on navigation risk. The ship anchor threat requires specific information about the highest potential location for an accidental anchor drop and/or emergency attempt to anchor, and how to determine it, its distance from the cable and the likelihood (based on water depth, soil, initial penetration etc.) of the anchor fouling the buried cable.

Section 7 also discusses mitigations by using exclusion zones which are used elsewhere in the world, and from signage and beacons that regulatory agencies may mandate.

Section 8 deals with Cable Protection and the concept of the Burial Protection Index so that a variation to the soils along the route can afford the same protection by a variation in the burial depth. It discusses the factors that go into determining burial depth based on several variables as discussed from various factors:

- from cable design risks in Section 4 where the burial depth of a minimum of 1 meter was determined from a number of requirements (mainly one of heat dissipation) extending to possibly 2 meters+ for HVDC cable, and beyond this value increased burial is not recommended since the current capacity continues to degrade with depth;
- from installation risks in Section 9 where except in special circumstances the burial depth of 1-2 meters appeared to be customary, achievable with reasonably sized equipment without significant bottom disturbance;
- from routing risks in Section 6 ensuring that a route providing burial depths of 1 meter or more would be optimum;
- from special considerations in Section 5 where burial 1 m. below sand dune troughs was ideal but the risk may be able to be mitigated by constant inspection and remediation; in seismic areas the only mitigation is to allow extra cable to be buried for a reasonable distance parallel to the fault line to mitigate a separation distance;
- from navigation hazards in Section 7 where recreational vessel threat can be mitigated with armoring, fishing vessel threat can be mitigated by armoring and burial of 1 meter, and ship anchor interactions can be minimized by determining the most probable location of a dropped anchor and avoiding it by at least 100+ yards or other mitigations.

Section 8 on cable protection concludes from all considerations is that the “norm” for burial depth acceptance of electric submarine cables, can be summarized as:

- In an anchorage area or in a channel with sizeable ship traffic where considerable maneuvering is required which may result in a ship deploying an anchor i.e. port entry: approx. 15 ft. (4.5 m.) below seabed (as noted from USCOE guidance Section 2);
- in all other areas between 1 m. and 2 m. (3ft. to 6 ft.) depending on cable design requirements for burial, installation needs, and site-specific circumstances.

Adjustments can and should be made from these “baseline figures” from special considerations:

- Deeper burial is required in softer sands where trawler nets may penetrate, and shallower burial is suitable in stiffer soils, such as dense clays;
- Rocky areas may be protected with rock berms or by cutting into the rock in some circumstances;
- Additional armoring may offer some extra protection if protecting against marginally larger than recreational or fishing vessels;
- Rocky bottoms and areas of scour may lead to unsupported lengths so armoring in opposite lays may provide mitigations against unsupported lengths.

Cable protection methods are outlined further in terms of rock dumping for rocky areas, techniques of burial near the coast where horizontal directional drilling may be used, and the special considerations scour protection in high current areas particularly at the interface at the turbine structures, and for areas expecting rafted ice. The importance of the Post-Installation Survey and a plan for In-Service Inspection and Repair is discussed.

In Section 9 the cable installation vessel and equipment spreads are explored listing the likely equipment required for trenching and burial of the submarine cable for various soil types including rock. Appendix D provides information, when available, on the vessels and equipment used for the installation for European offshore wind farms, mentioning some of the features of those vessels. An overview of the installation procedures is given for the J-tube interface at shore noting the historical issues and recommending attention be paid to the bending radius, the smoothness of the inner surfaces, the fill % values to prevent overheating, and the issue of ensuring that the exit of the cable is below the scour depth. Activities are laid out for the shore approach and an example given of the general procedures noting that options for shore approach may include horizontal drilling, beach landing or making connection using a cofferdam, the example provided notes its purpose of the cofferdam connection was to connect after drilling under shore dunes.

Section 10 outlines the Documentation recommended to be retained throughout the life of the cable.

Finally some Recommendations are made in Section 11 separated into those items which may be considered for inclusion in the Facility Design Report, and those items that may be considered for research subjects which are important to progressing the knowledge and understanding of submarine cable protections for offshore wind farms.

1. INTRODUCTION

Building offshore wind farms has many challenges. A key challenge, elaborated on in this report is that of ensuring the integrity of the submarine power cables: getting the power back to shore. Output from a wind farm is entirely dependent on the integrity of the in-field and export cables, but compared to higher-profile issues such as turbine layout, turbine tower and foundation design it tends to receive less attention than deserved. Cabling currently accounts for between 8% and 10% of a project's overall costs, but some 70% of insurance claims involve submarine power cables [Ref. 1.5].

During operations, subsea cables represent a key risk in the connection of the offshore wind farms to the grid being as they are generally a "single point of failure" of the wind farm. Cable failures in offshore wind farms to date have resulted, typically, in the loss of several months offline before they could complete repairs and/or replacement of significant portions of the cables. During this time there may be no power on the turbine for heaters and dehumidifiers for periods of several weeks or months possibly leading to corrosion and other issues from the marine air conditions and perhaps physical damage due to mechanical equipment standing by in one configuration.

The purpose of this research is to:

- Establish general electrical cable burial guidance that is based on expected vessel traffic, potential anchor types and drag depths, and recreational usage for the area. This guidance will include issues involved in selecting the optimum route for cables; cable type selection; installation considerations; and cable protection options.
- Establish guidance to determine acceptable separation distances and potential protection methods for instances where electrical cables cross other electrical cables, communication cables, etc.
- Establish special considerations for cable installations in seismically active areas and areas with significant sand waves.

1.1 Planning Overview

There is great inter-dependency between variables that are important to the design of a cable. Prior to designing the cable it is recommended that the vessel equipment and vessel layout that will be used laying the cable is identified since the cable laying vessel equipment is part of the design input to the cable. The BOEMRE Guidelines for Information Requirements for a Renewable Energy Construction and Operations Plan (COP) dated December 17, 2010 reflect this recommendation (b)(11). Cable design requires detailed information about the forces to be absorbed by the cable during installation: while coiling for storage on board the vessel and during deployment, the speed of deployment and the amount of catenary in the water depth among other variables.

The geological and geophysical conditions must be known both to the installer and to the cable designer before selection of the installation equipment and for the cable to be designed.

During development of the Construction and Operations Plan it is recommended that the cable designer, installer, and the geotechnical and geophysical contractors are involved with the owner and

regulator to ensure that the information being developed is satisfactory to all stakeholders in order to achieve an optimum design and best practice for the submarine cables at the site-specific location. While the geophysical campaign is guided by the BOEMRE recommended Guidance [Ref. 2.1] the sample points may increase if the bottom conditions are rocky, and deviations may be permitted if the bottom conditions are uniform: optimal locations can be sampled and optimal sampling techniques used because of input requirements to the cable design, the installation and/or potential future repair.

It is additionally recommended that consideration be given to the installer and the cable designer to attend the geophysical surveys to ensure that the conditions of data acquisition are known and there is an ability to react to input requests for further definition in a time-efficient fashion while the sampling vessel is in the field.

The experience in design of suitable cables is important since the cable design is complex and subject to incorporating experiences, lessons learned and there are many aspects of the cable design that depend upon the installation vessel configuration, the process of laying it, the depth it is possible to lay it at. Success is based on knowing details about the environment (soils, weather, and water characteristics) that the cables will be deployed in, and the experience of the installers, and the contractual arrangements with the cable supplier. It is recommended that the cables are procured from a cable design and manufacturing company with a long pedigree of successful cable design and manufacturing. It is additionally recommended that arrangements are made for an experienced jointer to be available for the installation period and that a contingency repair arrangement include spare cable, and a jointing plan (and factory pre-tested rigid joints, if appropriate) for the cables available in the case of a needed repair.

The planning recommended will include a geophysical and geotechnical campaign, possibly an initial one and a final one to establish the site-specific route and bottom conditions in detail to include:

- Route Selection
- Planning for Tools to Determine the Site Parameters
- Soil Testing
- Burial Assessment
- Burial Risk Assessment
- Navigation Risk Assessment
- Cable Design and Suitability
- Installation
- Cable Protection
- Obstructions
- Survey of potential landing points.

The campaign goal is to obtain a detailed understanding of the seabed characteristics, stability, and the location of any rocks or sand waves; information on historical cable and pipeline installations in

the locality; the location of disused cables, pipelines, munitions, wrecks etc. some of which may be gleaned from local sources including fishermen.

It is recommended that at the time of the cable design the following information resulting from the geotechnical data is available to the cable designer and other stakeholders:

- the soil resistivity,
- heat absorption capability,
- seawater salinity,
- the potential for small animals to burrow into the cable,
- potential exposure of the cable to becoming unburied, and
- any other site-specific factors including metocean data, temperature variations and protection requirements.

The design of portions of the cables are influenced by the following factors which are recommended to be determined and evaluated prior to the design of the cables:

- The variety of environmental conditions along the cable route, including the transitions between water and land which in some cases may be rocky; some cases may be beach; some cases may be ports; in many cases there will be the potential of severe and breaking waves that impact the bottom and these are recommended to be included in the project description;
- The stresses on the power cable (and armoring) during installation or retrieval the dependencies being: (stress = a function (weight of the cable x the water depth) x dynamics of vessel laying the cable + the residual bottom tension (since the horizontal force pulls against the already laid cable) + catenary forces from the cable shape during lay). Forces increase particularly when laying in marginal weather conditions in order to accomplish the work in a timely manner; and particularly when laying with a small vessel, with higher motion characteristics, in order to have minimum draft or minimum anticipated cost. Calculations should support these design variables;
- It is recommended that the design plan include consideration of the stresses affected by possible cable repair activities when it is necessary to haul up a water depth length of both cable ends, while providing for a stable platform to make the repair joint. These stress calculations should take into account the weather limitations set for repair activities for all seasons particularly in areas where waves can seasonally pound the shores.

Regional information should be gathered which are input to determine cable life:

- the potential for electrical surges in the cable (e.g. from lightning and other sources) ,
- the evaluation of likely fluctuations from production of the electricity,
- the predicted temperature ranges that the cable will be subjected to at its burial depth and during seasonal fluctuations since the increase in temperature by 10⁰C from the assumed steady-state temperature may change the life of the cable by a factor of 2 [Ref. 3.36].

Another requirement of the cable designer is to know early on the requirements of the communications and monitoring systems to be used with the wind farms if the fiber cables need to be laid as part of the power cable bundle.

Prior to design of the J-tubes which lead the cable up to the turbine it is recommended that J-tube designer is made aware of the cable designer's limitations on the cable dimensions and minimum bending radius since there can be numerous problems at the "pull-in" and significant damages and time lost if the process has not been well thought out. The fill % for constrained areas such as the J-tube should additionally be formulated and built into the design or heat problems may arise.

It is recommended to include at the time of planning, at a minimum, several of the mechanical tests are described in CIGRE, 1997: Recommendations for mechanical tests on submarine cables Electra, Vol. 171, No. 3. [Ref. 1.4] and values should be calculated as given by Worzyk [Ref. 3.36].

Quality control for a cable planned to last for 20-40 years without fault, without ingress of water is critical. The reliability of a submarine cable system will be directly affected by the quality of the submarine cable design and manufacture. The design life of the cable in Europe is assured through a qualification and type approval testing process. Manufacturing quality is assured through a factory acceptance test process and commissioning tests on site. It is recommended that the cable design and manufacturing be assured by a qualification to ISO 9000.

It is recommended as concluded by the Marine Board [Ref. 1.1] that the submarine cable design, fabrication and installation be subjected to review of a Certified Verification Agent qualified as a Professional Engineer in the appropriate discipline.

The importance of good planning is reinforced by noting that a survey by insurance broker Marsh Ltd. found that:

"44% of respondents identified a lack of sound operating and maintenance procedures and practices and lack of previous experience of project participants, contractors, sub contractors etc as a major concern for a small number of technologies. Again this is likely to be more applicable to those technologies which are based offshore (wind, wave, tidal) and require specialist marine equipment/ vessels and contractors during construction, operating and maintenance periods. Specific mention was made of the concerns over cable installation and maintenance associated with marine renewables" [Ref. 1.2].

An example of one of the early offshore submarine cable installations the UK wind farm Blyth [Ref. 1.3] experience is summarized in Appendix E and may provide context to some of the remarks in this Report.

1.2 Cable Selection on Wind Farm Submarine Cables to Date

Cable information on existing and developing wind farms is presented in Table 1.2. Information includes, where available the selected cable including type, length, weights, and comments on installation/ burial. The information comes from a variety of sources and some of the sources provide conflicting information and so should be used with caution and not for purposes other than to provide a general overview of the subject.

Table 1.2 presents a list of offshore wind farms to date together with available details of submarine power cables /characteristics. With conflicting reports from different sources about the material contained therein – the data is presented to be used as a general notion of the parameters included and for accurate information the developers should be contacted directly.

Table 1.2 Information on Offshore Wind Farms

Name	Region	Distance to Shore	Infield Length	Type	Size	Burial Depth	Export Length	Type	Size	Capacity (MW)	Field MW	Depth buried	Commissioned	Water Depth	Comments	Burial
Arklow	Ireland	7-12 km	7 km	35kV	125 mm		16.5 km	35kV	125 mm	25	7 x 3.6 MW (GE Wind Energy 3.6)		2003	2-5m	It is understood that surveys undertaken post installation indicated localized exposures of cables. This was possibly caused by scouring of the superficial sediments adjacent to the bank. It is also understood that the export cable suffered a fault resulting from an anchor contact with a repair being completed within one week. Further cable protection methods are under consideration.	A subsea cable plough was used to bury the export cables.
Baltic 1 (EnBW)	Denmark	7 km								48.3	21 x Siemens 2.3 - 93		2010	16-19m		
Bard 1	Germany													40 m		
Barrow	UK	7.7 km	25 km	Prysmian Conductor 3@120 mm ² + 3 @ 300 mm ² 33kV XLPE	76/109 mm		1@27 km	132kV	3 conductor XLPE300mm ²	90	30 x Vestas V90-3MW	2m	2006	21-23m	Infield laying .15km/day; Export .2km/day A subsea cable plough was used to bury both the export cables. During the installation of one of the cables an operational incident occurred in which the plough overran and damaged the cable which resulted in the need for an offshore joint.	CS Sovereign with Atlas ROV for remedial infield cable burial. ROV measured cable spans at monopile bases.
Beatrice	UK	23 km	900m +1900m	33kV	100mm		25km	33kV	100 mm	10	2 x 5MW		2007	40m	Vessel Sovereign -	.
Bligh Bank (Belwind)	Belgium		50 km in total	33kV			52km	170kV		165	55 x Vestas V90-3MW		2010			
Bluewater Wind Delaware	USA, Delaware			35kV			63.4081km	138kV	20-inch diameter HDPE conduit for 230kV cable which is 9.3 inches (237mm)	(230-450 Planned)	"(100 x 3 MW turbines)" - Vestas	6 feet (1.8288m)	2008			
Blyth	UK	11 km	0.5 km	Prysmian XLPE Double armor 11 kV with 16 fiber optic pkg. 70 mm ²			1 km			4	2 x 2 MW V66 Vestas		2000	6m with tidal range of 5m and 8m wave height	Global Marine mobilized a local barge to install the 11 kV power cables to shore.	
Borkum West Phase I, (Alpha Ventus)	Germany	43 km	16 km	14 @ 33kV	125 mm 28 kg/m NSW Cable	60 cm	2 x 128 km	150kV DC	HVDC Light (ABB) 98mm Bi-Polar	Phase I (200)	40x Areva Multibrid M5000 (5MW)	1.5 m minimum 2.0 m tideways 3.0 m traffic routes 3.0 Hitide to 12 mi	2010	2-30m ; waves at 6-8m w/max at 10m	45 km north of island Borkum	BSH requirement 0.6 m Most approximately 1m
(Trianel Windpark) Borkum West Phase II,	Germany			36kV		80 cm	2 x 128 km	150kV DC	HVDC Light (ABB) 98mm Bi-Polar	Phase II (200); 400 Total (I&II)	40x Areva Multibrid M5000 (5MW)	1.5 m normal 3.0 m specific e.g.reefs	2013	2-30m ; waves at 6-8m w/max at 10m	AC power from the 80 wind turbines runs to an AC platform from which a 170 kV XLPE (cross-linked polyethylene) submarine cable delivers the power 1 km to an offshore HVDC Light® converter station platform. There the power is converted to DC and transmitted in two parallel 1200 mm ² HVDC Light® submarine cables to the island of Norderney, where they are joined to two 1600 mm ² HVDC Light® submarine cables. Those cables run to a transition point onshore where they are connected to two 2300 mm ² HVDC Light® underground cables, which transmit the power a distance of 75 km to the HVDC Light® converter station at the Diele substation. At Diele the power is converted to AC and fed into the transpower 380kV transmission grid.	

Table 1.2 Information on Offshore Wind Farms

Name	Region	Distance to Shore	Infield Length	Type	Size	Burial Depth	Export Length	Type	Size	Capacity (MW)	Field MW	Depth buried	Commissioned	Water Depth	Comments	Burial
Butendiek		34 km	34 km	33kV				155 kV			80 x 3.6MW		2012	16-20m		
Burbo Banks	UK	5.2 km 7-12 km	40km; also reported as 21 km	36kV			3@19km	ABB's 36kV XLPE	155 kV	90	25 x Siemens 3.6-107		2007	7-12m		
Cape Wind	USA, Mass.		67 mi of 5.2"-6.5"				12.6 mi (7.6 in Mass.)	115KV 2 x AC +2 fiber optic	7.75" diameter	468	130 x 3.6MW	6 ft	2015		2 trenches 20 ft apart	jet plow plus cable barge winched along
Donghai Bridge, Shanghai	China							40.5 kV ABB		102	34 x 3 MW Sinovel SL 3000/90		2010			
Egmond aan Zee	Netherlands	8-12 km		3@34kV		2-3 m	3@10-18km	150 kV		108	36 x Vestas V90-3MW		2006	15-20m		
Greater Gabbard	UK	36 km	140 cables 1-3 km length =200 km	36kV	35 kg/m	1 m	3 export cables 50 km each + 1 export @ 20 km.	Prysmian 132 KV XLPE	175 km 18"-24" 61-77 kg/m		140 x 3. MW =504 MW	1-1.5 m		2.4-10 m up to 32m		
Gasslingegrund	Sweden	4 km								30	10 x 3 MW		2009	4-10m		
Gunfleet Sands	United Kingdom	7 km					24 km	3 @ 132 KV/145 KV	3 @ 800mm ² + fiber optic (48 fibers) Prysmian	172	48 x Siemens 3.6-107		2010	2-15m 2-24m	Installed by EIDE 28 with plough and 4600 ton turntable; Directional drilling @ shore 400m @630mm diam. Crossing deep sand dunes.	2 m by using Sea Stallion IV plough
Helwind 1	Germany								560 KV				2013			
Horns Rev	Denmark	14 km	57 km 160 cable connections	34kV Nexan 3 core	100/130	1-2m	1@21 km@71 kg/m	170kV	192mm XLPE Nexans 3 conductor 630mm ² 71 kg/m	160	80 x Vestas V80-2MW	1-1.5m (Surf area 3 m)	2002	6-14km	Infield laying .6 km/day 90 days to lay It is understood that the installation contractor encountered difficulties whilst installing and burying the inter-array cables. It is thought that the wave climate proved problematic during the installation operations and it is believed that divers were subsequently employed to bury the cables which were left exposed, particularly close to the offshore structures.	
Horns Rev 2	Denmark	30 km	70 km	34 kV XLPE Nexans	Min bend 1.5m ; 104 mm diam 15 kg/m		1@42 km	(HV)	300mm	209	91 x Siemens 2.3-93		2009	9-18 m or 12-28m	175 mattresses needed to be installed using Oil Express for protection of the J-Tube extensions. Currents at location were high. Small Micro ROV (VideoRay) monitored the J-Tube as the cable was pulled into the towers.	Post burial by means of trench ROV
Hywind	Norway	12 km	N/A	N/A	N/A	N/A	13.6km	24kV XLPE-insulated (Nexans) + Integrated Fiber Optic Cable (Rognan)			1 x Siemens 2.3-82		2009	220m		
Jiangsu Rudong Wind Farm	China									32	2 x 3 MW, 2 x 2.5 MW, 6 x 2 MW, 6 x 1.5 MW		2010			
Kemi Ajos I + II	Finland						11km	110kV		30	10 x WinWinD 3MW		Phase 1 connected in 2007, Complete 2009	3-8m		
Kentish Flats near Herne Bay	UK	8.5 km	21km	33	3 rows of 10; 3-core 500 mm ² ;129mm OD; 32.2 kg/m 24 fibre package		3@10 km	3 x 33k V@ 30 kg/m	129mm	90	30 Turbines x 3 Mw	1.5m		5 m	Infield laying .35 km/day; Export 1.0 km/day Inner array 60 days; Export cable 30 days to lay. Difficulties in burial operation were encountered where the cable installation had crossed spud depressions from the main installation vessel – Mayflower Resolution. Inter-array were surface laid and then buried by the 'Otter'.	The export cables were buried using the Global Marine owned Hi-Plough. The inter-array cables were buried using the Global Marine Otter tracked vehicle in jetting mode. Cable barge at low tide was grounded.

Table 1.2 Information on Offshore Wind Farms

Name	Region	Distance to Shore	Infield Length	Type	Size	Burial Depth	Export Length	Type	Size	Capacity (MW)	Field MW	Depth buried	Commissioned	Water Depth	Comments	Burial	
Lely	Netherlands	.75 km					750 m HVAC			2	4 x 500 kW, NEG Micon		1995	7.5 m			
Lillgrund	Sweden	10 km	27 km	36kV			1@7 km	145kV ABB	400 mm ² 48 fibers 166 mm diam 56 kg/m	110	48 x Siemens 2.3	1 m	2007	2.5-9 m	Infield laying .25 km/day; Export 1.4 km/day	Export by Nautilus Maxi laying Vessel Gravingen Dredger excavated trench	
Lincs			64.8 km total 3core cable w/ fiber optics line				20.5km 3core cable w/ fiber optics	TKRAQ 145 kV 3@630mm ² /1000m m ² ; Two lengths @49 km = 98 km total		270	75 x 3.6MW Siemens AG		2012				
London Array	United Kingdom	20 km	650m-1200m; 209km total (Phase 1)	Non-coilable		1 m	4 cables @ 55km avg. length; 220km total; 219/210 mm diam non- coilable	TKRA 170 kV	3 x 1 x 630mm ² ; switch to 800 mm ² each 3 km from end; Main length 46-48 km	Phase 1 630MW; 1GW (1000MW) Total planned	175 x SWT-3.6-120	1-3m	2012	2-23m	JDR Cable Horizontal drilling 4 @ 125m x 560mm; 4 existing cable crossings; 3 x Kentish flats; 1 by BritNed.	Stemat 82' and 'Stemat Spirit' for infield cable installation (barge and plow) Horizontal Directional Drilling Conduit 1 m depth at landfall	
Lynn and Inner Dowsing	United Kingdom	5 km	43 km	36 kV	43 km inter- array Varied: 3 x 185-240- 630-1000mm ²		6 @7 km	36kV XLPE + fiber optic		194.4	54 x Siemens SWT- 3.6-107	2 m at shore	2008	6-13m			
Middelgrunden	Denmark	2-6 km	14km	30 kV			2 of 3.5 km	XLPE		40	20 x Bonus (Siemens) 2MW		2001	2-6m	Infield laying .5 km/day; 30 days to lay		
NordE.on							2 x 125km+2 x 75km	150kV HVDC Light		400							
North Hoyle	United Kingdom	3-10 km	15km				2@12 km			60	30 x Vestas V80- 2MW	Export cable 1.5 m; Foreshore burial 2 m	2003	5-12 m	Infield laying.15 km/day; 105 days to lay; Export .5km/day 49 days to lay One of cables was installed from the shore to the wind farm and the other cable installed from the wind farm on the shore. Pre-installation of concrete mattress across two 3" BHP pipelines. Diver intervention required to bury the sections of cable from the edge of the mattresses to the termination points of ploughing operations. Divers were used to bury the last 50m of cable close to the 2nd turbine Problems 4 kt currents impact on air diving; harder than expected soil; J-tube design lacked operational input	Export Cables: A Sea Stallion subsea cable plough with a 2m burial depth capability was employed to achieve a target burial depth of 1.5m. Infield: The LBT1 trencher was used which simultaneously laid and buried the interarray sections of cable to a target burial depth of 1m	
Nysted (Rødsand I)	Denmark	6-10 km	55 km	36 kV			6-9 km to land: 1@ 11 km	132KV Pirelli		165.6	72 x SWT-2.3-82 (Siemens)		2004	6-9.5m	It is understood that the cable installation and burial were successfully completed. However, the burial operations took a considerable period of time owing to poor weather.	A variety of installation techniques were employed. Jetting was used in areas of looser substrates which included sands, silts and clays with shear stress less than 75kPa. Pre-trenching and backfilling was used to cut through areas of harder substrate with back-hoe excavators working from a shallow water jack up	
Ormonde	Irish Sea	10 km	25km	33 kV	3@ 500mm ² ; 3@ 300 mm ² ; 1@150mm ²		2@25km	2.4 km TKRA 420 kV 1 x 1200mm ² ; another report: 132kV Prysmian 630mm ²	non-coilable		108 MW		2010	0-21m	Installation vessel Ponta Maris - Infield NKT Cable	2 cable crossings; 1 pipeline crossing; Sea Stallion 1m to 2.0 m depth on Export; Post lay burial with ROV infield	

Table 1.2 Information on Offshore Wind Farms

Name	Region	Distance to Shore	Infield Length	Type	Size	Burial Depth	Export Length	Type	Size	Capacity (MW)	Field MW	Depth buried	Commissioned	Water Depth	Comments	Burial
OWEZ	Netherlands		27km				3@15 km	10-18 km 3 cables			36 Turbines for 108 MW		2006		Infield .3 km/day; Export 1.1 km/day	
Prinses Amalia (aka Q7)	Netherlands	23 km	45km each one 400m-600m long with lengths to 800m	22kV 3phase			1@28km	150kV 3phase w/fiber optic	28km	120	60 x Vestas V80-2.0 MW		2008	20-24m	Infield laying .3 km/day; Export .9 km/day Inner array cable 150 days; Export Cable 30 days	
Riffgat											30 Repower 1.5 MW					
Rhyl Flats	United Kingdom	15 km	1km	24 interarray cables @ 18km total			3@11km			90	25 x Siemens SWT-3.6-107	6.5-12m	2009	4-15m	Infield laying .2 km/day; Export .6km/day	
Robin Rigg (Solway Firth)	United Kingdom	15 km	44 km	16 Interarray			2@13 km			180	60 x Vestas V90-3MW		2010	5 m	Infield laying .2 km/day; Export .4km/day	
Ronland	Denmark	0-1 km								9.2	4 x Siemens SWT-2.3 MW-93			2 m		
Rødsand II	Denmark	25 km	75km	\			11km	132kV		207	90 x Siemens SWT-2.3 MW-93		2010	5.5-12m	13 km south of danish Island Lolland	
Samsö,	Denmark	3.5 km	7.5 km	36kV			7.5km	36kV		23	10 x SWT-2.3-82 (Siemens 2.3MW)		2003	12-18m		
Scroby Sands	United Kingdom	2.5 km	29 x 600-650 m 33 kV cable 18.3 km and 430 tonnes	33 kV	240 mm ²	3 m	3 @ 4km	3 cables @33 kV	300 mm ² double armour	60	30 x Vestas V80-2MW	3 m	2004	3-12m	Infield laying .3 km/day; 60 days total Export .3 km/day 60 days total The second export cable had to be cut during the installation due to adverse weather, an offshore joint was subsequently introduced and the repair splice buried with post lay burial techniques. Inter-array cables have become exposed as a consequence of scour around base of the offshore structures. It is also believed that remedial rock dumping has been undertaken but the results of this subsequent intervention are unknown. Problems 6 kt currents impact on air diving and cable lay; Harder than expected soil. CPTs every 1 km does not reduce risk wrt burial. Continuous burial assessment survey with BAS Tool better. J-tube design: no more ihinged J-tubes. Use "I" tubes with slight bell mouth at bottom and install "I" seal and bend restrictor to the cable during the diver-less pull-in operations to secure cable to J-tube at bottom. Proper pad eye design and location on the turbine for cable pull-in operations.	Export and Import cable burial was undertaken using a Sea Stallion plough which had been modified to achieve a target depth of burial of 3m. partly to do with mobile sands.
Sheringham Shoal	UK	17-22 km	81km	36kV			21.6 km	2 x 145kV XLPE (Nexan) 2@21 km 3 x 1 x 630mm ² ; 2 x .2 km 3 x 1 x 1000 mm ²		316.8	88 x SWT-3.6-107 (Siemens 3.6MW)	1.6m-deep; 2.2m-wide	2011	14-22m		open cut trenching
Sprogo		2 km								21	7@3 mw		2009	6-16 m		
Sylwind 1	Germany								320 KV						Supplied by Prysmian	
Thanet	UK	11.3 km	75 km	100 Interarray EPR with conductor 3@95/300/400			11 km from coast but needs 2@26.5 km cables	Prysmian XLPE 2 x 133kV	132mm	300	100 x Vestas V90-3MW	2.5 m	2010			

Table 1.2 Information on Offshore Wind Farms

Name	Region	Distance to Shore	Infield Length	Type	Size	Burial Depth	Export Length	Type	Size	Capacity (MW)	Field MW	Depth buried	Commissioned	Water Depth	Comments	Burial
Thornton Bank	Belgium	27-30 km	4km	36kV			2@38km	170kV	TKRA 170KV 3 conductor x 500m ² -600mm ²		150MW phase 1; finally 78 @325 MW-3.6mw; also reported 6 x 5 mw Repower		2008	12-27 m	Infield laying cable .3 km/day; Export 1.0 km/day	
Troll A Offshore Platform	Norway		N/A	N/A	N/A		280 km	60 kV D.C.	2 x HVDC							
Tuno Knob	Kattegat Sea	6 km								5	10 x 500 kW+L2 Vestas		1995	0.8-4m		
Utgrunden,	Sweden	7 km	11 km Aluminum conductor	24kV			11km	24kV	Conductor 3 @ 240mm ² XLPE Prysmian	10 MW	10 @ 1.4 MW		2001	4-10 m		
Vänern (Gässlingegrund)	Sweden									30	10 x WinWinD WWD-3-100		2010			
Vindeby	Denmark	2.5 km						Bi-Polar HVDC	11 x 450	4.95	11 @ ?Seimans		1991	2-5m		
Walney	UK, Cumbria	14 km		45 km XLPE 132 kV	Prysmian Conductor 3@800mm ²		15 km			367.2	51 x SWT-3.6-107 (Siemens 3.6MW) + 51 x SWT-3.6-120 (Siemens 3.6MW)		2011	19-24m	On shore landing and export cable installation with Stetmat Spirit and Sea Stallion 4 plough; 2 cable crossings; 3 pipeline crossings; 2 m burial requirement.	Infield installed with Stetmat 82, 1200 ton carousel; Post lay burial by jetting
Yttre Stengrund	Sweden	4 km	22 km AC	24kV			22km	132kV	630 mm ²	10	5@2 MW NEG Micon		2002	8-12 m		

1.3 References

- 1.1 Structural Integrity of Offshore Wind Farms, Special Report 305, Oversight on Design, Fabrication and Installation, Committee on Offshore Wind Energy Turbine Structural and Operating Safety, Transportation Research Board of the National Academies, 2011.
- 1.2 Survey of Insurance Availability for Renewable Energy Project, United Nations Environment Programme, Marsh Energy and Marine, March 2006.
- 1.3 Annual Report Blyth Harbour Wind Farm – Operational Aspects, Report of DTI, 2004
www.berr.gov.uk/files/file_18014.pdf
- 1.4 www.CIGRE.org
- 1.5 Offshore Cable Installation, Engineering & Maintenance: Two-Day Windpower Monthly Forum Plus Workshop Announcement 28 - 30 September 2011, London, UK
<http://www.windpowermonthlyevents.com/events/offshore-cable-installation-and-maintenance/>

2. REGULATIONS AND REGULATORY ISSUES

2.1 Regulatory Requirements of 30 CFR 285 on Subsea Power Cables

Within § 30 CFR 285 the gathering, transmission and distribution cables are considered part of the Facility and thus detailed engineering information needs to be submitted as part of the Facility Design Report. The BOEMRE Right-of-Way grant authorizes the installation of the cable (§285.300(a)) including the full length of the corridor on which a cable is located and a 200 feet (61 meters) width, centered on the cable, although deviations can be acceptable if necessary (§ 285.301) as this is quite a tight restriction.

For the submarine cables the COP information must include information on: location, design and installation methods, testing, maintenance, repair, safety devices, exterior corrosion protection, inspections, and decommissioning; and a description of the deployment activities as well as safety, and environmental protection features or measures that the owner will use.

Information on burial methods and vessels are required (§ 285.701). For example, it is anticipated that a typical 6 foot burial depth will be required as stipulated on the approval of the Cape Wind project.

There is also a requirement to provide a list of solid and liquid wastes generated in installation including disposal methods and locations (§ 285.626). A permit may be required for soil generated from trenching operations in some cases, and for dredging operations if necessary.

The lessee is required to make repairs as soon as practical in the event of a cable failure and submit a report to BOEMRE as required by (§ 285.711).

Within 2 years of termination of the lease there is a requirement to remove all cables and obstructions (§ 285.902) and to provide plans for transportation and disposal (including as an artificial reef) or salvage of the removed cables.

Guidance is offered by the BOEMRE on Geological and Geophysical Hazards and Archeological Information [Ref. 2.1] as well as Information Requirements for the Construction and Operations Plan [Ref. 2.2] at <http://www.boemre.gov/offshore/renewableenergy/RegulatoryInformation.htm>

2.2 Cables and Mariners/ Fishermen

Over the past decade there has been a huge increase in the number of submarine cables being installed (mainly for telecommunications). Fishing gear can cause severe damage to submarine cables - resulting not only in expensive repairs but also disrupted supply and lost revenue. Less common are damages to the more robust submarine electrical cables which are typically buried.

In the UK prior to the creation of the Kingfisher Information Service - Cable Awareness (KISCA) project, only limited success had been achieved by some cable owners/operators co-operating to improve general awareness of their activities. Therefore, to protect their individual interests, many companies published (and will continue to publish) flyers, and other ad-hoc material notifying the communities about their activities. Information notices were published on the Kingfisher Fortnightly Bulletin to alert fishermen of the routes of their cables.

Against this background, and in an effort to improve general co-operation between North West European cable owners / operators and fishermen, the UK Cable Protection Committee (UKCPC) was formed to supplement the global work of the International Cable Protection Committee (ICPC).

These Committees involve the communities acting together to protect the mariners, fishermen and cable owners.

It is recommended that a government entity be identified to encourage the formation of a similar Committee in the USA in regions where offshore wind farms are established.

In the UK, although it is not compulsory to erect cable beacons on shore for notification to mariners and fishermen of their presence, there are still situations where they can offer protection to the submerged cable:

- Protection from Anchoring at river or estuary crossings when both shores can be seen by vessels and the cable line can be identified;
- At locations where there is an established anchorage within site of the landing or where vessels may anchor on occasions to seek shelter;
- When the cable is surface laid or only partially buried due to seabed conditions. Where local invasive fishing techniques are employed, i.e. scallop fishing or clam dredging;

While on the one hand, in the era of electronic charts, GPS and other techniques are available to give warnings, the Cable Beacon can offer a visual reminder of the presence of a submarine cable.

It is recommended that BOEMRE consider including cable warnings/beacons at the shore landing when appropriate with high visibility.

2.3 Legal Restrictions to Cable Vessel Operations and the Jones Act

[Ref. 2.3]

The Jones Act (the Merchant Marine Act (MMA) of 1920) requires that all commerce between two U.S. ports (“coastwise points”) be carried on a U.S. flagged, crewed and owned vessel. The definition of a port includes any area on the OCS. The Jones Act is enforced by the Customs and Border Protection (CBP).

Marine cabotage laws often colloquially known as the Jones Act, though more documents are encompassed than just the MMA of 1920, apply to the US territorial or navigable waters, generally 3 nautical miles from the coast (except Texas and Florida which were provided for 3 leagues when each became a state).

From the research carried out it appears:

- Cable laying vessels are likely to be able to be foreign flag;
- Vessels transporting maintenance workers as passengers from shore to the wind farm will have to be “Jones Act” vessels;
- Rock transporting and dumping vessels and may be also subject to having to be “Jones Act” vessels since the rock may be considered “cargo”;

- That it is not very clear as to how the experienced foreign citizens working in and around the offshore wind farm will be viewed, particularly if they are considered part of a vessel's senior crew e.g. cable jointer.

A more detailed discussion of these points can be found in MAINE Deepwater Offshore Wind Report, Funded by DOE, February 23, 2011 [Ref. 2.4].

The activity of laying a submarine cable does not exclude foreign cable-laying ships. CBP has determined that a "vessel used solely for pipe laying purposes and not for the purpose of exploring for, developing, or producing resources from the OCS is not considered "attached " to the seabed as that term is used in OCSLA and therefore is not a coastwise point" [Ref. 2.5].

2.4 USCG and Customs & Border Protection

The USCG and CBP (formerly United States Customs Bureau), are now both divisions of the Department of Homeland Security and have a pivotal role in the application of maritime cabotage laws.

The responsibilities of USCG are laid out in the Memorandum of Agreement between the BOEMRE and US Coast Guard [Ref. 2.9]. Additionally USCG offers guidance on its Roles and Responsibilities for Offshore Renewable Energy Installations in NVIC 02-07 [Ref. 2.10] including useful information on conducting a Navigation Risk Assessment and providing other USCG references for risk evaluations.

CBP is tasked with providing interpretations as to when vessels are engaged in coastwise transport and are subject to the provisions of the Jones Act. CBP has traditionally given a liberal interpretation to "vessel equipment", which is not subject to the provisions of the Jones Act. The CBP has allowed foreign vessels to carry merchandise (often pipelines, jumpers, risers, umbilicals, decks, generators, jackets, boat landings etc.) from a U.S. land location to a location on the OCS as long as the same vessel installed the merchandise. CBP has previously stated that installing a pipeline is not coastwise trade because the pipe is laid out in a continual process as the operation proceeds because no single coastwise point is involved in laying the pipeline, so it is expected that the same will hold true of a cable.

In these cases, the CBP has ruled that the material being carried is not merchandise but vessel equipment as it is required for the vessel to perform its intended "mission". One particular point for the wind farms transfers from an oil and gas interpretation where each well in a field is considered a separate "coastwise point" thus preventing transportation between coastwise points. For each wind turbine the interpretation may be a "coastwise point".

In July 2009, CBP issued a decision which would restrict the definition of vessel equipment to "portable articles necessary and appropriate for the navigation, operation or maintenance of the vessel and for the comfort and safety of the persons on board." As a result this effectively revoked the previous policy of allowing foreign pipelaying vessels to operate laying pipelines in the US. This decision was revoked in October 2009 and the replacement ruling has yet to materialize.

For the equipment that buries cables and the emulsification of the seabed surrounding the cable by ROV or other devices CBP has held that such an operation does not constitute an engagement for "dredging" for purposes of the 46 U.S.C. 55109 (CBP HQ H012082 Aug 27, 2007). Cable removal,

scour protection removal, and site clearance and verification has been described by an MMS Report, and is not discussed further here [Ref 2.7].

2.5 United States Army Corps of Engineers (USACE) Viewpoint

U.S. Corps of Engineers has been involved in many submerged cable installations. Their authority implementing regulations comes Title 33, Code of Federal Regulations (CFR), Parts 320-330, and pursuant to Section 10 of Rivers and Harbors Act of 1899 (33 U.S.C. 403), and Section 404 of the Clean Water Act 33 U.S.C 1344).

Under Section 404 of the Clean Water Act, the Corps of Engineers has jurisdiction to regulate the discharge of dredged or fill material in waters of the United States. The seaward limit of waters of the United States for purposes of Section 404 is the territorial seas, which extend three nautical miles from the baseline defining the territorial sea (33 CFR § 328.4(a)). The baseline is generally the line on the shore reached by the ordinary low tides (33 CFR § 329.12(a)(1)). Section 404 regulation deals with the discharge of dredged and fill material associated with trenching, particularly when that dredged and fill material is removed from its original location. Not all trenching for submarine cables requires a Section 404 permit e.g. generally the Corps does not consider jet plowing to be subject to 404 permitting as it does not represent a discharge of dredged or fill material. The jet plow blade is lowered to the seabed, water pump systems are initiated, and a trench is created from the pressurized water jets. As the jet plow progresses, the cable is simultaneously laid and so buried in the trench as the jetted material settles back into the trench behind the jet plow. Because the vast majority of jetted material falls back into the trench at the same time and same location where it had just been excavated, the Corps does not consider this to be a discharge of dredged or fill material.

Under Section 10 of the Rivers and Harbors Act of 1899, the Corps of Engineers has jurisdiction to regulate structures and work in and affecting navigable waters of the United States 33 U.S.C. § 403; 33 CFR § Part 322.

As an example of burial requirements of submarine power cables, the following is a brief sample:

Company	Location	Burial Details
Bayonne Energy	Upper New York Harbor & Gowanus Bay	15 feet below bottom
Upstate NY Power	Galoo Island, Lake Ontario	6 feet
Cape Wind	Nantucket	6 feet
HDR- One Company	Champlain Hudson Power Express Project	cable burial depths will vary by location, typically 4 feet below seabed and fifteen 15 feet when crossing or a federally maintained navigation channel.
Mid-Atlantic Power Pathway	Chesapeake Bay	6 feet
Long Island Power Authority	LIPA Connection	4 feet outside of navigation channels and up to 17 feet at channel crossings.

Company	Location	Burial Details
Champlain Hudson Power Express,	Lake Champlain via Hudson River	Each 345 kV 3-phase circuit buried as a bundle when the burial depth is 4 feet but must be buried separately where deep burial is required (15 feet or greater) due to thermal dissipation requirements.

Table 2.1 Sample of USACE Burial Depths for Various Submerged Power Cables
(not for Wind Generation)

The application for approval of the burial depth and separation distances is obtained from the nearest District Engineer of the U. S. Army Corps of Engineers, who will specify depth requirements and any other pertinent conditions, when the system is being extended across navigable waters within the United States.

An inferred guidance from the US Corps of Engineers on burial depths would be:

- in an anchorage area or marine park: 15 ft. below seabed;
- otherwise it may be as low as 3-6 ft.

In general there is no expected difference between AC and DC power cables and the above values may change as the site-specific circumstances are evaluated.

Those conditions frequently entail a specification of the time between periodic inspections. The frequency of inspection is largely determined by the importance of the equipment or facility it serves or contains. Inspections can vary in frequency from 6 months to 5 years, but a 2-year cycle of inspection is quite customary. Records are to be kept of each inspection [Ref. 2.8].

The US Corps of Engineers also has set out their requirements for testing of the cable at commissioning and other times and is a useful reference [Ref. 2.10].

2.6 References

- 2.1 Guidelines for Providing Geological and Geophysical Hazards and Archaeological Information Pursuant to 30 CFR Part 285.
- 2.2 Guidelines for Information Requirements for a Renewable Energy Construction and Operations Plan (COP), December 17, 2010.
- 2.3 TradeWinds Quotes Charlie Papavizas on Offshore Wind Development, Winston and Strawn LLP, Washington DC www.winston.com.
- 2.4 MAINE Deepwater Offshore Wind Report, Funded by DOE, February 23, 2011
- 2.5 CBP HQ H012082 (Aug. 27, 2007))

- 2.6 Constantine Papavizas & Gerald Morrissey, “Does the Jones Act Apply to Offshore Alternative Energy Projects?” 34 Tul. L. Rev. 34-35 (2010).
- 2.7 Kaiser, M.J. and B. Snyder 2011. Offshore Wind Energy Installation and Decommissioning Cost Estimation in the U.S. Outer Continental Shelf. U.S. Dept. of the Interior, Bureau of Ocean Energy Management, Regulation and Enforcement, Herndon, VA. TA&R study 648. 340 pp.
- 2.8 Melnyk M., Andersen R., Offshore Power, PennWell Publishing 2009,
- 2.9 Memorandum of Agreement between the Bureau of Ocean Energy Management, Regulation and Enforcement – U.S. Department of the Interior and the U.S. Coast Guard – U.S. Department of Homeland Security, OCS-06 dated 27 July 2011, “Offshore Renewable Energy installations on the Outer Continental Shelf”.
- 2.10 USCG Navigation and Vessel Inspection Circular 02-07 “Guidance on the Coast Guard’s Roles and Responsibilities for Offshore Renewable Energy Installations (OREI)”, February 2007.
- 2.11 Facilities Engineering Exterior Facilities – Chapter 5, Joint Departments of the Army, the Navy and the Air Force, TM 5-864/NAVFAC MO-200/AFJMAN 32-1082.

3.0 HISTORICAL INCIDENTS WITH CABLES

Studying the failures, near misses, and potential setbacks for an offshore wind farm related to the cables and installation gives insights into potential risks. It is believed that the information that follows represents only a very small portion of the incidents that have occurred.

Where experience could be attributed to a specific case or a specific location it is given, but often there are details missing. An anchor that pulls up a cable begs the question of why? Was the vessel in danger of hitting coastline rocks and threw out an emergency anchor? Did the anchor release in some accidental way? Did the chain break and fall? Was the submarine cable noted on the charts? Without this detail the lesson is not learned – only additional caution to exercise the normal protections.

Details of reports with references are presented in Appendix A.

Some of the issues that can be gleaned from the historical incidents are summarized:

- Faults can arise from design, construction and handling of the cable: in the distant past design and construction of the cables was as much an art as a science, but calculations methods now exist and advantage should be taken of the science by carrying out appropriate calculations for cable design;
- Missed features or inaccurate seabed characterization may be missed due to incomplete analysis of existing data or where an existing sensor was not operating correctly: even small areas of mischaracterized seabed can cause significant downtime to repair a damaged plow or cable;
- Marine operations should be conducted with caution, with experienced personnel, and appropriately sized equipment so to avoid incidents such as the installation vessel being blown off location, the cable being overrun by the plow, or by footings and footprints of jack-up platforms affecting the bottom conditions for the cable before or after installation;
- The J-tube should be carefully designed accounting for the characteristics of the cable including bending radius, sufficient space for heat absorption, ensuring that the inside path up the J-tube is free from snags, and that sufficient planning is done to assure the appropriate power in the winches, and the plan is appropriately documented;
- Cable tensions need to be monitored during installation e.g. when feeding the cable up a J-tube;
- Diver operations should be minimized where practical, particularly in high current situations;
- Even though the wind farm field has been adequately surveyed, installation activities may damage the cables, or subject the bottom to indentations which subsequently result in scour on the submarine cable;
- A repair plan should be in place including plans for a repair vessel suitable to the appropriate weather complete with spare length of cable, an experienced joiner, and appropriate electronic gear to locate the fault quickly.

Cable installation, and some inferred issues with cable design, has had a checkered history on offshore wind projects. Several things can be done to mitigate damages and prevent cable installation delays:

- Good cable route engineering, avoiding areas likely to have damage potential (ship fairways, military ordinance disposal zones etc. and provision of very good and detailed soils information);
- Selection of trained and competent installers, involved early in the project, with vessels and burial equipment well capable of carrying out the work without stretching the capacity;
- Ensuring robust interface management with the cable manufacturer so that the design accounts for good site information, and the particular installation vessel or is able to be adapted if the vessel information is not available;
- Ensuring that calculations are carried out appropriate to best practice instead of reliance solely on experience and what has been done before in other parts of the world;
- Independent surveyors present during laying to note and report appropriate resolution of issues along the route which may jeopardize the longevity of the cable.

There are lessons to be learned from the telecommunications industry on cable laying. Lessons learned from the past particularly relevant to shallow water installations, include recognition that the underlying rock interface may be shallower than expected from the burial surveys if interpretations are not done rigorously. The result in one case was that there was a requirement to pull up the cable and replace it with cable with a second layer of armoring since it was not possible to bury the cable at the anticipated depth Allan 2001 [Ref. 3.48].

3.1 References

- 3.1 Project Upwind Work Package 9: Electrical grid, Deliverable D 9.1, Survey of Reliability of Large Offshore Wind Farms Part 1: Reliability of State-of-the-Art Wind Farms.
- 3.2 Review of Cabling Techniques and Environmental Effects Applicable to the Offshore Wind Farm Industry – Technical Report, January 2008. Dept. of Business Enterprise and Regulatory Reform.
- 3.3 BERR Capital Grants Scheme Annual Report: Barrow Offshore Wind Farm 1st Annual Report July 2006-June 2007.
- 3.4 Barrow Offshore Wind Cable Route inspection & Scour Monitoring Survey Report June 2008 http://www.bowind.co.uk/pdf/post%20cmr%202009/Appendix_4_Scour_Monitoring_C7039.pdf.
- 3.5 Blyth Harbour Wind Farm - Operational Aspects - Amec Energy Ltd., Report of DTI, 2004.
- 3.6 Dave Black National Wind Watch Ref: www.wind-watch.org.
- 3.7 Monitoring and Evaluation of Blyth Offshore Wind Farm, Installation and Commissioning, L. Pepper, 2001.

- 3.8 Lange B., Aagaard E., et al, Offshore Wind Farm Bockstigen, Installation and Operation Experience, Wind World of 1997 Denmark.
- 3.9 <http://www.wirralglobe.co.uk/news/4687615>.
- 3.10 [http://www.bwea.com/pdf/realpower/realpower_12](http://www.bwea.com/pdf/realpower/realpower_12.pdf). pdf
- 3.11 IMCA Renewable Energy Position Paper <http://www.imca-int.com/documents/regions/europeafrica/minutes/renewableenergy/IMCA-RenewableEnergyPosition.pdf>
- 3.12 Case Study: European Offshore Wind Farms — A Survey for the Analysis of the Experiences and Lessons Learnt by Developers of Offshore Wind Farms — Final Report, Deutsche WindGuard GmbH, Deutsche Energie-Agentur GmbH (Dena), University of Groningen.
- 3.13 The Copenhagen Post www.chpost.dk 20 November 2009.
- 3.14 Mason V.C., Wind power in West Denmark. Lessons for UK, October 2005.
- 3.15 Andersen, P., 2004a: “Forskere endevender søsyge transformere”. [Researchers scrutinise seasick transformers]. Eltra magasinet, 2, February.
- 3.16 Møller, T., 2005: “Erstatningskrav på 17 mill. Kr. for transformer-havarier”. [Compensation claim of DKK 17 million for transformer damages]. Naturlig Energi, March 2005.
- 3.17 Recharge June 4, 2010.
- 3.18 Realities of Offshore Wind Technologies, Middelgrunden, Orkney, October 2002.
- 3.19 Offshore Wind Energy Ready to Power a Sustainable Europe Final Report Concerted Action on Offshore Wind Energy in Europe Supported by the European Commission December 2001.
- 3.20 <http://www.4coffshore.com/windfarms/kobenhavn-denmark-dk08.html>
- 3.21 <http://www.whitehavennews.co.uk/1.340117>.
- 3.22 <http://www.offshore247.com/news/art.aspx?Id=12808> and www.timesandstar.co.uk/1.506927
- 3.23 http://news.bbc.co.uk/2/hi/uk_news/scotland/south_of_scotland/6998281.stm
- 3.24 Scroby Sands Offshore Wind Farm 3rd Annual Report 2007, Offshore Wind Capital Grants Scheme, Dept. of Business Enterprise & Regulatory Reform, UK.
- 3.25 BBC News 21 January 2008.
- 3.26 Scroby Sands Offshore Wind Farm – Coastal Processes Monitoring Cefas, UK 2006 <http://cefafas.co.uk/media/21503/ae0262-final-report-scroby-owf.pdf>.
- 3.27 Centre for Environment, Fisheries & Aquaculture Science, <http://cefafas.defra.gov.uk/> CEFAS, 2006.
- 3.28 SED02 Seabed and Coastal Processes Research Dynamics of scour pits and scour protection: Review of datasets on scour and scour protection (Milestone 1 report), Technical Note DDS0442/01 Department of Trade and Industry www.berr.gov.uk/files/file50448.pdf

- 3.29 Technical Report by Van Oordz ACZ Cable Installation Study, DOWEC research project. November 2001.
- 3.30 Reported in Skegness Magazine on 14 February 2009 <http://www.windwatch.org/news/2009/02/15/skegness>.
- 3.31 <http://www.gazettelive.co.uk/news/teesside-news/2008/08/09/offshore-windfarm-proposals-move-on-84229-21497998/> .
- 3.32 <http://www.jdcon.dk/HTML/News/Festures/Utgrenden0-6.htm>
- 3.33 <http://www.carbon-innovation.com/cleantech/Osiris.pdf>
- 3.34 Svoma R et al., Subsea Connections to High-Capacity Offshore Windfarms, 19th International Conference on Electrical Distribution, CIRED, May 2007.
- 3.35 2010 Offshore Development Information Statement Appendices, National Grid UK http://www.nationalgrid.com/NR/rdonlyres/CC4994A2-83C5-4990-9E0C-F8CE04DCA588/43378/Appendices2010_Final.pdf
- 3.36 Worzyk T., Submarine Power Cables, Springer 2009.
- 3.37 www.iscpc.org/publications/ICPC-UNEP_Report.pdf
- 3.38 Hydro International – October 2006, Volume 10 No 8 Offshore wind farm cable survey
- 3.39 Ocean Surveys 2005.
- 3.40 R. Rapp, C. Carobene, F. Cuccio, Burial Assessment and Successful Cable Burial: Old Topics, New Lessons, Tyco Electronics Subsea Communications, Suboptic 2007.
- 3.41 Sarah Wootton, Robin Comrie, Setech Ltd., A Risk Based Approach to Cable Installation for Offshore Wind Farms, Technical Paper.
- 3.42 John Foreman Presentation BWEA Wave and Tidal Supply Chain Seminar 2009, http://www.bwea.com/marine/supply_chain_seminar2009.html
- 3.43 Kordahi M., Shapiro S., Lucas G., Trends in Submarine Cable Faults, On behalf of the Submarine Cable Improvement Group, Suboptic Conference 2007
- 3.44 Kordahi M. et al Global Trends in Submarine Cable System Faults, Suboptic 2010.
- 3.45 Analysis of Remediation Alternatives for the Pacific Crossing-1 North and East Submarine Fiber Optic Cables in the Olympic Coast National Marine Sanctuary http://sanctuaries.noaa.gov/library/national/pcl_ea.pdf
- 3.46 Platform Hogan Submarine Cable Repair Project, Santa Barbara Channel, Presentation by Mark Steffy of Longitude 123 Inc., http://www.slc.ca.gov/division_pages/mfd/Prevention_First/Documents/2008/Barcelona/Coastal%20Facilities%20Engineering,%20Construction,%20and%20Maintenance/POOL%20Platform%20Hogan%20Submarine%20Power.pdf
- 3.47 Jeppsson, J., P.E. Larsen and A. Larsen. Technical Description of Lillgrund Power Plant http://www.vattenfall.se/sv/file/2_Technical_Description_Lillgru_8459792.pdf_16611908.pdf

3.48 Allan, PG. Hydrographic Information and the Submarine Cable Industry, Hydro 2001, Norwich, March 2001.

4.0 CABLE TYPE SELECTION & INSTALLATION CONSIDERATIONS IN CABLE DESIGN

The submarine cables are one of the most complex parts of the offshore wind farm and require much attention and consideration when deciding upon an appropriate design. It is very important to know the water depth and vessel to be used in installing the cable since the cable has to be designed to take the full length of the cable in one piece for efficiency and the installation loads of the cable weight. The cable has to take its own weight from the vessel to the seabed including the catenary weight, the horizontal load, and also absorb the tension from the vessel movement during the laying process. The dynamic loads should be determined as accurately as possible but also allowing for the worst weather one could get caught-out in. The amount of bending required either in coiling on the deck or in deployment must be accounted for in the design thus layout of the installation vessel is a design input.

Export cables for wind farms are usually very much longer and larger in dimensions than the each of the in-field cables and consequently require different installation considerations. In order to aid installation efficiency, lack of faults, and lack of losses of power transmission, it is preferable for all cables and particularly the export cable to be installed in one length if possible. Depending on the power and need for redundancy the export cable may be selected as either one large, or multiple smaller cables, sometimes separated by a distance for added physical protection from external aggression.

In general, there are three options to be used for connecting an offshore wind farm to the main electrical grid onshore partly depending on the number and size of the wind turbines:

- Medium Voltage Alternating Current up to about 36 kV
- High Voltage Alternating Current (HVAC) generally from 100kV to 200 kV
- High Voltage Direct Current (HVDC) up to about 500kV – past 500 kV the connectors may not yet be developed of sufficient reliability.

In general, the voltage output from an individual wind turbine is stepped up by an internal transformer to 36 kV to reduce transmission losses. Higher voltages would require larger transformers within the wind turbine and more costly switchgear. As a rule of thumb for wind farms less than 100 MW and less than about 15 km to shore it is generally more economical to connect the power output of the windfarm directly using multiple medium voltage AC cables. No substation is needed. For higher output or greater distances it is usually more economical to connect the individual turbines to a transformer substation close by the field, bump up the voltage to a higher voltage, transmit the electricity to shore, and then bump the voltage down for connection to the grid. The increased efficiency of transmission negates the cost of the transformer substation and associated switch gear and reactors. The equations that apply are: (power = voltage x current) and (loss = resistance x current squared). A doubling of voltage equates to a reduction of the losses to 25% for the same power. The simplicity of the AC transformer, allows AC voltages to be easily stepped up and then down when reaching the shore prior to introduction into the grid.

For very large distances or very high output, HVDC is an option and the improved efficiency compensates for the increased cost of the cable, substations, and sophisticated switchgear when the

distance gets greater than about 25 – 50 km where the HVAC becomes less economical. As the distance increases, past about 35 km for AC transmission a significant amount of reactive power will use up much of the capacity in the cables such that additional equipment will be required to compensate for it: DC does not have such problems. (A simplistic explanation is that the AC power resides on the outer perimeter of the cable whereas for DC the power resides uniformly throughout the cable, thus being more efficient; this coupled with the idea that for AC the transmission must “row” its way along the cable, much like a boat is “rowed” along in a seaway and thus the reactive power can be viewed as the loss of energy while the oars are returned to the spot where force is applied again in the desired direction, adds to the efficiency of the DC System). The HVDC systems are able to carry 2-5 times the capacity of an AC line of similar voltage and thus reduce the size of cables needed. The downside of the HVDC system is the need for more sophisticated equipment including power converters, DC inductors, filters etc. needing to be placed offshore which leads to possible future maintenance problems, a larger space, and more capital expense. The need for less cabling and reduced electrical losses makes up for this over longer distances. Part of the reason HVDC may not have been developed more rapidly for shorter distances may lie in the issue that electrical engineers are not as familiar with DC systems as they are with AC systems, and this may be a reasonable input to the decisions as to which system to install.

In summary on the issue of HVDC vs. HVAC the overall system must be taken into account including the issue of having more than one export cable to minimize interruption because of a fault. The distance at which one becomes economic over the other varies a lot with the site-specifics and AC has been justified well in excess of 100 km, and DC down to about 50 km but the distances will change over time. Maintenance issues must also be taken into account. Table 1.2 can be consulted for the situation in historic offshore wind farms.

The design of the cables themselves is a very complex process targeted at improving (decreasing) the losses, minimizing the cable size, while ensuring the life of the cable will exceed the design life, usually around 20-40 years.

There are two main types of converter technologies used in HVDC transmission to convert from AC to DC and vice versa at either end of the transmission line:

- Line Commutated Current Source Converter (CSC),
- Self-Commuted Voltage Source Converter (VSC).

The advantage of VSC technology is that it is able to rapidly control both active and reactive power independently of one another. This thus reduces drastically the need for reactive power compensation and affords fast responses to disturbances. VSCs are therefore especially suitable for wind turbines’ application as they are able to respond quickly to fluctuations due to the changes in wind condition. BorWin 1 wind farm in Germany makes use of this system.

The maximum available voltage level for extruded submarine cables in general use, currently, is around 170 kV [Ref. 4.3]. Although the rating is for 170 kV in order to accommodate a +/-10% operating voltage range the maximum transmission voltage is usually set at about 150 kV. (The reported numbers for wind farm cable values in Table 1.2 shows how this may be reported differently). With the demand for higher offshore power it is anticipated in the future that higher voltage levels will become the norm up to 500 kV. A power cable of 500 kV is being constructed for

the Denmark-Norway SK4 electricity transmission line. The frequency of faults for these higher voltages has been reported as higher in the literature [Ref. 4.6].

The cable between offshore wind turbines in-field is typically around 36 kV AC and the export cable typically 132-245 kV AC for the transmission of the power from the offshore substation to the onshore grid. The cable in Figure 4.1 shows the specific cable for Horns Rev.



Figure 4.1: Horns Rev Export Cable 170 kV 3
-core XLPE insulated submarine power cable 630 mm² Cu-conductor Outer diameter: 194 mm. Weight 79 kg/m

Germany is currently building some very large offshore wind farms. The cable that has been selected is HVDC Light (high-voltage direct current) transmits power from the 400 MW Borkum West II wind farm and other wind farms in the area. The wind farms will be connected to an offshore HVDC transformer station which will transmit electricity to the onshore HVDC station at Dörpen, on the northwest coast of Germany. This will involve 165 km of underwater 320 kV DC cables. At Dörpen the DC will be converted to AC and then on to the grid.

Figure 4.2 below shows the cable cross-section used for Greater Gabbard wind farm in the UK. Of note is the single layer armoring, common for offshore wind farms. The Greater Gabbard submarine cables had over 200 km of inter-array cable, 100 km of main line to onshore tie-in, routed through large J-Tubes, then laid on the seabed with 18" to 24" cable diameters, with bundled fiber optics for turbine and platform controls.

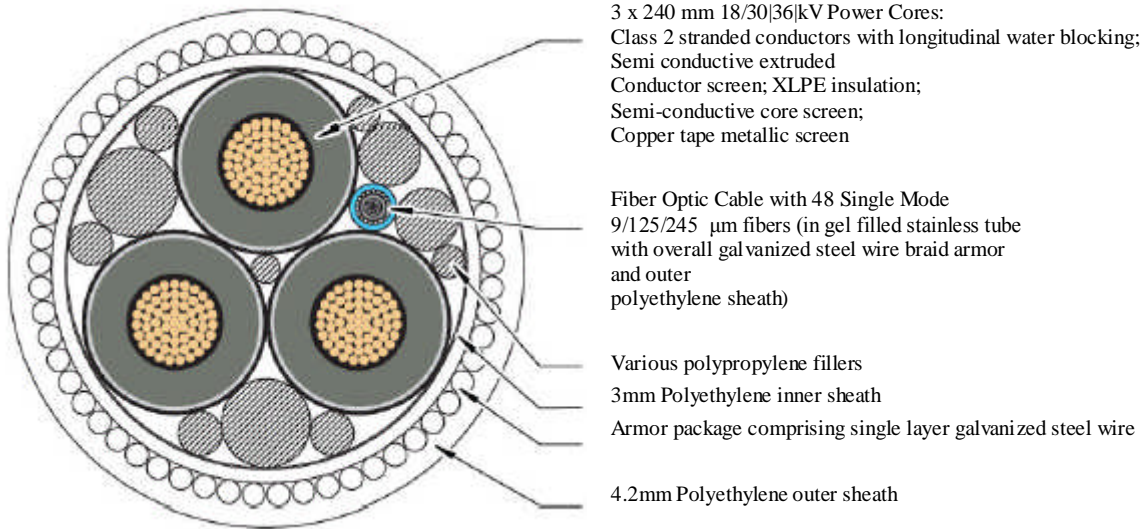
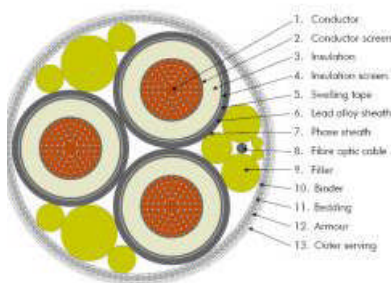

Figure 4.2: Subsea Cable details of Cross Section

Mike Bateman, Heerema Fabricators presentation to the Society of Petroleum Engineers, Houston, Sept. 2009 [Ref. 4.4].

Other UK wind farms have similar configurations:



LINCS: 250 MW

- TKRA 145kV 3x630/1000mm²
- Two lengths of 49km, 98km total
- Including a Fiber Optic element 84 fibers
- Joints, drum for spare length and accessories
- SHERINGHAM

SHOAL: 315 MW

- 2 x 21km TKRA 145 kV 3x1x630 mm²
- 2 x 0.2km TKRA 145 kV 3x1x1000 mm²
- Including a Fiber Optic element
- Joints, spare length and accessories

LONDON ARRAY

- 4 export cables
- TKRA 170kV 3x1x630mm²
- TKRA 170kV 3x1x800mm²
- 800mm² at each 3km end
- 47-48km 630mm² main length

Figure 4.3: Sheringham Shoal, Lincs & London Array (Courtesy Nexans)

The submarine cable used for the Blyth project was 70 sq. mm EPR Double Wire Armor with 16 fiber optic package.

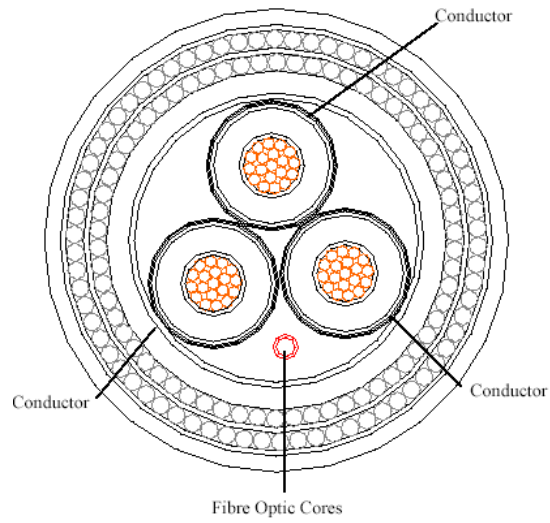

Figure 4.4: Cross Section of 70 Sq. mm Double Armor with 16 fibers Optic Package



Figure 4.5: Cable Terminations at Horns Rev 2 (Courtesy Nexans)



Figure 4.6: Accessory Hangoffs (Courtesy Nexans)

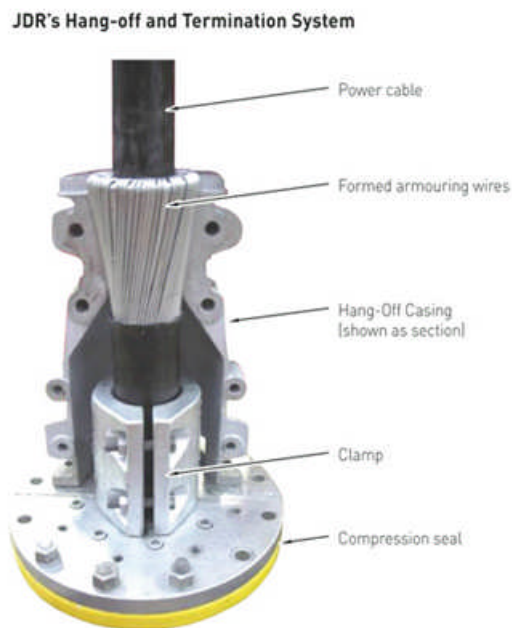

Figure 4.7: Hangoff and Termination – London Array (Courtesy JDR).

The table below contains a typical variety of submarine power cables to be used with wind farms:





					
Rated Voltage	33 kV AC	150 kV AC	420 kV AC	320 kV DC	450 kV DC
Insulation	XLPE, EPR	XLPE	Oil/paper or XLPE	Extruded	Mass Impregnated
Typical Application	Connection of offshore WTG	Export cable	Crossings of rivers with large export capacity	Long distance connections of offshore wind parks	Interconnection of power grids
Max. Length	20-30 km	70-150 km	<50 km	>500 km	>500 km
Typical rating	30 MW	180 MW	700 MW/ 3 cables	1000 MW/ Cable pair	600 MW / cable

Table 4.1 Comparison of Features of Various Cables

The earliest electricity generation in the days of Edison and Westinghouse was DC. At the time the Niagara Falls hydroelectric dam was built, Nikola Tesla persuaded the builders to provide an AC system. The main reason for the adoption of AC was that it is relatively simple to change AC voltage levels by using transformers, while it is difficult to change DC voltages and higher voltages allowed more power to be transmitted with fewer losses. The development of solid-state power electronics in the last decade has allowed an increased use of DC for transmission and in the form of HVDC interconnections. DC transformers have become commercial even though they are much more complex than AC transformers (and thus more expensive). DC switch gear is more expensive than AC. As an example, some of this is due to the fact that more power arcs across the contacts in a DC line than an AC line when it is connected and disconnected. When a high voltage AC line is switched off, the voltage will arc across the switch contacts. Once the contacts get far enough apart, the arc will naturally extinguish itself since the voltage drops to zero twice during the AC sine wave cycle. Since DC is constant and doesn't cycle to zero, a DC switch will draw a much longer arc, and suppressing this arc requires more expensive switching equipment [Ref. 4.1].

DC power transmission does have some advantages over AC power transmission. AC transmission lines need to be designed to handle the peak voltage of the AC sine wave. However, since AC is a sine wave, the effective power that can be transmitted through the line is related to the root mean squared (RMS) value of the voltage, which for a sine wave is only 0.7 times the peak value. This means that for the same size wire and same insulation on standoffs and other equipment, a DC line

can carry 1.4 times as much power as an AC line [Ref 4.2]. Another advantage is that HVDC allows power transmission between unsynchronized AC distribution systems, and can increase system stability by preventing cascading failures from propagating from one part of a wider power transmission grid to another.

AC power transmission also suffers from reactive losses, due to the natural capacitance and inductive properties of wire. DC transmission lines do not suffer reactive losses. The only losses in a DC transmission line are the resistive losses, which are present in AC lines as well. Capacitance is the ability of an insulating material between conductors to store electricity when there is a voltage difference between the two conductors. The buried cable itself acts as a long capacitor, and charging current is produced along its entire length, so the longer the cable, the more kVARs (Kilovolt-Ampere-Reactance) are generated. Reactive power is consumed by reactances, and is measured in volt-amperes reactive, or VAR (sometimes kVAR). Typical amounts of kVAR generation are in the range of 100-150 kVAR/km for 33 kV XLPE cable and 1000 kVAR/km for 132 kV XLPE cable [Ref. 4.3].

The additional reactive current reduces the active current-carrying capacity of the cable. For any length over about 6 mi., a device is required to decrease the reactive power by adding devices at the cable ends to accomplish that. The insulation used for the same amount of electricity transmitted is more for the AC line because the insulation is designed for the maximum current rather than the average: in a DC system the voltage is constant so the maximum is also the average.

For an overall power transmission system, this means that for a given amount of power, AC requires more expensive wire, insulators, and towers but less expensive equipment like transformers and switch gear on either end of the line. For shorter distances, the cost of the equipment outweighs the savings in the cost of the transmission line. Over longer distances, the cost differential in the line starts to become more significant, which makes high-voltage direct current (HVDC) economically advantageous [Ref. 4.5].

For underwater transmission systems, the line losses due to capacitance are much greater, which makes HVDC economically advantageous at a much shorter distance than on land [Ref. 4.14]. Overhead transmission lines primarily use aluminum as a conductor because of concerns about weight: because they have high resistance they can overheat within conduits, so for those situations they are often accompanied with cooling systems when in confined spaces (e.g. underground or in conduits). Underwater cables are generally made of copper as weight is not generally an issue, although there is always a balance between the greater cost of copper against its superior conductivity and lower resistive heating.

A DC transmission system can consist of one cable (single pole) or two cables (bipolar). A single pole system uses electrodes for sea or ground return. While reducing the cable and laying costs, single pole transmissions have two disadvantages: greater electromagnetic field creation; and emissions of gases generated at the electrode. Bipolar is the more common design, but often includes sea electrodes for temporary backup use in the case of damage of one of the cables. A relatively new configuration on the market is a bipolar coaxial DC cable with the return conductor surrounding the inner conductor: one manufacturer calls this “HVDC Light”.

Larger wind farms will demand more sophisticated electrical transmission systems because wind power makes a greater demand on the onshore electrical grid. The electricity emanating from the wind farm may require “conditioning” prior to onward transmission to the grid, and so there are likely to be big advances in technology in the area of power electronics.

The cable laid from wind turbines to shore presents a significant cost to the project. Since the cable carries the fiber optic control connection, lack of power and lack of connection may put the turbine and tower structure at risk of failure if the movement of the yaw mechanism to align with the wind is crucial to tower survival (based on load cases required by the IEC Code).

4.1 Types and Manufacture

Because the distances from the initial proposed wind farms to shore is not large it is most likely that the U.S. will see mostly the medium voltage 36 kVA cables in the inter-array cables and mostly 132kVA AC in the export cables in the first round of developments.

4.1.1 Basic Information on Cable Construction

There are a huge variety of shapes / patterns used by manufacturers in their “recipe” to get the most out of the materials for efficient submarine power cables and minimize losses, however, the most important item to the purchaser is the minimum electrical resistance for the required cross-section. Variables include compression factors, raw material grade, lay length etc. The minimum ratings for standard sizes are given in IEC 60228: Conductors of Insulated Cables. Submarine cables for are almost always tailor-made for a specific job and location which requires a long lead time (2 years at present), but has the benefits of material not being wasted: but provides a compelling reason to order and carefully store additional spare cable in case of a need to repair a fault.

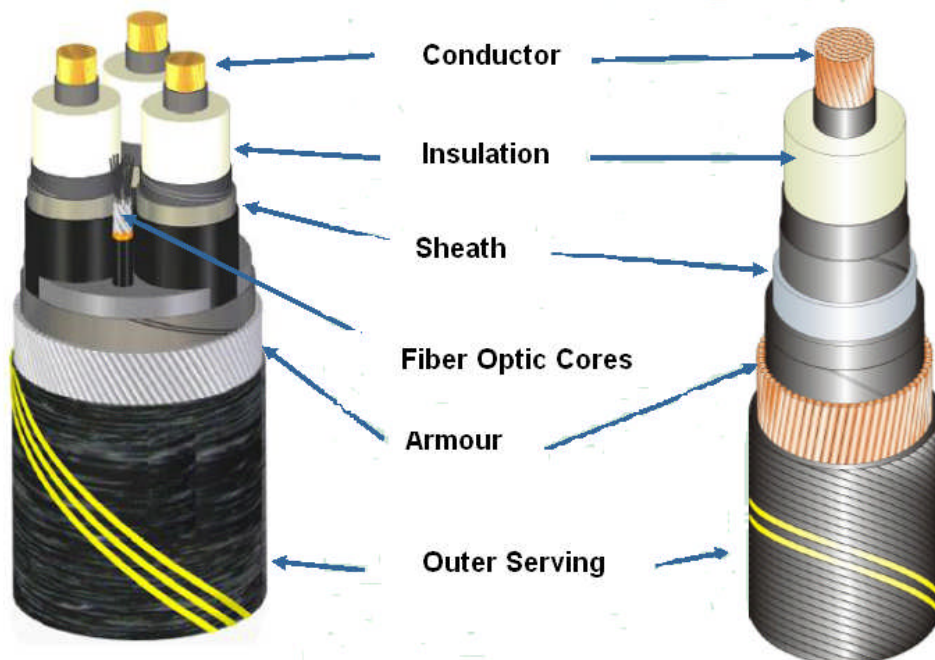

Figure 4.8: Typical 3 Phase AC Cable bundled with Fiber optic and Single Cable

Cables can be laid either left hand or right hand lay. It is most important for installation considerations to know the lay since it determines whether lay-out is clockwise or anti-clockwise on the deck. As you lay out the cable the wires either tend to open to one-another or compress to one another. An opening of the conductors which are coiled can damage the insulation layers, if the conductor wire is laid incorrectly. In a Z-lay, the conductors should be laid clockwise which will tighten the diameter and not open up and damage the insulation layer. When the cable is complete with armoring, the closing-in on the armor wires may lead to kinks or loops thus for armored cable the opposite should be the case and the Z-lay armored wire should be laid anticlockwise which should act to open the space between the armor wires slightly. It is best to have the coiling direction clearly stipulated by the manufacturer [Ref. 3.36, pgs. 12 & 135]. To observe if the cable is Z-lay or S-lay look at a vertical segment of the cable: the stripes are either Top Right-Bottom Left like the middle segment of the letter Z. Likewise the stripes for S-lay are Top Left to Bottom Right like the center section of the letter "S". The standard cited for design of conductors is IEC 60228: Conductors of Insulated Cables.

Water tightness of the submarine cable is paramount. When laying the end of the cable through a J-tube at the turbine location, the end must be sealed against water ingress. This is achieved by putting sealing material covering over the cable end while threading the conductor. An important feature of the cable is for the material around the conductors to swell up and seal so that in the event of water ingress, a minimum length of cable is exposed to water: allowing this to be cut out when splicing the cable during repair. It is important to know the swelling agent as those for fresh water may not work as well in salt water and the swelling agent for a cable in salt water may have to be specifically designed. The swelling compounds used are known as hydrophobic compounds. Petroleum jelly (vaseline-based material) can be one of the ingredients in the swelling compound.

4.1.2 Conductors

The conductor in medium- and high-voltage submarine cables for offshore wind farms is generally copper. Aluminum also has been used and improvements are being sort but this has a lower current-carrying capacity (ampacity) and so requires a greater diameter. The size of copper strands are dictated by the power required to be carried. The area of the cable increases in direct proportion to the power requirement.

For many of the offshore wind farms to date with AC transmission the three phases of the AC transmission are bundled into one three-core cable to reduce laying costs. It also produces weaker electromagnetic fields (EMF) outside the cable since the interference among the cables negates EMF. 3-core cable has lower current losses than three separate single core cables. As the diameter increases (because the load increases) the handling issue becomes overwhelming. The higher power requirements result in the laying of several single core cables which are less wieldy and can be developed in longer lengths.

Details	33 kV Cable Type				
	95 mm ²	240 mm ²	400 mm ²	630 mm ²	800 mm ²
Overall Diameter (mm)	89	104	127	143	153
Weight (kg/m)	12.2	18.6	38	49	59
Power MVA	18	29	36	44	48
Details	132 kVA Cable Type				
	300 mm ²	500 mm ²	800 mm ²	1000 mm ²	1200 mm ²
Overall Diameter (mm)	185	193	214	227	232
Weight (kg/m)	58	68	88	100	108
Power MVA	127	157	187	200	233

Table 4.2 Typical Cable Characteristics of AC Cable [Ref 3.2]

As an illustration of the differences between copper and aluminum and the variation with land vs. submarine the following figure shows for a DC cable the required cross-section area as a function of power required for offshore and for land for both copper and aluminum. Submarine copper cable is the smallest size required. Land cable requires a slightly larger cross section as the temperature is not dissipated with the water, and aluminum requires an even larger cross-section for the same power.

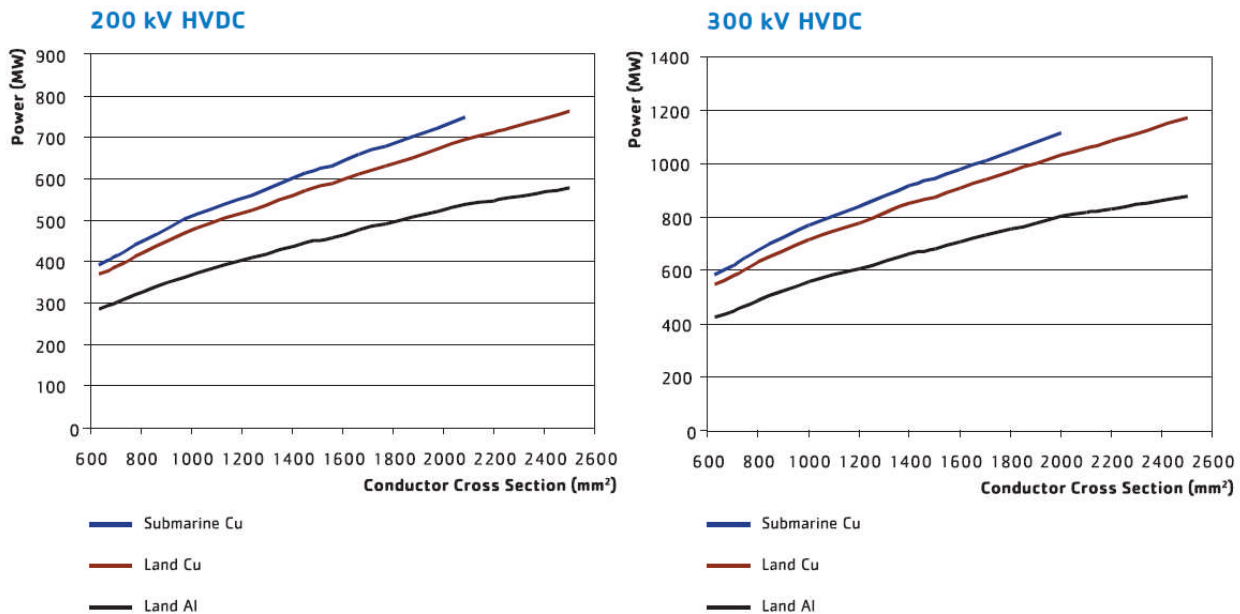

Figure 4.9: Nominal Power for 2 applications of HVDC and various Conductor Cross-sections [Courtesy: Nexans’ Brochure]

4.1.3 Insulation

A variety of insulation materials are available and may be acceptable. Several types of cable insulation are in common use for submarine transmission for long distances (at least several

kilometers). Low-pressure oil-filled cables, insulated with fluid-impregnated paper and have been historically used in the US for submarine AC transmission. Solid mass-impregnated cables have been used for HVDC transmission where lapped paper is insulation is impregnated with a high-viscosity fluid (from which there is no leakage). The most popular type proposed for offshore wind farms seem to be extruded insulation cables such as XLPE (Cross Linked Polyethylene). Other materials can be used for insulation but one needs to ensure that each is compatible with the voltages to be transmitted. While Low, Medium and High density polyethylene (LDPE, MDPE and HDPE) have been used in the past for wind farm application the XLPE is favored because it can operate at 90°C and does not short-circuit until over 250°C, whereas the LDPE operating temperature is 70°C, and short circuits at 125°C. The cross-linking process is irreversible so it is not possible to mold the insulation by melting. At a voltage up to about 150 kV, manufacturers of XLPE claim there is no limit to the distance over which transmission can occur, and over 400 kV the claim is limited to about 100 km or 62 miles. For the very high voltages there is a paucity of connectors and thus the cable needs to be made in a single length which adds complications to any repair scenario.

4.1.4 Screening

A semi-conductive screening layer, of paper or extruded polymer, is wound around the conductor to smooth the electric field, and also to assure a complete bond of the insulation to the conductor.

4.1.5 Bending Radius

Large cables may have a bending radius as large as 20 ft. When being laid, the cable vessel must be able to accommodate the manufacturer's restrictions on the bend radius. When cables are fed through the J-Tube at the turbine end there is a need to ensure that the bending radius of the J-tube suits that of the cable. This apparently has been a problem with many cables laid in the UK. The diameter of the J-tube needs to be about 2.5 times the diameter of the cable in order that it can be pulled through. New devices on the market for introducing the cable directly into the wind turbine pipe/platform avoiding a J-tube are available and there is a way to set a bend arrestor for those devices in locking plastic coverings together to provide the limitation. Bending the cable more than the design can lead to a reduced life and increase the probability of faults.

4.1.6 Sheathing

Outside the screening of all the conductors is a metallic sheathing to prevent moisture. It helps to ground the cable as a whole and carries fault current if the cable is damaged. In AC cables, current will be induced in this sheath, leading to necessary efficiency losses.

Options of sheaths that can allow humidity to defuse outward are also useful. Metal sheaths can protect against some species of mussels that can attach themselves to any unburied cable and cause damage. Suitable lead sheaths for submarine cables are designated to EN 50307: Lead and lead alloy sheaths and sleeves of electric cables. Polyethylene sheaths are common in offshore wind farm cables. High Density Polyethylene is a desirable sheath and is impermeable to water and the vapor permeability is very low.

4.1.7 Armoring

The decision of armoring is one of the more complex tasks in designing a marine cable for an offshore wind farm. Numerous variables have to be evaluated. Armoring provides strength for the

cable which is in tension during the laying process. The deeper the waterdepth the more armoring is required to support the cable during this temporary phase (and during any repair phase). The amount of armoring must take into account the stress from the weight of the entire cable and the motions of any vessels now or in the future which could impart load to the cable.

The armoring protects against recreational vessel anchors, fishing gear, installation tools, and any motion of the cable on rocks and the like as well as ship's anchors in some cases. It provides support over unsupported lengths in certain terrains e.g. rocky terrains, or areas where scour may lead to unsupported lengths.

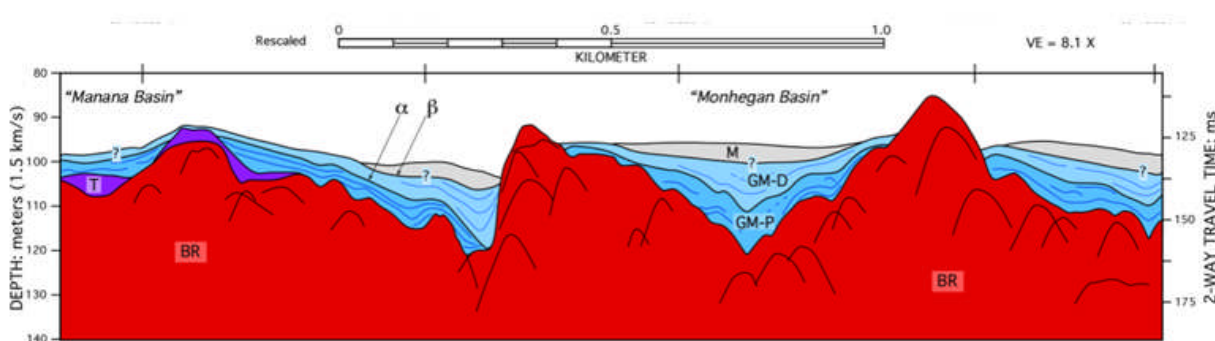

Figure 4.10: Rocky Terrain Offshore Maine –
planning for cable to a potential Spar demonstration project
(Courtesy Team Megan – Texas A & M University Student Project).

Noting that the armoring may have direction to it being right or left lay, or possibly cross-lay, this may lead to complications if the vessel is not pre-selected at the time the cabling is designed. The issue of the lay of a cable component has been noted with respect to the conductor in Section 4.1.1 but it is emphatically so for the armoring. For armoring of cable for rock areas the outer wire layer has a very short lay length to improve the cable crush resistance. As armoring changes either in content or lay length the techniques of installation also change.

Corrosion can occur to the armoring wire if it comes into contact with seawater. This may need to be considered in the design sizes to allow some corrosion allowance. The armor is generally zinc-coated wire and generally dipped in hot bitumen.

4.1.8 Jacket

An overall cover (jacket), a further protective layer usually in the form of an extruded polymeric layer. If yarns are used as an alternate, it is important to get the yarn lay in the same direction as that of the armor provided or damage can occur from being bent so as to open the layers. The external layer is often striped to observe twisting, and also for identification.

4.1.9 Fiber Optic Cables

Fiber optic cables for communications and control can be bundled into the cables or can be separate. In some cases it may be possible to replace one of the armor wires with the fiber optic cable in an aluminum sheath. The risk is that if the optical fibers are damaged one would need to extract the

entire cable to effect a repair. The fiber optic cables can be buried at the same time, attached to the main cable by tape. This is largely a matter of risk and choice.

4.1.10 Cable Joints

Cable joints are sometimes required in the manufacturing process in the factory. The conductors are generally welded either by individual strand or by a solid seam across the multiple wires. The welding of the conductor weakens them by about 30% as the material is annealed in the process. The joint insulation, made out of the same material as the original cable can be applied often by appropriate tapes and is cured under heated and pressure conditions. Factories are set up with special rooms for jointing which include temperature and humidity control and special arrangements to joint under clean conditions. A sheath, usually lead, is added over the joint and joined to the cable's lead sheath. Other layers can be added including a polymeric shrink tube, and armoring. The result is a somewhat larger diameter cable over the joint area.

The armoring is best welded from one section to the other accounting for a continuation any spiral pattern and spaced so as to ensure no additional tension comes onto the inner cables.

Besides the joining of cables as described above, in the field, a joint can be formed by several other techniques including providing a steel outer casing, and a jointing of the wires by the use of pre-molded joint sleeves with both electrical and insulating layers on each side. The wire armoring each side is connected to the joint by clamping or welding and the casing can then be filled with bitumen or other specially designed compound.

Section A.16 describes with photos the repair of the submarine cable to the Hogan Platform offshore California.

Many varieties of jointing arrangement have been successfully executed and a specific jointing may need to be especially designed and factory tested to the extent possible when jointing different wire sizes as may be necessary if the size of the wires change on shore approaches.

The terminations for offshore cables are almost the same as on-shore terminations of underground connections except that account must be taken of the salty environment and extra corrosion protection must be ensured. Space is often limited in offshore terminations and layouts need to take into account the space required for these and for their repair should that be necessary.

Figures 4.5 and 4.7 show typical terminations.

4.2 Cables and Heat

All electrical cables have resistance and the resistance manifests itself as heat. The amount of heat is proportional to the power transmitted. When in seawater the heat can dissipate easily. Buried cable even underwater is something to be concerned about but as it comes ashore the shore connection, not cooled by water is an important area to check the design for.

Greenpeace [Ref. 4.10] states in relation to environmental impacts: "Due to the immense heat capacity and conductivity of seawater, local heat production along the cable is not really a problem. For an HVDC cable it can be assumed that a significant temperature rise at the sea floor above the cable can be avoided if the trench has a depth of at least 1m."

When the cable is buried beneath the sea, the water effectively cools the seabed surface above the cable to water temperature. The water is usually much cooler than the ambient air temperature, and in addition air does not cool the surface quite as effectively. Quite often the cable is buried deeper in the onshore section – which also adds thermal insulation. Any thermal issues when getting to shore may be solved by increasing the cable size. Thanet wind farm moved from conductor area of 630 mm² to 1000 mm² at the shore approach. When the shore portion is insulated by a containment protection pipe (when drilled in), another constraint to overheating needs to be overcome either with sufficient space for heat dissipation or some cooling arrangement added. Of course soils are different – some have better thermal conductivity than others. It is part of the design cycle to do thermal analyses for each project in order to determine the sufficient cable size.

Most often fiber optic cables are embedded into the submarine cable to transmit data on control and monitoring of the wind farm, or are attached to the main cable separately as a side-appendage. With the issues that have arisen in cables, and are particularly likely to arise in a new geographic setting there are compelling reasons to integrate additional temperature measuring cables alongside the conductors. These optical fibers have the purpose of:

1. Temperature measurement along the line;
2. Measurement of cable strain and vibration;
3. Fault detection and locations;
4. Detection of changes over time i.e. exposure of buried cable from sand wave mobility.

The temperature can be deduced from the spectral changes in the back-scattered light from short laser impulses with a device called a Distributed Temperature Sensing system (DTS). The DTS is an opti-electronic device which measure temperatures by means of optical fibers functioning as linear sensors. Temperatures are recorded along the optical sensor cable, thus not at points, but as a continuous profile. A high accuracy of temperature determination is achieved over great distances. Typically the DTS systems can locate the temperature to a spatial resolution of 1 m with accuracy to within $\pm 1^\circ\text{C}$ at a resolution of 0.01°C . Measurement distances of greater than 30 km can be monitored.

In order to examine the issue of cables and heat in concept, the following Figures may make some of the issues clear. The cable manufacturers have developed models over the years that are used to determine, what the likely temperature rise is with power required, based on the water temperature at location (which may vary with depth), the thermal resistivity of the soil (measured during soil surveys), and cable construction. The outcome of such a computer model is show in Figure 4.12.

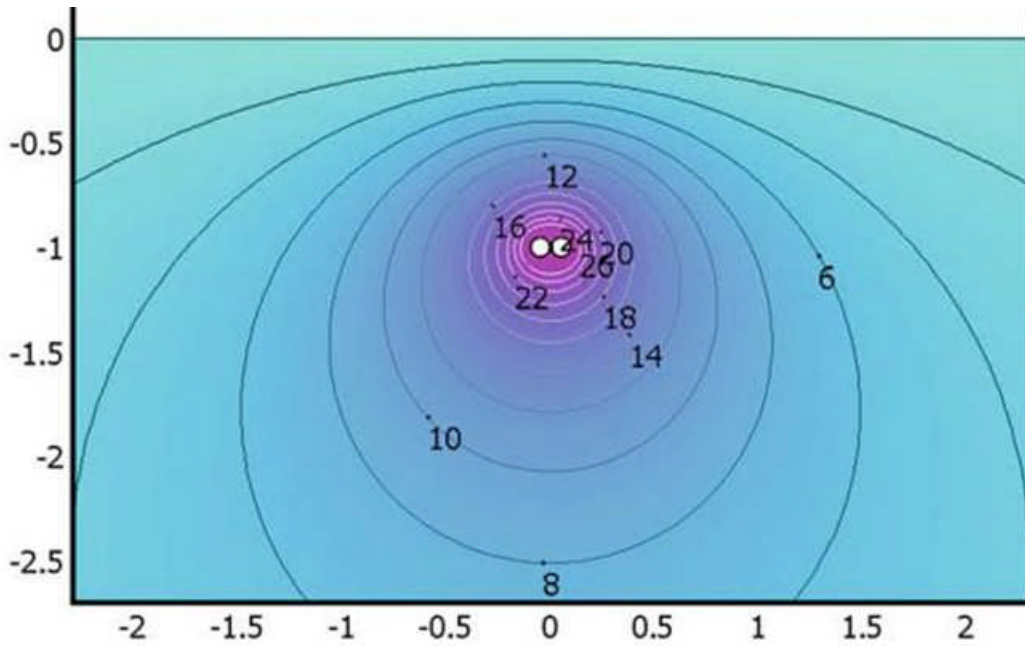

Figure 4.11: Temperature contours around a pair of submarine HVDC cables.
 x-axis is horizontal distance in meters, y-axis vertical depth below seafloor in meters (cable is at -1 m depth), and numbers in the diagram is the temperature rise above the seabed temperature in °C [Ref. 3.36]

As can be seen from Figure 4.11, a happy cable is likely to be some 20°+ above the ambient temperature. Temperature limits on XLPE cables is 90° C so based on a reasonable temperature in the water Figure 4.11 shows an acceptable situation. As such a cable comes on land, it may be that an ambient temperature in summer may be more than this, and thus either the size of cable may need to be increased (lowering the resistance and thus heat) or some way found to lower the temperature around the cable by other means.

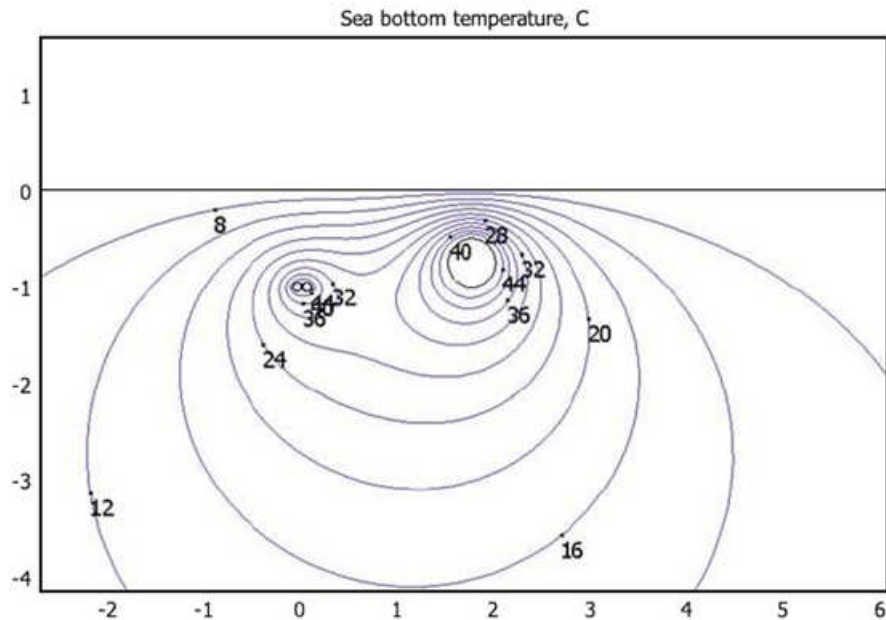

Figure 4.12: Temperature contours around a pair of submarine cables on the left and a pipeline on the right with a 50° C surface temperature.

The x-axis is horizontal distance in meters, y-axis vertical depth below seafloor in meters (cables are at about -1 m depth), and numbers in the diagram is the temperature rise above the seabed temperature in °C [Ref. 3.36]

The stated goal of the German requirements is for a limit of 2 degrees above ambient temperature of 20 cm below the seabed. In this figure the bottom temperature is 4°C. From Figure 4.12 it appears likely that the pipeline would cause the temperature at the seabed to be approximately 8 degrees at 20 cm below the seabed or twice the German regulatory limit. An additional contribution to the heat is the electrical cable and from this analysis it would be desirable to move the electrical cable by at least 10+ meters from the pipeline. If the cable is an XLPE cable its heat limit is at 90° C, so that the cable were alone buried at 1 m. it has no problem coping with this situation.

In confirming the design of the cable it becomes important to take into account the many factors that may influence the design i.e. power requirements, frequency of overloads which is dependent on depth and soil type, annual variation of temperatures, load patterns, and the potential for other cables to be installed nearby in the future. Computer modelling of the proposed design becomes critical. It is also important to add the issue of the cable becoming un-buried to the model, when appropriate in a sand wave area, as this leads to not being able to have a “sink” which can allow a temporary electrical overload of the cable since the thermal capacitance of the adjacent soil is not present.

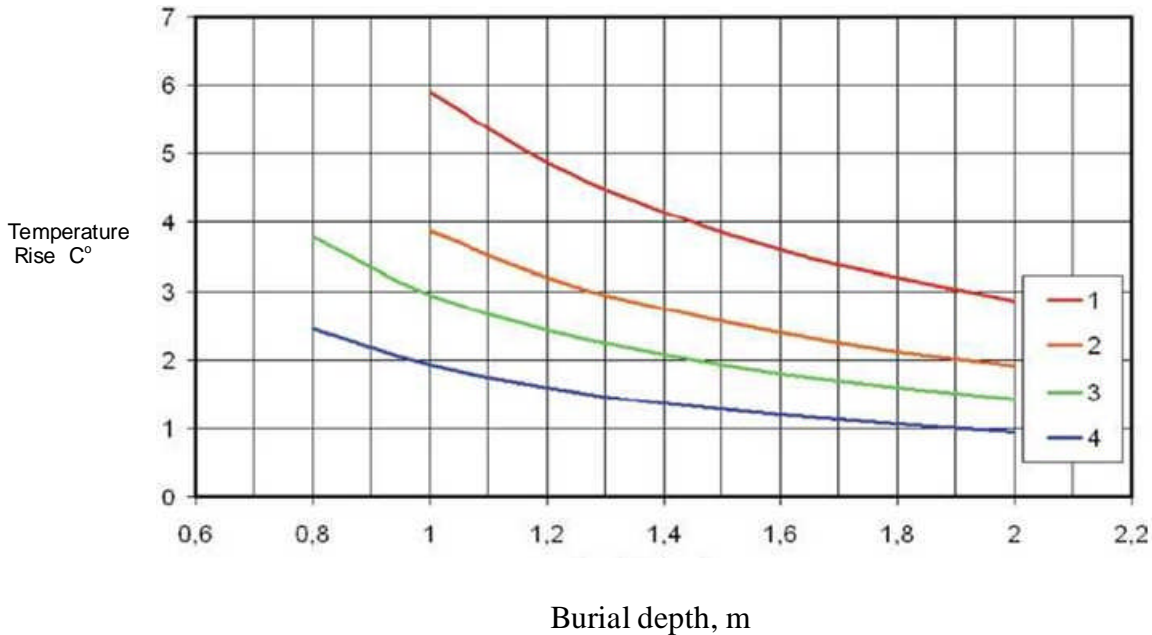

Figure 4.13: Temperature rise at -0.2m and -0.3m below the sea floor.

Figure 4.13 shows the results of a calculation that is required in Europe is to determine the temperature rise at the sea floor (or for conservatism, below the seafloor) and to confirm whether it exceeds the ambient seafloor temperature by more than 2 to 3 degrees [Ref. 3.36].

Curve 1 models a pair of HVDC cables, touching, cable diameter 100mm and -0.3m depth.

Curve 2 models a pair of HVDC cables, touching, cable diameter 100mm and -0.2m depth.

Curve 3 models a single cable, diameter 150mm, and 0.3m depth

Curve 4 models a single cable, diameter 150mm, and 0.2m depth

The interpretation in this example would be that for Curve 4 there would be a required burial depth of 1 meter to meet the requirement at the -0.2 m depth; and for Curve 2 it would have to be a burial depth of 1.9 meters. Options would be available to increase the cable size, reduce the power or accept the burial depth.

The German requirements are set out in [Ref. 4.9]. There is no similar requirement in the USA.

A useful chart that is of interest is to see the annual variation in temperature over a year as a function of burial depth.

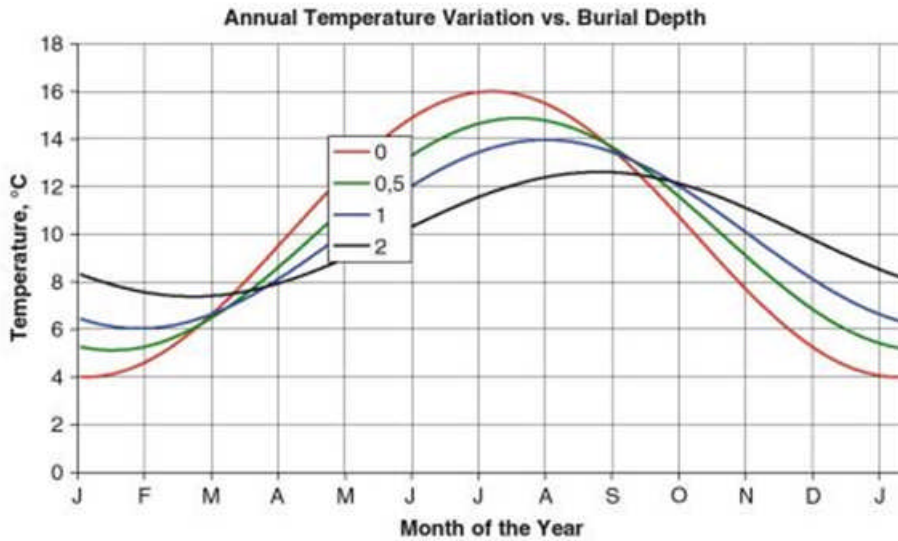

Figure 4.14: Temperature as a function of time and burial depth in meters. (based on Thermal resistivity value of (m x K/W) of 0.65 [Ref. 3.36].

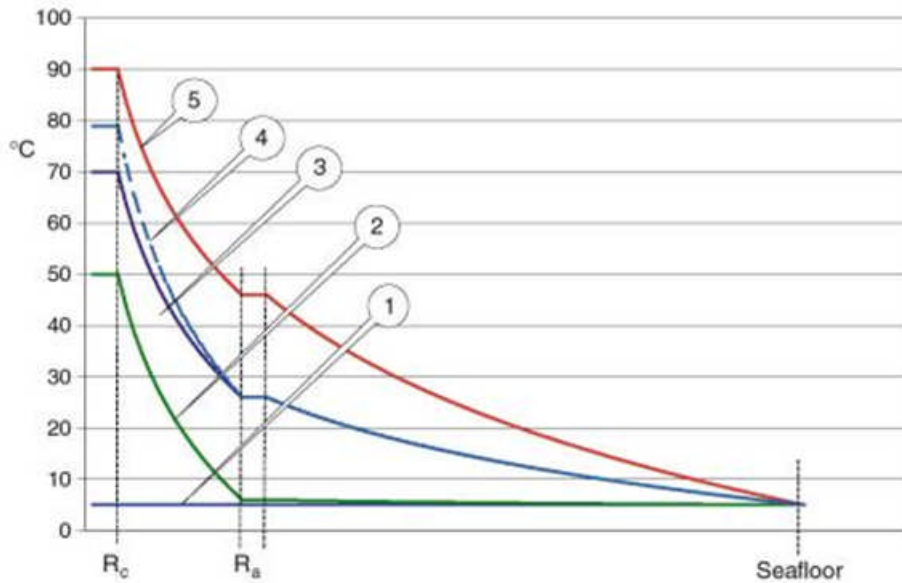

Figure 4.15: Temperature profile in a single-core cable and surrounding soil (R_c is the conductor radius, R_a is the armoring radius; x-axis measures the distance from the cable centerline to the seafloor) [Ref. 3.36].

It is also interesting to note that during commissioning it is not possible to test out to know the final temperature of the cable as it takes considerable time for the cable to heat, and to heat the surrounding soil to a stable temperature. This reinforces the benefit of having a fiber optic monitoring of cable temperature. Figure 4.15 may be interpreted as follows:

Curve 1 when the electrical load is first introduced, the temperature at the seafloor is 5°C.

Curve 2 after 3-4 hrs. a steady state is reached, noting that the temperature across the armor is a constant and that the cable itself is heating up but very little is dissipating into the soil.

Curve 3 after more time the heat dissipating from the cable into the soil causes the soil temperature to rise outside the armor and the rise inside and outside the armoring remains similar.

Curve 4 as the soil temperature continues to rise, the core maintains a 45° constant value over the temperature of the armoring.

Curve 5 after several weeks, the temperature of the cable up to its specification limit of 90° since we assume this is an XLPE cable.

If the cable gets overloaded during the few weeks building up to Curve 5, it is not a problem. If the cable was just in seawater with no soil to heat up, then the steady state would be reached in a few hours instead of a few weeks.

Another interesting graph is the electrical current rating decrease with depth, from temperature increases and ability to dissipate the heat.

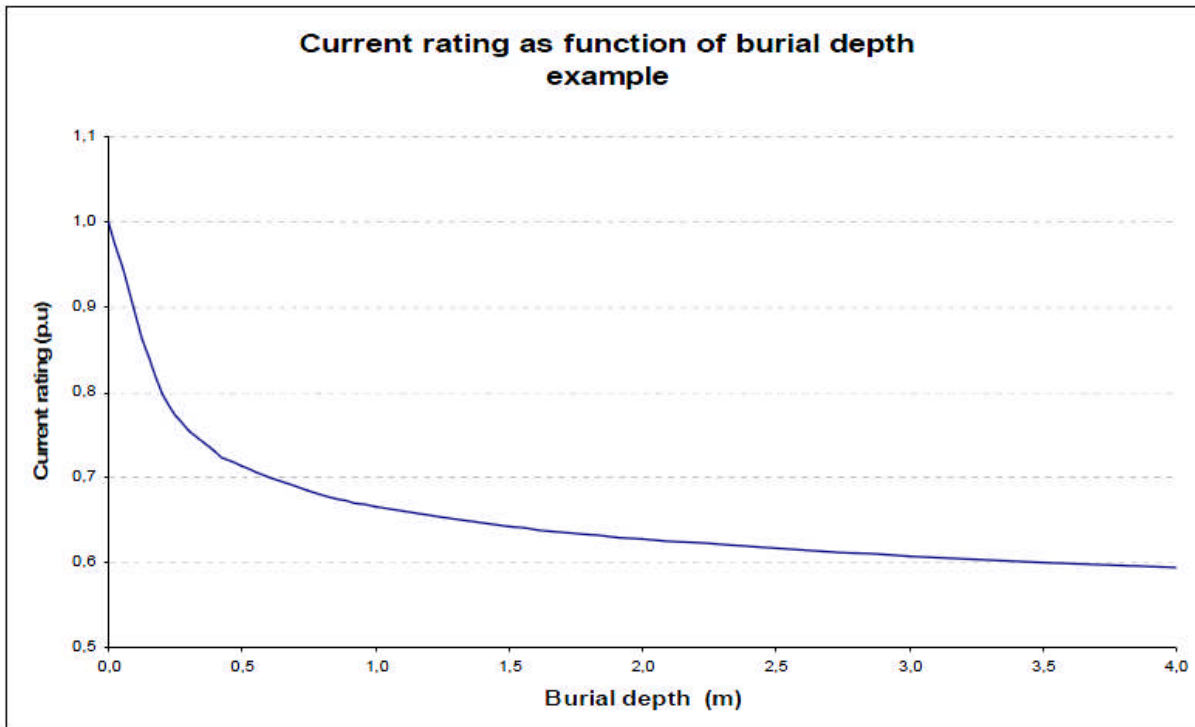

Figure 4.16: Current Rating as a Function of Burial Depth (Example)
[Ref. 4.19]

The caution here is do not bury deeper than necessary.

Calculations and graphs such as Figures 4.11 to 4.16 for the site-specific cable and soil, submitted as part of the Facility Design documentation provides confirmation of a suitable design for the submarine cable.

4.3 Electromagnetic Fields (EMF)

An electromagnetic field (EMF) is a combination of an electrical field (created by voltage or electrical charge) and a magnetic field (created by an electrical current). Electromagnetic fields are present in our daily lives from common sources such as household appliances, TV antennae, radio stations and cellular phones. It is also of note that subsea pipelines, sewer outfalls, and dock structures are often protected by impressed current or sacrificial anodes albeit at low current 1-2 amps D.C. These systems are not reported as having any effect on marine organisms.

The crux of the issue is that when electricity is transmitted in a cable an electromagnetic field forms around the cable. The influence of this electromagnetic field is only over a very short distance, a few meters, from the core of the cable but has been suspected of “influencing” electro-sensitive fish and other sea creatures. From a large amount of research carried out, it appears that there is no influence in navigation of surface ships (with one configuration being the exception), nor any issues other than perhaps a minor effect on certain species of fish and sea creatures that has yet to be determined. There are some details of the studies that are worth exploring.

The characteristics and strength of the magnetic field vary based on whether A.C. or D.C. is being transmitted and the configuration of the cables: whether the transmission is in 3 phases bundled together for A.C. or whether single, bi-polar or coaxial cables for D.C.. In all cases the EMF strength is proportional to the current and surrounds the core concentrically: leading to the note that the EMF of power transmitted at a voltage of 170kV is less than one-quarter of that transmitted at a voltage of 36 kV.

In Europe, monitoring studies of potential wind project-related EMF have shown minimal, if any, effects on marine organism behavior or movement. This is in part because magnetic fields produced by electrical cables tend to be restricted to an area of several meters from the cable. There may be some concern with potential interference with cathodic protection of crossing pipelines, however, no clear conclusions appear to have been made on this subject [Ref 1.1, Pg. 112].

An extensive study carried out on Danish wind farms confirms the minimal effect [Ref. 4.7].

Reports coming in from research in the UK indicate that there is some effect, albeit small, in electro-sensitive fish, but there appear to be no conclusion as to what the extent or consequences of the effect is, and whether beneficial or harmful. Research is likely to continue on this subject [Ref. 4.8].

4.3.1 EMF and Alternating current

A summary Report issued by the German regulatory authority (BSH) [Ref.4.9] states:

“With three-conductor cables, the magnetic fields almost cancel one another out. The limit value of 100 μ T at 50 Hz required by BImSchV (German EPA partly equivalent) for areas in which people stay for long periods is thus complied with, without restrictions. The same applies for coaxially operated three-phase single-conductor cables as well as for three-phase single-

conductor cables operated in a bipolar arrangement. When non-stranded cables are used, it is necessary to demonstrate that they have been laid in accordance with BlmSchV.”

4.3.2 EMF and Direct current

....and

“The magnetic fields almost cancel one another out when bipolar cables are used. The limit value of 400 μ T at 0 Hz for areas in which people stay for long periods, as required by BlmSchV, is therefore complied with without restrictions. When monopolar cables are used, it is necessary to demonstrate that they have been laid in accordance with BlmSchV.”

To avoid the impact of electromagnetic fields on the environment by D.C. cables, the two poles of a D.C. system, the forward and the return conductor, have to be installed parallel and close to each other in order to neutralize each other: this is called a bipolar system. In monopolar systems, strong electromagnetic fields are generated along the single cable and electrolysis occurs at anode and cathode of the return conductor, the sea water. According to Greenpeace this precludes the use of monopolar systems in offshore wind farms. Certainly it would mean they need to be studied in those systems [Ref. 4.10].

There are, however, a number of monocables used for connecting electrical grids:

- the Baltic Cable connecting Sweden and Germany is a monocable with return current being conducted by sea electrodes. It is rated at 450kV D.C. and been in operation since 1994, over a distance of 250 km.

The only assertion in relation to any effect of EMF on ships, is contained in a paper by Ohman [Ref 4.11]:

“the FenoScan power transmission cable which is a mono-polar HVDC cable located between Sweden and Finland in the Baltic Sea. At full power the current is 1600 amps, with the return current fed through the Baltic Sea. The magnetic field generated is strong enough to influence ships’ compasses.”

While this assertion has been made, our research turned up no other citations to substantiate the statement.

4.3.3 Further Explanations of EMF

In a bipolar DC system with two parallel conductors, the magnetic fields of the currents in the forward and return conductors are counter-rotating Figure 4.17 (left). The two fields are superimposed on one another, and if the distance between the two conductors is small, then they will cancel one another out and the resulting magnetic field will be zero at a certain distance from the cable if the forward and return currents are equal. For the coaxial cable the superposition of the magnetic fields is totally integrated, the resulting magnetic field around the cable surface will be zero, Figure 4.17 (right).

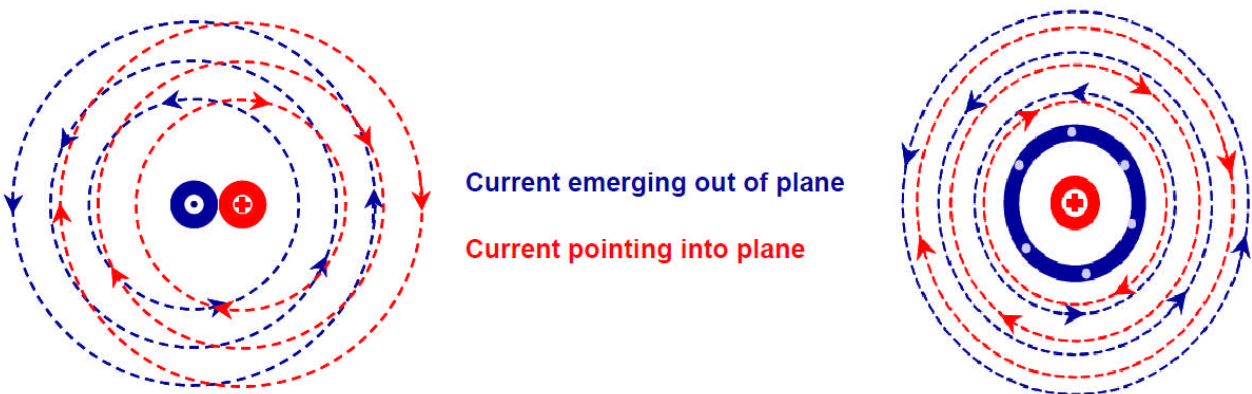

Figure 4.17: Magnetic field around a parallel bipolar cable (left), with currents in opposite directions, and around a co-axial cable (right), with opposite currents in the inner and outer conductors.

For the parallel bipolar cable at a certain distance the resulting magnetic field is zero, due to the superposition of the two counter-rotating magnetic fields. For the co-axial cable the resulting magnetic field is zero, due to the superposition of the two counter-rotating magnetic fields [Ref. 4.10].

In three-phase AC systems, the magnetic field around the cable is also zero, as the sum of the currents in the three phases is zero at all times [Ref. 3.2].

A \$600,000. study by COWRIE has shown that there was no detectable effect of the EMF on sea creatures, either positive or negative [Ref. 4.12].

Since the magnetic fields of all types of submarine power cable except monopolar D.C., are either small or zero, it may be concluded that the electromagnetic fields of submarine cables for offshore wind power will not have any significant effects on the marine environment. Since the most likely plan for the early wind farms are likely to be AC and bundled 3 phases in the same cable, or bipolar DC cable, there is agreement that this type of cable has no EMF consequences to the environment, or navigation.

In conclusion, several studies conducted by Denmark, the United Kingdom, and Greenpeace found the effects of EMFs on the marine environment to be negligible except for monopolar DC cables.

4.4 Cables for Floating Wind Turbine Application



Figure 4.18: Floating Power Plant www.floatingpowerplant.com potentially proposed offshore Oregon.

It is anticipated that in some areas of the USA floating wind farms will be the preferred option. Several concepts have been put forward including Spar based (Hywind), the one proposed for offshore Oregon, as shown in Figure 4.18, and several vertical axis wind farms notably proposed for offshore Hainan Island. Floating offshore wind farms has also been the focus of research with an alliance to promote wind farms offshore Maine [Ref 2.4].

Changes may be necessary for the power cables to floating wind farms. One example may be to the sheathing used in the electrical cable design. For floating wind farms where there is likely to be frequent motion of the vessel a copper sheath may be preferred to the lead ones now generally in use since the material is resistant to fatigue, being very malleable, and would be preferred to a lead sheath which has a low tolerance of large bending deflections. Aluminum sheaths may also be investigated as part of the cost-benefit tradeoff when selecting the appropriate cable.

Umbilical power cables have been used for electric dredgers for a long time: the manufacturers of these special purpose cables are the same as those that would be providing on the submarine cables for wind farms. Lifetime experience with their cables in protected waters is presently about 6 years before changeout although the advanced technology may extend that time period to 10-15 years. The advice of those operating dredgers suggest it may be prudent to have a subsea connecting point underneath the floating unit to allow for a changeout of any cable if it became necessary. The cable used for electric dredgers is typically double armor with a polyurethane protective on the outside. The biggest problems have been on the splice or the internal wires and seawater coming into the armor which causes corrosion and finally failure of the armor [Ref. 4.17].

4.5 Cable Type Selection Summary

Cable Type and Selection has been explored. It is most likely that the cable selected for Offshore Wind Farms on the OCS will involve 36 kV cables in-field and initially to shore when close in. As the fields move further offshore a gathering platform (transformer platform), will step up the voltage to HVAC and export cable(s) will transport the electricity to shore. As offshore wind farms move yet further offshore and HVDC equipment becomes cheaper the gathering platform will step up the voltage and also change to HVDC to transmit the electricity a greater distance to shore.

Armoring is necessary to hold the tension loads during installation, and for protection of the cables from external vessel threats, from rock abrasion, and to counteract unsupported lengths of cable.

From cable design considerations, the burial depth of a minimum of 1 meter was determined from a number of requirements (mainly one of heat dissipation) extending to possibly 2 meters+ for HVDC cable, and beyond this value increased burial is not recommended, considering the cable issues alone, since the current capacity continues to degrade with depth.

It is recommended that detailed calculations be provided for heat influences on the design of the cable, in the site-specific soil, looking at the interactions with cables, pipelines that it may be parallel to or cross.

With the exception of monopolar DC cables there was no effect found from EMF, and thus it is recommended that justification for EMF considerations be omitted from design considerations except if monopolar DC cables are proposed.

4.6 References

- 4.1 Leonard L. Grigsby, "The electric power engineering handbook" CRC Press in cooperation with IEEE.
- 4.2 D. F. Warne, "Advances in high voltage engineering" Institution of Electrical Engineers.
- 4.3 Grainger, W., Jenkins, N., "Offshore windfarm electrical connections," Proceedings of 20th BWEA conference, Cardiff, September 1998. Available at: http://www.owen.eri.rl.ac.uk/documents/bwea20_46.pdf.
- 4.4 Mike Bateman, Heerema Fabricators presentation to the Society of Petroleum Engineers, Houston, Sept. 2009.
- 4.5 Sharples, M. Wind Farm/Turbine Accidents and the Applicability to Risks to Personnel and Property on the OCS, and Design Standards to Ensure Structural Safety/ Reliability/ Survivability of Offshore Wind Farms on the OCS, BOEMRE Report, www.boemre.gov/tarprojects/633.htm 2010.
- 4.6 Catastrophic Failures in Mooring Systems Possibly Put Floating Structures at Risk, BOEMRE Safety Alert # 296, May 2011, http://www.gomr.boemre.gov/homepg/offshore/safety/safealt/SA_296.pdf.
- 4.7 Danish Offshore Wind: Key Environmental Studies, Published by DONG Energy, Vattenfall, The Danish Energy Authority, and The Danish Forest and Nature Agency, November 2006

- http://193.88.185.141/Graphics/Publikationer/Havvindmoeller/havvindmoellebog_nov_2006_skrm.pdf.
- 4.8 CEMACS at University of Liverpool, UK & ECONNECT LTD, A Baseline Assessment of Electromagnetic Fields Generated by Offshore Windfarm Cables - An Investigation of EMF Generated by Subsea Windfarm Power Cables”, 2003.
 - 4.9 Federal Maritime and Hydrographic Agency (BSH), Design of Offshore Wind Turbines December 2007.
 - 4.10 Greenpeace: Offshore Wind Energy - Implementing a New Powerhouse for Europe, (Grid Connection, Environmental Impact Assessment & political Framework0, March 2005.
 - 4.11 Öhman, M.C., Sigray, P., & Westerberg, H. (2007). Offshore windmills and the effects of electromagnetic fields on fish. *Ambio*, 36, 630-633.
 - 4.12 Gill, A.B., Huang, Y., Gloyne-Philips, I., Metcalfe, J., Quayle, V., Spencer, J.; Wearmouth, V. (2009). COWRIE 2.0 Electromagnetic Fields (EMF) Phase 2: EMF-Sensitive Fish Response to EM Emissions from Subsea Electricity Cables of the type Used by the Offshore Renewable Energy Industry. Commissioned by COWRIE Ltd (project reference COWRIE-EMF-1-06). http://www.offshorewindfarms.co.uk/Assets/COWRIE_2_EMF_FINAL_REPORT_Combined_09.pdf accessed June 4, 2011.
 - 4.13 Broussard B., Impcorp, ‘Specifying Cable System Reliability’, Pure Power, June 2007.
 - 4.14 Ocean Energy Magazine September 2010.
 - 4.15 Offshore Engineer October 2010.
 - 4.16 Normandeau, Exponent, T. Tricas, and A. Gill. 2011. Effects of EMFs from Undersea Power Cables on Elasmobranchs and Other Marine Species. U.S. Dept. of the Interior, Bureau of Ocean Energy Management, Regulation, and Enforcement, Pacific OCS Region, Camarillo, CA. OCS Study BOEMRE 2011-09.
 - 4.17 Private Communication courtesy of Damen Dredging, Netherlands.
 - 4.18 Tom McNichol, "AC/DC: the savage tale of the first standards war", 2006 Published by Wiley Imprint.
 - 4.19 Balog G., Potential Cost Savings on Submarine Cables, BWEA28, Glasgow Oct. 2006 (Nexans).

5.0 SPECIAL CONSIDERATIONS

5.1 Installations in Seismically Active Areas

Although there are some techniques to minimize the effect of faults on the submarine electrical cables, by distributing extra cable along the fault line as part of the route selection, there may be locations where eliminating the risk in extreme quakes is simply not feasible. Determination of the amount of extra cabling along the fault line, geared to the anticipated movement across the fault line, needs to be determined for each potential site.

Some history of earthquakes and wind farms in California give some insight. In June 1992 two earthquakes subjected 3000 turbines in the Palm Springs area to earthquakes of 7.3 magnitude (with epicenter 15 miles away), and another of magnitude 6.4 about 40 miles away. Almost all the turbines were shut down and the turbines survived. There was a common effect of impact on the foundations which had indications of some 12 inches displacement during the event. No reports of cable damage were received as far as could be ascertained.

The Japanese Tsunami event of March 2011, and the Indian Ocean Tsunami event of 26 December 2004 has raised public awareness of the ability of extreme tsunamis caused by massive earthquakes, to devastate a wide area. The news reports stated that the wave heights in Hawaii due to the tsunami were 1 meter.

There are only a few detailed studies on seismic impact on submarine cables, and those that are there relate mainly to telecommunications cables and those involving mud-slide areas, often in deepwater. Telecommunications cables are smaller are not as robust as electrical cables. In order to understand the seismic issue and how it might affect offshore wind farm submarine cable it was important to look at the historical record.

In deepwater the impact of the tsunami is small. The height of the tsunami wave is small but it is a very long series of waves travelling at high speed and so the volume of water moving is substantial. In shallow water as the wave propagates towards the shore the height of the wave increases as the bottom friction causes the height to increase. In the action on the soil of the bottom friction wave approaching shore in shallow water and of the water receding from the shore creates the potential for scour. This is an effect which should be considered when selecting the burial depth for the shore approach.

5.1.1 Newfoundland 1929

The Newfoundland earthquake of 1929 broke a series of trans-Atlantic telephone cables by triggering a massive undersea mudslide. The earthquake was centered on the edge of the Grand Banks of Newfoundland, about 400 kilometers (250 mi) south of the island. It was felt as far away as New York and Montreal. The quake, along two faults 250 kilometers (160 mi) south of the Burin Peninsula, triggered a large submarine landslide. It snapped 12 submarine transatlantic telegraph cables and led to a tsunami that arrived in three waves, each 3 to 4 meters high that struck the coast at 105 km/h (65 mph) about three hours after the earthquake occurred. The tsunami was recorded along the eastern seaboard as far south as South Carolina. It was suggested that ruptures to the submarine cables were mainly due to seabed displacement induced by fault movement, submarine landslides and

seabed soil liquefaction etc., and a turbidity current which is similar to earthquake induced mud-rock flows on land.

5.1.2 Hengchun Earthquake near Taiwan 2006

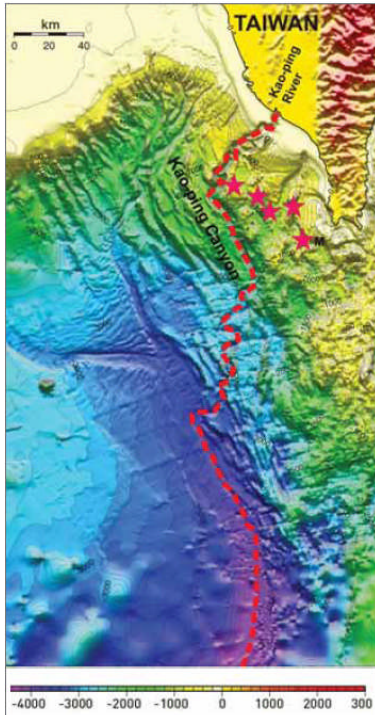

The 2006 Hengchun earthquake (magnitude 7.2) on December 26, 2006 rendered 9 telecommunications cables near Taiwan inoperable disrupting telecommunication services in various parts of Asia. The repairs took approximately 3 weeks.

Referring to Figure 5.1 the earthquake and aftershocks (pink stars) set off several submarine landslides off southern Taiwan. These slides transformed into fast-flowing mud-laden currents that sped down Kao-ping submarine canyon (red dashes) into a deep-ocean trench: a distance of over 300 km. The 9 cables broken en route, disrupted international communications for up to seven weeks [Ref. 5.1].

Following the earthquake, studies were undertaken to calculate the effect of movement on the cables. The conclusion of the studies that followed was that the fault displacement of the Hengchun earthquake was 2.68 meters. The crossing angle of the fault and the submarine cable was 90° which is not optimum [Ref. 5.2].

Figure 5.1: Map of Taiwan area Illustrating the Cable Break Issue

5.1.3 Other Seismic Events and Discussion of Potential Effects on Submarine Cables

Seismic induced mudslides were triggered by an earthquake, off Papua New Guinea, and the resultant turbidity currents disrupted telecommunication cables at least 280 km away in water depths of over 6,600 meters due to current speeds of 30–50 km/hr. Such an event would not be relevant to an offshore submarine power cable in that most likely the cable would be buried and not on the surface of the seabed, or in such deep water. More recently, cables were damaged off Algeria, following the 2003 Boumerdes earthquake (magnitude 6.8), when landslides and turbidity currents damaged six cables to disrupt all submarine networks in the Mediterranean region. Earthquakes were also the cause of the damage for the communication cables and a major earthquake and tsunami in December 2004, in the Indian Ocean caused big damages to the underlying telecommunication cables. These are fiber optic cables and not buried (larger and robust) electrical cables, and thus far more vulnerable to damage.

Numerous other seismic events some with tsunamis have been chronicled in a paper by Bershader et al. [Ref. 5.3].

5.1.4 Historical Seismic Events in the US

In the US, the Aleutian Islands earthquake occurred in 1946. It was followed by a Pacific-wide tsunami (magnitude 7.8), with its epicenter at 52.8°N, 163.5°W. It resulted in 165 casualties (159 people on Hawaii and six in Alaska) and over \$26 million in damages with destructive waves at heights ranging from 45 – 130 ft. coming in, multiple at a time. It obliterated the Scotch Cap Lighthouse on Unimak Island, Alaska and killed all five lighthouse keepers. This prompted the creation of the Pacific Tsunami Warning Center in 1949. The tsunami was unusually powerful for the size of the earthquake and is believed to have been caused by the seismic event triggering an underwater landslide.

The 1964 Alaska earthquake began across south-central Alaska resulting in ground fissures, collapsing buildings, and tsunamis causing about 131 deaths.



Figure 5.2: The largest landslide in Anchorage occurred along Knik Arm between Point Woronzof and Fish Creek, causing substantial damage to numerous homes in the Turnagain-By-The-Sea subdivision. [Ref. 5.5].

Figure 5.2 is illustrative of the point that it is beyond reason to expect a submarine cable to be designed to survive such an upheaval when the entire region is a national disaster of enormous proportions.

5.1.5 Seismic Design Considerations

Portions of the coastal waters of the United States are located in seismically active areas and it is necessary to give consideration to protect against earthquake ground movement. As for most other types of facilities, it is not warranted and normally not economical to design of submarine power cables that can preclude any possible damage from the most severe earthquake imaginable. The design provisions usually made in the codes are for the maximum displacement from an earthquake of 1/1000 year magnitude when the structure itself is designed to 1/100-year return period.

As a perspective on acceptability of a design, society regularly accepts to risk to pipelines in the Gulf of Mexico even though they are subject to movement and failure in hurricanes on a regular basis. Multiple pipelines were damaged in mudflow areas in Hurricane Ivan as just one example [Ref. 5.4].

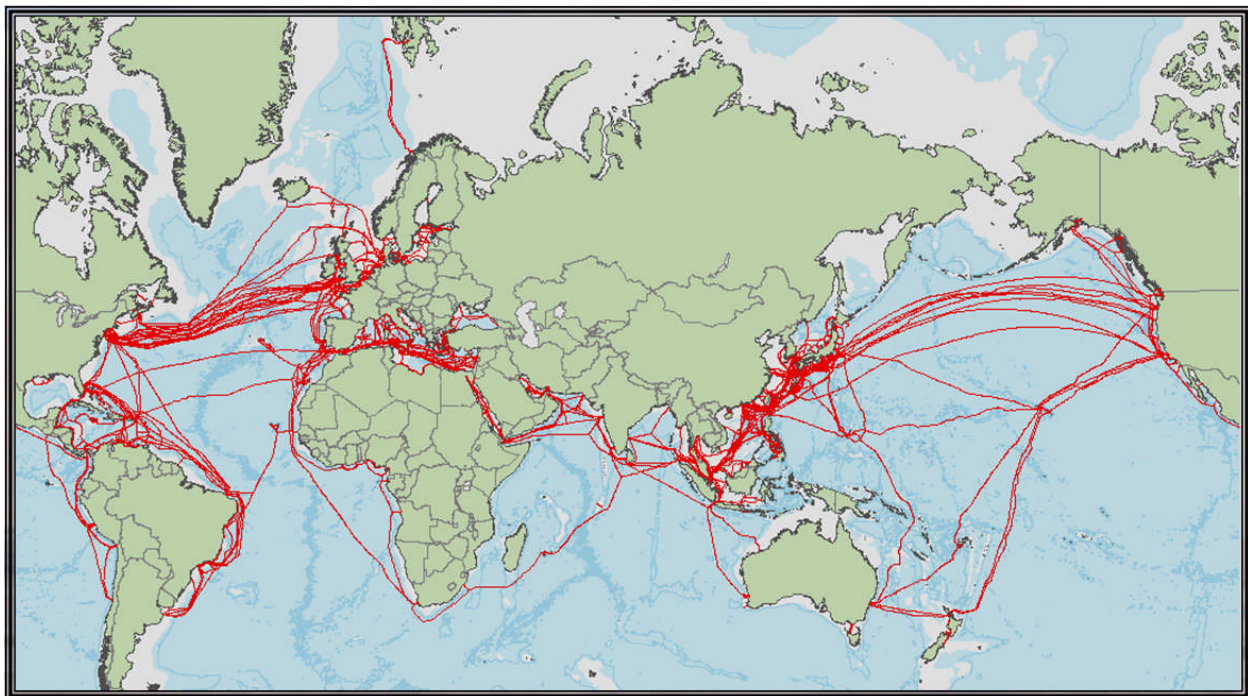

Figure 5.3: International Offshore Cable Routes (from Global Marine Systems Ltd.) currently in use. [Ref. 5.6].

Figure 5.3 shows the offshore cable routes coming into the United States. The literature was scoured for articles related to any recent submarine cable failures coming into the United States either on the east coast, or on the west coast (more likely), but none were found.

The most likely effects on submarine cables may come from earthquakes sourced in the US or from tsunamis formed in the Pacific. Tsunamis are most prevalent in the Pacific Ocean and may affect the west coast and Hawaii. Hawaii has its own earthquakes and the historical record reflects that the worst occurred on April 2, 1868, when 81 people lost their lives. With a magnitude of 7.9 and generated a 15-meter high tsunami along Kilauea's south coast [Ref. 5.6].

Tsunamis seem unlikely to affect installations along the relatively geologically inactive Atlantic coasts. Earthquakes do occur on the east coast but are thought to not be a major issue for offshore wind farms. An earthquake near Bar Harbor, Maine, was noted as a Richter magnitude of 4.2 [Ref. 5.8]. A recent study by University of Maine [Ref. 2.4], reported: “Maine is located within the North American plate and experiences “interplate” earthquakes, not plate boundary earthquakes like those that occur in California, which cannot be correlated with known faults. Generally Maine earthquakes seem to break on a different fault every time.The impact of this geohazard is likely minimal.”

5.1.6 Seismic Areas of United States

The following two figures show the seismic areas of the United States.

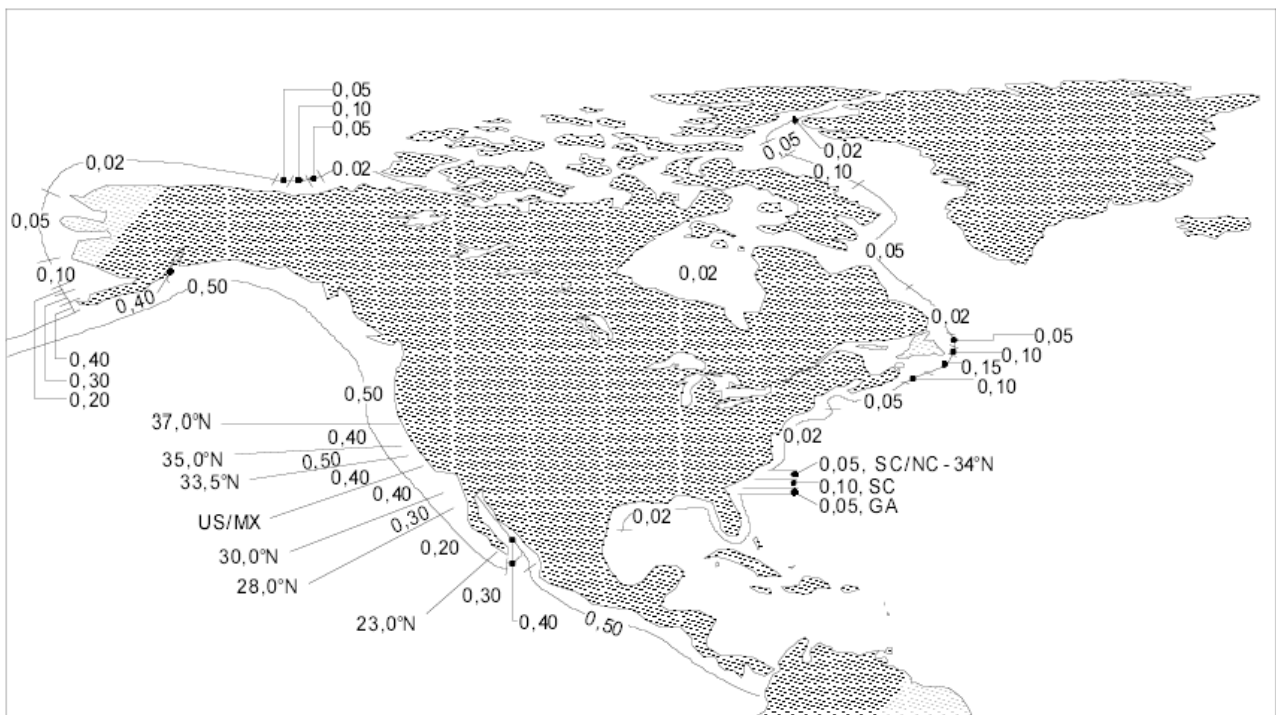

a) 1,0 s oscillator periods

Figure 5.4 (a): 5% damped Spectral Response Accelerations for offshore North America

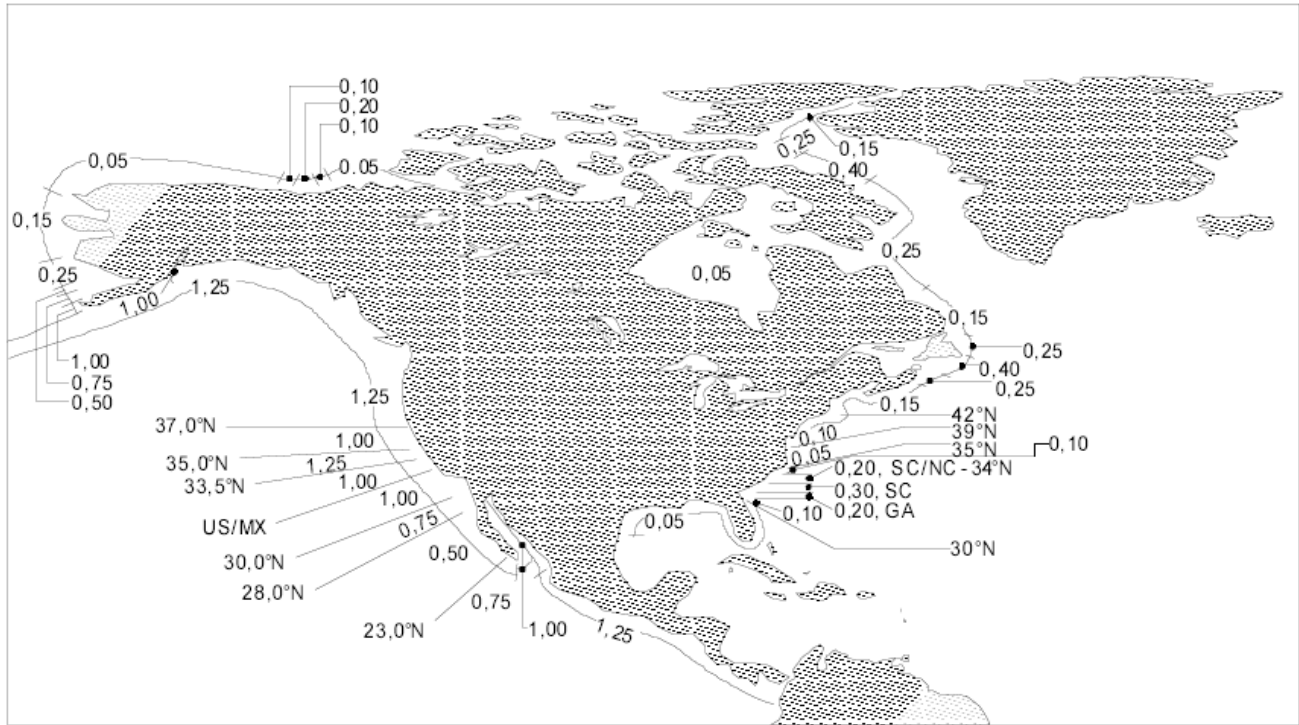

b) 0,2 s oscillator periods

Figure 5.4 (b): 5% damped Spectral Response Accelerations for offshore North America

Key: US/MX – US-Mexico border SC South Carolina NC North Carolina GA Georgia

Figure 5.4 gives generic 5 % damped spectral accelerations, in g, for bedrock outcrop for a 1.0 second oscillator period and for a 0.2 second oscillator period, respectively, for determining the site seismic zone of an area and for use in the simplified seismic action procedure in ISO 19901-2 [Ref. 5.16].

The return period selected for the development of these ground motion maps is 1/1000 years.

Based on the definitions referred to in ISO 19901-2 and the purpose of that document to avoid life-safety and major pollution issues, this would usually not apply to submarine cables. Since the definition of risk may be different for submarine cable in the regulatory context, it is recommended that due account be taken of any areas where the accelerations are above 0.2 seconds in these charts as a judgment call from consideration of the points in the document. Thus in the presented charts with the possible exception of South Carolina on the East coast, all US offshore wind farms on the east coast should not need to consider seismic implications in depth unless anomalies show up in the route surveys. The west coast, which must consider this design case throughout the entire west coast including Alaska.

Seismic risk charts are given in API RP2A standard for fixed offshore platforms which although an older document shows a similar pattern of areas where risk is high and those where risk is low.



Figure 5.5: Seismic Risk in U.S. Coastal Waters (0 is low, 5 is high)

5.1.7 Mitigating Actions for Seismic Areas

From the studies in the literature it seems that in each of the submarine cable failures to date, they have all been less robust telecommunications failures, were not buried and occurred in deep water or in situations where they had been laid in mudslide areas down the slope of the continental shelf.

Submarine cables for windfarms are for the foreseeable future going to be laid close to shore buried and unlikely to be located in areas in mudslide areas (i.e. Mississippi Delta).

Except for anomalies that arise in the site specific studies, with the exception of South Carolina it is concluded that the need for seismic considerations in the Atlantic east coast offshore wind farms are minimal. The consideration for West coast wind arms and any other seismic areas a series of mitigations are proposed below, where based on the studies researched, it was concluded the performance of submarine cables can be enhanced by:

- avoiding direct fault areas where a large displacements could occur when selecting the submarine cable route;
- allowing excess length of the submarine cable if areas of strong seismicity cannot be avoided, and laying it in the direction of the fault line;
- constructing a secondary cable with an alternate route for important submarine cables;
- developing detailed earthquake emergency plans for the submarine fiber optic cable if separate from the main electrical cable; and
- setting up a submarine earthquake monitoring and emergency repair plan.
- improving the deformation capability of the submarine cable (design of armoring);

The tensile strength of a submarine cable is mainly provided by a number of armor steel wires. Two-layer armored cable is generally used for telecommunications cables in shallow waters to protect against anchoring and fishing. The reader will note that Greater Gabbard only provides one layer of armor. In areas of high seismic risk it will be important to calculate the worst expected displacement in a seismic event, and balance that with armoring considerations, the spare cable (and location) and the ability of the electrical cable to stretch so as to advise the stakeholders and regulators of how robust the system is against a potential fault.

There is little doubt than in a severe earthquake sufficient to sever the cable that the turbine towers would probably have failed before a submarine cable event would prevent transmission [Ref. 5.9].

The ASCE published guide with the American Lifelines Alliance a public-private partnership to reduce risk to utility and transportation systems from natural hazards: Guideline for Design of Buried Steel Pipelines, July 2001 is a helpful instructive reference [Ref. 5.10] and other useful references are given at the end of the chapter [Ref. 5.11], through [Ref. 5.15].

Earthquakes have been a significant feature in telecommunications cables but electrical cables are more robust and situated in circumstances where damage is much less likely, e.g. avoiding mudslide areas. It is concluded that extreme earthquakes where ground upheaval is significant there are no reasonable mitigations that can completely avoid damage. For smaller quakes where ground displacement is an issue then the mitigation of laying spare cable parallel to the direction of the fault line can minimize the probability of damage.

5.1.8 References

- 5.1 Submarine cables and the oceans: connecting the world, International Cable Protection Committee
- 5.2 Earthquake Engineering & Engineering Vibration (2009) 8:159-164 Response analysis of a submarine cable under fault movement, Liu Aiwen Institute of Geophysics, China Earthquake Administration, Beijing 100081, China.
- 5.3 Bershader S., Erickson M., & Palmer H, Submarine Geohazards vs. Fiber optic Telecommunications Cables: No Contest!" Suboptic Conference 2010.

- 5.4 Pipeline Damage Assessment from Hurricane Ivan in the Gulf of Mexico, DNV Report to MMS, 2006.
- 5.5 http://en.wikipedia.org/wiki/1964_Alaska_earthquake
- 5.6 International Cable Protection Committee (ISCPC) (2009). "A Short History of Submarine Cables." Information. Telstra, ISCPC. <http://www.iscpc.org>
- 5.7 USGS <http://earthquake.usgs.gov/monitoring/anss/regions/hi/>.
- 5.8 The 2006-2007 sequence of Earthquake at Bar Harbor, Maine, Seismological Research Letters; May/June 2008; v. 79; no. 3; p. 457-468; 2008 Seismological Society of America.
- 5.9 OTH561 - Guidelines for trenching design of submarine pipelines
www.hse.gov.uk/research/othpdf/500-599/oth561.pdf
- 5.10 American Lifelines Alliance, Guidelines for the Design of Buried Steel Pipe, July 2001
- 5.11 DNV OS-F-101 Submarine Pipeline Systems, 2000.
- 5.12 Aiwen, L. (2009). "Response Analysis of a Submarine Cable Under Fault Movement." Earthquake Engineering and Engineering Vibration 8: 159-164. Abstract only not yet purchased
- 5.13 Canada Standard Z19901-2-07 Seismic Design Procedures
- 5.14 Fine, I.V., A.B. Rabinovich, B.D. Bornhold, R.E. Thomson, and E.A. Kulikov (2005). "The Grand Banks landslide-generated tsunami of November 18, 1929: preliminary analysis and numerical modeling." International Journal of Marine Geology, Geochemistry and Geophysics. 215: 45-57.
- 5.15 Cable Safety, UK Cable Protection Committee UKCPC.
- 5.16 ISO/FDIS 19901-2:2004 Petroleum and natural gas industries – Specific requirements for offshore structures – Part 2: Seismic design procedures and criteria.

5.2 Sand Wave Effects on Route Selection

5.2.1 Overview of Sand Wave Issue

Placing a cable in an area of sand waves is somewhat of a challenge both in terms of initial installation and in terms of maintenance.

The term sand waves is often applied to features that range in size from ripples (less than about 4 inches high) which are a function of grain size and bottom current orbital velocity to large sand waves which are 5 ft. to 75 ft. high with a wave length of 100 ft. to 1000 ft. or more. A recent report stated “New seismic-reflection data show that large sand waves near the head of Wilmington Canyon on the Atlantic Outer Continental Shelf have a spacing of 100–650 m and a relief of 2–9 m.” [Ref. 5.17].

There is evidence of sand and gravel features migrating and 2-12 m per year due to large scale synoptic currents driven by Nor'easters offshore Maryland [Ref.2.4].

The characteristics of the sand itself, and distribution of grain sizes, coupled with the metocean environment, wind, wave and current dictate the characteristics that can cause sand waves to occur. The development of meticulously accurate soils information is crucial to the evaluation of likelihood of sand wave movement.

Sand waves form because the sand grains have roughness which creates turbulence as water flows over the soil surface. The drag on a soil particle gives an uplift force which may exceed the weight of the particle, in which case it is transported along the seabed. Relatively slow flow speeds can generate sufficient turbulence to move sand particles along the seabed. Gravel particles, however because their weight is heavier than the uplift force over the gravel's surface, tend to be more stable on the seabed. The propensity to move, related to grain size has been illustrated in the Hjulström curve. Named after Filip Hjulström (1902–1982), the graph Figure 5.6 is used by hydrologists to determine whether an area will erode, transport, or deposit sediment. The dotted line is the critical erosion velocity line: minimum current velocity before the particles are eroded. The solid line is the critical deposition velocity: minimum current velocity before the particles are transported [Ref. 5.19].

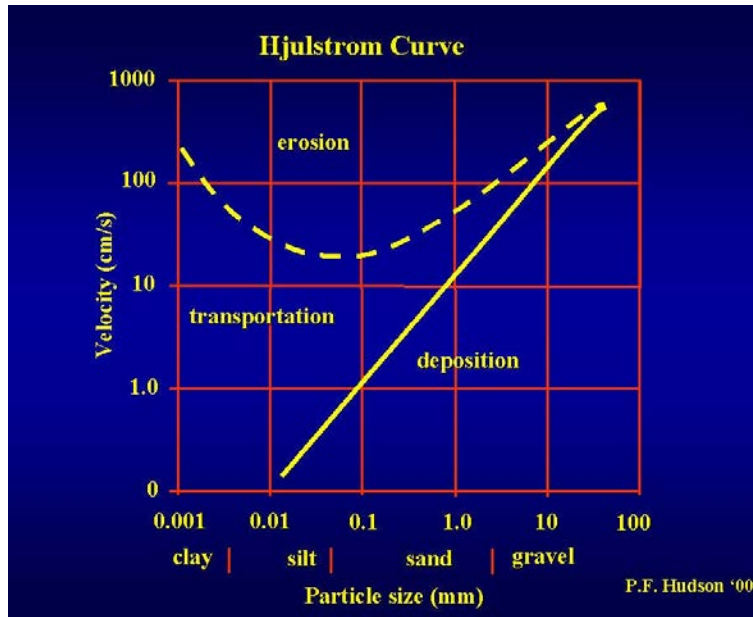

Figure 5.6: Diagram showing the relationship between stream velocity and ability to transport material of varying sizes.

Note that gravel (larger than 4 mm) needs a higher velocity to be moved because of size and weight. The fine silts and clays (smaller than 0.06 mm) also need higher velocities for movement because they stick together cohesively. Sand (between 0.06 and 2 mm) is relatively easily eroded and moved. As the sand moves along it tends to ride up and over the sand that is ahead of it creating a wave, and a small eddy current is created as sand reaches a pinnacle leaving the well-known asymmetrical (forward pointing) shape one sees in the small sand waves at most sandy beaches.

5.2.2 Installation Issues in Sand Waves

If the cable is laid by plow, then as the plow makes its way over the crest of the sand wave, depending on length of the plough, distance between forward and back sleds and location of the plowshare, the burial depth changes as the plow proceeds. This occurs because of the mismatch of length of plow and length between sand waves: in the area of the crest of the sand wave the resulting burial depth may be shallower than the plow is configured for and in the trough may be deeper than the plow is configured for depending solely on the geometry of the plow.

In the process of laying the cable over the sand wave, the plow is likely to leave the cable at a much lower burial depth than the nominal “flat terrain” prescribed cable depth. If the lay tension is high on the downslope it is likely to pull the cable out of the seabed on the downslope. Trough erosion may add to this exposure issue.

The two most robust ways to solve the issue of the cable security in a sand wave area is to remove the sand waves on the route of the cable completely and bury the cable below the depth at which the sand is no longer mobile by using a plow with a greater depth capability taking the cable past the normal erosion depth. Plows are available to achieve a burial depth of 4 meters but beyond this depth there are only a very few plows and the burial deeper than this may become economic.

5.2.3 Mitigating Actions for Sand Waves

There is no standard solution for a protection design suitable for sand waves. Therefore, a design can only be made on a case by case basis. [Ref. 5.18]

During the construction of the Nuon OWEZ wind farm offshore the builders encountered sand waves up to 4 meters in height in 18 meters of water depth and these moved at the rate of 6 meters per year.

After a number of issues that arose offshore Netherlands where the mobility of the seafloor sediments and sand waves re-exposed previously buried cables, engineers have developed calibrated models of movement of sand waves and these may be used to predict the risk at a particular location.

Depending on the situation there are several approaches to the problem:

- Sweeping the seabed flat prior to installation and bury the cable the burial amount below the anticipated trough of the sand wave: if the sand waves are reasonably high >2-3 m this is often not considered an economic solution. Dredging or jetting tools can sweep the sand waves flat, however the cable lay and burial operation must follow quickly behind the sweeping operation before the trench fills in.
- Increase the nominal burial depth in the area of the sand waves to minimize the anticipated time between exposures.
- Protecting the cable against the movement of sand waves after installation: rock can be used to stabilize the area and this slows, but does not stop the issue if the sand wave is moving: the sand waves will spread engulfing the rock berm and then over time lower the rock berm as the trough of the sand wave passes, but the cable itself does not get exposed; The rock cover dimensions and grading can be adapted to allow erosion of sand from under the rock cover. This will result in a gradual lowering of the rock cover including the cable as the crest of the sand wave recedes. Once the lowest point is reached, accretion will bury the rock berm until some other sand wave trough will re-expose and potentially further erode the sand from under the berm. The volume of rock and initial geometry to be placed has to be considered carefully based on details of the sand wave characteristics to allow the reshaping of the berm without losing the protective function.
- Maintain the burial depth requirement by continual and frequent remediation. The ability to maintain the burial depth on a continuing basis is an economic one and would be dependent on availability of vessels, weather windows when this mitigation method can be used, and frequency of remediation, all of which are very site-dependent parameters.

5.2.4 References

- 5.17 Knebel H.J., Folger D.W., Large sand waves on the Atlantic Outer Continental Shelf around Wilmington Canyon, off Eastern United States. U.S. Geological Survey, Woods Hole, 1976.
- 5.18 Allan P.G. Cable Security in Sandwaves, ICPC Plenary Meeting, Copenhagen, May 2000.

5.19 Baker & Ritter, Competence of Rivers To Transport Coarse Bedload Material, Geol. Soc. Am Bull. 1975; 86: 975-978.

5.3 Separation Distances

5.3.1 Vertical Separation

Providing a distance between submarine electrical cables crossing one another, crossing telecommunication cables, or crossing pipelines is a subject that can be imagined to be of serious concern from potential interference from electrical activity, cathodic protection systems etc.. From the research carried out there was very little information available, and from what there was reflected that other than a concern with an issue of heat effects, there appears to be no other technical issues arising from proximity of a submarine electrical cable to other submarine cables, telecommunication cables or pipelines.

On the issue of vertical separation there is a minimum amount of technical advice written in the literature on this subject, and very little guidance as to the specific rationale behind the recommended distance of separation. The appropriate distances for pipeline crossings is noted in the regulations and there may be no better guidance available for cable / pipeline crossings.

30 CFR §250.1003 Installation, Testing, And Repair Requirements For DOI Pipelines.

(a)(1) Pipelines greater than 8-5/8 inches in diameter and installed in water depths of less than 200 feet shall be buried to a depth of at least 3 feet (1m) unless they are located in pipeline congested areas or seismically active areas as determined by the Regional Supervisor.

(a)(3) Pipelines shall be installed with a minimum separation of 18 inches at pipeline crossings and from obstructions.

It is understood that, at the time of writing, the minimum separation distance is intended to be reduced in the CFR to 12 inches in the future.

In Europe generally a minimum physical separation of 12 inches between pipelines and/or cables is specified. There is little concern about electromagnetic interference: telecom cables comprise glass fibers, and high voltage power cables usually carry three AC-cores (canceling out electromagnetic currents), and wrapped with shielding armoring wires [Ref 5.20].

DNV F-101 for pipelines requires a Separation distance 0.3 m (12 inches). [Ref. 5.21].

ABS pipeline requirements state as follows: [Ref. 5.22]:

Pipeline crossings are to comply with the design, notification, installation, inspection, and as-built requirements of the regulatory agencies and the owners or operators of the pipelines involved.

API 1111 states the following for pipeline crossings [Ref. 5.23]:

7.3.2.3 Pipeline Crossings

Pipeline crossings should comply with the design, notification, installation, inspection, and as-built records requirements of the regulatory agencies and the owners or operators of the pipelines involved. A minimum separation of 12 in. typically using sand-cement bags or concrete-block mattresses should be provided.

The effect of cathodic protection from pipeline to pipeline in a crossing situation was set out in a BOEMRE research project. As part of the research project, appropriateness of the present MMS (BOEMRE) regulation that requires a minimum separation distance of 18 inches between crossing marine pipelines was addressed and it was concluded “*It is highly unlikely, however, that such corrosion would be influenced by pipeline separation distances that typically exist at a point of crossing (several inches to several feet).*”[Ref. 5.24].

The National Electrical Code [Ref. 5.26] gives the following information on industry practices in radial separation from other underground installations:

“Separations between supply and communication conduit systems. Conduit systems to be occupied by communication conductors shall be separated from conduit systems to be used for supply systems by not less than

- a. 75 mm (3 in.) of concrete*
- b. 100 mm (4 in) of masonry*
- c. 300 mm (12 in) of well tamped earth*

EXCEPTION: lesser separations may be used where the parties concur.”

In relation to proximity of high pressure pipelines however the recommended distance is greater:

Made grounds or grounded structures should be separated by 3.0 m (10 ft.) or more from pipelines used for the transmission of flammable liquids or gases operating at high pressure [1030 kPa (150 lb./in²) or greater] unless they are electrically interconnected and cathodically protected as a single unit. Grounds within 3.0 m (10 ft.) of such pipelines should be avoided or shall be coordinated so that hazardous ac conditions will not exist and cathodic protection of the pipeline will not be nullified.

RECOMMENDATION: It is recommended that calculations or tests be used to determine the required separation of ground electrodes for high-voltage direct-current (HVDC) systems from flammable liquid or high-pressure gas pipelines.

NOTE: Ground electrodes for HVDC systems over 750 V may require greater separation.

Experts on pipelines do not express strong opinions about interference with cables and pipelines.

Existing pipelines are the most common problem for designers. One pipeline can cross another one, but it is not practicable simply to lay the second pipeline across the first. A crossing has to be carefully designed so that neither pipelines damages the other, there is no undesirable interference between two cathodic protection systems, and neither is overstressed

or destabilized by hydrodynamic forces. One simple options is to trench the first pipeline more deeply at the crossing point, lay mattresses over the first line to provide physical separation to prevent coating damage and separate the cathodic protection systems and then carefully lay the second line over the crossing point..... The number of crossing should be kept to a minimum, and the crossing should be at right angles.

“Vulnerable submarine cables crisscross many areas of the sea floor. The usual way of crossing a cable with a pipeline is to sever the cable first, lay the pipeline through the gap, and then splice the cable and lower it back over the pipeline. This is an expensive operation and should be avoided if possible.” [Ref. 5.27].

An interesting technical review of a power cable installation within the Harmon, Hudson and East River with multiple crossings as permitted by the Corps of Engineers:

For fiber optic/telecommunication crossings, the Applicant states that a minimum separation between the Project’s submarine cable and the existing telecommunication cables will be provided by installing a protective sleeve on the cable at each crossing. The protective sleeve will extend for approximately 50 and 80 feet on each side of the crossing point.

For gas and oil pipeline or power cable crossings, the Applicant states that the submarine cables will cross the existing infrastructure as close as possible to right-angles, extending for approximately 300 feet on each side of the crossing point. For deep-buried pipelines or cables, a protective sleeve will be applied to the submarine cables at each crossing to provide a minimum separation between the submarine cables and the existing infrastructure. The sleeve will be installed for up to 80 feet to either side of the crossing location

For shallow buried pipelines, the Applicant states that a minimum separation between the submarine cable and the pipeline will be provided by pre-installing a 150 mm-thick grout-filled mattress on top of the infrastructure at each crossing. The submarine cable and pipeline will be post-lay protected by further placement of grout-filled mats or articulated concrete mats [Ref. 8.17].

5.3.2 Cable Protection at Vertical Crossings

In Europe the vertical separation of cables/cables and cables/pipelines for offshore wind farms is usually achieved by placing a concrete mattress at the crossing location over the existing line, prior to laying the new line. The concrete mattress ensures long term physical separation, irrespective of seabed movements. The protection is illustrated in Figures 5.7 – 5.10.



Figure 5.8: Concrete mattress in place protecting pipeline from cable laid above it.



Figure 5.7: ROV deployment of concrete protection

Bridges over top of existing cables configured in such a way as the bottom cable can be retrieved and repaired if necessary is another technique which is heralded with success.

Figures 5.9 and 5.10 give variations of the concrete bag and mattress protections.

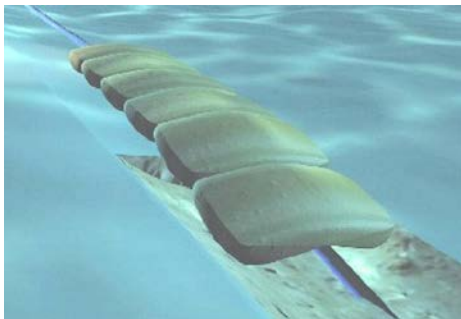

Figure 5.9: Concrete Bags Protection

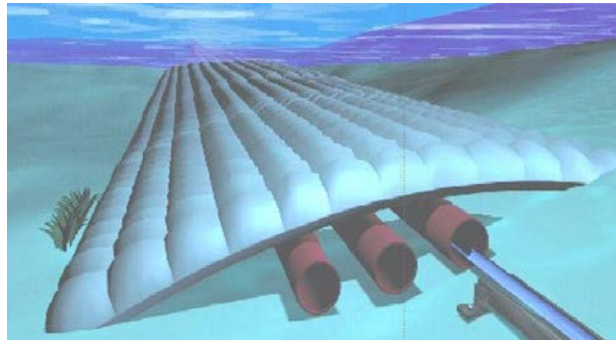

Figure 5.10: Mattress Protection

Other advice on electrical supply line separation is available from a Report of Best Practice with the Common Ground Alliance.

When installing new direct buried supply facilities in a common trench, a minimum of 12 inch radial separation should be maintained between supply facilities such as steam lines, plastic gas lines, other fuel lines, and direct buried electrical supply lines. If 12 inches separation cannot be feasibly attained at the time of installation, then mitigating measures should be taken to protect lines against damage that might result from proximity to other structures. Examples may include the use of insulators, casing, shields or spacers. If there is a conflict among any of the applicable regulations or standards regarding minimum separation, the most stringent should be applied [Ref. 5.25].

5.3.2 Horizontal Separation

Horizontal distances between cables usually is dictated by ensuring lack of interference when one cable is being repaired, or to assure redundancy if one cable is severed. For the former, a distance of 20 ft. is a considered minimum to allow vessels to retrieve and repair one cable while not interfering with another, however this may not be enough for the redundancy issue which is more an engineering judgment having reviewed the probability of failure from external sources.

The issues with horizontal separation to avoid navigation risks is discussed in Section 7 of this Report.

Germanischer Lloyd provides the following “certification guidance” for separation [Ref. 5.30]:

The distance between parallel running cables to be 2 times the waterdepth plus laying depth to allow future cable repair;

Cape Wind, for example, is proposing 20 ft. separation distances between its two export cables [Ref. 5.31].

On the issue of horizontal separation the following quotation puts this into a commercial /liability avoidance context:

“AT&T would use the industry standard “2 times the water depth” or, 164 feet (50 meters) minimum separation, in parallel sections (with existing cables) that are laid in deep water (beyond depths at which cables can be recovered by divers) in order to provide system security and an adequate margin for repair operations if required. A minimum separation of twice the water depth is necessary and adequate to ensure that cable repair operations do not run the risk of violating international and federal law for showing “due regard” for cables belonging to others. In particular, the United Nations Convention on Law of the Sea (UNCLOS) Article 79 (Submarine Cables and Pipelines on the Continental Shelf) stipulates that: “When laying submarine cables or pipelines, states shall have due regard to cables or pipelines already in position. In particular, possibilities of repairing existing cables or pipelines shall not be prejudiced.” In addition, UNCLOS Article 114 and the U.S. Submarine Cable Act (U.S. Code [USC] Title 47, Chapter 2) impose liability on cable companies that damage other cables in repair operations.” [Ref. 5.28].

5.3.3 Non-Technical Issues

A non-technical issue of some concern may be the negotiations of crossing agreements. Although cooperation is the order of the day in most marine circumstances it may not be easy to spark negotiation between the developer wishing to lay an electrical cable and the owner of an existing pipeline or cable. Between telecom companies, arrangements of crossing agreements are negotiated around the world on a cooperative manner based on the understanding that the roles of each telecom company may be reversed at some point in the future in another location, so it is of mutual benefit to cooperate. That is not, however, the case with submarine electrical cables. This may give rise to contractual issues of submarine electrical cables crossing existing pipelines and existing telecommunications cables and the resolution may not be simple. ICPC [Ref. 3.37] has pro-forma agreements on their website for use in this process. Generally the first permittee does not have exclusive rights to the “crossing area”, but does have the right that their pipeline/cable not be

disturbed or adversely affected without compensation. In other words the second applicant might need to bury deeper make the crossing at a different location or propose an alternate solution where the first permittee is not adversely impacted without compensation.

It is recommended that this area be studied by the regulators for the future benefit of facilitating development of offshore wind resources.

5.3.4 Separation Distance Recommendations

Figure 4.12 illustrates the temperature contours around a pair of submarine cables on the left and a pipeline on the right with a 50° C surface temperature. The x-axis is horizontal distance in meters, y-axis vertical depth below seafloor in meters (cables are at about -1 m depth), and numbers in the diagram is the temperature rise above the seabed temperature in °C [Ref. 3.36]

Subject to the provisions of ensuring by calculations that the combinations of the cable /cable or cable/pipeline do not raise the temperature past the design points of the cables/lines, the following separation distances are recommended:

- A minimum horizontal separation of 20 ft. is recommended for parallel cables or combination of pipeline and electrical cables. Any lower horizontal separation distance may be evaluated by providing detailed calculations. Acceptance of a lower value should be subject to a risk analysis if there is an extraordinary potential consequence of a high pressure gas line failing, or a potential pollution event.
- A minimum vertical separation of 12 inches is recommended for crossings of electrical and telecommunications cables. Crossings of high pressure gas lines should be evaluated by calculation for determination of this value being sufficient. Acceptance should be subject to a risk analysis if there is an extraordinary potential consequence of a high pressure gas line failing, or a potential pollution event.
- If more than one cable is provided to offer redundancy for the export cables, it is recommended based on research outlined in Section 7 that a spacing of a minimum of 200 yards be used for planning purposes, however, a final proposed separation distance should come from a formal Navigation Risk Analysis. This recommendation is based upon the notion that in 100+ yards from dropping an anchor if left with slack chain, would either stop the vessel or break the chain in either case within 200 yards it would have a very low probability of severing a second cable.

5.3.5 References

5.20 Ploeg A., Ovento- Private Communication.

5.21 Offshore Standard DNV-OS-F101, October 2010 Sec.5 – Page 41.

5.22 ABS Guide for Building and Classing Subsea Pipeline Systems and Risers 2001, Chapter 3 Design Section, 6 Routing, Installation, Construction and Testing 3-6.

5.23 Recommended Practice for the Design, Construction, Operation, and Maintenance of Offshore Hydrocarbon Pipelines FOURTH EDITION, DECEMBER 2009.

- 5.24 Retrofit Cathodic Protection of Marine Pipelines Associated with Petroleum Production, <http://www.boemre.gov/tarprojects/242/242ab.pdf>
- 5.25 Report of Best Practice of the Common Ground Alliance (www.commongroundalliance.com).
- 5.26 National Electrical Code IEEE – C2 2007.
- 5.27 Subsea Pipeline Engineering by Andrew Palmer and Roger A King, 2nd Edition, Penn Well Publishing 2008.
- 5.28 AT&T Asia America Gateway Project)
www.slc.ca.gov/division_pages/depm/depm.../AAG_Attachment_1.doc
- 5.29 Technical Review Report (ESS) of the Application of Champlain Hudson Power Express, Inc., for a Certificate of Environmental Compatibility and Public Need.
- 5.30 Germanischer Lloyd Guidelines for the Certification of Offshore Wind Turbine Structures, 2005.
- 5.31 Analysis of Effects of Wind Turbine Generator Pile Array of the Cape Wind Energy Project in Nantucket Sound (Final Pile Report_05-128)
www.boemre.gov/offshore/PDFs/CWFiles/05.pdf

6. ROUTE SELECTION

Route selection must consider a number of factors which are intertwined:

- considerations of cable design, installation, burial depth, and lifetime;
- considerations of installation vessel based on water depth, geological information, permissible cable stresses, burial depth/cable protective measures;
- weather for installation;
- potential cable protection from scour and navigation risk.

Waterdepth – The deeper the water the more loads the heavy power cable has to absorb during installation, supporting its own weight, all the way to the seabed together with the catenary weight, horizontal load and the installation vessel's dynamic motion.

Rocky Shores – Sharp rocks need to be eliminated from proximity to the cable. On the exit route of the cable from shore this may be done either by drilling-in and encasing the cable path or by other means of protecting the path to a distance where the cable is not subject to damage i.e. with a rock shield around the cable, or other plastic protections. The amount of protective armoring of the cable itself can be adjusted but this is often insufficient mitigation and if the entire route is not subject to sharp rocks it can be an unjustified expense for the total cable length. Any motion of the cable against the rock either during installation or during operations (in the unlikely event that the cover may be washed away) will lead to abrasion and ultimately a repair issue. In some areas the rocky shores may be covered by granular materials, but it is always important to be assured that there are no underlying rocky features that can impact the cable. Steep slopes also make it difficult to secure the cable against vertical movement after placing, and in some cases it may be necessary to find some means of securing the cable to the location (some broad cable ties) without providing local stresses to damage it.

Scour – The shifting of sand/ gravel by currents, tides, and surf action may lead to the cable being exposed and then itself be subject to motion of the waves, movement in currents and exposure to human activities in the same area e.g. marine vessel anchoring. Examples of this have arisen in several locations in European wind farms. In hurricane regions it is best to keep in mind that the scour potential may be there but would only materialize in a sizeable hurricane which may not be frequent. So it is important to look at the long-term potential of scour.

The method to assess the potential of scour requires the following information:

- A bathymetric survey to identify sand waves;
- Samples of surface seabed soils (to assess particle size distributions);
- Assessment of seabed currents;
- Analysis, including model tank tests, to assess potential for scour.

Boulder Fields – Boulders can impact the trenching activity and the best plan is to avoid them, however, if it can be substantiated that the boulders will not move in wave action even in extreme storms, then moving them slightly from the path may be an option. Being very sure that there are

none hidden on the route, perhaps, by providing a burial assessment plow to pull along the route at an early stage, would give confidence that the cable laying can take place safely.

Marine Slope Instability – Although it seems unlikely that submarine cables will be laid in areas where there is marine slope instability which occurs typically at the mouth of river mouths with potentially unstable sediments (such as the Mississippi) it is nevertheless something to be cautious about. Generally marine slope instability results from infrequent severe weather (hurricane), or a seismic event. Slow moving rivers that are depositing mud mixed with silt as they reach the ocean providing mounds that can liquefy under the cyclic loads of larger than normal waves. (This works much like thixotropic paint which appears of medium penetrability until the can is shaken when it turns almost immediately to liquid). Sometimes the seabed is significantly deeper after an event where tens of feet are washed away. The experience of pipelines and fixed platforms in the area of the Mississippi delta have been described in the literature [Ref. 5.4].

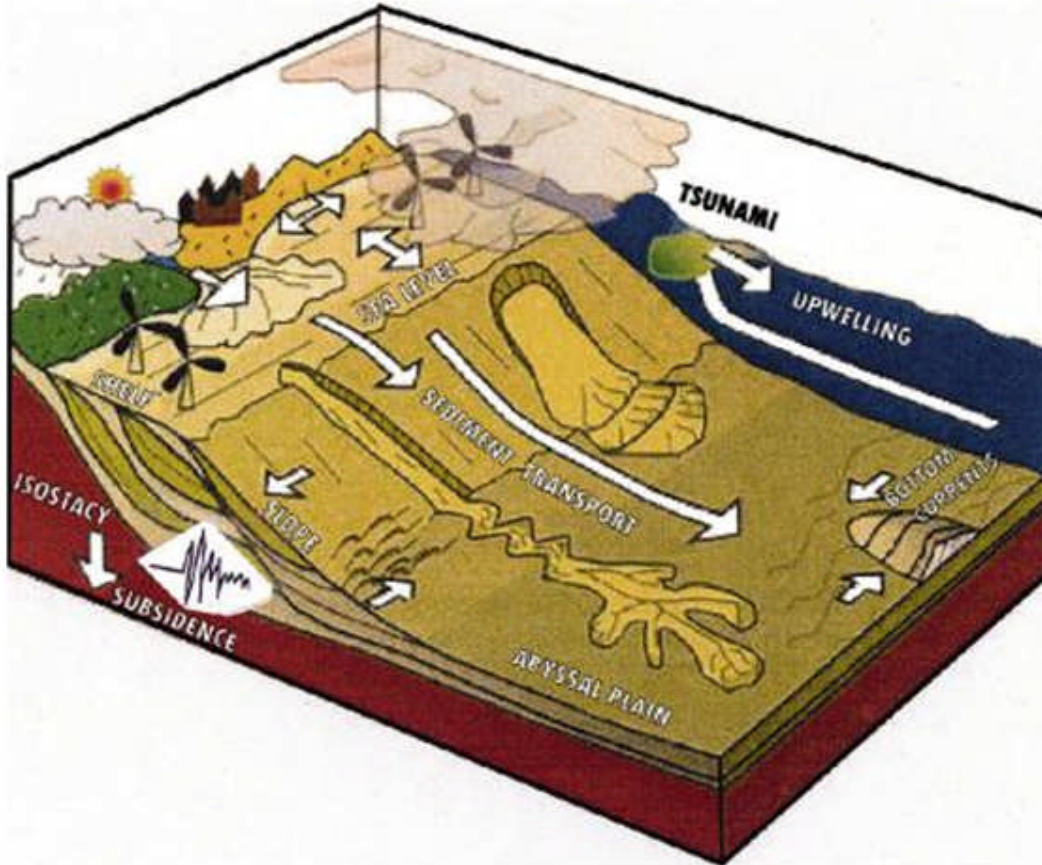

Figure 6.1: Cartoon examples of various geohazards.

The seismic event illustrated at lower left in Figure 6.1 illustrates how this can trigger these geohazards. Note the slope instability on the right is beyond the anticipated area where offshore wind farms are likely to be sited [Ref. 6.1].

Incompetent Soils - Areas which are incompetent to support cables (which may also be subject to Marine Slope Instability), need to be regarded with caution. Unsupported lengths of cable will be subject to high stress, and if the cable penetrates the soil to large distances then the external cooling of the cable may be insufficient leading to a rise in the operating temperature of the cable and the breakdown of the protective materials. Soil with a large amount of organic material is likely to be declared incompetent.

Soil Properties – The properties of the soils themselves, and any dumping, particularly of organic waste in the area, may affect the thermal protection offered by the cable design. It is thus important to know the thermal resistivity of the soil and consider the fact that during the burying process those properties may also be changed. Soil types with high organic content have poor cable cooling and thus finding out about this before cable design means that the design engineer can change the size of the conductor accordingly [Ref. 6.2]. This can be anticipated by carrying out laboratory tests of remolded soil material. Any corrosive properties of the soil, or any gas seeps which may be corrosive, also need to be taken into account.

Ice - Offshore Maine or Alaska and other northerly states there will be a need to offer extra protection against ice loads, particularly for rafting pack and ice in the surface and subsurface zone. Knowing how ice forms particularly in the area of the cable landing may determine the optimum cable route depending on whether the cable is to be buried or drilled at the shore landing.

Physical Objects – It is often surprising how much debris in both type and size is on the seabed, often close to shore, that is not charted or defined. Disposal areas or toxic chemical dumps if not marked may also be a hazard to be discovered. As offshore wind farms go further offshore the size and amount of the debris may be more of an issue as it is normally ignored if it is not a depth hazard to shipping. NOAA tries to chart some of these but there are many items that are not charted. Other pipelines, power cables, communications cables, effluent outfalls, sometimes abandoned ones are often not effectively well charted and it is hard to find definitive documentation.

Archeological Sites - Preservation of historical and archaeological sites may be important but are not the subject to be dealt with in this document but may determine the selection of the route.

Local Ocean Use -In order to carry out the risk assessment prior to design it is usual to carry out interviews with local fishermen, tour-guides, sailors and commercial shipping. These interviews may determine particular features of the local environment which make a route inappropriate. Such interviews cannot be overemphasized as it would determine customary and alternate routes of the vessels, and the gear that may impact the cable locations. Photos and videos should chronicle the fishing gear and fishing techniques of the region. An understanding of the expectation of how the fishing, or other uses may change as a result of the wind farm (and thus change the undersea cable risk), is important so as to gain an understanding: fishermen may respond of their intention to fish close-by the turbine structures, and their attitude to a potential exclusion zone may be important to understand.

Initial Planned Route – The shortest cable route from A to B will not always be the most technically suitable or cost effective solution as illustrated in the Figure below.

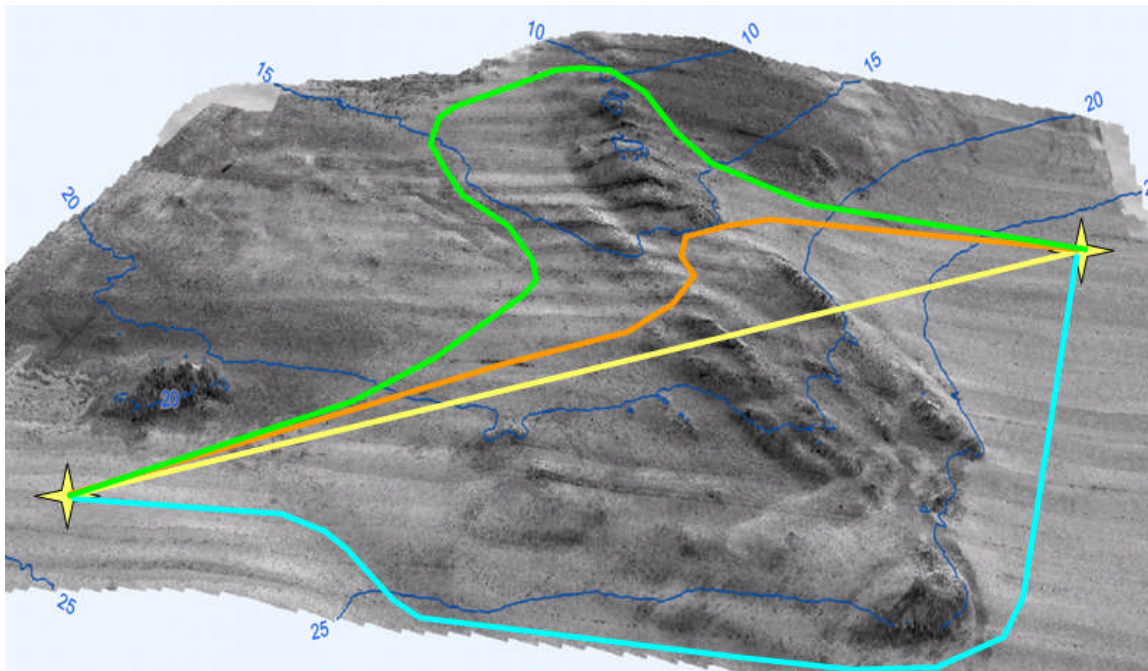

Figure 6.2: Four Alternates Routes from one location to another as a function of topography.
[Ref. 5.10]

The straight line in Figure 6.2 would have provided a minimal cost based on amount of cable required but would have been faced with potential free spans of unsupported length which vastly increased the probability of failure.

Outlining what is necessary for a particular installation is first decided with a Desktop Study.

6.1 Desktop Study

The desk study brings together all the existing, and researched information so as to identify clarifications and deficiencies which plan the field campaign. The desk study should collect and review all relevant data for the site and route, for example:

- Bathymetric information- charts, and surveys from harbors;
- Anchorage areas, shipping fairways, normal shipping routes, pilot boarding location, seabuoy etc.;
- Geological information – rock outcrops, mudslide areas;
- Existing geotechnical (soils) data and information from possibly other surveys in the area;
- Information on existing cables/ pipelines etc. ;
- Meteorological and oceanographic information (metocean) including tides, currents, wind and wave regimes;
- Information on wrecks and debris on seabed; NOAA databases including Automated Wreck and Obstruction Information System (AWOIS) [Ref: 6.3].

- Seismic activity maps and any records of seismic activity;
- Archeological and chemosynthetic communities – that it may be necessary to avoid;
- Information from USCG databases of incidents and near misses of shipping in the area, dropped equipment;
- the Navigation Risk Assessment, if available at the time of the desktop study,

Desktop studies should include additional information such as seabed, restricted areas, military activities including restricted military activity areas, etc. The London Array in UK, for example, needed to carry out a search of the area for unexploded bombs, being the location where World War II planes dumped their unused bombs before returning to home base. A preliminary view of shipping movements and fishing activities noting bottom impact considerations should be part of the desktop study

Potential sources for information and data sets include companies with proprietary data, national geological survey organizations, universities, and marine contractors.

A desk study helps provide the basis to design and plan site soil investigation work.

6.2 Metrocean Information

It is important to assemble the information on the extreme values of current and waves and determine how that may affect the cable along the route, and particularly at the shore approach. Breaking waves and sediment movement are important considerations, and are propelled by the metrocean phenomena at the location. Protective measures may need to be provided: the cost of protection may very well preclude certain shore landing sites.

A key point for consideration for the hurricane prone areas is that these storms happen frequently but not in the same location or at the same strength. The standard that is met for the oil and gas infrastructure in the Gulf of Mexico with its frequent hurricanes is a record of 50 recent years, with consideration given to the data over 100 years, the early part of which may not have as accurate measurements. The structures will be in place for 20+ years, and short term measurements are inappropriate alone, to long term response, particularly in areas of infrequent tropical revolving storms or other infrequent phenomena.

The measurement of waves and currents near the proposed cable route is recommended to calibrate the hindcast models to the local conditions. Strong waves and currents can change sea bed conditions in operations and provide conditions during construction preventing the use of divers and remotely operated vehicles. There may be the potential to select routes with better geographic features or where tides, currents, and winds allow a larger window for installation.

6.3 Route Assessment Field Survey

Guidelines issued by BOEMRE provide the minimum information required for field surveys [Ref. 2.14] and some important information about the anticipated reporting of information found.

While it is tempting to minimize the cost of the route surveys ahead of time, it is often the case that items show up during the installation that were not anticipated including wooden logs, and abandoned pipelines, or fishing gear/wire ropes etc. It is always better to spend the effort to detect these ahead of

time rather than waiting until you have a large cable laying spread of marine vessels there and then find these item(s) are tangled in the equipment, or that the route must be changed.

Since the eventual goal is to provide the information to confirm that the cable can be designed for its agreed lifetime, designed so that it can be installed by the available installation vessels, installed without damage to the appropriate burial depth, it is considered prudent for the cable designer and installer to be involved with the surveys and sampling carried out at an early stage in the project.

Without the designers confidence in the sampling the makeup of the cable may not be optimized for the route providing safer materials or amounts of material that may not optimize the design. Since the design factors may not be fully appreciated by the soils crew if information obtained is not perfectly clear to the designer then deficiencies in the cable design could result.

Without the installer's "blessing" on the locations to be sampled, techniques for sampling and investigation of anomalies, there is less confidence that the installer will know what equipment is needed for the job, and risk sharing for the installation activities may not be optimally shared. Although it is not typical for other offshore and marine projects to engage the designer or installer at such an early stage in the project, it is recommended for offshore windfarm submarine cables to minimize the overall technical risk as the project goes forward.

It is necessary to have complete coverage of the route, at least 300 m. wide [Ref. 2.14] for the entire length of the planned and alternate proposed cable routes using the tools described in Appendix C.

A Navigation Risk Assessment (Section 7) needs to be carried out in preliminary form prior to the field information being gathered. The highest risk from a shipping perspective is that of a dragging anchor from a ship of 10,000 tons or greater, and possibly a somewhat lesser size. This requires knowledge of the soil some distance along any well-used navigation route in an attempt to estimate the risk of a dropped anchor reaching the cable from the "most likely" position that an anchor drop could occur.

The tools for determining suitability of the route are many and the detail will vary somewhat depending on the hazards perceived. These tools and techniques for site survey have been described in Appendix C. The information can be summarized:

- Bathymetry survey – to confirm charts' information which is generally not sufficiently detailed
- Sonar survey –to understand the bottom and sub-bottom profile, potential sand waves, information on evidence of bottom currents
- Magnetometer survey – to provide information on metal objects including pipelines and pre-existing cables
- Geophysical survey – to provide soil type, strength, temperature, and temperature absorption capability
- Current survey

Some of these items may be combined into a "Burial Assessment" as described in Section 6.5.

The tools for determining suitability of the route are many and will vary depending on the hazards perceived.

Three types of material to be avoided when possible:

- bedrock (since it is difficult to trench and if undulating may lead to unsupported lengths of cable),
- very soft soil (due to the lack of support of suspended cable), and
- organic debris (which do not allow dissipation of heat from the cable into the seabed).

Two types of material to avoid when other options are easily available:

- Compacted sand and cohesive material are both more difficult to trench to the appropriate burial depth for protection.

The most preferred soil for submarine cables is sand and gravel of medium to medium-low compaction. Light equipment, jet plows, can be used to bury the cable into a muddy or sandy bottom. A selection of equipment is discussed in Section 8 on Cable Protection.

After selection and just prior to installation, running the burial assessment plow along without a cable present is one way, to confirm the route. This effort which still has merit is often substituted by electronic surveys of the route as an alternate option. Both techniques are referred to in the literature as “Burial Assessment Surveys”.

Another precaution prior to final installation is to run side scan sonar to pick up any items that have arrived on the route since the survey was carried out.

6.4 Burial Assessment Survey

The Burial Assessment Survey is a term whose definition has changed over time. At one time it referred to pulling a plow with no cable through the route to ensure that the cable could be installed. Nowadays it generally relates to a series of activities that involve a sled pulled along the seabed with some sophisticated instruments that effectively provide the same and additional information, though it is inferred from signals and computer manipulation of electrical signals.

6.4.1 Burial Assessment Survey by Pulling the Plow

The cable route can be proved by the technique of pulling a plow with no cable through the entire route to ensure that the trench can be completed to the correct depth. This method remains as the most positive proof of plow-ability directly. This tool provides real time data obtained for the penetration of the tool into the seabed plus sonar and visual data if camera systems are fitted. The plowing tool when used in conjunction with soil information, including some drop cores, and some grappling, historically provided a good assessment of the burial task. Figures 6.3 and 6.4 show two examples of different size plows that were pulled along to prove the route.

Towing forces for this activity are high and it is necessary to correlate the data developed during the route survey to understand the plow results. The data recorded (plow attitude, share penetration, towing force) are reviewed in the light of the geophysical survey results and conclusions drawn on

the burial feasibility. This approach has the shortcomings of cost (particularly of the powerful tow vessel), difficulty in interpreting some test results and lack of timely and efficient data integrated information [Ref. 6.5] & [Ref. 6.6].



Figure 6.3: Mini-Plow



Figure 6.4: Basic Assessment Plow

The “plowing assessment” survey is still undertaken on occasion. When used it is sometimes pulled along the route of the proposed cable well in advance of the scheduled cable installation work as part of the pre-survey operations.

Although such a situation is site-specific, objection could be made to disturbance of the seabed and thereby require some environmental permitting activity. If the plow is pulled and the cable laid allowing the disturbed soil to be jetted back into the trench subsequent to the installing plow following the same route a short time afterwards, then it may not be an issue. The advantage of separating the two activities in time, however, is that if there is an anomaly not picked up in the geotechnical survey, mitigation activities can take place to choose a detour to the route.

6.4.2 Burial Assessment Survey with Instrumented Sled

The information provided by route assessment field surveys is enhanced by use of an instrumented sled carrying out a burial assessment survey, which in turn needs to be correlated to physical coring tests in order to answer a number of questions about the cable design and burial activities:

- what is the appropriate burial method (e.g. plowing, jetting, trenching, others) and can the required depth be achieved?
- will the burial tool hangup or become unstable or have an increased risk of damage in some areas (thus requiring a backup available)?
- what is the anticipated speed that can be achieved as the cable is laid (for weather/ time planning)?
- what size vessel do I need as a function of speed of laying?
- as trenching proceeds does the soil fill-in or are alternate methods needed to backfill?
- what sort of armoring will be appropriate for the cable based on the soil characteristics?

The Burial Assessment Survey with an instrumented sled effectively combines many of the individual tools outlined in Appendix C into a single instrument. Several activities can take place continuously and concurrently using one sled towed through the proposed cable route, recording data, and providing most of the needed basic information for the burial depth requirement for the cable design and burial depth requirement from all but external threats. The group of activities encompasses providing information on:

- Seabed description;
- Seafloor Resistivity Testing/ Seismic Refraction;
- Hazards such as slopes, rock, boulders, coral, sand waves, soft sediment, pock marks;
- Mini-CPT testing;
- Cable or pipeline crossings;
- Current that may affect plow or ROV deployment;
- Computer analysis.

The seafloor resistivity testing and seismic refraction are more detailed and more accurate technique than the chirper or pinger surveys carried out for the initial route assessment. The advantage of a continuous survey from the instrumented sled means that it covers the entire route rather than depending on a sequence of snapshots along the route. Even small areas of mischaracterized seabed can cause significant downtime to repair a damaged plow or cable and perform recover, re-routing etc.



Figure 6.5: Typical Burial Assessment Survey Sled
[Ref. 6.9]

Figure 6.5 shows a typical modern Burial Assessment Survey Sled. The equipment aboard may vary from company to company.

Typically it is dragged along the seafloor cable route and a complete system may offer up to 3 primary data acquisition subsystems: direct current electrical resistivity and an ultra-high resolution, multi-frequency sub bottom profiler and a mini-cone penetrometer. They are usually designed to operate off a vessels-of-opportunity using standard handling equipment and deep sea coaxial cables. While land based systems using resistivity have been available the data quality was less than desired because of inadequate coupling of the electrodes to the ground. Put the system in water, towed along the seabed, and the electrode coupling is not an issue as the electrodes are surrounded by water, which is highly conductive. The in-place measurements of the electrical properties of rocks and sediments that comprise the cable route provide data from which the geotechnical properties of the material can be inferred. The DC electric current is injected into the sediment-water interface and measures variations in the electric field as this sensor array is towed across the seafloor. Changes in signal strength are related primarily to changes in the sediment porosity and thus can be used to infer lithological changes. For most geologic materials occurring in marine settings, the bulk electrical conductivity of the material is, to the first order, related to the material's porosity. The strong correlation between porosity and bulk conductivity exists due to the high specific electrical conductivity of the pore water as compared to specific conductivity of the sediment in the

environment near the sediment-water interface. Pore water is assumed to be in free communication with the overlying seawater and thus the electrical conductivity of pore water is assumed equal to the measured seawater conductivity and thus can be ignored in providing the differences between sediments.

Current technology allows this system to make continuous measurements of the conductivity of the sea floor to at least 3 meters. Two systems that were reviewed in the research employed an inverted Schlumberger array consisting of one pair of current (transmitter) electrodes, located nearest the center of array, and seven pairs of potential (receiver) electrodes symmetrically arranged over a 20m length of the active portion of the array. The data acquisition system provides a real-time display of apparent depth vs. apparent porosity/density. Post processing of the data provides true layer thickness vs. true porosity/density. The resistivity of the ambient seawater and the water depth are also measured and used in the calculations.

The computer system, provides data to a computer on the survey/tow vessel merging the data with the navigation system information. The addition of a Mini Cone Penetrometer (MCP) allows geotechnical measurements to be made of the soil characteristics. A hydraulic mechanism provides a thrust force of up to (typically) 1.5 tons to push the probe/tube into the soil and strain gauges mounted in the probe transmit the tip resistance and sleeve friction through wires in the tube to the data acquisition system. There is some dispute as to whether the MCP results compare as well as a full size CPT however it is beyond the scope of this study to delve too deeply into this issue: suffice it to say that MCPs are indeed used regularly with cable burial assessments.

The resistivity checked against the CPTs and any borehole information is the most advanced form of information that can be provided for the Burial Assessment. Review of actual project data after the burial has confirmed that the technique provides the appropriate information and can accurately predict the soil conditions, electrical resistivity of the soil for cable design, and identify burial issues.

Seabed seismic refraction is a method of acquiring high-resolution information of soil sedimentary structures where fine detail is required for shallow depths. A seismic source at the seabed is used to induce an acoustic pressure wave into the soil typically with an air gun. As the pressure wave passes through the soil layers, some of its energy is refracted along sedimentary boundaries before returning to the soil surface, where a hydrophone streamer picks it up. The seismic refraction method provides quantitative data (compressive wave velocities) of individual soil layers which are compared with geotechnical information from CPTs and/or cores taken at intervals along the route varying from 0.5 km to more than that. Thus burial conditions can be determined and the magnitude of towing forces of the seabed plows. The high-resolution seismic refraction system, GAMBAS®, is one technique used where the sled is dragged across the seabed complete with the seismic source, angular position sensors, pressure/depth and temperature sensors, tension meters for the tow cable.



Figure 6.6: GAMBAS – Tow Sled for Seismic Refraction [Ref. 6.14]

Figure 6.7 shows the correlation for a given forward force from a towline, how the pressure exerted by the plow can change and how the speed of progress changes as a function of the stiffness of the clay. Thus gathering the undrained shear strength accurately can determine how best to go about trenching. Changing from using a sled with a Jet Pressure of 1 vs. a sled with Jet Pressure of 2 increases the towing speed by a significant amount. As one example for 100 kpa shear strength from 52 m/hr. to 100 m/hr.

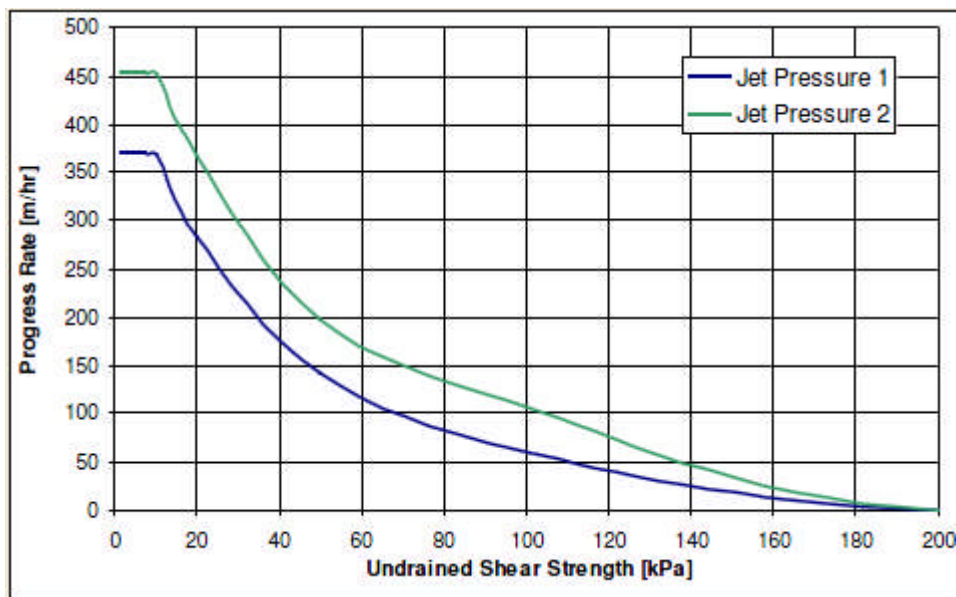

Figure 6.7: Progress rate as a function of undrained shear strength for 2 jet pressures.

The explanation of how these systems works can be reviewed in detail in Reference 6.10 [Ref. 6.10].

Current technology allows a set of electronic instruments which can take continuous resistivity data, or seismic refraction data to depths of 3-5 meters to be provided on a sled. Mini-CPT data can be taken from strategic points along the survey route.

The Burial Assessment Survey generally follows the study methods and sampling methodology outlined for the initial Route Assessment using the tools described in Appendix C. This additional information is needed to determine the geotechnical properties on a continuous basis to confirm the assessment of how easy or difficult it will be to trench the route.

The electrical resistivity test gives indications of variations in soil porosity and hence soil strength. It is particularly important to use the cores as a check against CPT interpretation. A good reference for the correlation issues on CPT vs. Cores is given in Reference 6.7 [Ref. 6.7].

Soils which prove hardest to plow are tentatively identified from cone penetration tests.

In cases where it is necessary to anchor the cable to the foundation, in a route with a steep slope, then modeling should be carried out to ensure both protection against the cable coming loose of the anchor and also against the anchoring straps damaging the cable ensuring there is a mechanism to have the anchor give way before damaging the cable [Ref. 5.1], [Ref. 6.8].

The frequency of Cone Penetrometer tests which may be done with gaps in the route survey, carries higher consequences than for the similar operation on pipelines. (Pipelines are easier to stop and start than a cable laying process- there is little consequence to laying down the pipeline; and little consequence of backing up and restarting a section and are generally only buried to 1 meter in offshore service [Ref. 6.11]).

The results of the Burial Assessment Survey should provide sufficient information to determine the best mechanism for installation: and if a plow is to be used, the best plow geometry and weight, together with the tow force required for the installation; if a jet plow is used to the pressure and volume of water to be provided.

The tow force is very dependent on the penetration of the plowshare tip and the soil characteristics. Both empirical relationships and theoretical models have been developed in order to predict the tow forces. Validation from a number of installations e.g. North Sea, and Irish Sea where burial of pipelines is quite customary due to the marine and fishing traffic and the legal system where the pipeline owner has a hard time to claim if a non-buried pipeline is hit, confirm the methods [Ref. 6.12], [Ref. 6.13].

An example of the one of the final products of the Burial Assessment is shown illustrated in Fig. 6.8. Note that the yellow area at the sea bottom is loose sand and the red area below shows dense to very dense sand. The dotted green line shows the route the cable will take buried at about 3 feet in this example. The CPT surveys are located along the route in confirmation of the findings.

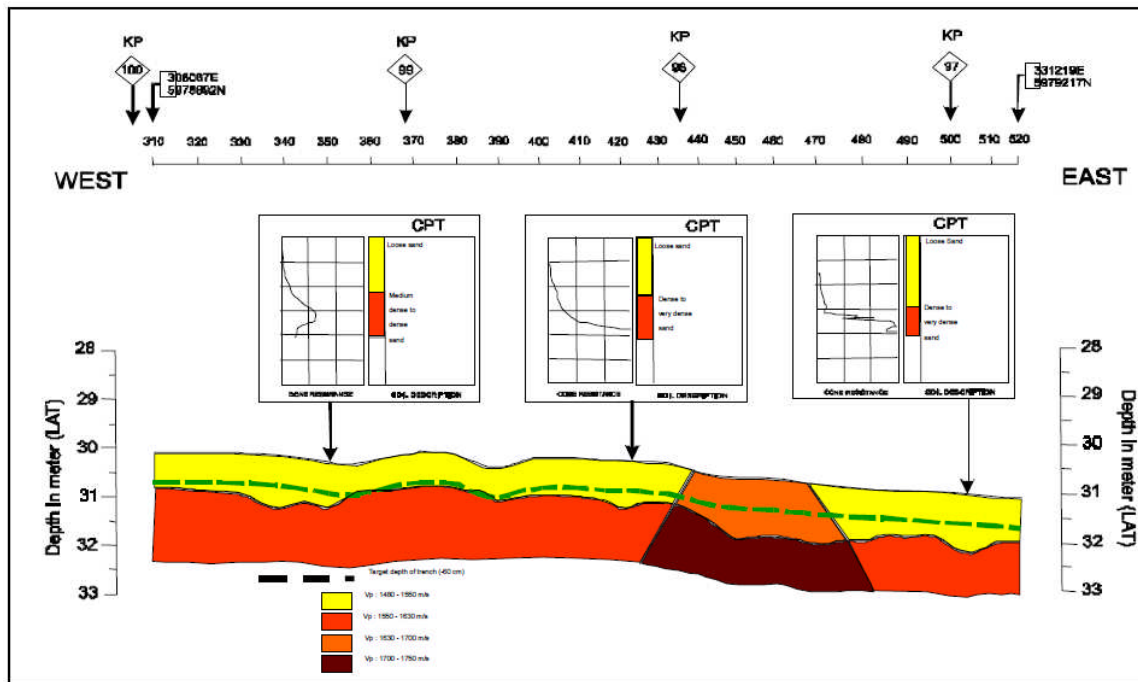

Figure 6.8: Burial Assessment Example Graphic Final Product
[Ref. 6.15].

6.5 Route Selection Summary

The route selection is determined by the optimum route to minimize distance with consideration of deviations to mitigate potential hazards along the route. A Desktop Survey is first performed, then a more detailed Route Assessment Field Survey and finally a Burial Assessment Survey. This information is sufficient to determine the likely route from “internal” issues, meaning from all but the external aggression dealt with in the Navigation Risk Assessment, Section 7.

The information developed by the techniques described both in the Route Assessment Field Survey and the Burial Assessment Survey provide input to design of cables and armoring, for confirmation of the potential burial depth, subject to accounting for external aggression. The information also provides sufficient data to determine the speed with which the cable can be laid and the selection of burial equipment.

6.6 References

- 6.1 Bershader S., Erickson M., & Palmer H, Submarine Geohazards vs. Fiber optic Telecommunications Cables: No Contest! Suboptic Conference 2010.
- 6.2 Abu-Hamdeh N H et al. (2000) Soil Thermal Conductivity: Effects of Density, Moisture, Salt Concentration and Organic Matter, Soil Science Society of America Journal, Vol. 64.
- 6.3 <http://www.nauticalcharts.noaa.gov/hsd/awois.html>.
- 6.4 McNeilan T. and Smith K.R., Seabed Scour Considerations for Offshore Wind Development on the Atlantic OCS, February 2011, www.boemre.gov/tarprojects/656.htm.

- 6.5 Allan, PG. “Geotechnical Aspects of Submarine Cables”, Proceedings of the subsea Geotechnics Conference”, IBC, Aberdeen 1998.
- 6.6 Noad J., “Successful Cable Burial – Its dependence to the Correct Use of Plough Assessment and Geophysical Surveys”, Conference Proceedings Offshore Site Investigation and Foundation behavior 1993, Society of Underwater Technology, London 1998.
- 6.7 CPT interpretation in marine soils less than 5m depth –examples from the North Sea R. Mitchell, S. Wootton & R. Comrie, SEtech (Geotechnical Engineers) Limited, Newcastle, England.
- 6.8 Puecha A, Tuenter H.J., Fugro, Continuous Burial Assessment Of Pipelines And Cables: A State-Of-Practice Paper OSIG-02-153, Proceedings Offshore Site Investigation and Geotechnics, 'Diversity and Sustainability', November 26 - 28, 2002, London, UK.
- 6.9 <http://www.wassoc.com/Upload/Specifications/cbass.pdf>)
- 6.10 Graham R.F., Williamson & Associates, Inc. An Introduction to Marine Electrical Methods: Towed Resistivity & Towed Induced Polarization Applied to Marine Geotechnical Problems *OTC-14143 2002*.
- 6.11 API 1111 - Design, Construction, Operation, and Maintenance of Offshore Hydrocarbon Pipelines (Limit State Design), Dec 2009.
- 6.12 Puecha A, Tuenter H.J., Fugro, Continuous Burial Assessment Of Pipelines And Cables: A State-Of-Practice Paper OSIG-02-153, Proceedings Offshore Site Investigation and Geotechnics 'Diversity and Sustainability', November 26 - 28, 2002, London, UK.
- 6.13 Correlation of Seismic Refraction Compressive Velocity and CPT Data With Particular Application to the Continuous Burial Assessment of Pipelines and Cables, Alain Puech A., Foray P., and Emerson M. OTC 14074.
- 6.14 Geotechnical & Geophysical Investigations for offshore and Nearshore Developments, International Society for Soil Mechanics and Geotechnical Engineering, September 2005.
- 6.15 Alain Puech et al, The use of surface waves in the characterisation of seabed sediments: development of a MASW system for offshore applications, Seatech Week, Brest, France October 2004.

7. NAVIGATION RISK ASSESSMENT

The Navigation Risk Assessment is necessary to determine the external threats from vessel traffic, including fishing, general shipping, and recreational uses, takes into account the anchor types, drag depths, and recreational usage for the area.

The U.S. Coast Guard requires an evaluation of the potential impacts of the proposed facility on the safety of navigation and, the traditional uses of the particular waterway [Ref. 2.10]. As such USCG calls for a Navigational Risk Assessment to be commenced at the time of the proposal and provides NVIC 02-07 for guidance on how to carry out the evaluation of the magnitude of the risks associated with the hazards and the effectiveness of the control measures that can be used to mitigate the risks.

The result of the Navigation Risk Assessment may change a proposed route, burial depth, cable armoring, traffic routing, warning signs etc. depending on the findings. A USCG specific recommendation is to investigate the effect of seabed cabling in electromagnetic fields.

While NVIC 02-07 contains little specific guidance for submarine cables, the techniques for a Navigational Risk Assessment for surface issues are very similar. Understanding the risks together with the Burial Assessment will find the optimum cable route which will give maximum security and safety to the installed cable whilst delivering the most economical solution for burial.

The questions to be answered for both the Installation and Operational phases of the submarine cable and for both the in-field and export cable(s) are:

- What regular historical and future planned traffic will potentially damage the submarine cable?
- What burial depth, armoring, or other cable design features are required to mitigate cable damage decreasing the probability of encounter with fishing gear, dropped or dragging anchors, or recreational vessel activity to an acceptable level?
- What, if any, effect will the submarine cable have on the navigation systems of ships and other marine craft in the area?
- What is the likelihood of ships dropping their anchors directly on top of the cable, or at a distance and direction that in local soil conditions it could penetrate far enough to be a threat to the cable(s), outlining the mitigation barriers to prevent the threat from actualizing?

Gathering the information is the first step in the process, and as advised by NVIC 02-07 para. 5f, the involvement of the Stakeholders should be part of the plan. Some of this interchange can occur as a result of gathering the information needed for the Risk Assessment.

7.1 Information Needed

The USCG specific recommendation is to investigate the effect of seabed cabling in electromagnetic fields is dealt with in Section 4.3 of this Report.

The information needed for the vessel threat to the cable can be divided into 5 or so categories to suit the area/port:

Marine & Industrial Vessels

- Traffic patterns
- Size and type
- Location of activities e.g. industrial vessels carrying out dredging.
- Size and type of Anchors on those Marine Vessels
- Locations where marine vessels may anchor
- Likelihood of the marine vessels being in a position near the submarine cable and in adverse weather deploying an anchor at the submarine cable location to slow the vessel down, dragging the anchor over the submarine cable location.

Fishing Vessels

- Traffic patterns of Fishing Vessels
- Size and type of Fishing Vessels
- Dimensions and types of Anchors on those Fishing Vessels
- Dimensions and type of Trawl Gear on those Fishing Vessels
- Type and size of Shell fishing gear

Recreational Vessels

- Traffic patterns of recreational vessels including yachts, motor boats, tour boats, anticipated to exist after the wind farm installation is complete

Military Vessels

- Traffic patterns
- Activities affecting the seabed

Communications Information

During the surveys with Stakeholders it is important to understand the different communications systems used by marine traffic in the area and to document this for future potential use in warning traffic, both during the construction phase, and later during operations either to prevent issues with vessels and cables, or to warn vessels in the vicinity of repairs.

7.2 Sources of Information

USCG NVIC 02-07 Enclosure 7 provides some guidance on maritime traffic and vessel characteristics to form the basis of the traffic survey. Much information needs to be assembled and the following discussion identifies most of those documents in order to research the issues completely.

The charts of the area should be obtained with marked pipelines, cables, vessel traffic control areas, location of AIS beacons (if any), etc. It is useful to have the latest available charts, and pilot books since those are customarily what a mariner may have available when navigating the region. The bathymetry will be on the existing chart, but fishing charts may exist for the region as well.

It will be important to establish whether or not there will be any measurable compass deflection anomalies in the area since it is important to know that ships will stay on track.

Since a drifting ship with no power is subject to the local currents, knowledge of these and the local tidal frequencies and tidal direction goes into the assembly of documents.

Wrecks in the area need to be known. NOAA keeps track of wrecks, many of which are on the charts but not the detail of what is known about them. This is available at the NOAA Database Automated Wreck and Obstruction Information System (AWOIS)

<http://www.nauticalcharts.noaa.gov/hsd/awois.html>. Research on wrecks may indicate the cause of wrecks and the location and history may lead to important local knowledge as well as they may be a hazard to the navigation during construction or to the vessels in transit in the region after installation.

Traffic movements may be tracked by a variety of sources.

- The US Army Corps of Engineers keeps a data system of traffic in and out of various US ports available at <http://www.ndc.iwr.usace.army.mil/>.
- Lloyd's List also tracks traffic and a traffic study can be purchased from them. Once the vessels are themselves identified and categorized it is possible to look their information up in Classification Society registers (Lloyd's, American Bureau of Shipping, and DNV) and the anchor size/weight is usually reported though not the type.
- USCG under its Port State Control program keeps track particularly of foreign flag vessels and inspects many of them on arrival in the US.
- Bureau of Transportation Statistics (BTS) of the U.S. Department of Transportation (DOT) keeps data on ships entering and leaving US ports and their cargo.
- Maritime Administration keeps statistics on various vessel types calling at US ports, and activities of US flag ships elsewhere: www.marad.dot.gov/data_statistics. Typical data kept includes:
 - Vessel Calls at U.S. Ports
 - Average Vessel Size per Call at U.S. Ports
 - Containership Calls at U.S. Ports by Size
 - Average Age of Vessels per Call at U.S. ports
 - Vessel Calls at U.S. Ports by U.S. Coast
 - Vessel Calls, Top 10 U.S. Ports
 - U.S. and Global Vessel Calls
 - Vessel Calls at U.S. Ports, U.S.-flag and Jones Act Fleets

- Average Age of Vessels per Call at U.S. ports, U.S.-flag
- ...and the Jones Act Fleet
- Jones Act Vessel Calls by U.S. Coast
- Lloyd's Marine Intelligence Unit, Vessel Movements Data Files, 2004-2009,
- London: Lloyd's Marine Intelligence Unit, 2004-2009. This source contains data for vessel port calls, ports and active fleets.
- Lloyd's Marine Intelligence Unit, Seasearcher, London: Lloyd's Marine
- Intelligence Unit, 2010. This source contains data for vessel port calls, ports and active fleets.
- Clarkson Research Studies, Clarkson's Vessel Registers, London: Clarkson Research Studies, January 2010. This source contains data on the characteristics of the world merchant fleets.

Ships are tracked globally through the Automatic Identification System (AIS). Since 2007 there has been a requirement (Regulation 19 of SOLAS Chapter V) all ships of 300 gross tonnages and upwards engaged on international voyages, cargo ships of 500 gross tonnages and upwards not engaged on international voyages and all passenger ships irrespective of size to use the AIS system (automatic identification).

The regulation requires that AIS shall provide information - including the ship's identity, type, position, course, speed, navigational status and other safety-related information - automatically to appropriately equipped shore stations, other ships and aircraft.

By identifying the closest port the internet provides access through <http://www.marinetraffic.com/ais/> the information about the various vessels in the vicinity a designated GPS system (near the coast).

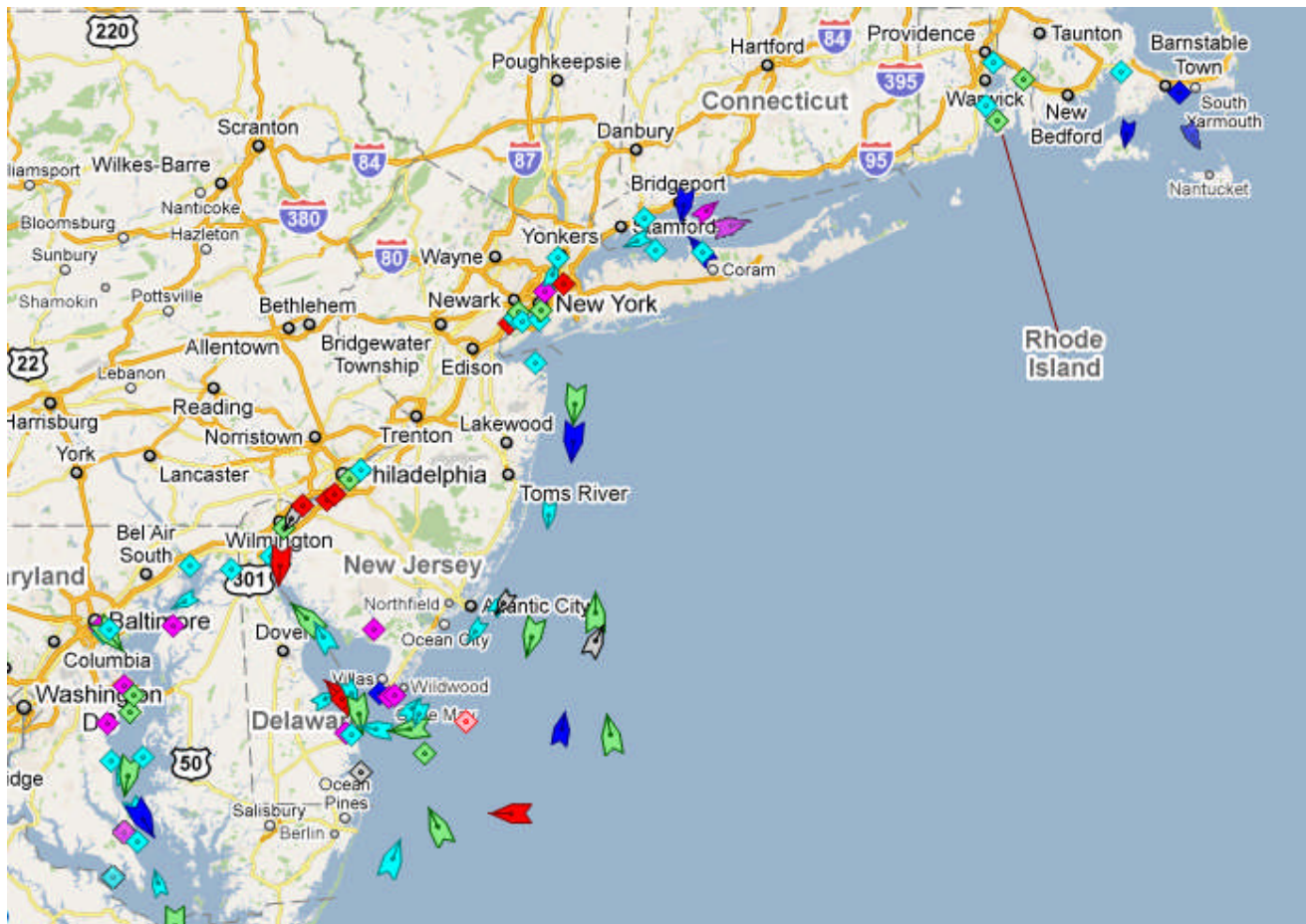

Figure 7.1: Screen Shot of East Coast Ports March 12, 2011 6:30 pm.

Using the AIS system it is possible to track the vessels by computer. While this does not record the vessel movements over time it does give warning of the approach of different vessels, and this could be adapted to give warnings to oncoming vessels, either routinely or during fog, or other special circumstances as to the presence of a submarine cable. If there was a need, and it was deemed to be a useful hazard mitigation technique then a AIS transmitter could be set up near the shore station for the cable in order to transmit warning messages based on proximity to the cable, or it could be set to do that only in particular weather conditions.

Since many vessel types will not be accounted for in the databases or on AIS, one of the best sources of information is to carry out a traffic study in the area. That requires attendance for a month or so at the proposed cable route, possibly in different seasons, monitoring the various comings and goings over the cable route, noting vessels, and frequency and when possible tracking down anchor sizes (weights and types) of those vessels. It is important to visit the ports personally and interview the port authorities, pilots and also local fishermen/organizations to get a better picture of the traffic, and how it may vary throughout the year. The pilots may be able to provide critical information on the most likely area that an anchor may be dropped accidentally when ships are preparing the anchor

arrangements to enter port, or where they complete the anchor preparations for going to sea (see Section 7.6).

Anchorage areas should be identified. Anchoring is normally limited to clearly defined zones and is also limited by water depth. The size of anchors can be estimated or can be researched directly. The selection of anchors for merchant vessels is governed by the Rules for the Classification of Ships published by various organizations including Lloyd's Register of Shipping, American Bureau of Shipping and Det Norske Veritas. The anchor size is governed by a complex set of requirements but can be somewhat generalized based on tonnage as shown in Table 7.2. The survey of the navigation across the potential cable site should indicate the name of the ship, the classification company is indicated on the Load Line painted on the ship at mid length, per Fig 7.2: using this information it is possible to look up the vessel on the Class website and determine the Equipment number and by consulting the Rules the weight of the Anchor is known for that particular ship. the AB in Fig. 7.2 stands for ABS which is the Class Society Rules the photographed vessel adheres to. Other options are LR for Lloyd's Register of Shipping, NV for Det Norske Veritas etc.

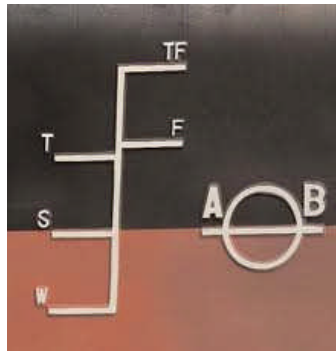

Figure 7.2: Showing the Load Line on a ship:

7.3 Recreational Vessels

Recreational vessels pose minimum threat to the submarine cable except to the extent that they may (inadvertently) create issues while the cable laying process or the cable repairing process is going on with a flotilla of vessels which are unable to maneuver while engaged in their operations.

The anchors of recreational vessels are generally rather small and if indeed they were to penetrate to the depth of the cable it is unlikely they would inflict extensive damage the cable, if the cable has at least one layer of armor. Unless unusually large it is unlikely they could unearth it.

It is worthwhile to carry out a survey of the types of recreational vehicles which could be in the vicinity of the submarine cable to confirm that there is a minimum threat to the cable from this source as circumstances vary from site-to site. Carrying out local enquiries create awareness in the community and this awareness itself may lead to cable protection ideas.

7.4 Fishing Gear

Fishing activities which pose a threat include trawling by both beam and otter boards. This type of fishing gear scrapes the seabed and can damage any cable exposed on the seabed. Shellfish dredging

penetrates the seabed to chase the bottom living fish into the nets. Scallop dredging is even more invasive. Other types of shellfish dredging disturb the seabed by water jets, again to chase the fish into a net, but potentially expose a cable over time.

Stow net fishing is carried out in areas of relatively shallow water, with high currents. Rather than trawl, the fishing vessel anchors and casts its nets which fill with fish transported by the current. The anchors are larger than normally expected on the vessel based on size. For these situations it may be necessary to consider an increased burial depth of the power cable.

Bottom (demersal) trawling is one of the main types of fishing that is associated with damage to cables. The net is held open by trawl doors that are designed to skim across the seabed. The doors vary significantly in size and weight.

While the site-specific gear should be examined in detail and the site-specific soil matched against these generic characteristics, the following table sets out an example of some generic expected values of the burial depth if there is an unacceptable probability of the submarine cable being encountered by fishing gear.

A mitigation method used in Europe to minimize any chance of a problem with in-field cables in the UK is to carry out some studies to develop fishing gear particularly modified for fishing within the area occupied by wind turbines, thereby benefiting the community while maintaining protection against snags with the submarine cable. Public meetings and promulgating the appropriate research information to fishermen could result in a significant mitigation to the risk of fishing gear snagging a submarine cable [Ref. 7.13].

GEAR	Fine Sand m	Firm Clay m	Course Sand m	Very Soft Clay m
Trawl boards, Beam trawls and Scallop dredges	<0.4	<0.4	0.5	>0.85

Table 7.1 Penetration of fishing gear in various soil types [Modified from Ref. 7.17].

A further reference shows more detail indicating the conservative nature of Table 7.1 that in clay the fishing trawl gear has low penetration:

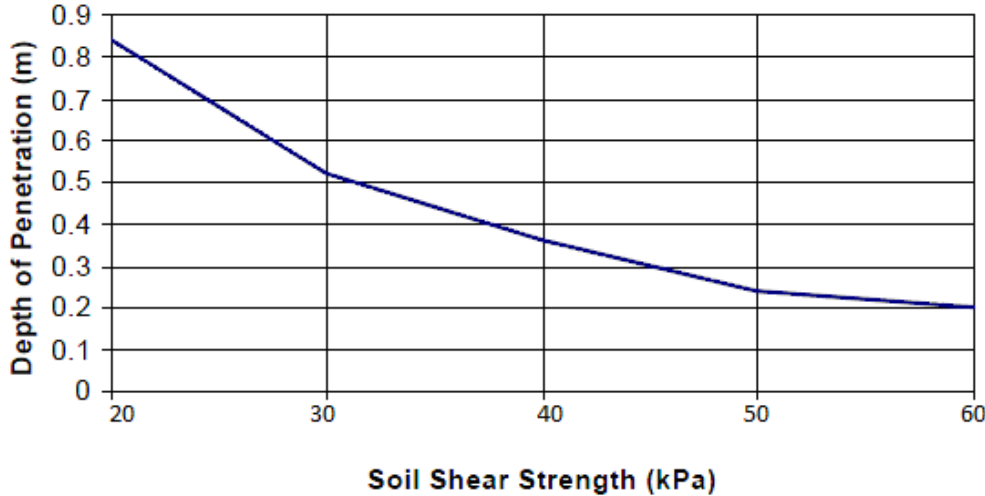

Figure 7.3: Relationship between Trawl Door Penetration and Soil Shear Strength [Ref. 3.43]

For fishing vessels the recommended burial depth is 1 meter, subject to examination of the site-specific details. The cable is recommended to be protected with at least a single armor layer.

7.5 Construction Vessels

The historic record shows that both vessels which are used in construction and anchoring in the field can pull up a cable accidentally, and the jack-up vessels can put a footing on a cable and damage it.

Cable protection for these vessel types depends mainly on clear communications as to the location of cables at any point in the construction program, and developing communications to the point where all personnel in the field are aware of the cables and how keep getting close them either in anchoring or setting jack-up legs onto their locations.

7.6 Ship Anchors: Depth of Potential Damage from Anchor Release

Evaluating the threat from Ship Anchors has not resulted in as much definitive information as anticipated when the research started. The statistics on ships anchors being dropped, the circumstances etc. are almost non-existent, and those that exist have been suspected as to their accuracy. The issue is mainly the reporting, as frequently those that damage cable are either not investigated or not caught. The experiments that have been done on anchors are not well reported: while figures are published it is not known if the anchor penetrations tabulated relate to initial penetration from being dropped or to a dragging penetration. When dragging the activity of the anchor is not usually tracked and how far it penetrates and why it stops penetrating is not discussed in the experimental write-ups. The experiments carried out at University of Texas as a result of

understanding MODU anchors have indicated that the dragging is limited in distance, in clay, as a result of the increase in penetration of the anchor which would result in the force increasing to the point of either the ship stopping, or the anchor line breaking. The experiments also noted that aside from initial penetration, the size of the ship anchor was not the most important factor in deciding the depth of penetration.

Interviews with numerous mariners many with international experience of large vessels provided varied results. For ocean going vessels the anchors are secured during transit and only can drop after they are released for port entry (or at least, that's allegedly the procedure). There are stories of ships pulling anchors, occasionally snagging telecom lines but rarely snagging electrical cables (and mostly it is not known if those cables were buried and to what depth).

One of our conclusions is that this subject needs more detailed research. The best advice available at the moment is that the navigation risk assessment should try to discover the local practices of ships that transit the cable, the location at which they release the security on the anchor to enter port and its distance from the cable and it may even be prudent to carry out some physical tests on the likely variety of anchors being used at the location if that is feasible, engaging the actual soil at location in full scale. Meanwhile it is believed that the navigation risk assessment can certainly help determine, when carried out diligently, a high, medium or low risk, and assist in determining a suitable burial depth for the cable.

Ship's anchors are rarely dropped but have the potential to damage a cable should they be dropped on top of the cable or dragged along crossing the cable route. In an analysis of the potential for a cable drop it is necessary to establish the probability of it occurring at a suitable distance that it is still dragging when crossing the cable.

Sometimes anchors are dropped on a lee shore to stop the vessel going ashore in an emergency as a result of steering gear failure or engine failure, or lack of control in bad weather. Assessing the probability of such an event far enough prior to crossing the cable that the anchor is still dragging at the buried cable location is the task of the risk assessment. Sometimes the anchors are dropped when the vessel is preparing to come into port.

Most ocean going vessels secure their anchors so they cannot be released while on the ocean transit. They have to be released manually to be able to be deployed, usually done when entering port while travelling. Coastwise vessels often do not secure their anchors with wires but hold them on the brake. Depending on traffic patterns, the coastwise vessels should form an important part of the assessment particularly if their preparations to enter port may occur closer to a potential cable crossing than an ocean-going vessel.

Generic soil types and generic penetration depths are given in the following table for a variety of ships and anchor weights, from various published literature including [Ref. 7.16]. Several references are given [Ref. 7.3, 7.6, 7.7, 7.8, 7.9, 7.10] where other researchers have commented on appropriate burial depths. The information in the references often conflicts technically one from another.

Class & Typical Size	Length	Beam	Draft	Typical DWT	Typical Anchor (tonnes)	Hard Ground	Firm Soil	Very Soft Clay
	m	m	m					
		Typical				Penetration in meters		
Seawaymax (Tanker)	225	24	8	10,000-60,000	2-10	1.5	2.1	7.3
Handy Size (Cargo)				28,000-40000	5-7	1.5-2	2.5	7.3
Handymax (Cargo)	150–200			40,000-50000	7-8	2	2.5-2.9	7.3
Panamax (Tanker or Cargo)	220	33	12	60,000 -80000	8-13	2	2.5-2.9	7.3
Aframax	250	44	12	80,000-120,000	13-15	2	2.5-2.9	7.3
Capesize (Cargo)				100,000-200000	14- 25	<2.2	2.9	9.2
Suezmax			16	120,000-200,000	15-20	<2.2	2.9	9.2
VLCC	470	60	20	200,000 -315,000	20-30	<2.2	2.9	9.2
ULCC				320,000-550,000	20-30+	<2.2	2.9	9.2

Table 7.2: Example of Ship Types, DWT, Anchor Sizes and Estimated Penetrations (not recommended burial depths).

Some research information available gives the depth of penetration of a dropped anchor in a given water depth. The probability of hitting the cable directly with an anchor being dropped is very, very much smaller than the probability of a dropped anchor snagging the line as it is pulled along. For a dropped anchor the anchor weight and the water depth are important variables. For the pulled anchor the fluke angle is the most important factor: more important that weight. Additionally for an anchor being pulled the speed of pull is also important to the amount of penetration: an anchor pulled slowly will increase penetration whereas an anchor being pulled at 3-5 knots may not penetrate so deep with the same force applied.

The assessment of the potential depth that a dropped or dragging anchor can reach must be determined with site-specific analysis, once the vessel patterns, likely drop site, likely amount of chain deployed and site specific soil are available. The soil type and strength needs to be available for a distance along any navigation route several hundred yards along the navigation route either side of the cable. A ship's anchor may be attached to typically 600 ft. – 700 ft. of chain.

The penetration depths given in Table 7.2 indicate that the heavier the anchor, the further it penetrates. The knowledge of the initial penetration of the dropped anchor is helpful to the initial

circumstances in a simulation model, but may be either more or less than the resulting trajectory depth of the anchor being pulled, which additionally may depend on the speed it is being pulled with both the power and inertia of the ship. The depth of penetration will depend on the amount of anchor chain deployed, which may be limited by the total length of chain or by a lesser amount if the brake was effectively applied at some point when the anchor was being deployed.

Recent insights from the research carried out sponsored by BOEMRE together with interviews with marine experts gave a better understanding of the issue with potential damage to cables from ships' anchors. The typical ships anchors are designed for the fluke to point into the soil and the anchor is designed so that it will automatically adjust to this configuration. For standard ship anchors the typical angle arrangement for the fluke suggests that the fluke to the shaft angle should approximate 50° in mud bottoms, 30° in sandy bottoms.



Figure 7.4 Fluke Angle of Typical Ship Anchor

The anchor is designed to penetrate until either the anchor chain breaks or the vessel is stopped. While anchor tests cited below are for uniform clays, no boulders, no sand lenses, the results were of interest.

Tests were carried out on plate anchors as a result of a BOEMRE sponsored project [Ref. 7.17] carried out in parallel with the MODU Mooring Joint Industry Study [Ref. 7.18] on anchoring MODUs in hurricane conditions. This study concluded that far outweighing all other parameters the major effect on penetration depth was the fluke angle with the larger fluke angle resulting in the largest penetration depth. The effect of the different soil types was to change the required force pulling the anchor into the soil: thus for a ship dragging in an increased of soil strength, it may out-pull the engine horsepower and the ship will either stop or break the chain in a distance which shortens as the soil strength increases. Knowing the distance between the most probable drop site (on purpose or accidental), allows a calculation to take place to see if there is a likelihood of the vessel interacting with the cable.

The conclusion reached from this research is that if a ship of any substantial size drags directly over the cable the values given in Table 7.2 may indeed be realistic and possibly underestimated. It appears unlikely, however, that ship anchors can pull more than a few hundred yards before action is taken, or the cable breaks, or the ship is diverted from the route: causing action to be taken. The frequency of an anchor reaching the cable and snagging it depends on soil, speed and distance from the anchor drop site. A computer simulation program is still in development at the time of writing and is a deliverable from the Mooring JIP [Ref. 7.18] although it does not include these variables in its current version.

Interviews with marine experts suggested the most likely location for an anchor to be accidentally dropped from a ship is when the ship changes mode from “ocean transit” to “port entry” at which time the wires/turnbuckles (and other appliances) holding the anchor in place on the ship are released so that the anchor is then held on the brake. Seaman are sent to the fo’c’sle of the ship to carry out this work: weather, experience, and other factors play in the probability that an anchor can be accidentally dropped. While not frequent, it happens in enough occasions many ships have changed an end pin to a weak link so that the chain’s bitter end will part at a load to prevent bulkheads being pulled out of the ship! Understanding of likely locations for an anchor drop may be in the knowledge of the local pilots or harbor masters: it is likely to occur prior to the location that the pilot comes on board, so a rough idea can be gleaned from knowing that location in relation to the cable position. This location may be different for ocean-going ships vs. coastwise trade. Calculations can then show the likelihood of an anchor dragging as far as the location of the submarine cable. Given enough space it would be expected that the anchor would either stop the ship before that point, break the cable (in which case it’s no threat to the submarine cable): thus the location of the pilot boarding (or if no pilot the location where attention of the navigator is enhanced when entering port) becomes important to the probability of damage to the buried cable. The arrangements at the port, weather conditions during transit of the area near the buried cable, are inputs to assess the likelihood of vessel dropping an anchor in emergency conditions.

Interviews with marine experts has also indicated that when maneuvering in tight quarters there is sometimes a need to drop an anchor to prevent either a collision or grounding. The area of port entry is one such consideration and may be one of the reasons that the USACE sets the target burial depth at 15 ft. in anchorage areas or in port entry areas as indicated in Section 2 of this report. From the information available, it appears that while a deeper depth is appropriate where there is sufficient traffic, the initial results show that the anchor may still penetrate further than the 15 ft. set by “rule-of-thumb”. It is still useful as a “default value” and the experience of the USCOE, is implied in their decisions, although it was not possible to confirm in the research that this was a directed policy.

It is also recommended from the above consideration that any area within an anchorage should be avoided, leaving plenty of room for an error by those vessels which might deploy their anchor approaching such an area.

It will be important in a site-specific evaluation to review the anchor penetration depths once the soil is known and should be able to be evaluated by appropriate soils experts taking into account the research that has been carried out. Tests on model or prototype anchors may reveal further insights. It is recommended that further research be conducted on this subject. Some information may be available from the surveys run after a number of pipelines were damaged after the recent Gulf of Mexico hurricanes, however, the anchors generally used by MODUs significantly differ from those of ships, and are usually pre-laid by supply vessel rather than dropped; National Civil Engineering Laboratory has done many tests on a variety of anchors and depth of penetration may be available for typical ship anchors [Ref. 7.1].

The task of deciding if this is a high or low risk, based on the information gathered, particularly the location of the anchorages and most likely sites of accidental anchor drop, can be calculated in a Quantitative Risk Analysis or Qualitative Risk Analysis. This analysis methodology can be applied to any type of vessel, but for example purposes is discussed only in relation to the ship vessels.

7.7 Quantitative Risk Analysis : Step-by-Step Method

The quantitative risk analysis looks for scenerios that combine to cause the damage to the cable.

In order for a ship anchor to damage the cable the following has to take place based on the estimated number of crossings of the cable that are anticipated to happen each year and assuming a 20 ton anchor as an example. The anchor could be dropped directly over the cable or in line to drag the anchor over the cable. The proposed burial depth of the cable is 2 meters.

The anchor could be dropped for several reasons:

- It is let go completely accidentally by a seaman just making a simple mistake, which often happens at the release of the cable perhaps at a location just before the pilot comes aboard when preparing for port entry by releasing the securing wire and putting the anchor line on the brake; whether the ship could drag the anchor the distance between the drop point and the cable would depend upon the soil conditions, power of the tanker, reduced by the probability that the ship was not diverted from the course over the anchor, the crew did not know it was dragging and take action; it would also depend upon speed, however, we were unable to locate any research that pointed to the effect of speed and ship inertia on the penetration depth;
- There is an emergency where the Captain thinks he may be going to ground after an engine failure or a steering gear failure;
- An emergency where there is a pending collision and the Captain drops the anchor to steer or slow down;

These situation may be modified by whether the Captain knows that there is a submarine cable present but marine experts thought it unlikely that the knowledge would modify letting go if the vessel could be about to ground;

In order to reach the burial depth of the cable using Table 7.2 the anchor would have to be in something less than “hard ground”. However, this table needs to be modified based on the research carried out [Ref. 7.18] and calculations produced which may show that likely anchor drop point is or is not at a distance and depth of a likely hit on the cable based on ship speed, and inertia.

A series of fault trees can be constructed and probabilities of failure put on each of the steps (faults) that lead to a result (either hitting the cable or not). These fault trees are generally constructed by a trained engineer in fault tree analysis together with experts on ships, anchors, soils etc. and the probabilities estimated. When statistics are available they must be used with caution to be assured that they apply to the situation at hand. Quite often statistics for a particular situation do not exist but experienced personnel can estimate them based on similar circumstances, which may be acceptable. There is very limited information on ship anchor drops but some anecdotal information says it happens often enough for several ship owners to have changed the fastening arrangements for the ship end of the chain attachment in the chain locker to being a weak link. For human factor estimates, techniques exist with documented probabilities for certain actions.

For estimating the probability of human failure for the anchor may be dropped accidentally when getting ready for going into port, there may be no specific statistics on this subject. The probability can be still be estimated by referring to HEART (Human Error and Reduction Technique) [Ref. 7.19, 7.20]. This allows use of a systematic method identical to that used in process plant risk estimates to determine the probability of failure due to human causes.

Some of the factors that are determined vary depending on the type of task and familiarity of the operator. Each of these options has a published probability or factor:

- Determine base “Nominal Human Unreliability” for the task, e.g.:
 - Totally unfamiliar with no understanding of consequences
 - Simple task given scant attention (**probably the case for this activity**)
 - Restore or shift a system to original or new state following procedures & with checking (**unlikely the seaman can stop the anchor run-out, once started, in this activity**)
 - Completely familiar, well designed, highly practiced routine task occurring several times per hour
- Consider additional “Error-Producing Conditions”, (modifications to the “factor” are based on multiplying by the result of the “error producing condition”)
 - Shortage of time available
 - No way for operator to get spatial reference
 - Ambiguity in required performance standard
 - Incentive to use other, more dangerous, procedures
- Decide on Proportion of “Error Producing Condition” (another modification to apply to the “factor”)
 - Unfamiliarity with a situation which is potentially important but which only occurs infrequently or which is novel
 - A shortage of time available for error detection and correction
 - No means of conveying spatial and functional information to operators in a form which they can readily assimilate
 - Little opportunity to exercise mind and body outside the immediate confines of a job
 - Disruption of normal work-sleep cycles
- Combine factors to determine “Nominal Likelihood of Failure”

For this case, one works the faults in the following fashion (simplistic interpretation) for a ship coming into port determining the probability from an accidental drop, which is then added to the probability of other reasons the anchor is deployed. Concentrating just on the anchor accidental drop scenario:

Probability that the anchor drops accidentally, multiplied by the probability the location is within 200 yards of the cable, multiplied by the probability that if dropped the anchor deploys sufficiently to penetrate the bottom to a greater depth than the cable, multiplied by the probability that the vessel is not stopped, multiplied by the probability that vessel is not diverted and steers the anchor away from the cable, multiplied by the probability that the speed is such that the anchor pulls only at a depth less than the cable depth, multiplied by the probability that the chain does not fail due to excessive penetration etc. These probabilities are combined (and others are added appropriate to the detailed scenario) for a result of determining the probability of damage from an accidental drop. Combine this with other scenarios and a total probability of failure can be estimated.

For this case, suppose that the result of combining the individual potential faults, was a probability of the ship dropping the anchor $P_f = .001$ but the probability of a dropped anchor hitting the cable (too far away, course diverted etc.) was $P_f = .0001$ i.e. that in a 1 year period there was a 1/1000 chance of the ship's anchor being dropped and a further 1/1000 chance of a dropped anchor hitting a cable, that would result in a total probability of both actions being 1/100,000 of a buried cable being damaged by a ship anchor.

One must now determine the consequences. The consequence to the cable is the cost of repair:

$1/100,000 \times (\text{say}) \$1,000,000 \text{ repair cost} \times \# \text{ of vessels/year (100)} = \$1000/\text{year}$ – a potentially acceptable number. However, one must also consider the loss of electricity and its cost over the repair period that could be several months, and if this is the export cable it becomes a large number. There may be other consequences to be considered including reputation, safety if the towers depend on the cable for their safety etc.

The example above considers only commercial ships. It is necessary for a full risk assessment to complete the exercise for other vessel types that may damage the cable, from all considered scenarios and consider the sum total of all risks in the evaluation.

When this Risk Analysis is completed after estimating probabilities and knowing the traffic, equipment, soil conditions, area likelihood of ship grounding or accidentally deploying an anchor, the results give the developer, regulator and other stakeholders the ability to evaluate the burial depth to determine acceptability. If the result is acceptable, the proposed burial depth is confirmed. If the result is not acceptable then mitigation methods are developed to lower the risk: once the fault trees are built it is quite simple to change numbers and review the final probability of the cable being damaged with mitigations added.

The software used for building and summing up or multiplying (as appropriate) the probabilities is readily available. An excellent package SAPHIRE 7.27 (Systems Analysis Programs for Hands-On Integrated Reliability Evaluations) is available in the USA from the Oakridge National Laboratory and is quite easy to use.

7.8 Qualitative Risk Analysis: Step-by-Step Method

An alternative to the quantitative detailed risk analysis described in Section 7.7 is the Qualitative Risk Analysis.

The methodology comprises hazard identification and evaluation of the frequency and consequence and illustrating the result in a risk matrix. Within the matrix, the ALARP (As Low As Reasonably Practicable) region may be used to identify an area where the risk is acceptable. Further reduction of risk would be subject to a cost-benefit evaluation. This approach is a common process used in decision making on complex subjects in the offshore oil and gas world i.e. API RP2 SK (mooring systems) [Ref 7.5] and guidance available from ABS [Ref. 7.14] and DNV [Ref. 8.9].

The same basic information needs to be available as in the quantitative risk analysis but instead of calculating probabilities through a fault tree analysis, estimates of whether the risk is high, medium or low is determined by a set of Rules drawn up for a HAZID. The evaluation of these results in developing mitigations if the total risk comes out to be unacceptably high and thus the unacceptable issues can be re-evaluated to confirm if they are acceptable when mitigating steps are taken. The method is considered equally valid but how well it is carried out depends more on the experience of the personnel assembled. The personnel assembled may include experts on fishing vessel equipment, local port officials, an insurance claims personnel, cable expert, and ship's master etc. in order to determine the risks and consequences based on the background information developed. The group, then in concert, places the probabilities and consequences on a risk matrix. The Risk Matrix can consist of various sizes, and a 5 X 5 matrix is illustrated in Fig. 7.5.

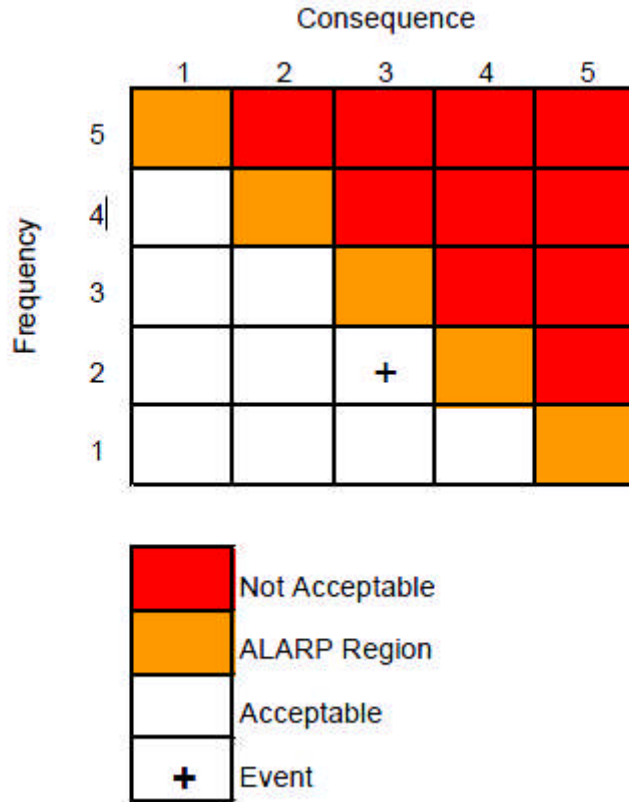

Figure 7.5: Frequency vs Consequence Matrix

Each risk is put into a box. The matrix has escalating consequence to the right and decreasing frequency in rows moving downwards. In developing a risk matrix, the frequency of occurrence is given a ranking from 1 (low) to 5 (high). Similarly, the consequence is either calculated or estimated, then ranked from 1 (low, non-critical consequence) to 5 (high, severe consequence). The Consequences for an offshore wind farm might generally be categorized as Assets (a money issue), Environment, or a risk to Reputation. If it is decided that the risk can be mitigated to a lower number a second + mark is placed with an arrow to show the decrease in risk or consequence as a result of a separate action.

Mitigation methods for items that arise being outside the acceptable range:

- Change routing (reducing frequency)
- Increase depth of burial (reducing frequency)
- Increase mechanical protection (reducing consequence).

By carrying out such an assessment it is possible to consider the appropriateness of burial depth in some sections of the route, with additional external protection in others reducing the perceived risk to the same level by different countermeasures.

In each case in the evaluation it is necessary prior to commencing the formal risk evaluation to have knowledgeable presentations made on the various issues i.e. a presentation of the results of the information search outlined in Section 7.2 and the soils information for the region and studies such as carried out for BOEMRE on drag anchor embedment [Ref. 7.17]. The team assembled would then examine the circumstances under which they might drop and anchor or which fishing gear would foul the cable at the proposed burial depth.

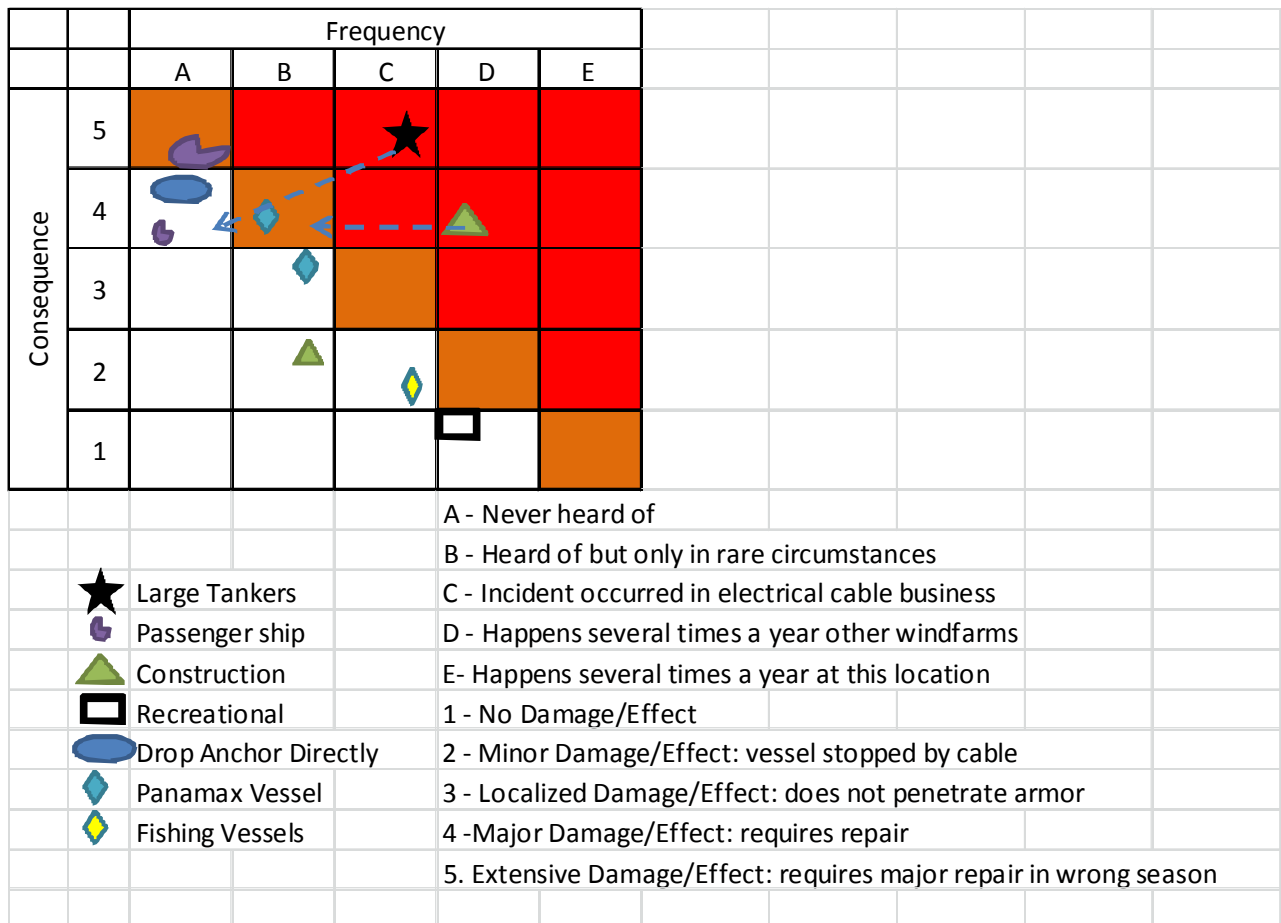

Figure 7.6: Risk Analysis Matrix

The matrix is carefully defined as to frequency based on “qualitative” parameters: suggestions are made in Figure 7.6 for a fictitious assessment. Definitions of the amount of damage may be based on Environment or on Cost, or on Reputation.

Note that the risk of a large ship dragging over the cable was deemed unacceptable in the case shown in Figure 7.6: a mitigation was effected as shown by the arrow, as a result of tankers being re-routed to by-pass the cable or perhaps some other mitigation.

Note that there are two construction vessel items which might be: one large – a jack-up installation vessel, and a smaller crew vessel. The original evaluation showed a crew vessel was a small risk (small icon), and the jack-up installation vessel had an unacceptable risk. A procedure perhaps could be implemented involving an instrument on board the vessel to detect if the footings were over top a cable, and a person assigned 24/7 to be in the control room to monitor the potential cable issue while the construction vessel was moving from one in-field location to another, thus allowing a change in the consequence.

As can be seen in Figure 7.6 this results in no unacceptable risks (they would remain in the red zone). There are some risks that fall in the orange (ALARP) zone and opportunities should be used to mitigate the potential down even further. The remainder of the risks are lower (clear zone), and can be managed for continuous improvement as the opportunity arises.

The Summary Table would be developed to report on the issues examined in this Risk Analysis:

Worst Credible Scenario	Matrix position: Consequence Category - whether \$, Environmental Concern or Reputation	Measures to reduce risks to ALARP (As Low As Reasonably Practical)
Large Tanker drops anchor and drags through cable: mode change “ocean transit” to “port ready” close by	C-5 Assets & Environment	Large Tanker traffic re-routed for alternate entry to port; or a second export cable is used several hundred meters distant.
Vessel en route to port has engine failure drops anchor that drags and snags cable – but not sufficient to sever line	B-4 Assets & Reputation	Communications with ship monitored by AIS alerts ship when he broadcasts engine failure, that there is a cable in the area and to consult charts before throwing anchor
A storm erodes the cover to the line and anchor of yacht drifting and snags the line	D-1 Assets	Yacht unlikely to have anchor large enough to penetrate armor at that depth. Ensure In Service Inspection Plan submitted and approved by Regulator is being used - and that surveys after storm take place.
Construction Vessel puts foot on in-field cable	D-4 for Assets and Reputation	Equipment on board added with observer during moves
Dredging vessel decides to take sand very near cable near to shore	C-3 for Assets (not shown in Figure)	Vigilant watch by wind farm workers; ensure that cable continues to be marked on chart.

Table 7.3 Mitigation Measures (Risk Reduction)

7.9 Effects of Cables on Marine Navigation

Magnetic Compasses

The potential effects of any electromagnetic fields will be minimized by the correct choice of cable and by burial and will have no impact on navigational or electronic equipment. This is supported by some studies which indicate a magnetic field of about $0.95 \mu\text{T}$ 5 m from a cable buried 1 m deep. This should be set against the earth's magnetic field of a typical $50 \mu\text{T}$. (should be checked for the area) [Ref 7.21].

7.10 Assumptions of Due Diligence

The Navigation Risk Assessment is normally carried out on the basis of assuming that due diligence has been done in installation of the offshore windfarm cables including ensuring they are indeed buried to the specified depth, and regular inspections to ensure they stay buried; inspection after a major storm etc.

It also assumes that competent marine contractors are installing the cables, and that heavy lifts over the cables are properly managed.

7.11 Acceptance of Risk

Anchors of very large vessels if deployed in the wrong circumstances e.g. directly on top of or very near the buried cable have the possibility of damage to the cable in spite of the diligent mitigations.

7.12 Mitigation of Risk

Several methods of mitigating risk have been explored in this Section however there are further items that may be emphasized particularly for the vessels (with large anchors) transiting the area, since they will all be equipped with the AIS system (automatic identification).

Since 2007 there has been a requirement for international vessels to use the AIS system (automatic identification). If the offshore wind farm and cable route is being monitored there are opportunities to notify vessels when they are threatening the cable route.

Cable spacing if more than one cable is installed preserves some degree of redundancy though obviously a ship with an anchor dragging could capture more than one cable in the same incident. The distance becomes important between the two. The distance that the cable can pull at equal to or greater than the burial depth is limited according to initial results from studies (Ref. 7.19], and about 200 yards.

7.12.1 Mitigation by Exclusion Zones

Exclusion Zones for offshore wind farms and cable protection zones for submarine cables have been used elsewhere in the world when feasible to designate an area for ship traffic to avoid. This draws attention to the installations and is represented on nautical charts to warn mariners, fishermen and the general public about their presence and dangers.

One good example of a charted area prohibiting anchoring is offshore New Zealand for the New Zealand terminal of the Southern Cross and other international submarine cables. Source: Telecom New Zealand [Ref. 7.2].



Figure 7.7: Cable protection zone New Zealand

Whether all submarine cables associated with wind farms will be charted depends upon the scale of the chart. As with all submarine cables, mariners should note the hazards associated with anchoring or trawling near them.

The International Association of Marine Aids to Navigation & Lighthouse Authorities (IALA) publishes useful Recommendations O-139 On the Marking of Man-Made Offshore Structures which mentions the marking of wind farms in detail but does not give any guidance on protection of submarine cables, except in their observation that they should be and are buried. Dependent on chart scale submarine cables may be shown, or it may be marked as a cable area.

7.12.2 Mitigations Available from Signs, Beacons and Potential Exclusion Zones

Temporary safety zones may be established by the USCG during construction, major maintenance and decommissioning. Those charts where submarine cables are shown are displayed with symbols shown in Figure 7.8.

It is worthy of note that the CFRs describe the requirements for the US Corps of Engineers.

33 CFR §209.310 Representation Of Submarine Cables And Pipelines On Nautical Charts.

(a)(1) Within protected waters such as harbors, rivers, bays, estuaries or other inland waterways the location of submarine cables and pipelines is to be indicated by shaded areas marked "Pipeline area"

or "Cable area". The extent of the limits of the area will be governed by local conditions but shall include the immediate area which overlies the cable or pipeline.

(a)(2) Ordinarily, the shaded area on a chart which depicts a cable area or pipeline area should not exceed 500 feet on each side of the location of the cable or pipeline except on small scale charts where an area of that width would not be of sufficient prominence.

While no similar regulations exists for BOEMRE it is understood that the same policy applies and that cables are noted on BOEMRE informational maps, and the information provided to NOAA.

On NOAA Nautical Charts the following is the note that describes how the cables are shown:

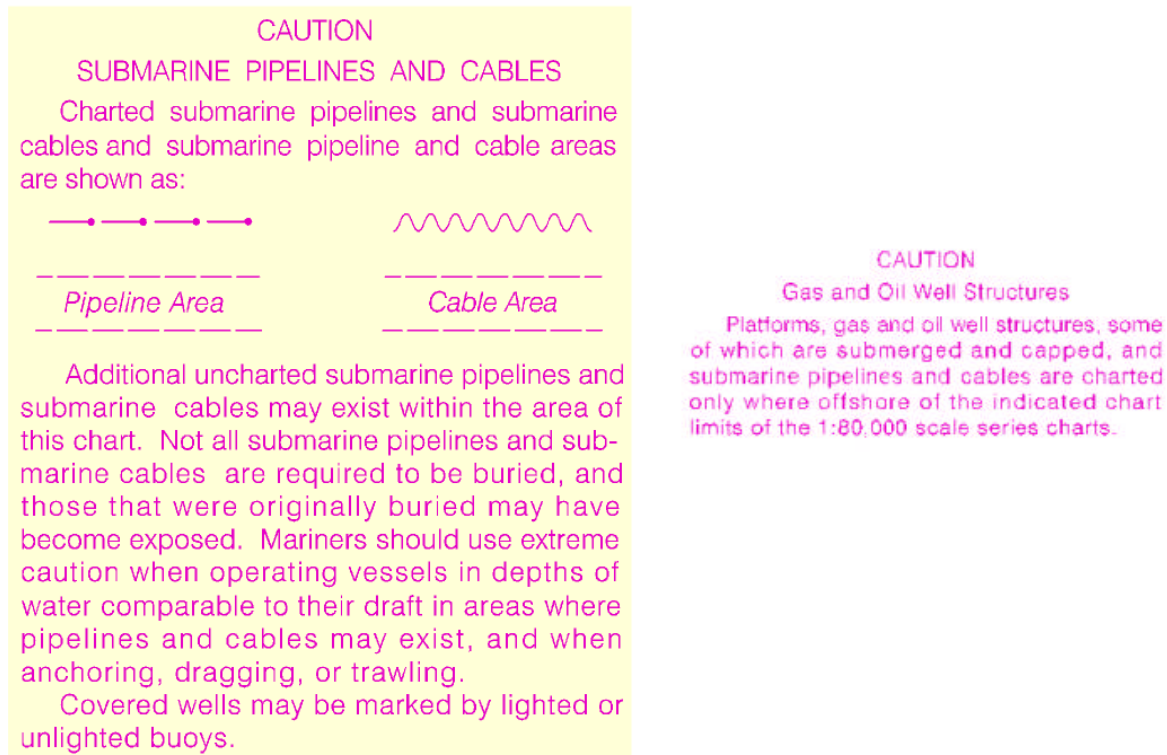

Figure 7.8: Legends from a NOAA Chart describing the Cable symbols.

The US Coast Guard & NOAA both warn that submarine cables if fouled should not be cut:

Vessels fouling a submarine cable or pipeline should attempt to clear it without undue strain on the cable, anchors or gear; no attempt should be made to cut a cable or pipeline. Divers may be necessary in order to accomplish the clearance without imposing further damage.

[Ref. 7.3], [Ref 7.4].

The MMS (Pacific Region) has provision for warning on a Notice to Lessees (NTL 2010-P04) which remains in effect until February 23, 2015:

"The following sign criteria were included in the original NTL and remain in effect:

Pipelines and power cables shall be identified with warning signs on each platform. The signs shall use letters not less than 10 inches in height, and the letters shall be black on a white

background. Signs shall be (a) affixed at locations that are close to the points where the pipelines/cables enter the ocean or where the pipelines/cables leave the platform's boundaries and (b) legible to approaching boat traffic. The signs shall contain the following language and information and be maintained in a legible condition:

1. "WARNING:"
2. "SEAFLOOR PIPELINES AND/OR POWER CABLES"
(whichever is appropriate)
3. "DO NOT DREDGE OR ANCHOR""

Voluntary aids to navigation are generally permitted by the USCG and a Racon at the departure location and landing point for the export cable may be beneficial to consider, warning all shipping that they are "running into danger".

7.13 References

- 7.1 Techdata sheet 83-08R, "Drag Embedment Anchors for Navy Moorings," Naval Civil Engineering Laboratory, 1987.
- 7.2 Submarine cables and the oceans: connecting the world, International Cable Protection Committee.
- 7.3 [http://www.navcen.uscg.gov/pdf/Inms/D14 Special Notice 2011.pdf](http://www.navcen.uscg.gov/pdf/Inms/D14%20Special%20Notice%202011.pdf)
- 7.4 <http://www.nauticalcharts.noaa.gov/nsd/xml2html.php?xml=coastpilot/files/cp9/01.xml>
- 7.5 API RP2SK Design and Analysis of Stationkeeping Systems for Floating Structures.
- 7.6 Balog G., Potential Cost Savings on Submarine Cables, BWEA28, Glasgow Oct. 2006 (Nexans).
- 7.7 Robert Donaghy, ESB International, HV Submarine Cable Systems Design, Testing and Installation, Presentation at CIGRE Conference Ireland October 2010.
- 7.8 Christensen C F., DNV, Cable Risk Assessment. Lecture on a Symposium on Installation of Submarine Power Cables for Grid Connection of Offshore Windparks, Bremen, Germany 2006.
- 7.9 National Electrical Code IEEE – C2 2007.g
- 7.10 Subsea Pipeline Engineering by Andrew Palmer and Roger A King, 2nd Edition, Penn Well Publishing 2008.
- 7.11 Allan, PG and Comrie, R. Risk assessment methodology and optimization of cable protection for existing and future project SubOptic 2004, Monaco, March 2004.
- 7.12 Christensen C F., DNV, Cable Risk Assessment. Lecture on a Symposium on Installation of Submarine Power Cables for Grid Connection of Offshore Wind parks, Bremen, German 2006.

- 7.13 Blyth-Skyrme, R.E. (2010). Options and opportunities for marine fisheries mitigation associated with wind farms. Draft report for collaborative Offshore Wind Research Into the Environment contract FISHMITIG09. COWRIE Ltd, Nature Bureau, Newbury, UK. 125 pp.
- 7.14 ABS Guidance Notes on Review and Approval of Novel Concepts
- 7.15 Risk Assessment of Pipelines Protection DNV-RP-F107.
- 7.16 Dept. of Business Enterprise and Regulatory Reform (UK), Review of Cabling Techniques and Environmental Effects Applicable to the Offshore Wind Farm Industry, January 2008.
- 7.17 The Performance of Drag Embedment Anchors (DEA), C. Aubeny and staff of Texas A&M and the UT and Evan Zimmerman, Delmar, March 2011
- 7.18 MODU Mooring Strength and Reliability Joint Industry Project (JIP), ABS Consulting, Offshore Risk & Technology, et al. 2009.
- 7.19 Williams J.C., 1985, "HEART – A Proposed Method for Achieving High Reliability in Process Operation by Means of Human Factors Engineering Technology", Proceedings of a Symposium on Achievement of Reliability in Operating Plan, Safety and Reliability Society, 26th September, 1985.
- 7.20 Williams J.C., "HEART- A proposed Method for Assessing and Reducing Human Error", 9th Advances in Reliability Technology Symposium 1986.
- 7.21 http://www.nationalgridus.com/non_html/shared_env_emfs.pdf

8. CABLE PROTECTION

The consequential damage involved for the export cable of an offshore wind farm electrical subsea power connection can amount to many months of downtime. The techniques of protecting the in-field cables and export cables may differ on any particular project.

The following hazards provide reasons to bury the cable, aside from the electrical reasons to do so, discussed elsewhere in this document:

- Interaction with recreational vessels
- Interaction with fishing gear
- Interaction with dropped or dragged ship anchors
- Exposure of the cable due to seabed conditions e.g. sand waves, scour
- Exposure of the cable when exposed from unsupported lengths or jagged rocks along the route
- Dredging Activities
- Other dropped objects.

The best protection is to bury the cable below the depth which the threat can reach. Only a small depth is required for the more frequent hazards: often less than 1 meter but no truly effective measure can be taken against anchors dropped from large ships, as modern anchors can dig deep into the seabed although they cannot usually be dragged a great distance. The depth of trench to completely avoid all potential incidents would be economically unviable.

The accident of hitting a cable has no severe environmental and only a limited safety impact. Should the cable be torn, the resulting electrical short can lead to an equipment overload and the shut-down of converter or transformer stations. The ship involved will suffer no electrical shock due to the high electrical conductivity of seawater, resulting in a complete earthing of the damaged cable. The economic damage, however, may be significant as the repair of broken cables is very expensive.

Once the information about the ability to bury the cable is known decisions can be made about how much to armor the cable and what armoring is required from risks due to “navigation” e.g. ships and trawlers, rocks, unsupported lengths and from other environmental hazards such as creatures burrowing into the cable. Since armoring and burial depth protect against somewhat different faults these are not interchangeable factors. External armoring by protection devices sleeved on top of the cable also is an option (see Figure 8.10).



Figure 8.1: Cross Section of Cable with Single Armor Layer.

The research has shown that it is clearly not possible to avoid all hazards. Burial of cables was addressed:

- from cable design risks in Section 4 where the burial depth of a minimum of 1 meter was determined from a number of requirements (mainly one of heat dissipation) extending to possibly 2 meters+ for HVDC cable, and beyond this value increased burial is not recommended since the current capacity continues to degrade with depth; (Note: Greenpeace [Ref. 4.2] recommends a sufficient burial depth of 1 meter).
- from installation risks in Section 9 where except in special circumstances the burial depth of 1-2 meters appeared to be customary, achievable with reasonably sized equipment without significant bottom disturbance;
- from routing risks in Section 6 ensuring that a route providing burial depths of 1 meter or more would be optimum;
- from special considerations in Section 5 where burial 1 m. below sand dune troughs was ideal but the risk may be able to be mitigated by constant inspection and remediation; in seismic areas the only mitigation is to allow extra cable to be buried for a reasonable distance parallel to the fault line to mitigate a separation distance;
- from navigation hazards in Section 7 where recreational vessel threat can be mitigated with armoring, fishing vessel threat can be mitigated by armoring and burial of 1 meter, and ship

anchor interactions can be minimized by determining the most probable location of a dropped anchor and avoiding it by at least 100+ yards or other mitigations.

Our conclusion from all considerations is that the “norm” for burial depth acceptance of electric submarine cables, can be summarized as:

- in an anchorage area or in a channel with sizeable ship traffic where considerable maneuvering is required which may result in a ship deploying an anchor i.e. port entry, (supported by experience outlined in Section 2): approx. 15 ft. (4.5 m) below seabed
- in all other areas between 1 m. and 2 m. (3ft. to 6 ft.) depending on cable design requirements for burial, installation needs, and site-specific circumstances

Adjustments can and should be made from these “baseline figures” from special considerations:

- Deeper burial is required in softer sands where trawler nets may penetrate, and shallower burial is suitable in stiffer soils, such as dense clays.
- Rocky areas may be protected with rock berms or by cutting into the rock in some circumstances.
- Additional armoring may offer some extra protection if protecting against marginally larger than recreational or fishing vessels;
- Rocky bottoms and areas of scour may lead to unsupported lengths so armoring in opposite lays may provide mitigations against unsupported lengths.

Some areas of the US will have issues with burial. Maine is one of those states that has a lot of rocky shores and so trenching becomes very expensive, and the solution lies with rock berms and extra armoring to mitigate free spans, abrasion and small vessel anchors, and significant attention to mitigating large vessel anchor damage.

There are a wide variety of drag embedment anchors in use along the United States coastline, by ships. The majority of these are shown in Figure 8.2. By contrast, offshore oil and gas MODUs use very large sophisticated anchors that do not deploy under self-weight and need to be deployed by an anchor handling vessel and placed in the correct orientation on the seabed – so they are not used on ships. These are shown, for contrast in Figure 8.3.

Small Bruce anchors are used on yachts, but because they are small the penetration is neither as great, nor the damage they can do so extensive as the larger sizes typical on offshore oil rigs.

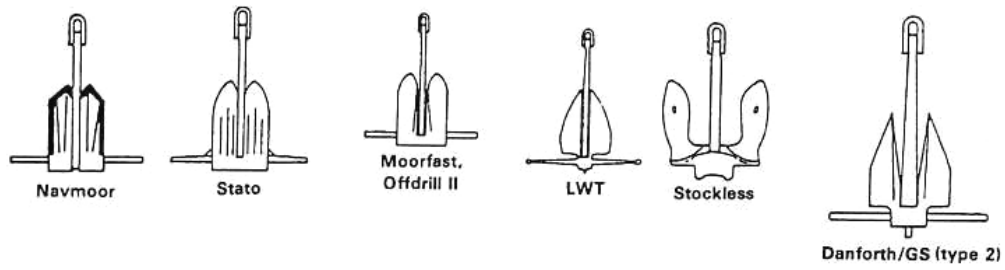

Figure 8.2: Typical Ship Drag Embedment Anchors

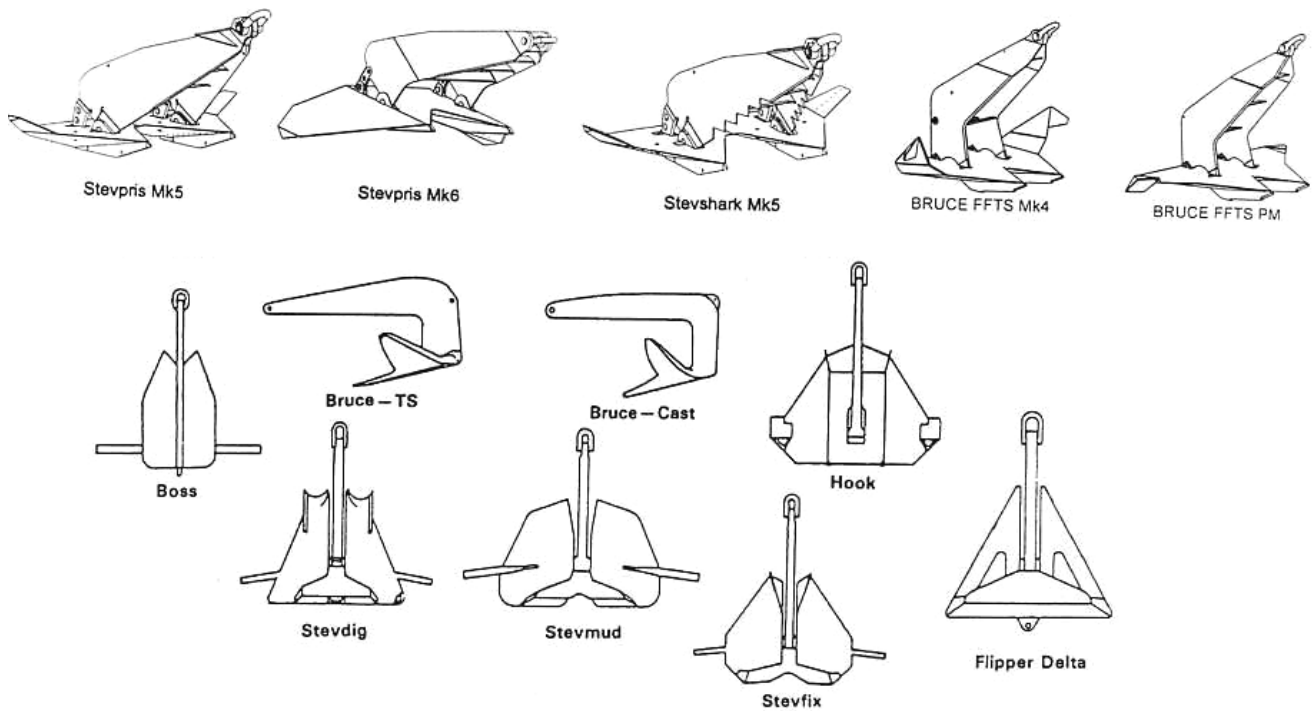

Figure 8.3: Typical Offshore Rig Anchors

Burial depth requirements to protect the cables have varied depending on location: as an example Borkum West

Area	Minimum depth below seabed
Traffic routes in the Wadden Sea	3.0 m
Tideways	2.0 m
The remaining Wadden Sea area	1.5 m
From the high tide contour line to 12 n. mi-line	3.0 m

Table 8.1 Burial Depths – Borkum West
Source: [Ref. 3.12]

8.1 Burial Protection Index.

For many years the industry standard burial depth when at risk from trawling, was 2-3 ft. (3 ft. is still used by pipelines close to shore). Except in exceptional circumstances it was also used as the appropriate burial depth for protection from anchors. The capability of the plows at that time was limited to 0.5m -1m (it is now generally up to 4 m).

Based on information from Mole *et al*, 1997 [Ref. 8.1] developed the concept of a ‘Burial Protection Index’ (BPI) as shown in Figure 8.4.

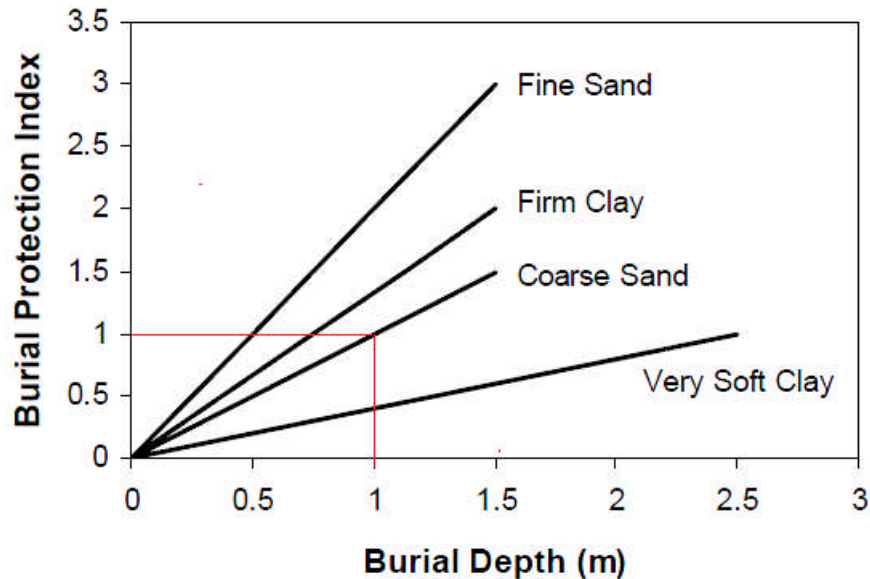

Figure 8.4: Illustration of Burial Protection Index.

This BPI Index recognizes that different seabed soils react differently to the penetration of fishing gear and anchors. It was recognized at the time that this was a simplistic concept but it has in fact, caught on with the industry. It may be that a more sophisticated set of graphs can be provided as more historical information becomes available, but it appears the BPI seems to have its uses even as-is.

A BPI of 1.0 has been scaled such that good protection may be anticipated from trawling and fishing gear in coarse sand with an appropriate factor of safety. With this as its basis a measure of the depth is deduced for a variety of other seabeds which then can be said to have about an equivalent “protection”. According to the authors:

- BPI = 1 is considered suitable for water depths greater than 100 m where anchoring of ships is unlikely or where shipping and anchoring is prohibited. This equates to 1 m depth of burial in coarse sand.
- BPI = 2 would provide protection from vessels with anchors up to about 2 tonnes. This may be adequate for normal fishing activities, and small merchant ships, but would not be suitable for larger ships’ anchors.
- BPI = 3 would be sufficient to protect from anchors of all but the largest ships*. It would be suitable for anchorages, at the entrance of harbors where ships have been known to often accidentally deploy an anchor, and heavily trafficked shipping channels with adjustments made to suit known ship anchor sizes. [Ref. 8.2].

*Note: research [Ref. 7.18] indicates that after initial drop, the penetration depth is primarily a function of fluke angle and not size and weight – though clearly the inertia of the ship and ability of the cable to hold the ship is a function of size.

The factor of safety is not readily apparent but there are some illustrations. Selection of higher BPI values is appropriate in areas of higher risk such as in a harbor where anchoring risk is greater or in areas using aggressive fishing techniques:

- In very soft clay to reach a BPI of 1 it would be necessary to bury the cable to almost 3 meters; Using a BPI of 3 and very soft clay e.g. at a port entrance would indicate an extrapolated depth of around 25 ft.
- In fine sand, a BPI of 1 could be reached with 0.5 meters, assuming there were no other issues such as scour, erosion and waves etc.
- In very soft clay in order to give roughly an equivalent level of protection to a 1 meter burial depth in sand or 0.8 m in firm clay a burial depth of 2.5 meters is required

While the BPI concept is useful, without further consideration it may lead you to convince yourself that it is appropriate to the situation but the technique can also be used to convince yourself something is safe that more detailed study may show is not. It is insufficient to rely only on the BPI in evaluating a potential location.

The tendency in installation has been to be prescriptive and state a fixed depth without due regard for the protection provided by the geology and its associated risks; (e.g. Cape Wind had specified a uniform 6 ft. burial depth throughout the length). If the seabed varies throughout the cable route, or

for competing cable routes to make a fair evaluation on a risk-basis it is useful to adopt the BPI concept. An Index value is specified and then the depth is according to the Figure 8.4 and a uniform protection is provided regardless of the soil, if the threat level is constant throughout the route.

The background to the BPI lines emanate from gathering information such as the information in Figure 8.5, one of many graphs from which the index was developed:

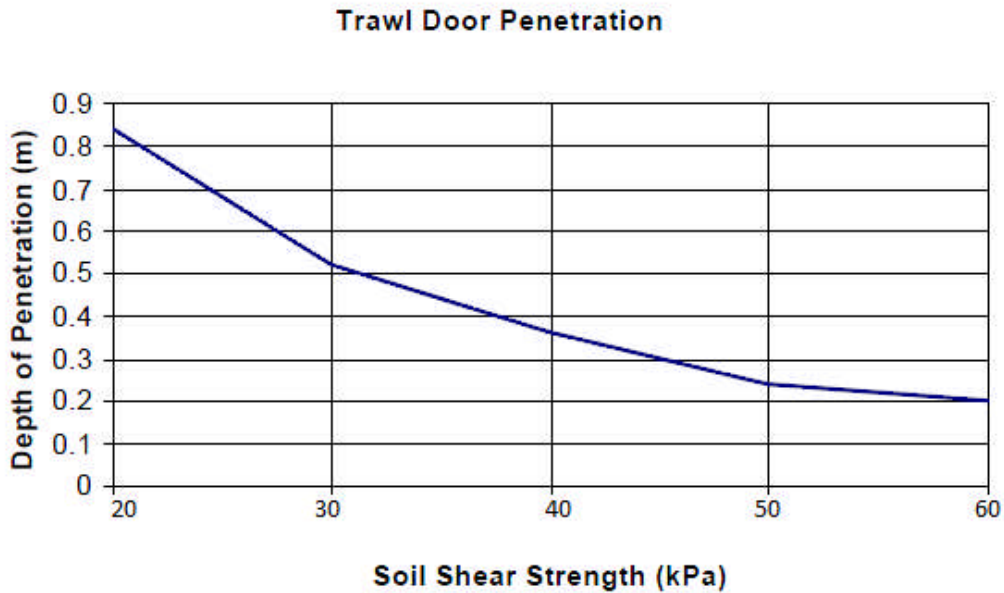

Figure 8.5: Depth of Penetration of Trawl against the Soil shear Strength in Clay.

It was recognized by the practitioners that reasonable protection from fishing gear was provided between 0.6m and 1.0m depth in firm clay with strength greater than 40kPa, at an anticipated penetration of 0.36 meters, however a safety factor was added. The rationale was that assessed by the practitioners and assigned a BPI of 1. Estimating the increase in depth of burial with a reduced clay strength was provided from the following graph. Increasing it beyond 60 kPa resulted in no gain.

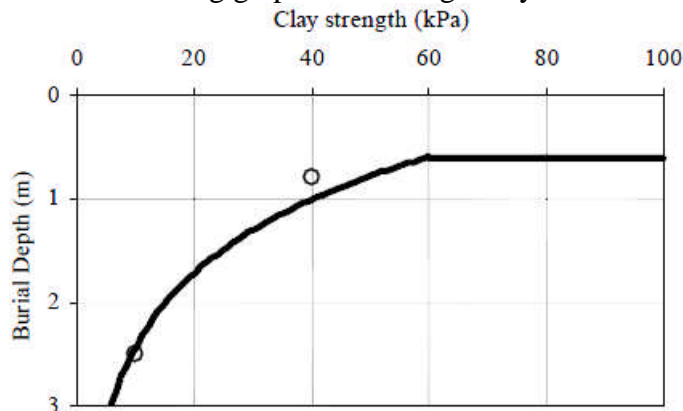

Figure 8.6: The variation in burial depth with Clay Strength for use with BPI.

As the Figure 8.4 indicates for a BPI of 1 in very soft clay (say 5 kPa) a burial depth of 3 meters corresponding with the value in the Figure 8.6 would be appropriate.

While the correlation to sand was based on the penetration that could be assumed from the drop weight of the fishing gear and expected bearing capacity of the sand under different densities the following graph evolved:

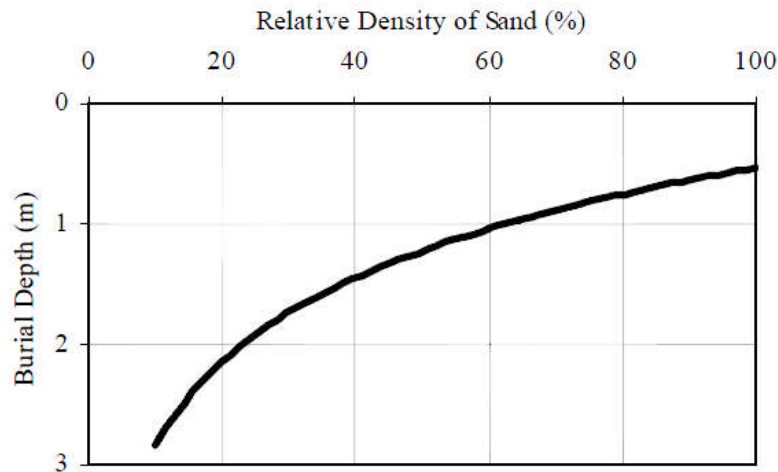

Figure 8.7: Variation in Burial Depth with Relative Density of Sand

The literature reflects that a great number of variables were taken into account in developing the Burial Protection Index, and the above discussion does not cover all relevant factors which are promulgated by the committee developing the concept. The BPI took into account:

- soil shear strength
- fishing and maritime activities
- cable strength
- cable repairability
- cable ampacity

It is thus possible to see how the derivation of the BPI came about from amalgamating the various experiences with a risk based method. Although ignoring more complex engineering modelling, it did arrive at a conceptual way of looking at things which has been well received by industry and makes a useful ability to specify burial depth when there is potential variation along the route.

In summary, the BPI provides a uniform-risk based method of providing protection in different soil types on an equivalent risk basis.

For reference to more detailed information on application of the BPI refer to papers by Allan [Ref. 8.5], and [Ref. 8.7].

8.1.1 A Simulation Model: Building on the BPI Index Concept

As one accounts for further analysis of the BPI method one runs into an inevitable conclusion that the method has its limitations.

The BPI method can be improved for the benefit of the offshore wind community in incorporating the research into a simulation model. So far, the simulation model developed as an extension to research [Ref 7.17, 7.18] considers only clay soil and determines the resultant depth of penetration, pull required and distance travelled based upon the anchor area, fluke angle, initial penetration etc.. Further refinements could add sandy bottoms, determine some combination of power, speed and inertia of the ship to determine the distance travelled in more detail, and possibly add anticipated holding power of the chain before breaking. As such it would be a very useful simulation model to get a much better prediction of the anticipated effect of the threat from a ship's anchor.

The general information that has been available looks at the initial penetration of the anchor drop and not at the depth of penetration as it continues to drag, which is the prime scenario which has a larger probability of occurrence. Using the research carried out by Texas A & M University under the direction of Dr. Charles Aubeny, [Ref. 7.18, 8.3, 8.4] it was determined that the important parameter in determining penetration is the fluke angle and not the anchor weight; additionally it showed that there is no limitation to the potential depth of penetration except the strength of the chain and the load that can be imposed by the ship either because of inertia or because of engine power. Extending the simulation model to look at this problem for the offshore wind industry is recommended.

8.2 Repair and Armoring Issues

While minimum burial depth may be an obvious issue to assure safety of the cable, there are other considerations that go into the optimal depth selection. It must be possible to repair a fault in a cable from whatever source. Therefore, while burial offers protection, there is a need to identify an optimum depth which both protects the cable but enables recovery to be achieved. Appendix B gives more detail on the cable repair issue.

Grappels for recovery of cables must be capable to penetrate the seabed to a depth greater than the original burial depth. Once caught on the cable they cut and hold the cable to allow it to be recovered to a vessel's deck to enable a repair.

While the additional armoring for protection is an option it is not without its own issues. Armoring is normally applied as additional layers of wire. These may be around the wire almost perpendicular to the main conductor, or diagonally on the wire in either a left or right hand lay. The addition of these extra layers may increase the rigidity of the line and thus make it more difficult to lay, bending in the plow tighter than the design for bend, and more difficult to repair. It may also be an issue if the cable is prone to be suspended between points, due to its additional stiffness. Each additional layer of armor is also very costly. Additional layers need to be planned taking into account the laying process.

8.3 Decommissioning of Cable

Recovery of the cable at the end-of-life of the wind farm is required if the owners are held to the permit and not given a deviation for it to remain. De-burying the installed submarine cables is likely to result in a significant disturbance to the seabed. If cables are only buried to a shallow depth in

sandy seabed, an under-runner can be used to de-bury the cable. This device is put on the cable and as the name suggests 'under runs' the cable while being towed from a line from a host vessel. This procedure, however will not work for deeper buried cables as is commonly associated with offshore wind farms (1.0 m. and deeper), especially when the cables are effectively buried in clays, gravels, chalk etc. Therefore, de-burial would involve the use of significant subsea plant (as yet not commercially available to the market on a significant scale) using aggressive methods such as cutting large open trenches to access the buried cables [Ref. 8.7].

8.4 Protection at the Shore Landing

The shore landing section has its own issues and the BPI may not easily be applied to this area which covers the tidal and surf zones. The offshore boundary is typically the closest position the cable-laying vessel can safely reach. From this point support equipment is needed to pull the offshore cable to shore.

Typical hazards to a cable traversing this section are:

- Severe wave and sediment action;
- Variable seabed profiles and seasonal changes of seabed profile;
- Recreational activities – digging tourists, garbage cleaning with penetrating equipment;
- An eroding beachhead.

As the cable transitions from the water the heat characteristics of the cable may compel a larger cable be used, and/or a deeper depth. The same methodology applies as was carried out for the Navigation Risk Assessment except there is a change to look for hazards associated with the transition zone.

To provide sufficient protection for this section of the cable the minimum depth depends on the coastal zone morphology and requires detailed study of the actual location.

8.5 Protection from Ice Rafting: Offshore Maine and Alaska

Offshore Maine and Alaska there is the issue of ice build-up near shore that could cause damage to the cables. The ideal protection is to drill the cable path to some distance offshore below the impact area: since this type of drilling is customary to distances of a few (2-3), kilometers it may be appropriate to consider this method for those locations. The forces of ice would require a substantial burial depth which may be difficult to create on a rocky bottom in Maine, and the drilling may be an optimal solution. Surveys may be able to reveal historic scarring of the seabed due to ice as one determinate of the extent of burial protection required.

8.6 Rock Dumping and Plastic Sheaths

Other protective methods include rock dumping. This is relatively simple, but it must be stressed that the rock must be carefully selected and sized to be appropriate for the job. If rock dumping is done when it is impractical to bury cable – one has to take caution to ensure no damage to the cable occurs during this process.



Figure 8.9: Cartoon of Rock dumping

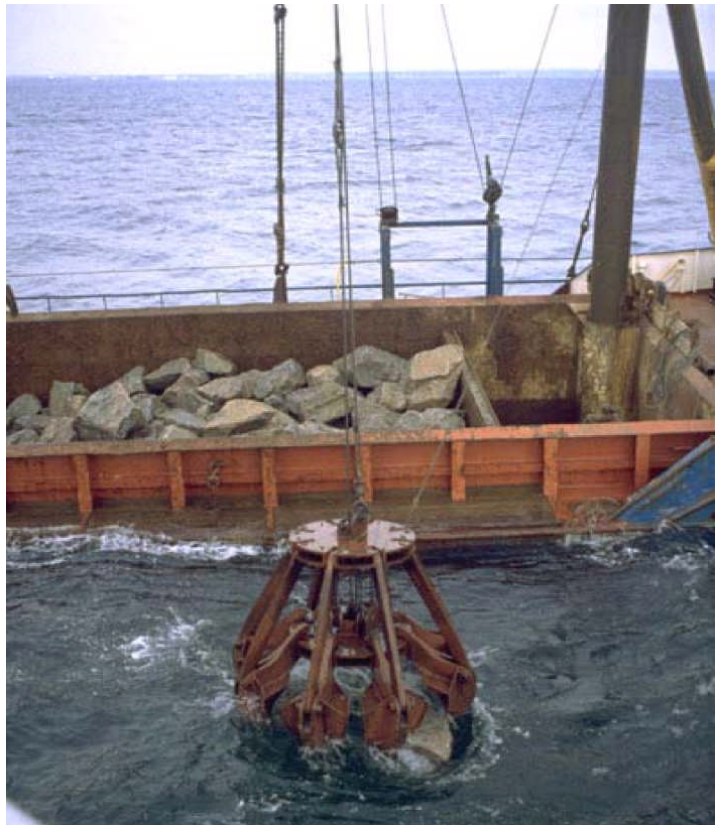

Figure 8.8: Illustration of Rock Dumping



Figure 8.10: Proprietary system to protect the Export cables to London Array (Courtesy Cicor International)

Several companies have developed a plastic covering for the cable which acts to protect it. These are usually used in conjunction with other protective measures such as rock covering.

8.7 Scour Protection

Scour which has occurred at several wind turbine sites e.g. Scroby Sands, and Prinses Amelia where granular soils and high currents were a factor and can extend to a depth of 5 m and a diameter of 60m around each turbine, thus exposing the cable [Ref. 4.5]. If currents are suspected to be high at sandy locations then regular inspection of foundations and along the cable length should be carried out.

Passive scour protection systems can safeguard the areas of scour by covering vulnerable areas with material of sufficient weight or form to resist erosion velocities. These systems generally take the form of rock-dumping or concrete mattresses placed around the scour area.

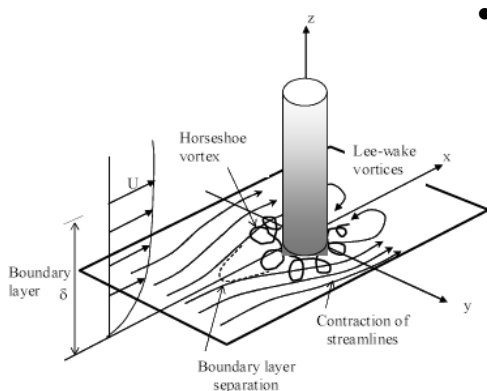

Figure 1
Flow around the base of a vertical pile

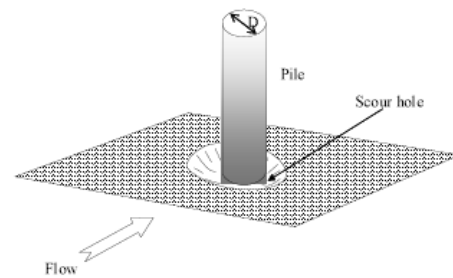

Figure 2
Scour hole around a vertical pile

Figure 8.11: Scour Illustration from DNV OS J 101 2007 [Ref. 8.9]

Active systems attempt to reduce the local flow regime around scour protected equipment. These systems usually take the form of artificial matting with PVC “seaweed-type” fronds which slow the flow, encouraging deposition of sediments. If the scour systems can be securely attached to the seabed it requires little maintenance, and encourages sediment buildup until the fronds are completely covered.

The Figures 8.11 above are extracted from DNV OS J 101 2007 as illustrative of the fact that the J-Tube which sleeves the submarine cable in its exit from the tower should be placed below the area identified with a potential to scour or should lead out from it far enough that scour protection can be put in place.

A particular issue noted in the BOEMRE Report [Ref. 6.4] shows an example of erosion at an offshore wind farm cable in its Figure 5-2 where a section of the export cable route (that had scour protection placed because the cable did not achieve the target burial depth due to a hard seabed), shows the cable area is being eroded due to the interaction of the current and the holes left by the spud cans of the installation vessel. Attention to this detail is most important, in that it may go unobserved.

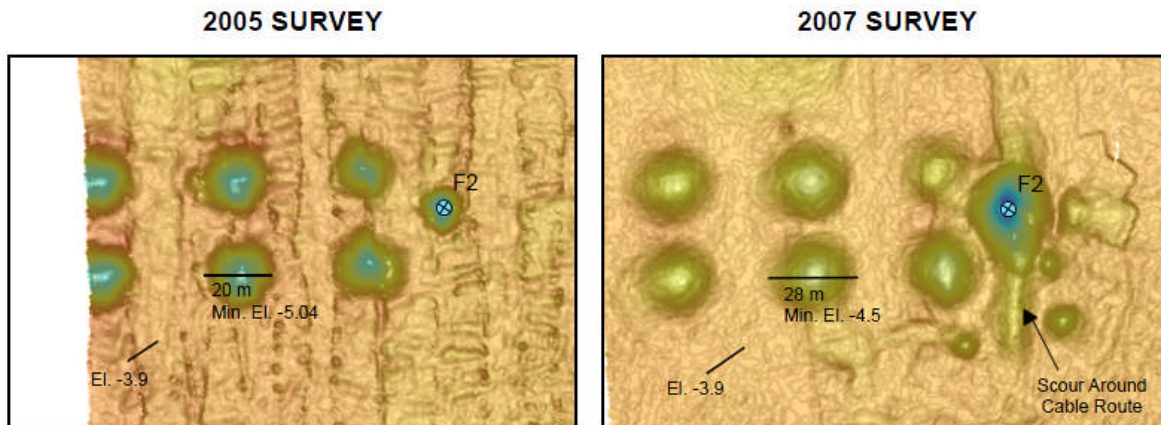

Figure 8.12 BOEMRE Report Figure 5-2

If scour cannot be avoided on the cable route it is necessary to evaluate the methods of protection. When scour protection is needed it is often in the form of layers of natural crushed rock. This form of scour protection is relatively simple to install and provides sufficient flexibility to adapt to future changes over the longer timeframe. The rock itself is an environmentally friendly material that will not degrade through the life of the turbines.

The design of the scour protection can be separated into the following issues:

- Grading of armor rock (to get a stable top layer under design condition);
- Grading of filter layer(s) (to avoid washing out of the seabed soils through the rock layers);
- Thickness of different rock layers (to avoid washing out of the seabed soils through the rock layers);
- Horizontal dimension of the scour protection (to secure the soil at sufficient distance from the cable path).

For the design of the rock grading, the combined shear stresses from currents and waves is needed. Calculations can be performed to identify the correct rock size based on metocean conditions, and velocities at the seabed. This results in a required minimum average rock size where 50% of the rock passes through the prescribed filter screen. A standard rock grading that fulfills the requirement of this average rock size is then taken for the “rock armor”. The required number and grading of the filter layers depends on the dimension of the “rock armor” and the seabed soil. The layer thickness of the both “rock armor” and filter layer(s) is then determined with a standard formula depending on the average rock size of the grading used in that layer.

The introduction of the scour protection on the seabed results in increased turbulence at the downstream side of the scour protection. This increased turbulence introduces scour of seabed material at the edge of the scour protection. The resulting scour gash partly undermines the edge of the scour protection. Some of the rock will relocate thereby stabilizing the scour slope.

8.8 Post Installation Survey

A post installation survey is imperative to cable protection assuring the cable is lying in the bottom of the trench and is adequately buried. It is particularly important to carry this out with sufficient accuracy if it becomes necessary for the cable to be retrieved and/or repaired or if there is work to be done nearby it. Recording the exact location of the cable and communicating that to those transiting the area is a crucial mitigation of the risk and thus protection of the cable. It can be done by sidescan sonar, or with a cable locating device (electromagnetic field detection or metal detector).

8.9 In-Service Inspection Plan

As part of the In Service Inspection Plan (ISIP) a number of prepared joints with spare cable and spare terminations should be available. The amount of spares depends on the perceived probability of failure or damage, and the time to obtain spare parts. Plans for vessels and tools should be thought out within the ISIP to understand if specialized tools or equipment may be needed and to track where they may be obtained in the world market (particularly in the initial stages of development of the US industry).

The plan should encompass:

- Plan for re-surveying after potentially extreme events that may disrupt the cable;
- Temporary procedures in case of being unable to affect permanent repairs;
- Safety hazards involved in repair and re-installation;
- Notification of authorities;
- Methods to determine the distance to the fault and availability of instruments to do so. Time domain reflectometry pulses may be able to determine the distance down the cable that the fault occurred but this technique if it is intended to be used must be thought out ahead of time so the devices can be located that can conduct such a test.
- There are many ways to repair a failed cable that depends on a number of factors such as the distance from shore, depth of water, age and condition of cable. Repair methods should be detailed in the In-Service Inspection Plan.
- A video survey is recommended to be made of the cable route prior to commencement of the trenching, and afterwards, particularly in the area of the cable entering the J-tube. It is also worth considering a multi-beam echo sounding map of the seabed and a possibly a sub-bottom profile providing certainty about the burial depth. Any or all of these provide useful comparison for the future repair and remediation.

Subsequent to the laying it will be necessary to monitor the route periodically (depending on location e.g. in the spring). The frequency of cable burial inspections depends on the seabed dynamics. In case of migrating sand waves or scour hole developments, twice per year may be a recommended minimum. After the first few years the inspection frequency could be reduced if the cable cover appears stable [Ref. 8.8].

It is recommended an In-Service Inspection plan be presented for such monitoring at the time of installation complete with the as-built information.

8.10 References

- 8.1 Mole, P., Featherstone, J. and Winter, S. (1997) Cable Protection – Solutions Through New Installation and Burial Approaches. SubOptic '97. San Francisco. 750-757.
- 8.2 Cable Installation Study for DOWEC, Van Oord ACZ, DOWEC-F1W1-RH-01-033/00, November 2001.
- 8.3 Aubeny, C.P. and Chi, C-M., (2010) “Mechanics of drag embedment anchors in a soft seabed,” ASCE Journal of Geotechnical and Geoenvironmental Engineering, vol. 136, No. 1, 57-68.
- 8.4 Aubeny, C.P., Kim, B.M., and Murff, J.D. (2008) “Prediction of anchor trajectory during drag embedment,” Intl. J. Offshore and Polar Engineering, Vol. 18, No. 4, pp 314-319.
- 8.5 Allan PG and Comrie RJ, Risk Assessment Methodology and Optimisation of Cable Protection for Existing and Future Projects, SubOptic 2004, Monaco, March 2004.
- 8.6 National Civil Engineering Laboratory, Handbook for Marine Geotechnical Engineering, Dept. of Navy, March 1985.
- 8.7 Allan, PG. Geotechnical Aspects of Submarine Cables, IBC Conference on Subsea Geotechnics, Aberdeen, November 1998.
- 8.8 Ploeg A., Ovento- Private Communication.
- 8.9 DNV, Risk Assessment of Pipeline Protection DNV-RP-F107 March 2001.
- 8.10 ABS Guide for Building and Classing Subsea Pipeline Systems and Risers 2001, Chapter 3 Design Section, 6 Routing, Installation, Construction and Testing 3-6.
- 8.11 Recommended Practice for the Design, Construction, Operation, and Maintenance of Offshore Hydrocarbon Pipelines FOURTH EDITION, DECEMBER 2009.
- 8.12 Retrofit Cathodic Protection of Marine Pipelines Associated with Petroleum Production, <http://www.boemre.gov/tarprojects/242/242ab.pdf>
- 8.13 Report of Best Practice of the Common Ground Alliance (www.commongroundalliance.com).
- 8.14 AT&T Asia America Gateway Project) www.slc.ca.gov/division_pages/depm/depm.../AAG_Attachment_1.doc
- 8.15 Technical Review Report (ESS) of the Application of Champlain Hudson Power Express, Inc., for a Certificate of Environmental Compatibility and Public Need.
- 8.16 Mooring Design, Dept. of Defense Handbook, MIL-HDBK-1026/4A Anchor System Design Procedures 1 July 1999.

9.0 INSTALLATION CONSIDERATIONS

Appendix D provides information, when available, on the vessels and equipment used for the installation for European offshore wind farms, mentioning some of the features of those vessels.

9.1 Installation Vessels

For the cable installation the following equipment spreads are typically required:

- cable-lay vessels including cable handling tray, tensioners, winches, cranes etc.;
- burial tool (plow, jet), including auxiliary equipment;
- support vessel with crane, ROV and diving crew;
- anchor handling tug with survey equipment;
- Shore spread including winch, bulldozer, backhoe, and possibly drilling capability depending on the landing site.

Typical vessels used to date have been listed in Appendix D, together with salient features of those vessels.

Installation considerations include:

- Planning for appropriate weather windows for installation;
- Ensuring that the soil characteristics of the selected route are sufficient to guarantee no problems;
- Ensuring that the pre-selected vessel configuration is the same as that anticipated when the cable was designed;
- Ensuring no damage during loading;
- Avoiding cutting and running when weather /vessel combination cannot work together (depends on dynamic motions of vessel);
- Avoiding cutting and running to avoid a collision from on-coming traffic;
- Ensuring no kinks during deployment;
- Ensuring the trench is deep enough, that the cover is sufficient, and that the cable is deployed in the bottom of the trench.

Primary factors influencing the successful laying are:

- Size, power and characteristics of the vessel (s) and their equipment;
- High competence and training of the experienced crew;
- Vessel appropriately equipped for carrying out cable splicing and repairs in case of a need;
- Competence, skill and availability of Joints in the case of a need: the cable supplier may be a source of some competent jointers and installation advisers.

- Clear communications between the parties on board the flotilla.

While there have been several incidents of cable installation issues in Europe, it is important to stress that the installation considerations for the U.S. locations may increase the probability of an incident for a number of reasons. A study by Hagerman [Ref. 9.1] shows an average significant wave height of 2 meters could be expected off the East Coast, whereas there is a general limitation to the cable laying vessels of about 1.2 meters [Ref. 9.2]. The West Coast is subject to long swells which may affect the motions of a vessel laying a cable. Several locations may have strong currents or the area may be affected by strong winds and/or breaking waves, again, impacting the vessel's ability to have a smooth laying process. The probability of not getting the installation correct, of having damage or kinks in the lines that remain unknown until commissioning may be low but is of high consequence.

There can be significant variation in cable length, diameter, stiffness, weight, handling requirements, storage and burial methods (to name but a few) between the inter turbine cable and the export cable as chronicled in Table 1.2. Because of these differences in physical and dimensional characteristics, a single vessel specified to meet the lay requirements of both the inter-turbine and export cables may not be appropriate for efficiency reasons. Barge motions for flat bottomed vessels offshore in shallow water can be high, whereas draft restrictions prevent larger vessels coming in-shore.

Installation of power cables has traditionally been performed by a specialized cable-laying vessel, with an integral turntable or reel for storage, equipment for proper tensioning of the cable, dynamic positioning for precision maneuvering, a trencher, and a crew with experience in cable laying. For lengths of cable that cannot be manufactured and shipped in one piece, a clean jointing room is required in which to perform the splices. The cable is then laid directly from the coil into the water through a roller system which is necessary to avoid kinking. For laying the cable into deeper water a special cable laying unit which coordinates the laying speed and braking of the cable is required (Courtesy Nexans). The installation and burial of submarine cables can be 1-3 times the cost of the cables themselves.

A few of these vessels are in use in Europe and Japan but none is currently stationed in the US. For instance, for the HVDC New York – Connecticut Cross Sound cable (2002), a cable-laying vessel was brought from the Netherlands.

While there is a reasonable number of cable vessels listed globally, the majority of cable vessels in the world in recent years have involved laying small diameter fiber optic telecommunications cable in deep water. This has required vessels with large storage, capable of laying small diameter light, flexible cables over long distances. Propulsion requirements for those vessels are for speed rather than for deployment of heavy electrical cables in shallow water, and the motion responses of such vessel are unlikely to be tuned to shallower water operations with very much heavier power cables. Jointing equipment on board is also likely to be geared for lower cable size and weights.

The ability of the cable vessel to work depends very much on the height and period of the sea, wave direction and natural period of the vessel. Refurbishment may take into account devices to decrease motions on a vessel: Voith has been experimenting with thrusters to change vessel motions; a slo-roll system uses air tanks on either side of the vessel in a unique way to change motions; a number of

other patented ways exist to improve the motion characteristics. On the west coast of USA, for example, the long swell waves will take their toll on the motions since the period of the vessel roll or pitch may coincide with the wave period. In all instances the cable laying vessel will have to be carefully chosen accounting for the normal wind, waves, and current expected at the time of the scheduled laying. The ability of the vessel to maintain station will be compromised by bad weather both with anchored barges or dynamically positioned vehicles. When there is a loss of stationkeeping the cable is subject to the possibility of kinks and twists or to having to be cut, then involving a lengthy time for jointing.

The cable burial equipment must be up to the job and that not on the limits of its capability. It is often useful to have equipment that can bury cable deeper than anticipated. “Vessels-of-opportunity” are tempting in that they are often on-site, and sometimes with local knowledge; however from a practical standpoint it is very important to have experience with cable laying. Changing anchor positions with inexperienced crew generally leads to significant issues, delays and damage: anchors are not placed properly and do not hold, the vessel backs up and causes a kink etc.. Keeping the appropriate tension on the cable while deploying it in various conditions where over-tension can lead to pull-out of the cable needs an operator with significant experience.

For offshore wind farms it has been possible in Europe, though perhaps not as efficient, to lay the cables with barges adapted for that purpose. The operation of these barges takes a very experienced crew since many of the automated processes used on a cable ship are not available on the converted barge – i.e. the cable laying system is not linked to the positioning system as it is on a dynamically positioned cable-laying ship. It is important to have the capability to lay the entire export cable to shore in one continuous activity. If the vessel needs to be stopped to joint another section of cable or repair damage occurring during loading and installation, it is effectively immobilized while that activity takes place, and subject to weather conditions and the traffic risk in the area.



Figure 9.1: Cable laying within a wind farm (Courtesy Nexans)

The inter-turbine cables required are laid in shallow water, in short lengths (0.5 to 2 km) and have to be connected into each turbine structure in a field of perhaps 100+ turbines. Cape Wind, for example has 130 turbines, and will be connected with 65+ miles of 5.2”-6.5” diameter cable. The export lines involve 7.75” diameter cable. The cables need to be buried for protection and the shore end will usually have to be brought ashore by manual methods and be connected to one or more shore sub-stations.

Crew competence needs to be of the highest order on the installation vessel. The planning needs to be meticulous. Clear communication between all parties on board should be worked out ahead of time as there is no time to clarify things when something starts to go wrong. The presence of the cable essentially constrains the vessel to a relatively small area and a single course or heading. Since it is very expensive to cut and splice a cable unnecessarily, cable-laying vessels are often considered immovable obstacles to other sea traffic due to this constrained maneuverability. At Scroby Sands an export cable had to be cut during laying due to adverse weather, and there may not have been unanimous agreement on board as to that action.

A rather marvelous account of the problems with cable laying, and dealing with on-coming traffic is reported in “Operation Channel Cable” by Capt. D.T. Smith, Elder Brother of Trinity House, Seaways, August 1984. This was an account of how during the construction there was no end to the troubles that the project team had in ensuring that vessels did not run down the project team and construction as they laid their cable in the heavy traffic of the English Channel in fog, with vessels bearing down on them taking no account of warnings including rockets launched across the bows to attract attention. The efforts put into the exercise of warning the seafarers heading for the cable laying spread was Herculean, and the near misses were frequent and astounding.

Barges and supply vessels can be converted to lay power cables. Barges without their own propulsion have to rely on anchor handling tugs and winching-in of anchors to move them along the cable route. Backing up results in kinks in the line, so it is important to have this work as a smooth operation. Anticipating there are occasions that the anchors may not hold a contingency plan needs to be at the ready. Vessels with sufficient bollard pull to operate the plow are frequently not easy to locate. The ideal vessel is one with dynamic positioning capability, but may not be available economically at the time installation starts in the U.S. locations.

9.2 Trenching and Burial Equipment

There are a variety of trenching methods and there are new techniques being developed regularly. On rocky shores the cable is often drilled in a horizontal distance and to a depth where burial is feasible subsea or rock berms can effectively protect the cable. It is possible to saw cut a groove into rocks to provide a suitable protection for the cable (see Appendix E). In sandy areas seabed plowing is customary.

The keeping of accurate burial records is critical to being able to return to the location in case of repair, and to advise others of the precise location of the cable. It may be useful to have an independent 3rd party to sign-off on the installed cable as-built maps.

Cable burial can take place simultaneously to cable laying (in-situ) using a cable plow, or after laying (post-lay) using an ROV with a cable jetting or trenching capability. Burial plows normally require large handling and recovery equipment (10-20 tons) and are less easily mobilized on any small cable laying vessel. ROVs have the advantage of being smaller when compared to a plow and capable of being easily mobilized to the vessel.

9.2.1 Mechanical Plows

The seabed cable plow is shaped much like an agricultural plow, has a pointed end which cuts into the seafloor and provides a narrow slit into which the cable is fed directly behind the plowshare (a V-shape which provides the cutting edge). Plows are usually towed from a surface vessel by a towing vessel. The typically available plows have been able to trench down to 1-2 meters but recent new designs can reach down to 3+ meters depending on the site specific soils. Originally designed for specific application for pipelines there are a few plows that can trench much deeper. Plows can be damaged when they come across rock unexpectedly, or if the terrain is hilly they can and do turn over. The soils studies are very important to understand what terrain the plow will work in. The installer should have input to the geophysical campaign to ensure that the equipment selected is appropriate to the terrain.

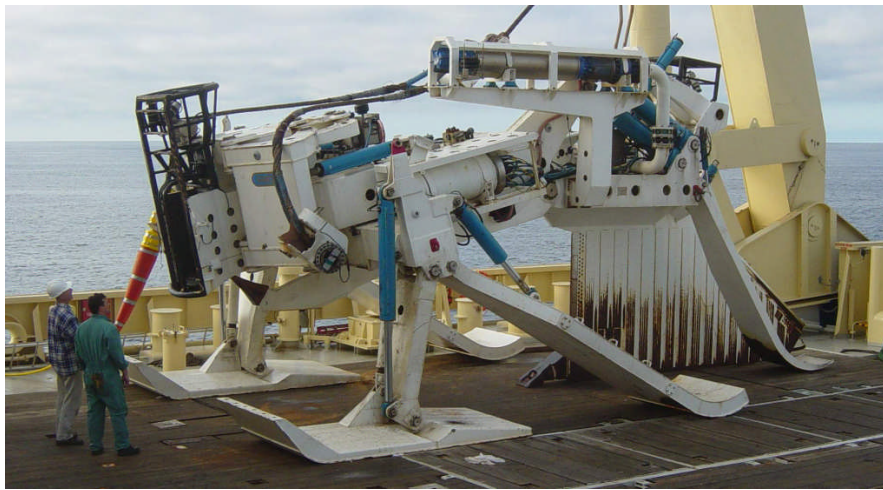

Figure 9.2: shows a plow as per Figure 9.3, providing a better view of the details of the “share”.

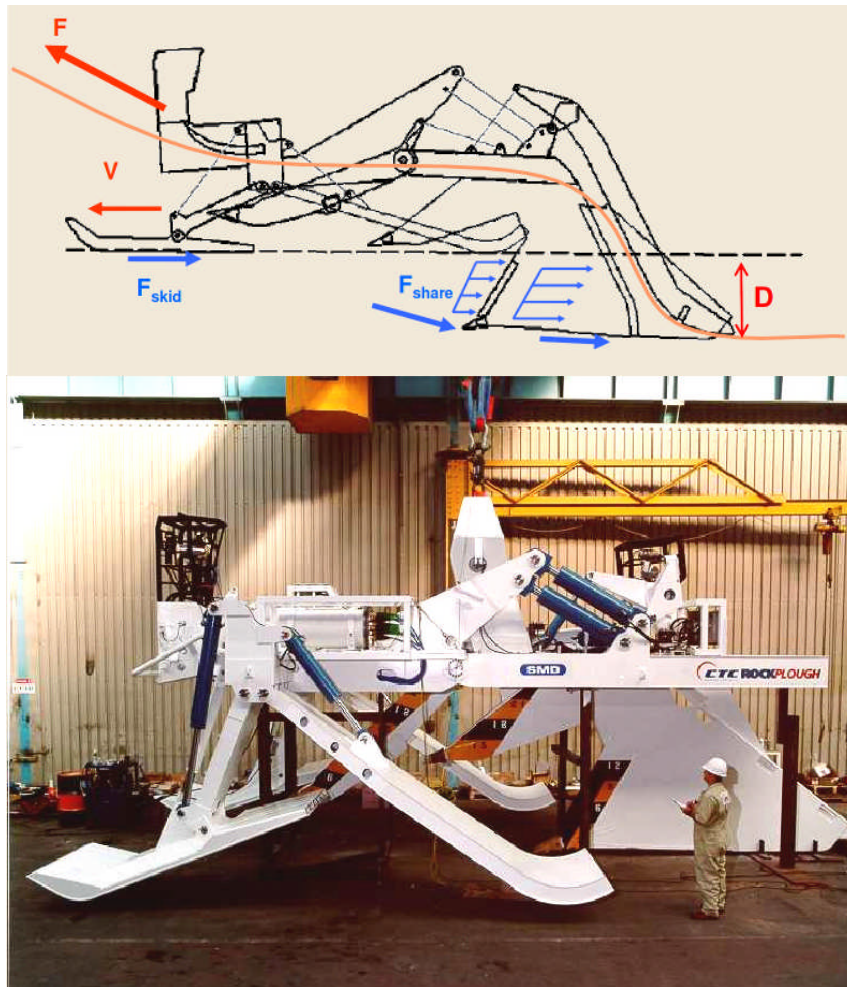

Figure 9.3: Plow showing forces in Cartoon (above) and plow below: note the “share” is the “plowshare” which is a V shape tip that cuts through the soil.

Offshore deployment may be by winched barge where the anchors are placed by tug and the barge moved, anchors placed anew and the barge moved and so on. A sizeable tug with the horsepower to pull the plow simultaneously while burying the cable is often used jointly with the barge.

A plow which has been used extensively on submarine cable installations at offshore wind farms is the Sea Stallion (See Figure 9.17). Its specification includes a maximum burial depth with sinkage of 2.0 m. holding a cable diameter up to 200 mm. The bollard pull is recommended at approximately 50 tons (about 5000 HP tug). It can operate in a wide variety of seabed environments, ranging from sand to firm clays.

Minimum burial depths are specified for each project (often a single value in Europe often set using the industry standard Burial Protection Index) suited to local seabed conditions.

Each plow may have one or more forecutters depending on soil conditions. These additional cutting tools reduce the tow force required to cut the soil, particularly in dense, impermeable sands and stiff clay. Some plows are fitted with cutting tools which are raked forwards, with the forces generated by the soil when under tow which keeps the plow in the ground providing minimal tendency for it to be pulled upwards to benefit appropriate penetration.

The burial depth is controlled by raising and lowering the front skids, with two large hydraulic cylinders. As the plow is pulled forward the weight of the plow and soil force the plow to dig deeper until a sufficiently large heel force is generated so the plow is running horizontal. The cable is loaded into the plow on deck before the plow is launched, with the cable routed through the bellmouth and down the back of the share where it emerges from the aft of the plow, forming an “S” curve.

An experienced crew is necessary to monitor the cable laying, ideally with instrumented winches. One must be cautious to monitor as the cable passes through the plow since the residual tension in the cable will increase which can result in the cable being laid in such a way as to be suspended over hollows on the seabed. The residual tension needs to be high enough to avoid any slack which could lead to loops forming in front of the plow providing a snare, yet the tension must also be low enough to keep the cable stresses within allowable limits and allow the cable to follow the contours of the seabed.

Overbending the cable is also a risk. Both the design and operation must be such as to ensure that the plow leads the cable over a greater radius than the minimum for which the cable is designed. A plow depressor keeps the cable in the share to make sure it departs from the plow at the bottom of the trench. The trench behind the plow fills in, but this, of course is something to double-check after installation.

Depending on the type of soil, the forces for some of these plows can be high, reaching 100-180 tons. There are few tugs or anchor handling tugs that are capable of this horsepower (10,000 - 18,000 HP) in the United States and thus this aspect will have to be thought out early on.



Figure 9.4: Pipeline Plow

Primarily for pipelines, Figure 9.4 shows the EPTM Advanced Cable Plow capable of reaching 4 meters.

The geometry of these various vehicles must be kept in mind. The distance between legs of the plow (fore and aft) determines the burial depth. If the geometry is such that the forward legs go over a hump, the burial depth may be increased or decreased from the flat surface deployment of the cable. Depending on the steepness of the surface both going up the hill and down the hill, the burial depth can vary. This is very important when laying over sand dunes. More in-depth discussion is given by P.G. Allan [Ref. 9.8].

Plows have some particular advantages including being essentially passive equipment, therefore requiring minimum on-board power and able to be towed for considerable distances and times between recovery.



Figure 9.5: Sea Stallion 4 Cable Plow Burying North Hoyle Export Cables up the Beach
(Photo courtesy of The Engineering Business Ltd)

Under ideal conditions good conditions, mechanical plows can trench and lay cables at rates approaching 60 ft. per minute.

9.2.2 Jet Plows

Jet Plows carry a sword of water nozzles and use pressurized sea water from water pump systems on board the cable vessel to fluidize sediments long enough to deposit the cable which sinks down through a slot much like the plowshare. The water nozzles are directed to maximize the trench depth. The cable settles into the trench under its own weight to the planned burial depth. The trench is typically trapezoidal 4-6 ft. at the top to a depth of 8 feet or so below the bottom for a 6 ft. burial depth. Greater depths can be achieved if required. The jet plow embeds the cable system in such a way as to also maximize the gravitational replacement of the suspended sediments within the trench. The suspended sediments solidify over the cable.

Jet plows can also be used to bury a cable that has been pre-laid on the seabed. Some plows can be configured to engage the cable while jetting while others jet alongside the cable. In both these cases it is important to know when the cable has reached the appropriate target depth. This technique must usually be used to bury a cable post-repair.



Figure 9.6: Cable Jetting device. The sword carrying water nozzles is visible and working.
(Courtesy of L D Travocean, France)

The jets create a powerful force to fluidize the soil often providing water flow up to 1000 m³/hr. at 5 bar or 700 m³/hr. at up to 7 bar. Sufficient power is required on board to provide the water flow and pressures.

Some jet plows can crawl along the seabed, and provide their own power through umbilicals. Depending on the seabed the jet plow can progress at 10-30 ft. per minute.

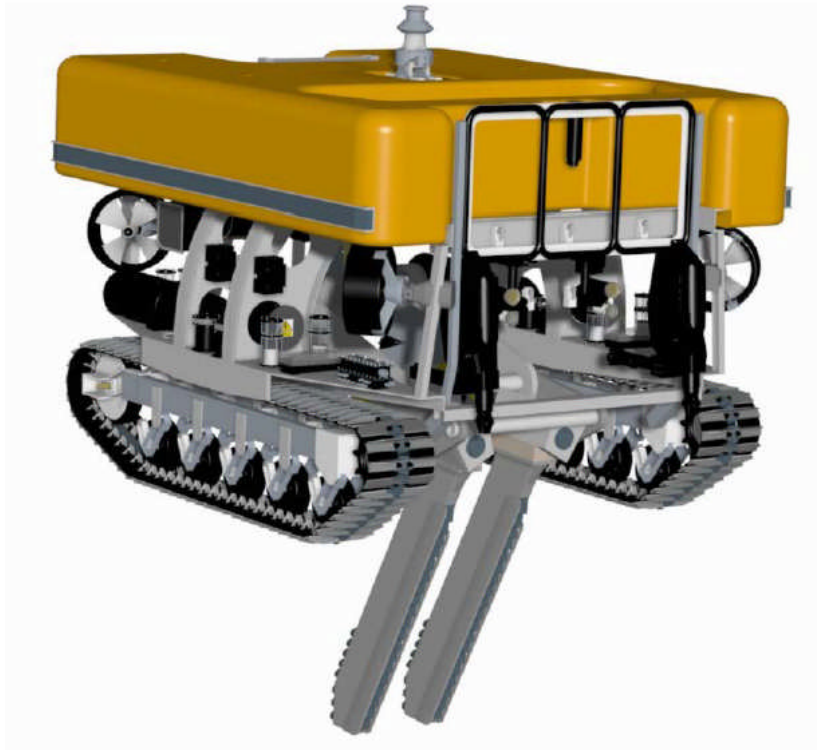

Figure 9.7: Jet Plow - Perry Slingsby.

Jet plows of the type shown in Figure 9.7 are equipped with 400-500 hp, can provide 4000+ gallons/minute at a pressure of 140 psi and can be propelled at approximately 100 ft. per minute (1 knot). These systems have been designed to offer burial in 100 kPa (2 ksf – soft clay) soils and trench depths of up to 3 meters in non-cohesive seabed conditions. Although primarily tracked trenchers, these vehicles are capable of operating in free-fly mode to carry out trenching.

Jetting is widely used for burial of cables near crossings of existing pipelines and cables, as well as in very soft clays which may not be able to support a plow. Jet plows have an ability to bury a cable already laid on the seabed and able to operate close to existing installations with minimum risk of damage.

During the installation of the Q7 wind farm in Holland, sandy soils were trenched at approximately 3.3 m (10.8 ft.) per minute in the shallow nearshore, and 10.2 m (33.5 ft.) per minute in the deeper portions using an ROV-based jet plow (Subtrench Pty Ltd., 2010) [Ref. 2.4].

For extreme situations plows exist to provide cable burial to up to 30 m.

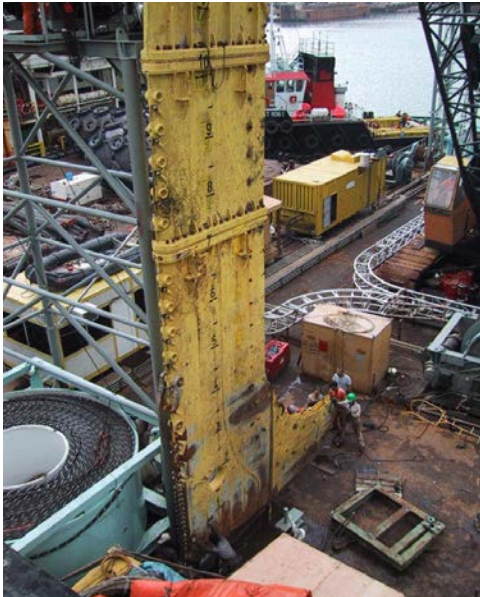

Figure 9.8: Oceanteam Vertical 30m Jetting Tool
[Ref. 9.7]

9.2.3 Rock Saw

Methods are available for special circumstances. A rock saw has to be operated within diver limitations but can chomp up a trench of up to 4 m. dependent on seabed conditions, primarily chalk, coral, sandstone and limestone only. The saw is essentially an underwater chain saw that saws through rock along the cable route. Speed is slow typically 6 ft. per minute. Backfill may have to be brought in to fill the trench above the cable, depending on how fineness and roundness the particles being cut. Figure D.4 shows the rock cut at shore for the Blyth Offshore Wind Farm cable coming ashore.



Figure 9.9: Wheel cutter for rocky sea floor
Cable trench cut into calcarite sea floor (Courtesy of L.D. Tranvocean) [Ref. 3.36]



Figure 9.10: Rock saw can reach down 4 meters in soft rock

9.2.4 Dredging

Dredging can be used, as shown in Figure D.5. This is particularly useful in harbor or where contaminated sediments are present that have to be disposed of elsewhere. Dredging can be carried out using a clamshell, or can be pumped to a ship and either cleaned and returned or offloaded to a dumping barge.

In case of sandwaves present in the area, a suction hopper dredge can be deployed for pre-sweeping of the cable route, however, the dredged sand must be disposed of (see Section 2.5).

9.2.5 Horizontal Directional Drilling

The area near shore may be rocky or otherwise unsuitable for trenching. As the cable comes ashore it may also be necessary to increase the cable size due to thermal effects (being out of water). In such circumstances it is often necessary to drill the cable conduit in from shore. The limits on horizontal drilling are about ½ mile or about 1000 meters by conventional equipment. This is a much slower method of deploying the shore cable. The horizontally drilled area is generally protected with a suitable conduit pipe to protect the cable with sufficient spacing to prevent heat build-up typically with a diameter 5+ times the cable diameter.

9.2.6 Interface at the Turbine

Prior to installation of the turbine foundation, there is a need to have prefabricated arrangement for the pull-in of the cable. These arrangements include the internal J-tube to allow pull in without exceeding the bending limitations of the cable.

This can be pre-installed but has to be fabricated to withstand high shock loads during pile driving, or can be post-installed once pile-driving is completed to avoid heavy bracing structure (shock loading up to 1000*g have to be accounted for). The installation covers the following activities:

- Connection flange for the external J-tube extension;
- Installation platform on top of the foundation, to be installed once pile driving is completed. This platform must include fixed position points for a pull winch and powerpack;
- Preparation of several winch/powerpack units for the pull-in of the cable.



Figure 9.11: J –Tube assembly.

The installer is then faced with some of the following issues ensuring there is:

- enough space near the J-tube to accommodate the cable;
- enough cable being supplied as part of the customer order to lay on the seabed to accommodate an extra length for potential repair as many have been damaged during pull-in;
- sufficient slack to accommodate the pull-in tensions which should be been calculated prior to cable order;

- sufficient headroom and what possible conflicts there are with the equipment needed to carry out the pull-in;

Many of the J-tubes are of different sizes, and sometimes manufactured without due notice of the required cable sizes. The bend radius of the J-Tube needs to follow the cable manufacturer's instructions typically to be about 2 - 2.5 times the diameter of the cable. It must be large enough to accommodate the cable but during operations the heat generated by the cable both in water and in air decreases the longevity of the cable. The inside must be very smooth without welding beads or other obstructions. A winch (must be strong enough) is used on the wind tower to pull the cable up through the J-Tube, the cable having been sealed against water ingress prior to deployment to the bottom of the J-Tube. Divers or ROVs are often required to feed the cable in without snagging the end of the J-tube. Corrosion inhibitors can be put into the J-tube if it is sealed at the bottom, and creating a draft in the upper section with openings above waterlevel.

In meetings with industry personnel it was indicated that many of the issues with installation on offshore wind farm cables circle are around the issues with the J-Tubes. There are no standard sizes and shapes of J-Tubes with fairings differing and the size of J-Tube to size of cable differing as well as the angles of approach. There is some documentation of this in the literature but the indication is that there is more of this on site, than is generally reported.



Figure 9.12: J-tube laid on side during construction

The cable being fed into the turbine structure must be delivered below the scour depth with a lead coming up the pre-installed conduit or J-tube to allow the cable to be pulled onto the turbine/platform.

The following sequence of actions is envisaged to complete the tie-in of the cable. The sequence is based on the use of a monopile foundation with internal J-tube. If a different foundation is chosen, the details will differ but the sequence of basic actions remains the same:

- Installation of the J-tube horizontal extension with a support vessel / installation vessel;
- Placement of scour protection with a rock dumping vessel (where appropriate).

Once scour protection is completed cable installation can take place, but in principle this can be postponed by any length of time to suit scheduling.

- If not pre-installed, installation of the internal J-tube and placement of the support platform in/on top of the pile with a support vessel.
- Placement of the winch unit on top of the foundation pile and connection of the messenger wire in the J-tube to the winch cable with a support vessel;
- Clearing and opening of the J-tube extension bellmouth and transfer of the messenger wire and winch cable to cable laying vessel using divers from the support vessel;
- Winch cable connected to the cable pull head, the cable paid out and simultaneous pulling from the pull-in winch and deployment using the cable-lay vessel;
- Once the cable is placed fully in the turbine foundation, it is necessary to place the stopper clamp and fix the cable to the installation platform;
- Release of pull-in winch and demobilization of winch-unit and personnel from the foundation to the support vessel;
- Cable lay and trenching of in-field or shore section using the cable-lay vessel;
- Rock protection of transition zone from J-tube extension bellmouth until full burial depth is reached using a rock dumping vessel



Figure 9.13: Photos of the Installation process
(Source: Elsam 2002)

Other products, as shown in Figure 9.14 have recently come on the market that compete with the J-tubes, but there is little published data on their success, however, in enquiries with consulting engineers working on UK wind farms there is a belief that they do have merit.

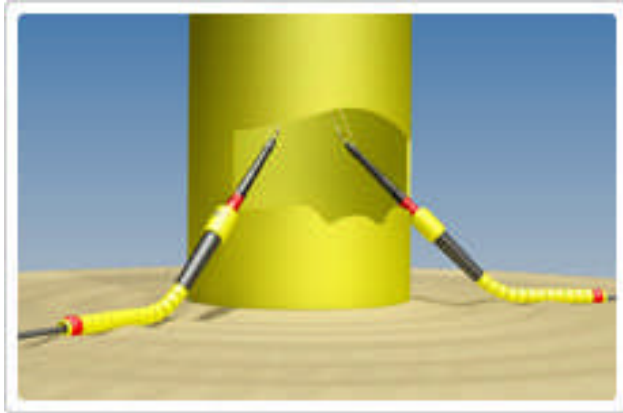

Figure 9.14: TEKLINK® Cable Protection System.

This system introduces the cable into the turbine at a low level through the pile wall. It has been specified for several German offshore wind farms. It enters through the pile and is fastened through a mechanical latch. There are, of course issues that have to be designed into the pile to accommodate this and the strength around the entry way is likely to have some modifications to reduce the stress. The omission of the J-tube would reduce the overall forces from currents and waves.

In general, the cable for the shore connection section will be heavier and stiffer than the cable for the in-field section. Therefore, a larger cable vessel, fitted with a rotating cable pan & sufficient loading capacity and a larger burial tool are required for the shore connection section than for the in-field section, where a smaller vessel will be more cost effective.

9.2.7 Vessel Functions to Deploy Inter-Array Cables

The following activities need to be considered for the installation of the in-field connections for the various vessels being used:

Cable Laying Vessel:

- Load-out of cable lay vessel with cable lengths and preparation of burial tool;
- Sail to site and take up position at main collection point;
- Pull-in and fixation of cable-head: cable prepared with pull-heads and readied for load-out;
- Lay length of cable to next turbine – last section with floats to buoy up the line;
- Connect messenger wire to floating pull-head;
- Pull-in and fixation of cable tail;
- Deploy burial tool and bury main length of cable section;
- Repeat above for all interconnections.

Diving Support Vessel:

- Assist cable laying vessel with pull-in activities;
- Diver-jetting burial of transition from bell mouth to point where burial tool achieved full burial depth.

Rock Dumping Vessel (if required):

- Place Rock protection over transition zone.

9.2.8 Activities to Deploy Shore Connections

Close to shore if not drilled in, the cable may be deployed by hand, with it suspended by floats from the offshore barge/ship until it is sufficiently far onto the land where initially it may be on rollers going up the shore, and later lifted into the trench.



Figure 9.15: Buoyed Line with cable being brought ashore.

The shore landing includes the traverse of the beach and to the point where the connection to the shore grid can be made. The following activities need to be considered for the installation of the shore connection.

On a slope where the cable has been drilled in either because of steepness or shore sand dunes, a beach coffer dam makes up the connection point with the shore grid. When the connection is completed within the cofferdam, the offshore cable is pulled ashore and guided into the duct.

The following actions complete the shore landing activities:

- Cable lay vessel takes up position just offshore of the landing point;
- Winch cable is brought from the beach to the cable vessel and connected to cable pull-head;
- The cable is paid out, fitted with floaters and pulled onto the beach;

- The cable gets connected to the messenger wire and transferred into the duct and pulled to the grid connection manhole;
- The floaters are removed from the cable;
- The burial tool is placed on the cable as close to the beach manhole as possible and post-installation burial of the cable to intended depth commenced;
- Cable lay vessel continues laying / burying the cable towards the wind farm, or to where the cable has already reached the required depth;

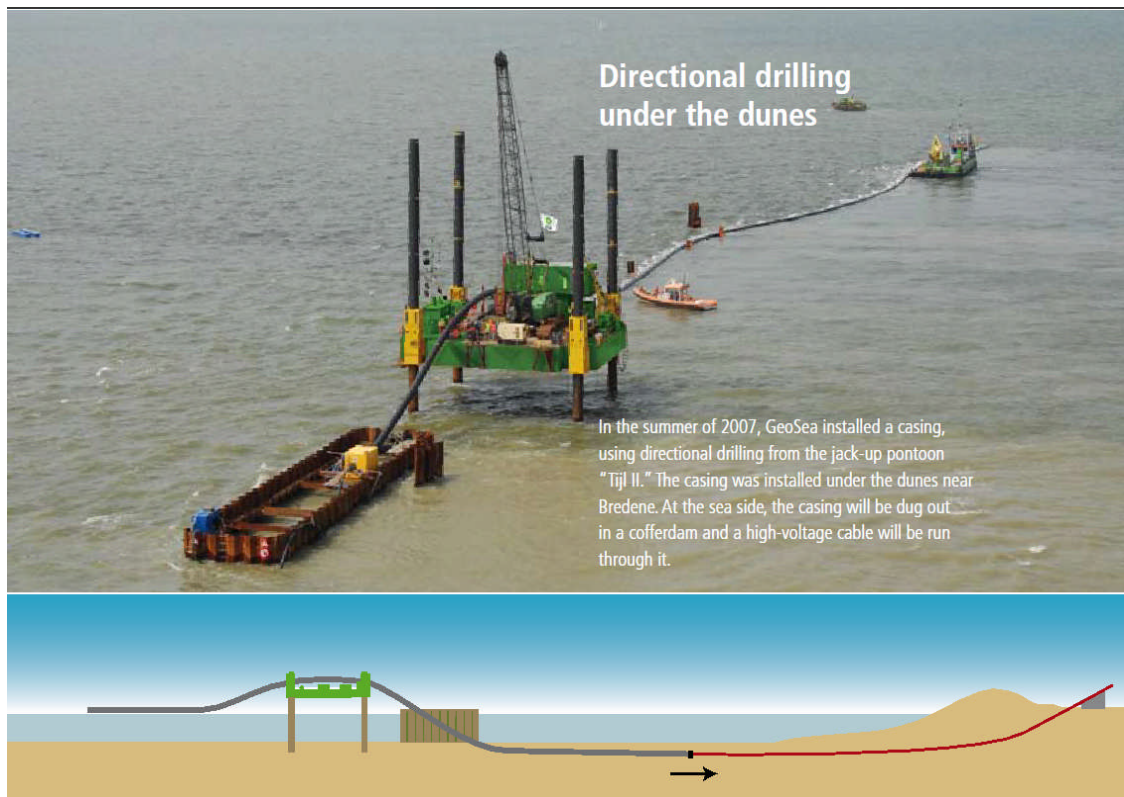

Figure 9.16: showing a connection made in a cofferdam at the beach (Netherlands)

9.4 References

- 9.1 Hagerman George, Southern New England Wave Energy Resource Potential, Building Energy 2001 Conference, Medford Massachusetts.
- 9.2 Carter, J., North Hoyle Offshore Wind Farm: Design and Build, Energy Vol. 160. <http://www.aseanenergy.info/Abstract/31029497.pdf> .
- 9.3 Kaiser, M.J. and B. Snyder 2011. Offshore Wind Energy Installation and Decommissioning Cost Estimation in the U.S. Outer Continental Shelf. U.S. Dept. of the Interior, Bureau of Ocean Energy Management, Regulation and Enforcement, Herndon, VA. TA&R study 648. 340 pp.

- 9.4 www.amtbarges.com
- 9.5 Gilbertson O., Electric Cables for Power and Signal Transmission, John Wiley & Sons, New York, 2000.
- 9.6 Lessons Learned offshore cable installation – Presentation by Alan Readyhough [Idlylic Scene A_Readyhough_Global-Marine-Energy_Lessons-Learned] Global Marine Energy UK.
- 9.7 Oceanteam Power and Umbilicals http://www.oceanteam.nl/uploads/specs/Oceanteam_VI-001_Rev_Ref_4.pdf
- 9.8 Allan, PG, Selecting Appropriate Cable Burial Depths – A Methodology, IBC Conference on submarine Communications, Cannes, November 1998.

10. DOCUMENTATION

The following records should be maintained for operation and maintenance purposes:

- a) Construction Portfolio – detailing the specifications of the material and equipment;
- b) As-built survey route maps with cable depths post-installation;
- c) Management of change log for major changes from the Facility Design report documentation;
- d) Cable installation and periodic surveillance Records;
- e) Break, fault and failure investigation Records;
- f) Records of repairs with documentation;
- g) Records of safety equipment inspection to prevent electrical overloads of line;
- h) In-Service inspection plan and Records.

11. RECOMMENDATIONS

11.1 Specific Information Recommended for Inclusion in the Facility Design Report

1. The submarine export cable is often unique to the offshore wind farm and any damage to it can put the entire field out of service for several months. Depending on the design of the turbine structure the structural survival of the wind turbine towers may depend on the submarine cable(s). If this risk exists for an offshore wind farm it is prudent that it should be well documented in the Facility Design Report and the Safety Management System noting risk to personnel that may potentially be put in harm's way.
2. The Right of Way (ROW) specified in the CFRs is 200 ft. centered on the cable; however for installation vessels requirements/future repair requirements, consideration should be given to increasing this to 250 m. either side of the centerline of the cable when considering a suitably practical right of way beside which another ROW can be issued without any additional spacing.
3. In order to assure "best practice" it is recommended that the Facility Design Report contain a requirement to demonstrate the information exchanges (in both directions) between the electrical and communications cable designers, geophysical /soils consultants, installers, cable protection "designers" because of the interdependencies between task discipline subjects (e.g. cable design, installation, burial depth and cable protection). The Report should also provide detailed minimum bending radius information for the cable, and detailed information on the design requirements for fill volumes of the J-tubes, shore approach ducts or other areas of cable constraint.
4. A recommendation was noted in a BOEMRE study [Ref. 4.21] that the design parameters for the cable be available early on in the project to further research on EMFs. As the research results state Section 4.3 that with one exception of the conductor return path being via the sea, the issue of EMFs is not of technical concern, it is however prudent to have the cable design parameters available early in the project to follow the existing recommendation.
5. Detailed engineering information is to be submitted as part of the Facility Design Report, including information on the submarine cable. It is recommended that the features of design, and installation decisions on the submarine cable be chronicled in a Design Decisions section with a summary of the technical calculations carried out, and a submission of the detailed supporting calculations to the regulator or an appointed CVA. Calculations should include modeling of temperature influences on the cable accounting among other parameters for burial depth and temperature vs. season, water salinity, heat absorption capability of the soil, and effect on nearby pipeline(s) or cable(s).
6. It is recommended that the Facility Design Report lay out the electrical and mechanical tests to be carried out during the factory cable acceptance tests, during commissioning and in service.
7. It is recommended that the cable laying vessel equipment and layout features be identified in the Facility Design Report in order that it is available for cable design. It is additionally recommended that a cable repair plan be provided as part of the Facility Design Report or as

part of the In-Service Inspection plan identifying sources of jointers as well as potential equipment to be used for repair.

8. It is recommended that as early in the project as practical the details be made available to relevant parties for the submarine cable information including the proposed burial depth and armoring required to mitigate the probability of cable damage from recreational vessel, fishing gear or dropped and dragging anchors to an acceptable level while providing sufficient depth to provide the anticipated cable life considering particularly the heating effects of the cable transmitting the power.
9. In areas where a tsunami may impact the shore it is recommended that consideration be given in the Facility Design report to the consequences of scour at the beachfront. It is further recommended that if the cable is to cross a fault line that the mitigation to prevent a break be outlined and rationale for distance of spare cable along the potential fault line or other mitigations be commented on.
10. It is recommended that a specification be developed for an acceptable In-Service Inspection Plan for the submarine cable including a repair identifying sources of jointers as well as potential equipment to be used for repair and including recovery tension tables that describe the maximum recommended recovery speed in given water depth and at a given angle for each soil type at the site.
11. It is recommended that the documents listed in Section 10 Documentation be required to be provided and retained.

11.2 Recommendations for Research Topics

1. A simulation model (Excel based) was developed to predict the behavior of plate anchors to identify the most important parameters for penetration depth, distance, and force required for clay soils [Ref. 7.17], [Ref. 7.18]. This study concluded that far outweighing all other parameters the major effect on penetration depth was the fluke angle with the larger fluke angle resulting in the largest penetration depth. The effect of the different soil types was to change the required force pulling the anchor into the soil: thus for a ship with increased strength of soil the anchor is in, the anchor resistance will exceed the engine horsepower and the ship will either stop or break the chain in a distance which is shorter as the soil strength increases. Previous investigators have assumed that there is a limit to the depth of penetration, or that the initial penetration from a drop is the value to consider: however it does not address directly the issue of ship's anchors, the probability of penetration depth considering variables of ship speed power and inertia, anchor fluke angle, distance of travel, and chain strength. Extending the study of the clay model to encompass clay, sand, gravel and a combination of channel bottoms would be a valuable tool in determining the acceptability of a burial depth as part of the Navigation Risk Assessment.
2. It is recommended that research is carried out to develop guidance on appropriate electrical factory acceptance tests, commissioning tests and in-service tests to provide a comprehensive document for the benefit of the integrity and longevity of submarine cables of the type and voltage used in offshore wind farms cable. The US Corps of Engineers testing requirements [Ref. 2.11] should be considered together with those recommended by CIGRE, IEC and DIN

standards since these have been adopted piecemeal by the German and other regulatory agencies [Ref. 4.9].

3. The Marine Board study [Ref. 1.1] concluded that *to ensure a level of reliability consistent with public policy expectations, the committee believes that the standards must consider design, fabrication, installation, and commissioning from the export cable through to the towers and incorporated systems* and concluded that the CVA scope should include a review of the infield and export submarine cables. It is recommended that research is carried out to formulate a detailed definition of documentation to submit, and scope of surveillance activities (particularly on the fabrication CVA activities) on the submarine cable system either by BOEMRE inspectors or a CVA for the submarine cable. One method of exploring this with industry may be by a sponsored workshop on the subject.
4. It is recommended that the guidance be developed on requirements for onshore and offshore cable signage requirements/ cable warnings/ beacons for notification of submarine cables. This could be formulated for inclusion in the document On the Marking of Man-Made Offshore Structures issued by The International Association of Marine Aids to Navigation & Lighthouse Authorities (IALA) or by the preparation of a Notice to Lessees such as (NTL 2010-P04).
5. The lack of availability of power cable laying vessels for repair of submarine cables in the early stages of the US offshore wind industry is expected to significantly affect offshore wind farm development in the USA by lack of assurance that faults can be expeditiously rectified. It is recommended that this subject should be researched and reported on and includes commercial issues with potential solutions.
6. One issue that arose during discussion with installers was that of the arrangement between cable installers and prior-use owners of telecommunications cables and pipelines who may not easily agree to allow submarine cables to cross their existing facilities where by custom and perhaps by law they are due compensation for allowing the crossing. While not a technical issue, as such, it appears that it may be worthwhile to enquire further on this commercial arrangement and possibly provide guidance if appropriate.

11.3 Other Recommendations

It is recommended that a government entity be identified to encourage the formation of a Committee modeled after the intent of the UK Cable protection Committee in the USA in regions where offshore wind farms are established, to protect fishing interests, and to involve the local regional users of the waterway in understanding the cable issues.

APPENDIX A: HISTORICAL CABLE INCIDENT DETAILS AND REFERENCES

A.1 Arklow Bank

Arklow Bank experienced a cable fault due to an anchor dragging over it. It took a week to repair [Ref. 3.1].

“It is understood that surveys undertaken post installation indicated localized exposures of cables. This was possibly caused by scouring of the superficial sediments adjacent to the bank. It is also understood that the export cable suffered a fault resulting from an anchor contact with a repair being completed within one week. Further cable protection methods are under consideration.” [Ref. 3.2].

A.2 Barrow

At the Barrow Offshore Wind Farm a survey of the export cable in April 2007 identified some exposed sections of the export cable [Ref.3.3].

Further surveys have been done showing the extent of scour and remediation continues [Ref 3.4].

A subsea cable plow was used to bury both the export cables. During the installation of one of the cables an operational incident occurred in which the plow overran and damaged the cable which resulted in the need for an offshore joint [Ref. 3.2].

A.3 Blyth

“In early 2001, there was a cable fault on the link between the two turbines. This was the result of poor installation. The attachment of the cable to the seabed was to be carried out by divers. The installation of the cable was carried out in October and the visibility became poor. The contractor thought enough had been done to secure the cable for the winter and planned to finish the work in the spring. Unfortunately this was not the case.

The cable protection where the cable left the J-tube came loose and slipped down the cable. The current then caused the cable to wear on the end of the J-tube and the cable was cut through. There was sufficient spare cable in the link to allow the damaged section to be pulled into the tower and cut off. However the spare length was at the far end and had to be worked along to the appropriate end. There were three attempts to do this, mainly frustrated by combinations of weather and tides. In the end the entire length of cable was suspended on floatation bags and pulled along with a small tug. Again this was a diver operation and required good visibility. The cable was out of service for approximately three months.

The cable was then secured at intervals to the sea-bed and the supports at the entrance to the J-tubes were supported by shaped cement filled bags. A video of the cable route and securing arrangements was made for reference.

Spare cable for a repair was available but was not needed in this case.

The lessons learned from this problem were;

- *try to use installation methods with no or very little diver intervention*
- *the detail of the cable entry is very important and requires close cooperation between the steelwork designer and the cable laying contractor*

- *detailed repair strategies need to be worked out in advance.”*

“During the video survey it was noticed that the polypropylene outer layer was worn off as a result of current action in a few places during the first winter. The wire armor was not damaged and the cable was secured properly after that winter.” [Ref. 3.5].

“HV Switchgear: The only issue has been that condensation has been observed in the cable termination boxes. The dehumidifier has cured this.” [Ref. 3.5].

“Cambois turbines stalled again”:

“Plans to get Britain’s first offshore wind farm producing power again after a gap of almost three years have been stalled by a further technical hitch.

Rotor blades on the two turbines off Cambois, Northumberland have not turned since March 2006, when the seabed cable connecting them to the mainland snapped.

Two months ago power company E.on said it was about to switch them on again after replacing the damaged cable.

Now it says it will be several weeks before the turbines are ready to become fully operational again, after a brief trial run revealed an internal technical problem which needs to be put right.....

Yesterday an E.on spokeswoman said: “The seabed cabling has all been repaired and re-installed and we switched the turbines back on for a short period to warm them up, after they were off for more than two years. During the warm-up process we discovered an extra internal problem which is being fixed.

“They were off for a long time and got a bit damp inside so we are now doing a full service and hope to have them up and running again, and producing electricity, in the next few weeks.....

The two turbines were built at a cost of £4m but have been out of action since the undersea power cable was snapped by the rocky seabed. Now E.on has replaced the cable, using a different route to allow sections of it to be buried in sand.

The two turbines were previously owned by a green power consortium. In 2002, a rotor blade had to be replaced after it was hit by lightning and in 2005 one of the turbines was out of action for several months after a cable connecting the two machines failed. [Ref. 3.6], [Ref. 3.7].

A.4 Bockstigen

“A number of new technologies were developed and implemented to make the offshore wind farm Bockstigen (Sweden) technically and economically feasible. Through the whole construction process only one genuine technical problem was encountered which was the anchoring of the sea cables. The water current was larger than assumed due to an acceleration of the flow over a ridge and the difficulty to anchor the sea-cable to the sea bed was underestimated. Where large areas of the seabed were free from loose layers it proved necessary to anchor parts of the sea-cable with the use of steel hoops. The first attempt was to use concrete sacs as weights. The second attempt was to anchor the cable with hooks made of 12 mm steel. Both failed and first the third attempt employing 25 mm U-shaped hooks anchored in two holes in the sea bed was successful.” [Ref. 3.8].

A.5 Burbo Bank



“A massive wind farm off the coast of Wirral was out of action for four weeks after a problem with onshore cabling”. A joint in an underground cable connecting to the Burbo Bank farm “failed” and it took engineers four weeks to first locate the breach, excavate down to it and then carry out the repairs” [Ref 3.9].

It was necessary to excavate a damaged 500 meter in-field cable from the seabed” [Ref.3.10].

A.6 Horns Rev

In the Horns Rev installation, and in others that our research discussed with industry professionals there have been a number of issues related to J-tube design which made it difficult to thread the cable. The issues related to pulling methods and appropriate fittings on the tower, access to power and lighting on the tower during construction, and protection of the tower and platform from the elements. The same issues have arisen on other installations involving:

- design of messenger wire and plug in the J-tube;
- water ingress during pull-in;
- J-tube bell mouth design;
- winches and power packs;
- pulling cable from the vessel;
- pulling brackets and padeyes on the turbine tower;
- access and working space on the tower.

although the details have not been documented for public access.

“In the Horns Rev installation there was discussion of techniques for reducing diver operations, including redesigning the J-tube bell mouth, how to recover the J-tube pull messenger wires, and appropriate design of J-tubes to remove risk of blockages.”

“The Horns Rev installation highlighted the need for monitoring cable tensions whilst the cable is being pulled through the J-tube assembly. Also highlighted were the issues of cable drum movements and transfer of cables offshore during construction”.

The IMCA document points out the issue of tidal action in coastal waters being considerable, and that “the divers have had only a few minutes access time at slack water. Sea state must be considered also, as wind farms are generally situated where it is windy!” and infer, particularly for the issue of burying the cable at the J-tube, that diver intervention if needed must be very well planned [Ref. 3.11].

During installation, a construction vessel destroyed one of the interconnection cables in the wind farm: the anchor hit the cable which laid unprotected on the seabed. (Repair Cost: EUR 2 million) [Ref. 3.12].

Horns Rev 2 experienced several problems with terminal strips. Twenty four required replacement before operations commenced and still the wind farm had to be shut down after just two months of operation for further repairs of the terminal strips [Ref. 3.13].

During burial the wave climate proved problematic during the installation operations and it is believed that divers were subsequently employed to bury the cables which were left exposed, particularly close to the turbines [Ref. 3.2].

A.7 Kentish Flats

For the inter-array cable difficulties in burial operation were encountered where the cable installation had crossed spud depressions from the main installation vessel – Mayflower Resolution [Ref. 3.2].

A.8 Lynn and Inner Dowsing

It is noted that there was a cable repair February through to summer 2009. The cable repair was undertaken at Skegness beach on the export cable. The project involved cutting out the damaged subsea joint and replacing it with two subsea repair joints and a length of 630mm² cable. The damaged joint was excavated from the beach and cut out before the cable was lifted on board the repair vessel.

A.9 Middelgrunden

Middelgrunden: “3 accidents with damages of the subsea cables” [Ref.3.18].

Another document reports that at Middelgrunden some of the interconnecting cables were damaged when the foundations were installed. The problem was foreseen with spare cables available [Ref. 3.19].

A.10 Nysted

“A variety of installation techniques were employed. Jetting was used in areas of looser substrates which included sands, silts and clays with shear stress less than 75kPa. Pre-trenching and backfilling was used to cut through areas of harder substrate with back-hoe excavators working from a shallow water jack-up barge [Ref.3.2].

A.11 Robin Rigg

The Robin Rigg project had its setbacks as drill barge was blown away: May 2004

“A jack barge drilling test holes for a windfarm off the West Cumbrian coast was washed off its legs and into the sea this week. Mowjack 3 was standing four metres above the water and was unmanned when it disappeared from its moorings on the Robin Rigg sand bank” [Ref.3.21].

E.on was forced to evacuate its workers to safety from its Robin Rigg offshore wind farm after a cable-laying barge broke free from its anchors in stormy seas.the 42 workers were aboard the UR101 barge at the Robin Rigg wind farm, eight miles west of Maryport, when three of their four anchor cables snapped [Ref. 3.22].

“The jack-up rig Lisa A was being used to work on a wind farm development between Scotland and England. However a rescue operation was launched after fears that the vessel was in danger of overturning in gale force winds on Sunday night. All 38 crew members escaped without injury.

During the operation two of the vessel’s legs bent, causing it to list at over 30 degrees”. The crew was evacuated by crane and the crane operator by helicopter [Ref. 3.23].

A.12 Scroby Sands

The Scroby Sands wind farm is located on an enormous sand bank. Large tides (range 3 m, tidal velocities up to 1.5 m/s) make this area subject to likely scour. In a 30-year period, the sea bottom has changed by 8 m (as measured by the British Admiralty). This provided a probable scour hole of 6-8 m and made a scour protection necessary. The selected scour protection material is comprised of stones installed by dumping from a side-dumping barge.

“Generating capacity was affected following a transition joint failure on one of the three export cables, causing the circuit to be taken out of service for repairs. A replacement joint was promptly installed in the beach. However, during commissioning tests a fault was identified on the sub-sea portion of the cable. The replacement of the sub-sea section of the cable is planned for spring 2008.

Until the permanent repair is affected, the power output is shared between the two remaining export cables. This does not affect turbine availability as the system is designed to facilitate cable maintenance. However there is a reduction in generation as a reduction in maximum capacity applies when wind speeds are particularly high.” [Ref. 3.24].

Other news on BBC reported that part of the promenade on Great Yarmouth’s north parade was excavated to allow repairs to one of the 33,000-volt cables which had failed because moisture had seeped into a connection joint. A worker was treated in hospital for burns caused by an electrical flash while working to repair those cables [Ref. 3.25].

Aside from the cable fault a computer graphic illustrates the consequence of scour which can affect the cabling around the foundation [Ref. 3.26].

- Image from a recent survey at Scroby Sands Offshore Wind Farm in UK
- Red cylinder: 4.2 m diameter monopole
- Image illustrates scour around protection work

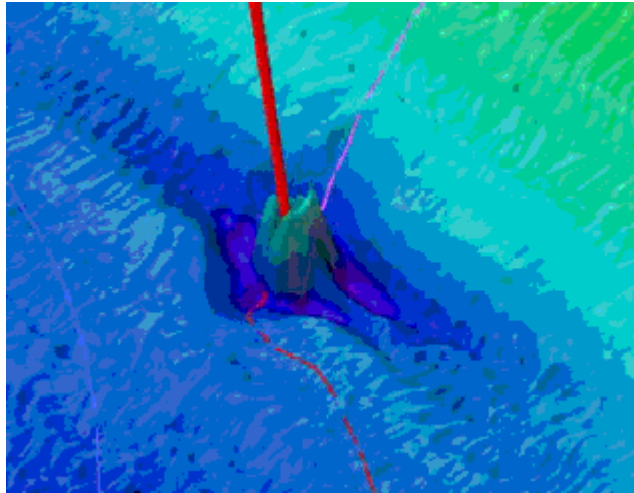

Figure A.1: Scroby Sands Illustration of Scour

Further illustrations of scour in the entire field can be seen in Figure A.2

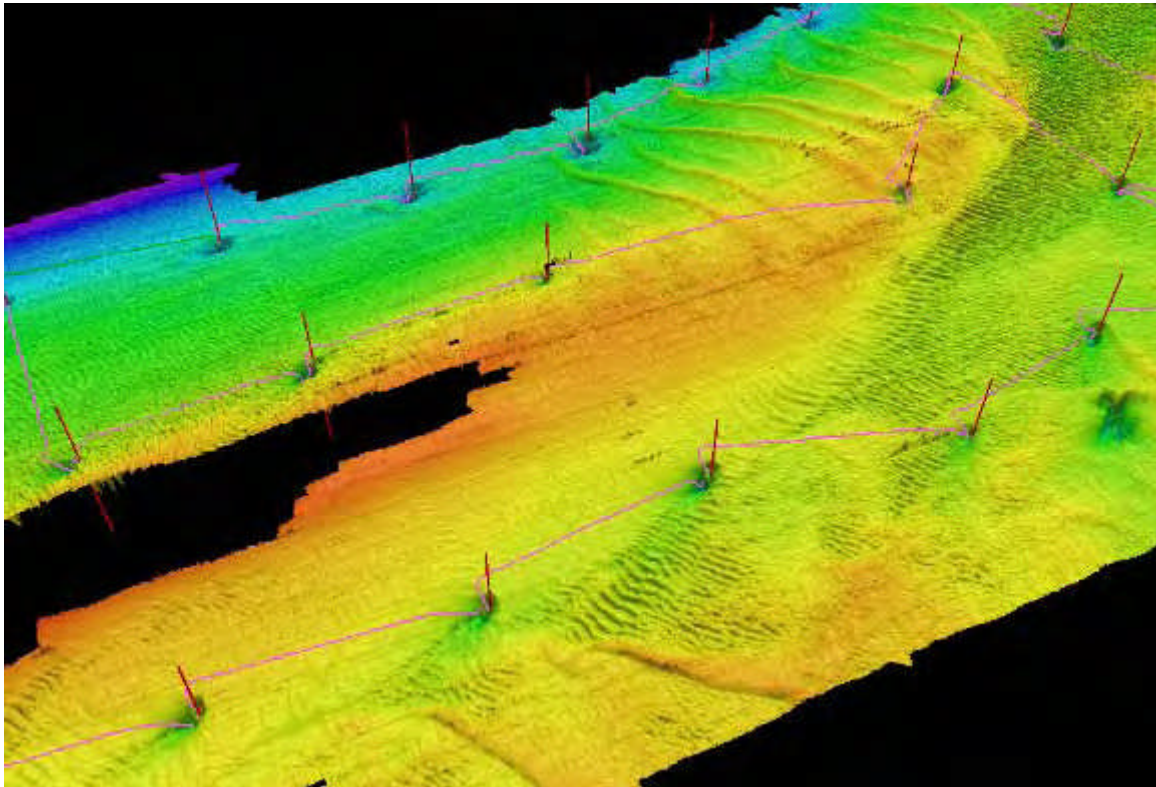

Figure A.2: Fledermaus image showing the survey of February 2005 from the Scroby Sands Offshore Wind Farm.

The sand waves can be seen and the monopiles (red cylinders) and intra-array cable route (magenta) are also shown. In some cases a scour tail extends to the neighboring monopile [Ref. 3.27].

All three export cables were buried to the target depth of 3 m as required by the permit based on EMF concerns and its effect on migratory fish as well as concerns with mobile sands. The second export cable had to be cut during the installation due to adverse weather, an offshore joint was subsequently introduced and the repair splice buried with post-lay burial techniques. Some of the inter-array cables have become exposed as a consequence of scour around the base of the offshore structures [Ref 3.2].

A.13 Skegness Offshore Wind Farm

A cable from the Skegness wind turbine has snapped causing £1m per month loss of revenue from the renewable energy programme.....The repair work is expected to take a week to complete and is said to be “costing a fortune”. [Ref. 3.30].

A.14 Teeside Offshore Wind farm

Report August 2008.

“The bore holes and CPTs will sample the seabed down to 40m below the sea floor. The data obtained will help the project team evaluate potential foundation designs for the wind turbines. It’s a resumption of tests which were interrupted in February when a barge - not the one being used now - broke free in bad weather and ended up on the beach.” [Ref. 3.31].

A.15 Utgrunden

“In June and July 2006 JD-Contractor A/S exchanged and embedded the main cable from the shore and approx. 2 kilometers out to the Utgrunden Wind Turbine Farm in Sweden. Earlier in 2004 and 2005 JD-Contractor A/S had made a successful exchange of all the submarine cables between the 7 offshore wind turbines at Utgrunden Wind Turbine farm.”[Ref. 3.32].

A.16 Oil & Gas Platform “Hogan”, Offshore California – Repair/Replacement Cable.

The submarine power cable providing electrical power to Platform Hogan and Platform Houchin [Ref. 3.46] broke on November 17, 2007, thought to be caused by commercial fishing activities as trawl marks were found near the faults. All power to both platforms was lost. Although the backup systems kept the platforms going on diesel power it was important to fix the cables. A single 25KV submarine electrical cable spans between the shoreline of Carpinteria at the Casitas Pier and Platform Hogan, a distance of approximately 21,000 feet. This three-conductor, armored cable was installed in 1967. It also had sustained damaged to the nearshore segment in October of 1980 and was repaired with three splices at that time. In 2007, during preliminary testing 2 potential faults were identified.

There was apparently no spare cable for the repair, and there was a long lead time to manufacture replacement cable, coupled with limited west coast submarine cable repair resources (resources generally consist of vessels set up to repair cables, with qualified people to surface the cable and qualified jointers).

A time-domain reflectometer was used to locate the fault area half way from shore to the platform at a 2000 ft. distance from each other where an ROV survey revealed trawl marks, net debris and wire rope.



Figure A.5: D/B JC Freese 30 ton crane,



Figure A.6: j Splicing with the expert Jointers

The final result was that there were three fault locations resulting in 6 splices. Due to a shorter length of repair segments a burial sled was not used and the cable had to be re buried using hand-jetting a major time-consuming process. All repair segments were buried a minimum of 1 meter below the seafloor. The work was completed in 26 days working 7-day weeks.



Figure A.7: Splice box being filled with No-Void



Figure A.8: Splice box rigged and ready



Figure A.9: Pulling cable

Lessons Learned:

- Use a cable tracker in conjunction with the ROV to ensure that the ROV is actually tracking the cable when doing the initial cable surveys for a buried faulted cable. Power the cable tracking signal through an un-faulted leg of the cable.
- Calibrate the reflectometer using known physical lengths rather than relying on supposed cable velocities.
- Use a cable tracker during diver location of the cable to speed up location and recovery of a buried cable.
- Ensure high voltage electricians are available to work around-the-clock once splicing begins.
- Consider replacing the entire cable from the platform to a shallow water splice point. Requires only one splice, installation time may be reduced by two-thirds, thereby paying for cost of additional cable.
- Use mooring system with anchor legs suited to the water depths and capable of longest excursion distances possible [Ref. 3.45].

A.17 General Review of Historical Experience

Several other cables have been worked on but reports are limited on the reasons [Ref. 3.33] e.g.:

Burbo Bank 2006-2008 – Inter array cable replacement

Thornton Bank 2008 - Cable repair involving de-burial repair and re-burial.

Q7 project reported a need to change out the cable laying vessel due to worse than expected weather conditions: *“With safety as the main priority, a way forward was found that ultimately involved the substitution of both the cable and turbine installation vessels. The cable vessel substitution brought immediate results with the remaining cables being installed substantially faster than with the original vessel.”* [Ref. 3.10].

“Cable laying should be avoided during wintertime. At Lillgrund a propeller breakdown on the vessel resulted in the cable being placed on the seabed ± 15 meter within the trench line. After repair of the vessel and waiting for proper weather conditions the cable was picked up from the seabed and re-laid in the trench. During this delay of almost 2 months the pre-excavated trench was partly backfilled by natural causes. After re-laying the cable in the trench, water jetting had to be used to bring the cable to the bottom of the pre-excavated trench.”

“The landfall operation was a success but the cable laying operation initially failed due to propeller breakdown on NAUTILUS MAXI. The vessel hit boulders on the seabed and got stuck a number of times during the first 500m. The stern’s starboard thruster did not work properly as its output was too weak. It is believed that stones had been sucked into the tunnel, damaging the screws.

The laying had to be continued with a tugboat to control the forward movement whilst controlling the lateral movement with the vessel thrusters. After a short distance the stern’s starboard thruster broke down completely, losing the ability to maneuver the vessel in line with the trench. This resulted in the cable being placed on the seabed within 15 meters of the trench line using only the tugboat.

After repair in a dry dock at the shipyard in Landskrona (approximately 4 hours from site) NAUTILUS MAXI was ready to pick up the cable from the seabed and re-lay it in the trench.

Unfortunately bad weather forced NAUTILUS MAXI to remain in the harbour, resulting in the export cable being re-laid on February 10th, 2007, a delay of almost 2 months, which allowed the pre-excavated trench to partly backfill by natural causes.

After re-laying the cable, water jetting was used to bring the cable to the bottom of the preexcavated trench.” [Ref 3.47].

Failure Statistics are presented in a paper by Svoma et al 2007 [Ref. 3.34]: the model used is presumably based on statistics from existing failures at the time, even though those had been few, and perhaps other cable information. Nonetheless, assuming a knowledgeable researcher, the following table shows some rather serious frequencies.

Voltage (kV)	132	220	400	275	400
Cable Type	3C	3C	3C	SC	SC
Per Cable Power Transfer	120	220	400	515	1000
Failure rate (failures/year)	0.25	0.46	0.67	0.15	0.22
Projected time between failures (years)	4	2.2	1.5	6.5	4.9
Projected number of repairs in 20 years)	30	27	26	18	13
Estimated cost of repairs (M GBP)*	90.8	119	114	79.2	57.2
Ohmic Cable Loss in MW	5.8	5.7	5.8	17.6	19.3
Total Losses %	6.6	9.4	20	7	6.5

*Revenue loss not factored in

Table A.1 Failure Statistics

Svoma also notes that the HVDC Cross Channel Interconnector in 2003 was repaired from a fault in 83 days.

Typical failure rates for subsea cables are 0.1 failures per 100 km per year [2], with a mean time to repair of 2 months [3], but this could obviously vary with local conditions [Ref. 3.35].

Thomas Worsyk reports a failure rate of 0.3 failures per 100 km per year, but notes several specific instances of the Fox Island Cable, Maine, and the Long Island Cable having much higher failure rates. He also notes that the average statistics can be skewed by one or two cables where there are multiple failures which might be attributed to faulty construction, with no information available other than to guess [Ref. 3.36].

Fishing gear and anchor damages are accused for many of the submarine cable failures for both power cables and telecom cables. With the number of reports in Figure A.10 this includes telecom cables and may not be representative of the more robust electrical submarine cables.

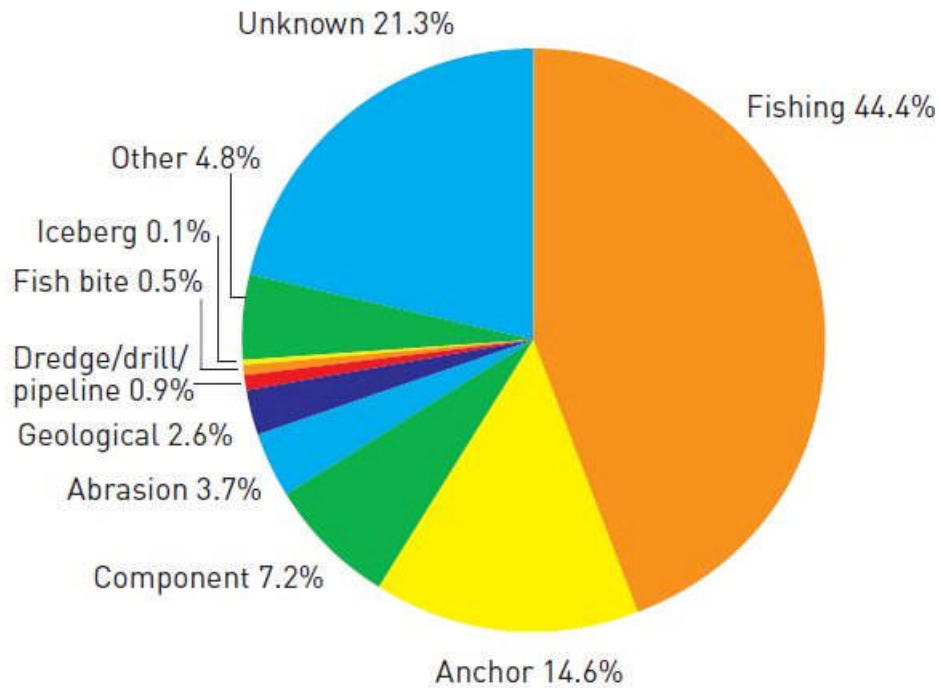

Figure A.10: Damage from 2,162 records spanning 1959–2006. Source: Tyco [Ref. 3.37]

The laying of power cables is much more onerous than telecommunications cables, with heavier cables (more copper conductor), larger cables (more insulation), stiffer cables (more armoring), and at-sea terminations.

Scour pits can form very quickly around a foundation, some cases having been reported of these occurring within a single tidal cycle. The cable emerges from the bottom of the typically approximately 5m pile diameter and become free-spanning, leading to potential damage [Ref. 3.38].

Some of the wisdom coming out of the history can be summarized in a few points:

- The laying of sea cables for the offshore wind farms has proved to be much more time-consuming than in the planning stages;
- Depending on the vessel the time for laying cables can involve long weather delays;
- Power cables that connect land-land locations also become exposed during storms. The Cross Sound Cable, buried beneath Long Island Sound became exposed after just 2 years after it was put into service [Ref. 3.39]. Electricity flow through the cable was turned off during the two months required to rebury the cable;
- Cable Tensions need to be monitored during installation e.g. when feeding the cable up a J-tube;
- Missed features or inaccurate seabed characterization may be missed due to incomplete analysis of existing data or where an existing sensor was not operating correctly: even small

areas of mischaracterized seabed can cause significant downtime to repair a damaged plow or cable;

- There are risks involved the footprints of jack-up platforms that operate in the vicinity during installation. The platform will leave a ‘footprint’ on the seabed which may restrict the positioning of the cable or serve to encourage scour of the cable assembly;
- Sand banks, rubble and other debris on the seabed need to be considered: unexploded ordnance, including mines, shells and bombs, has proved to be a hazard. – Many ocean dumpsites are indicated on nautical charts published by NOAA, but military dump sites are often unidentified. “The U.S. Army has put only 1 of its 26 known chemical weapons dumps on nautical charts” [Ref. 2.8, Pg. 111].
- Because there is often strong tidal currents in areas suitable for wind farms avoiding use of divers except where absolutely necessary is preferable;
- Areas of strong tidal current are often subject to scour issues both with the turbine foundation and the cables;
- Cable laying equipment may be designed for longer distances than often encountered with inter-array cables and careful consideration is required for selecting the right equipment for the job;
- Preparing for the event of a repair is very important and much time can be saved by having available the documentation of how to carry out the repair and the contact details, and pre-arranged contract for repair is often helpful. If weather gets bad enough during installation it may be necessary to cut the line for the vessel and crew to run to shelter;

Several helpful publications give useful tips from experience gained.

- Deciding operations in sand waves to avoid pulling cable out of the trench;
- Resolving boulder fields and high relief rock to avoid plow and cable damage;
- Avoiding plow launches in soft seabed to avoid cable damage. [Ref. 3.40]

Off the East coast of Ireland, bathymetric surveys were carried out at a 6 monthly interval following the installation of the export cable. The surveys clearly demonstrated that significant changes in seabed level had occurred in an area of sandwaves.

Migration of a sandwave over a relatively short distance can leave a previously buried cable exposed at the seabed. As the crest of the sandwave migrates over a cable buried to a nominal depth of 1 m below seabed, the cable may become exposed. Over time, the sandwaves will migrate and cover the cable again; however the cable remains exposed to threats such as fishing and anchors until this happens.” [Ref. 3.41].

Clearing debris from the seabed before laying the cable is important and ensuring that as laying proceeds the cable is positioned and tensioned in such a way as to avoid kinks.



Figure A.11: Clearing debris off the seabed



Figure A.12: Ensuring there are no kinks in the line
[Ref. 3.42]

A number of studies including those carried out by UK [Ref. 3.2] have researched cable fault rates based on the depth of burial of the installed system. Cables buried to 0.6m depth are likely to only experience one or two hits in a 10 to 15 year lifetime (probably in areas of shallow burial or where sand-waves are mobile) and cables buried to 1.0 m or more are likely to have a high probability of remaining fault free.

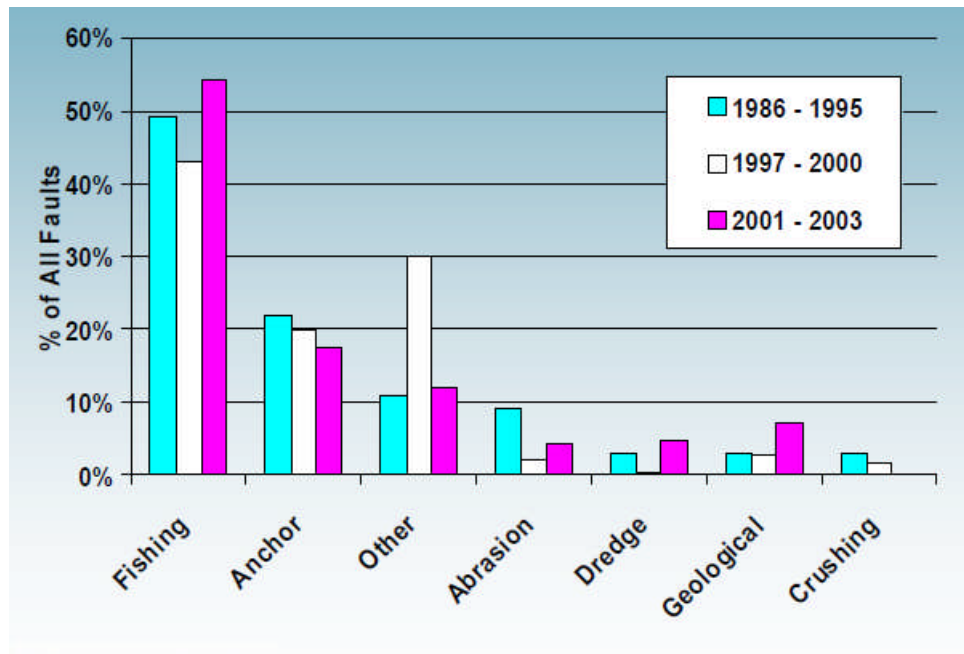

Figure A.13: Sources of External aggression from a Recent Paper on Cable Faults

These statistics [Ref. 3.43] are averages many involving telecommunications cables, and are not necessarily indicative one way or another of what might happen at a particular site. The figures quoted in the table include a 33% safety factor which recognizes that the target depth of burial is not always achieved in the field for operational reasons. The recommendations coming out of the study were as follows:

- *Continue cable burial in shallow waters, as it is still the most effective protection method in most regions of the world*
- *Communicate cable routes through Cable Awareness Programs (to harbor masters, fishermen, government agencies, etc.)*
- *Monitor fishing data in medium water depths to ascertain a possible forming trend*
- *Continue to update cable protection methods to reflect newer seabed usage*

Kordahi reports that recently, due to great efforts by numerous maintenance organizations around the world, the source of many faults has changed the statistical viewpoint which may have erroneously based on reports assigning cause to fishing vessels when they now can be assigned with some evidence to vessels unknowingly losing their anchors while under way, and dragging these anchors across undersea cable systems and damaging them. This change was brought about because of the measurements now available through investment in their own investigations and the new technology of the Automatic Identification System [AIS] that allows an accurate tracking of vessels with respect to cable locations [Ref 3.44].

The following photos illustrate some of the hazards:



Figure A.14: Dropped Object (courtesy Nexans)



Figure A.15: Anchoring (courtesy Nexans)

IMCA's position paper on Renewable Energy highlighted a few issues from their members. While the incidents that caused the cautions are not reported, the cautions are themselves worthwhile in that some if not all arose because of a problem and are worthy of consideration in avoiding incidents [Ref. 3.11].

A.18 For Further Reading

There are some interesting stories about cable failures such as the one reported Offshore Maine as noted by Marenco Engineering (http://www.marencoengineering.com/case_study.html).

One in the Pacific that is of note is the Remediation for the Pacific Crossing-1 North and East Submarine Fiber Optic Cables in the Olympic Coast National Marine Sanctuary off the coast of Washington. The cable was laid in 1999-2000 and the target burial depth required was not achieved. The permitted depth was $\geq 0.6\text{m}$ and this could have been achieved but for higher than normal residual tension, a higher plowing than conditions warranted and limited route selection data [Ref. 3.45].

A.19 Germanischer Lloyd Advice

Germanischer Lloyd is one of the authorized certifiers for German regulatory compliance. The following are from their "certification guidance" for subsea cables based on historical experiences:

- The burial depth "shall be in accordance with the local requirements concerning sea bed warming";
- The cable shall not be overstretched during installation and the reference standard is "1185-1995 IEEE Guide for Installation Methods for Generating Station Cables";
- Cautions include that the cable at the turbine shall be cared for such that no damage shall occur from:
 - Rubbing between cable and the vibrating tower or foundation;
 - Too small a bending radius;
 - Pulling forces, squeezing, salt water, animal or animal excrement above or under the water surface;
 - Heat by too small tubes or because of underwater cables going through air above sea level;

- The tubes shall be smooth on the inside and so protected at the ends that there is no damage to the cable sheathing;
- As a rule, tubes shall not be filled with cables to more than 40% of their cross-section. Deviations are permissible if the cable can be pulled through without difficulty and there is no unacceptable mutual heating of the cables. The filling factor should never exceed 60%.

APPENDIX B DESIGN OF, REPAIR OF, and LIFE OF SUBMARINE CABLES

B.1 Design Issues

The key information a designer needs to determine the cable, besides the power required to be transmitted includes the following:

- Ambient temperature (seabed & land);
- Burial depth;
- Particular burial/protection requirement at shore approach (deeper burial, directional drill pipe...);
- Axial spacing of cables;
- Thermal resistivity of seabed, approach to land to the land termination point;
- Length of submarine cable;
- Water depths & salinity of the water;
- Likely risk of a length becoming unsupported;
- Vessel to be used in installation;
- Any bottom features which would cause a higher than average number of faults;
- Life of cable required

Resonance can develop in electrical power lines, much like the phenomenon of water hammer in a plumbing system. The transmission system must be designed to avoid resonance between the cable's capacitance and the reactance of the generators, any power electronics in the wind farm or other devices connected on the on-shore grid.

The higher the temperature, the faster the rate of deterioration in the physical properties of the insulation, including the formation of voids in solid-type or paper-insulation. The temperature of the soil adjacent to a buried cable or conduit system must also be considered as affecting cable life. If cable temperatures become high enough, the moisture in the soil will migrate away from the cable causing a considerable increase in the soil thermal resistivity. This may lead to thermal instability of the soil and further increase its thermal resistivity which, in turn, may cause excessive cable temperatures and, perhaps, even cable failure.

Since power surges contribute to cable aging, a cable having a cable subjected to a higher level of lightning or switching surges or a cable subject to intermittent loads such as in an offshore wind farm will probably have a shorter life than an identical cable with a constant load and infrequent surges.

As the cables come ashore the electrical connection to grid is a point of discussion. If the power being fed in from offshore is 34.5 kV and the grid system is a different value, say 115 kV, then additional electrical equipment will be required to upgrade the voltage to match the grid. At some locations as the cable comes into shore it may be necessary to have a larger diameter cable joined at the ends: since the cable is no longer underwater at this point the cross-section may be advised to be larger so

as to decrease any concerns on temperature of the cable section to be buried on dry land. When arriving on dry land the cable may require less, or perhaps more protection and thus the cable armoring and/or size may change.

When cable losses exceed about 10% it is deemed appropriate to find an alternative method of transmission. Thus with 34.5 kV AC connection the limit is approximately 35 miles even accounting for connecting devices to be compensating reactors [Ref. 2.4]. DC transmission lines have been laid to over 200 km., Vancouver Island as one example has several both high voltage A.C. and D.C. lines from the mainland.

Considerable care must be taken when laying new cables over existing pipelines, power cables or telephone lines to avoid damaging or impairing both.

A good example of the type of subsea cable for a 34.5 KV cable would consist of an 800 mm² conductor with cable constructions as follows [Ref. 2.4] (courtesy of Nexans):

- *35.0 mm, round, stranded, compressed, copper conductor of 61 strands filled with a semi-conducting compound.*
- *Conductor screen comprised of a semi-conducting cross-linked compound.*
- *8.0 mm thick cross-linked polyethylene (XLPE) insulation.*
- *Insulation screen comprised of an extruded layer of semi-conducting cross-linked compound.*
- *Metallic screen comprised of 0.1 mm layer of copper tape.*
- *Polypropylene yarn fillers and fiber optic cable located in the interstices between the cable cores.*
- *Inner sheath of 2.2 mm extruded semi-conducting polyethylene.*
- *Armor comprised of 51 to 54 7.5 x 2.5 mm, galvanized steel, flat, armor wires layered in 2 layers applied in opposite directions, (appropriate for a rocky bottom).*
- *Outer serving comprised of two layers of polypropylene yarn and bitumen.*
- *Cable diameter – 149 mm.*
- *Cable weight (in air) – 48 kg/m.*
- *Minimum bending radius – 2.7 meter (8.86 ft).*
- *Maximum pulling tension 290 kN.*

A HVAC cable is shown in Figure B.1.



Figure B.1: Typical HVAC Submarine Power Cable: 3 Phase Bundled with Fiber-Optic Elements (Courtesy NSW)

Solid conductors, instead of multiple wire strands, can be used if the cross section is less than about 400 mm² in cables <150kV. Solid conductors offer the advantage of a minimum outside circumference for a given cross-sectional area. When bent, solid wire retains its shape, which makes it desirable for coiling. Larger sizes are too rigid and therefore stranded wire is appropriate and some

can achieve up to 92% of the solid. Conductors with differing degrees of flexibility are obtained by varying the size, number and twist (lay) of the strands.

Most conductors in submarine cables are made from smaller round wires which are wound together. These can achieve a high fill factor (e.g. 90%+), but the conductivity is reduced by cold working as the wires are forced into the correct pattern the following data was also reported from cable characteristic data provided by Nexan Energy. These figures identify the respective per unit voltage drop and the kW loss over the 34.5 kV 800 mm² cable at different operating conditions (0%, 50%, 80% and 100%) and cable lengths (35 km, 45 km and 60 km).

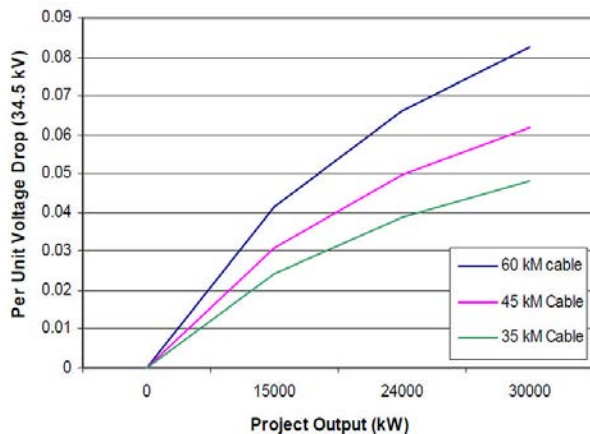

Figure B.2: Voltage drop characteristics

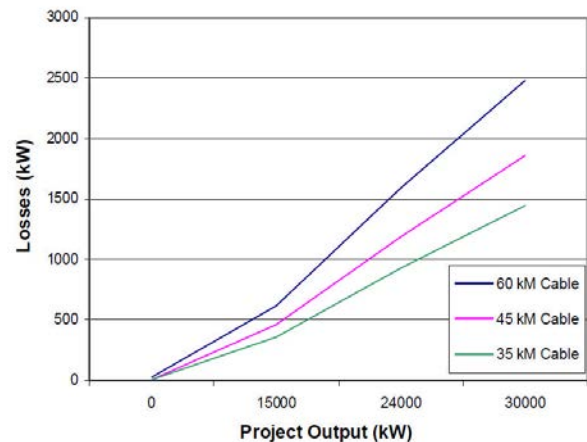

Figure B.3: Kilowatt (kW) loss characteristics

More guidance can be found in the references [Ref. B.1], [Ref. B.2].

Insulation was discussed in 4.1.3. The XLPE 3-core cables that are produced have 3 layers. The first around the conductor transform the cable into a smooth surface using a semi-conductive layer and thus produce a stress reducing layer in case of bending of the cable. A second layer provides an insulation layer and then a third layer provides an insulation screen. High quality requires that these are formed around the conductor as part of a simultaneous extrusion process. Submarine cables are usually tailor made and thus it is important to assure that the formulation of base resin and additives is well composed in order to have excellent dielectric values, good process-ability, anti-aging properties and not allow “water-treeing” by either water or humidity either of which erodes the longevity of the cable. Careful attention should be paid to the connectors for this type of cable to ensure that they are also appropriate and that the repair procedure can be reliably carried out. For these tailor-made cables there should be early factory acceptance tests.

XLPE has been recently improved and can now be made resistant to breakdown in DC currents thus XLPE insulation can also be extruded for HVDC lines such as that used for the Troll A offshore oil and gas platform offshore Norway noted in Appendix B.

Other extracted insulation materials can also be satisfactory and is quite popular including Ethylene Propylene Rubber (EPR).

Since the cable must remain in place for the field life, often 20-40 years, it is most important to get the insulation properties correct and assure that the cable is both watertight, and that the ends are protected by swelling agents to self-seal the cable if water should come in from a break in the line.

Duplicating the export cable is usually not an alternative, but if it is done due account should be taken of the separation distance to account for repair, and to account for possible ship anchor damage. Both of these subjects are discussed in Section 7.

For counteracting the effect of a fault due to abrasion and from vessel damage, the more armor there is in the line the more difficult it is to disrupt it. This is always a balance since the more armor the heavier the line, and more difficult it is to place it and the more restricted the number of vessels available, and the more difficult the repair job [Ref. B.3].

An interesting project using a submarine power cable laid in Norway to an offshore oil platform may cause significant cables to be available offshore for offshore wind farms to tie in to. Norway which has mainly hydro-power sources has an aggressive desire to reduce carbon emissions and powering from shore for their offshore platforms made sense. A high percentage 20%+ of the CO₂ emissions come from the offshore industry in Norway. Supplying the cable from shore resulted in a smaller platform size (no need for anything but a small amount electrical generation on board to run essential survival services during a power outage). This results in smaller sized platforms, reduced manpower and lower CO₂ emission. The first offshore field utilizing this concept was the Troll field in the North Sea in 1995. The required 18 MW platform power supply is provided through a 67 km long, 52 kV XLPE insulated composite power and fiber optic cable.

B.2 Repairing Cables

There are likely to be challenges in early wind farms expected off the U.S. Coast. There are few repair vessels for submarine electrical cables in the world, and those may already be on-contract with utilities to standby in specified locations. The ability to attract an individual wind farm to call upon an electrical cable repair vessel may involve delays perhaps as much as 6 months. Once there is some 5 GW of offshore wind farm in a specific area, then it may be possible to negotiate a contract for a quicker response time. The figure below is illustrative of the problem [Ref. B.18]:

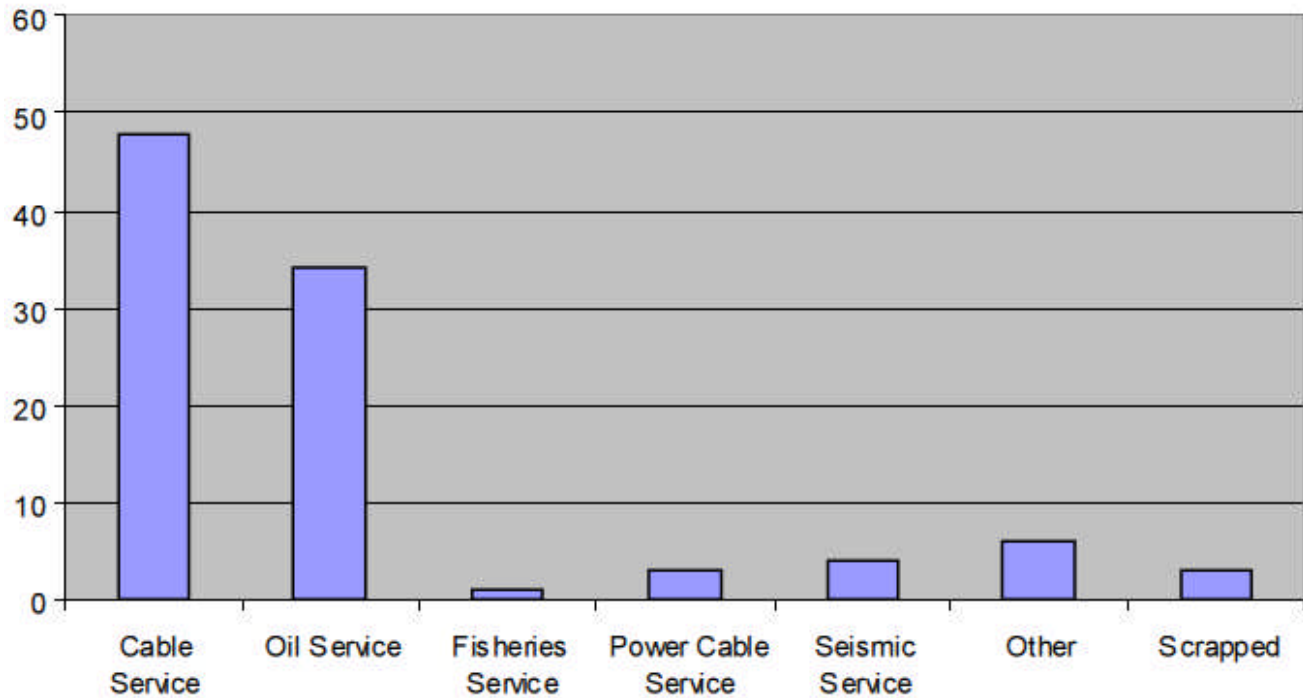

Figure B.4: 2007 Cable Ships by Market

Another challenge in repair of wind farms, is obtaining the services of an expert Jointer. Jointers are in short supply. A recommendation made by installers is for a developer to negotiate the provision of a Jointer in the agreement to purchase the cable, and the spare cable.

During the haul up process, sometimes from 1-5 m below the seabed – the strain on the cable is substantial. Thus the recovery is a complex process that takes into account a wide range of variables

- The speed and angle of recovery;
- The ship's track along the cable route;
- The drag of the cable which may have increased due to biological growth on the exterior;
- Waterdepth, current velocity, wave effects on vessel motion and any natural or man-made objects;
- Amount of consolidation in the soil;
- The allowable cable tension by design.

To aid the recognized issue with tension the manufacturers provide recovery tension tables that describe the maximum recommended recovery speed in given water depth and at a given angle for each soil type.

Another of the challenges for a submarine cable break/fault is locating it. An illustration is given in Section A.16 of this report where some time was taken to determine the location of the faults, depth

of the cable etc. which with proper mapping and periodic inspection should save time in case a repair is indicated. The importance of an accurate map of the burial route is a given, which will locate the original coordinates. A time-domain reflectometer can then be used to identify the distance to the fault from shore or the turbine. Time-domain reflectometry involves sending a signal down the cable line and then viewing the reflected signal. Other similar techniques can be used. With this information it is possible to find the exact location on the cable.

After retrieval, a practical method of determining how far the cable has been penetrated by water is to cut the cable 25 -50 feet on either side of the fault. Testing the insulation at that point for moisture can determine if the cycle needs to be repeated. The operation should continue until it is confirmed that no moisture is in the cable. All cable with moisture should be replaced with new cable.

B.2.1 Contingency Cable Lengths

It is appropriate to have spare cable available for repair issues. Burial on the seabed has been suggested, however, predicting the location of the break is not possible, and the issue of aging of the cable in place, and the issue that the cable has “memory” and may not uncoil so easily if in place for a length of time, negates any possible advantages over making up two joints at each fault location while storing the spare cable in a climate controlled warehouse so it is as-new when it needs to be deployed. Appendix A.3 describes the issue with the Blyth cable. The amount of contingency cable should reflect the likely number of times you may have to repair the cable and the waterdepth that both ends have to be pulled up from, keeping in mind that it is quite tricky as well as expensive to retrieve the cable for surface repair.

B.2.2 Issues for Repair

Repair may take a long time. Whatever effort is made to install the cable correctly is probably well spent as once the repair becomes necessary the procedure is hugely expensive.

Various products on the market can detect a submarine cable and the burial depth. One example is given below. With a low frequency electroding tone applied to the cable, the system can be used to locate cables buried beneath the seabed and to establish their burial depth.

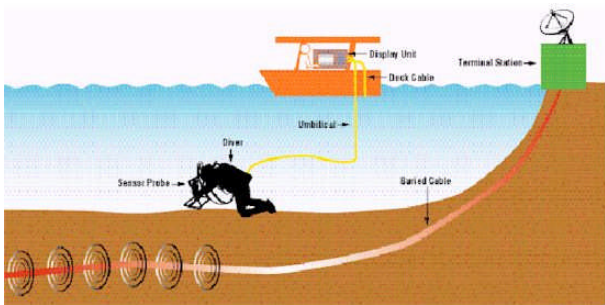

Figure B.5: Tinsley Survey System
www.tinsley.co.uk

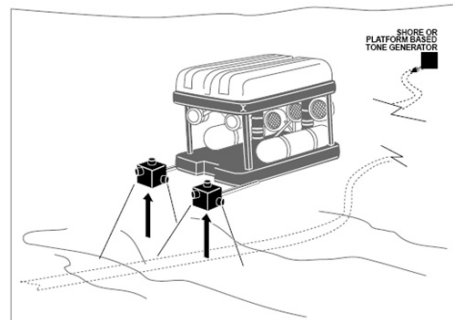

Figure B.6: Ocean scan – survey system
www.oceanscan.net

The vessel selected for the repair job must be foreseen to be able to work in the reasonably frequent conditions at any point in the year that the cable repair must take place. The jointing of cables is not easy at the best of times, let alone in above average wave heights, and generally most owners don't wish to wait on seasonally better weather.

There are only a few ships in the business of repairing power cables. It is a good strategy to have an agreement for repair so that a vessel is available. It is generally easier to find a vessel that can un-bury the cable, and to re-bury it after repair, but the repairing itself may take a special arrangement that should be worked out ahead of time, since the configuration is quite different than any other wind farm operation, and must be ready to deploy at short notice. The jointing takes being able to haul up and hold the cable ends (crane or winch), a sheltered location to make the joint (clean jointing room), and a meticulous jointing crew. If the joint is going to involve a spare insert then the sheltered jointing location must be large enough to handle both ends of cable handling gear to move the joint in and out of the room. The jointing house has to be of an appropriate size typically about 4 m x 20 m. The equipment needed includes direct radio communication to the vessel bridge, an alarm mechanism, electric power supply, air conditioning, and a dryer to ensure the cable remains without moisture as it is spliced. An emergency cutter is needed just in case it becomes necessary to cut the cable to maintain safety of the vessel. A hydraulic cutter is often the best choice though its use should be avoided if at all possible.

Since time is generally of the essence and the weather may not hold for an extended time (wind farms are often in places with a lot of wind, and thus wave), it is best to work round the clock for a repair which then requires sufficient experienced cable jointers to be used.

It is unlikely to be cost-effective to repair one inter-array cable with a cable vessel which has to be brought specially to the location from overseas and so it may be desirable to work out a contingency plan for the initial offshore wind farm developments. Since all the submarine cables used for wind farms are non-standard products, it is important to have on hand cable of the same type manufactured with the original cable and stored for potential repairs. Since time is of the essence in cable repair that cable should be stored in such a way as a prescribed length can be on hand to transit to the site with the repair vessel so that it is not necessary to return to shore to retrieve a spare length of cable to be added, if the original repair cable length is not sufficient.

Based on the offshore wind farm cables that have been repaired historically (See Appendix A) the downtime can be from a few days to several months.

B.2.3 Repair Costs

It is interesting to note the cost of repair from a 2002 study on a fictional windfarm [Ref. B.4].

In the study the estimate was for a yearly failure rate of the cable under study failing once every 21 months. The repair costs for one cable were estimated assuming that the repair vessel and diving crew could operate below a significant wave height of 1.5 m, which may be optimistic for some of the US locations where a Hagerman study [Ref. B.6] showed the average wave height at some east coast locations to be 2m. For the purposes of approximation the Euro was trading at above \$1 to the €1, and it can be assumed for approximate comparison that the value would be a suitable comparison for this chart - so for the € read \$.

Equipment	Mobilization/ Demobilization	Repair
Cable lay vessel	40,000 € per day for 8 days each mob/ and demob	60,000 € per day for 5 days
Burial Tool	40,000 € per day for 2 days each mob/ and demob	60,000 € per day for 5 days
Vessel Assisting	12,000 € per day for 2 days mob /and 1 day demob	60,000 € per day for 5 days

Table B.1 Estimated Cost of Repair

Based on the premise of the time at location waiting on the appropriate weather of $H_s = 1.5$ m and $V_w = 12$ m/s a wait time of approximately 7 days was calculated for waiting on weather.

Equipment	Mob/Demob €/event	Repair €/event	Waiting €/event	Total €/event	Total €/year
Cable lay vessel	640,000	300,000	420,000	1,360,000	771,120
Burial Tool	60,000	100,000	140,000	300,000	170,100
Vessel Assist	36,000	100,000	140,000	276,000	156,492
Total	736,000	500,000	700,000	1,936,000	1,097,712

Table B.2 Estimated Total Cost of Repair

It is clear from the Table that the economics dictate avoiding faults and repairs whenever possible.

B.3 Life of Cable & Maintenance

The life of the cable is determined by temperature it is running at, possible fatigue, chemical aggression, stress from overloads (e.g. lightning or fluctuations in power being transmitted), insulation deterioration (chemical reaction) etc. and thus the life of the cable can be designed into the system. Over time the strength of the dielectric decreases and the useful life becomes limited. Since the cable may be subjected to different conditions along the length one portion may deteriorate more quickly than another. Sufficient safety factors are usually included, such that by monitoring the cable over the original design life, it can be determined if the cable can be re-qualified for additional years when the historical record is known.

An increase in operating temperature of 8-10⁰C can cut the life-time of the cable in half, so it is important to be sure of the operating temperature during cable design, which in-turn depends on soils, temperature, burial depth etc. An increase in operating voltage can cut the life-time of the cable in half.

Cables for wind farms should be inspected periodically and when doing so with magnetometers and other devices, it is possible to determine the depth of the cable thus preserving the burial depth and

possibly the design life. Reburial is performed generally using an ROV and a waterjet sled or by divers re-burying with water-jet.

As the cable comes ashore it is important to keep it protected from sunlight in order to ensure that UV radiation does not add to the mechanisms deteriorating the cable.

B.4 References

- B.1 US Army Corps of Engineers. Facilities Engineering Electrical Exterior Facilities, Chapter 5 Underground and Submarine Cables, Technical Manual 5-684/NAVFAC MO-200/AFJMAN 32-1082.
- B.2 Wright S.D., Rogers A.L., Manwell J., Ellis A., Transmission Options for Offshore Wind Farms in the United States, Proc. AWEA Annual Conference, Portland OR, June 2002.
- B.3 Wald D., Orton H., Svoma R., Requirements for Different Components in Cables for Offshore Application, CIRED 20th International Conference on Electricity Distribution Prague, 8-11 June 2009, Paper 0064.
- B.4 Rademakers L., Braam H, O & M Aspects of the 500 MW offshore Wind Farm at NL7 DOWEC 10080 Rev 2, 2002.
- B.5 Collins C.L, Hughes E.W., Seltzer G H, and Welch D., “A New Paradigm for Responsive Submarine Cable Repair”, 3 U Technologies LLC, Suboptic 2007.
- B.6 Hagerman George, Southern New England Wave Energy Resource Potential, Building Energy 2001 Conference, Medford Massachusetts.

APPENDIX C: TOOLS TO DETERMINE SUITABILITY OF ROUTE

Several devices (tools) are described that are used for understanding the route:

- Multi-beam sonar: horizontal positioning better than 5 m +5% of water depth and accuracy for reduced depths;
- Side scan sonar: Frequency 100 kHz or higher (preferred digital dual frequencies of 445 and 900 kHz); capable of achieving a vertical bed separation resolution of at least 0.3 m in the uppermost 15 meters below the seafloor; recognition of cubic features >1 meter and preferably <0.5m; digital recording; cruise speed max. 4 knots; sonar positioning to better than 5 meter;
- Sub-bottom profiler, chirp sonar or alternative systems of comparable or better performance;
- Magnetometer or active metal detection system;
- Vibrocorer or Cone Penetration Test device (CPT) down to the planned cable burial depth, spacing to be determined on the basis of seismic data.

In shallow water the bottom surveys often carried out by an Autonomous Underwater Vehicle (AUV), which will be subject to difficulties in deployment if there are constant waves which may also result in inaccuracies in understanding the bottom conditions. AUVs operate autonomously without on-line command and control intervention by following a pre-programmed work scope and failsafe procedure uploaded to their on-board computers. The larger of these vehicles can be equipped with swath echo sounders, side scan sonars and high-frequency sub-bottom profilers. Some AUVs can also carry, or tow, a magnetometer and many other sensors, making them extremely flexible and powerful tools.

The alternative of shallow water diver surveys are quite difficult as the divers can be tossed around in waves and swept from the path in current: their work in surveys and then in placing the cable and ensuring that it is suitably protected along its route can be quite difficult and is contributed to by waterdepth in conjunction with the wave and current fields. The precision with which the waterdepth along a route can be determined should account not only for what is on the bathymetry chart, and the tools used to measure the waterdepth, but also mention time, tide, chart type, what contour interval and what elevation datum. The interpretation of the results of any of these techniques requires that the operator have a base knowledge of the soil profile fairly accurately at any particular location. For this, boreholes, or some other sampling method e.g. cone penetrometer are needed.

C.1 Bottom Profile

Echo sounders are used to verify the nautical charts that may be available or to plot new contours of the region. The charts are usually made with significant distances between soundings, and the charts drawn from those points are not accurate enough for a route survey for a submarine cable. While it may be possible to research the original survey measurements from the charts and the drop point locations, it is always best to verify the information with new measurements. Historical information can only tell you the depth as measured and not the measuring tool limitations. Early checking of a route out of a Norwegian fjord discovered a mountainous area which was important to a deep draft concrete oil platform exiting the fjord but was not relevant for the ships that had transited the area for

several hundred years and thus was not noted on charts. Distance between points of measurement on the original charts was in kilometers, not in meters.

There are several useful configurations for echo sounding. Figure C.1 and Figure C.2 illustrate the single beam, multiple-single beam and multi-beam echo sounders. The accuracy of multi-beam (also known as swath) systems is critically dependent on the corrections applied to remove vessel motion (heave, pitch, roll, yaw etc.); consequently, a swath system is integrated with many other specialist sensors within the ship or sub-sea vehicle. Thus there may be merit in using single beam echo sounders depending on the application.

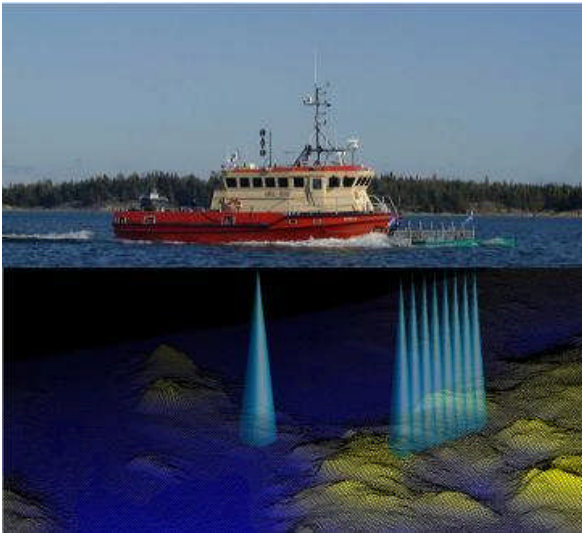
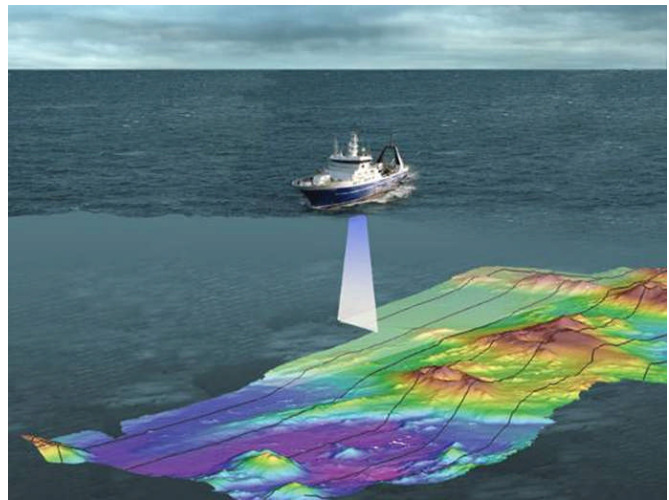
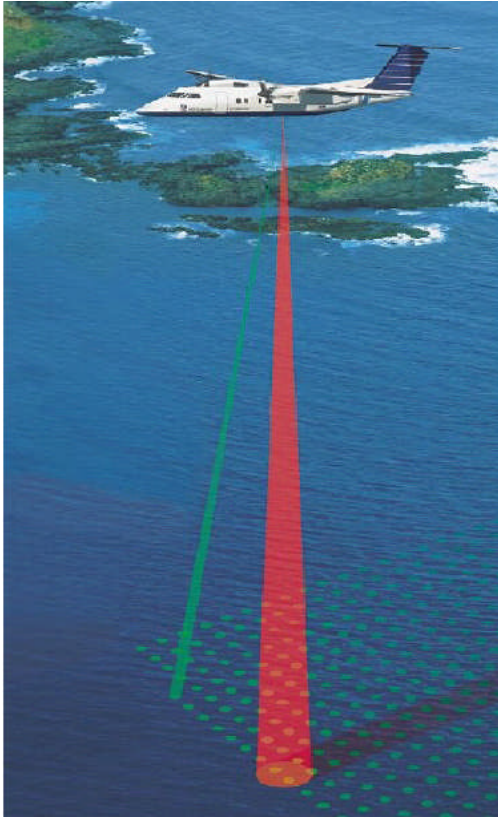

Figure C.1: Single Beam and multiple single beam echo sounder. [Ref. C.2]

Figure C.2: Multi-beam Echo sounder [Ref. C.3]



The multi-beam echo sounder is an ideal way to develop a topographic map as shown in Figure C.2. The flattest path for a cable is preferred as it is the least difficult to lay, with no unsupported lengths. It is important to use this surveying technology so that the safest cable route can be planned in order to eliminate potential damage from the cable as well as extend the cable’s life span.



In shallow, clear waters (typically less than 30 m to 50 m deep and with relatively low concentrations of suspended solids), air-borne, laser scanning systems known as Lidar are becoming increasingly common. Two laser frequencies are used: red light for reflecting from the sea surface; and green light to penetrate to the seabed. This is used for early mapping of the seabed.

Figure C.3: Artist's Rendition of Lidar Survey
[Ref. C.1]

C.2 Side Scan Sonar

The results of side scan sonar provide images and shadows of items on the surface of the sea bottom only.

The side scan sonar system's transducer is housed in a towfish, which is towed through the water a few feet above the bottom or contained in an AUV. The reflected acoustic returns are processed into an image similar to an aerial photograph, which is viewed real-time on a computer monitor in the "mother" vessel. Typically, the side scan sonar searches a swath 60 to 160 feet wide at about 2 knots, although other ranges can be used depending upon the size of the object being sought.

Location information from a differentially corrected global positioning system (DGPS) is used to guide the towing/mother vessel along predetermined search lines as well as to identify the location of any point on the side scan image. The stored GPS location information allows the searchers to return to any point in the image for further investigation.

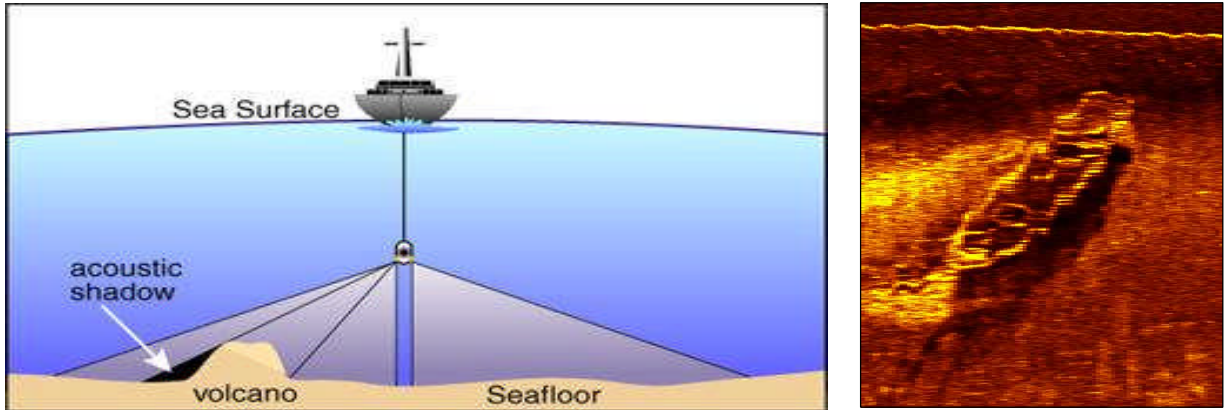

Figure C.4: Side Scan Sonar – how it works, and view of the resulting image viewed with side scan sonar [Ref: C.5], [Ref. C.6].

Unlike a bathymetric survey which can determine depth alone, side scan presents images which allow views of wreckage and undulations on the seabed in order that the investigator can get a better perception of the seabottom. Figures C.4 show the results of using a side scan sonar tool.

Figure C.5 gives the image of the seabottom which has been combined with software from which a route can be graphically depicted and data on depths etc. derived. This tool, however, only provides information about the surface. Sub-surface phenomena may provide reasons to select a different routing.

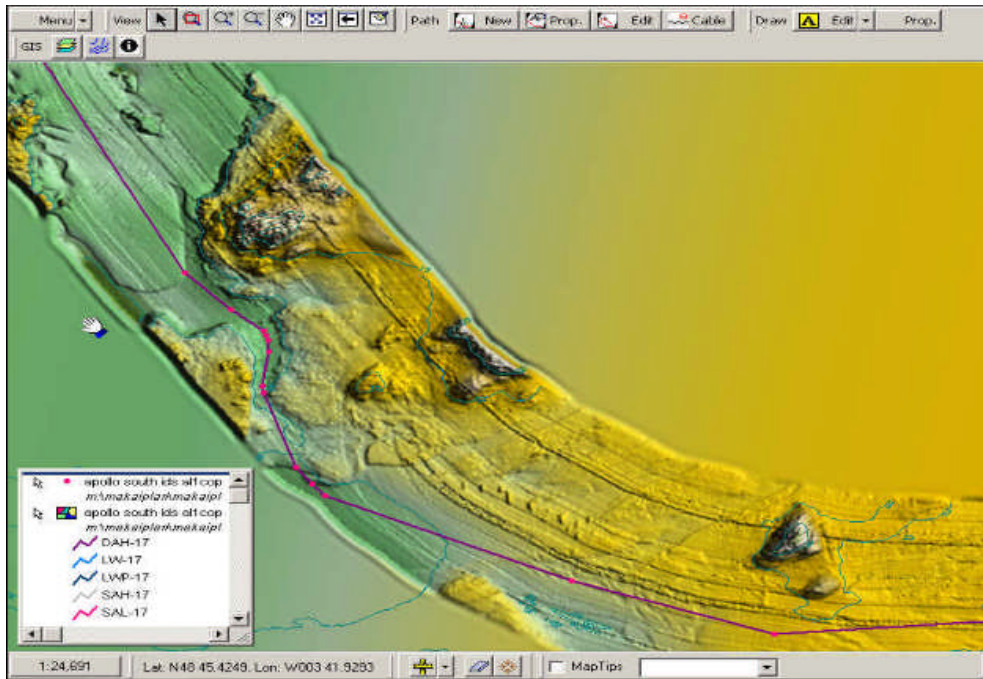

Figure C.5: View of a survey processed with advance route planning techniques [Ref. C.1]

C.3 Remote Operated Vehicle – Camera

Another very useful tool to use to determine the characteristics along the anticipated route is a camera on board an ROV. If visibility is good the camera allows views of debris on the seabed which may not get picked up by other instruments described. Further information on the nature of cans on the seabed, for example, may lead to finding military debris, or chemical containers that were disposed of either illegally or prior to requirements being in place, and which could result in a hazard for the cable route.

C.4 Geophysical Survey on Site

Guidance is offered by the BOEMRE on Geological and Geophysical Hazards and Archeological Information [Ref. 2.13] and is directly applicable to the submarine electrical transmission cables.

Information on the specific requirements of the Construction and Operations Plan is also available [Ref. 2.14]. Both documents are available at

<http://www.boemre.gov/offshore/renewableenergy/RegulatoryInformation.htm>

C.4.1 Sub Bottom Profiler

Whereas both the echo sounder and sidescan sonar are used to detect surface issues, the sub-bottom profiler looks below the surface to determine characteristics and anomalies of the soil. It is necessary to have extensive experience to interpret the images and issues. Whether a layer is sandy or rocky may require a soil boring or soil sampling to determine the characteristics of what appear as different colors on the diagrams below.

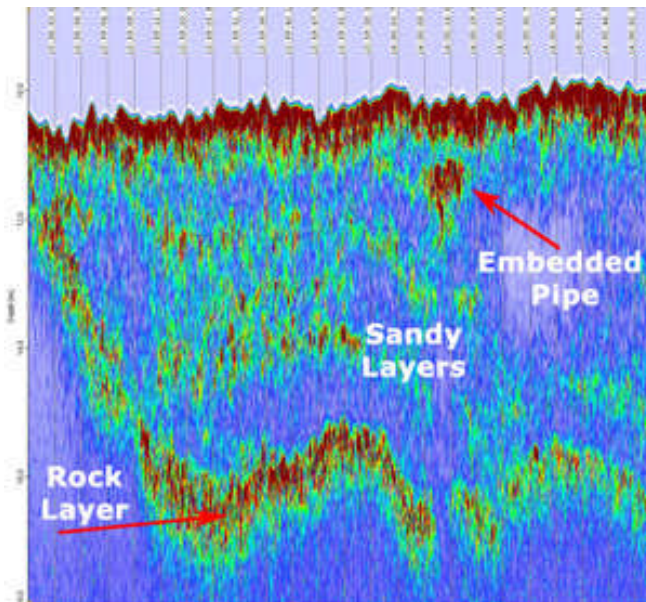

Figure C.6: Sub Bottom Profiler showing survey Interpretations [Ref. C.7]

Different sources of signal (noise) determine the depth into the soil that features can be detected. The Chirper or Pinger work on a frequency of 2.5 – 9 kHz which means it can penetrate the soil to a depth of 20-40 meters, i.e. sufficient for a submarine power cable. Should a deeper penetration with

high resolution other methods are available using lower transmission frequencies and resulting in higher penetration i.e. a Sparker approx. 30-100 m penetration or a Boomer 50-1000 m penetration.

A chirper is suitable for submarine cables in shallow water and often used since it has very good resolution for determination of the soil in shallow formations.

A minimum performance requirement should be made when specifying the survey equipment: refer also to BOEMRE requirements [Ref 2.13]. A typical resolution should be less than 0.5 meters at a speed of 2-4 knots, with a deployment in average weather for the area and season.

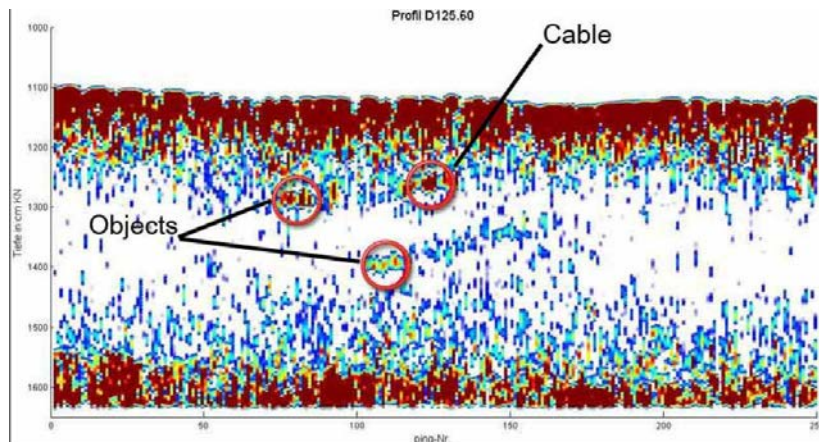

Figure C.7: Sub Bottom Profile Results after identification [Ref. C.7]

The principal aim of the geophysical (sometimes referred to as seismic) survey is to reveal the general near-surface geological structure and indicate reflectors which may represent a change in soil characteristics and/or stratigraphy. This requires the correlation of the shallow seismic data (sub-bottom profiler) with soil borings in the vicinity. The seismic data can tell you that the soil is layered but can only give you limited information on what characteristics it might have. The seismic acquisition equipment should be capable of providing detailed information to a depth of up to about 5 times the cable depth. Drop cores and grab samples are also required to assist the geophysical interpretation at frequent locations along the route, with periodic borings at a rate of approximately 1 per kilometer for areas that show little change to 2 per kilometer for more average locations and more than that where there are more frequent changes in soil profile, type, or other anomalies are present.

The shallow seismic needs to be interpreted by a competent person, ideally one who was responsible for performing the work on location. Every effort should be made in the interpretation to comment on the soil type and strength: this will require correlation with a borehole/CPT in the vicinity of the survey and some degree of local experience.

C.4.2 Magnetometer

For metallic objects it is possible to use a magnetometer to detect ferrous items on the seabed e.g. anchors, pipelines, cables, or other obstacles which cannot be identified only by their density. Magnetometers are also used to detect archaeological sites, shipwrecks and other buried or submerged objects.

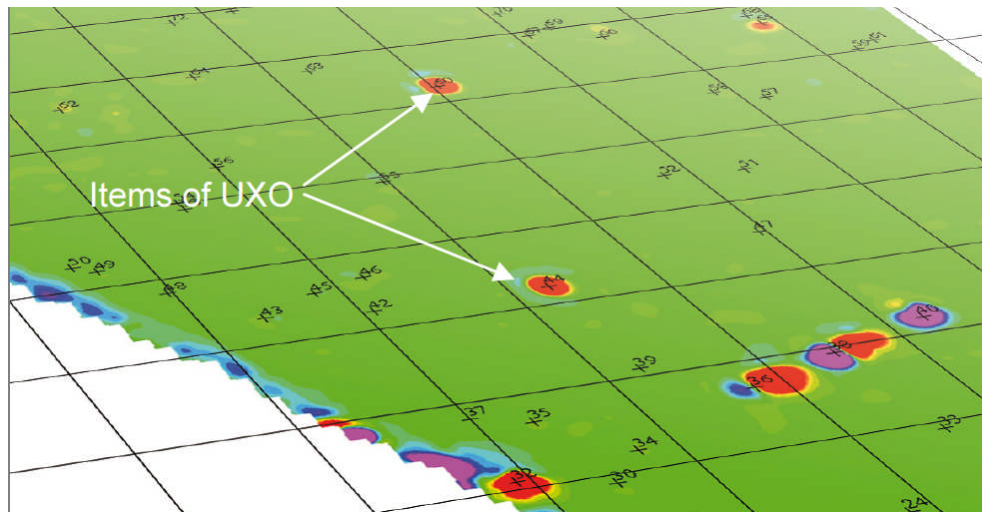

Figure C.8: Unexploded Ordnance from Magnetometer survey
[Ref. C.8]

C.5 Soil Surveys in the Field

For the design of the cable trench, information about soil properties is important such as soil density, and grain size distribution that can be obtained from CPTs or vibrocore borings along the cable route.

Various instruments exist for taking soils information from the field. A key item is deciding how far between data points, and this depends on the expectation of change throughout the route.

The instruments used for sampling the soil at the location along the route are primarily

- Cone Penetrometer
- Piezo Cone Penetrometer
- Temperature Probe
- Vibrocore Borings
- Vane Shear Tester

If the soil conditions and water depths are very homogeneous, being interpreted from seismic investigations, boreholes and CPT tests, it may be sufficient to perform boreholes or CPT tests at few locations along the length as discussed above (every 500 meters or so) but if the area is subject to a changing bottom landscape every 100 meters may be a better target. This depends on the special variability of the soil parameters and robustness of the cable design. For calibration of the CPTs, a minimum of one CPT should be performed in close vicinity to one of the soil borings.

Although the spacing of the CPT readings may be specified as a function of soil type, logistics often dictates the time period a vessel is available for such activity, perhaps as part of a larger program of determining bathymetry and sub-bottom profiling and thus if the vessel is on hire 2 days and CPT readings can be taken each hour or less, the time period available may influence the number and spacing of the readings.

C.5.1 Cone Penetrometer Test (CPT)

The cone penetration test provides an empirical assessment of the soils based on pushing a cone-tipped probe into the soil at a constant rate. The constant rate ensures differences in bearing pressure are logged. Strain gauges within the cone measure the resistance on the cone tip and they also measure the resistance of the larger diameter sleeve behind the tip. Data are transmitted to the support vessel for recording and analysis. Soil types are determined by reference to a graph of cone resistance against the friction ratio which was derived using the same speed of pushing (penetration). Other empirical relationships are used to estimate shear strength in clays and the relative density and internal angle of friction in sands.

Taking an additional measurement of the pore pressure provides information on a soil's stratification, permeability and whether it is "under"-, "normally" or "over"-consolidated which in turn gives an indication of the difficulty of providing a trench for the submarine cable.



Figure C.9: CPT Skid



Figure C.10: The SEAROBIN is one of the widely used CPT units for determining the soil for the route assessment.

The CPT unit is the most popular tool for submarine cable and pipeline route investigations, plowing assessment and for trenching studies. The unit typically comprises a frame mounted on a seabed base some with skirts and weighing 1-2 tons. A drive motor pushes the cone into the surface up to about 2 meters or so. CPT has now been developed to penetrate in excess of 20 m (more than enough for a submarine cable). The more traditional boreholes are needed to correlate the information to physical samples.

The standard CPT test has a 10 cm² cone and a 150 cm² sleeve mounted behind the cone tip. Measurements are carried out continuously as the penetrometer is pushed at a standard rate of 2 cm/s.

Besides the cone a number and other varieties of probe are used including ball probes, T-bar probes etc. Some are better at one type of soil than another so selection of the type depends on the site-specific soil parameters.

By adding a cone containing the ability to measure pore pressure (Piezocone) the test becomes a piezocone penetrometer test (PCPT) additionally measuring pore water pressure via a porous element in the cone face or at the shoulder between cone tip and friction sleeve.



Figure C.11: PCPT Instrument



Figure C.12: Pore Pressure Probe

Other cone penetration tests are available including a temperature probe.



Figure C.13: Temperature Probe
[Ref. C.9]

An electrical conductivity cone is sometimes used. In situations where one is crossing a cable in close proximity the electrical conductivity of the soil may be important. The electrical conductivity depends on the soil type, porosity, water content and pore water composition. This feature becomes important if the cable crosses or is in close proximity to a pipeline with cathodic protection or another cable line [Ref. C.10].

C.5.2 Thermal Conductivity Probe

A Thermal Conductivity Probe is used for measuring a soil's heat dissipation characteristics. This is especially important in submarine cable site investigations where the insulating characteristics of soils are important considerations for ensuring the ampacity of the cable is not compromised by the soil insulating the cable and allowing the heat to build up in the cable, thereby causing the ampacity of the cable to decrease and eventually causing damage to the cable.

Ampacity is defined as the maximum amount of electrical current which a cable can carry before sustaining immediate or progressive deterioration. It is also described as current rating is the electric current which a device can continuously carry while remaining within its temperature rating. The ampacity depends on:

- the insulation temperature rating;
- the electrical resistance of the cable current carrying wires;
- the frequency of the current, in the case of alternating current;
- the ability to dissipate heat, which depends on cable geometry and the soil thermal conductivity (the ability of the soil to distribute the heat away from the cable); and
- the ambient temperature.

All electrical cables have some resistance to the flow of electricity, and electric current flowing through them causes a voltage drop and power dissipation, which heats the cable. Having a large overall surface area may dissipate heat well if the environment (soil) can absorb the heat.

The overall ampacity of the insulated conductors in a bundle are de-rated from what they would be alone. The de-rating factor is often tabulated in wiring regulations/standards. The bonding of the metallic components (e.g. armoring) that are outside of the cable core will also influence the ampacity of the cable system.

The single probe method employs a heat source inserted into the soil whereby heat energy is applied continuously at a given rate. The thermal properties of the soil can be determined by analyzing the temperature response adjacent to the heat source via a thermal sensor. This method reflects the rate at which heat is conducted away from the probe. The limitation of this device is that it measures thermal conductivity only. Applicable standards are:

- IEEE Guide for Soil Thermal Resistivity Measurements (IEEE Standard 442-1981)
- ASTM D 5334-08 Standard Test Method for Determination of Thermal Conductivity of Soil and Soft Rock by Thermal Needle Probe Procedure

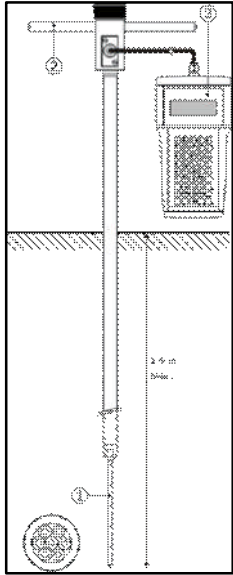

The instrument shown in Figure C.14 is specially designed for measurements at around 1.5 meters below the soil surface, which is the typical depth of burial for high voltage cables.

The probing of the soil can be done by a single probe or by a more accurate dual-probe heat-pulse technique. The dual-probe technique consists of two parallel needle probes separated by a distance. One probe contains a heater and the other a temperature sensor. The dual probe device is inserted into the soil and a heat pulse is applied and the temperature sensor records the response as a function of time. A heat pulse is sent from the probe across the soil to the sensor. The great benefit of this device is that it measures both volumetric heat capacity and the speed at which the heat can diffuse. From this, all the main soil thermal properties (known as thermal conductivity) can be calculated. As with all samples they are small and don't cover all the variations that one may have in between sample points.

Figure C.14: Example of a complete system for measurement of soil thermal conductivity

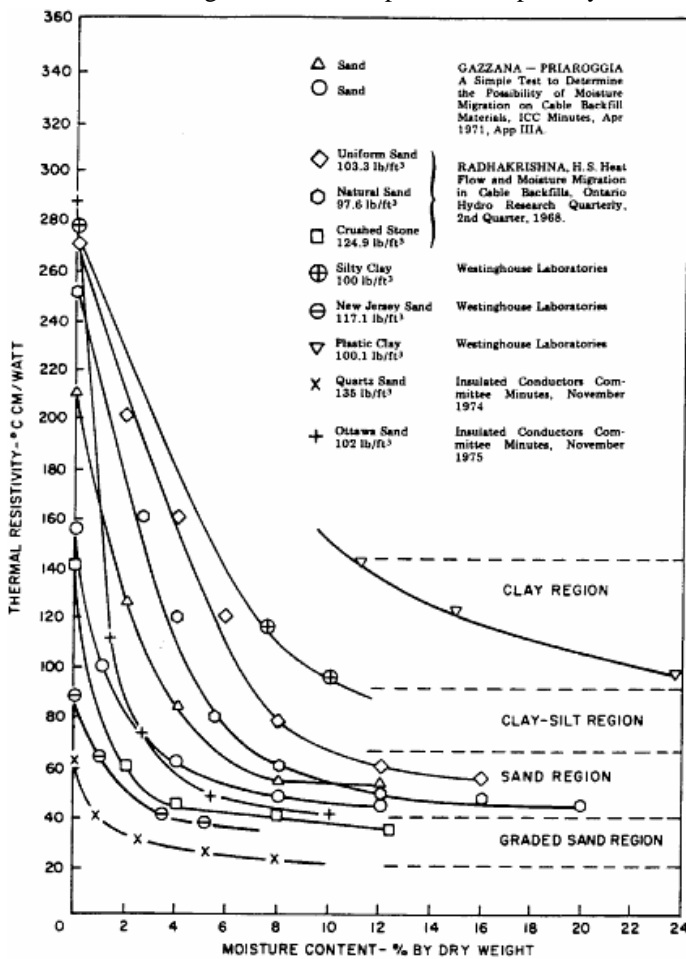

A textbook illustration of the information from the temperature probe can be seen in Figure C.15 [Ref C.11].

Figure C.15: Thermal property characteristics of Various soils

A good source is the IEEE 442 Guide for Soil Thermal Resistivity Measurement [Ref. C.11]. This guide covers the measurement of soil thermal resistivity to properly install and load underground cables. The designs for both laboratory and field thermal needles are also described in this guide.

A further reference can be found in the US Army Corps of Engineers Manual [Ref. C.12].

C.5.3 Soil Samples

A boring or coring is a sample, generally taken with a circular tube which is dropped, pushed, vibrated or drilled into the ground, depending on the soil or rock at the location. The type of boring is generally reflective of the name:

- Gravity coring is performed when the core sampler is dropped into the sample;
- Vibracoring, is performed when the sampler is vibrated to allow penetration often into sand;
- Drilling is performed by a rotating annular tool backed up with a core sample storage device. A mechanism is normally needed to retain the cylindrical sample in the coring tool.

C.5.4 Vane Shear Test

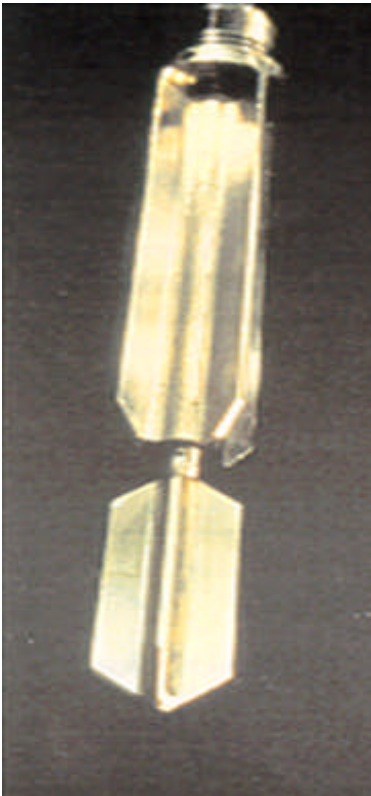

The vane shear test measures undrained shear strength of clay. The test consists of forcing a vane equipped with four orthogonal blades into the soil and then rotating the shaft and blades until soil failure. Maximum torque value must be measured and recorded. Afterwards the remoulding shear resistance of the soil can be measured rotating the vane for several turns.

The vanes have a rectangular shape and a height double their diameter, according to the recommendation included in the EUROCODE 7 (1977) and ASTM Standard Code (D 2573).

The above mentioned codes prescribe that the rotation must be carried out at a rate of 0.1-0.2 degrees/sec. The values have been correlated with a large number of samples to infer the corresponding shear strength.

Figure C.16: Vane Shear Test Instrument

C.5.5 Soil Testing

In-situ and laboratory soil testing is summarized in the following table. The information is similar to that required for siting Mobile Offshore Drilling Units:

Testing Environment	Soil Test	Soil Property
In-Situ	Soil Classification Tests	Visual description Water Content, w Unit weight, γ
	Unconsolidated Undrained Triaxial Test	Undrained shear strength S_u
	Piezo Cone Penetration Test (PCPT), Ball Penetrometer Test (BPT) and T-Bar Test	<u>By direct measurement:</u> Cone resistance q_c , Sleeve friction F_s , and pore pressure, u <u>Using Correlations:</u> Soil Classification Relative Density, D_R (cohesionless soils) Undrained shear Strength S_u Effective Stress friction Angle, ϕ Others (e.g. overconsolidation ratio OCR, Elastic Modulus E).
	Field Vane Shear Test.	Undrained shear strength S_u
Laboratory	Soil Classification Tests	Water Content, w Atterberg limits (cohesive soils) Unit weight, γ Particle Size Distribution Relative Density, D_R (cohesionless soils)
	Unconfined Compression Test	Undrained shear strength, S_u
	Triaxial Test	Shear strength parameters, S_u
	Oedometer	Stress History (OCR) Consolidation Properties

Table C.1 GL Noble Denton Criteria for Seabed and Sub-Seabed Data Required for Approval of MOUs (Mobile Offshore Units)

[Ref. C.13]

The following information is generally required out of the soil testing that takes place on the geophysical survey and associated laboratory analyses:

CLAY	SAND
General description incl. grain size	General description incl. grain size
Particle size distribution	Particle size distribution
Atterberg (plastic/liquid) limits	Relative density
Water content	Maximum and minimum densities
Undrained Shear Strength	Friction angle
Bulk unit weight	Bulk unit weight

Table C.2 Basic Soil Parameters Required for Cable Route

Additional soil parameters may be needed for particular design issues.

APPLICATION	PERTINENT SOIL PARAMETERS (Properties required for S=Sand, C=Clay, R=Rock)													
	Shear Strength	Friction angle	Relative Density	Particle size distribution	Permeability	Compressibility	Sensitivity	Cyclic Strength	Liquefaction Resistance	Rock Quality	Chemical Analysis	Electrical Conductivity	Thermal Conductivity	Backfill Properties
Scour/erosion	C	S	S	S			C		C/S					
Slope stability ¹	C	S	S	C/S										
Liquefaction	C	S	S	C/S	S	C/S								
Settlement	C	S	S			C/S								
Free span assessments ²	C	S	S	S		S								
Dropped objects	C	S	S											
Shore approaches ³	C	S	S	S			C	C/S	S	R	C/S		C/S	C/S
Corrosion											C/S	C/S		
Thermal insulation													C/S	
Plowing	C	S	S	S	S	S	C		C/S					
Jetting ¹	C	S	S	S	S	S	C		C/S					
Self-bury potential/ natural backfill	C	S	S	S	S	S	C		C/S			C/S		
Lateral resistance	C	C/S	S	S										

¹ Strain Rate Effects

² Detailed mapping of outcropping clay, soil spring stiffness

³ Depth to bedrock, weak zones

Table C.3 Additional Soil Parameters for Specific Cable Problems

[Ref.C.14]

C.6 Report on Soils & Bottom Conditions

The exact location of exploration and field investigations must be clearly documented. The field locations and test types should be entered on an accurate scale map which should also show the contours of planned cable route. Reference dimensions to the survey lines should be detailed. The field investigations dates and any special observations made during attendance should be noted.

Summary data should be provided to ensure there is a clear understanding of the issues along the route.

Since the positioning of all construction vessels should be conducted with the use of an electronic (GPS) tracking system the route should be able to be known and once decided upon it should be simple to get the cable to be laid accurately. All hazards and areas of concern in the immediate vicinity of the anticipated cable laying activities should be appropriately highlighted. For shallow-water operations, it may also be prudent to physically mark pipelines or other physical structures with buoys to provide a visual indication. Based on the survey results any anticipated buoyed locations should be identified.

Pipeline or other cable crossings should be recorded and it should be noted as to the source document or information that provided its location, to know on the chart if this is historic information or resulting from physical observations at site. Contact details for the pipeline owner should be included, or at least coordinates of the pipeline and with some idea of direction, size etc.

A Soils Report should contain the following:

- Prepare a synthesis of known natural features of relevant importance, including but not limited to shipwrecks, fault lines, anticipated sediment types, historical feature migration, historical bathymetry, and the geological history of the area;
- Present the results of the multi-beam hydrographic survey along the planned cable route area at a minimum using the performance specification of the International Hydrographic Bureau publication: IHO S-44 Special Order (5th Edition, February 2008), Monaco. This will allow for the detection of items on the seafloor and will give an accurate depiction of bathymetric changes along the cable route. (Single-beam echo sounders typically do not provide the required resolution for accurate planning of a cable route);
- Present the results of the Sidescan sonar investigations reporting objects on the seafloor that are difficult or impossible to trench through. Sidescan sonar specified as a minimum requirement by BSH [Ref. 4.9] along planned cable routes;
- Present the results of the sub-surface profiling including showing the results of layered materials within the bed as well as the possibility of anything erratic that can make trenching difficult: BSH [Ref. 4.9] recommends a minimum resolution of 0.5 m along planned cable routes;
- Present the results of sediment grab samples along the planned cable route and the results of test of contaminants and heavy metals that may create environmental challenges and for organic matter that may affect the design requirements of the cable;
- Present the results of any archeological searches made from magnetometers or drop-cameras that may need to be avoided;
- Present the data, including the location of the borings/samples marked on the chart and a snapshot explanation of the findings including information on the local testing for strength of the soils for supporting trenching equipment such as grain size, gradations and shear strengths;
- Present the data for trenchability including: strain rate effects, permeability (sands/silt), shell content, plasticity, compressibility and relative density;

- Present information on sediment transport conditions across the entire planned cable route including identifications of dynamic features (ridges and shoals), as well as an assessment sediment transport and shoreline change in the vicinity of the cable landing area. Any areas that are particularly susceptible to scour should be identified and appropriate measures recommended by the soils company;
- Present any information on unexploded ordnances, boulders, large sand and gravel ridges and shoals particularly those that may be mobile.

C.7 References

- C.1 Gordon Lucas, “The Evolution of Marine Tools & Technology”, Sub Optic 2007.
- C.2 http://wn.com/echo_sounder
- C.3 NWIA via ICPC Presentation www.iscpc.org
- C.4 Lunne T., The CPT in Offshore Soil Investigations – a Historic Perspective, Norwegian Geotechnical Institute, Oslo, Norway.
- C.5 <http://gralston1.home.mindspring.com/Sidescan.html>
- C.6 <http://www.wisconsinhistory.org/shipwrecks/images/side-scan-sonar-l.jpg>
- C.7 <http://www.generalacoustics.com>
- C.8 http://www.bactec.com/pdf/marine_survey_spec.pdf
- C.9 McNeilan, T., Geological, Geophysical, & Geotechnical Considerations for Offshore Wind, Marine Technology for Offshore Wind Power, Arlington, Va. 2009.
- C.10 Geotechnical & Geophysical Investigations for Offshore and Near Shore Developments, Technical Committee 1, International Society for Soil Mechanics and Geotechnical Engineering, September 2005.
- C.11 IEEE 442 Guide for Soil Thermal Resistivity Measurement.
- C.12 Army Corps of Engineers TM-5-852-6 AFR 88-19, Volume 6, Arctic and Sub-Arctic Construction Calculation Methods for Determination of Depths of Freeze and Thaw in Soils http://www.wbdg.org/ccb/ARMYCOE/COETM/ARCHIVES/tm_5_852_6.pdf
- C.13 GL Noble Denton Criteria for Seabed and Sub-Seabed Data Required for Approval of MOUs.
- C.14 Norsok Standard G-001 Marine Soil Investigations.

APPENDIX D: TYPICAL INSTALLATION VESSELS USED TO DATE

The following information comes from various reports of vessels used for installation of cables for wind farms offshore Europe and will be useful in understanding the size and type of vessels that may be identified for U.S. operations.

For shallower waters the Oceanteam Installer in Figure E.2 is capable of sitting on the seafloor during low tides.



Figure D.1: Oceanteam Installer – a flat bottom barge (Courtesy of Oceanteam Power and Umbilicals).

The Oceanteam Installer characteristics are 65 m. long x 22 m. wide, crane, two spud poles, two thrusters, a four point mooring system and a pull winch.

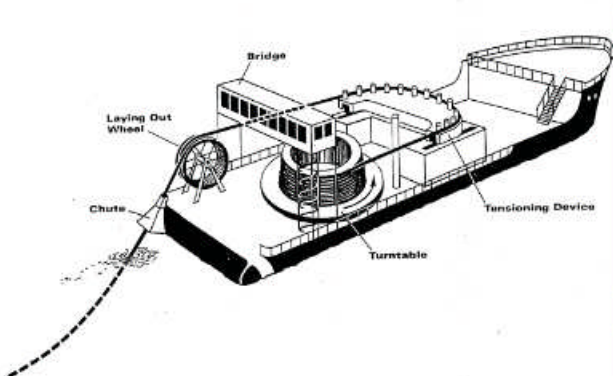

Figures D.2: Henry P. Lading.

(Courtesy of JD-Contractor A/S).

The inter-turbine and export cables to Middelgrunden were laid by the Henry P. Lading vessel shown in Figure D.2. Characteristics include a 40 ton crane, 1800 ton Carousel and a 6 m. laying wheel, with an 81 m. beam and a small minimum draft approximately 3.1 m. It has no propulsion machinery and is equipped with an anchor winch, 6 warp winches and 2 capstan winches complete with anchors, chains and wires and accommodation for 26 people. (Sketch courtesy of Robert Donaghy HV Submarine Cable Systems Design, Testing and Installation, Cigre Ireland Technical Seminar October 2006).

Note that a number of the installation vessels are equipped with A-frames in order to launch the plow. Cranes are required among other services, to put concrete mats into place, deploy ROVs or to haul up debris in the path.



Figure D.3: AMT Discoverer was the cable laying vessel for Rhyl Flats for the inter turbine cables. (Courtesy Anchor Marine Transportation).

The characteristics of the AMT Discoverer, Figure D.3, are a 2800 m.² deck space, 5500 ton carousel and associated cable lay spread, 300 ton crane, Length 91.9 m., Breadth 30.5 m., minimum Draft 1.1 m., maximum Draft 6.2 m. and accommodation for 48 persons; 3.0 m. cable plow spread; 8 point mooring spread with an additional 200 Te pull ahead winch.



Figures D.4: AMT Explorer

The AMT Explorer, Figure D.4, was used to lay the export cable for Rhyl Flats and did some cablework on Greater Gabbard. The carousel is capable of 7000 tons. The dimensions are: Length 91.7 m., Breadth 30.3 m., and a Draft of 2.5 m. (Courtesy of Anchor Marine Transportation).



Figure D.5: Global Marine Systems C.S. Sovereign

The C.S. Sovereign, Figure D.5, laid the cable for Prinses Amelia and Barrow inter-turbine cable. It is dynamically positioned rated DPS-2. The equipment includes a trenching/work class ROV and a 35 tonne A-frame. It has 2 main tanks for cable of 2800 tons each. Bollard pull approx. 80 Te. Draft approx. 7 m.



Figure D.6: Pontra Maris

The Pontra Maris, Figure D.6, was frequently used in European wind farms including Q7 and Barrow, measuring 70 m. x 23.8 m. with a Draft of 3 m. fully loaded. It has 6 x 40 ton line pull constant tension winches, with 80 ton hold. Drum storage: each winch up to 800 m., ϕ 38 mm. Central controlled from a control cabin and 13 cabins for total 26 persons (Courtesy Stemat).



Figure D.7: Normand Mermaid

The Normand Mermaid, Figure D.7, is dynamically positioned with 80 ton crane and dimensions 90.1m. x 20.5 m., a Draft of 7 meters and accommodation for 70. This vessel was used on Greater Gabbard to carry out some of the cable splicing. It was also used for the cable work on Thanet.



Figure D.8: UR101 Beached at Lynn and Inner Dowsing,



Figure D.9: Polar Prince

The Polar Prince, Figure D.9, has 180 Te bollard pull, cable lay spread installed with a carousel or reel based system – project dependent. Equipment includes a 3.0 m. cable plow spread, integrated ROV spread, heave compensated crane for concrete mattress installation, and an A-Frame launch / recovery system for the cable plow. It was used on Thanet and Greater Gabbard.

The cost increases as the size and sophistication of the vessel, but the investment in the submarine cable and “getting it right” is important. A discussion on the economics of the vessels is contained in a BOEMRE TA&R study [Ref. 9.3].

The designs of the plows vary and a tug bollard pull range to be available may be 50-180 tons, however, there are some plows on the market that claim to be able to work with vessels and lower bollard pull tensions.

The vessels that might get adapted in USA may go through an upgrading process: as an example of one upgrading the following may be instructive:

ABERDEEN — Aberdeen-based subsea construction company Subocean Group has invested almost GBP 16 million (US\$24.5 million) in cable laying equipment and the re-fit and mobilization of cable-laying barge ATM Discoverer, which is on long term charter to meet demand for services in the offshore wind sector.

Subocean has put GBP 5 million (US\$7.65 million) into a long-term charter and the re-fit and mobilization of the barge. The vessel is also being equipped with a cable plough to bury the power cables up to three meters (9.8 ft) below the seabed. ATM Discoverer is being mobilized by Fergusons in Port Glasgow in a contract worth around GBP 500,000 (US\$765,462) and involving 30 shipyard workers.

The company has invested GBP 5 million (US\$7.65 million) in a 5,500-ton cable carrying capacity carousel for reeling the power cables on to the barge before laying the cables under the seabed. A further GBP 2 million (US\$3 million) has been spent on two new specially designed cable ploughs acquired from IHC Engineering Business.

The equipment is for exclusive use on recently awarded contracts in the offshore renewable energy sector in the UK.

The company has also invested GBP 4 million (US\$6.12 million) in upgrading its existing UR101 (Figure D.8) barge with a 1,000-ton cable carrying carousel and upgrading an existing cable plough to make it capable of cable burial in depths of three meters (9.8 ft.). [Ref. 9.4].

The load capacity required for the cable laying vessel is a function of waterdepth and draft, but ideally the vessel should be capable of laying each cable between turbines, or for the export cable laying the cable from field to shore, without joints. Turntables are ideal in that the larger cables may not be able to be stored in a coiled tank, depending on their bending radius. In storing cable the minimum coiling diameter of the coiling ring should be no less than 60 times the cable diameter [Ref. 9.5]. A vertical axis turntable must be carefully loaded and unloaded with a constant tension arrangement as the cable layers can slide down if the tension is not sufficient.

Coiling cable on deck has to be done with caution. The lay of the armor determines how the coiling can be accomplished e.g. right lay, left lay or double cross lay, since it may be twisting in an undesirable direction opening spaces in the armor cable by the twisting effect.



Figure D.10: Coiling Submarine Cable prior to Deployment

In the case of paired HVDC cables in shallow water, the lay technique is to lay 2 cables (requiring 2 turntables) and the cable pair is bundled, perhaps with separate fiber optic cable, all at the same time.



Figure D.11: Protective Plastic shells

These shells in Figure D.11 are attached to two HVDC cables and a fiber optic cable before the cable group leaves the vessel. [Courtesy ABB Sweden][Ref. 3.36].

The vessel must be equipped with the ability to position very accurately on the cable corridor. The corridor permitted by the BOEMRE is reasonably small, and ensuring to stay within the permit coupled with staying close to the prescribed route is most important.

The jointing house is an important feature of the vessel and has been discussed in Appendix B.

Winches and other cable tensioning devices are needed to apply tension during loading, and during laying. The paying out mechanism must be capable of holding the weight of the cable to the seabed, in a catenary, allowing for deviations, and must be able to take an additional dynamic load from the motion of the vessel. It seems clear that when loading the vessel from shore one doesn't want a "run-away" where the cable reels off a shore based bobbin and takes up such a speed that the cable lay vessel cannot load it fast enough. Likewise when laying offshore one must be sure that the cable cannot continue off the vessel when the marine spread has to stop.

Many other installation aids are required which are not so much a function of the vessel type, but are still very important. ROV equipment is necessary since in many instances there is a need for observation at trench level, and sometimes action below when it is inconvenient or inclement weather to deploy divers. The ROV system has its own space and deploying equipment, and its own crew to operate.

The control of the vessel during the laying is critical. The cable must maintain constant tension with the seafloor and be deployed as a catenary. If it is laid vertically the cable can select any direction and thus may easily kink. Moving backwards during the lay can cause the same problem. The anchors used must be appropriate for the bottom conditions and the winch tensions must counteract the cable under tension during the laying. The anchor handling boats must be well coordinated. If the anchors are insufficient then additional tugs need to be attached to the laying barge and their actions must be carefully coordinated by a towmaster.



Figure D.12: Installation Vessel installing the cable (Courtesy ABB).

The shore approach requires the cable to be floated off with buoys and hauled ashore. In some cases it is necessary to provide a cofferdam for splicing the cable to a cable segment with a larger

conductor. The larger conductor the shoreline segment is to overcome heating problems when the cable is on land instead of being in the sea where it is possible to dissipate the heat.

Table D.1 gives a list of the some typical offshore wind farms and the vessels which are believed to have been associated with the cable laying operation. Much of the information is provided from the www.4c.com website, but other and sometimes conflicting information has been found, and the reader should be cautious and check the data before using it. Direct contact with 4C or with the wind farm owners is recommended if this data is to be used for anything other than a general appreciation of the vessel types used in this service, the number that are used on site, and the names that that may show up for multiple wind farms.

Wind Farm	Vessel
Arklow Bank	Coastal Spider- export cable and interarray cable
Bard 1	Maersk Recorder with 4 jet trenching for array cable; Northern River and T1 Trencher for cable installation
Barrow	Pontra Maris – Export cable; Pontra Maris & MPI Resolution – Inter-turbine; Buried with ROV; CS Sovereign for remedial array cable lay
Beatrice	Sovereign (DP2)- to lay; Atlas to bury them with ROV. Light intervention and inspection Super Mohawk ROV
Blyth	Coastal Explorer; Andre B dredger for part of the deeper trenching.
Blyth	Voe Viking removed old power cable and re-laid new cable;
Borkum West II Phase I	Nostag 10 will install the array cabling
EnBW Baltic 1	M.S. Vina laid the array cables; Cable One used its coil carriage to feed the cable into the seabed.
Greater Gabbard	Far Sovereign - array cables; (Polar Prince had been planned for); Deep Cygnus - array cables; AMT Discoverer- installed 2 export cables; Normand Mermaid conducted cable splicing; Normand Pioneer conducted cable splicing.
Gunfleet Sands	Nico infield cable; EIDE 28 for export cable installation.
Horns Rev	H.P. Lading- Export cable;
Horns Rev 2	Team Owen – Export cable; Pontra Maris and Stemat 82 for interarray cable; Excalibur, Super Mowhawk & Atlas II ROVs to bury the cable; (also mention of CS Sovereign & Oil Express installations being utilized).
Kentish Flats	Pontra Maris – Export cable; Pontra Maris & Wind Jack-up for post lay burial work with Otter Trenching System.
Lillgrunden	Pleijel array cable installation; Dredger GRÄVLINGEN used for pre-excavation of export cable trench. 1 m. deep and 1.5 m. at base. Nautilus Maxi installed the export cable.
Lynn and Inner Dowsing	U101 for array and export cables; Stemtat Oslo for cable repair.
Middlegrunden	Henry P Lading - export cables;

Wind Farm	Vessel
North Hoyle	Pontra Maris - export cable
Nysted	Mika 1 for laying, installation and trenching.
Ormonde	Pontra Maris array cabling; Stemat Spirit for export cable;
Prinses Amelia	Pontra Maris to lay both export and interarray cables & Subtrench II to complete the trenching; C.S. Sovereign to install array cable with Atlas 1 ROV.
Q7	Pontra Maris involved with the cables;
Rhyl Flats	AMT Discoverer – Inter-array cables; AMT Explorer export cable
Robin Rigg	U101 for array cables and some export cable; AMT Explorer for array and export cable MV Union Beaver for 90 mm and 113 mm array cable;
Rodsand	Nostag 10 for array cable; Henry P Lading for transport and installation;
Sheringham Shoal	Stemat Spirit & Team Oman to install both the array and export cables.
Thanet	MW Sia & Polar Prince assisted by Normand Mermaid laid the array Cable; U101 & Stanislav Yudin for export cabling;
Thornton Bank	CS Sovereign array cabling;
Tuno Knob	Henry P Lading -export cables 1995
Utgrunden	M/S Honte - laying the new cable and moving the existing cable to the bottom of the trench; Per Aarsleff excavating trench to 2.5 m; Helle Saj covered the cables post lay
Walney Phase I	VOS Sympathy jettied down the array cable; Stemat 82 to install array cable; Normand Mermaid -install array cable; Pontra Maris & Stemat Spirit installed export cable;
Walney Phase II	Giulio Verne -install a section of export cable to substation; Stemat Spirit will do another section

Table D.1 Offshore Wind Farm and Installation Vessels believed to have been on site.

APPENDIX E: SUBMARINE CABLE INSTALLATION EXAMPLE OFFSHORE WIND FARM- BLYTH

E.1 Overview

Blyth wind farm was commissioned in 2000. It comprises two 2 MW turbines installed at a distance of 1 km from the UK coast, in a water depth of 6 m (low tide) with a tidal range of 5 meters. The site location is on a submerged rocky outcrop.

Since the distances were small, a small survey vessel, the Coastal Explorer was used for the installation of both the inter-array and the export cables.



Figure E.1: Coastal Explorer



Figure E.2: Coastal Explorer laying the inter-array Cables

The scope of work for the installation of the power cable between the two offshore wind turbines and the mainland included:

- Diver Swim Survey across the harbor and the site of the turbines
- Installation of the duct and cable across the harbor mouth, the cable between turbines and the export cable

The cable going across the harbor had to be buried 2 m below the maximum dredged depth requiring the project to excavate a shallow trench in the bedrock of the river bed, lay ducting, then pinning the duct to the floor of the trench and laying the cable through the duct.

The Andre B, a spud leg dredger, was used to trench the cable into the seabed at a depth of 2 meters and was followed by a pontoon by which the removed sand which was disposed of (with appropriate environmental permits).

The installation of the high voltage cable had to be done before the Wijslift (small jack-up barge) could move due to the fact that the generator on board was needed to operate the nacelle service crane as there was no electrical power in the turbine at that time. The cable drum was lifted in a frame that was then mounted onto the access platform. The nacelle service crane was used for pulling the cable inside the turbine through the door and also during the installation.

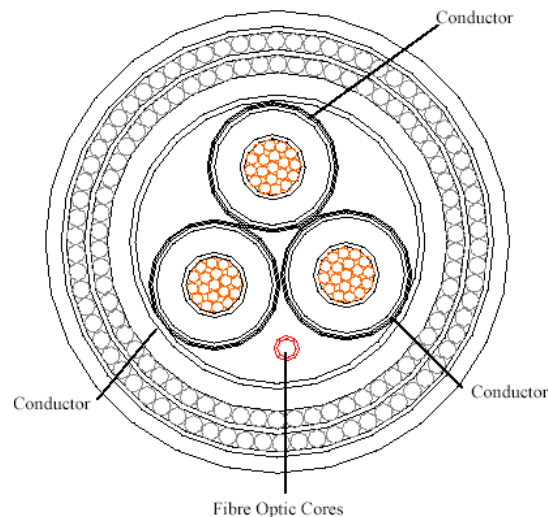

Figure E.3: Cross Section of 70 Sq. mm Double Armor with 16 fibers Optic Package

The optic fibers were contained in a seamless, laser welded, and hard drawn stainless steel tube filled with a thixotropic compound. The cable load elongation performance is crucial to the fiber long term performance and effective service life. Therefore the optic package was of a loose tube construction ensuring that the fibers saw no strain at the designated working load.

The original plan for the duration of cable laying was 60 days whereas it actually took 3.5 months. Some of this delay was due to the weather and one of the contributors was that the divers could not work in the weather conditions that were too severe. The installation of the inter-turbines cables, took

three days rather than one day as planned. There were delays of 7-10 days downtime in laying the cable across the river, and the dredging work that preceded it. Some of this downtime was due to repairs to the hydraulic system of the dredger and also some time in changing out buckets that were broken digging the rock out of the seabed. Another issue was that the trench and ducts backfilled before the cable could be pulled through, requiring these to be cleaned out regularly during the laying process.

E.2 Beach Preparatory Work

Site perimeter barricades for the beach work were required because the cable is under tension when being laid and letting go could prove a major safety issue.

The cable handling equipment was loaded on board the Coastal Explorer and bolted into place. Once the vessel had been mobilized the cable drum was loaded on board and installation commenced.

Navigation, tracking, monitoring and recording systems consisted of 1 x DGPS receiver which provided a Helmsman's display and had a data logging feature that recorded the position of the installed cable.

E.3 Cable Landing at the Turbines

The installation vessel was moored close to the base of the southern turbine. The cable end was then passed up the J-Tube via a short messenger line, utilizing a small winch. Once the required amount of cable had been installed and secured into the turbine, the cable lay could commence. When the installation vessel approached the shore, the cable end was passed to the beach team via divers (wading depth), who then pulled the remaining cable onto the beach, until the required amount of the cable was ashore.

E.4 Diving Operations

The diving operations had to be thoroughly planned, briefed and executed in accordance with good diving practice and the regulations. The Coastal Explorer was also used as a dive support vessel. The work included:

- Surveying the proposed shore end route;
- Assisting with the pulling rope;
- Removing the cable floats;
- Surveying the as-laid cable;
- Supporting the cable lay and burial operations;
- Attachment of the ducting where cable was fed through the ducting for extra protection.

The authorization to dive was required from the Diving Supervisor, Offshore Superintendent and Beach Master to ensure operational safety for the divers.

E.5 Cable Lay Operations between the Northern & Southern Turbines

The vessel moved to the North turbine and moored up at the base of the turbine. A messenger line was run up the J-Tube and a small winch was installed at the top of the J-Tube. The cable was then hauled up the J-Tube via the messenger line. Once the required amount of cable had been hauled up the cable was then secured inside the turbine tower. The cable that was laid between the two turbines and also from the southern turbine to the beach was laid directly onto the seabed. The cable was paid out from the cable drum, controlled by the power cable stand, via the overhead cable roller quadrant and cable pathway. The cable lead was visible at all times from the deck of the vessel.

E.6 Cable Lay Operations Across the River Blyth

In order to affect a beach landing it was necessary to remove 2 m of mud overburden and cut a trench into the bedrock.

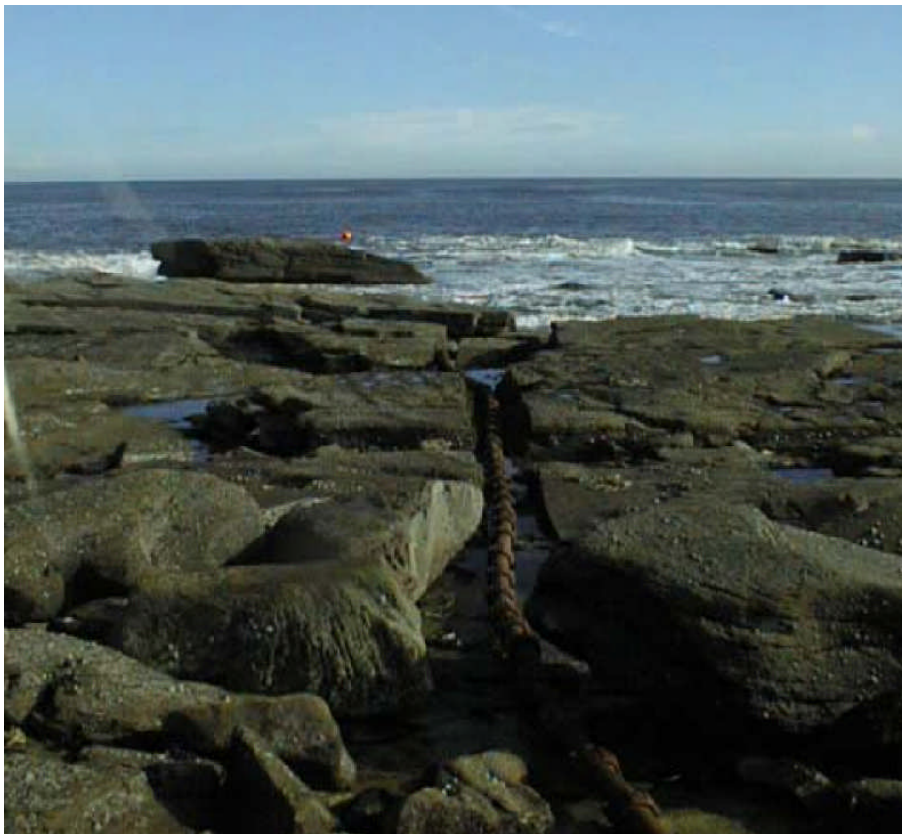

Figure E.4: Shore Connection dug into the Rocks (Source: Figure 12 www.berr.gov.uk/files/file_18014.pdf)

A spud leg dredger was mobilized (with dredging arm) to carry this out, throughout most of the tidal range. As the trench was excavated a duct was installed. It was positioned in the trench by divers and weighted so that it would sink. At the breakwater the duct met with another directional drilled duct and as a manhole had previously been excavated in the harbor wall the cables could be joined. The cable for the harbor crossing was delivered to site on a drum. The drum was set up on the shore/quayside and pulled through the duct to the manhole, using a winch.



Figure E.5: Dredger Operation with Pontoon alongside.

Initially it had been understood that the cable had to be buried 2 m. below the current dredged depth of the river so the initial plan was to prepare a deep trench across the river below bed level and bury the cable in a trench without the use of ducts. The Harbor Commission, however, actually required the cable to be buried under the River Blyth at a depth of 2 m below the maximum dredged depth – and this caused a change of marine equipment because of the need to excavate a shallow trench in the bedrock of the river bed, lay ducting, then pin the duct to the floor of the trench and lay the cable through the duct.

The rock was a lot harder than at first thought, causing several problems mainly breakages of dredger equipment which resulted in delays as the equipment had to be replaced. [Ref. 1.3].

Offshore: Risk & Technology Consulting Inc.

CORPORATE HEADQUARTERS

506 Nottingham Oaks Trail, Suite 200,

Houston, Texas 77079

Tel: 713-922-8170 Fax: 281-840-5691

Principal: Malcolm Sharples, B.E.Sc, Ph.D., FSNAME, P.E.