

HILTI

Interior Construction
Catalog

2008 Edition



On the job. Every day.

Hilti. Outperform. Outlast.

We're with you every step of the way.

At Hilti, our people and products are with you every step of the way. From design to construction, we support you with expert technical advice, reliable products, prompt delivery, ongoing research and development, and outstanding service from a team of highly trained professionals to make your team more productive, every day.

Local Account Managers are highly trained product and application experts

Field Engineers work directly with architects and engineers to provide technical assistance and on-site problem solving

Fire Protection Specialists offer firestop consultation and training

Fire Protection Engineers provide Engineering Judgments for unique and complex applications

Diamond Coring Specialists provide expert, hands-on training for the use of diamond coring systems

Engineering and Custom Services provide solutions for unique application needs

We're available nearby.

Inside Sales

Hilti, Inc. (U.S.) — 1-800-879-8000

Servicio al Cliente en español — 1-800-879-5000

Hilti (Canada) Corporation — 1-800-363-4458

Real-time order entry, application assistance and technical support

Online

Hilti, Inc. (U.S.) — www.us.hilti.com

Hilti (Canada) Corporation — www.hilti.ca

Anytime access for online ordering, up-to-date product and application information, maps to local Hilti Centers, Hilti ProShops and rental outlet locations

Hilti Centers

Convenient locations provide on-hand inventory, expert technical advice and product training

Hilti ProShops

Hilti ProShops at The Home Depot provide quick and easy access to quality Hilti products and professional expertise

Independent Rental Outlets

Convenient access to Hilti products to meet peak demand or unique project needs

Authorized Dealers

Trained to deliver local availability with Hilti-quality sales and service

¡Ahora en español!

Lifetime Manufacturers Warranty

Hilti repairs or replaces the tool at no cost, if there is damage to the tool due to defects in materials or workmanship.

See page 34.

HILTI	2 Years
LIFETIME SERVICE™	NO COSTS
Lifetime	Lifetime
REPAIR COST LIMIT	MANUFACTURERS WARRANTY

Hilti Tool Fleet Management

We'll manage your tools so you can manage your business.

See page 35.

For the price of a coffee...
...have yourself a new Hilti tool.

Hilti Online...24/7:

- Online ordering
- Technical library
- Design centers
- Interactive product advisors
- Full-line product catalog
- Locator maps
- Answers to questions

www.us.hilti.com

www.hilti.ca



Table of Contents

Measuring Systems Page 4

Accurate laser tools for easy one-person layout and measuring

Cordless Page 6

Cordless power you can depend on

Screw Fastening Page 12

Complete system of screwdrivers and screws available from one source

Direct Fastening Page 15

Powder-actuated and gas-driven tools and consumables for quality fastenings

Drilling & Demolition Page 21

Tough combihammers and demolition tools are the symbol of Hilti quality

Adhesive & Mechanical Anchoring Page 24

Tested and approved for use in a wide variety of base materials

Cutting & Sawing Page 28

Powerful systems for cutting, grinding and finishing concrete, metal and wood

Installation Systems Page 30

Labor saving, versatile systems for all trades

Foam & Construction Chemicals Page 31

Foam and construction chemicals designed to seal and insulate

Firestopping Page 32

UL tested and listed firestop systems for Life Safety

Hilti. Outperform. Outlast.

The Hilti Difference... Hilti measuring systems are designed to save time and reduce the number of people needed to perform measuring, estimating, leveling and alignment tasks. Using highly accurate, state-of-the-art technology, Hilti laser systems are designed for easy

operation and jobsite durability. And Hilti measuring systems are all backed by Hilti Lifetime Service™, including one no-cost calibration per year for the first two years from date of purchase.

Hilti. Outperform. Outlast.



PRI 2 Rotating Laser

- Fully automatic horizontal and vertical leveling
- 360° remote control use
- Out of level indicator reduces errors
- Four handle Hilti design for added tool protection and ease of handling
- Optional rechargeable battery pack for hours of continued use

Item No.	Description
331411	PRI 2 Rotating Laser Includes tool, PRA 2 remote control, PRA 51 target plate, (2) "D" alkaline batteries and operating instructions in an impact-resistant plastic tool box
3427904	PRI 2 Interior Kit Includes tool, PRA 71 wall mount bracket, PRA 2 remote control, PRA 51 target plate, (2) "D" alkaline batteries and operating instructions in an impact-resistant plastic tool box
3428196	PRI 2 Interior Kit Rechargeable Includes tool, PRA 71 wall mount bracket, PRA 2 remote control, PRA 51 target plate, (2) "D" alkaline batteries, PRA 82 battery pack, PUA 80 battery charger and operating instructions in an impact-resistant plastic tool box
233904	PUA 32 Crank Tripod
331419	PRA 22 Laser Receiver
331421	PRA 82 Rechargeable Battery (battery only)
377460	PUA 80 Battery Charger
285416	PRA 51 Target Plate

Technical Data

Accuracy	+/- 1/8 in. at 100 ft (+/- 1.0 mm at 10 m)
Range (diameter)	Up to 100 ft (30 m) without a receiver 7 ft - 500 ft (2-150 m) radius with PRA 22 laser receiver
Function	For horizontal or vertical alignment, setting slopes and laying out right angles
Self-leveling range	+/- 5°
Laser class	635 nm, Class 3a/IIIa (IEC 825-1; FDA 21 CFR 1040)
Protection class	IP 54



Optional PRA 22 receiver

PR 25-IF Rotating Laser

- Auto Alignment System™: one person layout with the touch of a button
- PRA 25 remote control and electronic receiver in one device
- Heavy duty design: Fully enclosed rotating head for indoor and outdoor protection



Item No.	Description
286210	PR 25-IF Rotating Laser (Laser class 3a) Includes tool, PRA 25 remote control and electronic receiver, PRA 51 target plate, (3) "D" alkaline batteries, (2) "AA" alkaline batteries and operating instructions in an impact-resistant plastic tool box
3409447	PR 25-IF Interior Kit with Wall Mount Bracket (Laser class 3a) Includes tool and its components plus PRA 71 wall mount bracket and soft pouch
3409652	PR 25-IF Interior Rechargeable Kit (Laser class 3a) Includes tool and its components plus PRA 71 wall mount bracket, PRA 80 rechargeable battery pack and soft pouch
286212	PRA 25 Laser Remote Control and Electronic Receiver Use with PR 25 and PR 25-IF, remote control and electronic receiver
285315	PRA 71 Universal Wall Mount Bracket For mounting PR 16 or PR 25 to wall for hanging suspended ceilings, mounting to tripod for vertical alignment or mounting to column or stud

Technical Data

Accuracy	+/- 1/11 in. at 100 ft (+/- 0.75 mm at 10 m)
Range (diameter)	Remote control up to 300 ft / Laser receiver up to 1300 ft using 50 or 300 rpm speed
Function	For horizontal or vertical alignment, setting slopes and laying out right angles
Self-leveling range	+/- 5°
Laser class	635 nm, Class 3a/IIIa
Protection class	IP 56 as per IEC 529 std



Hilti. Outperform. Outlast.

PD 40 and PD 42 Laser Range Meters



- Innovative pulse technology
- Durable rubber protection surrounding all the edges of the tool
- PD 40: Measures distance, adds and subtracts measurements and calculates square footage
- PD 42: Includes all PD 40 functions plus calculates volume, 3 Pythagorean modes, painters area, sets out distances, memory and timer functions, built-in opticals



Item No.	Description
320280	PD 40 Range Meter Includes tool, soft pouch, (2) "AA" alkaline batteries, hand strap and operating instructions in a cardboard box
320285	PD 42 Range Meter Includes tool, soft pouch, (2) "AA" batteries, target plate, hand strap, operating instructions in a cardboard box
226879	PDA 52 Target Plate (large)
226878	PDA 71 Measuring Extension

Technical Data

Accuracy	+/- 1/25 in. (+/- 1.0 mm)
Range	2 in. up to 650 ft (0.5 - 200 m)
Function	PD 40: Add, subtract, area, clear PD 42: Add, subtract, area, volume, painters area, 3 Pythagorean modes, min/max, timer, setting out, memory
Data Memory	PD 40: Last 5 measurements PD 42: Last 30 measurements

PMP 32 Plumb Laser

- Self leveling: settles in less than 3 seconds
- Out-of-level indicator
- Integrated foot with small built-in magnets to hold in place against the drywall track



Item No.	Description
383554	PMP 32 Plumb Laser Includes tool, (4) "AA" batteries, soft pouch, (2) target plates and operating instructions in a cardboard box
383555	PMA 52 Target Plate
383556	PMA 61 Soft Pouch

Technical Data

Accuracy	Plumb Beam: +/- 1/8 in. at 30 ft (+/- 3 mm at 10 m) Reference Beam: +/- 1/2 in. at 3 ft (+/- 2 mm at 1 m)
Range	Plumb Beam: 100 ft (30 m) Reference Beam: 3 ft (1 m)
Function	Vertical alignment, transferring points from floors to ceilings
Self leveling range	+/- 4°

PMP 34 / PMP 34-F Point Laser

- PMP 34: Automatic pendulum lock system for added protection when the tool is closed
- Plumb, level and square from a single reference point
- PMP 34: Adjustable housing lets you mount the tool vertically, horizontally or on an inclined surface



Item No.	Description
287261	PMP 34 Point Laser Includes tool, soft pouch, target plate, PMA 75 drywall adapter, (4) "AA" alkaline batteries and operating instructions in a cardboard box
287262	PMP 34 Point Laser Kit Includes tool, soft pouch, target plate, PMA 75 drywall adapter, (4) "AA" alkaline batteries, PMA 74 magnetic bracket, PMA 71 wall mount, PA 250 frame clamp, (2) marking pencils and operating instructions in an impact-resistant plastic tool box
3411454	PMP 34 Kit with Magnetic Bracket Includes PMP 34 Point Laser and its components plus PMA 74 magnetic bracket
224070	PMP 34-F Point Laser Compact fixed base, fits inside track (Not compatible with multi-directional accessories)

Technical Data

Accuracy	+/- 1/8 in. at 30 ft (+/- 3 mm at 10 m)
Range	Up to 100 ft (30 m)
Function	4 beams with single origin, 2 plumb beams and 2 level beams at 90°
Self leveling range	+/- 5°



PMP 34-F

PML 32-R Line Laser

- 120° fan angle produces a long visible line
- Automatic pendulum lock system for added protection when tool is closed
- Optional receiver enables work over a long distance in bright light conditions



Item No.	Description
331542	PML 32-R Line Laser Includes tool, soft pouch, PUA 60 laser visibility glasses, (2) target plates, (4) "AA" alkaline batteries and operating instructions in a cardboard box
354481	PML 32-R Line Laser Kit Includes tool, (4) "AA" alkaline batteries, PMA 30 laser receiver, laser visibility glasses, (2) target plates and operating instructions in a cardboard box
380631	PML 32-R Deluxe Kit Includes tool, (4) "AA" alkaline batteries, PMA 30 laser receiver, PMA 74 magnetic bracket, PMA 76 ceiling clamp, PRA 51 target plate, PUA 70 markers, rotating disc and operating instructions in an impact-resistant plastic tool box
272707	PMA 76 Ceiling Clamp
2842	PMA 30 Receiver

Technical Data

Accuracy	+/- 1/16 in. at 30.5 ft (+/- 1.5 mm at 10 m)
Range	With receiver: Up to 100 ft (30 m) Without receiver: Up to 30 ft (10 m)
Self-leveling range	+/- 5°



PMA 30 Receiver



PMA 76 Ceiling Clamp



Hilti. Outperform. Outlast.

The Hilti Difference... Hilti cordless systems offer the power and durability you need to get the job done quickly and efficiently. Our award winning designs are tailored with the professional craftsman in mind. From durable glass-fiber reinforced casings to rubberized comfort grips and overall tool balance, Hilti cordless tools are built to ease your work

effort. Coupled with top quality Hilti NiCd, NiMH and Li-Ion / CPC batteries, our cordless systems help you outperform and outlast.

Hilti. Outperform. Outlast.

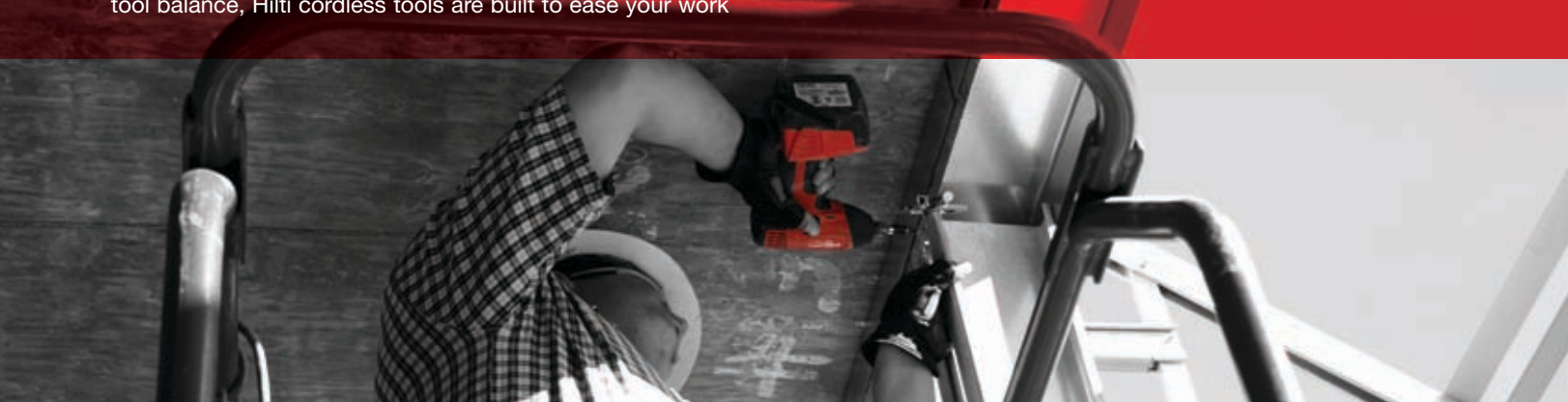

SID 144-A CPC / SIW 144-A CPC Cordless Impact Driver

- CPC batteries deliver reliable power
- High efficiency motors deliver long lasting reliable power
- Drop resistant casing for tough jobsite conditions
- Double spindle bearing for longer life
- Three LED lights provide better visibility



Technical Data

Capacity	Li-Ion B14: 2.6-Ah CPC at 14.4 V = 37.4 Wh
Blows per minute	0-3100 blows/min
No load	1st speed: 0-2100 rpm 2nd speed: 0-2700 rpm
Max torque (1st speed)	SID 144-A CPC: 930 in-lb SIW 144-A CPC: 1025 in-lb
(2nd speed)	SID 144-A CPC: 1240 in-lb SIW 144-A CPC: 1370 in-lb
Chuck	SID 144-A CPC: 1/4" hex socket with lock ring (Snap Chuck) SIW 144-A CPC: 1/2" square drive with locking pin
Weight with battery	3.5 lb

Item No.	Description
3418187	SID 144-A CPC 1/4" Hex Driver (C 4/36 Li-ACS charger)*
3418189	SID 144-A CPC 1/4" Hex Driver (C 4/36 Li-ACS TPS charger)*
3418188	SIW 144-A CPC 1/2" Square Driver (C 4/36 Li-ACS charger)*
3418190	SIW 144-A CPC 1/2" Square Driver (C 4/36 Li-ACS TPS charger)*

*Kit includes tool, (2) B 14 Li-Ion 2.6-Ah CPC batteries, battery charger and operating instructions in an impact-resistant plastic tool box

SF 144-A CPC Drill Driver

- CPC batteries deliver reliable power
- High efficiency motor delivers reliable power
- Long-lasting, 100% all-metal gears for greater reliability
- Drop-resistant glass-fiber reinforced casing for tough job site conditions
- Robust CPC lithium ion cells for reliability



Technical Data

Capacity	2.6-Ah at 14.4 V = 37.4 Wh
No load	1st speed: 0-380 rpm 2nd speed: 1400 rpm
Max torque	Flexible screw fastening in wood: 292 in-lb Rigid screw fastening in metal: 619 in-lb
Torque clutch	17-106 in-lb with 15 settings
Chuck	Steel jaws, up to 1/2" dia.
Weight with battery	4.8 lb

Item No.	Description
3431126	SF 144-A CPC Drill/Driver (C 4/36 Li-ion battery charger)*
3431127	SF 144-A CPC ACS TPS Drill/Driver (C 4/36 Li-ACS TPS battery charger)*

*Kit includes tool, (2) B 14 Li-Ion 2.6-Ah CPC batteries, battery charger and operating instructions in an impact-resistant plastic tool box



Hilti. Outperform. Outlast.

Hilti, Inc. (U.S.) 1-800-879-8000 www.us.hilti.com • en español 1-800-879-5000 • Hilti (CA) Corporation 1-800-363-4458 www.hilti.ca

12 V NiCd / NiMH

SID 121-A / SIW 121-A Cordless Impact Driver and Wrench

- Virtually no reactionary torque for superior comfort
- Double spindle bearing for longer life
- LED lights for better visibility applications



Item No.	Description
3418164	SID 121-A 2.0-Ah NiCd 1/4" Hex Driver (SFB 121 batteries)*
3418165	SID 121-A 3.0-Ah NiMH 1/4" Hex Driver (SFB 126 batteries)*
3418167	SIW 121-A 2.0-Ah NiCd 1/2" Square Driver (SFB 121 batteries)*
3418168	SIW 121-A 3.0-Ah NiMH 1/2" Square Driver (SFB 126 batteries)*

*Kit includes tool, (2) batteries, C 7/24 battery charger and operating instructions in an impact-resistant plastic tool box

Technical Data

Capacity	2.0-Ah at 12 V = 24 Wh
Blows per minute	0-3100 blows/min
Max torque (1st speed)	SID 121-A: up to 867 in-lb SIW 121-A: up to 965 in-lb
Max torque (2nd speed)	SID 121-A: up to 1155 in-lb SIW 121-A: up to 1290 in-lb
Tool weight	3.7 lb

15.6 V NiCd / NiMH

SF 151-A / SFH 151-A 15.6 V Cordless Drill/Drivers

- Highest torque available among all 15.6 V tools on the market (up to 619 in-lb)
- Drop resistant casing made from a highly durable composite
- SFH 151-A: 3 speed settings with hammer drilling (0 - 2,000 rpm)



Item No.	Description
227936	SF 151-A 2.0-Ah NiCd (SFB 150 batteries)*
227942	SF 151-A 3.0-Ah NiMH (SFB 155 batteries)*
227949	SFH 151-A 2.0-Ah NiCd (SFB 150 batteries)*
227955	SFH 151-A 3.0-Ah NiMH (SFB 155 batteries)*

*Kit includes tool, side handle, (2) batteries, C 7/24 battery charger and operating instructions in an impact-resistant plastic tool box

Technical Data

Capacity	2.0-Ah at 15.6 V = 31.2 Wh 3.0-Ah at 15.6 V = 46.8 Wh
Blows per minute	SFH 151-A: 36,000 blows/min
Max torque	Flexible screw fastening in wood: 292 in-lb Rigid screw fastening in metal: 619 in-lb
Torque clutch	17-106 in-lb with 15 settings
Tool weight with battery	SF 151-A: 2.0-Ah NiCd: 5.5 lb 3.0-Ah NiMH: 5.6 lb SFH 151-A: 2.0-Ah NiCd: 5.9 lb 3.0-Ah NiMH: 6.0 lb



18 V NiCd / NiMH

SF 181-A / SFH 181-A 18 V Cordless Drill/Drivers

- Highest torque available among all 18 V tools on the market (up to 690 in-lb)
- Long-lasting, 100% all-metal gears for longer tool life and greater reliability
- SFH 181-A: 3 speed settings with hammer drilling



Item No.	Description
272608	SF 181-A 2.0-Ah NiCd (SFB 180 batteries)*
3420705	SF 181-A 3.0-Ah NiMH (SFB 185 batteries)* Kit also includes (1) 10 pc. insert bit pocket pack and (2) 1/4" jobber bits
272623	SFH 181-A 2.0-Ah NiCd (SFB 180 batteries)*
3420706	SFH 181-A 3.0-Ah NiMH (SFB 185 batteries)* Kit also includes (1) 10 pc. insert bit pocket pack and (2) 1/4" TM masonry bits

*Kit includes tool, side handle, (2) batteries, C 7/24 battery charger and operating instructions in an impact-resistant plastic tool box

Technical Data

Capacity	SFB 180: 2.0-Ah at 18 V = 36 Wh SFB 185: 3.0-Ah at 18 V = 54 Wh
Blows per minute	SFH 181-A: 36,000 blows/min
Max torque	Flexible screw fastening in wood: 292 in-lb Rigid screw fastening in metal: 690 in-lb
Torque clutch	17 to 106 in-lb with 15 settings
Tool weight with battery	SF 181-A: 6.1 lb SFH 181-A: 6.6 lb



SF 4000-A 18V Cordless Drywall Screwdriver

- 4,000 rpm for consistent professional performance
- Cordless design is ideal for ceilings and exterior sheathing
- Tool weighs only 2.9 lbs with optional belt adapter

Use with
SMD 57
Magazine



Item No.	Description
340746	SF 4000-A 18 V Screwdriver 2.0-Ah NiCd (SFB 180 batteries)*
3417132	SF 4000-A 18 V Screwdriver 3.0-Ah NiMH (SFB 185 batteries)*

*Kit includes tool, (2) batteries, C 7/24 battery charger and operating instructions in an impact-resistant plastic tool box

Technical Data

Capacity	SFB 180: 2.0-Ah at 18 V = 36 Wh SFB 185: 3.0-Ah at 18 V = 54 Wh
No load speed	0-4000 rpm
Max torque	57.6 in-lb
Tool weight	5.11 lb with battery 2.9 lb with belt adapter



Hilti. Outperform. Outlast.

24 V NiCd / NiMH

TE 2-A
24 V Rotary Hammer Drill



- A cordless hammer drill for fast drilling in concrete, block and masonry
- Selector switch to change from hammer drilling to rotary only drilling
- Controlled hole starting with variable speed switch

Item No.	Description
3001614	TE 2-A 2.0-Ah NiCd Includes tool, (2) B 24/2.0 batteries (2.0-Ah NiCd), C 7/24 standard charger, fixed TE-C (SDS) chuck and operating instructions in an impact-resistant plastic tool box
3001618	TE 2-A 3.0-Ah NiMH Includes tool, (2) B 24/3.0 batteries (3.0-Ah NiMH), C 7/36-ACS "Smart" Charger, fixed TE-C (SDS) chuck and operating instructions in an impact-resistant plastic tool box

WSR 650-A
24 V Cordless Reciprocating Saw



- Orbital function for faster, more aggressive cutting into wood and other soft materials
- Anti-vibration system reduces vibration up to 20%
- Specially hardened carburized gearing for longer life

Item No.	Description
304464	WSR 650-A 2.0 Ah NiCd Includes tool, (2) 2.0-Ah nickel cadmium (NiCd) battery, C 7/24 standard charger, 6" x 6T wood saw blade, operating instructions and list of safety precautions, packed in an impact-resistant plastic tool box
304465	WSR 650-A 3.0 Ah NiMH Includes tool, (2) 3.0-Ah nickel metal hybrid (NiMH) battery, C 7/36-ACS "Smart" Charger, 6" x 6T wood saw blade, operating instructions and list of safety precautions, packed in an impact-resistant plastic tool box

WSC 6.5-A24
24 V Cordless Circular Saw



- Sturdy twin-arm Rip Fence helps the saw stay true to the line when ripping sheets of material
- Built-in viewing window for unobstructed view of cutting line
- Trigger interlock to minimize inadvertent start during transportation of tool

Item No.	Description
3430384	WSC 6.5-A 2.0-Ah NiCd (2 batteries) Includes saw, (2) B 24 batteries (2.0-Ah NiCd), C 7/24 standard charger, Hilti tool bag (large) and operating instructions in a cardboard box
3430385	WSC 6.5-A 2.0-Ah NiCd (1 battery) Includes saw, (1) B 24 battery (2.0-Ah NiCd), C 7/24 standard charger, Hilti tool bag (large) and operating instructions in a cardboard box
3430390	WSC 6.5-A 2.0-Ah NiCd (1 battery, no charger) Includes saw, (1) B 24 battery (2.0-Ah NiCd), Hilti tool bag (large) and operating instructions in a cardboard box
3430386	WSC 6.5-A 3.0-Ah NiMH (2 batteries) Includes saw, (2) B 24 batteries (3.0-Ah NiMH), C 7/36-ACS "Smart" Charger, Hilti tool bag (large) and operating instructions in a cardboard box
3430387	WSC 6.5-A 3.0-Ah NiMH (1 battery) Includes saw, (2) B 24 batteries (3.0-Ah NiMH), C 7/36-ACS "Smart" Charger, Hilti tool bag (large) and operating instructions in a cardboard box
3430389	WSC 6.5-A 3.0-Ah NiMH (1 battery, no charger) Includes saw, (1) B 24 battery (3.0-Ah NiMH), Hilti tool bag (large) and operating instructions in a cardboard box

TE 6-A
36 V Rotary Hammer Drill



- Selector switch to change from hammer drilling to rotary only drilling
- Electronic switch for variable speed regulation
- Removable TE-C (SDS) chuck allows quick change to keyed, keyless, or TE-AC angle chuck

Item No.	Description
3420489	TE 6-A Deluxe Includes tool, TE-C (SDS) chuck, side handle, dust shield, cleaning cloth, BP 6-86 battery, C 7/36-ACS "Smart" Charger, operating instructions and safety precautions in an impact-resistant plastic tool box

Technical Data

Speed under load	0-900 rpm
Battery capacity	2.0-Ah NiCd: 48 Wh 3.0-Ah NiMH: 72 Wh
Weight	8.3 lb with 2.0-Ah NiCd battery 8.4 lb with 3.0-Ah NiMH battery

Drilling Range

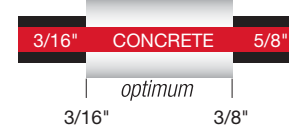

TE-C (SDS)

HILTI LIFETIME SERVICE™ NO COSTS	2 Years REPAIR COST LIMIT MANUFACTURERS WARRANTY
---	---

Technical Data

Voltage	24 V
Power input	650 W
Stroke rate	900 - 2200 / min
Stroke length	1-1/4"



HILTI LIFETIME SERVICE™ NO COSTS	1 Year REPAIR COST LIMIT MANUFACTURERS WARRANTY
---	--

Technical Data

Voltage	24 V
Blade Diameter	6-1/2"
Arbor	5/8"
Weight	11.6 lb

HILTI LIFETIME SERVICE™ NO COSTS	1 Year REPAIR COST LIMIT MANUFACTURERS WARRANTY
---	--

Technical Data

Speed under load	0-890 rpm
Battery capacity	B 36 (2.4 Ah NiCd): 86.9 Wh
Weight	10.4 lb with BP 6-86 battery

Drilling Range

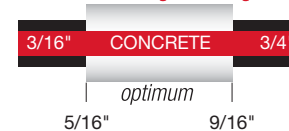

TE-C (SDS)

HILTI LIFETIME SERVICE™ NO COSTS	2 Years REPAIR COST LIMIT MANUFACTURERS WARRANTY
---	---

36 V NiCd / NiMH

Hilti. Outperform. Outlast.

TE 6-A Li 36 V Rotary Hammer Drill

- Drilling in concrete, stone and masonry with drill bits up to 3/4" diameter
- Lightweight and high performance for drilling overhead and above chest level
- Drilling in wood, plastic and steel



Technical Data

Speed under load	0-890 rpm
Battery capacity	B 36 (2.4 Li-Ion): 86 Wh
Weight	8.4 lb with B 36 battery

Drilling Range

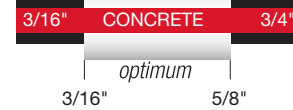

TE-C (SDS)

Item No.	Description
3420336	TE 6-A Li Deluxe Kit Includes tool, side handle, (2) B 36/2.4 batteries (2.4 Ah-Li), C 4/36-ACS TPS charger and operating instructions in an impact-resistant plastic tool box
3420337	TE 6-A Li Standard Kit Includes tool, side handle, (1) B 36/2.4 batteries (2.4 Ah-Li), C 4/36-ACS TPS charger and operating instructions in an impact-resistant plastic tool box

HILTI LIFETIME SERVICE™ REPAIR COST LIMIT	2 Years NO COSTS LIFETIME MANUFACTURERS WARRANTY
--	---

TE 7-A CPC 36 V Li Rotary Hammer Drill

- 3 modes of operation including: rotation only, rotation with hammer, and hammer only (chiseling function)
- Virtually dust free drilling with the optional self-contained dust removal system (DRS)
- Quick interchange of all common chuck types
- Works with Hilti 36 V Li-Ion



Technical Data

Speed under load	0-740 rpm
Battery capacity	B 36 (3.3-Ah Li-Ion): 118.8 Wh
Weight	10.8 lb with 3.3-Ah Li-Ion battery

Drilling Range

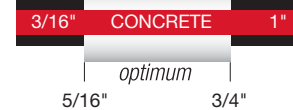

TE-C (SDS)

Item No.	Description
3424224	TE 7-A Performance Package Includes tool, side handle, (2) B 36/3.3 batteries (3.3 Ah-Li), C 4/36-ACS TPS charger, operating instructions in an impact-resistant plastic tool box plus one of each of the following: TE-C3X 1/4" x 6", TE-C3X 3/8" x 6", TE-C3X 1/2" x 6", TE-C3X 5/8" x 8", TE-CX 3/4" x 8" and TE-CP FM 18 flat chisel
3424886	TE 7-A Professional Kit Includes tool, side handle, TE DRS-M dust removal module, (2) B 36/3.3 batteries (3.3 Ah-Li), C 4/36-ACS TPS charger and operating instructions in an impact-resistant plastic tool box
3424225	TE 7-A Contractor Kit Includes tool, side handle, (2) B 36/3.3 batteries (3.3 Ah-Li), C 4/36-ACS TPS charger and operating instructions in an impact-resistant plastic tool box
267769	TE DRS-M Self-contained Dust Removal System in a cardboard box

HILTI LIFETIME SERVICE™ REPAIR COST LIMIT	2 Years NO COSTS LIFETIME MANUFACTURERS WARRANTY
--	---

WSC 7.25-A 36 V Li-Ion Cordless Circular Saw

- Highest capacity cordless circular saw on the market with a 36 V 3.3-Ah CPC Li-Ion battery
- 2-5/8" cutting depth at 90° which is the deepest depth of cut on the market
- Trigger interlock to minimize inadvertent start during transportation of tool



Technical Data

Voltage	36 V
Blade Diameter	7-1/4"
Arbor	5/8"
Weight	12.7 lb

HILTI LIFETIME SERVICE™ REPAIR COST LIMIT	2 Years NO COSTS LIFETIME MANUFACTURERS WARRANTY
--	---

Item No.	Description
3430388	WSC 7.25-A 3.3-Ah CPC Li-Ion (1 battery) Includes saw, (1) B 36 batteries (3.3-Ah CPC Li-Ion), C 4/36-ACS CPC Li-Ion battery charger, Hilti tool bag (large) and operating instructions in a cardboard box

Teflon Coated Circular Saw Blades for Cordless Saws

- Teflon coated to reduce friction and maximize cutting capacity
- Superior cutting performance and quality of cut due to finely-tuned tooth geometry and bevel angle
- Ultra thin blade technology reduces saw advance pressure and increases cutting speed
- High grade carbide designed for long life and durability

Item No.	Description	Dia.	Teeth/in.	Arbor	Qty.
237471	W-CSC 6 1/2-A5/8 z24	6-1/2"	24	5/8" with UDM	1
237472	W-CSC 6 1/2-A5/8 z42	6-1/2"	42	5/8" with UDM	1
237475	W-CSC 7 1/4-A5/8 z24	7-1/4"	24	5/8" with UDM	1
237476	W-CSC 7 1/4-A5/8 z42	7-1/4"	42	5/8" with UDM	1



Hilti. Outperform. Outlast.

Hilti Cordless Power Care (CPC) Lithium-Ion Batteries

- **Lighter Batteries** - half the weight of NiCd batteries of the same capacity.
- **Quick Charge** - up to 75% charged in 20 minutes, means early removal from charger has no harmful effect.
- **Ready to Go** - batteries maintain high state of charge for up to 6 months or longer with no use.
- **Individual Cell Management** - each cell is independently monitored to ensure optimum operational life.
- **State of Charge** - an LED State of Charge indicator on each battery, indicates the level of charge remaining.
- **Theft Protection System (TPS)** - an industry first! Available on all CPC batteries and chargers - activation is optional.



Batteries

For use with 12 V

Single Pack Item No.	Twin Pack Item No.	Description	
340888	3413001	SFB 121 Battery (2.0-Ah NiCd)	
340889	3413002	SFB 126 Battery (3.0-Ah NiMH)	①

For use with 14.4 V

273114		B 14 2.6 CPC Li-Ion Battery	②
--------	--	-----------------------------	---

For use with 15 V

340890	3413003	SFB 150 Battery (2.0-Ah NiCd)	
340891	3413004	SFB 155 Battery (3.0-Ah NiMH)	③

For use with 18 V

370100	3413005	SFB 180 Battery (2.0-Ah NiCd)	
370102	3413006	SFB 185 Battery (3.0-Ah NiMH)	④

For use with 24 V

378424	3413007	B 24 V Battery (2.0-Ah NiCd)	⑤
378426	3413008	B 24 V Battery (3.0-Ah NiMH)	

For use with 36 V

332031	3413027	BP 6-86 Battery	
--------	---------	-----------------	--

For use with 36 V Li

272471		B 36 2.4-Ah CPC Li-Ion Battery	⑥
274006		B 36 3.3-Ah CPC Li-Ion Battery	



Chargers

Item No.	Description	
378449	C 7/24 Standard Includes charger with manual refresh and can be used with all Hilti battery types from NiCd and NiMH 9.6 V to 24 V	⑧
378457	C 7/36-ACS "Smart" Charger For all current Hilti battery types from NiCd and NiMH 9.6 V to 36 V (Hilti batteries BP 6-86, BP 72, BP 60, BP 40, SBP 10 and SBP 12). With automatic conditioning charge mode for refreshing. Requires CA 7/36 adapter (item no. 377629) for use with BP 72 and BP 40 batteries	⑦
272939	C 4/36 Li-CPC Standard Charger Includes charger with manual refresh and can be used with all Hilti battery types from NiCd and NiMH 9.6 V to 24 V	
272445	C 4/36-ACS Li (TPS) Li-Ion charger for up to 36 V batteries equipped with Hilti Theft Protection System (activation is optional)	

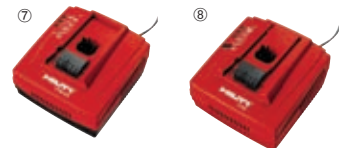

Flashlights

Item No.	Description
370494	SFL 12/15 Flashlight (12 V and 15 V batteries sold separately)
370495	SFL 18 Flashlight (18 V battery sold separately)
303920	SFL 24 Flashlight (24 V battery sold separately)



Hilti. Outperform. Outlast.

Choose your cordless package. Experience the added value.

Mixed Voltage Combos

Hilti mixed voltage combos provide greater capacity in various applications. Mixed voltage combos also offer the added value of an additional battery unlike most cordless combos on the market.

2 Tool CPC Cordless Combo 36 V Li-Ion Rotary Hammer and 14.4 V Li-Ion Impact



Item No.	Description
3429837	TE 7-A & SID 144-A CPC Kit

2 Tool Cordless Combo 36 V Li-Ion Rotary Hammer and 14.4 V Li-Ion Impact



Item No.	Description
3429839	TE 6-A Li & SID 144-A CPC Kit

2 Tool Cordless Combo 36 V Li-Ion Circular Saw and 14.4 V Li-Ion Impact Driver



Item No.	Description
3429841	WSC 7.25 & SID 144-A CPC Kit

2 Tool Cordless Combo 24 V Rotary Hammer Drill and 12 V Impact



Item No.	Description
3429819	TE 2-A & SID 121 2.0 Kit
3429820	TE 2-A & SID 121 3.0 Kit

4 Tool Cordless Combo 24 V Rotary Hammer, 24 V Reciprocating Saw 15.6 V Drill/Driver and Flashlight



Item No.	Description
3415575	TE 2-A, WSR 650-A, SF 151-A, SFL 12/15 2.0
3415576	TE 2-A, WSR 650-A, SF 151-A, SFL 12/15 3.0

3 Tool Cordless Combo 24 V Circular Saw, 24 V Flashlight and 15.6 V Hammer Drill/Driver



Item No.	Description
3429842	WSC 6.5 & SFH 151-A 2.0 Kit
3429844	WSC 6.5 & SFH 151-A 3.0 Kit

3 Tool Cordless Combo 24 V Reciprocating Saw, 24 V Flashlight and 15.6 V Hammer Drill/Driver



Item No.	Description
3429848	WSR 650-A, SFL 24 & SFH 151-A 2.0 Kit
3429846	WSR 650-A, SFL 24 & SFH 151-A 3.0 Kit

Single Voltage Combos

Hilti cordless combos offer convenience and performance. Our single voltage combos include tools that use the same voltage battery. This allows customers to use the right tool for the application with the simplicity of a single battery and charger.

2 Tool CPC Cordless Combo 14.4 V Li-Ion Drill/Driver and Impact



Item No.	Description
3429831	SF & SID 144-A CPC Li-Ion 14.4 V Kit

2 Tool Combo 12 V Drill/Driver and Impact



Item No.	Description
3429827	SF & SID 121-A 2.0 12 V Kit
3429828	SF & SID 121-A 3.0 12 V Kit

Hilti. Outperform. Outlast.

The Hilti Difference... Hilti screw fastening systems are designed for superior handling and comfort. By offering cordless and corded models, Hilti screw fastening tools can be used virtually anywhere. Whether you're performing light duty repairs or drilling into heavy wood or steel, Hilti offers

the tools, screws and smooth shank drill bits to get the job done right.

Hilti. Outperform. Outlast.



SD 4500 Drywall Screwdriver

- Operates at 4700 rpm for optimal framing and drywall screw installation
- Powerful 6.5 amp motor
- Innovative air outlet helps prevent dust from blowing into operator's face



Technical Data

Rated voltage	120 V
Rated power	740 W
Rated current	6.5 A
No-load speed	0-4500 rpm
Max torque	84 in-lb (9.5 Nm)
Dimensions (LxWxH)	11.4" x 2.9" x 6.3"
Weight	3.1 lb (1.4 kg)



Item No.	Description
285698	SD 4500 Drywall Screwdriver — 15 ft cord Includes tool, 3" magnetic bit holder, Phillips #2 bit, aluminum depth gauge, 15 ft cord and operating instructions in a cardboard box
285699	SD 4500 Drywall Screwdriver — 50 ft cord with twist lock Includes tool, 3" magnetic bit holder, Phillips #2 bit, aluminum depth gauge, 50 ft cord with twist lock plug and operating instructions in a cardboard box
285700	SD 4500 Drywall Screwdriver — 50 ft cord Includes tool, 3" magnetic bit holder, Phillips #2 bit, aluminum depth gauge, 50 ft cord and operating instructions in a cardboard box

SD 2500 Drywall Screwdriver

- High torque for heavy gauge framing, drywall and wood applications
- Superior handling due to balanced, lightweight design with comfortable grip
- Innovative air outlet helps prevent dust from blowing into operator's face



Technical Data

Rated voltage	120 V
Rated power	740 W
Rated current	6.5 A
No-load speed	0-2500 rpm
Max torque	168 in-lb (19 Nm)
Dimensions (LxWxH)	11.9" x 2.9" x 6.3"
Weight	3.3 lb (1.5 kg)



Item No.	Description
285703	SD 2500 Screwdriver — 15 ft cord Includes tool, 3" magnetic bit holder, Phillips #2 bit, aluminum depth gauge, 15 ft cord and operating instructions in a cardboard box



Hilti. Outperform. Outlast.

SMD 57

Drywall Screw Magazine

- Use with SD 2500, SD 4500 and SF 4000-A drywall screw drivers
- Ideal for interior drywall and exterior sheathing
- Significant savings potential through increased productivity



Item No.	Description
281297	SMD 57 Screw Magazine Includes magazine, S-MBL 166 BH2 Phillips bit, magazine strip guide and built-in adapter in a cardboard box

Collated Drywall Screws¹

Screws in magazine strips of 50

S-DS Sharp Drywall Screws With Fine Thread

For drywall sheets on metal profile up to 25 gauge

Item No. (Qty)	Description	Length
254805 (1000)	S-DS 6" x 1-1/8" PBH sharp collated	1-1/8"
254806 (1000)	S-DS 6" x 1-1/4" PBH sharp collated	1-1/4"
254807 (1000)	S-DS 6" x 1-5/8" PBH sharp collated	1-5/8"
331927 (1000)	S-DS 6" x 2" PBH sharp collated	2"

S-DC Sharp Course Thread Drywall Screws

For drywall sheets on wood

314640 (1000)	S-DC 6" x 1-1/8" PBH S. CRS collated	1-1/8"
254809 (1000)	S-DC 6" x 1-1/4" PBH S. CRS collated	1-1/4"
254810 (1000)	S-DC 6" x 1-5/8" PBH S. CRS collated	1-5/8"
331919 (1000)	S-DC 6" x 2" PBH S. CRS collated Kwik-Cote™	2"
331921 (1000)	S-DC 6" x 2" PBH S. CRS collated black	2"

S-DD Self-drilling Zinc-plated Drywall Screws

For drywall sheets on metal profile up to 20 gauge

314645 (1000)	S-DD 6" x 1-1/8" PBH SD zinc collated	1-1/8"
314646 (1000)	S-DD 6" x 1-1/4" PBH SD zinc collated	1-1/4"
314647 (1000)	S-DD 6" x 1-5/8" PBH SD zinc collated	1-5/8"
331931 (1000)	S-DD 6" x 2" PBH SD zinc collated	2"

¹ - Zinc-plated screws conform to ASTM 1941, as tested in accordance with ASTM B-117, which requires a minimum zinc coating thickness of 5 microns (0.0002 in.)

- All Hilti drywall self-drilling screws meet or exceed ASTM C-954 requirements



KWIK-PRO™ Sharp Point Framing Screws

All Hilti Drywall sharp point screws meet or exceed ASTM C 1002 requirements

Fastening stud to track from 20 ga through 25 ga

U.S. Item No. (Qty)	Canada Item No. (Qty)	Description
86206 (10000)	286541 (10000)	7" x 7/16" PPH S Framer
86207 (10000)	286542 (10000)	6" x 7/16" S CRS Framer



KWIK-PRO™ Framer

Fastening wire lath to 20 ga through 25 ga studs

10262 (10000)	286511 (10000)	8" x 1/2" PTH S Lathing Zinc
10263 (10000)	10263 (10000)	8" x 3/4" PTH S Lathing Zinc
10264 (8000)	10264 (8000)	8" x 1" PTH S Lathing Zinc
10265 (6000)	286514 (6000)	8" x 1-1/4" PTH S Lathing Zinc



KWIK-PRO™ Lathing

KWIK-PRO™ Self-Drill Framing Screws

All Hilti Drywall self-drilling screws meet or exceed ASTM C 954 requirements

Fastening stud to track from 14 ga through 20 ga

86225 (10000)	286559 (10000)	7" x 7/16" PPH SD Framer
86226 (10000)	286560 (10000)	7" x 7/16" PPH SD Framer Zinc
372756 (7500)	372756 (7500)	10" x 5/8" PPCH SD Framer
372761 (7500)	372761 (7500)	10" x 3/4" PPTH SD Framer



KWIK-PRO™ Self-Drill Framer

Fastening wire lath to 14 ga through 20 ga studs

86228 (10000)	286561 (10000)	8" x 1/2" PTH SD Lathing Zinc
87145 (10000)	87145 (10000)	8" x 3/4" PTH SD Lathing Zinc
86231 (8000)	286562 (8000)	8" x 1" PTH SD Lathing Zinc
86232 (6000)	286563 (6000)	8" x 1-1/4" PTH SD Lathing Zinc



KWIK-PRO™ Self-Drill Lathing

Hilti. Outperform. Outlast.

Kwik-Pro™ Sharp Point Drywall Screws

Hilti Drywall Screws meet ASTM C-1002 Standards.

Fine threaded screws (20 to 25 gauge)

U.S. Item No.	Canada Item No.	Description	Qty
84297	-	6" x 1" PBH S	10000
84329	286532	6" x 1-1/8" PBH S	10000
84291	286516	6" x 1-1/4" PBH S	8000
84323	286529	6" x 1-5/8" PBH S	5000
84310	286522	6" x 2" PBH S	3500
84311	286523	6" x 2-1/4" PBH S	3000
84319	286526	7" x 2-1/2" PBH S	2500
84328	286531	8" x 3" PBH S	2000

High/low laminating screws (20 to 25 gauge)

U.S. Item No.	Canada Item No.	Description	Qty
86198	286534	6" x 1-1/8" PBH S H/L	10000
86199	286535	6" x 1-1/4" PBH S H/L	8000
86200	286536	6" x 1-5/8" PBH S H/L	5000
86201	286537	6" x 2" PBH S H/L	3500
86204	-	8" x 3" PBH S H/L	2000

Type "G" laminating screw for temporary fastening of drywall to drywall

86205	286540	10" x 1-1/2" PBH S Laminating	5000
-------	--------	-------------------------------	------

Coarse thread drywall screws

U.S. Item No.	Canada Item No.	Description	Qty
84325	-	6" x 1" PBH S CRS THRD	10000
84316	286524	6" x 1-1/8" PBH S CRS THRD	10000
84294	286518	6" x 1-1/4" PBH S CRS THRD	8000
84307	286521	6" x 1-5/8" PBH S CRS THRD	5000
84320	286527	7" x 2" PBH S CRS THRD	3500
84295	-	7" x 2-1/4" PBH S CRS THRD	3000
84322	286528	7" x 2-1/2" PBH S CRS THRD	2500
84317	286525	8" x 3" PBH S CRS THRD	2000

Cement board screws (20 to 25 gauge)

372757	-	8" x 1-1/4" PWH S CMT BD	5000
3024068	-	8" x 1-5/8" PWH S CMT BD	4000
3024069	-	8" x 2-1/4" PWH S CMT BD	2500

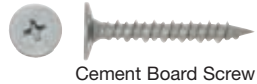

Kwik-Pro™ Self-Drill Drywall Screws

Hilti Self-Drill Drywall Screws meet ASTM C-954 Standards.

Fastening drywall, plywood, insulation, etc. to metal studs from 14 to 20 gauge metal studs

U.S. Item No.	Canada Item No.	Description	Qty
86211	286545	6" x 1" PBH SD	10000
86212	286546	6" x 1" PBH SD Zinc	10000
86213	286547	6" x 1-1/8" PBH SD	10000
86214	286548	6" x 1-1/8" PBH SD Zinc	10000
84290	286515	6" x 1-1/4" PBH SD	8000
86215	286549	6" x 1-1/4" PBH SD Zinc	8000
86216	286550	6" x 1-5/8" PBH SD	5000
86217	286551	6" x 1-5/8" PBH SD Zinc	5000
86218	286552	6" x 1-7/8" PBH SD	4000
86219	286553	6" x 1-7/8" PBH SD Zinc	4000
86220	-	8" x 2-3/8" PBH SD	2500
86221	286555	8" x 2-3/8" PBH SD Zinc	2500
84293	-	8" x 2-5/8" PBH SD	1600
86222	286556	8" x 2-5/8" PBH SD Zinc	1600
86223	286557	8" x 3" PBH SD	1400
86224	286558	8" x 3" PBH SD Zinc	1400

Cement board screws (14 to 20 gauge)

372759	-	8" x 1-1/4" PWH SD CMT BD	5000
--------	---	---------------------------	------



Tech Screws

Item No. (Qty)	Description
311445 (8500)	S-MD 10-16 x 1/2" HWH 2
311450 (7500)	S-MD 10-16 x 5/8" HWH 3
311451 (6500)	S-MD 10-16 x 3/4" HHWH 3 (hi-profile)
244212	S-MD 10-16 x 3/4" HWH 3 (lo-profile)
311458 (5000)	S-MD 12-14 x 3/4" HWH 3
10354 (5000)	10-24 x 1-1/2" PWH 3 Kwik Flex
87647 (2500)	12-14 x 1-1/2" HWH 3 Kwik Flex
8598 (1500)	14-14 x 2" HWH 3 Kwik Flex

Decking Screws

Plywood to metal framing

Item No. (Qty)	Description
311630 (4000)	S-WD 8-18 X 1-5/16" PFH #3 BLK PHSPHTD
311633 (5000)	S-WD 10-24 X 1-1/4" PWH #3
311635 (4000)	S-WW 10-24 X 1-7/16" PWH #3 Wings



The Hilti Difference... When you choose a Hilti fastener, you're getting more than just a fastener. We work hard to bring industry leading technology and innovation to the market place. With Hilti fastening systems, you receive the benefits of our labor. Technical information and

application support are readily available through our web site at www.us.hilti.com (U.S.), www.hilti.ca (Canada) and in our published *Product Technical Guide*.

Hilti. Outperform. Outlast.



GX 120 Gas-Actuated Fastening System



- First LED gas gauge helps you avoid running out of gas unexpectedly
- No battery to charge ever
- Reliable electronic gas injection system for consistent fastening
- Versatile, high performance fastening system over a wide range temperatures
- Slim, streamlined design for easy access even in tight corners and narrow tracks
- Drives 750 fasteners with a single gas can, magazine holds 40 fasteners for greater efficiency and higher productivity



Technical Data

Fastener range	1/2" to 1-5/8"
Power source	GC 22 (gas canister)
Magazine capacity	40 collated fasteners
Dimensions (LxWxH)	17" x 5.25" x 15.5"
Tool weight (with fasteners)	7.9 lbs



HILTI		2 Years
LIFETIME SERVICE™		NO COSTS
Lifetime	Lifetime	
REPAIR COST LIMIT	MANUFACTURERS WARRANTY	

Item No.	Description
274638	GX 120 Gas-Actuated System with 40 nail magazine Includes tool, detachable support leg, tool support, nail punch set, ear protectors, safety glasses, cleaning cloth and operating instructions in an impact-resistant plastic toolbox



Fasteners for GX 120

Item No.	Description	Typical Base Length (in.)	Material
226933	X-GN 20 MX	3/4"	Concrete/Block/Masonry
226934	X-GN 27 MX	1"	Concrete/Block/Masonry
226935	X-GN 32 MX	1-1/4"	Concrete/Block/Masonry
226936	X-GN 39 MX	1-5/8"	Concrete/Block/Masonry
226931	X-GHP 18 MX	11/16"	Hard Concrete/Steel
226932	X-GHP 20 MX	3/4"	Hard Concrete/Steel
226930	X-EGN 14 MX	1/2"	Steel

Package content: 750 fasteners (collated in strips of 10) and (1) gas can

Tool and Fastener Packages

Item No.	Description	GX 120	Fastener Qty					Qty
			For Concrete	For Steel	For Hard Concrete		Gas Canister	
3429271	GX 120 & 7.5K X-GN20 MX / 3K X-EGN 14MX	1 ea	7,500	3,000			14	
3429272	GX 120 & 10.5K X-GN20 MX	1 ea	10,500				14	
3429273	GX 120 & 10.5K X-GHP18 MX	1 ea			10,500		14	
3429274	GX 120 & 10.5K X-GHP20 MX	1 ea				10,500	14	
3429275	GX 120 & 10.5K X-EGN 14MX	1 ea		10,500			14	
3429267	GX 120 & 27K X-GN20 MX	1 ea	27,000				36	
3429268	GX 120 & 27K X-GHP18 MX	1 ea			27,000		36	
3429269	GX 120 & 27K X-GHP20 MX	1 ea				27,000	36	
3429270	GX 120 & 27K X-EGN14 MX	1 ea		27,000			36	
3429276	GX 120 & 27K X-GN20 MX (75%) / X-EGN14 MX (25%)	1 ea	20,250	6,750			36	
3429277	GX 120 & 27K X-GN20 MX (50%) / X-EGN14 MX (50%)	1 ea	13,500	13,500			36	
3429278	GX 120 & 27K X-GN20 MX (25%) / X-EGN14 MX (75%)	1 ea	6,750	20,250			36	

Hilti. Outperform. Outlast.

DX 351 MX Fully Automatic Powder-Actuated

- Automatic piston return and cartridge advance
- Can be used with the single baseplate or can be converted for use with X-MX-32 magazine (as shown)
- Pole tool available for overhead applications



Technical Data

Fastener range	Single: 1/2" to 1-7/8" Magazine: 1/2" to 1-1/4"
Power source	Hilti .27 caliber short in plastic strips of 10
Weight	5 lb

Item No.	Description
373103	DX 351-E Single Fastening Guide Tool ^① Includes tool, ECH hanger adapter, safety goggles, cleaning brushes, cleaning cloth, Hilti spray and operating instructions in an impact-resistant plastic tool box
374308	DX 351 with MX 32 Magazine Includes tool with magazine, safety goggles, cleaning brushes, cleaning cloth, Hilti spray and operating instructions in an impact-resistant plastic tool box
377826	DX 351 with MX 32 Magazine & Single Fastening Guide Tool Includes tool with magazine, single fastening guide, safety goggles, cleaning brushes, cleaning cloth, Hilti spray and operating instructions in an impact-resistant plastic tool box



DX 460-MX Fully Automatic Powder-Actuated

- Automatic cartridge advance and piston return
- Can be used with single fastener, narrow-access base plate or MX 72 magazine
- The ultimate solution for a variety of applications



Technical Data DX 460-MX and F8

Fastener range	1/2" to 2-7/8"
Power source	Hilti .27 caliber short
Weight	Single: 7.27 lb Magazine: 7.78 lb

Technical Data DX 460-IE

Fasteners	All X-IE
Power Sources	Hilti .27 caliber in plastic strips of 10
Weight	7.78 lb

Item No.	Description
370448	DX 460-MX Deluxe Kit Includes tool, MX 72 magazine, cleaning kit, ear protectors, safety goggles, Hilti spray lubricant and operating instructions in an impact-resistant plastic tool box
305179	DX 460-F8 Deluxe Kit ^② Includes tool, single baseplate, cleaning kit, ear protectors, safety goggles, Hilti spray lubricant and operating instructions in an impact-resistant plastic tool box
377791	DX 460-IE ^③ Includes tool, cleaning kit, ear protectors, safety goggles, Hilti spray lubricant and operating instructions in an impact-resistant plastic tool box
244222	DX 460 MX 72 and Single Fastening Guide Tool ^③ Includes tool, MX 72 magazine, single fastening guide, washer holder, safety goggles, cleaning brushes, cleaning cloth, Hilti spray lubricant and operating instructions in an impact-resistant plastic tool box



Hilti. Outperform. Outlast.

DX 35

Powder Actuated Fastening Tool

Semi-automatic drywall track fastening tool.

- 10 cartridges per strip in 3 power levels
- Specially designed for drywall and acoustical applications
- Pole tool available for overhead work



Technical Data

Fastener Range	1/2" to 1-1/2"
Power Source	Hilti .25 caliber short in plastic strips of 10
Tool Weight	4.25 lb

Item No.	Description
2506	DX 35 Tool in Deluxe Kit Box Includes spare parts package, rubber stabilizer, cleaning brushes, Hilti spray lubricant, safety goggles and operating instructions in a plastic tool box

DX E72

Powder Actuated Fastening Tool

Single-shot, general-purpose fastening tool.

- Automatic cartridge ejection
- Padded grip for operator comfort
- Tough, durable, high-density polymer construction



Technical Data

Fastener Range	1/2" to 2-7/8"
Power Source	Hilti .22 caliber long, single cartridge
Tool Weight	4.5 lb

Item No.	Description
1092	DX E72 Deluxe Includes spare parts package, ejection rod, rubber stabilizer, round brush, cleaning cloth, Hilti spray lubricant, safety goggles and operating instructions in a plastic tool box



Powder-Actuated Fastening Cartridge Selection

Using Hilti powder-actuated tools combined with Hilti cartridges and fasteners produce the #1 powder-actuated fastening system in the industry! The results—the highest quality fastenings combined with safety, reliability and low maintenance.

.22 Caliber Cartridge

For Use with:	Item No. (Qty)	Description	Power Level
DX E72	50395 (100)	5.6/16 Gray — Very Light	1 ○
	50396 (100)	5.6/16 Brown — Extra Light	2 ●
	50397 (100)	5.6/16 Green — Light	3 ●
	50398 (100)	5.6/16 Yellow — Medium	4 ●



.25 Caliber Cartridge — (strips of 10 each)

For Use with:	Item No. (Qty)	Description	Power Level
DX 35	50106 (100)	6.3/10 M Green — Light	3 ●
	50107 (100)	6.3/10 M Yellow — Medium	4 ●
	50108 (100)	6.3/10 M Red — Heavy	5 ●
	50115 (1000)	6.3/10 M Green — Light	3 ●
	50116 (1000)	6.3/10 M Yellow — Medium	4 ●
	50117 (1000)	6.3/10 M Red — Heavy	5 ●



.27 Caliber Cartridge — Short (strips of 10 each)

For Use with:	Item No. (Qty)	Description	Power Level
DX 351 Series	333318 (100)	6.8/11 M White — Extra Light	2* ○
DX 460 Series	50351 (100)	6.8/11 M Green — Light	3 ●
	50352 (100)	6.8/11 M Yellow — Medium	4 ●
*For DX 351 only	50353 (100)	6.8/11 M Red — Heavy	5 ●
	333317 (1000)	6.8/11 M White — Extra Light	2* ○
	50371 (1000)	6.8/11 M Green — Light	3 ●
	50372 (1000)	6.8/11 M Yellow — Medium	4 ●
	50373 (1000)	6.8/11 M Red — Heavy	5 ●



Hilti. Outperform. Outlast.

Nomenclature

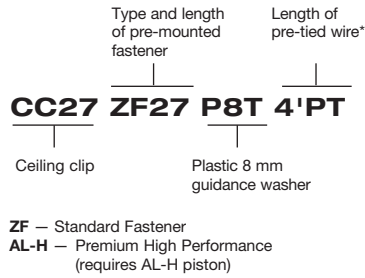

Ceiling Clips

For suspending ceiling grids and electrical services. Available with or without pre-tied wire.

Clip only (no pre-mounted fastener)

Description	Shank Diameter	Length	Non-Combo Item No. (Qty)	Fastener & Cartridge Combo (1000 each)		
				DXA Combo Item No.	DX 35 Item No.	DX E72 Item No.
CC-27	-	-	58750 (100)	-	-	-

Clip only pre-mounted with high performance fasteners

CC27XALH-22P8T	0.158"	7/8"	299814 (100)	299818	299817	299816
CC27XALH-27P8T	0.177"	1"	299845 (100)	299849	299848	299847

Clip only pre-mounted with standard fasteners

CC27 ZF 27 P8T	0.138"	1"	310322 (100)	299437	299346	299535
CC27 ZF 32 P8T	0.138"	1-1/4"	310325 (100)	299788	299787	299786

Ceiling clip with pre-mounted fasteners and pre-tied 12 GA wires*

CC27XALH-22P8T 4'PT	0.158"	7/8"	283343 (100)	283346	283345	283344
CC27XALH-27P8T 4'PT	0.177"	1"	283347 (100)	283350	283349	283348
CC27 ZF 27 P8T 4'PT	0.138"	1"	283351 (100)	283354	283353	283352
CC27 ZF 32 P8T 4'PT	0.138"	1-1/4"	283355 (100)	283358	283357	283356
CC27XALH-22P8T 6'PT	0.158"	7/8"	283359 (100)	283362	283361	283360
CC27XALH-27P8T 6'PT	0.177"	1"	283363 (100)	283366	283365	283364
CC27 ZF 27 P8T 6'PT	0.138"	1"	283367 (100)	283370	283369	283368
CC27 ZF 32 P8T 6'PT	0.138"	1-1/4"	283371 (100)	283374	283373	283372
CC27XALH-22P8T 8'PT	0.158"	7/8"	283375 (100)	283378	283377	283376
CC27XALH-27P8T 8'PT	0.177"	1"	283379 (100)	283382	283381	283380
CC27 ZF 27 P8T 8'PT	0.138"	1"	283383 (100)	283386	283385	283384
CC27 ZF 32 P8T 8'PT	0.138"	1-1/4"	283387 (100)	283390	283389	283388
CC27XALH-22P8T 10'PT	0.158"	7/8"	283391 (100)	283394	283393	283392
CC27XALH-27P8T 10'PT	0.177"	1"	283395 (100)	283398	283397	283396
CC27 ZF 27 P8T 10'PT	0.138"	1"	283399 (100)	283402	283401	2083400
CC27 ZF 32 P8T 10'PT	0.138"	1-1/4"	283403 (100)	283406	283405	283404
CC27XALH-22P8T 12'PT	0.158"	7/8"	283407 (100)	283410	283409	283408
CC27XALH-27P8T 12'PT	0.177"	1"	283411 (100)	283414	283413	283412
CC27 ZF 27 P8T 12'PT	0.138"	1"	283415 (100)	283418	283417	283416
CC27 ZF 32 P8T 12'PT	0.138"	1-1/4"	283419 (100)	283422	283421	283420



ALH Fasteners for hard concrete / steel applications



ZF Fasteners for standard applications

Additional wire lengths available through Custom Product Services!

Ceiling clip with pre-mounted fasteners and pre-tied 8 GA wires*

CC27 ZF 27 P8T 8GA 4'	0.138"	1"	283423 (100)
CC27 ZF 27 P8T 8GA 6'	0.138"	1"	283424 (100)
CC27 ZF 27 P8T 8GA 8'	0.138"	1"	283425 (100)
CC27 ZF 27 P8T 8GA 10'	0.138"	1"	283426 (100)
CC27 ZF 27 P8T 8GA 12'	0.138"	1"	283427 (100)

Ceiling clip with double wire*

CC27 ZF 27 P8T 4' Double Wire	283435 (100)
CC27 ZF 27 P8T 6' Double Wire	283436 (100)
CC27 ZF 27 P8T 8' Double Wire	283437 (100)

Ceiling clip with 12 GA wire - no fastener*

CC27 4' 12GA No Fastener	283452 (100)
CC27 6' 12GA No Fastener	283453 (100)
CC27 8' 12GA No Fastener	283454 (100)
CC27 10' 12GA No Fastener	283455 (100)
CC27 12' 12GA No Fastener	283456 (100)

* Length of wire prior to being tied.

Straight Wire

Description	(1000 pcs) Per Bundle
4-1/2' 12 GA Wire Straight	283442
6-1/2' 12 GA Wire Straight	283443
8-1/2' 12 GA Wire Straight	283444
10-1/2' 12 GA Wire Straight	283445
12-1/2' 12 GA Wire Straight	283446

Hilti. Outperform. Outlast.

Interior Construction Fasteners

X-U Premium Knurled, Ballistic Point Fasteners

For concrete and steel

Single fastener

Description	Shank	Length	Box (100 ea)**	Fastener & Cartridge Combo (10 x 100)		
				DX 35 Item No.	DX 351 Item No.	DX 460 Item No.
X-U 16 P8 (steel)	0.157"	5/8"	237330	3428998	3428998	3428998
X-U 19 P8 (steel)	0.157"	3/4"	237331	3428999	3428999	3428999
X-U 22 P8	0.157"	7/8"	237332	3429000	3429000	3429000
X-U 27 P8	0.157"	1"	237333	3429001	3429001	3429001
X-U 32 P8	0.157"	1-1/4"	237334	3429002	3429002	3429002
X-U 37 P8	0.157"	1-1/2"	237335	3429053	3429053	3429053

Single fastener with steel washer

X-U 27 P8 S15	0.157"	1"	237371	3429061	3429061	3429061
X-U 32 P8 S15	0.157"	1-1/4"	237372	3429062	3429062	3429062

Collated fastener (strips of 10)

X-U 16 MX (steel)	0.157"	5/8"	237344	-	3429066	3429066
X-U 19 MX (steel)	0.157"	3/4"	237345	-	3429067	3429067
X-U 22 MX	0.157"	7/8"	237346	-	3429068	3429068
X-U 27 MX	0.157"	1"	237347	-	3429069	3429069
X-U 32 MX	0.157"	1-1/4"	237348	-	3429070	3429070
X-U 37 MX	0.157"	1-1/2"	237349	-	-	3429071

Single fastener with metal "tophat"

X-U 16 P8 TH (steel)	0.157"	5/8"	237329	3431223	3431223	3431223
X-U 19 P8 TH (steel)	0.157"	3/4"	385781	3431224	3431224	3431224
X-U 27 P8 TH	0.157"	1"	385782	3431225	3431225	3431225



X-U Fastener



Fastener with premounted steel washer



Collated fasteners for use in tool magazine

Standard Drywall Track Fasteners

For steel

Single fastener with plastic "tophat"

Description	Shank	Length	Non-Combo Item No.	Fastener & Cartridge Combo (10 x 100)				Fastener & Cartridge Combo (1000 each)			
				DX E72 Item No.	DX 35 Item No.	DX 351 Item No.	DX 460 Item No.	DX E72 Item No.	DX 35 Item No.	DX 351 Item No.	DX 460 Item No.
X-ZF 14 THP	0.145"	9/16"	34558	3415662	3415688	3415661	3415661	299603	299605	299607	299607

Collated fastener (strips of 10)

X-ZF 14 MX	0.145"	9/16"	298777	-	-	-	-	-	-	299610	299610
------------	--------	-------	--------	---	---	---	---	---	---	--------	--------

Single fastener with metal "tophat"

ESD 16 P8 TH	0.145"	5/8"	-	-	40082	-	40081	-	40788	-
--------------	--------	------	---	---	-------	---	-------	---	-------	---



ESD Fastener

DAK Premium Drywall Track Fasteners

Trouble shooting fastener for difficult steel applications

Single fastener with plastic washer

Description	Shank	Length	Box (100 ea)**	Fastener & Cartridge Combo (1000 each)			
				DX 35 Item No.	DX 351 Item No.	DX 460 Item No.	DX E72 Item No.
X-DAK 16 P8	0.145"	5/8"	305525	-	-	-	-

Single fastener with metal "tophat" washer

X-DAK 16 P8 TH	0.145"	5/8"	305526	298507	298436	298436	298900
----------------	--------	------	--------	--------	--------	--------	--------

Collated fastener (strips of 10)

X-DAK 16 MX	0.145"	5/8"	305527	-	-	-	-
-------------	--------	------	--------	---	---	---	---

X-ZF Standard Pins

For concrete

Description	Shank	Length	Non-Combo Item No.	Fastener & Cartridge Combo (10 x 100)			Fastener & Cartridge Combo (1000 each)		
				DXA Item No.	DX 35 Item No.	DX E72 Item No.	DXA Item No.	DX 35 Item No.	DX E72 Item No.
X-ZF 20 THP	0.138"	3/4"	-	376448	-	-	299615	299613	299611
X-ZF 22 P8T	0.138"	7/8"	-	333528	-	-	299621	299620	299619
X-ZF 27 P8	0.138"	1"	-	376449	-	-	299624	299623	299622
X-ZF 27 P8 S23	0.138"	1"	-	-	-	-	299629	299628	299627
X-ZF 32 P8	0.138"	1-1/4"	-	333529	-	-	299632	299631	299630
X-ZF 37 P8	0.138"	1-1/2"	-	376450	-	-	299640	299639	299638
X-ZF 20 MX	0.138"	3/4"	-	-	-	-	299618	-	-
X-ZF 27 MX	0.138"	1"	-	-	-	-	299626	-	-
X-ZF 32 MX	0.138"	1-1/4"	-	376452	-	-	299634	-	-
X-ZF 37 MX	0.138"	1-1/2"	-	-	-	-	299641	-	-



ZF Fastener



Fastener with premounted 23 mm steel washer



Collated fasteners for use in tool magazine

X-DW Drywall Track Fasteners

For concrete and concrete block

X-DW 20 THP	0.118"	3/4"	-	3415657	3415686	3415658	337806	338857	338706
X-DW 22 THP	0.118"	7/8"	379164	-	-	-	-	-	-
X-DW 27 THP	0.118"	1"	-	3415659	3415687	3415660	337807	338858	338707
X-DW 39 THP	0.118"	1-5/8"	-	-	-	-	338461	-	-
X-DW 20 MX	0.118"	3/4"	-	-	-	-	337808	-	-
X-DW 27 MX	0.118"	1"	-	-	-	-	337809	-	-



DW Fastener



Collated fasteners for use in tool magazine

* Combos include 1000 pins and boosters packaged separately. Specify booster level (color) with your order.

** Boxes of 100 ea. Order boosters separately.

Hilti. Outperform. Outlast.

Interior Construction Fasteners

X-SW Soft Washers Only (no fastener)

For fastening insulation and membranes / plastic sheeting to concrete



X-SW

Description	Color	Diameter (mm)	Non-Combo Item No. (Qty)
X-SW 30	Gray	30	371370 (500)
X-SW 60	Gray	60	371371 (500)

X-SW Soft Washers with Pre-Mounted Fastener

Description	Color	Diameter (mm)	Length	Non-Combo Item No.	Fastener & Cartridge Combo (1000 each)				
					DX 35	DX E72	DX 351	DX 36M	DX 460
X-SW 30 ZF37	Gray	30	1-1/2"	40614 (500)	299386	-	299387	299387	299387
X-SW 30 XF37	White	30	1-1/2"	258043 (500)	299410	299409	299411	299411	299411
X-SW 30 ZF62	Gray	30	2-1/2"	40645 (100)	-	299393	-	299395	299395
X-SW 60 XF37	Gray	60	1-1/2"	3005408 (500)	299398	299397	299399	299399	299399
X-SW 60 ZF47	Gray	60	1-7/8"	40618 (100)	-	299401	299403	299403	299403
X-SW 60 ZF62	Gray	60	2-1/2"	40619 (100)	-	-	-	299407	299407

X-IE Fasteners

To fasten EPS/EIFS insulating materials to concrete



X-IE

Description	Fastener Length	Insulation Thickness	Box Item No. (Qty)	DX 460 Combo Item No.
X-IE 6-25 PH47	1-1/2"	1"	283990 (300)	3409834
X-IE 6-35 PH47	1-3/4"	1-1/2"	283992 (300)	3409835
X-IE 40 PH52	2"	1-5/8"	376466 (300)	299714
X-IE 45 PH52	2"	1-3/4"	376467 (300)	299715
X-IE 6-50 PH52	2"	2"	376468 (300)	299716
X-IE 6-60 PH52	2"	2-1/2"	376469 (300)	299717
X-IE 6-75 PH52	2"	3"	376471 (200)	299719
X-IE 6-80 PH52	2"	3-1/4"	367472 (200)	299720
X-IE 6-100 PH52	2"	4"	367474 (200)	299721
X-IE 6-120 PH72	2-7/8"	4-3/4"	367475 (150)	-

Accessories

Modular Pole Tools

Item No.	Description
333310	X-PT351 Modular Pole Tool Complete (7 ft length) Includes grip section assembly (1.9 ft), receptacle assembly (1.75 ft) and 3 ft pipe section
371661	X-PTA 460 Modular Pole Tool Complete (7 ft length) Includes grip section assembly (1.9 ft), receptacle assembly (1.75 ft) and 3 ft pipe section
309067	Pole X-PT 35 Pole Tool Complete Includes grip section assembly (1.9 ft), receptacle assembly (1.75 ft) and 3 ft pipe section

Pipe Sections for Adding Extra Length

254685	1 ft pipe section	①
254684	3 ft pipe section	②

Safety Glasses

373051	Safety Glasses — Mirrored (UVEX)	③
373050	Safety Glasses — Clear (UVEX)	④

Cleaning Kits

259271	DX Cleaning Kit Includes 3 brushes, spray lubricant and cleaning cloth	⑤
372810	DX 460 Cleaning Kit	
337260	DX 351 Cleaning Kit	
308976	Spray Lube	⑥



Receptacle Assembly



Grip Section Assembly



The Hilti difference... Hilti drilling systems are designed with optimum performance and operator comfort in mind. By incorporating the latest technologies, Hilti drills, combihammers and breakers set the standards others try to match.

Hilti compliments the technology in our tools by incorporating industry leading technology into our bits and chisels as

well. Hilti masonry bits feature double-helical fluting, solid carbide heads and larger flute gullets to allow increased drilling speeds and faster debris removal. The self-sharpening polygon design of Hilti chisels offers stronger breaking power and less sticking, and eliminates the need for resharpener which decreases costs and increases productivity.

Hilti. Outperform. Outlast.

TE 7-C Rotary Hammer Drills



- Drilling in concrete, stone and masonry with drill bits up to 1" diameter
- Light chiseling on concrete and masonry
- Drilling in dust sensitive areas with the dust removal module
- Drilling in wood or steel where high torque is required



Technical Data

Power input	720 W
Voltage	115 V
Hammering speed under load	0-4200 blows/min
Weight	7.0 lb

Drilling Range

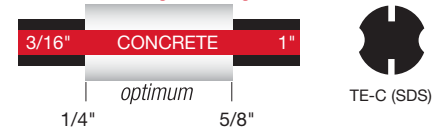

TE-C (SDS)

Item No.	Description
3425712	TE 7-C Performance Package Includes tool plus one each of the following drill bits: TE-C3X 3/16" x 6", TE-C3X 1/4" x 6", TE-C3X 5/16" x 6", TE-C3X 3/8" X 6", TE-C3X 1/2" x 6", TE-C3X 5/8" x 8" and TE-CP FM 18 narrow flat chisel
228043	TE 7-C Professional Package Includes tool, TE DRS-M, dust removal module, 13 ft. supply cord, side handle, dust shield and operating instructions in an impact-resistant plastic box
228061	TE 7-C Deluxe Includes tool, 13 ft. supply cord, side handle, dust shield and operating instructions in an impact-resistant plastic tool box
267769	TE DRS-M Self-contained Dust Removal System in a cardboard box

TE 6-S Rotary Hammer Drills

- Drilling with full hammering and rotation only
- TE 6-S: Reduced hammering action for drilling into brittle materials
- Dust removal system (DRS) available



Technical Data

Power input	650 W
Voltage	115 V (230 V available)
Hammering speed under load	0-5100 blows/min precision hammering 0-2700 blows/min (TS 6-S)
Weight	6.2 lb

Drilling Range

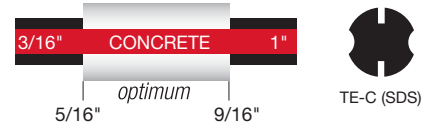

TE-C (SDS)

Item No.	Description
3425710	TE 6-S Performance Package Includes tool plus one each of the following drill bits: TE-C3X 3/16" x 6", TE-C3X 1/4" x 6", TE-C3X 5/16" x 6", TE-C3X 3/8" X 6", TE-C3X 1/2" x 6", TE-C3X 5/8" x 8"
370083	TE 6-S Professional Package Includes tool with DRS (Dust Removal System) in an impact-resistant plastic tool box
369025	TE 6-S Deluxe (Specialized) (115 V) Includes tool, 13 ft. supply cord, side handle, dust shield and operating instructions in an impact-resistant plastic tool box



Hilti. Outperform. Outlast.

TE 2 & TE 2-S

Rotary Hammer Drills

- Multi-purpose hammer drill for fast drilling in concrete, block and masonry
- TE 2-S: Reduced hammering feature for drilling at brittle materials like tile and stone



Technical Data

Power input	600 W
Voltage	115 V
Hammering speed under load	0-4600 blows/min
Weight	TE 2: 5.1 lb TE 2-S: 5.3 lb

Drilling Range



TE-C (SDS)



Item No.	Description
228085	TE 2 Deluxe (115 V) Includes tool, 13 ft. supply cord, Hilti grease, cleaning cloth and operating instructions in an impact-resistant plastic tool box
383249	TE 2 Standard (115 V) Includes tool, 13 ft supply cord, side handle, depth gauge, dust shield and operating instructions in a cardboard box
3431651	TE 2-S Performance Package Includes tool plus one each of the following drill bits: TE-C3X 3/16" x 6", TE-C3X 1/4" x 4", TE-C3X 1/4" x 6", TE-C3X 5/16" x 6", TE-C3X 3/8" x 6" and TE-C3X 1/2" x 6"
228098	TE 2-S Deluxe (115 V) Includes tool, 13 ft. supply cord, Hilti grease, cleaning cloth and operating instructions in an impact-resistant plastic tool box

TE-C3X Carbide Tipped Fractional Bits



Single Pack Item No.	6-Pack Item No.	24-Pack Item No.	72-Pack Item No.	Description (dia x length)	Working length
206662	226964	226970	3427073	TE-C3X 3/16" x 4"	2"
206663	226965	226971	3425857	TE-C3X 3/16" x 6"	4"
206664	226966			TE-C3X 3/16" x 8"	5-1/2"
206667	206680	226972	3425858	TE-C3X 1/4" x 4"	2"
206668	206681	226973	3425859	TE-C3X 1/4" x 6"	4"
206669	226967			TE-C3X 1/4" x 8"	5-1/2"
206671	226968			TE-C3X 5/16" x 6"	4"
206674	206682	226974		TE-C3X 3/8" x 6"	4"
206675				TE-C3X 3/8" x 12"	9-1/2"
206678				TE-C3X 7/16" x 6"	4"
206711	206710	226975		TE-C3X 1/2" x 6"	4"
206712				TE-C3X 1/2" x 12"	9-1/2"
206714				TE-C3X 9/16" x 6"	4"
206717	226969			TE-C3X 5/8" x 8"	5-1/2"
375844				TE-CX 11/16" x 12"	9-1/2"
375846				TE-CX 3/4" x 8"	5-1/2"
375847				TE-CX 3/4" x 12"	9-1/2"
375849				TE-CX 13/16" x 18"	15-1/4"
375852				TE-CX 7/8" x 10"	7-1/2"
375854				TE-CX 1" x 10"	7-1/2"

TE-C Standard Carbide Bits



Single Pack Item No.	24-Pack Item No.	Description (dia x length)	Working length
385069	385498	TE-C 5/32" x 6"	4"
385070	385499	TE-C 3/16" x 4"	2"
385071	385500	TE-C 3/16" x 6"	4"
385072	385501	TE-C 1/4" x 4"	2"
385073	385502	TE-C 1/4" x 6"	4"
385074		TE-C 5/16" x 6"	4"
385076	385503	TE-C 3/8" x 6"	4"
385078		TE-C 7/16" x 6"	4"
385079		TE-C 7/16" x 12"	9-1/2"
385080	385504	TE-C 1/2" x 6"	4"
385081		TE-C 1/2" x 12"	9-1/2"
385083		TE-C 9/16" x 6"	4"
385085		TE-C 5/8" x 8"	5-1/2"
284333		TC-C 3/4" x 8"	5-1/2"
283910		TC-C 7/8" x 10"	7-1/2"
283911		TC-C 1" x 10"	7-1/2"

TE-C3X Trade Sets

Item No.	Description
226946	TE-C3X Performance Pack Includes 1 each TE-C3X: 3/16" x 6", 1/4" x 6", 5/16" x 6", 3/8" x 6", 1/2" x 6", 5/8" x 6"
226960	TE-C3X Universal Pack Includes 2 each TE-C3X: 1/4" x 6", 3/8" x 6", 1/2" x 6"
226953	TE-C3X Small Diameter Pack Includes 1 each TE-C3X: 3/16" x 6", 1/4" x 4", 1/4" x 6", 5/16" x 6", 3/8" x 6", 1/2" x 6"

Extension Cords

Outdoor Heavy Duty Extension Cords

Heavy Duty: 3 conductor, UL listed, lighted ends, SJTW

Item No.	Description
375965	12/3 x 50'
375966	12/3 x 100'
375967	14/3 x 50'
375968	14/3 x 100'

Accessories

Item No.	Description
375972	Super Premium Ground Fault Interrupter (GFI) 12/3 x 3' GFI x Three-way (15 A) lighted end



Hilti. Outperform. Outlast.

SR 16 High-Torque 1/2" Drill

- High torque 2 speed motor
- Reversed lock out
- For drilling into steel and wood
- Great for mixing drywall mud



Technical Data

Power input	600 W
Voltage	115 V
Max torque	1st speed: 442 in.-lb 2nd speed: 177 in.-lb
Drilling range*	Steel: up to 1/2 in. dia. with Hilti HSS bits Driving screws: up to 1/4 in. x 4-3/4 in.
Weight	4.0 lb

*Base material hardness varies, temperature, moisture and operator pressure can effect drilling ranges



Item No.	Description
255948	SR 16 (Keyless Chuck) Includes tool, keyless chuck, side handle, 13 ft. (4 m) supply cord, operating instructions and safety precautions in a cardboard box
311165	SR 16 (Keyed Chuck) Includes tool, keyed chuck, side handle, 13 ft. (4 m) supply cord, operating instructions and safety precautions in a cardboard box

TM Carbide Tipped Smooth Shank Bits



Single Pack Item No.	36-Pack Item No.	Description	Working Length
61465	28859	Bit TM 3/16-4	2-1/8"
61466	28860	Bit TM 3/16-6	3"
61469	28861	Bit TM 1/4-4	2-1/8"
61470	28862	Bit TM 1/4-6	3"
61474		Bit TM 5/16-6	3"
61477	28864	Bit TM 3/8-6	3"
61483	28867	Bit TM 1/2-6	3"
61485		Bit TM 9/16-6	3"
62898	28870	Bit TM 5/8-8	5-1/2"

Accessories



Item No.	Description
24155	Stainless Steel Paddle Mixer (Smooth Shank) Specially designed for epoxy mortar. Use with Jacob's style chuck

Drill Bit Selector Guide

Selecting the proper drill bit for your application is critical for achieving maximum tool performance. Hilti provides a broad range of drill bit diameters for use with a wide variety of base materials. The selector guide below has been developed and organized to help you choose the correct Hilti Wood Systems drill bit.

For further assistance, please contact Hilti Customer Service at 1-800-879-8000 1-800-879-8000 in the US and 1-800-363-4458 in Canada.

Suggested Hilti Drill Bits By Material Type

Material	Drill Style	Angle Point	Operator Applied Pressure*	Coolant or Lubricant
Carbon Steel	Jobber	135°	M-H	oil or water solution
Ductile Brass		split point		
Carbon Steel	Titanium	135°	M-H	oil or activated solution
Aluminum		split point		
Stainless Steel	Cobalt	135°	M-H	oil or activated solution
Cast Iron		split point		
Hard Steel	Cobalt	135°	Heavy	oil or activated solution
Heat Treated Alloys		split point		
Wood	Spade	N/A	M-H	N/A
	Ship Auger	N/A	M-H	N/A
	Holesaw	N/A	M-H	N/A
	Stepper	N/A	M-H	N/A

*M-H: medium to heavy

Bit Style Reference

118°	Standard point for general purpose applications
135°	Split point for hard, tough materials; designed to self-center
Black Oxide	Provides additional tempering and stress relief to high speed twist drills
Cobalt	Use for drilling tough materials such as stainless steel, titanium, or heat treated steel with 135° split point for fast and accurate starting
Hole Saw	For cutting holes 9/16" to 6" Must be mounted to an arbor
Jobber Length	Used for drilling deep holes
Screw Machine Length	Also known as "stubby", main use is drilling in materials such as sheet metal
Ship Auger	Screw point bit used for heavy timber such as railroad ties or creosoted poles
Silver and Deming	Generic term for drills from 17/32" to 1-1/2" with 1/2" shank; 118° point with black oxide coating
Spade	"Wing Tip" style bit use for boring medium-sized holes in wood
Stepper	Incrementally flared bit used to widen existing holes with consistent precision
Titanium	Titanium nitride improves drill life by acting as wear-resistant, thermal barrier between high speed twist drill and material being drilled. These bits typically have 135° split point for fast and accurate starting

To order smooth shank bits go online or call toll-free



Hilti. Outperform. Outlast.



Kwik Bolt TZ / Kwik Bolt 3 Expansion Anchor

- Best approval ratings in class
- Suitable for concrete over metal deck applications
- Meet latest building code requirements
- KB-TZ especially suited for seismic and cracked concrete (tension zone) applications

Listings / Approvals

	KB-TZ	KB3
UL (Underwriters Laboratories)	3/8"-3/4"	3/8"-3/4"
FM (Factory Mutual)	3/8"-3/4"	3/8"-3/4"
ICC-ES (International Code Council)	ESR-1917	ESR-1385
COLA (City of Los Angeles)		RR 25577
Metro-Dade County		Pending
Qualified under an NQA-1 nuclear quality program		

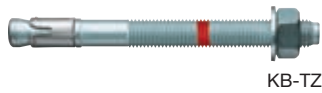

Anchor Size	KB-TZ Carbon Steel Item No. (Qty)	KB-TZ Carbon Steel MC Item No. (Qty)	KB 3 Carbon Steel Std Thread Item No. (Qty)	KB 3 Carbon Steel Std Thread MC Item No. (Qty)	KB 3 Carbon Steel Long Thread Item No. (Qty)	KB 3 Carbon Steel Long Thread MC Item No. (Qty)
1/4" x 1-3/4"	-	-	282502 (100)	3000340 (1200)	-	-
1/4" x 2-1/4"	-	-	282503 (100)	3000860 (1200)	-	-
1/4" x 3-1/4"	-	-	-	-	282504 (100)	3000695 (800)
3/8" x 2-1/4"	-	-	282505 (50)	3000861 (400)	-	-
3/8" x 3"	304581 (50)	3412458 (400)	282506 (50)	3000862 (400)	282522 (50)	3000885 (400)
3/8" x 3-3/4"	304582 (50)	3412459 (400)	282507 (50)	3000902 (400)	282523 (50)	3000903 (400)
3/8" x 5"	304583 (50)	3412460 (300)	282508 (50)	3000905 (300)	282524 (50)	3000906 (300)
1/2" x 3-3/4"	304584 (25)	3412531 (200)	282510 (25)	3000940 (200)	282526 (25)	3000959 (200)
1/2" x 4-1/2"	304585 (25)	3412532 (150)	282511 (25)	3000990 (150)	282527 (25)	3000992 (150)
1/2" x 5-1/2"	304586 (25)	3412533 (150)	282512 (25)	3000993 (150)	282528 (25)	3000994 (150)
1/2" x 7"	304587 (25)	3412534 (150)	-	-	282529 (25)	3000995 (150)
5/8" x 4-3/4"	304588 (15)	3412535 (90)	282514 (15)	3000997 (90)	282530 (15)	3000998 (90)
3/4" x 5-1/2"	202880 (10)	3412539 (80)	282518 (10)	3000844 (80)	282535 (10)	3001006 (80)
Anchor Size	HHDC Carbon Steel with 5/16" eyelet Item No. (Qty)	HHDC Carbon Steel with 5/16" eyelet MC Item No. (Qty)				
1/4" x 2"	371389 (100)	371390 (1000)				

KWIK-CON II+ Concrete & Masonry Fastening System

Listings / Approvals

ICC-ES (International Code Council)	ER 5259
Metro-Dade County Approval	01-0727.01

Screw anchor for light duty fastenings in block, masonry and concrete base materials

- Matched tolerance carbide-tipped drill bits for highest performance
- Zinc plated to minimum 8 microns
- Stainless steel fasteners available in select sizes



Anchor Size	Item No. (Qty)	Combo* Item No.	Master Carton Item No. (Qty)
1/4" x 1-1/4"	219906 (100)	256016	220593 (1000)
1/4" x 1-3/4"	219907 (100)	256017	220594 (1000)
1/4" x 2-1/4"	219908 (100)	256018	339507 (1000)
1/4" x 2-3/4"	219909 (100)	256019	220595 (1000)
1/4" x 3-1/4"	219910 (100)	256020	339508 (1000)
1/4" x 4"	219912 (100)	256022	339509 (1000)

* Combo includes 100 anchors and 1 bit.

KWIK-CON II+ Matched Tolerance Drill Bits

For 1/4" diameter KWIK-CON use large bits.

Item No.	Description	Bit Marking
3426038	TKC Large Concrete Bit SDS+ HEX	1/4" C
3426039	TKB Large Block Bit SDS+ HEX	1/4" B
3426042	TKC Large Concrete Bit TM+ HEX	1/4" C
205117	TKB Large Block Bit TM+ HEX	1/4" B



Hilti. Outperform. Outlast.

Metal HIT Drive Anchor

For easy through-type fastenings in concrete, concrete block, solid and hollow brick

- Quick and easy fastening for maximum speed and installation
- Low profile mushroom head style provides a nice finish and tamper proof fastening
- Anchor design allows easy through-type fastenings even in bottomless holes

Anchor Size	Item No. (Qty)	Master Carton Item No. (Qty)	Hole Diameter	Anchor Length	Min. Embed Depth	Max. Fixture Thickness at Min. Embed.
1/4" x 3/4"	15538 (100)	20680 (1000)	1/4"	3/4"	5/8"	1/8"
1/4" x 1"	66138 (100)	20681 (1000)	1/4"	1"	3/4"	1/4"
1/4" x 1-1/4"	66139 (100)	20682 (1000)	1/4"	1-1/4"	1"	1/4"
1/4" x 1-1/2"	66140 (100)	20683 (1000)	1/4"	1-1/2"	1"	1/2"
1/4" x 2"	45453 (100)	20684 (1000)	1/4"	2"	1"	1"



Metal HIT

Technical Data

Base material	Concrete Solid brick Hollow brick and concrete block
Anchor material	Body: Aluminum / zinc alloy Drive Pin: AISI 1018 carbon steel, zinc plated

IDP Insulation Anchor

- Specially structured head to help ensure bonding of plaster applied directly over the anchor
- Suitable for insulation thickness up to 4-3/4" for enhanced versatility
- Installation in concrete and masonry allow versatile use
- No metal parts which reduces potential condensation behind finish coat of EIF systems

Item No. (250/Box)	Description	Hole Dia.	Anchor Length	Minimum Embedment	Insulation Thickness
332105	IDP 0/2	5/16"	2"	1-1/8"	to 7/8"
332106	IDP 2/4	5/16"	2-3/4"	1-1/8"	7/8 to 1-3/4"
332107	IDP 4/6	5/16"	3-1/2"	1-1/8"	1-3/4" to 2-3/8"
332108	IDP 6/8	5/16"	4-1/4"	1-1/8"	2-3/8 to 3-1/8"
332109	IDP 8/10	5/16"	5"	1-1/8"	3-1/8 to 4"
332110	IDP 10/12	5/16"	6"	1-1/8"	4 to 4-3/4"



IDP

Technical Data

Base material	Concrete Lightweight concrete Solid brick
Anchor material	Polypropylene (not UV resistant)

HSP / HFP

For light duty fastenings in gypsum board (drywall)

- "Shark's tooth" design for correct positioning and quick installation
- Cuts its own thread
- One Hilti bit for anchor and screw. No setting tool required.

Description	Item No. (Qty)	Master Carton Item No. (Qty)	Anchor Length	Screw Diameter
HSP (zinc)	332682 (100)	333979 (1600)	1-1/2"	# 8
HSP-S (zinc w/ screws)*	332683 (100)	333980 (1600)	1-1/2"	# 8
HFP (nylon)	332686 (100)	333982 (1600)	1-1/8"	# 8
HFP-S (nylon w/ screws)*	332687 (100)	333983 (1600)	1-1/8"	# 8
D-B PH2 HSP/HFP Phillips Head Bit	332688 (5)	-	-	-

*Delivered with 100 screws, # 8 x 1-3/16"

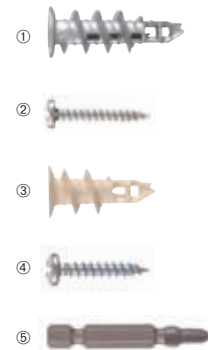

See Hilti Product Technical Guide for performance data on all Hilti anchors.

Hilti. Outperform. Outlast.



3/16" and 1/4"



3/8" and 1/2"

TOGLER® Bolt

For light and medium duty fastenings in a wide range of hollow-wall materials

- Unique installation “legs” and locking cap facilitate fastenings in wide range of drywall and hollow wall materials up to 2-1/4" thick
- One piece zinc plated carbon steel channel provides greater holding power

Anchor Size	Hole and Bit Size	Phillips Flat Head		Slotted Round Head		Without Screw	
		Box (Qty)	Master Carton (Qty)	Box (Qty)	Master Carton (Qty)	Box (Qty)	Master Carton (Qty)
3/16"	1/2"	374497 (100)	374498 (500)	374493 (100)	374489 (500)	374495 (100)	374491 (500)
1/4"	1/2"	374499 (100)	374500 (500)	374494 (100)	374490 (500)	374496 (100)	374492 (500)
3/8"	3/4"	-	-	66365 (25)	20673 (250)	66370 (25)	20677 (250)
1/2"	3/4"	-	-	66366 (25)	20674 (250)	66371 (25)	20678 (250)



KwikTog

KwikTog

For light duty fastenings especially in thin-walled and hollow base materials

- Unique one-piece design for easy setting
- Three convenient sizes for use in a variety of hollow base materials from 1/4" drywall to block and concrete
- Leg braces provide added support
- Ribs on body help prevent anchor from spinning during installation

Description	Box (Qty)	Master Carton (Qty)	Hole Dia.	Recommended Screw Size		Hollow Base Material Thickness
				Hollow Base Mat	Solid Base Mat	
Kwik Tog 2 (HLD2)	335506 (150)	3001809 (1800)	3/8"	#8 or #10	#10	3/16" to 5/8"
Kwik Tog 3 (HLD3)	335507 (100)	3001810 (1200)	3/8"	#8 or #10	#10	5/8" to 7/8"
Kwik Tog 4 (HLD4)	335508 (100)	3001811 (1200)	3/8"	#8 or #10	#10	15/16" to 1-1/4"

HAS Rods

Threaded Anchors for Hilti Chemical Anchor Systems*



HAS-E Rod

Description	HAS-E Rods Zinc Plated Carbon Steel		HAS Super Rods High Strength	HAS-R 304 Stainless Steel	HAS-R 316 Stainless Steel
	Item No. (Qty)	Master Carton Item No. (Qty)	Item No. (Qty)	Item No. (Qty)	Item No. (Qty)
3/8" x 3"	385417 (10)	3432178 (360)	-	-	-
3/8" x 4-3/8"	385418 (10)	3432179 (240)	-	-	-
3/8" x 5-1/8"	385419 (20)	3432180 (240)	68657 (10)	385462 (20)	3024335 (10)
3/8" x 8"	385420 (10)	3432181 (160)	-	385463 (10)	-
1/2" x 4-1/2"	385423 (10)	3432184 (160)	-	-	-
1/2" x 6-1/2"	385424 (20)	3432185 (160)	68658 (10)	385464 (20)	3024336 (10)
1/2" x 8"	385425 (10)	3432239 (120)	-	385465 (10)	-
5/8" x 7-5/8"	-	-	333783 (10)	385467 (20)	333781 (10)
5/8" x 8"	385428 (20)	3432188 (80)	-	-	-

Multi-Wythe BrickWalls



HAS-E Rod



Screen Tube

Item No. (Qty)	HAS-E Rod Description	Item No. (Qty)	Screen Tube Description	Hole Depth	Hole Dia.	Approx. Number Fastenings/Foil Pack		
						11.1 oz (330 ml)	16.9 oz (500 ml)	47.3 oz (1400 ml)
385420 (10)	HAS-E 3/8" x 8"	20953 (10)	3/8" x 6"	6-1/4"	1/2"	15	24	70
385425 (10)	HAS-E 1/2" x 8"	20955 (10)	1/2" x 6"	6-1/4"	11/16"	7	11	33
385428 (20)	HAS-E 5/8" x 8"	63930 (10)	5/8" x 6"	6-1/4"	27/32"	4	6	19
385432 (10)	HAS-E 3/4" x 10"	20836 (10)	3/4" x 8"	8-1/4"	1"	3	5	14

*Additional rod and screen sizes available

Hilti. Outperform. Outlast.

HFX Hybrid Adhesive



- Formulated for fast curing and easy installation in a wide range of base materials
- Injects directly into solid base materials and uses Hilti screen tubes for hollow base materials
- Single, self-opening cartridge fits any standard hard cartridge dispenser

Item No. (Qty)	Description
284266 (1)	HFX Hybrid Adhesive (9.3 fl oz / 275 ml) Includes (1) tube of HFX and 2 mixers per package
3421422 (12)	HFX Hybrid Adhesive (9.3 fl oz / 275 ml) MC
3422745 (1)	HFX Hybrid Adhesive Kit Includes (1) master carton and (1) MD 300 dispenser

Technical Data

Product	Hybrid Urethane Methacrylate
Base Material Temperature	40°F to 105°F (5°C to 40°C)
Package Volume	Volume of 9.3 fl oz / 275 ml hard cartridge is 16.8 in ³

Gel/Full Cure Time Table (Approximate)

Base Material Temperature		t _{gel}	t _{cure}
°F	°C		
70	20	5 min	40 min

HIT-HY 150 MAX Fast Cure Hybrid Adhesive



- Average 20% higher published load capacities than HIT HY 150
- May be used for oversized holes up to 1/4" larger than rod size
- HY 150 MAX with HIT-TZ Rods may be used in uncleaned, wet and diamond-cored holes

Item No. (Qty)	Description
283548 (1)	HIT-HY 150 MAX (11.1 fl oz / 330 ml)*
3412766 (25)	HIT-HY 150 MAX (11.1 fl oz / 330 ml) MC*
3427072 (1)	HIT-HY 150 MAX (11.1 fl oz / 330 ml) Kit Includes (1) master carton and choice of (1) MD 2000 or MD 2500 dispenser
283549 (20)	HIT-HY 150 MAX (16.9 fl oz / 500 ml) MC*
3421198 (1)	HIT-HY 150 MAX (16.9 fl oz / 500 ml) Kit Includes (1) master carton and (1) MD 2500 dispenser

*Includes (1) mixer and 3/8" filler tube per package

Listings / Approvals*

ICC-ES (International Code Council)	ESR-1967
COLA (City of Los Angeles)	(pending)
NSF/ ANSI Standard 61	Certification for potable water

* As of print date (5/06)

Gel/Full Cure Time Table (Approximate)

Base Material Temperature		t _{gel}	t _{cure}
°F	°C		
68	20	6 min	30 min

HIT-HY 20 Fast Cure Hybrid Adhesive



- Allows for dependable fastening and a quick cure over a wide range of temperatures in hollow base material
- Performs reliably where the quality of brick and mortar is inconsistent, even when the size and location of voids are unknown
- Suited for use in multi-wythe anchoring applications in renovation and seismic upgrades of unreinforced masonry buildings

Item No. (Qty)	Description
371959 (1)	HIT-HY 20 (11.1 fl oz / 330 ml)*
332229 (25)	HIT-HY 20 (11.1 fl oz / 330 ml) MC*
3427224 (1)	HIT-HY 20 (11.1 fl oz / 330 ml) Kit Includes (1) master carton and choice of (1) MD 2000 or MD 2500 dispenser
285595 (20)	HIT-HY 20 (16.9 fl oz / 500 ml) MC*
3408932 (1)	HIT-HY 20 (16.9 fl oz / 500 ml) Kit Includes (2) master cartons and (1) MD 2500 dispenser

*Includes (1) mixer with extension per package

Listings/Approvals

ICC-ES (International Code Council)	ER-4815 for URM
COLA (City of Los Angeles)	RR-24564 for URM

Gel/Full Cure Time Table (Approximate)

Base Material Temperature		t _{gel}	t _{cure}
°F	°C		
68	20	6 min	60 min

Dispensers and Accessories

Item No.	Description
284260	MD 300 Manual Dispenser For use with Hilti HFX and other single-tube products
229154	MD 2000 Manual Dispenser with Foil Pack Holder For use with HIT 11.1 oz / 330 ml foil packs
338853	MD 2500 Manual Dispenser with Foil Pack Holder ① For use with HIT 11.1 oz / 330 ml and 16.9 oz / 500 ml foil packs
3425363	ED 3500 2.0-Ah Kit ② Includes dispenser, 2.0-Ah NiCd battery, C 7/24 standard charger and accessories in an impact-resistant plastic tool box
340888	SFB 121 2.0-Ah NiCd Battery Pack
378449	C 7/24 Standard Charger (115 V)
229170	Replacement Cartridge (Foil Pack) Holder for MD 2000
339477	Replacement Cartridge (Foil Pack) Holder for MD 2500 and ED 3500



See Hilti Product Technical Guide for performance data on all Hilti anchors.

Hilti. Outperform. Outlast.

WSC 167 and WSC 267-E Circular Saws

- Magnesium construction is light weight, yet stands up to tough jobsite conditions
- Large viewing window for clear visibility of the cut line
- WSC 267: 6 speed settings let you fit the cutting speed to the job
- WSC 267: Optional guide rail ensures perfect straight and bevel cuts



WSC 167



WSC 267-E

Technical Data

	WSC 167	WSC 267-E
Item No.	3408976	304421
Smart Power	No	Yes
Nominal current input	15 A	13.5 A
Spindle speed under no load	5800 rpm	4300 rpm max
Max. cutting depth at 0°	2-9/32 in.	2-5/8 in.
Max. cutting depth at 45°	1-5/8 in.	2 in.
Angular adjustment	0° to 50°	0° to 45°
Blade diameter	7-1/4 in.	7-1/4 in.
Arbor	5/8 in.	5/8 in.
Weight	10.3 lb	10 lb

Circular Saw Blades

With anti-kick shoulder for fast cutting, also good choice for cordless saws

Item No. (Qty)	Item No. (Qty)	Description	Arbor
3412779 (2)	3412778 (25)	SB-CA 7-1/4" x 24T (.071" Kerf)	5/8" w/ Universal DM*
372178 (2)	372179 (25)	SB-CS 7-1/4" x 20T (.084" Kerf)	5/8" w/ Universal DM*
372181 (2)	372182 (25)	SB-CS 7-1/4" x 24T (.084" Kerf)	5/8" w/ Universal DM*
372184 (2)	372185 (25)	SB-CS 7-1/4" x 40T (.084" Kerf)	5/8" w/ Universal DM*
87802 (25)		Abrasive Wheel AB-AG 7" x 3/32" x DM	

*Universal DM — 13/16 diamond knockout



Abrasive Blades

Super Premium Track Saw Blades

Type 1 for cutting drywall track-channel

Item No. (Qty)	Description
25839 (10)	Abrasive Blade AB-A6P-12" x 3/32" x 1"
25916 (10)	Abrasive Blade AB-A6P-14" x 3/32" x 1"
25917 (10)	Abrasive Blade AB-A6P-16" x 3/32" x 1"

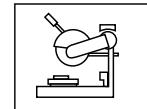

Premium Track Saw Blades

Type 1 for cutting ductile metal

Item No. (Qty)	Description
87810 (10)	Abrasive Blade AB-A49-12" x 3/32" x 1"
87811 (10)	Abrasive Blade AB-A4P-14" x 3/32" x 1"
25844	12" x 1/8" x 20 mm
25846	12" x 1/8" x 1"
25847	14" x 1/8" x 20 mm
25849	14" x 1/8" x 1"



Ductile Diamond Blades

Super Premium Blades

For cast iron pipe/sheet metal/drywall track

Item No.	Description
227853	12" x 1/8" x 1" / 20 mm
227854	14" x 1/8" x 1" / 20 mm



Hilti. Outperform. Outlast.

WSR 900, WSR 900-PE, WSR 1250-PE and WSR 1400-PE Reciprocating Saws

The Hilti Difference... When power, performance and operator comfort top your list of tool requirements, Hilti delivers. Hilti reciprocating saws feature some of the most advanced technology in the industry to make easy work of the toughest jobs.



Technical Data	WSR 900	WSR 900-PE	WSR 1250-PE	WSR 1400-PE
Item No.	376748	378275	285772	304545
Orbital Action		•	•	•
Anti-Vibration		•	•	•
Smart Power™	•	•	•	•
Power	8.5 A	8.5 A	12 A	13.5 A
Watts	900 W	900 W	1250 W	1400 W
Stroke Length	1-1/4 in.	1-1/4 in.	1-1/4 in.	1-1/4 in.
Weight	6.3 lb	7.2 lb	9.3 lb	9.9 lb

Reciprocating Saw Blades

Item No. (Qty)	Item No. (Qty)	Description	Teeth per Length	Blade inch (TPI)	Thickness
205989 (5)	253236 (50)	Wood Cutting R-NB 6" x 6T	6"	6	.050"
205990 (5)	253237 (50)	Wood Cutting R-NB 9" x 6T	9"	6	.050" ①
205993 (5)	253239 (50)	Metal Cutting R-MB 4" x 18T	4"	18	.035"
205995 (5)	253240 (50)	Metal Cutting R-MB 6" x 10T	6"	10	.035"
205996 (5)	253241 (50)	Metal Cutting R-MB 6" x 14T	6"	14	.035" ②
205997 (5)	253242 (50)	Metal Cutting R-MB 6" x 18T	6"	18	.035"
205998 (5)	253243 (50)	Metal Cutting R-MB 6" x 24T	6"	24	.035"
374342 (5)	3006054 (50)	BiM/Drywall & Plaster R-PB 6" x 6T	6"	6	.035"



WSJ 850-EB, WSJ 750-ET and WSJ 850-ET Jig Saws

- Smart Power™ system maintains constant blade speed under load
- OptiCut action with longer blade stroke (1-1/8") and four orbital action settings for the most aggressive cutting performance
- Precision Guide clamping system secures blade
- Unique counter-balance system reduces vibration by up to 60%



Technical Data	WSJ 750-ET/WSJ 850-ET	WSJ 850-EB
Item No.	303982	303983
Power	7.8 A	8.4 A
Stroke Length	1-1/8 in.	1-1/8 in.
Weight	5.5 lb	5.5 lb



Jig Saw Blades

Item No. (Qty)	Description	Length	Teeth per inch (TPI)	Material
378121 (5)	W-CSJ W 75/4 CurveCut	4"	6	HCS
378117 (5)	W-CSJ W 77/2.5 QualiCut	4"	10	HCS
377929 (5)	W-CSJ W 91/P QuickCut	4-1/2"	Progressive	HCS
378127 (5)	W-CSJ M 74/P MetalCut	4"	Progressive	HSS
378131 (5)	W-CSJ U 90/2.5 UniversalCut	4-1/2"	10	BiM
378129 (5)	W-CSJ U 106/P UniversalCut	5-1/4"	Progressive	BiM

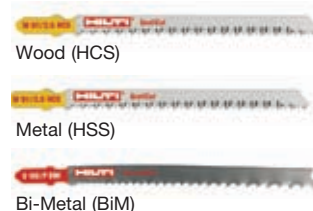

Accessories

Item No.	Description
375984	WSJ-DRS Dust removal system for WSJ 850-ET and WSJ 850-EB jig saws

Hilti. Outperform. Outlast.

Complete solutions for overall savings.

From project start to finish, you can count on Hilti for overhead, wall and floor support solutions for a wide range of applications. With innovative channel/strut and connectors, you can increase your productivity while maintaining optimum project flexibility.

Strut (12 & 14 Gauge)

- C-profile with serrated edges for greater hold and adjustability with MQN pushbuttons and MQA saddle nuts
- Stamped markings every 2" to assist with measurement, cutting, and installation
- Longitudinal swaging for greater strength

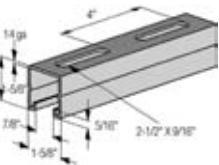
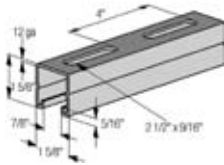

1-5/8" 12 gauge

Item No. (Qty)	VIP Item No. (Qty)	Description	Hole Configuration	Weight/Piece (lb)
3424503 (1)	3424504 (50)	158-12/PG 2 ft Kwik Cut	2-1/2" x 9/16"	3.6
3424505 (1)	3424506 (50)	158-12/PG 4 ft Kwik Cut	2-1/2" x 9/16"	7.2
3424507 (1)	3424508 (50)	158-12/PG 6 ft Kwik Cut	2-1/2" x 9/16"	10.8
3424511 (1)	3424512 (50)	158-12/PG 10 ft	2-1/2" x 9/16"	18.0
3424513 (1)	3424514 (50)	158-12/PG 20 ft	2-1/2" x 9/16"	36.0
3424499 (1)	3424500 (50)	158-12/PGS 10 ft	Solid	18.5
3424501 (1)	3424502 (50)	158-12/PGS 20 ft	Solid	37.0
3424523 (1)	3424524 (50)	158-12/GR E-Coat 10 ft	2-1/2" x 9/16"	18.0
3424525 (1)	3424526 (50)	158-12/GR E-Coat 20 ft	2-1/2" x 9/16"	36.0

1-5/8" 14 gauge

Item No. (Qty)	VIP Item No. (Qty)	Description	Hole Configuration	Weight/Piece (lb)
3424531 (1)	3424532 (50)	158-14/PG 10 ft	2-1/2" x 9/16"	13.6
3424533 (1)	3424534 (50)	158-14/PG 20 ft	2-1/2" x 9/16"	27.2

MQN Pushbutton

- Fast: one-part fastener replaces a spring nut, bolt and washer
- Universal—one MQN Pushbutton fits all Hilti strut types
- Removable and reusable



Item No. (Qty)	Description	Weight/Piece (lb)
369623 (50)	MQN	0.145

MQA-F Saddle Nut

- A single part replacing spring nuts and base plates
- For all types of channel



Item No. (Qty)	Description	Connection Thread	Weight/Piece (lb)
377885 (50)	MQA-F 3/8" Saddle Nut	3/8"	0.192

MQZ Base Plates

- For wall, ceiling or floor attachment of angles, connectors or brackets with KWIK-Bolt or HDI anchors
- For strut nut or spring nut applications with angles, connectors and brackets
- Used as heavy plate washer for strut

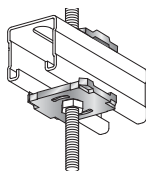

Item No. (Qty)	Description	For Thread	Weight/Piece (lb)
370632 (20)	MQZ-L 3/8" Base Plate	3/8"	0.203

Connectors, Splices and Bases

Item No. (Qty)	Description	Weight/Piece (lb)	
369643 (10)	MQV-12 Connector	1.224	①
369645 (10)	MQV-T Four Hole Tee Splice	0.432	②
370631 (10)	MQV-P5 Five Hole Cross Splice	0.309	③
369639 (10)	MQV-2/2D-14 Wall and Ceiling Base	0.966	④
369651 (12)	MQP-21-72 Standard Duty Base	2.535	⑤

For complete installation systems offering, call or go online.

Hilti. Outperform. Outlast.

Complete knee wall kits available!
Call for details!

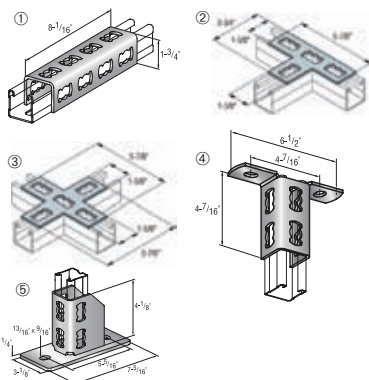

CF 810

Crack and Joint Pro Insulating Filler Foam



- Restricts air infiltration and creates water resistant seal
- High quality valve prevents pressure loss, prolongs shelf life and prevents waste
- Use as fireblock for Type V non fire-rated wood frame construction (refer to ESR 2179) (Not for use in fire-rated assemblies)
- Identifiable orange color



Item No.	Description
3413888	CF 810 Pro Foam 23 oz. can (case of 12)
3414915	CF 810 Pro Foam 23 oz. can (32 cases)

Technical Data

Foam yield per can	Approx 1.55 ft ³
Approximate Cure Schedule (ASTM C 1620)	Tack free after approx 8-10 minutes Ready to cut after approx 10-15 minutes
Application temperature	41°F to 95°F (5°C to 35°C)
Air infiltration (ASTM E 283)	0.01 cfm/ft ² @ 1.56 psf (75Pa)
Surface burning characteristics (UL 723)	Flame Spread: 0 Smoke Developed: 5
Shelf life from date of manufacture (when stored at 68°F)	12 months

CF 812

Window and Door Pro Low Pressure Filler Foam



- Tested as a low pressure insulating material for window and door frames (AAMA 812)
- Flexible foam allows for movement
- Faster application than traditional sealing methods such as caulking and batt-insulation
- High quality valve prevents pressure loss, prolongs shelf life and prevents waste



Item No.	Description
3413889	CF 812 Pro Foam 22.5 oz can (case of 12)
3414918	CF 812 Pro Foam 22.5 oz can (32 cases)

Technical Data

Foam yield per can	Approx 1.30 ft ³
Approximate cure schedule (ASTM C 1620)	Tack free after approx 8-10 minutes Ready to cut after approx 15-20 minutes
Application temperature	41°F to 95°F (5°C to 35°C)
Air infiltration (ASTM E 283)	0.01 cfm/ft ² @ 1.56 psf (75 Pa)
Surface burning characteristics (UL 723)	Flame Spread: 0 Smoke Developed: 5
Shelf life from date of manufacture (when stored at 68°F)	12 months

CF 512

Cold Weather Pro Foam

- Low temperature performance allows the CF 512 to be applied in cold weather (30° F)
- Use as a fireblock for Type V non fire-rated wood frame construction (refer to ESR 2179) (Not for use in fire-rated assemblies)
- Identifiable orange color



Item No.	Description
3431483	CF 512 Cold Weather Foam 24 oz can (case of 12)
3431485	CF 512 Cold Weather Foam 24 oz can (32 cases)

Technical Data

Foam yield per can	1.60 ft ³ (48 L)
Approximate cure schedule	Tack free after approx 8-10 minutes Ready to cut after approx. 25 minutes
Application temperature	30°F to 80°F (-1°C to 27°C)
Shelf Life from Date of Manufacture	12 months
Building material class	Class A
Tested in accordance with	• UL 723

All data measured at 73°F (23°C) and 55% relative humidity

Foam Accessories

259768	CF-DS1 Dispenser	①
313187	P20-600K Extra Long Dispenser (with 27" barrel)	②
311512	CF & EX/DS Plastic Nozzle Tip (20/pack)	
24631	CF-R1 Cleaner 17 oz (500 ml) can	



Hilti. Outperform. Outlast.

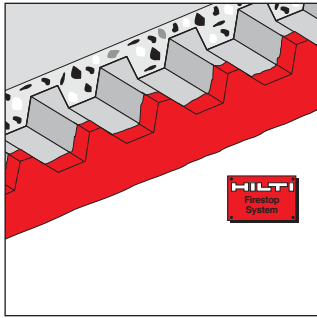

Complete Top of the Wall Firestop Solution

CP 672 Speed Spray

- A sprayable, latex based, fire-rated mastic for construction joints where maximum movement is required
- Maximum flexibility, exceeds 500 cycle requirements (Class II & III Approval) (UL 2079 & ASTM E 1966)
- Mold and mildew resistant
- Contains no halogens, solvents, asbestos or carcinogens
- Water based formulation so spills and over-spray cleanup quick and easy
- Meets LEED™ requirements for indoor environmental quality credit 4.1 Low Emitting Materials, Sealants and Adhesives and 4.2 Paints and Coatings

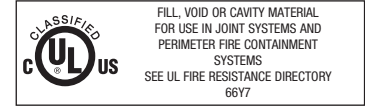

Item No.	Description	Color
385198	CP 672 Speed Spray, 5 gal pail	Red ①
3423575	CP 672 Speed Spray, 12 pails	Red
3423576	CP 672 Speed Spray, 18 pails (1 pallet)	Red
3423577	CP 672 Speed Spray, 36 pails (2 pallets)	Red
3423578	CP 672 Speed Spray, 18 pails / EPX 2555 Sprayer Combo	Red
3423579	CP 672 Speed Spray, 36 pails / EPX 2555 Sprayer Combo	Red
3426209	CP 672 Speed Spray, 18 pails / EPX 2355 Sprayer Combo	Red
3426210	CP 672 Speed Spray, 36 pails / EPX 2355 Sprayer Combo	Red
228971	CP 672 Speed Spray, 5 gal pail	White
233962	CP 672 Speed Spray, 5 gal pail (special order)	Gray

Accessories

Item No.	Description
334123	Spray Tech EPX 2555 Heavy-Duty Sprayer ②
3426208	Spray Tech EPX 2355 Warm-Weather Sprayer
376841	Spray Tech Sprayer Tip .225
335516	Spray Tech Sprayer Tip .227
3425297	Spray Tech Sprayer Tip .331
376840	Spray Tech Sprayer Tip.425
376844	Spray Tech Sprayer Tip.427
376843	Spray Tech Sprayer 3' x 1/4" Whip Hose
376842	Spray Tech Sprayer 3/8" x 1/4" Fitting

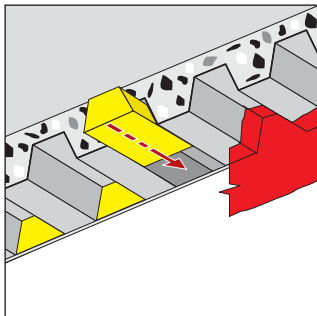

CP 767 and CP 777 Speed Strips and Speed Plugs

- Pre-formed mineral wool strips for most 1.5", 2" and 3" decks
- Pre-cut, leaves no gaps or voids
- Smooth surface provides cost effective spray coverage
- Safe to use, no asbestos, inorganic, will not mildew
- Up to 60% faster than castle cutting

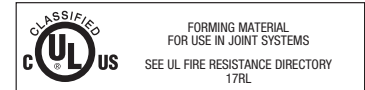

CP 777 Speed Plugs

Item No. (Qty)	Description	Flute Dimensions (L x (Flute) x H)
371925 (18)	CP 777 1.5" Speed Plug	36" x (3.5" x 4.5") x 1.5"
340998 (18)	CP 777 2" Speed Plug	36" x (4.5" x 5.5") x 2"
340999 (18)	CP 777 3" Speed Plug	36" x (5" x 7") x 3"

CP 767 Speed Strips

Item No. (Qty)	Description	Strip Dimensions (L x W x H)
374507 (84)	CP 767 2" Speed Strips (1 Hour)	36" x 0.625" x 2"
374508 (42)	CP 767 2" Speed Strips (2 Hour)	36" x 1.25" x 2"
374505 (42)	CP 767 4" Speed Strips (1 Hour)	36" x 0.625" x 4"
374506 (21)	CP 767 4" Speed Strips (2 Hour)	36" x 1.25" x 4"

Accessories

Item No. (Qty)	Description	Volume
236993 (4)	Mineral Wool (46"L x 24"W x 4"H Sheet)	17,664 in ³



Hilti. Outperform. Outlast.

CP 606

Flexible Firestop Sealant

- An acrylic based firestop sealant that provides movement capability in fire rated joint and through-penetration applications
- Paintable
- Meets LEED™ requirements for indoor environmental quality

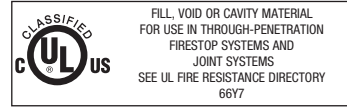

Item No. (Qty)	Description	Color	Volume	
337756 (20)	CP 606 10.5 oz tube (310 ml)	Red	18 in ³	(1 case of 20 tubes)
314272 (20)	CP 606 19.6 oz foil pack (580 ml)	White	36 in ³ ea	(1 case of 20 foil packs)
337192 (20)	CP 606 19.6 oz foil pack (580 ml)	Red	36 in ³ ea	(1 case of 20 foil packs)
337765 (1)	CP 606 19.6 oz foil pack (580 ml)	Red	36 in ³ ea	(1 pallet of 30 cases)
314273 (1)	CP 606 5 gal pail (19 L)	White	1155 in ³	(1 pail)
337193 (1)	CP 606 5 gal pail (19 L)	Red	1155 in ³	(1 pail)
337764 (1)	CP 606 Foil Pack Combo	Red	36 in ³ ea	(3 cases and 1 dispenser)
315017 (1)	CP 606 Foil Pack Combo	White	36 in ³ ea	(3 cases and 1 dispenser)
3426568 (60)	CP 606 Foil Pack Combo	Gray	36 in ³ ea	(3 cases and 1 dispenser)

CP 604

Self-Leveling Firestop Sealant

- Self-leveling, single-component, silicone-based firestop sealant for use with through-penetrations as well as construction joints in floors.
- Meets LEED™ requirements for indoor environmental quality

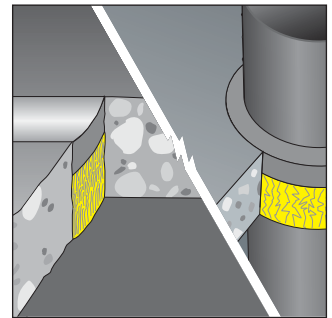
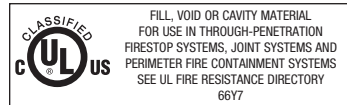

Item No. (Qty)	Description	Color	Volume	
369637 (12)	CP 604 20.2 oz foil pack (600 ml)	Gray	36 in ³ ea	(1 case of 12 tubes)
369177 (1)	CP 604 4 gal pail	Gray	924 in ³	(1 pail)

Accessories

Item No. (Qty)	Description
55205 (1)	CB 200 PI-300/310 ml Dispenser (use with 10.5 oz. / 310 ml tubes)
24669 (1)	600 ml Foil Dispenser (use with 19.6 oz. / 580 ml foil packs)
334548 (1)	Foil Pack Dispenser Replacement Nut
374502 (1)	Pneumatic Dispenser (use with 16.9 oz. / 580 ml foil packs)
306219 (10)	Hilti Firestop System Identification Plate



Tube



Foil Pack



Pail

CP 617, CP 617L & CP 617XL

Firestop Putty Pad

- An intumescent moldable firestop putty designed to help protect electrical outlet boxes
- Applied by hand
- Fast installation

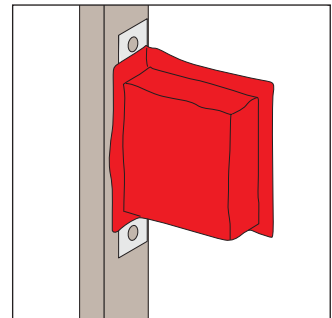
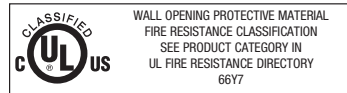

Item No. (Qty)	Description	Volume
309760 (20)	CP 617 Putty Pad 6" x 7"	42 in ² ea
333583 (20)	CP 617L Putty Pad 7" x 7"	49 in ² ea
373387 (20)	CP 617XL Putty Pad 9" x 9"	81 in ² ea

Hilti. Outperform. Outlast.

HILTI	
LIFETIME SERVICE™	
2 Years	NO COSTS
Lifetime	Lifetime
REPAIR COST LIMIT	MANUFACTURERS WARRANTY

Hilti Tools. Lifetime Service.

Lifetime Manufacturers Warranty

Hilti repairs or replaces the tool at no cost, if there is damage to the tool due to defects in materials or workmanship.

No-Cost coverage for up to 2 years*

With Hilti tools you incur absolutely no repair costs for up to 2 years from the date of purchase. This includes:

- No cost inbound and return shipping
- Labor costs
- Repair or replacement of any defective parts as well as parts subject to wear and tear**
- Servicing when indicated by the service indicator light on the tool
- Functional check, adjustments and safety check after every repair
- One calibration per year of Hilti laser tools during the 2 year No-Cost period

Lifetime Repair Cost Limit

After reaching the end of the 1 or 2 year No-Cost period, you pay a maximum of 30% of the corresponding new tool's list price per repair. If the cost of the repair is below this limit, you only pay the actual cost of the repair.

Plus

Each charged repair after your initial No-Cost period includes:

- An extended 6 month No-Cost period for tools with an initial 2 year No-Cost coverage, and 3 months for tools with an initial 1 year No-Cost coverage
- No cost inbound shipping
- No cost calibration with each laser tool repair

Hilti tool repair

When a tool goes down, Hilti understands your need to get it back on the job quickly. That is why we strive to repair and return your tool in 5 working days or less.

The process is simple:

- 1 - Call Hilti Customer Service** (U.S. 1-800-879-8000, Canada 1-800-363-4458)
- 2 - Answer a few simple questions** and a pre-paid shipping label will be faxed or emailed to you within minutes.
- 3 - Package your tool for shipping**, place the pre-paid shipping label on the box and give the packaged tool to your delivery person or drop it off at your nearest shipping location. (U.S. - Shipping via UPS; Canada - Shipping methods vary depending upon region.)

* The following limitations apply:

- Hilti gas saws and 4-1/2 inch angle grinders are covered with a Lifetime Manufacturer's Warranty and Lifetime Repair Cost Limit. Gas saws and 4-1/2 inch angle grinders are excluded from No-Cost coverage.
- Hilti tools covered with 1 year No-Cost period are 5 to 7-inch angle grinders, screwdrivers, drill/drivers, SID / SIW 121-A impact tools, GX 100 / GX 100-E gas-driven fastening tools, circular, jig and reciprocating saws, stand-up powder-actuated decking tools, pneumatic decking tools, chemical product dispensers and all Hilti NiCD and NiMH batteries and chargers.
- No-Cost coverage excludes damage due to abuse, or use not in accordance with the tool operator's manual.
- Lifetime Manufacturer's Warranty and Lifetime Repair Cost Limit offered as long as replacement parts remain available.
- Refurbished batteries may be used as a No-Cost replacement part.

** Pistons, spring clips and buffers for powder-actuated fastening tools are excluded from the No-Cost wear and tear coverage.

Hilti. Outperform. Outlast.

Hilti Tool Fleet Management

We'll manage your tools so you can manage your business.

Tool Fleet Management is a customized streamlined process to help eliminate costly administrative hassles associated with running a tool fleet. Start the program with the tools you need right now and add more tools at any time. One monthly invoice covers absolutely all tool related costs including tool usage, repairs and customized services. Each tool will be replaced at the right time (after 12-48 months) with the latest generation.

Always modern tools without any upfront investment



- Pay a monthly fee and get a whole new fleet of tools
- All tools are regularly renewed to eliminate costly downtime and ensure latest safety standards
- Fixed monthly fees make budgeting and cost allocation easy
- Add new tools anytime quickly and easily

Innovative tool management reduces costs by up to 50%



- No additional costs for repair or replacement for up to 4 years
- Elimination of administrative work related to tool purchasing, repair quotations and accounting
- Clear tool assignment to employees, cost centers or job-sites

Customized services for more productivity and profit



- Personalized tool labels to aid tracking – and deter theft
- Full transparency to your entire fleet is only one click away via the exclusive Fleet Management online site
- Deter theft further with unique features such as the Hilti Theft Protection System

For the price of a coffee...
...have yourself a new Hilti tool.

Safeguard your tools with Hilti's unique Theft Coverage offering.

- Minimize your financial exposure in the event of a theft
- A small monthly premium and a deductible of 20% covers your entire fleet
- All fleet tools are covered any time, any where with an annual coverage of 20% of the total fleet value
- Simply report the theft to Hilti with a police report—we take care of the rest

All this value for the price of a coffee...Yes.

Contact your Hilti Account Manager today for a personalized Tool Fleet Management consultation or call toll free to schedule an appointment.

Hilti. Outperform. Outlast.

In the US:

P.O. Box 21148 Tulsa, OK 74121
Customer Service: 1-800-879-8000
en español: 1-800-879-5000
Fax: 1-800-879-7000

www.us.hilti.com

In Canada:

6790 Century Avenue, Suite 300
CDN-Mississauga, Ontario L5N 2V8
Customer Service: 1-800-363-4458
Fax: 1-800-363-4459

www.hilti.ca

Hilti is an equal opportunity employer.
Hilti is a registered trademark of Hilti, Corp.
©Copyright 2007 by Hilti, Inc. (U.S.)
H670 • 3411244 • 10/07 • HA



*ISO 14001 US Only

The data contained in this literature was current as of the date of publication. Updates and changes may be made based on later testing. If verification is needed that the data is still current, please contact the Hilti Technical Support Specialists at 1-800-879-8000 (U.S.) or 1-800-363-4458 (Canada). All published load values contained in this literature represent the results of testing by Hilti or test organizations. Local base materials were used. Because of variations in materials, on-site testing is necessary to determine performance at any specific site.