



US Army Corps  
of Engineers  
Huntington District

*One Corps, One Regiment, One Team*

# Post-Tensioning Institute

## Tri-Service Infrastructure Systems Conference

Michael McCray, P.G.  
(304) 399-5234

Recommendations  
for Prestressed  
Rock and Soil  
Anchors



**pti** POST-TENSIONING  
INSTITUTE



US Army Corps  
of Engineers  
Huntington District

*One Corps, One Regiment, One Team*

# Technical Revisions

- ◆ **Corrosion Protection**
- ◆ **Partially Bonded Anchors**
- ◆ **Bond Length Design**
- ◆ **Bar Anchors**
- ◆ **Supplementary Requirements for Epoxy-Coated Strand Tendons**



US Army Corps  
of Engineers  
Huntington District

*One Corps, One Regiment, One Team*

**EC 1110-2-6058**  
**31 October 2003**

**◆ Rock Mass Shear Failure and  
References to PTI**



US Army Corps  
of Engineers  
Huntington District

*One Corps, One Regiment, One Team*

# Technical Revisions

## Corrosion Protection

- ◆ **Epoxy-Coated Bars**
- ◆ **Decision Tree** (Consequences Of Failure)
- ◆ **Corrugated**



US Army Corps  
of Engineers  
Huntington District

*One Corps, One Regiment, One Team*

# Corrosion Protection Epoxy-Coated Bars

An epoxy-coated bar tendon grouted into a drill hole that has successfully passed the water pressure test is no longer considered Class I Protection





US Army Corps  
of Engineers  
Huntington District

*One Corps, One Regiment, One Team*

# Corrosion Protection Epoxy Coated Bars

## Epoxy coatings for bar and strand are not equivalent

- ◆ The average thickness required and possible on bars is only one third that of strand
- ◆ ASTM A775 and A934 allow an average of 3 holidays per lin. m of bar (without patching)
- ◆ ASTM A882 for strand allows only 2 holidays per 30 lin. m of stand (must be patched)
- ◆ The epoxy coating used on strand is more resistant to damage



# Corrosion Protection Decision Tree

Figure 5.1 Corrosion Protection Decision Tree

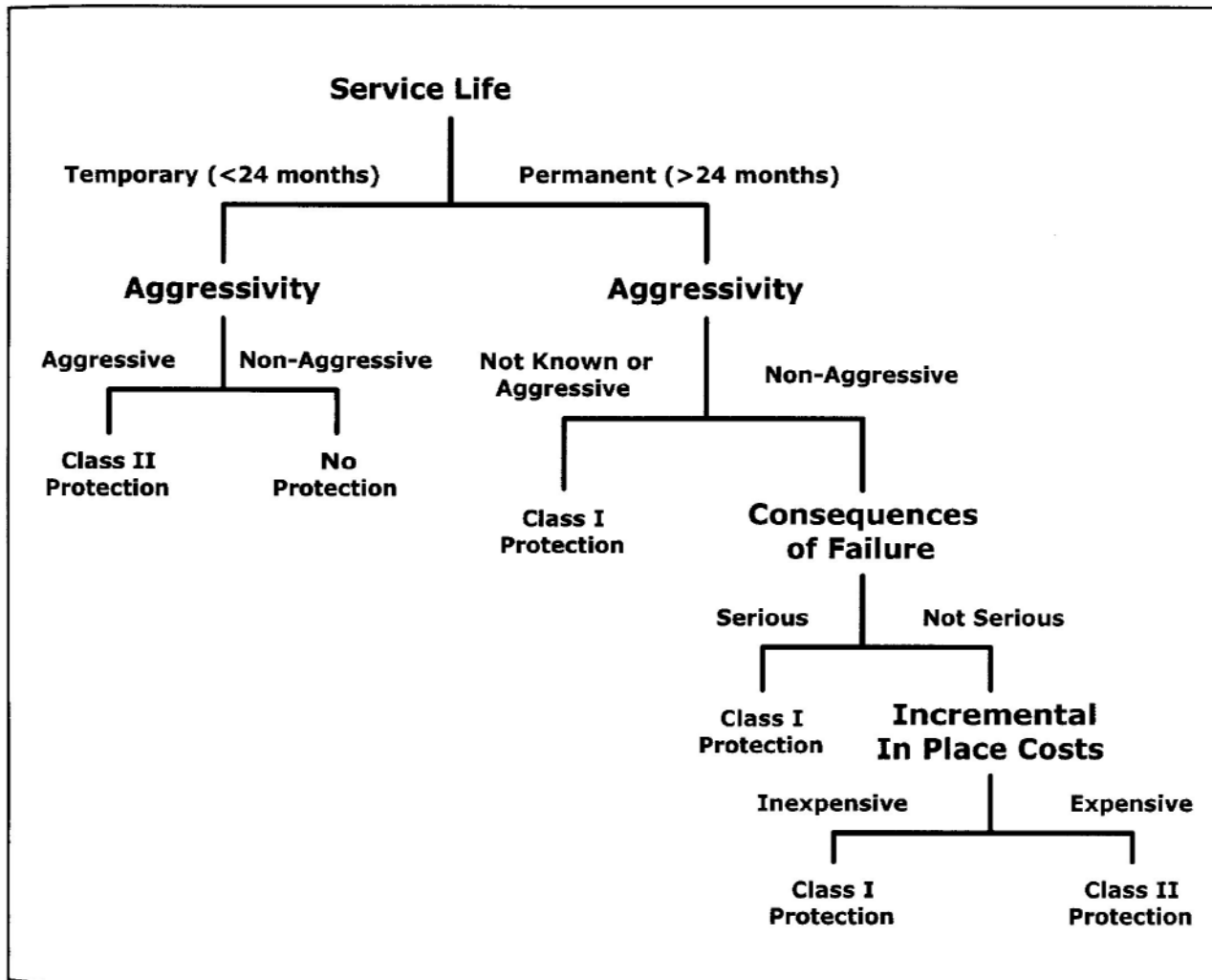





US Army Corps  
of Engineers  
Huntington District

*One Corps, One Regiment, One Team*

# Corrosion Protection Decision Tree

## Consequences Of Failure

### Third Edition

“If the failure of an isolated anchor could result in serious consequences, then the entire tendon length shall be protected by at least one layer of protection in addition to the grout or resin regardless of the aggressivity of the ground.”

### Fourth Edition

“If the failure of the anchors could result in serious consequences, such as loss of life or serious economic impact, then the entire tendon length shall be protected by a Class I protection (See Section 5.3).”

Post-Tensioning Institute, Recommendations for Prestressed Rock and Soil Anchors, Fourth Edition



US Army Corps  
of Engineers  
Huntington District

*One Corps, One Regiment, One Team*

# Corrosion Protection Corrugated

‘Cutting of “windows” in the sheath or omission of the end cap in order to allow equalization of interior and exterior grout levels shall not be permitted.’



US Army Corps  
of Engineers  
Huntington District

*One Corps, One Regiment, One Team*

# Corrosion Protection Corrugated

- ◆ HDPE Nominal thickness (0.060 in.)
- ◆ HDPE Minimum thickness (0.050 in.)

“A heavier wall thickness will be required for large diameter plastic tubing”

# Corrosion Protection

- ◆ **Corrugated (Prinsco, Goldline)**
  - 70-mil (measured at the crown)
    - 84-mil max
    - 56-mil minimum
  - 550 ft lengths

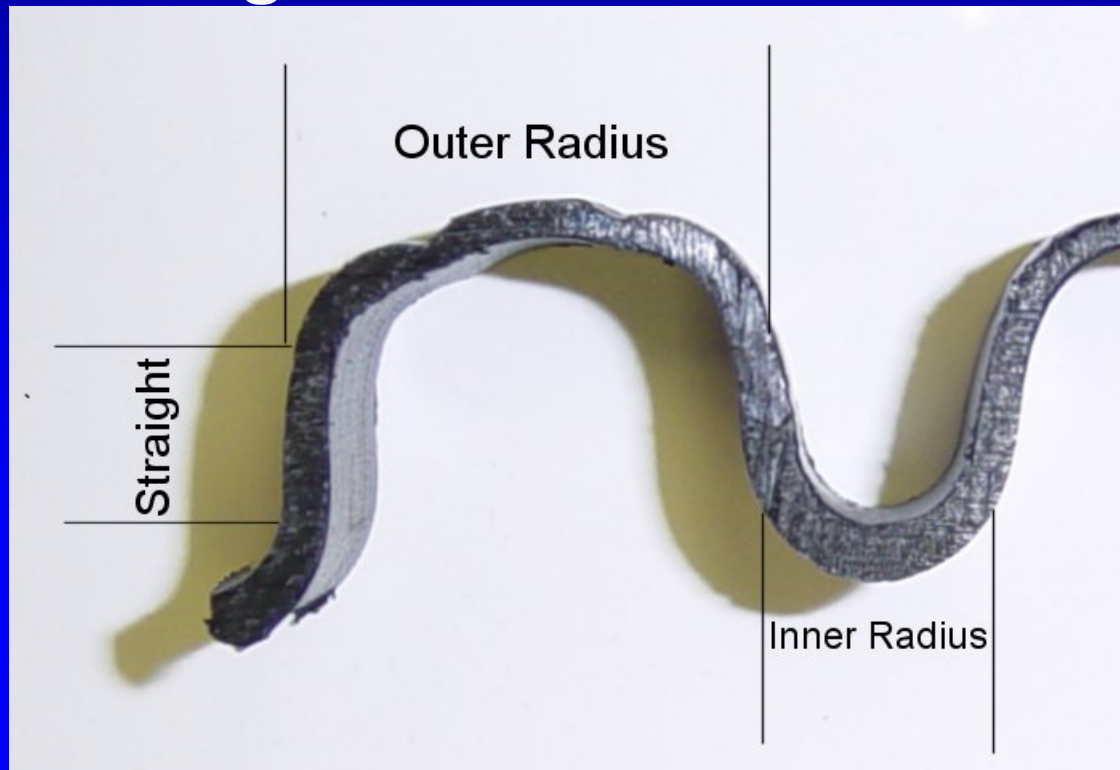



US Army Corps  
of Engineers  
Huntington District

*One Corps, One Regiment, One Team*

# Corrosion Protection Corrugated

- ◆ Critical buckling pressure for 10” diameter, 70-mil corrugated: 19 PSI
- ◆ Critical buckling pressure for 10” diameter, 100-mil corrugated: 39 PSI



US Army Corps  
of Engineers  
Huntington District

*One Corps, One Regiment, One Team*

# Corrosion Protection Corrugated

“On projects where routine water pressure testing of the drill hole is specified, pressure testing of the encapsulation after installation and prior to any grouting should be considered”

# Corrosion Protection Corrugated





US Army Corps  
of Engineers  
Huntington District

*One Corps, One Regiment, One Team*

# Technical Revisions

## Partially Bonded Anchors

**What are they?**





US Army Corps  
of Engineers  
Huntington District

*One Corps, One Regiment, One Team*

# Partially Bonded Tendon

“Partially bonded free lengths provide redundant load transfer at the anchorage while at the same time leaving a certain amount of unbonded free length.”

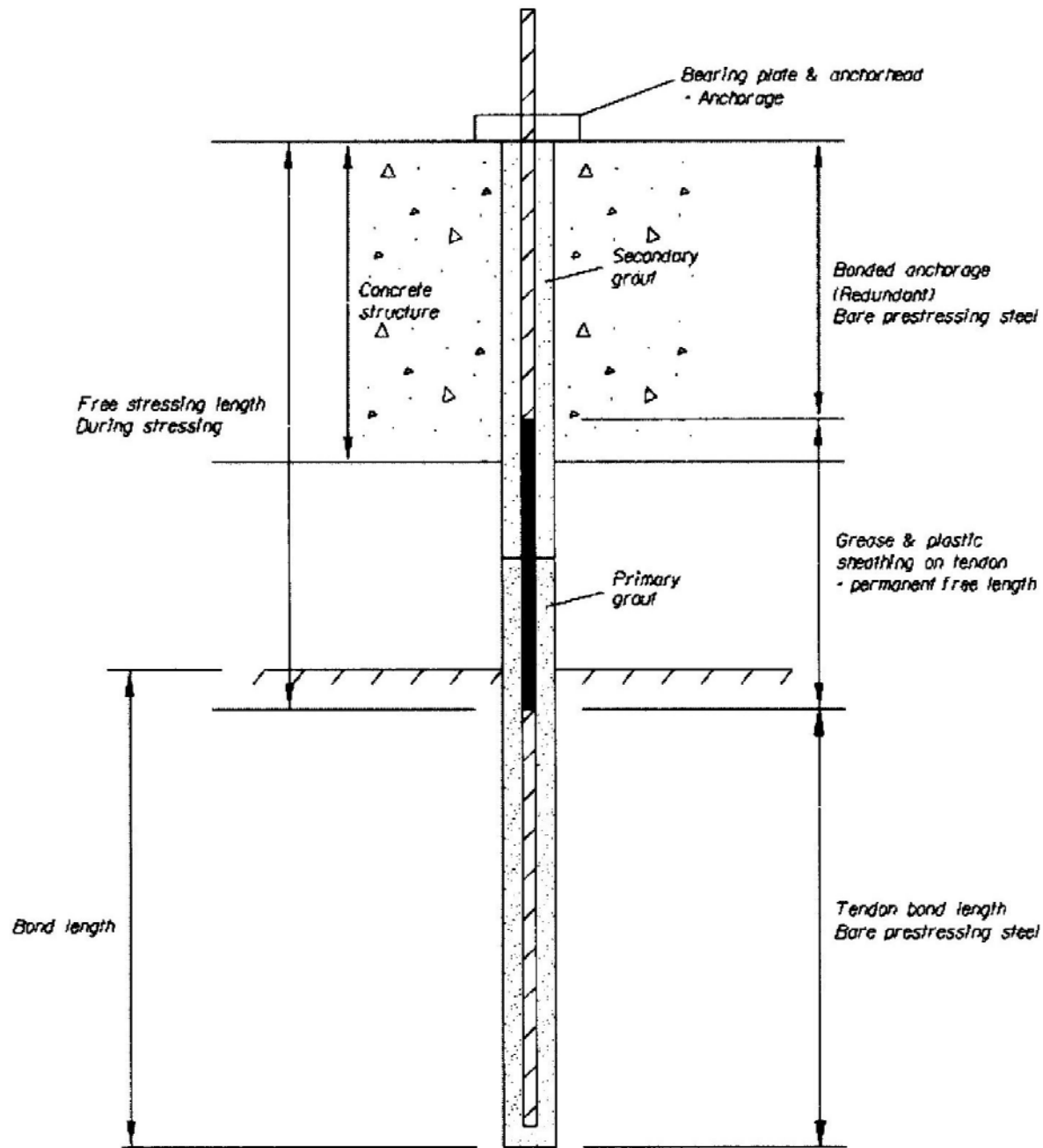



US Army Corps  
of Engineers  
Huntington District

*One Corps, One Regiment, One Team*

# Technical Revisions

## Bond Length Design

**Can we increase the efficiency?**



US Army Corps  
of Engineers  
Huntington District

*One Corps, One Regiment, One Team*

# Bond Length Design

“Extending the unbonded length of the prestressing steel a sufficient depth into the bond zone so that the bond length is partially loaded in compression”

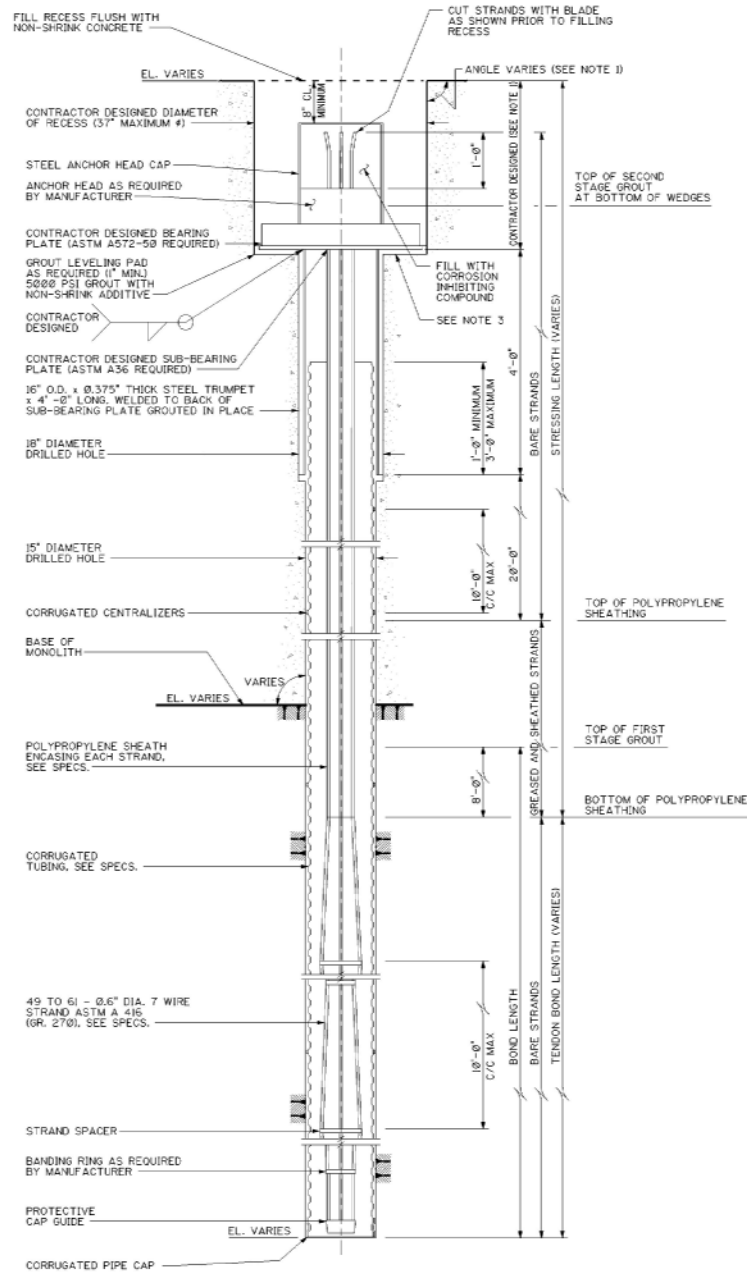

**TYPICAL 49 TO 61 STRAND  
NONRESTRESSABLE ANCHOR DETAIL**

SCALE: 1" = 1'-0"

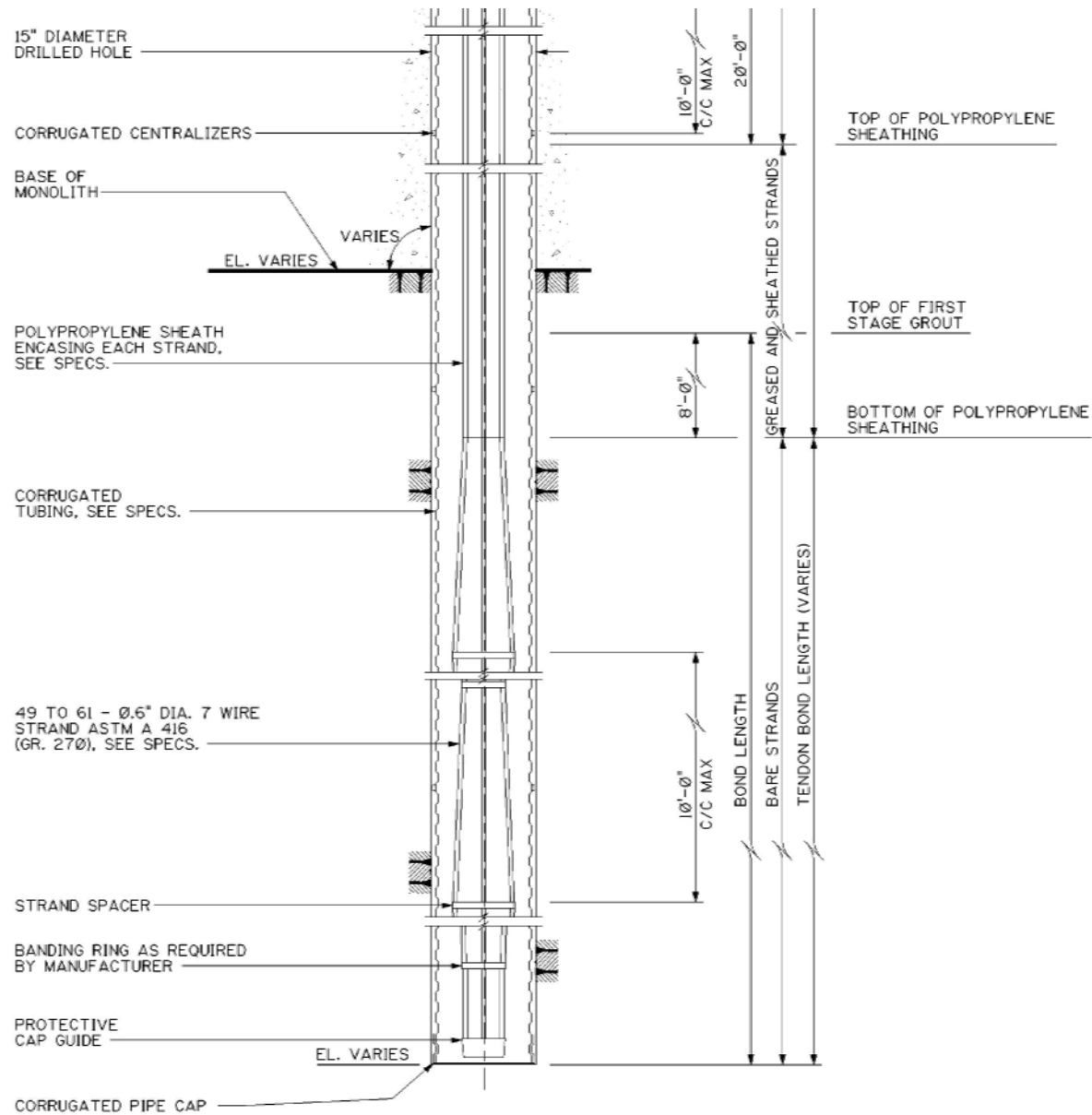

**TYPICAL 49 TO 61 STRAND  
NONRESTRESSABLE ANCHOR DETAIL**

SCALE: 1" = 1'-0"



US Army Corps  
of Engineers  
Huntington District

*One Corps, One Regiment, One Team*

# Bond Length Design

## Over Grouting of the bare strand (5 to 10 feet)

- ◆ Eliminates diking of the grout near the top of the bond zone
- ◆ Compensates for small grout losses
- ◆ Allows for partially bonded anchors



US Army Corps  
of Engineers  
Huntington District

*One Corps, One Regiment, One Team*

# Technical Revisions

## Bars

# Are they all created equal?





US Army Corps  
of Engineers  
Huntington District

*One Corps, One Regiment, One Team*

# Bar Anchors

“For bars that have not been proof stretched during manufacturing to  $0.8F_{pu}$ , creep test data shall also be submitted”



US Army Corps  
of Engineers  
Huntington District

*One Corps, One Regiment, One Team*

# Bar Anchors

- ◆ Threadbars up to a diameter of 1 3/8" are hot-rolled and then cold stretched (proof stretched)
  - Results in a very linear stress-strain curve to near the yield point
- ◆ Threadbars larger than 1 3/8" are cold drawn but not cold stretched
  - Because the drawing force used in the manufacturing process is much lower than the yield force the stress-strain curve is nonlinear
  - Results in:
    - Increased relaxation (ask for relaxation %)
    - Increased creep
    - Plastic behavior prior to yield



US Army Corps  
of Engineers  
Huntington District

*One Corps, One Regiment, One Team*

# Bar Anchors

“The Creep Test is intended to determine the creep movement of the grout body through the ground at the test load.”

Free Length  
56.5 feet

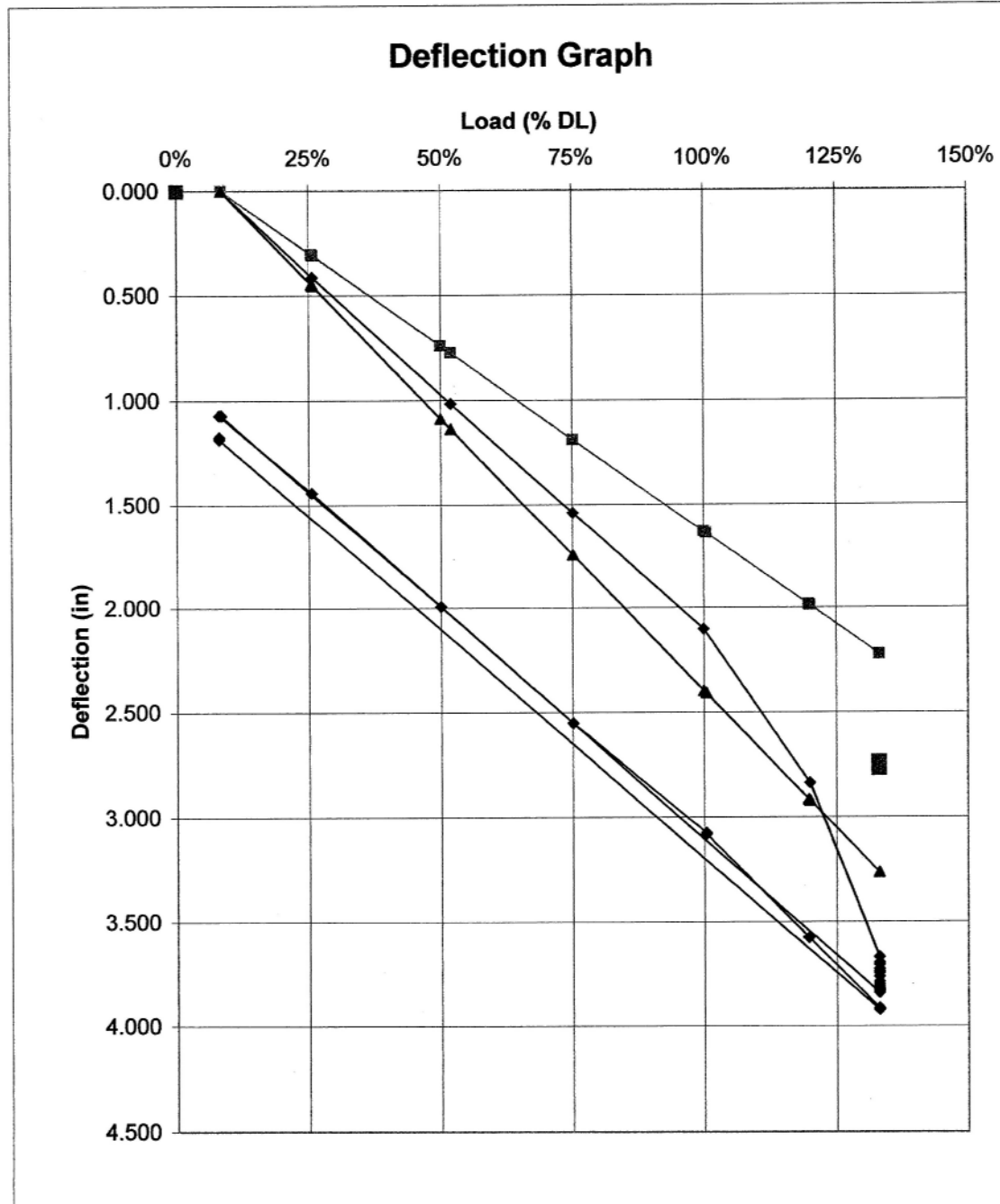



US Army Corps  
of Engineers  
Huntington District

*One Corps, One Regiment, One Team*

# Supplementary Requirements for Epoxy- Coated Strand Tendons

- ◆ Creep
- ◆ Relaxation
- ◆ Minimum free stressing length



US Army Corps  
of Engineers  
Huntington District

*One Corps, One Regiment, One Team*

# Supplementary Requirements for Epoxy-Coated Strand Tendons

“Recent tests have shown that the amount of creep between strands from one manufacturer can vary by up to 50% from the average creep and between manufacturers by as much as a factor of 3.”



US Army Corps  
of Engineers  
Huntington District

One Corps, One Regiment, One Team

# Supplementary Requirements for Epoxy- Coated Strand Tendons

Creep Test Performed at 80% GUTS							
	Average % Creep After 10 Min	25 foot Free Length elongation in Inches	50 foot Free Length elongation in Inches	100 foot Free Length elongation in Inches	150 foot Free Length elongation in Inches		
<b>M1 Bare Strand 16 Samples</b>	0.0057%	0.017	0.034	0.068	0.102		
<b>MAX</b>	0.0100%	0.030	0.060	0.120	0.180		
<b>Min</b>	0.0012%	0.004	0.007	0.015	0.022		
<b>STDEV</b>	0.0028%	0.008	0.017	0.034	0.051		
<b>M1 Epoxy Strand 21 Samples</b>	0.0092%	0.028	0.055	0.110	0.165		
<b>MAX</b>	0.0171%	0.051	0.103	0.205	0.307		
<b>Min</b>	0.0042%	0.013	0.025	0.050	0.075		
<b>STDEV</b>	0.0034%	0.010	0.020	0.040	0.060		
<b>M2 Bare Strand 4 Samples</b>	0.0067%	0.020	0.040	0.080	0.120		
<b>MAX</b>	0.0100%	0.030	0.060	0.120	0.180		
<b>Min</b>	0.0050%	0.015	0.030	0.060	0.090		
<b>STDEV</b>	0.0023%	0.007	0.014	0.027	0.041		
<b>M2 Epoxy Strand 26 Samples</b>	0.0248%	0.074	0.149	0.297	0.446		
<b>MAX</b>	0.0421%	0.126	0.253	0.505	0.758		
<b>Min</b>	0.0163%	0.049	0.098	0.195	0.293		
<b>STDEV</b>	0.0067%	0.020	0.040	0.081	0.121		

Note: Those samples tested to 70% were not included.



US Army Corps  
of Engineers  
Huntington District

*One Corps, One Regiment, One Team*

# Supplementary Requirements for Epoxy- Coated Strand Tendons

	<b>OPTIONS</b>	<b>DESIGN LOAD (<math>F_{pu}</math>)</b>	<b>CREEP CRITERIA</b>	<b>TEST LOAD as % of <math>F_{pu}</math></b>	<b>COMMENTS</b>
1	Test to 1.5 DL	0.53	None	80	No Creep Test is conducted
2	Test to 1.33 DL	0.53	Same as bare strand	70	Limited test data suggest creep for epoxy-coated strand at this stress level is similar to bare strand
3	Test to 1.33 DL and conduct subsequent Lift-off Tests	0.60	None	80	Lift-off must be at least the original load minus the predicted tendon relaxation





US Army Corps  
of Engineers  
Huntington District

*One Corps, One Regiment, One Team*

# Supplementary Requirements for Epoxy- Coated Strand Tendons

“In defining the design load, the higher relaxation in epoxy-coated strand should be considered. The relaxation of epoxy-coated strand can be as high as 6.5% in 1,000 hours at  $0.7F_{pu}$ , compared to 2.5% for bare strand.

Both creep and relaxation are the results of plastic deformation in the strand under load.”



US Army Corps  
of Engineers  
Huntington District

*One Corps, One Regiment, One Team*

# Supplementary Requirements for Epoxy- Coated Strand Tendons

“A longer free stressing length is required for epoxy-coated strand to compensate for higher wedge seating loss, typically 15 to 25 mm (5/8 to 1 in.), versus 3 to 12 mm (1/8 to 3/8 in) for bare strand.”



US Army Corps  
of Engineers  
Huntington District

*One Corps, One Regiment, One Team*

**EC 1110-2-6058**

**31 October 2003**

# **Rock Mass Shear Failure and References to PTI**



US Army Corps  
of Engineers  
Huntington District

*One Corps, One Regiment, One Team*

**EC 1110-2-6058**  
**31 October 2003**

### (3) Rock-mass shear failure

- (a) Tensioned structural anchors. With all tensioned structural-anchor systems, a major consideration is determining how deep to install the anchors. An anchor system that is too shallow may cause tension and cracking to occur along potential failure planes in the foundation, and a system too deep is uneconomical. PTI recommends normal bond length not less than 3.0m (10ft) for bars and 4.5m (15ft) for strand. Bond lengths greater than 10m (35ft) are normally not used. PTI recommends free stressing lengths to be at least 3.0m (10ft) for bar tendons and 4.5m (15ft) for strand tendons. Center-to-center spacings between anchors shall be at least 1.5m (5ft) unless unusual circumstances dictate. The fixed end (dead end) anchorages should be staggered.



US Army Corps  
of Engineers  
Huntington District

*One Corps, One Regiment, One Team*

**EC 1110-2-6058**  
**31 October 2003**

Post-Tensioning Institute, “Recommendations for Prestressed Rock and Soil Anchors”, does not give guidance on determining how deep to install the anchors.



US Army Corps  
of Engineers  
Huntington District

*One Corps, One Regiment, One Team*

# Anchor Depth Design

“When selecting the elevation of the top of the bond length, the designer must consider the resistance to pullout of the rock mass, which also governs anchor length.” PTI

Post-Tensioning Institute, Recommendations for Prestressed Rock and Soil Anchors, Fourth Edition



US Army Corps  
of Engineers  
Huntington District

*One Corps, One Regiment, One Team*

# Anchor Depth Design

**“The anchor depth is taken as the anchor length necessary to develop the anchor force required for stability.” EM 1110-1-2908**



US Army Corps  
of Engineers  
Huntington District

*One Corps, One Regiment, One Team*

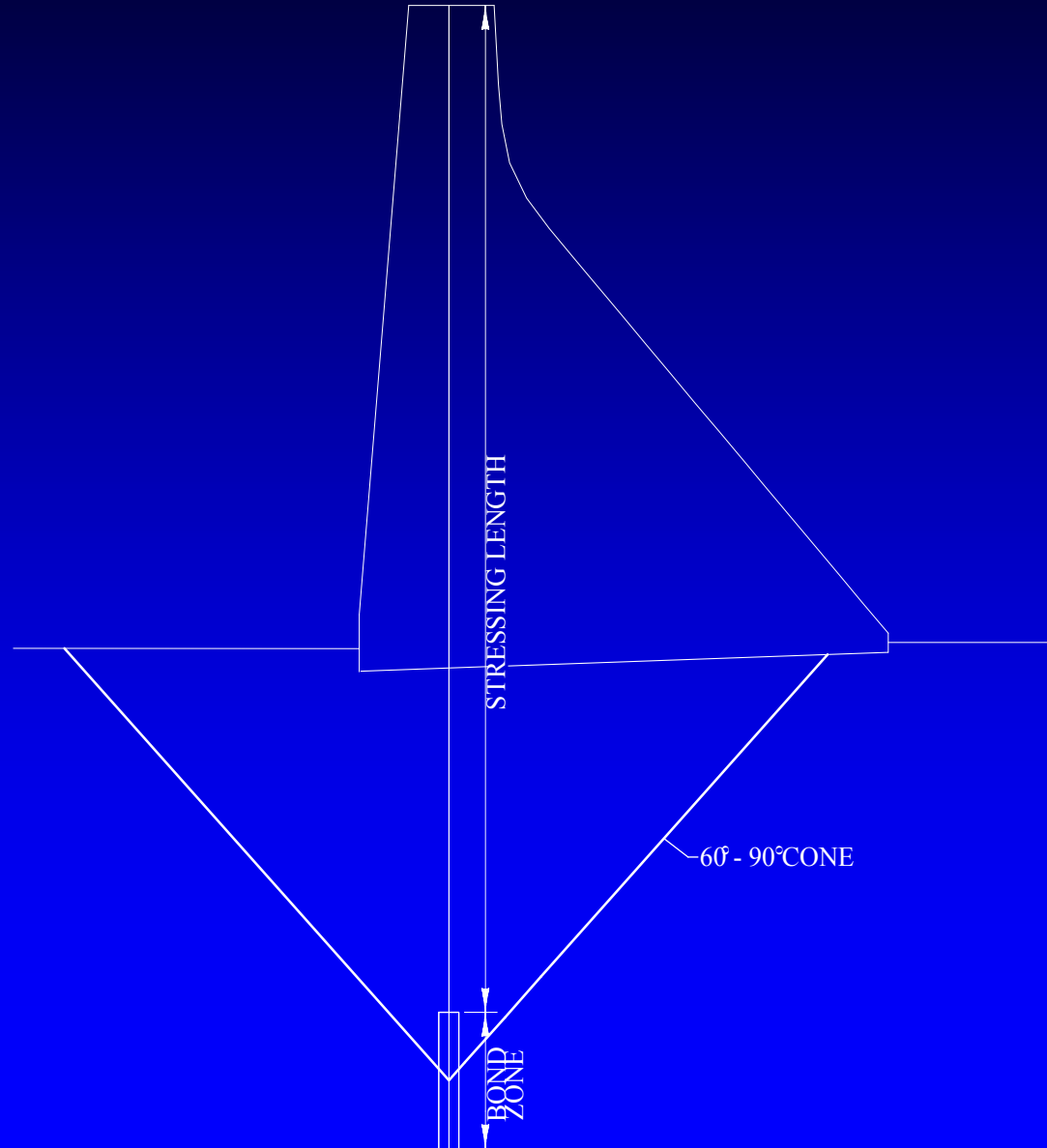





US Army Corps  
of Engineers  
Huntington District

*One Corps, One Regiment, One Team*

# Anchor Depth Design

**EM 1110-1-2908 gives 2 formulas for competent rock:**

- 1. Single Anchor in Competent Rock**
- 2. Single Row of Anchors in Competent Rock**



US Army Corps  
of Engineers  
Huntington District

*One Corps, One Regiment, One Team*

# Anchor Depth Design

**EM 1110-1-2908 gives 3 formulas for fractured rock:**

- 1. Single Anchor in Fractured Rock**
- 2. Single Row of Anchors in Fractured Rock**
- 3. Multiple Row of Anchors in Competent or Fractured Rock**

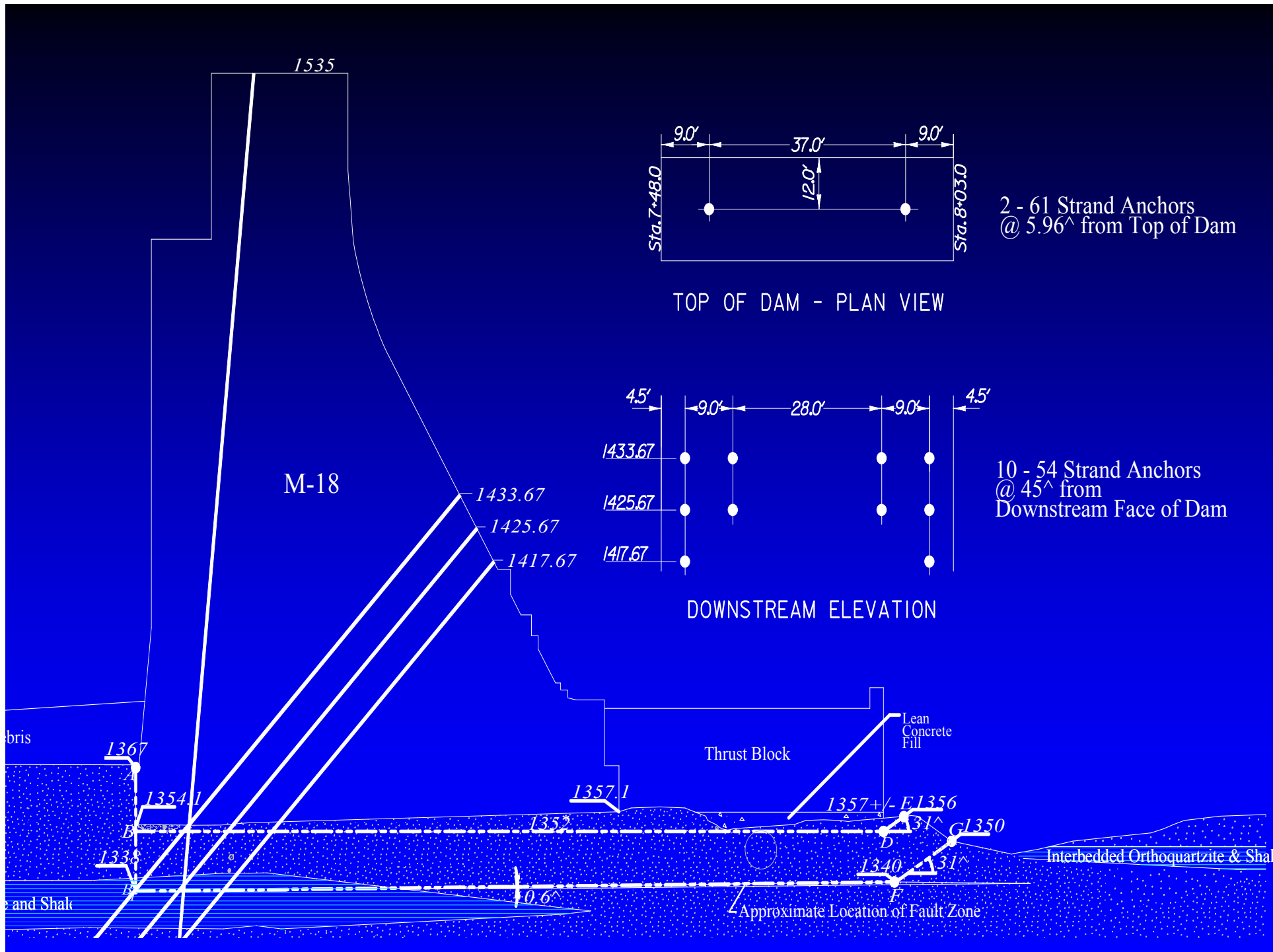



US Army Corps  
of Engineers  
Huntington District

*One Corps, One Regiment, One Team*

# Anchor Depth Design Mon-18

Multiple rows of anchors in competent rock, with a factor of safety of 1.5

$(FS * F) / \gamma_{ls}$  = Suggested depth of anchor for overall cone stability

360 feet



*One Corps, One Regiment, One Team*

**US Army Corps  
of Engineers**  
Huntington District

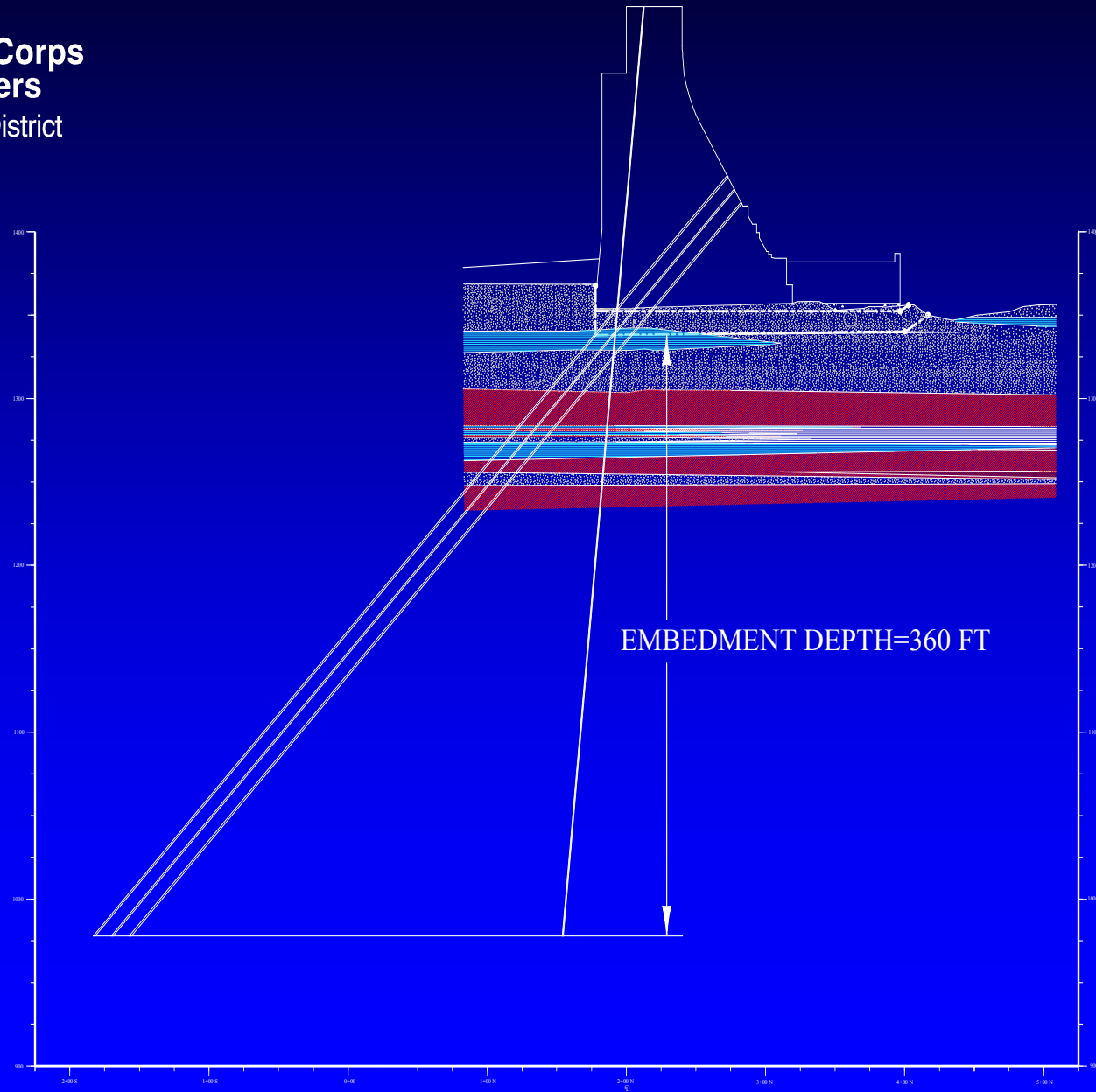

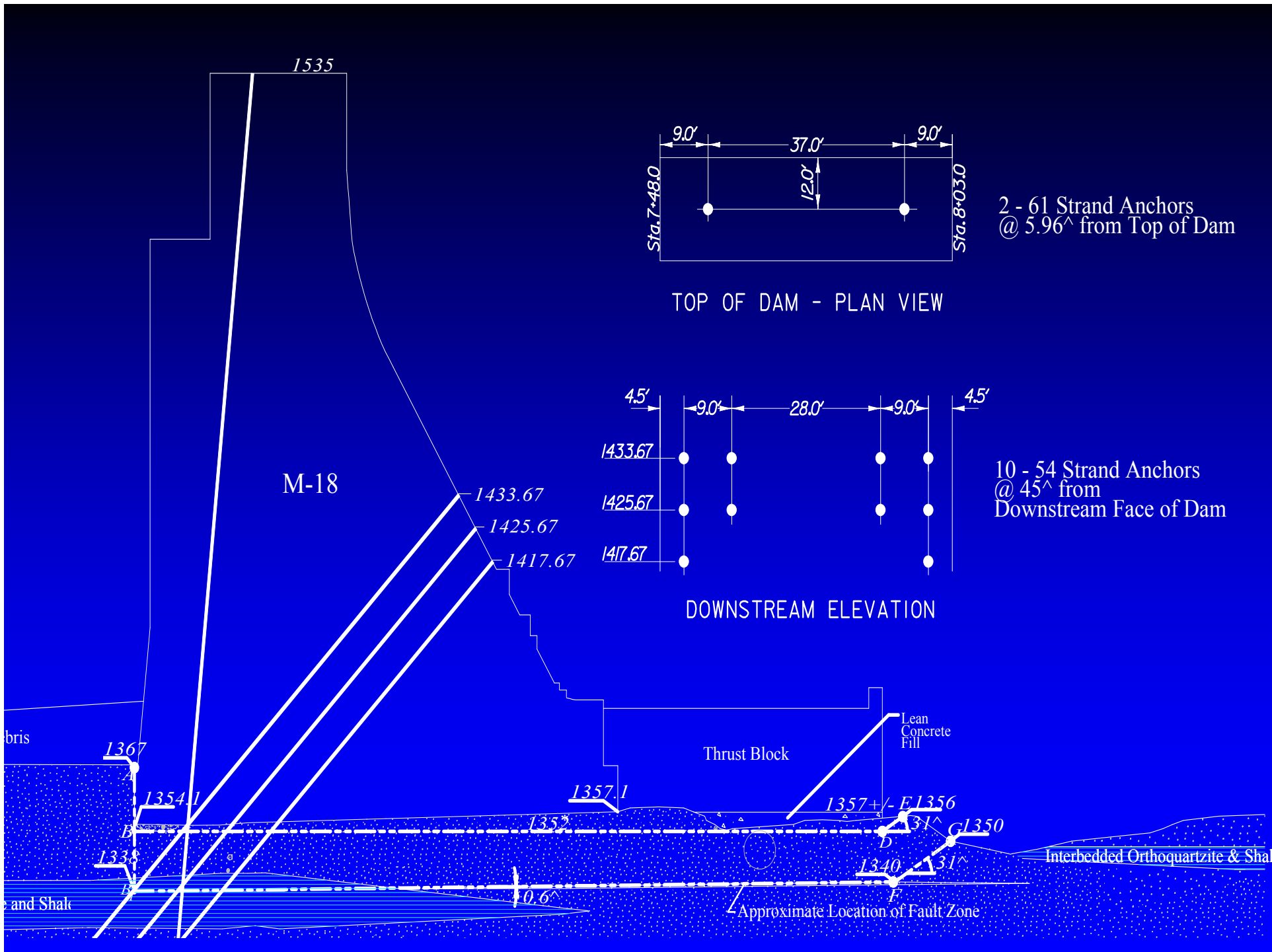



US Army Corps  
of Engineers  
Huntington District

*One Corps, One Regiment, One Team*

# Anchor Depth Design Mon-18

single anchor in fractured rock with the combined  
design load of all the anchors in that area

$$\text{cbt}((3FS * F) / (w * 3.14159)) \quad \mathbf{65.3 \text{ feet}}$$

**19,008,000 pounds of anchor  
force**



US Army Corps  
of Engineers  
Huntington District

One Corps, One Regiment, One Team

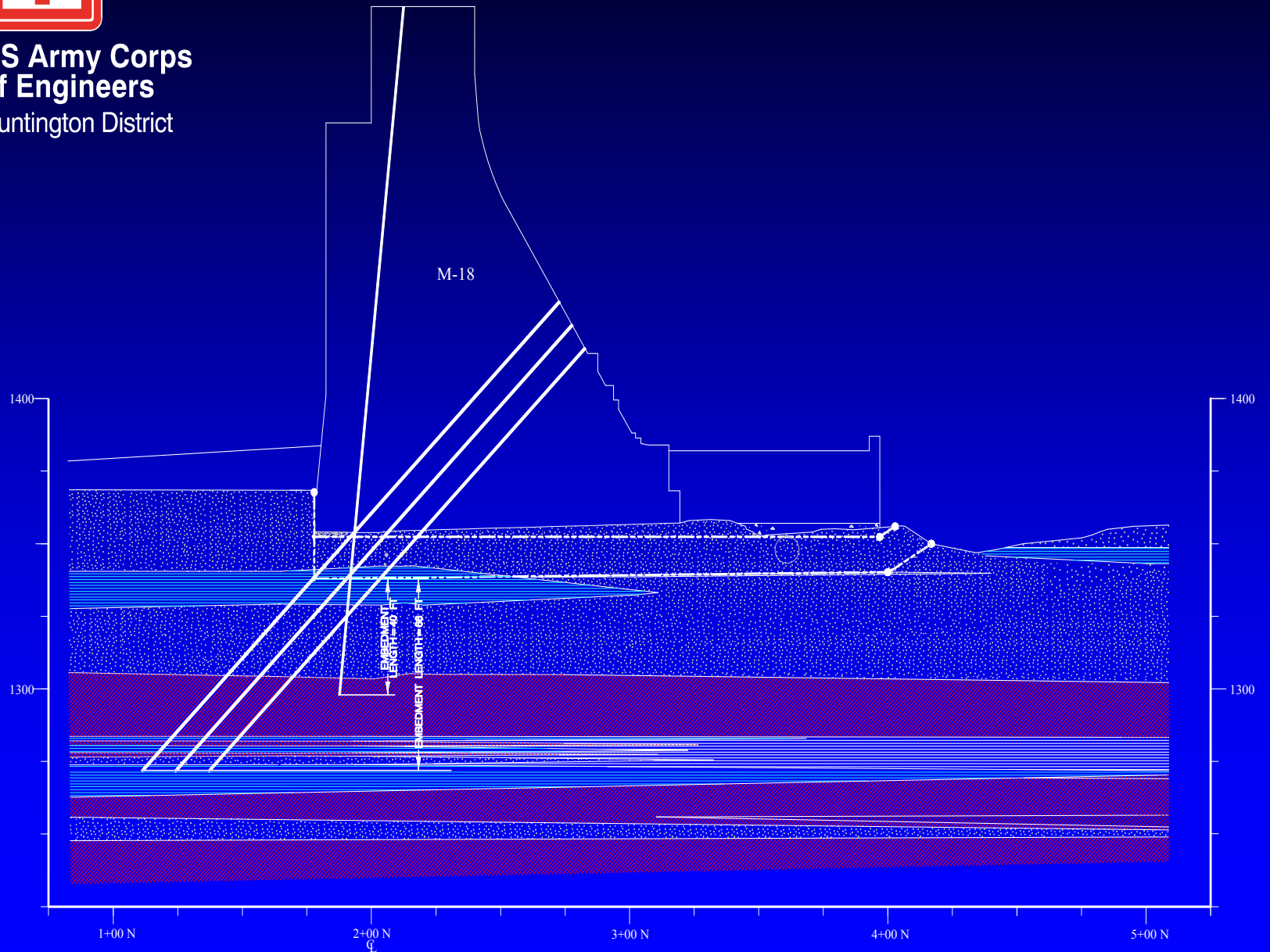



# 3-D CADD Drawing of Anchor Failure Cones Mon-18

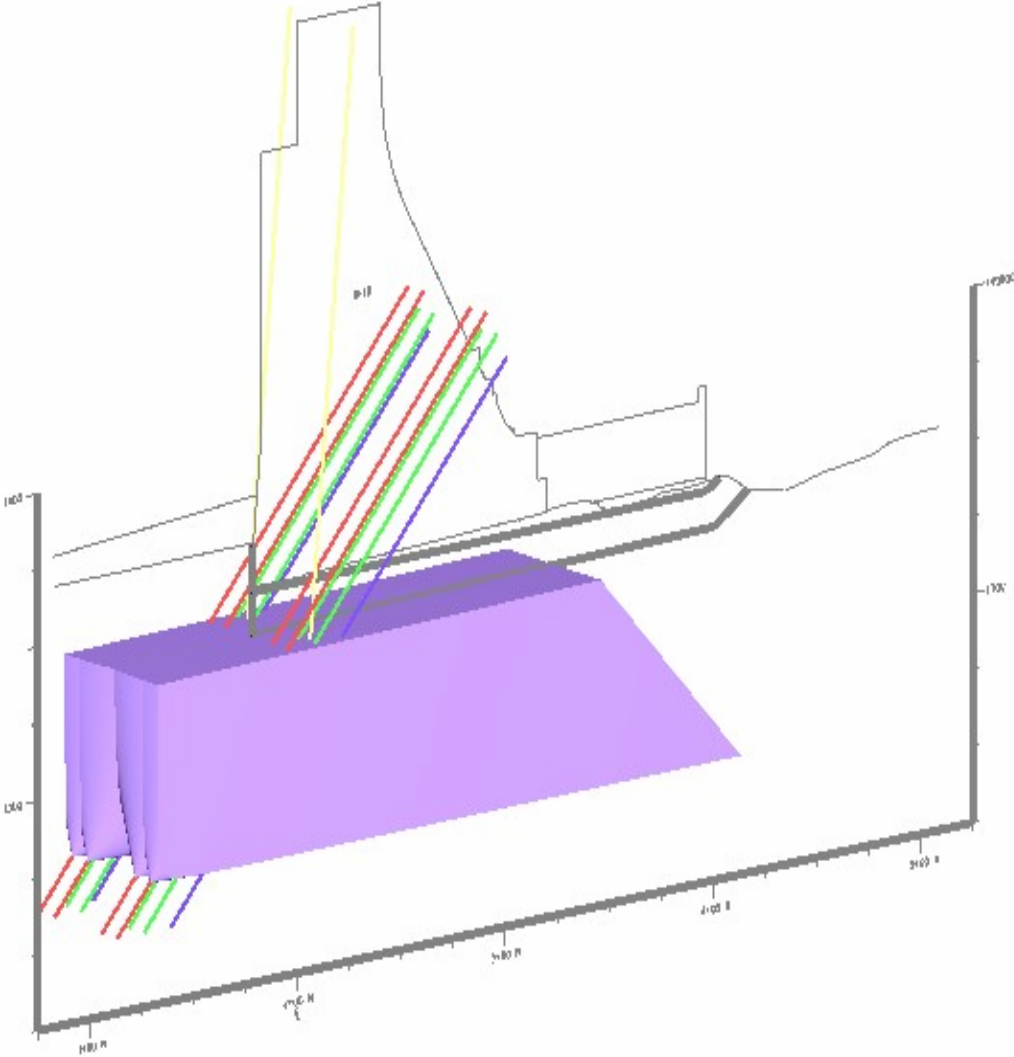



US Army Corps  
of Engineers  
Huntington District

*One Corps, One Regiment, One Team*

# Anchor Depth Design

**The buoyant weight of the rock mass engaged by the anchors in monolith 18 is 3.75 times that needed to resist the total force of the anchors.**



*One Corps, One Regiment, One Team*

**US Army Corps  
of Engineers**  
Huntington District

# Questions ?

**Michael McCray**

**Phone (304) 399-5234**

**E-mail [mikem@mail.orh.usace.army.mil](mailto:mikem@mail.orh.usace.army.mil)**

