



Operating Guide

www.photonsoundbeam.org

Congratulations on choosing to purchase the Photon Sound Beam Complete. By doing so you now have the assurance and peace of mind that comes with purchasing a device built and tuned to the highest quality and performance standards, and backed by a comprehensive 2-year warranty. We hope you enjoy using the Photon Sound Beam Complete for many years to come.

Warning

Do not use the Photon Sound Beam Complete until you have read this operating guide from cover to cover.

Please check for updates to this manual on a regular basis by visiting www.photonsoundbeam.org

17 Dec 2018

Revised 18 Oct 2019

Revised 30 Oct 2019

Revised 7 Mar 2020

Revised 30 Apr 2021

Revised 7 Sep 2022

Contents

1. Introduction
2. Quick Start Directions
3. Practical use of the Photon Sound Beam Complete
4. Application and Usage
 - 4.1 PSB (Photon Sound Beam) Selection
 - 4.1.1 More on positioning of the Glass Plasma Tubes
 - 4.1.2 Program selection settings
 - 4.1.3 An Explanation of the Frequencies and their Historical Application
 - 4.2 Application and Usage – Zap Selection
 - 4.3 Application and Usage – Aux Selection
 - 4.4 Application and Usage – IR (Infrared)
5. Typical Exposure Times for PSB, Aux and Zap
6. Special Protocol for Pets
7. Contraindications and Precautions
8. Troubleshooting
 - 8.1 Important Supplement Notes from the Developer
9. About the RF Sound Probe
10. Quick Specs
11. Warranty
12. Disclaimer

1. Introduction

The Photon Sound Beam Complete is the latest in plasma technology. It builds upon the techniques and technologies by many of the innovators in this field, such as Rife, Lakhovsky, Abrams, Skilling, Beck, and everyone's favorite: Tesla. In fact, his is what enables us to create the plasma that can be applied when using this device.

The Photon Sound Beam Complete uses high-voltage, low-current to energize Teslalike coils to create non-thermal plasma, also known as cold physical plasma. The gas mixtures in the glass tubes glow when activated, thus creating plasma. They are modulated with various frequencies, in an attempt to achieve specific results for the user. The effects of plasma on the body have been studied by doctors around the world for many years, for their many potential benefits to the body.

2. Quick-Start Directions

Unpack the Photon Sound Beam Complete, and its accessories, and place them on a sturdy surface, such as a hard table, or stable shelf. The glass plasma electrodes are just that, glass, so please take care not to hit or drop them. It is recommended that you use a low-lying table such as a coffee table over a carpeted area to minimize potential damage to the tubes in case they are dropped. They are somewhat sturdy, but they are still glass. Make sure to set up in a comfortable space, with room for the various cords to run where they won't be bunched together or cause anyone to trip on them. If cords *must* cross each other (something we do not recommend), please do so in a perpendicular fashion, to minimise potential electronic interference. Please do not place cell phones, laptop computers, or other electronics next to the device or the glass plasma electrodes.

First, make sure the unit is switched OFF (the round “Power” button is a push-on, push-off style: if the button is recessed in it’s housing, it is in the ON position; depress it to turn it off), the power supply is unplugged from your wall or power strip AC connection, and the Intensity knob is turned off (if the pointer on the knob is set to below “1”, it is off, otherwise turn it counter-clockwise until it clicks). The power supply round plug gets inserted in the jack on the rear of the console, as shown in the photo below.





The Radio Frequency Sound Probe (RF Sound Probe, or RFSP for short) plugs into the headphone-style jack on the right, labelled “RF Sound Probe” (see below).

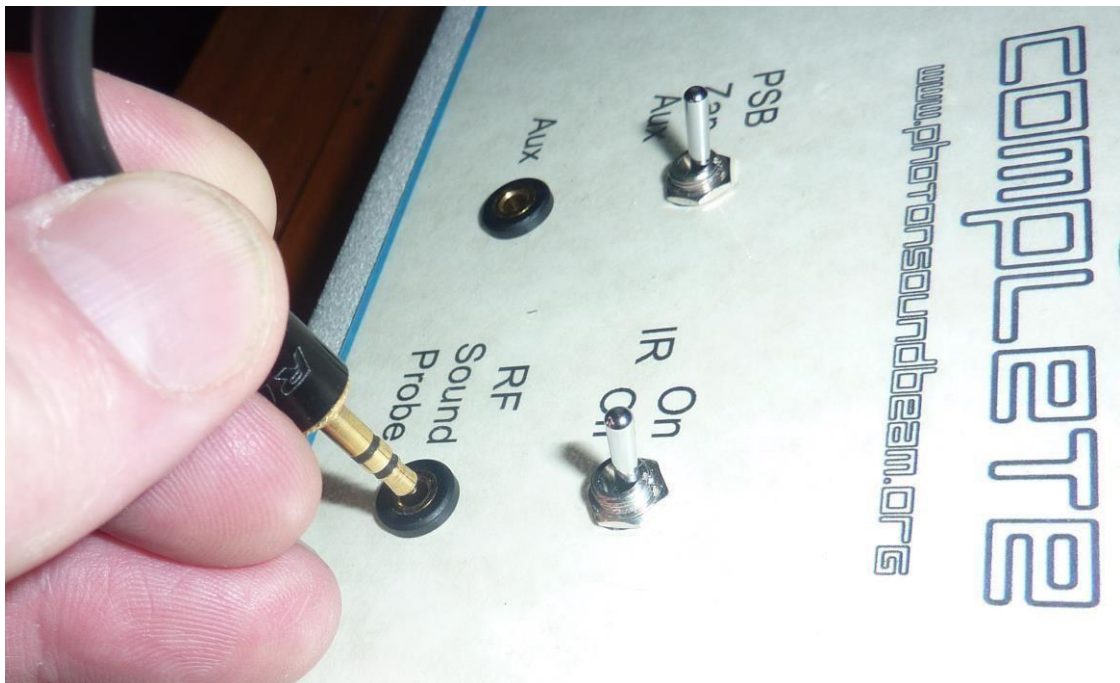

The glass plasma electrodes are plugged into the two connectors on top of the device.



After inserting the plug, turn the collar on the plug clockwise to lock the plug into position.



If using the optional AUX connection, the male-to-male stereo connector plugs into the headphone-style jack on the left, labelled “Aux”. Plug in the power supply to your AC connection, and you are now ready to go.

Select your desired function:

- PSB (with desired Program). *Note:* The most popular programs for general health maintenance are programs 1 and 2, which are general sweep functions covering the most common frequencies over a 30-minute period.

- Zap
- Aux

These can be selected with the mini toggle switch.



Depress the Power button, it will glow pleasantly, and you are now ready to go!

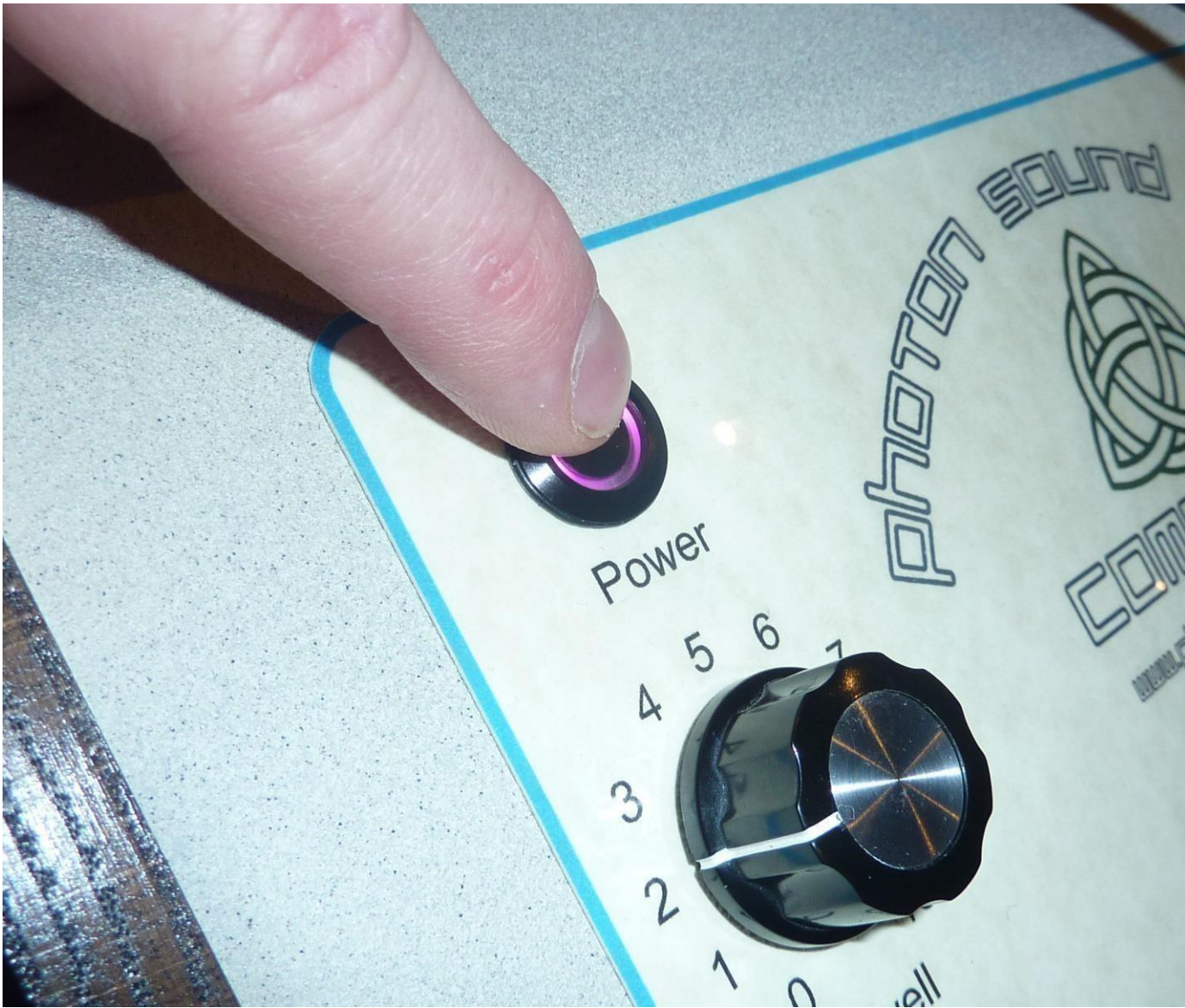

Next: Notes for use, and What do these dials do?

3. Practical use of the Photon Sound Beam Complete

Considerations

We realize that Photon Sound Beam Complete users would like all available information possible in order to make the most effective use of the unit. Please keep in mind that the Photon Sound Beam Complete is an experimental technology and

we are not allowed to make any medical claims or suggestions for use with various medical conditions. Ultimately, the Photon Sound Beam Complete is best considered as powerful “energy supplement” with both nourishing and allopathic benefits. It is important to practice good preventive health through proper diet, exercise, and a positive life-style.

It is very important for the individual to drink 8 to 10 large glasses of clean, pure water every day in order to assist in the elimination of toxins from the body. Failure to eliminate the toxins from the body can overload the various eliminative organs such as the liver and kidneys. *Practical*

If the glass plasma electrodes collect dirt or other blemishes, simply use a cloth with light soapy water (damp only, not wet) or wetted with denatured alcohol such as rubbing alcohol or methylated spirits, to clean the tubes.

We recommend that you drink a large glass of water before and after a Photon Sound Beam Complete session, to assist in toxin elimination from the system.

This may also cause the device to malfunction. If this occurs, power-cycle it (turn it off wait 10 seconds and then turn it back on), and it will reset. *Warnings*

- If the user is holding one or both active glass plasma tubes, and another person makes contact with the user, an effect known as capacitive coupling may give the other person a static shock. The user is ionically charged during the plasma process, and even though beneficial ions are created, they are also the cause of that static shock.
- Do not attempt to hold an active glass plasma tube while making adjustments to the Photon Sound Beam Complete, as it is likely that you may receive a harmless static shock.

4. Application and Usage

4.1 PSB (Photon Sound Beam) Selection

When used, the glass plasma tubes are typically placed on opposite sides of the body, such as either hand, torso and legs, or as per your protocol. The RF Sound Probe is also operated at the same program frequencies as the glass plasma tubes. That may be placed in whatever location is desired, or as per your protocol (e.g., if not placing it over a specific issue, then place it behind your back (on bare skin if using IR setting, otherwise with clothing between the RF probe and the patient's body)).



Example

Select a comfortable chair and hold each of the plasma tubes, one in each hand. Place the RF Sound Probe behind you on your lower back with the label facing towards your body.

Let's start with the basics – PSB setting, RF Sound Probe plugged in, “IR” Off (we'll talk about that, soon).

The “Dwell” dial determines how long a pulse is to stay on. A suggested starting point is setting it to 2.

The “Delay” dial determines how long a pulse is to stay off. A suggested starting point is setting it to 1.

The “Program” dial determines which sweeping set of frequencies, or individual pre-programmed frequency the user wishes to output.

The “Intensity” dial determines how strong the glass plasma tubes make plasma. **START** a session at the **LOWEST SETTING**, and then slowly move the level **UP** after the session begins. You will feel a slight sensation which becomes gradually stronger as you turn it **UP** until you reach a level which is appropriate for you. **More is NOT BETTER** necessarily. Half way up is sometimes plenty of strength for an individual.

4.1.1 More on positioning of the Glass Plasma Tubes

The glass plasma tubes can be applied both at the same time at the same location, or at separate locations of the body. The RFSP can also be used with the glass plasma tubes active, or by itself, without the tubes.

A traditional use is to hold both glass plasma tubes, one in each hand, for the duration of the session.

It is typical to work the body in (3) sections: The Upper Torso, Lower Torso, and extremities. The user may also apply them to any specific area of concern.

Upper Torso

When working any torso area, it is common to place the glass plasma tubes in semiopposing areas. For the upper torso place one plasma tube on the left side of the neck, and the other on the right side of the chest (it can be gently held with the under arm). The RF Sound Probe is then placed on top of the abdomen.

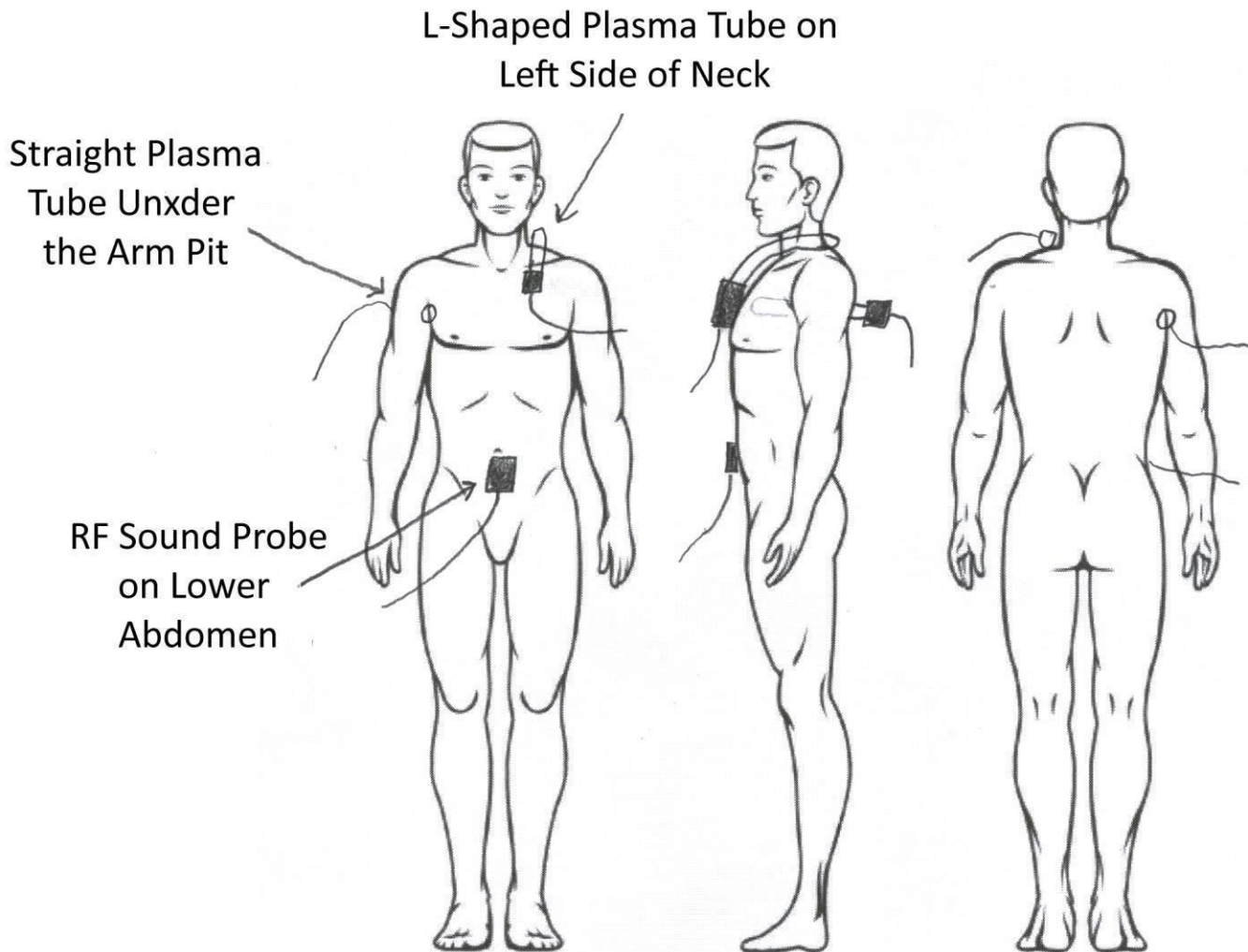

Lower Torso

Move one glass applicator onto the abdomen while placing the other glass applicator flat onto the lower back, groin or other part of abdomen. Move the RF Sound Probe to the upper torso or drape it down onto your upper back.

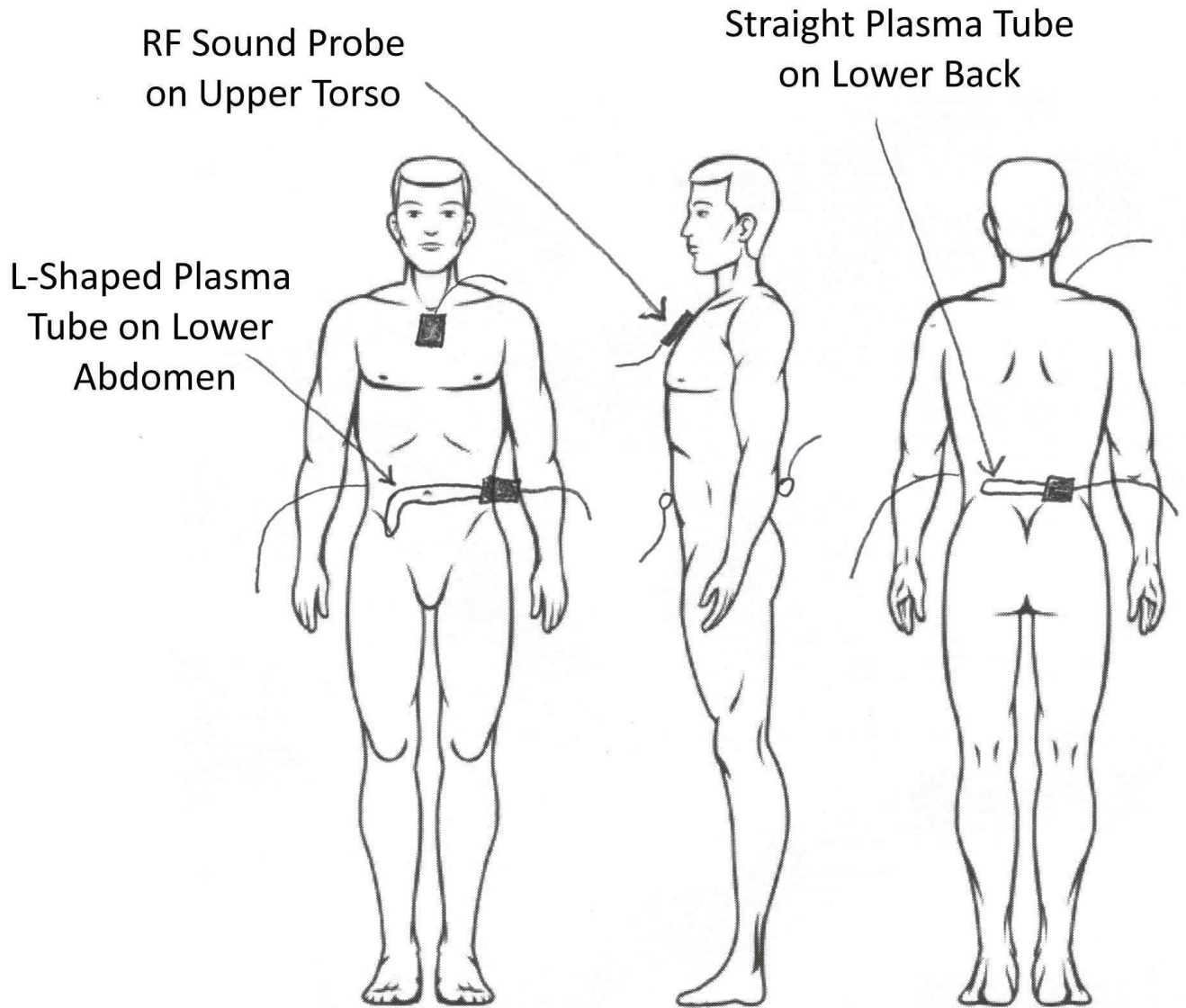

Extremities

Hold both of the plasma tubes, one in each hand. Ensure you are holding the glass section of the tube. Drape the RF Sound Probe over your shoulder to your lower back with the label of the probe facing towards you.

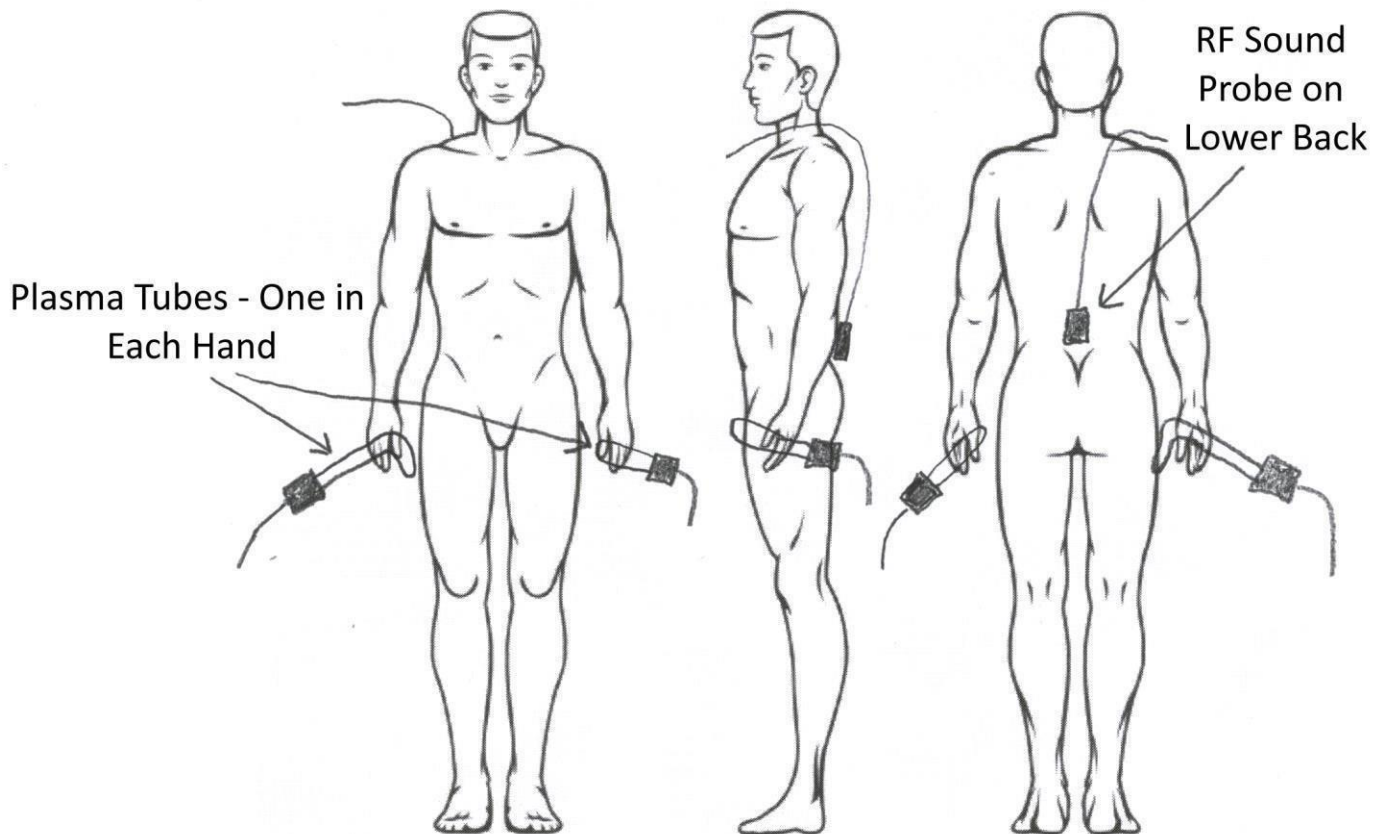

Holding onto the Glass in each hand, provides less output to the body than direct application to the torso, because the electrical energy must travel up the arms first. There are many options for placing the Glass Applicators on the body. **REMEMBER:** the entire body is receiving the energy no matter where one applies the Glass.

Any Specific Site of Concern

It is usually best to directly treat a problem area after the Lymphatic System has been opened up by working with upper and lower torso. Generally, one should not exceed 10 minutes when treating a problem area the first time with a lower Comfort Level (level 3-7). The RF Sound Probe can be positioned near the area or by itself at the end of the session. When working a specific, local site, one or both of the glass plasma tubes may be utilized. For example, if applying one to the top of the thigh, it may be beneficial to place the other behind the thigh. The RF Sound Probe can be positioned near the site, or it could be used as a follow-up to the plasma application.

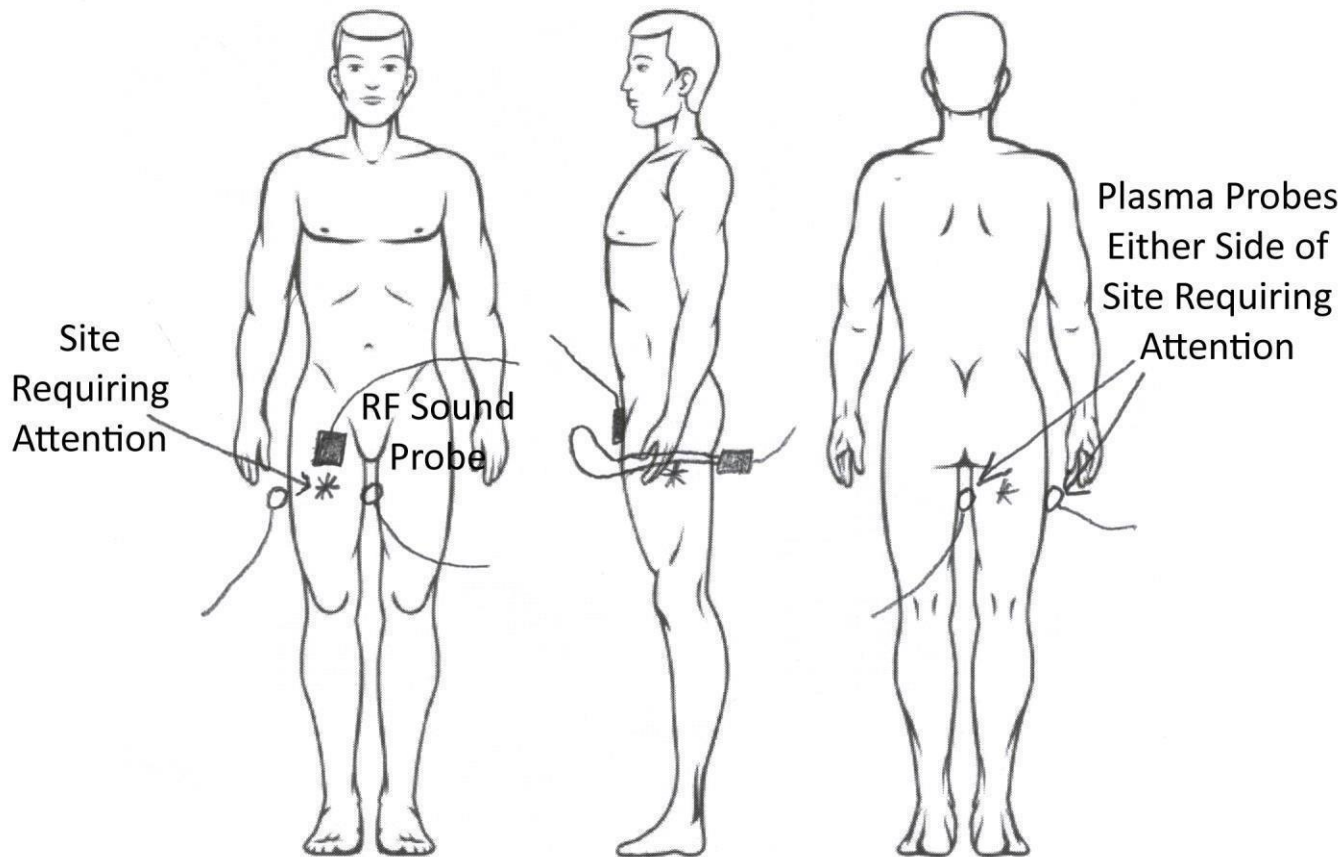

Slowing stroking the skin or moving the electrodes slowly over the skin is also suggested, especially when stroking the face or when applying the Glass to the Abdomen. You may follow the course of the Colon for example by moving the Glass in a Clockwise direction around the perimeter of the Abdomen.

Note that it is not necessary to hold the tubes tightly. The active energy field will travel all over the body, so feel free to experiment with whatever seems to work best for you. Use whichever glass plasma tube shape works best for your session, since the differing shapes allow for varying points of application – one may fit better than another.

When the distance between the two Glass Applicators is small, the energy is the strongest. Each applicator is alternating a positive and a negative energy, but it is always best to use BOTH GLASS APPLICATORS during a session to maximize the output to the body.

When using both tubes at once, on different parts of the body, an interference pattern can be generated. This is akin to where the energy broadcasts cross each other, at a more

local point. Imagine a line connecting the two glass plasma tubes, now put the area to receive the energy roughly at the mid-point of that line. Interference patterns (interferometry) has been studied to reduce pain and inflammation, as well as other benefits.

A known effect that may result in a mild static shock to an onlooker who happens to make physical contact with a user, is known as capacitive coupling. Although harmless, it may feel uncomfortable.

4.1.2 Program selection settings

When running any of these programs, observe *typical exposure times* when running this program in the article later in this document.

- 1) Classic Sweep. These frequencies are pulsed five times in a row, before going to the next frequency. They are as follows:

0.5, 3, 4, 5, 6, 7, 7.8, 8, 11, 13, 15, 17, 20, 122, 141, 222, 232, 322, 333, 421, 432, 441, 444, 522, 532, 550, 660, 697, 727, 728, 780, 787, 850, 880, 1550*, 2008, 2127, 2128, 2150, 2170, 2890, 2929, 3000, 5000, 6870, 8768, 10000.

- 2) PSBC Sweep. These frequencies are pulsed five times in a row, before going to the next frequency. They are also overlaid with a unique set of Bini frequencies, for enhancement. 50% of the energy delivered is in the form of the individual frequency listed, whereas the other 50% is in the form of the Bini group of frequencies. Program 1 is different in that 100% of energy is in the form of the selected frequency, and 0% in in the Bini group of frequencies. The sweep frequencies are as follows:

0.5, 11, 8, 7.8, 7, 6, 5, 4, 3, 728, 222, 141, 2150, 322, 333, 421, 432, 727, 728, 441, 232, 522, 532, 444, 550, 2929, 3000, 660, 697, 780, 787, 6780, 850, 880, 13, 15, 17, 20, 1550*, 2008, 2127, 2128, 122, 2170, 10000, 2890, 728, 5000, 8768.

- 3) 7.83Hz
- 4) 660Hz
- 5) 728Hz
- 6) 787Hz
- 7) 880Hz
- 8) 1550Hz
- 9) 2008Hz
- 10) 2128Hz
- 11) 2929Hz
- 12) 5000Hz

* Note: The 1550 frequency was added to the sweep functions from Jan 2020 onwards.

The historic uses for these frequencies are shown below. There is also a special carrier wave designed to maximize the output of the above Program frequencies.

4.1.3 An Explanation of the Frequencies and their Historical Application

The following is a list of frequencies and some of their historical application. The first application mentioned below for each frequency were those discovered in the 1930's. Other symptoms that are listed were those derived from the use of Metal Electrode Rod/Plate instruments since the 1950's (Reference: Townshend Letter for Doctors').

These applications should not be construed as absolutes. Each person's physiology and situation is unique. This is why Applied Kinesiology (muscle testing), dowsing, or some other diagnostic tool is highly recommended for determining your body's unique requirement at any given moment in time. It is recommended for determining your body's unique requirement at any given moment in time. It is suggested that you listen to your body, use what feels the most comfortable, and follow your intuition.

There have been many changes since the 1930's. Many understand that the laws of nature are rapidly changing. Individuals, individual diets, the environment, and micro-organisms have changed and continue to change dramatically.

Microorganisms have been subjected to and onslaught of antibiotics to which they are continually adapting. We all live in an environment heavily polluted by an electromagnetic and radio wave "soup" (by an estimated 20 million times of that 60 years, ago). There has been adaptation by both humans and micro-organisms to survive. Therefore, use your own discretion.

If in doubt use "5" since this frequency is the most time-tested and the most universal. Frequency Settings 4-12 are all in the Mid-Audio Range or are called Universal Rife Frequencies capable of addressing any issue. 3 is an Alpha frequency, below our hearing range, but derived using a carrier frequency. You may also consider going through all of the frequencies either during a single session or a new frequency each session. Again, always listen to your own body; respect the creative intelligence of your unique physiology. Settings 1 and 2 automatically cycles all frequencies pulsing them each 5 times.

Photon Sound Beam Complete Frequency Settings: 1

Classic Sweep of all frequencies

- 2 Classic Sweep of all frequencies with Bini frequencies included (50% energy on the frequency progression of program 1 and 50% on the grouped Bini frequencies
- 3 (7.83) Earth resonance, Schumann resonance, universal well-being, tolerance to stressful situations.
- 4 (660) Treponema, bacterial infections, fatigue, gonorrhoea, prostate, stomach, syphilis, ulcers
- 5 (728) Universal Use, staphylococci, arthritis, bladder infection, blood pressure, candida, cataract, cataract, eye, cervical C, mold and fungus, influenza, eye disorders, gallstones, lumbago, parasitic colon, pharyngitis, pneumonia, prostate, stiff muscles, stomach, tinnitus
- 6 (787) General Use...bacterial infection, Candida, gonorrhoea, syphilis, abscesses, heartburn, dental infection, intestinal problems
- 7 (880) Streptothrix, arthritis, bladder infection, Candida, cataract, melanoma, chronic fatigue, parasitic colon, pharyngitis, influenza general, pneumonia, measles rubella, tinnitus, ulcers
- 8 (1550) Streptococci, arthritis, bladder infection, blood pressure, diabetes, breast C, haemorrhoids, sore throat, tonsillitis, urinary tract infections, irritable bowel, prostate, sinusitis, gingivitis/dental infection
- 9 (2008) E-coli, melanoma, leukaemia C, orchitis, fibroids, prostate, pancreas
- 10 (2128) Carcinoma skin cell, general C, prostate C, non-Hodgkins, Diabetes 2, melanoma, breast C, Candida carcinoma, intestinal parasites, prostate
- 11 (2929) Immune system stimulation, Classic Rife
- 12 (5000) Immune system stimulation/stabilization, general malady, general antiseptic, Class Rife

After running any program, at the end of the session always switch to another random program to disassociate your body with the exposed treatment frequencies. The RF

Sound Probe always copies the program that is being used by the Photon Sound Beam Complete, whether one uses the PSB, Zap, or Aux settings.

4.2 Zap Selection

It has been estimated that the average adult male is unknowingly contaminated with up to 2 pounds of parasites in the blood and bodily organs. There is an association between parasites and disease that is being progressively discovered and confirmed in scientific and medical circles.

Through removing the hidden parasites in our body, we clear the way for our own body's immune system to get to work and conquer disease.



The Zap function on the Photon Sound Beam Complete uses 2500Hz and associated harmonics frequencies including the amplified 11th harmonic (227.27272727Hz) for assisting in destroying bacteria, viruses, fungi and other bodily pathogens, similar to many other zappers which are available today. The 11th harmonic of 2500Hz was introduced to our system on April 30 2021, and it is a particularly important synergism that powers the zap function, and is explained in the video shown on <https://www.youtube.com/watch?v=mBL9pS6GMdA>. It is our belief that this zap function has the most powerful delivery system through use of the plasma tubes, when compared with any other zapper available on the market today.

This selection does not utilize the Program dial, but the user MAY alter the base program using the Dwell and Delay dials. For standard usage, follow these steps;

- 1) Select the Zap function using the switch on the Photon Sound Beam Complete.
- 2) Set Dwell and Delay to zero.
- 3) Power the unit on.
- 4) Set Dwell to 2 and delay to 1.
- 5) Apply glass plasma probes and RF Sound Probe as required (e.g., plasma tube in each hand and RF Plasma Probe on lower back. The applicators will pulse on and off.

For advanced users, the Dwell and Delay dials are active, and will produce on and off pulses similar to the PSB function, once turned a little above “0”.

Once activated, an internal timer keeps the Photon Sound Beam Complete active with a 2500Hz frequency, which is used in other electrical-only devices. Plasma is a much more energetic thing, and penetrates the body well.

The timer is set for 28 minutes. Once the session is complete, the Zap function stops. The user may select the other settings, but the device must be power-cycled (switched off wait 10 seconds then switch back on again) to reset the internal timer.

Selecting Aux allows a user to connect their computer sound card (via the computer headphone or line-out ports), or other line-level audio device to the Photon Sound Beam Complete and run their own custom program, or other commercial software such as;

- Sirius Frequency Generator Software (Recommended). Sirius can be purchased online by visiting <https://www.naturesenergieshealth.com/collections/software/products/sirius-dr-rife-frequency-generator-software>



The Sirius software will deliver frequencies for specific diseases, as researched by people such as Dr. Royal Raymond Rife, and Dr. Hulda Clarke. We recommend using this system for applying specific frequencies and/or disease frequency groups through the Aux channel on the Photon Sound Beam Complete. The Sirius Software gives options where you can select the form of the wave being applied (i.e., sin wave or square wave). We recommend when applying the frequencies through the Aux port that you select the square wave option. (The sine wave option is better when applying the frequencies through speakers).

Practical Notes

Use a 3.5mm male to male stereo cord to connect the required sound device from your computer's headphone or line-out ports to the Aux port on the Photon Sound Beam Complete. If you do not have a 3.5mm male to male stereo cord, you can easily purchase one for only a few dollars from eBay or your local stereo store or electronics supplier.

If using the line-out port (marked as "audio out" on some computers), generally it is best to set volume on your computer to maximum, which will activate the Tesla Coils in the Photon Sound Beam Complete. This is due to internal isolation to help protect the computer/Photon Sound Beam Complete connection.

If connecting to your computer's head-phone jack, adjust volume to the lowest level first, then check for pulsing in the plasma tubes as you adjust the volume higher. If the volume is too low, there will be no pulsing in the tubes; then as you adjust volume higher, pulsing in the tubes will start. Head-phones typically have louder signals than "Line Out", so please adjust accordingly. Start with a lower volume, like 2 out of 10, then increase it until the desired intensity may be reached for pulsing in the tubes to begin. Headphone and speaker levels vary between devices, so experiment with yours. When using computer apps, they sometimes have an additional volume setting that also needs adjusting.

Lets look at some typical outputs on a computer. On a desktop computer, if you look at the back of the computer you might typically have a built in sound card which looks like the following;



The sound outputs are shown. On this set up, you would typically plug the lead into the green port which is usually the audio "line-out" port. The green port is usually the output on sound cards as well.

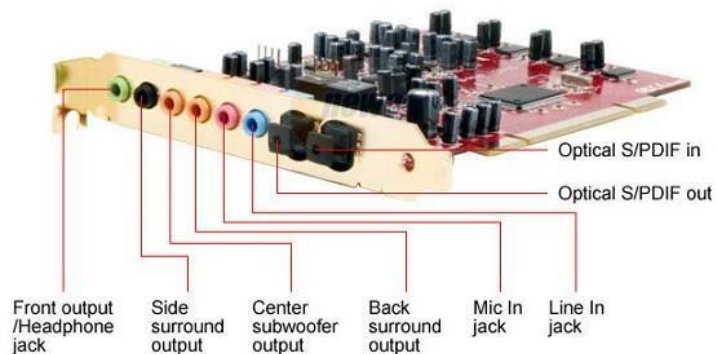

If after plugging the lead into this port, a window appears on your computer, you might typically select "Front Speaker Out" followed by "Next" and "Auto"..

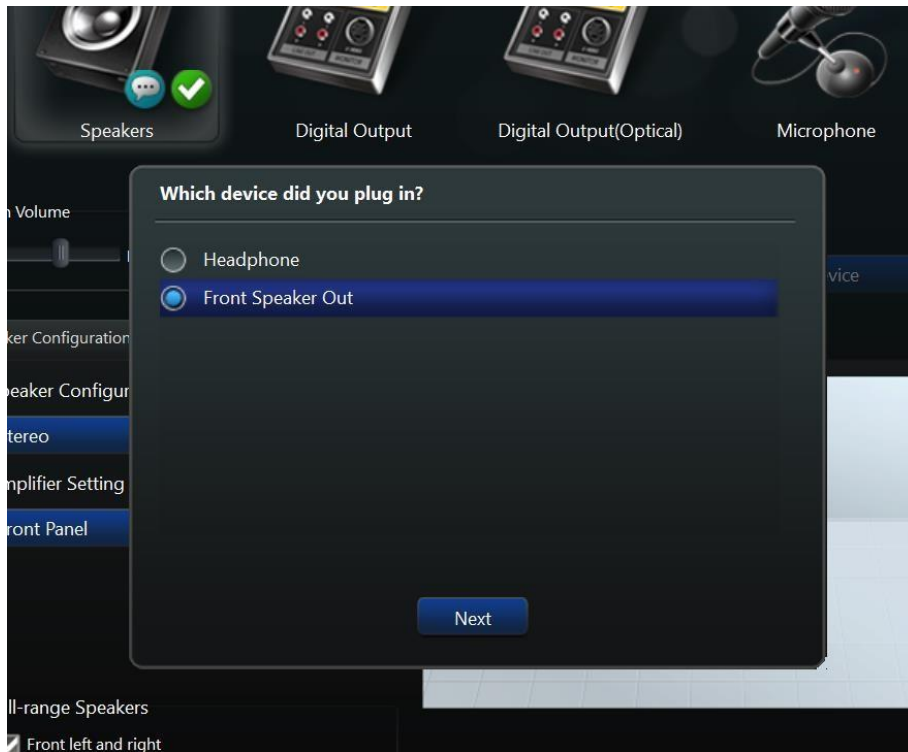

If you are using a Laptop, you might typically have audio ports on the side of your computer as follows;



The green port is again usually the Line-out port.

We generally recommend that you use commercial software such as Life

Frequencies Pro (see <https://www.naturesenergieshealth.com/products/life-frequencies-pro-3-single-licence-for-one-computer>) to generate frequencies, but if you prefer using custom frequencies generated by other means, it is best to include a carrier in the middle-range of hearing, because the Tesla-like coils respond better to those. If one is using multiple frequencies at once, which is typical, they should work fine. Experiment!

Note: Aux is always “on”, meaning you can add your custom frequencies to both the PSB and Zap selections as well, although Aux is not controlled by the Dwell or Delay dials at any time. This means that during pauses, only the Aux signals will be generated.

Disconnect the Aux cable when not using that function, as it may sometimes act as an antenna, causing undesired operation. *Procedure*

- 1) Refer firstly to the Practical Notes above and connect the Aux Port to your computer.
- 2) Select Aux on the Photon Sound Beam
- 3) Set Dwell and Delay to zero BEFORE POWERING THE PHOTON SOUND BEAM COMPLETE ON. This is very important.
- 4) Set volume on your computer to maximum output.
- 5) Start the computer program.
- 6) Power on the Photon Sound Beam Complete.
- 7) Adjust Dwell and Delay so that the signal pulses on and off (e.g., set dwell to 2 and delay to just a little higher than 1). Set intensity to 10, or adjust it to a lower comfort level if need be.
- 8) Apply the glass plasma probes and RF Sound Probe as required (e.g., upper torso, lower torso, extremities or focused in one area).

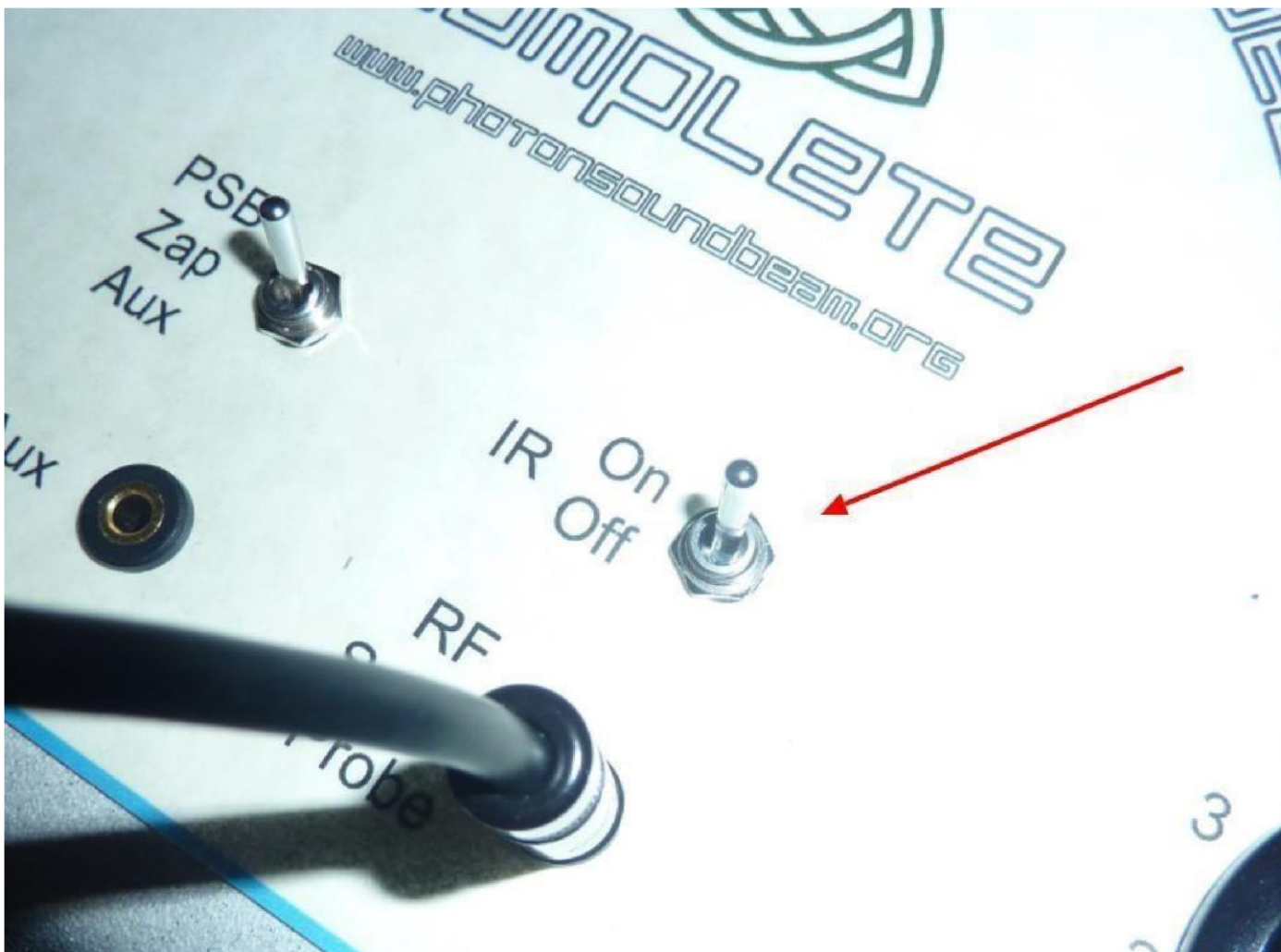

An extra feature of the Photon Sound Beam Complete is the addition of two pairs of infrared LED light generators in the RF Sound Probe. These are designed to penetrate 1-2 centimetres into the skin and surrounding tissues. One pair is near infrared, and is visible as a rich, red light. The other pair is far infrared, and is visible with many digital or cell phone cameras.

As with any light source, clothing and other coverings will block the IR light, so bare skin is needed when using the IR light source.

The IR light may be switch on or off at will, and like the RF Sound Probe, copies any running program.

About Far Infrared (FIR)

The sun emits many kinds of natural light, only some of which are visible. Infrared light has a longer wavelength than the visible spectrum and thus cannot be seen by the naked eye.

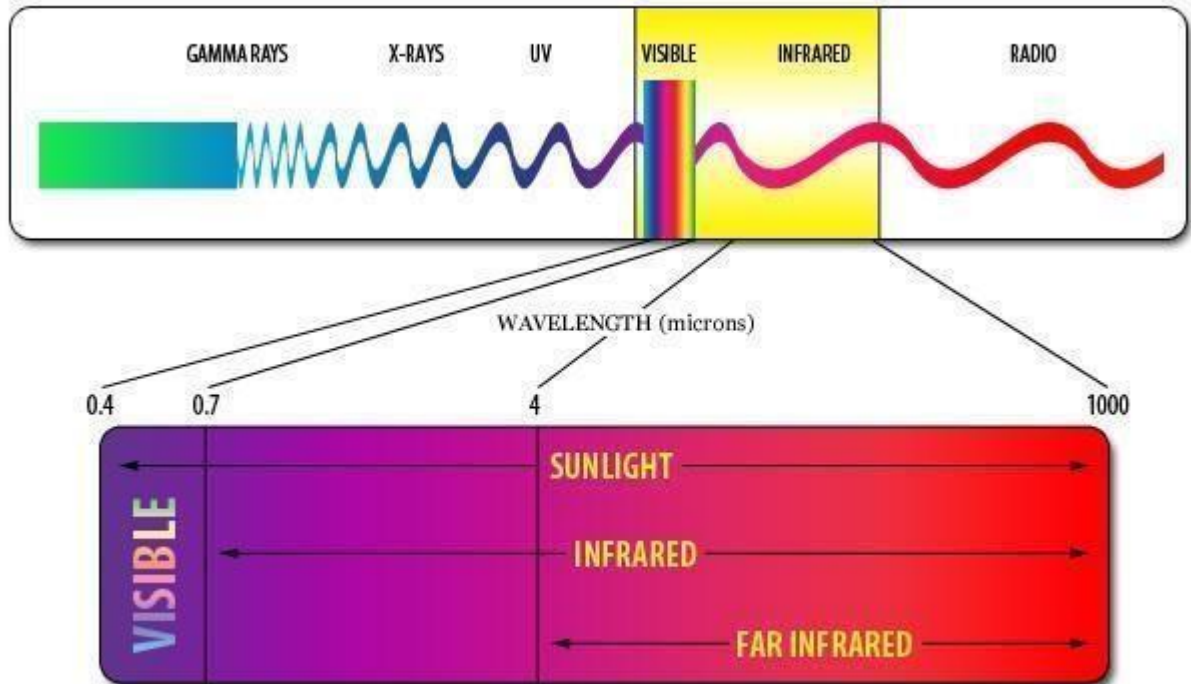

Far infrared rays (FIR) have the longest wavelength of any kind of infrared light, and thus are the only kind of infrared light that can deeply penetrate the human body. When emitted by the sun or from the Bioenergy pendant, FIR penetrates through the skin to the subcutaneous tissues and is transformed from light energy into heat energy, bringing about many beneficial effects:

Promotion of blood circulation and warming of the body, which helps relieve neuralgia (nerve pain), muscle aches and joint pain, as well as remedying cold hands and feet

Revitalization of cells, which promotes wound healing and helps restore tissue damaged by inflammation
Increased metabolism

- Relief from stress and fatigue
- Regulation of the nervous system
- Promotion of sound sleep
- Purification of bodily fluids and elimination of harmful toxins

- Strengthening of immune function
- Promotion of healthy growth and development in human beings and animals

At its normal core temperature, the human body emits heat energy at a wavelength of 5-15 microns. A FIR energy wave of similar length is emitted when natural stone - such as tourmaline or zeolite - is heated. Some studies have shown that FIR energy emitted from stone can penetrate organic matter 80 times deeper than other heat waves.

The heat from FIR resonates with the body's own energy waves to warm the body, improve blood circulation, and boost metabolism. FIR energizes the body at the cellular level. For this reason, many hospitals and clinics in Japan treat patients with medical devices that generate FIR. In addition to their positive effects on circulation and metabolism, far infrared rays also improve the function of the autonomic nervous and endocrine (hormone) systems, resulting in a better state of health.

FIR Therapeutic Mechanism of Action Explained

The FIR inlay releases far infrared wavelength emissions into the body. These have an effect on water molecules as well as the arterial system within our body as explained in the following diagrams;

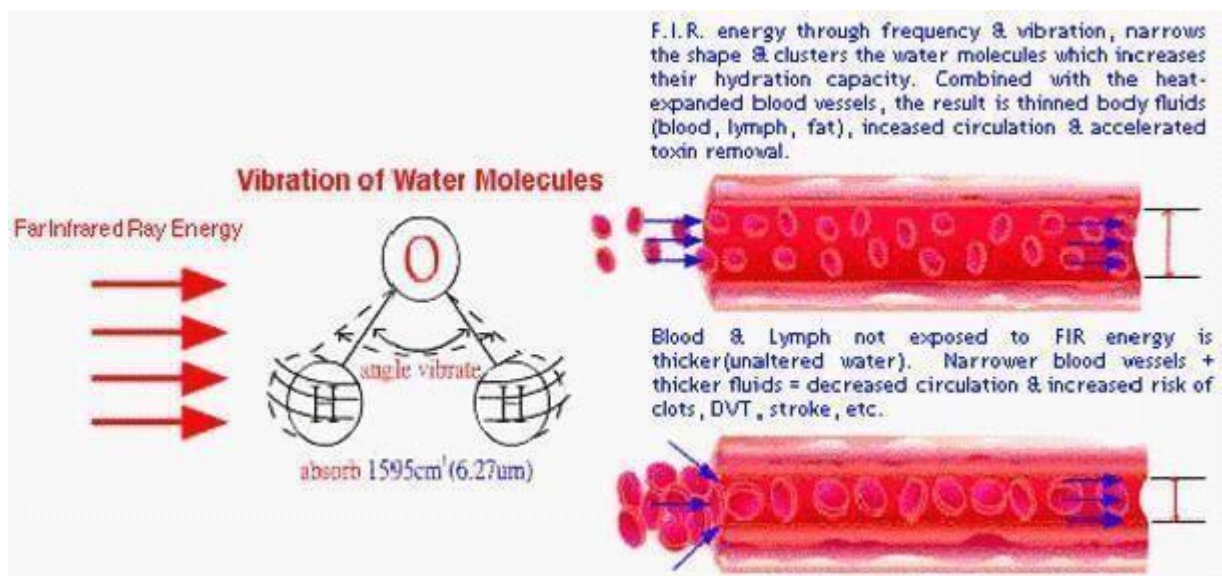

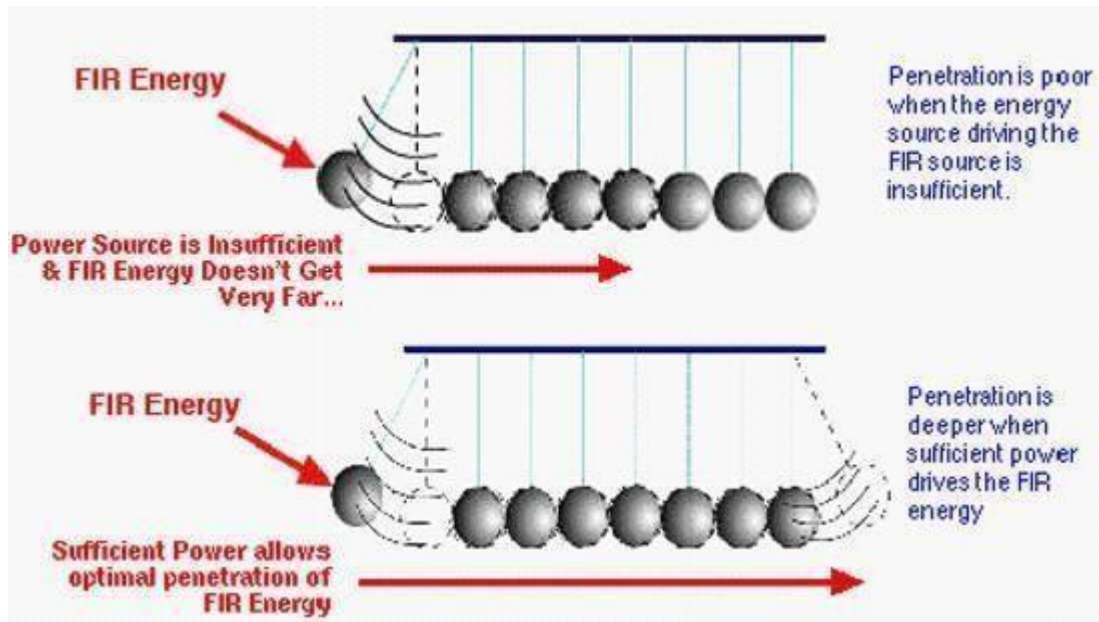

Accelerate blood circulation

As a result of the FIR reaction, and due to the increase in the temperature of deep skin, and the expanded microvascular system, there is an accelerated blood circulation, consolidated blood and cell metabolism, and this in turn results in an improved youthful appearance.

Adjust blood pressure

High blood pressure and arteriosclerosis are usually caused by contraction and narrowing of small arteries. Far infrared helps to expand the microvascular system, thereby accelerating blood circulation and reduce high blood pressure, resulting in improved hypotension symptoms.

Improve arthralgia

Deep penetration of far infrared can reach deep into muscle joints, thereby warming the inner body, relaxing muscles, leading to an exchange of oxygen and nutrients of the microvascular system. It can also purge accumulated fatigue substances and lactic acid as well as other aging wastes, and has excellent effects for eliminating turgescence (swelling) as well as easing pain.

Adjust autonomic nerve

The autonomic nerve mainly regulates visceral functions. Humans are often in a state of anxiety, and the autonomic nerve is as a result kept tense. This results in low immunity, headache, insomnia, fatigue and cold extremities.

Reduce fattiness

Far infrared therapy can result in an energy increase, as well as cell activation, thus promoting adipose tissue metabolism, burning and decomposition, resulting in consumption of excess fat. The end result over time is the effective loss of weight.

Strengthen liver function

The deep heat reaction from deep within the body resulting from far infrared can activate cell, enhance tissue regeneration capacity and promote cell growth, thereby strengthening liver detoxification, improving the body environment resulting in an improved physical condition of the body.

Promote metabolism

Once the microcirculatory system has improved, metabolic waste can be rapidly excreted from body, reducing the burden on organs such as the liver and kidney. Such waste includes heavy metals that can cause cancer; lactate, free fatty acids and subcutaneous fat that can cause fatigue and aging; and uranium ions that can cause hypertension.

Balance body's PH

Far infrared can purify blood and improve the quality of skin, to prevent excessive uric acid that can cause bone pain and arthralgia (joint pain).

5. Typical Exposure Times for PSB, Aux and Zap

Remember, these are general schedules, which can be varied with specific needs and tailored to your own regime:

1) **'Well' Balanced Person:**

30 minutes 1 x day for 1-3 days

30 minutes 2 x a day for 1-2 weeks (AM & PM) If desired, increase or maintain as above.

2) **Moderately Imbalanced Person:** 15 minutes

2 x a day for 1-3 days

30 minutes 2 x a day for 1-2 weeks 30 minutes

3 x a day for 1-2 weeks 30 minutes

4 x a day for 1-2 weeks

3) **Seriously Imbalanced Person:**

Best to do short exposures initially with periods of rest in between.

5 minutes 4 x a day for 1-3 days

10 minutes 4 x a day for 1-3 days

15 minutes 4 x a day for 1-3 days

20 minutes 4 x a day for 1-3 days

30 minutes 4 x a day for 1-3 days

If time is of the essence, consider 10-15 minutes every 1-2 hours (with plenty of good water). Try to give your body a day or two to flush out in between treatments.

Important: Always remember to drink purified water before and after each session to help toxin elimination. It is well worth considering a good liver cleanse as well to assist your body in detoxifying to eliminate toxins after treatment from your body.

6. Special Protocol for Pets

This is a brief guide for veterinary application or any application for pets of any kind.

The ideal setup is for the animal to be already resting.

This makes it easier to place both plasma tubes underneath their bedding or within a few inches of them -- one applicator on each side of the body. Exact positioning is not necessary. Specific application sites are relative to the issue of health.

Applying the Glass Applicators directly to the body can be done but is generally not recommended as it may scare the animal with a sensation it is unfamiliar with, preventing future treatments. If all the same you use direct contact, avoid the animal touching the glass with their noses.

The black applicator (RF Sound Probe) should be used directly on the site of concern or in triangulation with the 2 Glass Applicators. The RF Sound Probe may be used alternatively by itself without the plasma tubes, which is ideal for preventing the animal from becoming frightened.

The output level for the Glass Applicators with the "Intensity" dial should begin below 4 or 5 on the dial. Higher levels should be used with larger distances away from the animal further than approximately 1 foot.

Treatment durations are variable depending upon the health of the animal. If this is a critical stage 3 or stage 4 issue, care must be exercised in not treating the animal for too long a period of time can causing too much detoxification.

You can refer to the treatment times in the section "Typical Exposure Times". If the Glass Applicators are not making direct skin contact, treatment times can exceed those mentioned.

Care must be taken to avoid too much time ~ a couple or more of hours is usually OK at a few inches to a foot distance, but direct contact should not exceed one hour. NOTE: the output level of the RF Sound Probe is preset; the "Intensity" dial only affects the Glass Applicators.

Make sure the electrode wires are untangled and not touching each other before proceeding. You may clean the glass portion of the electrodes with a mild soap and water, or simply spray and wipe with alcohol or glass cleaner. We suggest you wet some paper towelling or cloth FIRST and then wipe the Glass. A clean electrode can only enhance the penetration of the output energy. Avoid liquids on the front panel of the Console, especially labels.

7. Contraindications and Precautions

- Do not use on subjects with cardiac pacemakers or defibrillator or similar medical devices, or products that are affected by electricity.
- Do not use near a computer or any sensitive software (at least 4 feet is recommended).
- Do not use during pregnancy
- Use caution using glass probes with sensitive skin conditions such as burns, recent scars, wounds, cuts, or sunburn as this may cause irritation.
- Do not advance output amplitude dial to uncomfortable levels. High levels are not necessary to achieve beneficial results.
- Glass probes are designed for external use only.
- Use minimum pressure in applying the glass probes against the skin. The L shaped glass plasma tube may break if applied with too much pressure.
- Whenever possible, remove any jewellery and metal when using the glass probes.
- Do not touch others or allow them to touch you when operating the PSB glass probes as both parties may receive a mild (harmless) shock. When using with an assistant, the second person may choose to wear rubber gloves. This has been greatly minimized with the new Photon Sound Beam Complete output
- Be aware of children or pets when using the PSBC as they may run into extended cords and lines.
- Always place the glass plasma tubes down and ensure the white high voltage wires are not touching you BEFORE turning the power off, to avoid a harmless static shock.

8. Troubleshooting

You may occasionally experience one of the following problems with your Photon Sound Beam Complete;

1. In the middle of a session, the power on sound is heard as if the unit has just been switched on.
2. The unit stops pulsing

If either of these issues occur, you will need to check the following;

1. Check that the leads are not crossing one another. It is particularly important not to let either of the white leads cross the black lead going to the RFSP unit. We generally recommend that each of the white leads go off the left and right side of the unit, and the black lead can then run over the back of the unit to where it is required, allowing the white lead plastic plugs to isolate it.

It is important also to ensure that none of the leads (in particular the white leads) are touching the knobs.

An example of this recommended setup is shown in the following picture;

2. When using the Aux function, turn the Dwell and Delay dials to zero **BEFORE TURNING THE UNIT ON**. (The developer says that it is good practice to do this for the PSB and Zap functions as well). You then start the computer program to send the frequencies into the Aux input, and then slowly turn the Dwell and Delay knobs to your desired setting. A starting setting is delay on 1 and dwell on 2.



3. If using an adaptor to convert the power plug from USA parallel pins to your local country electrical plug requirements, ensure that you use a very good quality adaptor. We have seen examples of some people using a poor-quality adaptor without a firm connection, which has resulted in the machine constantly re-starting (indicated by the sound that the machine makes when you press the power on button). It is important that there is a firm connection to the electrical outlet that you are using.
4. Whenever you are NOT using the Aux function, ensure that the Aux lead is NOT PLUGGED IN. If it remains plugged in, it can act as an antenna and collect radio signals which may interfere with the program you are running.
5. Check that the power jack at the back of the unit is firmly connected.

8.1 Important Supplement Notes from the Developer

29 April 2017

Before choosing a selection, either PSB, Zap, or AUX, make sure the power is off, and the Intensity dial is turned anti-clockwise to off.

The knob's painted indicator will point towards the operator. Make the selection, and power on the device. This will ensure smooth operation of the device, as well as remind the operator what will be happening when the device is powered on.

Do not attempt to activate the Intensity dial without having the plasma electrodes plugged into the high-voltage ports at the top of the device.

An electric shock can occur if someone is too close to the ports, with the potential for a spark to jump itself to the case, causing the device to restart automatically. Continued sparking can potentially cause the device to damage itself. The plasma electrodes do not need to always be plugged in, but if they are removed, check that the Intensity dial is all the way off.

9. About the RF Sound Probe

The RF Sound Probe is based upon the work of Georges Lakhovsky, a scientist who came to America from France in the 1920's. Two books were written about his work...The Waves That Heal and The Secret of Life. In 1925, Lakhovsky wrote an article in the Feb. issue of Radio News Magazine, in which he stated...."In conclusion I wish to call attention of the reader to the fact that I have obtained very conclusive results not only with a wavelength of two meters, but with longer and shorter wavelengths. The main thing is to produce the greatest number of harmonics possible."

The RF Sound Probe attachment is 2 3/4" wide by 2" long by 7/8" thick. It attaches to the front of the PSB with a plug at the end of a 6 ft. cord. The flat pak produces an electromagnetic signal in the high frequency, short wavelength radio spectrum. This signal can be heard over your FM radio.

The flat pak (black rectangular probe) contains three separate frequency generators, all designed for body penetration and harmonics. This includes the resonance of Oxygen. They are sent to a handmade, scalar-wound, Tesla coil antenna for

increased output and range. The radio energy output is approximately 0.5 watts which is a very safe level, yet still effective due to the proximity of the flat pak to the subject. This signal is modulated at the frequency setting selected on the frequency dial. This combination of frequencies and waveshapes produces the desired harmonic-rich output as explained by Lakhovsky. *RF Sound Probe*

Application Suggestions

- The RF Sound Probe may be placed directly onto the skin, or up to 1-2 feet from the body when used together with the glass electrodes, it should be kept isolated from the glass electrodes to maximize its value as a radiowave carrier of all harmonic frequencies. The RF Sound Probe may also be used by itself or as an energy field “room broadcaster”. It may also be operated overnight during sleep. Individuals report positive results by placing the RF Sound Probe on the body, or at a distance such as the floor, underneath the bed at night, or propped up in a chair 1-5 feet away from the body.
- RF Sound Probe may be used as a “radionic sweep well” to broadcast its scalar, subtle energy into a “witness” such as a blood sample, photograph, saliva, hair, written or verbal affirmation, etc. for absentee energy balancing.

10. Quick Specs

The glass plasma tubes utilize the noble gasses Helium, Argon, and Neon. They are made with HV (High Voltage) wire leads and insulating handles. They also include a blend of paramagnetic minerals in the handles to enhance their effects.

- The glass plasma tubes can also produce beneficial amounts of ozone. Their cords are also 2 meters long.
- Our High Frequency connectors used by the glass plasma tubes combine actual silver and gold wire together for the higher voltage transfer. This standard feature turns any regular glass plasma electrode into one that radiates the energetic vibrations of both gold and silver. Imagine, no need to obtain special electrodes! The power supply is 5 amp @ 12 volts DC, automatic between 100-240 volts AC.
- The higher voltage to create the plasma is generated using two Tesla-like coils in bi-phasic mode, one for each glass plasma electrode.

- The RF Sound Probe contains three separate frequency generators, all designed for body penetration and harmonics. This includes the resonance of Oxygen. They are sent to a handmade, scalar-wound, Tesla coil antenna for increased output and range. Tune a nearby radio to the 108MHz channel, and listen when a program is active! They are also harmonics of each other, in order to generate the high frequency harmonics typically desired for use. Total transmitter output is roughly ½ watt, and at higher frequencies and voltages than competitors.
- The RF Sound Probe cord is 3.5 meters long.
- The RF Sound Probe output may cause interference with other devices, so please experiment with it responsibly.
- The headphone-style jacks are gold-plated, for increased transfer of energy and frequencies, as well extending mechanical wear. The plug on the RF Sound Probe is also gold-plated for that reason. It is also more durable than a plastic connector.
- The console is made with red oak wood sides, with ebony stain and semigloss clear coat; console face painted with sandstone-like finish.

11. Warranty

The Photon Sound Beam has a full 2 year warranty on parts and labor.

Warranty excludes the breaking of the glass portion of the Glass Applicators with the exception any damage to the wire harness.

12. Disclaimer

This product is an artistic creation for learning, self-improvement, spiritual development, simple relaxation, personal experimentation, and is not offered for the treatment or cure of any disease. There is no guarantee of effectiveness for any operations of this device. No statement contained in this catalogue or description, and no information provided by this literature or companion website, should be construed as a claim or representation that this product is intended for use in the diagnosis, cure, mitigation, treatment or prevention of disease or any other medical condition. You should not use any of the information for diagnosis or treatment of any health problem or for prescription of any medication or other treatment. You should not stop taking any medication without first consulting your physician. The information contained in this catalogue or description or companion website is deemed to be based on reliable and authoritative report.

However, certain persons considered experts may disagree with one or more of the statements contained here. Seller/website owner/affiliates assume no liability or risk involved in the use of the products described here. We make no warranty, expressed or implied, other than that the material conforms to applicable standard specifications. Seller/website owner/affiliates do not accept any responsibility for the accuracy of the information or the consequences arising from the application, use, or misuse of any of the information contained herein, including any injury and/or damage to any person or property as a matter of product liability, negligence, or otherwise. No warranty, expressed or implied, is made in regard to the contents of this material. This material is not intended as a guide to self-medication. The reader is advised to discuss the information provided here with a doctor, pharmacist, nurse, or other authorized healthcare practitioner and to check product information (including package inserts) regarding dosage, precautions, warnings, interactions, and contraindications before administering any drug, herb, radionics tool, or supplement discussed herein. Seller/website owner/affiliates' products are for the sole purpose of educating people about intuitive abilities and environmental energies, and are for general information purposes only. The listing of a person, organization or other entity in any part is for convenience only and in no way implies any form of endorsement of the information, products, or services provided by that person, organization or other entity. All concepts, procedures, and technology described herein are speculative, not necessarily approved by any Government agency, and may be hazardous to susceptible or unqualified persons. In all instances, no diagnostic or therapeutic claims are made or implied. Please consult your licensed physician for medical advice. It is a condition of viewing this that you read and agree to the full disclaimer. Thank you for your understanding. The products and the claims made on or through seller/website owner/affiliates' products, emails, publications, or advertisements have not been evaluated by the United States Food and Drug Administration and are not approved to diagnose, treat, cure or prevent disease. Consult a physician before using this product if you have any medical condition whatsoever, or if you have or suspect you might have a health problem, or if you are pregnant, or if taking any kind of medication. In accordance with FDA regulation, we do not make any therapeutic claims regarding the health benefits of any products. If you have any medical problems, please be advised to contact your doctor. No promises, guarantees or warranties, whether stated or implied, have been made that you will produce any specific result as a result of purchasing our products, or using information from our website/email. Information may contain technical inaccuracies or typographical errors. Information may be changed or updated without notice.