



Panasonic®

Operating Instructions Air Conditioner

Model No.

Indoor Unit

CS-E7NKR
CS-E9NKR
CS-E12NKR
CS-E15NKR
CS-E18NKR
CS-E21NKR
CS-E24NKR
CS-E28NKR

Outdoor Unit

CU-E7NKR
CU-E9NKR
CU-E12NKR
CU-E15NKR
CU-E18NKR
CU-E21NKR
CU-E24NKR
CU-E28NKR



Before operating the unit, read these operating instructions thoroughly and keep them for future reference.



QUICK GUIDE

© Panasonic Appliances Air-Conditioning Malaysia Sdn. Bhd. 2012. Unauthorized copying and distribution is a violation of law.

TABLE OF CONTENTS

SAFETY PRECAUTIONS	4~5
REMOTE CONTROL	6~8
INDOOR UNIT	9
TROUBLESHOOTING	10
INFORMATION	11
QUICK GUIDE	BACK COVER

NOTE : The illustrations in this manual are for explanation purposes only and may differ from the actual unit. They are subjected to change without notice for future improvement.

OPERATION CONDITION

Use this air conditioner under the following temperature range

Temperature (°C)		Indoor	
		*DBT	*WBT
COOLING	Max.	32	23
	Min.	16	11
HEATING	Max.	30	-
	Min.	16	-

CU-E7NKR, CU-E9NKR, CU-E12NKR, CU-E15NKR, CU-E18NKR, CU-E21NKR, CU-E24NKR

Temperature (°C)		Outdoor	
		*DBT	*WBT
COOLING	Max.	46	26
	Min.	5	4
HEATING	Max.	24	18
	Min.	-15	-16

CU-E28NKR

Temperature (°C)		Outdoor	
		*DBT	*WBT
COOLING	Max.	46	26
	Min.	16	11
HEATING	Max.	24	18
	Min.	-15	-16

* **DBT**: Dry bulb temperature

* **WBT**: Wet bulb temperature

SAFETY PRECAUTIONS

To prevent personal injury, injury to others, or property damage, please comply with the following. Incorrect operation due to failure to follow instructions below may cause harm or damage, the seriousness of which is classified as below:

 **WARNING**

This sign warns of death or serious injury.

 **CAUTION**

This sign warns of injury or damage to property.

The instructions to be followed are classified by the following symbols:









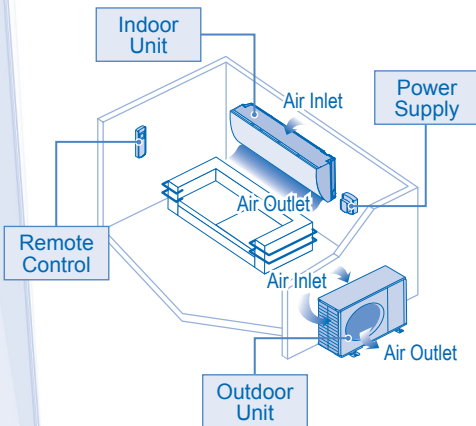

This symbol denotes an action that is PROHIBITED.



These symbols denote an actions that is COMPULSORY.



 WARNING	
INDOOR UNIT AND OUTDOOR UNIT	
	<p>This appliance is not intended for use by persons (including children) with reduced physical, sensory or mental capabilities, or lack of experience and knowledge, unless they have been given supervision or instruction concerning use of the appliance by a person responsible for their safety. Children should be supervised to ensure that they do not play with the appliance.</p> <p>Please consult authorized dealer or specialist to clean the internal parts, repair, install, remove and reinstall the unit. Improper installation and handling will cause leakage, electric shock or fire.</p> <p>Confirm to authorized dealer or specialist on usage of specified refrigerant type. Using of refrigerant other than the specified type may cause product damage, burst and injury etc.</p>
	<p>Do not install the unit in a potentially explosive or flammable atmosphere. Failure to do so could result in fire.</p> <p>Do not insert your fingers or other objects into the air conditioner indoor or outdoor unit, rotating parts may cause injury. </p> <p>Do not touch the outdoor unit during lightning, it may cause electric shock.</p> <p>Do not expose yourself directly to cold air for a long period to avoid excess cooling.</p> <p>Do not sit or step on the unit, you may fall down accidentally. </p>
REMOTE CONTROL	
	<p>Do not allow infants and small children to play with the remote control to prevent them from accidentally swallowing the batteries.</p>
POWER SUPPLY	
	<p>Do not use a modified cord, joint cord, extension cord or unspecified cord to prevent overheating and fire.  </p> <p>To prevent overheating, fire or electric shock:</p> <ul style="list-style-type: none"> Do not share the same power outlet with other equipment. Do not operate with wet hands. Do not over bend the power supply cord. Do not operate or stop the unit by inserting or pulling out the power plug.



WARNING

POWER SUPPLY



If the supply cord is damaged, it must be replaced by the manufacturer, its service agent or similarly qualified persons in order to avoid a hazard.

It is strongly recommended to be installed with Earth Leakage Circuit Breaker (ELCB) or Residual Current Device (RCD) to prevent electric shock or fire.

To prevent overheating, fire or electric shock:

- Insert the power plug properly.
- Dust on the power plug should be periodically wiped with a dry cloth.

Stop using the product if any abnormality/failure occurs and disconnect the power plug or turn off the power switch and breaker.

(Risk of smoke/fire/electric shock)

Examples of abnormality/failure

- The ELCB trips frequently.
- Burning smell is observed.
- Abnormal noise or vibration of the unit is observed.
- Water leaks from the indoor unit.
- Power cord or plug becomes abnormally hot.
- Fan speed cannot be controlled.
- The unit stops running immediately even if it is switched on for operation.
- The fan does not stop even if the operation is stopped.

Contact your local dealer immediately for maintenance/repair.



This equipment must be earthed to prevent electrical shock or fire.



Prevent electric shock by switching off the power supply and unplug when:

- Before cleaning or servicing.
- Extended non-use.
- Abnormally strong lightning activity.



CAUTION

INDOOR UNIT AND OUTDOOR UNIT



Do not wash the indoor unit with water, benzene, thinner or scouring powder to avoid damage or corrosion at the unit.

Do not use for preservation of precise equipment, food, animals, plants, artwork or other objects. This may cause quality deterioration, etc.

Do not use any combustible equipment in front of the airflow outlet to avoid fire propagation.

Do not expose plants or pet directly to airflow to avoid injury, etc.

Do not touch the sharp aluminium fin, sharp parts may cause injury.



Do not switch ON the indoor unit when waxing the floor. After waxing, aerate the room properly before operating the unit.

Do not install the unit in oily and smoky areas to prevent damage to the unit.

Do not dismantle the unit for cleaning purpose to avoid injury.

Do not step onto an unstable bench when cleaning the unit to avoid injury.

Do not place a vase or water container on the unit. Water may enter the unit and degrade the insulation. This may cause an electric shock.

Do not open window or door for long time during COOL/DRY mode operation.



Ensure drainage pipe is connected properly and keep drainage outlet clear of gutters, containers or does not immersed in water to prevent water leakage.

After a long period of use or use with any combustible equipment, aerate the room regularly.

After a long period of use, make sure the installation rack does not deteriorate to prevent the unit from falling down.

REMOTE CONTROL



Do not use rechargeable (Ni-Cd) batteries. It may damage the remote control.



To prevent malfunction or damage of the remote control:

- Remove the batteries if the unit is not going to be used for a long period of time.
- New batteries of the same type must be inserted following the polarity stated.

POWER SUPPLY



Do not pull the cord to disconnect the plug to prevent electric shock.

REMOTE CONTROL

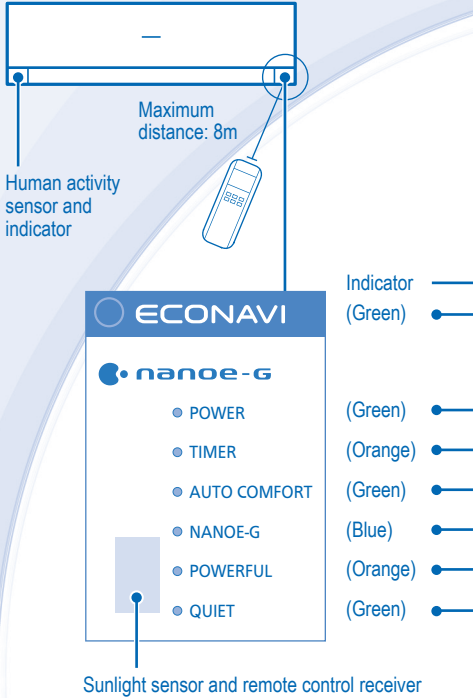

Remote Control display

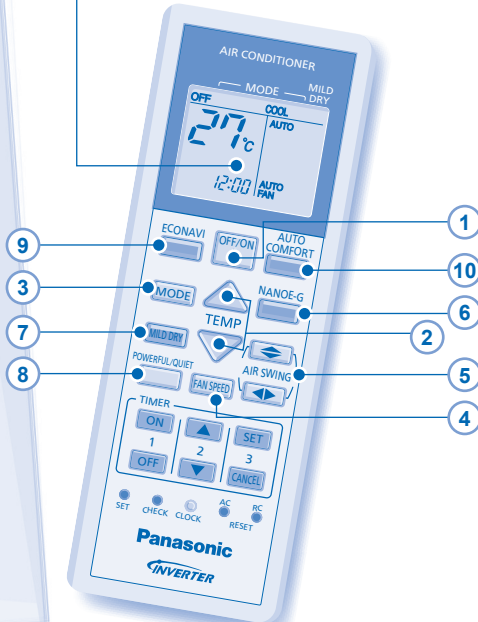

Press the remote control's button

1 TO TURN ON OR OFF THE UNIT



- Please be aware of the OFF indication on the remote control display to prevent the unit from starting/stopping improperly.

2 TO SET TEMPERATURE

- Selection range: 16°C ~ 30°C (Not applicable for FAN mode).
- Operating the unit within the recommended temperature could induce energy saving.
HEAT mode : 20°C ~ 24°C.
COOL mode : 26°C ~ 28°C.
DRY mode : 1°C ~ 2°C lower than room temperature.
- The set temperature selection range can be customized according to requirement. Please consult authorized dealer.

3 TO SELECT OPERATION MODE

AUTO mode - For your convenience

- During operation mode selection the power indicator blinks.
- Unit selects operation mode every 10 minutes according to temperature setting and room temperature.

HEAT mode - To enjoy warm air

- Unit takes a while to warm up. The power indicator blinks during this operation.

COOL mode - To enjoy cool air

- Use curtains to screen off sunlight and outdoor heat to reduce power consumption during cool mode.

DRY mode - To dehumidify the environment

- Unit operates at low fan speed to give a gentle cooling operation.

FAN mode - To circulate air in the room

4 TO SELECT FAN SPEED (5 OPTIONS)



- For AUTO, the indoor fan speed is automatically adjusted according to the operation mode.

5 TO ADJUST AIRFLOW DIRECTION (5 OPTIONS)

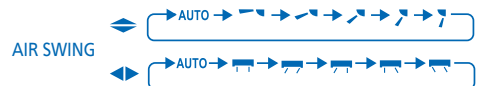

- Keeps the room ventilated.
- In COOL/DRY mode, if AUTO is set, the louver swing left/right and up/down automatically.
- In HEAT mode, if AUTO is set, the horizontal louver fix at predetermined position. The vertical louver swing left/right after the temperature rises.

6 TO PURIFY THE AIR



- Removes/deactivates harmful micro-organisms such as viruses, bacteria, etc.
- Can be activated even when the unit is turned off. In this condition, fan speed and air swing cannot be adjusted.
- nanoe-G starts automatically with the unit switched on with .

7 TO IMPROVE HUMIDITY AND MOISTURE LEVEL

- This operation reduces air dryness and provides you with a comfortable living environment during COOL mode only.
- When vertical airflow direction is set to AUTO, it stops at lower position to avoid cold air contact. However, you can adjust the louver direction manually.

8 TO SWITCH BETWEEN POWERFUL & QUIET



POWERFUL **TO REACH TEMPERATURE QUICKLY** **POWERFUL**

- This operation stops automatically after 4 hours.

QUIET **TO ENJOY QUIET OPERATION** **QUIET**

- This operation reduces airflow noises.

9 10 TO MONITOR HUMAN PRESENCE & ACTIVITY, SUNLIGHT FOR ENERGY SAVING & COMFORT

ECONAVI **ECONAVI**
 To optimize energy saving

AUTO COMFORT **AUTO COMFORT**
 To maximize comfort

- When either operation is activated, the unit will start to initialize for approximately 1 minute. Human activity indicator is blinking in sequence.
- After initialization, the human activity sensor will start to detect the level of heat source & movement, the unit adjusts the temperature and airflow to keep you comfort consistently.

Heat Source & Movement	Low	High	Normal	None
COOL/DRY Mode Set Temperature	+1°C			+2°C
Set Fan Speed	+1 tap*	-1°C +1 tap*		≤ Medium Fan

HEAT Mode Set Temperature	+0.3°C			
Set Fan Speed		-2°C		-2°C

- * For first 15 minutes or until set temperature is reached.
- The human activity sensor will also scan for area of heat source and movement in a room.

Human activity indicator	Heat source & movement
	At left area of the room
	At right area of the room
	At centre area or multiple areas of the room.

- The unit will determine the heat source & movement hotspot, and automatically adjust horizontal airflow direction louver either fix at predetermined position or swing left/right.

Detection area (top view)

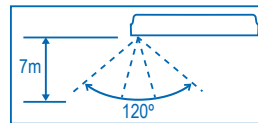

- When manual AIR SWING is selected, the ECONAVI and AUTO COMFORT operation will be cancel.
- The human activity sensor may not detect moving objects further than 7m away or beyond detection angle.
- The human activity sensor sensitivity is influenced by indoor unit location, movement speed, temperature range, etc.
- The human activity sensor may:
 - Mistakenly detects an object with heat source & movement similar to human, such as pets, etc. as human being.
 - Mistakenly detects as non-heat source & movement if a person stays motionless for certain period of time.
- During ECONAVI operation, the sunlight sensor detects sunlight intensity coming through windows and differentiates between sunny and cloudy/night to further optimize energy saving by adjusting the temperature.

Ambient condition	Cloudy/ Night	Sunny	Cloudy/ Night	Sunny
COOL/DRY Mode Set Temperature		+1°C		
HEAT Mode Set Temperature		-1°C		-1°C

- ECONAVI is activated while it is cloudy / night
- ECONAVI is activated while it is sunny

- In a room without window or with thick curtain, the sunlight sensor will judge as cloudy/night.

REMOTE CONTROL

11 Press and hold for 5 seconds to dim or restore the unit's indicator brightness.

12 Press and hold for approximately 10 seconds to show temperature setting in °C or °F.

13 Press to restore the remote control's default setting.

14 Not used in normal operations.

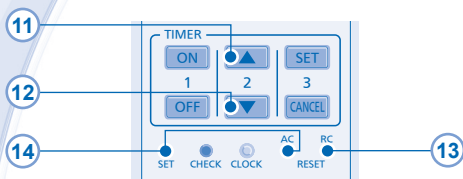

TO SET THE TIMER

- 2 sets of ON and OFF timers are available to turn ON or OFF the unit at different preset time.
- Complete below procedures to set each timer:

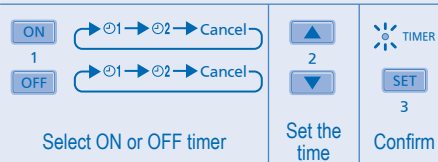

- Example of application at living room:
Morning: ON ⊙1 at 07:00 (Wake up)
OFF ⊙1 at 08:00 (Out for work)
Evening: ON ⊙2 at 17:00 (Back home)
OFF ⊙2 at 22:00 (Sleep)
- To cancel ON or OFF timer, press **ON** or **OFF** to select respective ⊙1 or ⊙2 then press **CANCEL**.
- If timer is cancelled manually or due to power failure, you can restore the timer again by pressing **ON** or **OFF** to select respective ⊙1 or ⊙2 then press **SET**.
- Upcoming timer will be displayed and will be activated in sequence.
- When ON Timer is set, the unit may start earlier (up to 35 minutes) before the actual set time in order to achieve the desired temperature on time.
- Timer operation is based on the clock set in the remote control and repeats daily once set. For clock setting, please refer to Remote Control Preparation on the back cover.

NOTES

NANO-E-G, POWERFUL/QUIET, AUTO COMFORT, ECONAVI

- Can be activated in all modes and can be cancelled by pressing the respective button again.

POWERFUL/QUIET, AUTO COMFORT, ECONAVI

- Cannot be selected at the same time.
- Cannot be activated during "MILD DRY COOLING" operation is activated.

INDOOR UNIT



CAUTION

- Switch off the power supply and unplug before cleaning.
- Do not touch the aluminium fin, sharp parts may cause injury.

CLEANING INSTRUCTIONS

- Do not use benzene, thinner or scouring powder.
- Use only soap (≈ pH7) or neutral household detergent.
- Do not use water hotter than 40°C.

HINT

- To ensure optimal performance of the unit, cleaning maintenance has to be carried out at regular intervals. Dirty unit may cause malfunction and you may see error code "H99". Please consult authorized dealer.

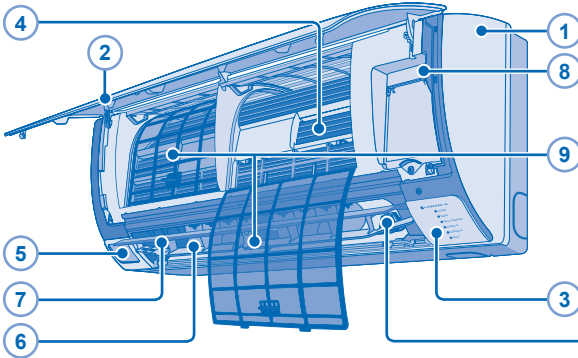

5 HUMAN ACTIVITY SENSOR

- Do not hit or violently press the sensor or poke it with a sharp object. This can lead to damage and malfunction.
- Do not place large objects near the sensor and keep away heating units or humidifiers from the sensor's detection area. This may lead to sensor malfunction.

10 nanoe-G GENERATOR

- Do not touch during operation.

1 INDOOR UNIT

- Wipe the unit gently with a soft, dry cloth.

2 FRONT PANEL

Remove Front Panel

- Raise and pull to remove the front panel.
- Wash gently and dry.

Close Front Panel



- 1 Press down both ends of the front panel to close it.
- 2 Press at center of the front panel to close it securely. (CS-E18NKR, CS-E21NKR, CS-E24NKR, CS-E28NKR)

3 SUNLIGHT SENSOR AND REMOTE CONTROL RECEIVER

4 ALUMINIUM FIN

5 HUMAN ACTIVITY SENSOR

6 HORIZONTAL AIRFLOW DIRECTION LOUVER

- Do not adjust by hand.

7 VERTICAL AIRFLOW DIRECTION LOUVER

- Do not adjust by hand.

8 AUTO OFF/ON BUTTON

- Use when remote control is misplaced or a malfunction occurs.

Action	Mode
Press once.	Auto
Press and hold until 1 beep is heard, then release.	Cooling
Press and hold until 1 beep is heard, then release.	Heating
Press again until 2 beeps, then release.	
Press the button to turn off.	

9 AIR FILTERS

- Air filter cleaning is required every two weeks.
- Wash/rinse the filters gently with water to avoid damage to the filter surface.
- Dry the filters thoroughly under shade, away from fire or direct sunlight.
- Replace any damaged filters.

10 nanoe-G GENERATOR

Clean with dry cotton bud.

- nanoe-G generator cleaning is recommended every 6 months.



TROUBLESHOOTING

The following symptoms do not indicate malfunction.

SYMPTOM	CAUSE
Mist emerges from indoor unit.	▶ • Condensation effect due to cooling process.
Water flowing sound during operation.	▶ • Refrigerant flow inside the unit.
The room has a peculiar odor.	▶ • This may be due to damp smell emitted by the wall, carpet, furniture or clothing. ▶ • This helps to remove the surrounding odours.
Indoor fan stops occasionally during automatic fan speed setting.	▶ • Extraction of remaining heat from the indoor unit (maximum 30 seconds).
Airflow continues even after operation has stopped.	▶ • The delay is a protection to the unit's compressor.
Operation is delayed a few minutes after restarting.	▶ • Condensation or evaporation occurs on pipes.
Outdoor unit emits water/steam.	▶ • The timer setting repeats daily once set.
TIMER indicator is always on.	▶ • The unit is in defrost mode (and AIR SWING is set to AUTO).
POWER indicator blinks during HEAT mode with no warm air supply (and louver is closed).	▶ • To avoid unintended cooling effect.
Indoor fan stops occasionally during heating operation.	▶ • This is a preliminary step in preparation for the operation when the ON timer has been set.
POWER indicator blinks before the unit is switched on.	▶ • Changes of temperature cause the expansion/contraction of the unit. ▶ • Judgement of heat source and movement area in progress.
Cracking sound during operation.	▶ • The unit is in Demand Response Mode.
2 or more human activity indicator turns on simultaneously.	
POWER indicator blinks 3 seconds ON and 0.5 seconds OFF during operation.	

Check the following before calling for servicing.

SYMPTOM	CHECK
Heating/Cooling operation is not working efficiently.	▶ • Set the temperature correctly. • Close all doors and windows. • Clean or replace the filters. • Clear any obstruction at the air inlet and air outlet vents.
Noisy during operation.	▶ • Check if the unit has been installed at an incline. • Close the front panel properly.
Remote control does not work. (Display is dim or transmission signal is weak.)	▶ • Insert the batteries correctly. • Replace weak batteries.
The unit does not work.	▶ • Check if the circuit breaker is tripped. • Check if timers have been set.
The unit does not receive the signal from the remote control.	▶ • Make sure the receiver is not obstructed. • Certain fluorescent lights may interfere with signal transmitter. Please consult authorized dealer.

The unit stops and the TIMER indicator blinks.

Use remote control to retrieve error code.

- 1 Press for 5 seconds.
- 2 Press until you hear beep sound, then write down the error code.
- 3 Press for 5 seconds to quit checking.
- 4 Turn the unit off and reveal the error code to authorized dealer.

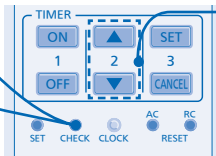

Note:

- For certain errors, you may restart the unit for limited operation with 4 beeps when operation starts.

INFORMATION

FOR SEASONAL INSPECTION AFTER EXTENDED NON-USE

- Checking of remote control batteries.
- No obstruction at air inlet and air outlet vents.
- Use Auto OFF/ON button to select Cooling/Heating operation. After 15 minutes of operation, it is normal to have the following temperature difference between air inlet and air outlet vents:
Cooling: $\geq 8^{\circ}\text{C}$ Heating: $\geq 14^{\circ}\text{C}$

FOR EXTENDED NON-USE

- Activate Heat mode for 2–3 hours as an alternative to remove moisture left in the internal parts thoroughly to prevent mould growth.
- Turn off the power supply and unplug.
- Remove the remote control batteries.

NON SERVICEABLE CRITERIAS

TURN OFF POWER SUPPLY AND UNPLUG then please consult authorized dealer under the following conditions:

- Abnormal noise during operation.
- Water/foreign particles have entered the remote control.
- Water leaks from Indoor unit.
- Circuit breaker switches off frequently.
- Power cord becomes unnaturally warm.
- Switches or buttons are not functioning properly.

Information for Users on Collection and Disposal of Old Equipment and used Batteries



[Information on Disposal in other Countries outside the European Union]

These symbols are only valid in the European Union. If you wish to discard these items, please contact your local authorities or dealer and ask for the correct method of disposal.



Note for the battery symbol (bottom two symbol examples):



This symbol might be used in combination with a chemical symbol. In this case it complies with the requirement set by the Directive for the chemical involved.

Pb

QUICK GUIDE

Remote Control Preparation

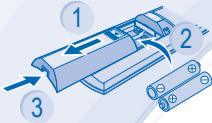

- 1 Pull out
 - 2 Insert AAA or R03 batteries (can be used ~ 1 year)
 - 3 Close the cover
-
- 4 Press CLOCK
 - 5 Set time
 - 6 Confirm

1

MODE



Select the desired mode.

2

OFF/ON

Start/stop the operation.

3

TEMP

Select the desired temperature.

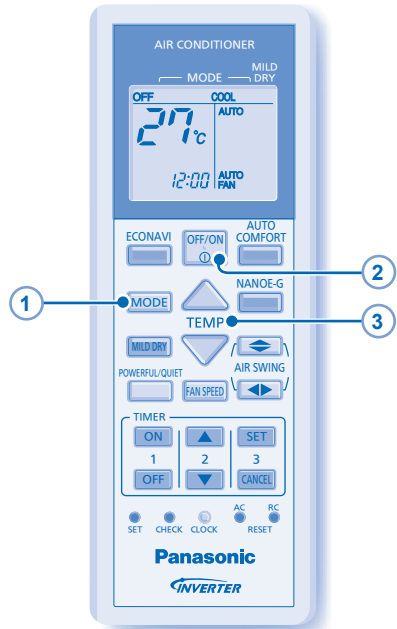

Panasonic Corporation
Website: <http://panasonic.net/>