

Operating Instructions

Blu-ray Disc™ Player

Model No. **DMP-BD75**



Dear customer

Thank you for purchasing this product.

For optimum performance and safety, please read these instructions carefully.

Before connecting, operating or adjusting this product, please read the instructions completely.

Please keep this manual for future reference.



Table of contents

Getting started

Safety precautions	3
Accessories	4
Unit and media care	4
Control reference guide	5
Playable discs/USB devices	6

Connections and settings

STEP 1 : Connecting to a TV	8
STEP 2 : Connecting to an amplifier/receiver	9
STEP 3 : Connecting to a broadband network	9
STEP 4 : Connecting AC mains lead	10
STEP 5 : Settings	10
STEP 6 : Reprogramming the remote control	12

Playback

Inserting or removing media	13
HOME menu	13
Playing video contents	14
Playing still pictures	18
Playing music	19
Playing back contents on the DLNA server (DLNA)	20
Linked operations with the TV (VIERA Link “HDAVI Control™”)	21

Settings

Playback menu	22
Setup menu	24

Reference

Troubleshooting guide	28
Messages	30
Specifications	31
Supplemental information	32

About descriptions in these operating instructions

- Instructions for operations are generally described using the remote control.

Firmware updates (⇒ 12)

Safety precautions

WARNING

Unit

- To reduce the risk of fire, electric shock or product damage,
 - Do not expose this unit to rain, moisture, dripping or splashing.
 - Do not place objects filled with liquids, such as vases, on this unit.
 - Use only the recommended accessories.
 - Do not remove covers.
 - Do not repair this unit by yourself. Refer servicing to qualified service personnel.
 - Do not let metal objects fall inside this unit.
 - Do not place heavy items on this unit.

AC mains lead

- To reduce the risk of fire, electric shock or product damage,
 - Ensure that the power supply voltage corresponds to the voltage printed on this unit.
 - Insert the mains plug fully into the socket outlet.
 - Do not pull, bend, or place heavy items on the lead.
 - Do not handle the plug with wet hands.
 - Hold onto the mains plug body when disconnecting the plug.
 - Do not use a damaged mains plug or socket outlet.
- Install this unit so that the AC mains lead can be unplugged from the socket outlet immediately if any problem occurs.

CAUTION

Unit

- This unit utilizes a laser. Use of controls or adjustments or performance of procedures other than those specified herein may result in hazardous radiation exposure.
- Do not place sources of naked flames, such as lighted candles, on this unit.
- This unit may receive radio interference caused by mobile telephones during use. If such interference occurs, please increase separation between this unit and the mobile telephone.
- This unit is intended for use in moderate climates.

Placement

- Place this unit on an even surface.
- To reduce the risk of fire, electric shock or product damage,
 - Do not install or place this unit in a bookcase, built-in cabinet or in another confined space. Ensure this unit is well ventilated.
 - Do not obstruct this unit's ventilation openings with newspapers, tablecloths, curtains, and similar items.
 - Do not expose this unit to direct sunlight, high temperatures, high humidity, and excessive vibration.

Batteries

- Danger of explosion if battery is incorrectly replaced. Replace only with the type recommended by the manufacturer.
- Mishandling of batteries can cause electrolyte leakage and may cause a fire.
 - Do not mix old and new batteries or different types at the same time.
 - Do not heat or expose to flame.
 - Do not leave the battery(ies) in a car exposed to direct sunlight for a long period of time with doors and windows closed.
 - Do not take apart or short circuit.
 - Do not recharge alkaline or manganese batteries.
 - Do not use batteries if the covering has been peeled off.
 - Remove batteries if you do not intend to use the remote control for a long period of time. Store in a cool, dark place.
- When disposing the batteries, please contact your local authorities or dealer and ask for the correct method of disposal.

NORSK

ADVARSEL

Produkt

- For å redusere faren for brann, elektrisk støt eller skade på apparatet:
 - Utsett ikke produktet for regn, fukt, drypping eller sprut.
 - Ikke plasser objekter som er fylt med væske, som vaser, på apparatet.
 - Bruk kun anbefalt tilbehør.
 - Fjern ikke deksler.
 - Reparer ikke denne enheten selv, overlat service til kvalifisert servicepersonell.

Vekselstrømnett

- Strømuttaket må begynne seg i nærheten slik at den lett kan kobles fra uttaket umiddelbart om det oppstår problemer.

FORSIKTIG

Produkt

- Dette produktet anvender en laser. Betjening av kontroller eller justering eller andre inngrep enn de beskrevet i denne bruksanvisning kan føre til farlig bestråling.
- Plasser ikke åpen ild, slik som levende lys, oppå apparatet.
- Dette apparatet er beregnet for bruk under moderate klimaforhold.

Plassering

- For å redusere faren for brann, elektrisk støt eller skade på apparatet:
 - Ikke plasser apparatet i en bokhylle, et innebygget kabinett eller et annet lukket sted. Pass på at produktet er godt ventilert.
 - Apparatets ventilasjonsåpninger må ikke dekket til med aviser, duker, gardiner eller lignende.

LASER-spesifikasjon

Klasse 1 LASER-produkt:

Bølgelengde : 790 nm (CD)/655 nm (DVD)/405 nm (BD)

Laserstyrke : Ingen farlig stråling sendes ut

Accessories

Check the supplied accessories before using this unit.

- 1 **Remote control**
(N2QAYB000577)
- 2 **Batteries for remote control**
- 1 **AC mains lead**
- 1 **CD-ROM**



- Product numbers provided in these operating instructions correct as of January 2011. These may be subject to change.
- Do not use AC mains lead with other equipment.

Using the remote control

Insert so the poles (+ and –) match those in the remote control.

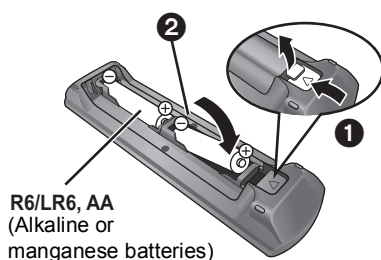

Point it at remote control signal sensor on this unit. (⇒ 5)

Unit and media care

■ Clean this unit with a soft, dry cloth

- Never use alcohol, paint thinner or benzene to clean this unit.
- Before using chemically treated cloth, carefully read the instructions that came with the cloth.

■ Clean the lens with the lens cleaner

Lens cleaner: RP-CL720AE

- This lens cleaner may not be available for sale in all countries, e.g. not available in Germany, please consult your Panasonic dealer for advice.
- This lens cleaner is sold as specific for DIGA, but can be used on this unit as well.

■ Clean discs



Wipe with a damp cloth and then wipe dry.

■ Disc handling precautions

- Handle discs by the edges to avoid inadvertent scratches or fingerprints on the disc.
- Do not attach labels or stickers to discs.
- Do not use record cleaning sprays, benzene, thinner, static electricity prevention liquids or any other solvent.
- Do not use the following discs:
 - Discs with exposed adhesive from removed stickers or labels (rented discs etc).
 - Discs that are badly warped or cracked.
 - Irregularly shaped discs, such as heart shapes.

■ To dispose or transfer this unit

The unit may keep the user settings information in the unit. If you discard this unit either by disposal or transfer, then follow the procedure to return all the settings to the factory presets to delete the user settings. (⇒ 28, "To return all settings to the factory preset.")

- The operation history may be recorded in the memory of this unit.

Control reference guide

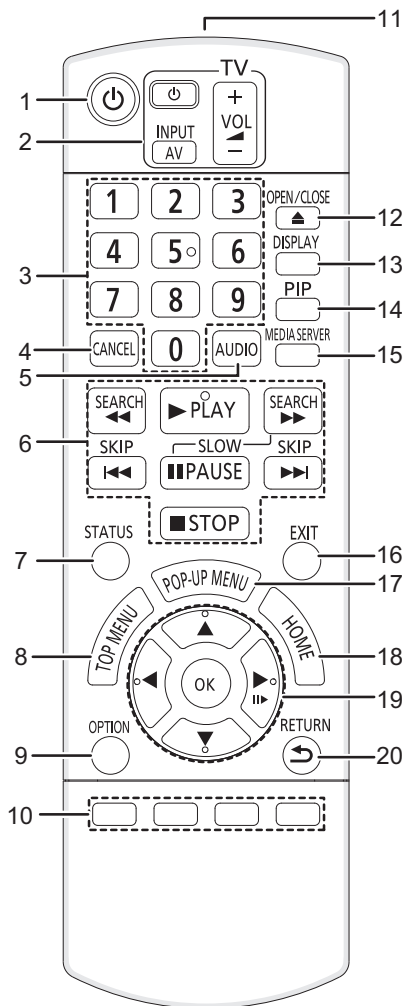

- 1 Turn the unit on and off
 - 2 **TV operation buttons** (⇒ 12)
You can operate the TV through the unit's remote control.
[TV] : Turn the television on and off
[AV] : Switch the input select
[+ - VOL] : Adjust the volume
 - 3 Select title numbers, etc./Enter numbers.
 - 4 Cancel
 - 5 Select audio (⇒ 14)
 - 6 Basic playback control buttons (⇒ 14)
 - 7 Show status messages (⇒ 14)
 - 8 Show Top menu/DIRECT NAVIGATOR (⇒ 14)
 - 9 Show OPTION menu (⇒ 15)
 - 10 Coloured buttons (red, green, yellow, blue)
These buttons are used when;
 - Operating a BD-Video disc that includes Java™ applications (BD-J).
 - 11 Transmit the remote control signal
 - 12 Open or close the disc tray (⇒ 13)
- CAUTION**
Do not place objects in front of the unit. The disc tray may collide with objects when it is opened, and this may cause malfunction.
- 13 Show playback menu (⇒ 22)
 - 14 Switch on/off Secondary Video (Picture-in-picture) (⇒ 16)
 - 15 Start up the DLNA function (⇒ 20)
 - 16 Exit the menu screen
 - 17 Show Pop-up menu (⇒ 14)
 - 18 Show HOME menu (⇒ 13)
 - 19 Selection/OK, Frame-by-frame (⇒ 14)
 - 20 Return to previous screen

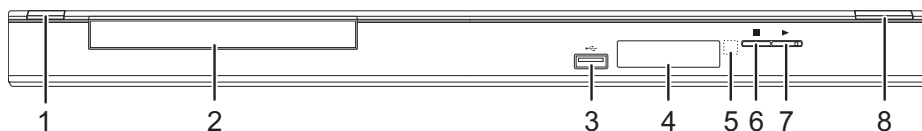







- 1 **Standby/on switch** (⏻/⏻) (⇒ 10)
Press to switch the unit from on to standby mode or vice versa. In standby mode, the unit is still consuming a small amount of power.
- 2 Disc tray (⇒ 13)
- 3 USB port (⇒ 13)
- 4 Display (⇒ 32)

- 5 Remote control signal sensor
Distance: Within approx. 7 m
Angle: Approx. 20° up and down, 30° left and right
- 6 Stop (⇒ 14)
- 7 Start play (⇒ 14)
- 8 Open or close the disc tray (⇒ 13)

Rear panel terminals (⇒ 8–10)

Playable discs/USB devices

Device	Disc markings	Device types	Contents format*
BD		BD-Video	Video
		BD-RE	Video JPEG
		BD-R	Video DivX® MKV
DVD		DVD-Video	Video
		DVD-R	Video AVCHD DivX® MKV
		DVD-R DL	MP3 JPEG
		DVD-RW	Video AVCHD
	—	+R/+RW/+R DL	
CD		Music CD	Music [CD-DA]
	—	CD-R CD-RW	DivX® MKV Music [CD-DA] MP3 JPEG
USB	—	USB devices (up to 2 TB)	DivX® MKV MP3 JPEG

* See page 7 and 31 for more information on the types of content that can be played.

■ Discs that cannot be played by this unit

- DVD-RAM
- Super Audio CD
- Photo CD
- DVD-Audio
- WMA discs
- DivX Plus HD discs
- HD DVD

■ Region management information

BD-Video

This unit plays BD-Video marked with labels containing the region code "B".

Example:



DVD-Video

This unit plays DVD-Video marked with labels containing the region number "2" or "ALL".

Example:



■ Finalize

DVD-R/RW/R DL, +R/+RW/+R DL and CD-R/RW recorded by a recorder, etc. needs to be finalized by the recorder to play on this unit. Please refer to the recorder's instructions.

■ BD-Video

- This unit supports high bit rate audio (Dolby Digital Plus, Dolby TrueHD, DTS-HD High Resolution Audio and DTS-HD Master Audio) adopted in BD-Video.
 - If "Dolby D/Dolby D +/Dolby TrueHD" is set to "PCM", the maximum possible number of Dolby sound is 2ch PCM. (⇒ 25)

■ Music CD

Operation and sound quality of CDs that do not conform to CD-DA specifications (copy control CDs, etc.) cannot be guaranteed.

■ USB device

- This unit does not guarantee connection with all USB devices.
- This unit does not support USB device charging.
- FAT12, FAT16 and FAT32 file systems are supported.
- This unit supports USB 2.0 High Speed.
- This unit can support an HDD formatted to FAT32. Some types of HDD may require the use of its external power supply unit.

■ BD-RE, BD-R

Discs recorded in DR mode using Panasonic Blu-ray Disc recorders may not playback the audio etc., correctly.



- It may not be possible to play the above media in some cases due to the type of media, the condition of the recording, the recording method and how the files were created.
- The producers of the disc can control how discs are played, so you may not always be able to control play as described in these operating instructions. Read the disc's instructions carefully.

STEP 1 : Connecting to a TV

- Do not place the unit on amplifiers/receivers or equipment that may become hot. The heat can damage the unit.
- Before making any connections we suggest you temporarily disconnect all the units from AC power.
- Do not connect video signals through a video recorder. Due to copy guard protection the picture may not be displayed properly.
- Please use High Speed HDMI Cables that have the HDMI logo (as shown on the cover). It is recommended that you use Panasonic's HDMI cable. When outputting 1080p signal, please use HDMI cables 5.0 meters or less.

Recommended part number (High Speed HDMI Cable):
RP-CDHS15 (1.5 m), RP-CDHS30 (3.0 m),
RP-CDHS50 (5.0 m), etc.

Back of the unit

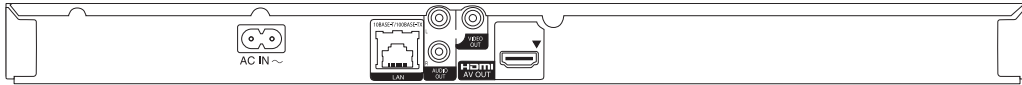

■ Via an HDMI AV OUT terminal (High quality)

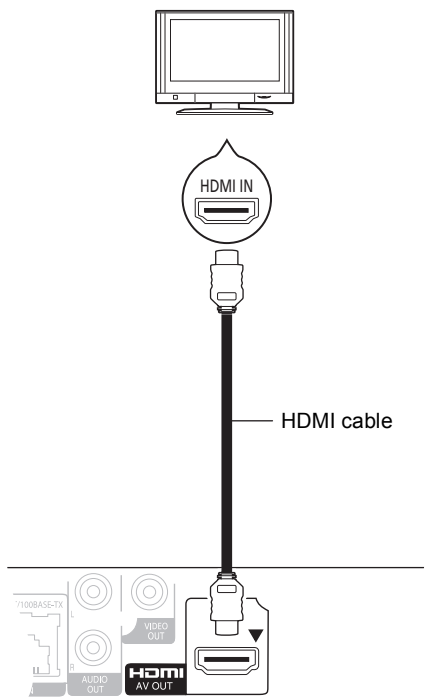

- Set "HDMI Audio Output" to "On" (⇒ 26).
- The HDMI connection supports VIERA Link "HDAVI Control" (⇒ 21).

■ Via a VIDEO OUT terminal (Standard quality)

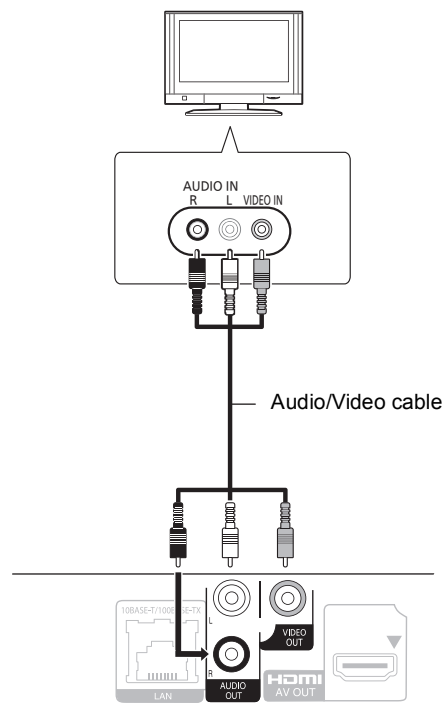

- Connect terminals of the same colour.

STEP 2 : Connecting to an amplifier/receiver

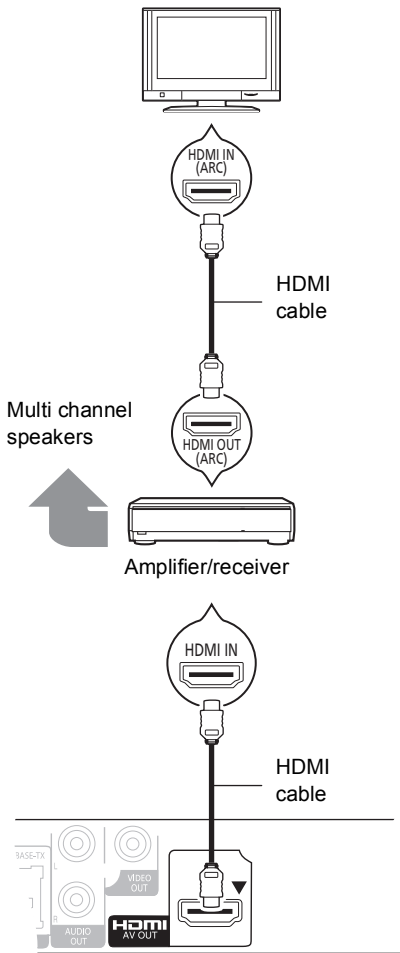

- Set "HDMI Audio Output" to "On" (⇒ 26).
- Set "Digital Audio Output" depending on the connected amplifier/receiver (⇒ 25).
- The HDMI connection supports VIERA Link "HDAVI Control" (⇒ 21).
- When using the TV or amplifier/receiver that does not have the indication of "(ARC)" (non-ARC-compatible) on the HDMI terminal, in order to enjoy TV's sound by amplifier/receiver it is also required to connect the amplifier/receiver and TV using an optical digital cable.

STEP 3 : Connecting to a broadband network

The following services can be used when this unit is connected to broadband.

- Firmware can be updated (⇒ 12)
- You can enjoy BD-Live (⇒ 16)
- You can access other devices (⇒ 20)

For details about connection method, refer to the instructions supplied with the connected equipment.

■ LAN cable connection

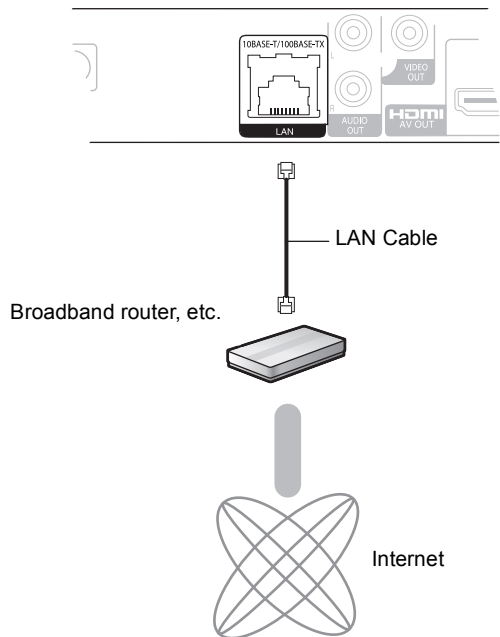

- Use category 5 or above straight LAN cables (STP) when connecting to peripheral devices.
- Inserting any cable other than a LAN cable in the LAN terminal can damage the unit.

STEP 4 : Connecting AC mains lead

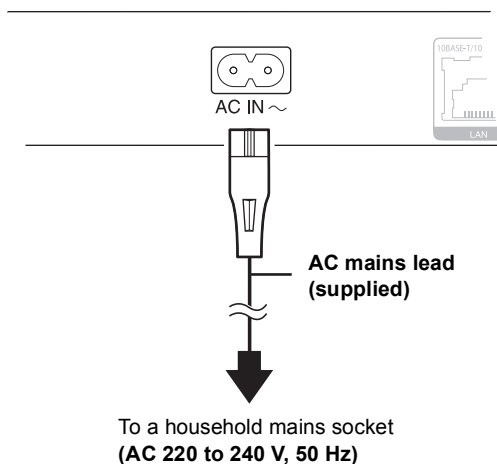

- This unit consumes a small amount of AC power ("Quick Start": "Off", approx. 0.2 W) even when turned off. In the interest of power conservation, if you will not be using this unit for an extended period of time, it can be disconnected.

STEP 5 : Settings

Easy Setting

After connecting your new player for the first time and pressing [⏻], a screen for the basic settings will appear.

Preparation

Turn on the television and select the appropriate video input on the television.

1 Press [⏻].

Setup screen appears.

2 Follow the on-screen instructions and make the settings with [▲, ▼] and press [OK].

"On-Screen Language", "TV Aspect" and "Quick Start" are set. (⇒ 25 – 27)

After completing "Easy Setting", you can perform "Network Easy Setting".



- You can perform this setup anytime by selecting "Easy Setting" in the Setup menu. (⇒ 27)
- You can also change these settings individually. (⇒ 25 – 27)

Network Easy Setting

After completing "Easy Setting", you can continue with "Network Easy Setting".

Follow the on-screen instructions and make the settings with [▲, ▼, ◀, ▶] and press [OK].

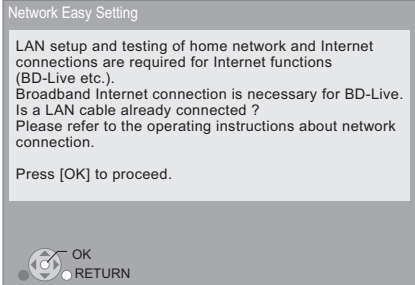

When you experience problems with settings

Network Easy Setting (Home Network Connection Check)

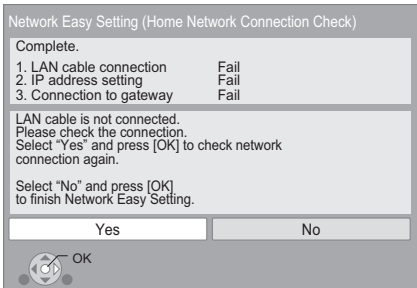

Display		Check the following
1. LAN cable connection	Fail	● Connection of the LAN cables (⇒ 9)
2. IP address setting	Fail	
3. Connection to gateway	Fail	
1. LAN cable connection	Pass	● Connection and settings of the hub and router
2. IP address setting	Fail	
3. Connection to gateway	Fail	● Settings of "IP Address / DNS Settings" (⇒ 26)
1. LAN cable connection	Pass	
2. IP address setting	Pass or Home network available	
3. Connection to gateway	Fail	

Network Easy Setting (Internet Connection Test)

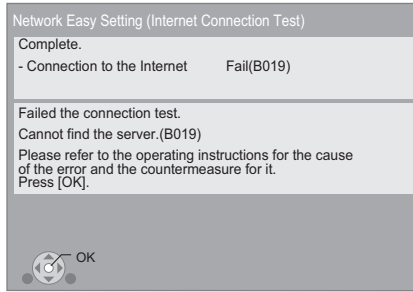

Display	Check the following
Cannot find the server. (B019)	● "Primary DNS" and "Secondary DNS" settings of "IP Address / DNS Settings" (⇒ 26)
Failed to connect to the server. (B020)	● The server may be busy or the service may have been suspended. Please wait a few moments, and then try again. ● Settings of "Proxy Server Settings" (⇒ 26) and the router



- Refer to the operating instructions of the hub or router.
- You can perform this setup anytime by selecting "Network Easy Setting" in the Setup menu. (⇒ 26)
- You can redo these settings individually using "Network Settings". (⇒ 26)

Firmware updates

Occasionally, Panasonic may release updated firmware for this unit that may add or improve the way a feature operates. These updates are available free of charge.

This unit is capable of checking the firmware automatically when connected to the Internet via a broadband connection. When a new firmware version is available, the following message is displayed.

New firmware is available.
Please update firmware in Setup.

To update the firmware

Press **[HOME]** ⇒ select **“Setup”** ⇒ select **“Player Settings”** ⇒ select **“Others”** ⇒ **[OK]** ⇒ select **“Firmware Update”** ⇒ **[OK]** ⇒ select **“Update Now”**

DO NOT DISCONNECT the unit from the AC power or perform any operation while the update takes place. After the firmware is installed, “FINISH” will be displayed on the unit’s display. Unit will restart and the following screen will be displayed.



- If downloading on this unit fails or this unit is not connected to the Internet, then you can download the latest firmware from the following website and burn it to a CD-R to update the firmware. <http://panasonic.jp/support/global/cs/> (This site is in English only.)
To show the firmware version on this unit. (⇒ 27, “System Information”)
- Downloading will require several minutes. It may take longer or may not work properly depending on the connection environment.
- If you do not want to check for the latest firmware version, set “Automatic Update Check” to “Off”. (⇒ 27)

STEP 6 : Reprogramming the remote control

For other Panasonic products

If you have more than one Panasonic player/recorder and the remote control operates both products at once, you will need to change the remote control code on one product to prevent this occurrence. (⇒ 27, “Remote Control”)

For TV

You can operate the TV using the unit’s remote control.

- 1 Input the 2-digit code (⇒ 32) with the number buttons while pressing [TV].**
e.g., 01: [0] ⇒ [1]
- 2 Test by turning on the television.**



- If your television brand has more than one code listed, select the one that allows correct operation.

Inserting or removing media

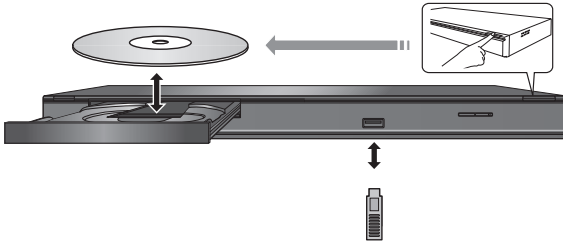

- When inserting a media item, ensure that it is facing the right way up.
- If you connect a Panasonic product with a USB connection cable, the setup screen may be displayed on the connected equipment. For details, refer to the instructions for the connected equipment.

HOME menu

Major functions of this unit can be operated from the HOME menu.

Preparation

Turn on the television and select the appropriate video input on the television.

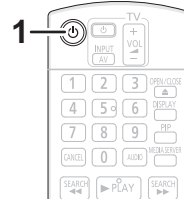

1 Press [POWER] to turn on the unit.

The Home menu will be displayed.

2 Press [OK] or [UP], [DOWN], [LEFT], [RIGHT] to select the item.

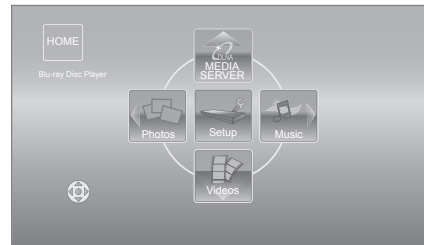

- When a media is inserted, contents selection screen for that media is displayed.
- If there are any other items, repeat this step.
- To return to HOME menu, select "HOME" or press [RETURN] several times.

Videos/ Photos/ Music	Disc	Play back the contents. (⇒ 14, 18, 19)
	USB	• When multiple contents are recorded, select the types of contents or the title.
MEDIA SERVER	(⇒ 20)	
Setup	Player Settings	(⇒ 24)
	USB Management	(⇒ 16)

To show the HOME menu

Press [HOME].



- Items to be displayed may vary with the media.
- Where necessary, set "Mixed Data Disc Option" when using a disc with both data files (MP3, JPEG, DivX, MKV) and Video. (⇒ 24)

Playing video contents

BD DVD CD USB

1 Insert the media.

When the contents menu is displayed, press [▲, ▼, ◀, ▶] to select the item. (⇒ 13)

2 Press [▲, ▼] to select the title and press [OK].

■ To show menus

You can display Top Menu, DIRECT NAVIGATOR or Pop-up Menu.

Press [TOP MENU] or [POP-UP MENU].

- Press [▲, ▼, ◀, ▶] to select the item and press [OK].

■ To show the status messages

While playing, press [STATUS].

The status messages give you information about what is currently being played. Each time you press [STATUS], the display information may change or will disappear from the screen.

e.g. BD-Video

T: Title, C: Chapter, PL: Playlist

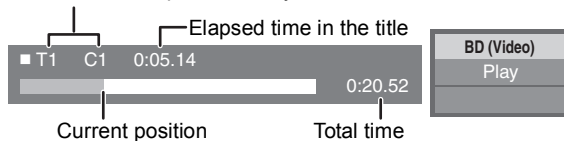

- Signal from PAL discs is output as PAL. Signal from NTSC discs is output as "NTSC" or "PAL60". You can select "NTSC" or "PAL60" in "NTSC Contents Output" for NTSC discs. (⇒ 25)
- DISCS CONTINUE TO ROTATE WHILE MENUS ARE DISPLAYED. Press [■STOP] when you have finished playback to protect the unit's motor, your television screen and so on.
- Depending on media and contents, the display may change or may not appear.
- DivX and MKV: Successive play is not possible.
- It is not possible to playback AVCHD and MPEG2 video which have been dragged and dropped, copied and pasted to the media.
- To save on electricity, the unit is turned off automatically if there is no button operation for about 30 minutes when not playing back (such as when paused, displaying the menu, displaying still pictures, etc.).

Other operations during play

These functions may not work depending on the media and contents.

Stop

Press [■STOP].

The stopped position is memorized.

Resume play function

Press [▶PLAY] to restart from this position.

- The position is cleared if the tray is opened or you press [■STOP] several times to display "STOP" on the unit's display.
- On BD-Video discs including BD-J, the resume play function does not work.

Pause

Press [||PAUSE].

- Press [||PAUSE] again or [▶PLAY] to restart play.

Search/Slow-motion

Search

While playing, press [SEARCH◀◀] or [SEARCH▶▶].

- Music and MP3: The speed is fixed to a single step.

Slow-motion

While paused, press [SEARCH▶▶].

The speed increases up to 5 steps.

- Press [▶PLAY] to revert to normal playback speed.

Skip

While playing or paused, press [◀◀] or [▶▶].

Skip to the title, chapter or track you want to play.

- Each press increases the number of skips.

Frame-by-frame

While paused, press [▶] (||▶).

- Press and hold to change in succession forward.
- Press [▶PLAY] to revert to normal playback speed.

Changing audio

Press [AUDIO].

You can change the audio channel number or soundtrack language, etc.

Useful functions

- 1 Press [OPTION].
- 2 Select an item, then press [OK].

While DIRECT NAVIGATOR screen is displayed

View Playlists	To play playlists.
View Titles	To select the title.
Folder	To switch to another folder.

While playing

Top Menu	To display Top Menu.
Pop-up Menu	To display Pop-up Menu.
Menu	To display Menu.



- Depending on the media and contents, displayed items are different.

■ Displaying subtitle text

You can display subtitle text on the DivX and MKV video disc with this unit.

The operation might be different or it may not operate properly depending on the way the file was made or the state of this unit (playing, stopped, etc.).

Set “Subtitle” in “Disc” (⇒ 22)



- DivX and MKV video files that do not display “Text” do not contain subtitle text.
- If the subtitle text is not displayed correctly, try changing the language settings. (⇒ 24)
- This function has no relation to the subtitles specified in DivX standard specifications and has no clear standard.

Enjoying BD-Live or picture-in-picture in BD-Video

Enjoying BD-Live discs with Internet

BD-Live allows you to enjoy more functions such as subtitles, exclusive images and online games by connecting this unit to the Internet. Since most of the BD-Live compatible discs are played back using the BD-Live function, additional contents are required to be downloaded into the external memory (local storage).

- This unit uses a USB device as a local storage device. BD-Live function cannot be used when there is no USB device inserted.

- 1 Perform network connection and settings. (⇒ 9, 11)
- 2 Insert a USB memory with 1 GB or more free space.
- 3 Insert the disc.

■ Deleting data on the USB device

If you no longer need data recorded on the USB device, you can delete data with the following operation.

- ① Insert a USB device.
- ② Press [HOME].
- ③ Press [OK] to select "Setup".
- ④ Press [▶] to select "USB Management".
- ⑤ Press [OK].

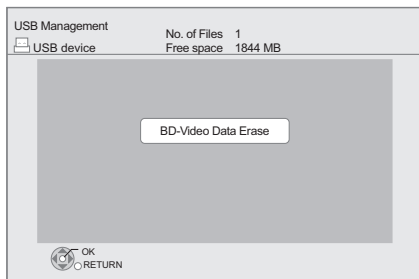

- ⑥ Press [◀, ▶] to select "Yes" and press [OK].
- ⑦ Press [◀, ▶] to select "Start" and press [OK].

Playing picture-in-picture

To turn on/off secondary video
Press [PIP].

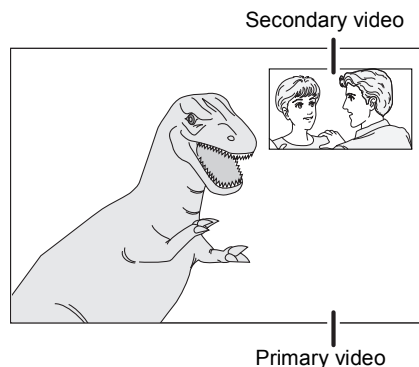

To turn on/off secondary audio
[DISPLAY] ⇒ select "Disc" ⇒ [▶] ⇒ select "Signal Type" ⇒ [OK] ⇒ set "Soundtrack" in "Secondary Video" to "On" or "Off"



- The usable functions and the operating method may vary with each disc, please refer to the instructions on the disc and/or visit their website.
- Some BD-Live content available on the Blu-ray discs may require an Internet account to be created in order to access the BD-Live content. Follow the screen display or instruction manual of the disc for information on acquiring an account.
- "BD-Live Internet Access" may need to be changed for certain discs (⇒ 24).
- When discs supporting BD-Live are played back, the player or disc IDs may be sent to the content provider via the Internet.
- During search/slow-motion or frame-by-frame, only the primary video is displayed.
- When "BD-Video Secondary Audio" in "Digital Audio Output" is set to "Off", secondary audio will not be played (⇒ 25).

Regarding DivX

ABOUT DIVX VIDEO:

DivX® is a digital video format created by DivX, Inc. This is an official DivX Certified® device that plays DivX video. Visit divx.com for more information and software tools to convert your files into DivX video.

ABOUT DIVX VIDEO-ON-DEMAND:

This DivX Certified® device must be registered in order to play purchased DivX Video-on-Demand (VOD) movies. To obtain your registration code, locate the DivX VOD section in your device setup menu.

Go to vod.divx.com for more information on how to complete your registration.

- Video images of the copyright-protected DivX contents stored on USB device can be output only through the HDMI output terminal.

Display the unit's registration code.

(⇒ 27, "DivX Registration" in "Others")

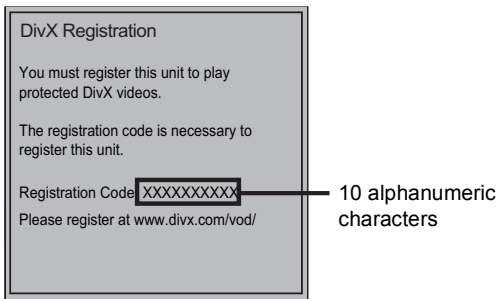

- After playing DivX VOD content for the first time, the registration code is not displayed.
- If you purchase DivX VOD content using a registration code different from this unit's code, you will not be able to play this content.

Cancel the unit's registration.

(⇒ 27, "DivX Registration" in "Others")

Press [◀, ▶] to select "Yes" in "DivX Registration".

Use the deregistration code to cancel the registration in www.divx.com.

Regarding DivX VOD content that can only be played a set number of times

Some DivX VOD contents can only be played a set number of times. When you play this content, the number of times already played and initially playable number of times is displayed.

- The remaining number of plays decreases each time a programme is played. However, when playing from the point where play was previously stopped, the remaining number of plays does not decrease due to the resume play function.

Playing still pictures

BD DVD CD USB

(BD-RE, DVD-R/-R DL, CD-R/RW, USB device)

1 Insert the media.

When the contents menu is displayed, press [▲, ▼, ◀, ▶] to select the item. (⇒ 13)

2 Press [▲, ▼, ◀, ▶] to select the still picture and press [OK].

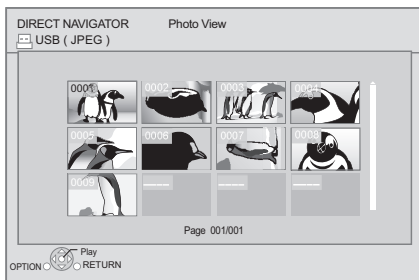

Press [◀, ▶] to display the previous or next still picture.

To exit the screen

Press [TOP MENU].

■ To show the still picture properties

While playing, press [STATUS] once or twice.

Shooting date



To exit the screen

Press [STATUS].

Useful functions

1 Press [OPTION].

2 Select an item, then press [OK].

While Photo View screen is displayed

Folder	To select the still pictures in another folder.
Start Slideshow	You can display still pictures one by one at a constant interval.
Slideshow Setting	Display Interval Change the display interval. Transition Effect Set display method. Repeat Play Repeat slideshow. Press [▲, ▼, ◀, ▶] to select "Set" and press [OK].

While playing

Rotate RIGHT	Rotate the still picture.
Rotate LEFT	



- Depending on the condition of the unit and media contents, displayed items are different.
- When a still picture with large number of pixels is played, the display interval may become longer. Even if the setting is changed, the display interval may not become shorter.

Playing music

DVD CD USB

(DVD-R/-R DL, music CD, CD-R/RW, USB device)

1 Insert the media.

When the contents menu is displayed, press
[▲, ▼, ◀, ▶] to select the item. (⇒ 13)

2 Press [▲, ▼] to select the track and press [OK].

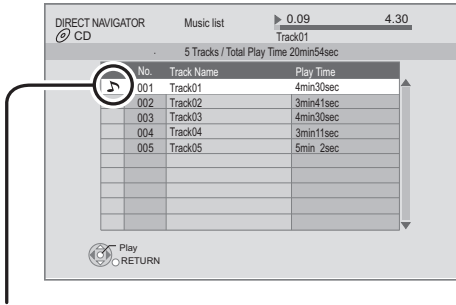

“🎵” indicates the track currently playing.

To exit the screen

Press [TOP MENU].

Playing a track in another folder

1 While DIRECT NAVIGATOR screen is displayed
Press [OPTION].

2 Press [▲, ▼] to select “Folder” and press [OK].



- You cannot select folders that contain no compatible tracks.

Playing back contents on the DLNA server (DLNA)

You can enjoy viewing video, still pictures and music saved on a DLNA Certified media server connected to the home network with this unit.

You can also enjoy viewing the video and still pictures recorded in Panasonic DLNA compatible recorders (DIGA).

- The countries where DIGA is available are limited. Refer to following site for availability.

<http://panasonic.jp/support/global/cs/>

Preparation

- ① Perform network connection (⇒ 9) and network setting (⇒ 11) of this unit.
- ② Perform Home Network settings of the connected equipment.

When connected to a PC with Windows 7 installed

- Add the contents and folder to the Windows Media® Player library.
 - Playlist of Windows Media® Player can play back only the contents that are stored in the libraries.
- Regarding setting method of Windows 7 refer to its instructions or help.

When connected to a Panasonic DLNA compatible recorder (DIGA)

When a message requesting operation of the equipment to be registered is displayed, perform step 1 and 2.

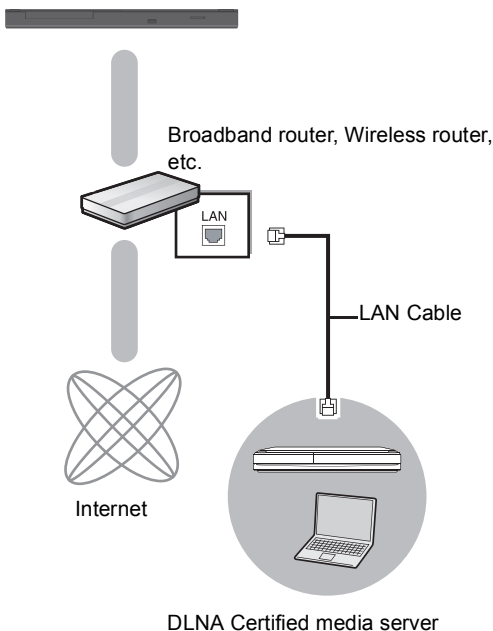

For details about the setting and operation method of connected equipment, and compatible equipment, refer to the following Website and the operating instructions for each item of equipment.
<http://panasonic.jp/support/global/cs/>
 (This site is in English only.)

1 Press [MEDIA SERVER].

- A list of equipment connected via the network is displayed.
- This list can be updated by pressing the red button on the remote control.

e.g.

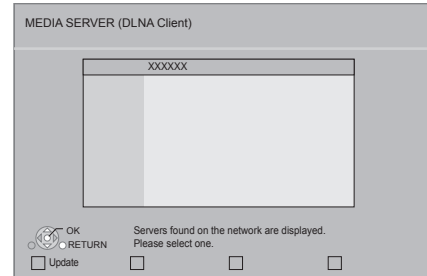

2 Press [▲, ▼] to select the equipment to playback the contents, and press [OK].

3 Press [▲, ▼, ◀, ▶] to select the item to playback (folder), and press [OK].

- You may be able to use convenient functions depending on the disc or content by pressing [OPTION] or [DISPLAY].
- Control Panel is displayed once the playback starts. Operation can be performed with [▲, ▼, ◀, ▶], [OK] and [EXIT].

Control Panel

e.g.

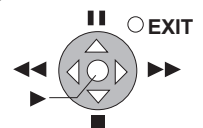

- Press [OK] if the Control Panel is not displayed.
- Press [RETURN] to hide the Control Panel.

To exit the screen

Press [EXIT], [HOME] or [TOP MENU].



- Menu structure will be different depending on the equipment connected to this unit. Select the contents by repeating the operation.
- Depending on the contents and the connected equipment, playback may not be possible.
- Items displayed in grey on the display cannot be played back by this unit.
- This unit cannot be played back via connected equipment.
- Depending on the performance of the connected PC, video frames may be dropped during playback, or video may not playback at all.

Linked operations with the TV

(VIERA Link “HDAVI Control™”)

What is VIERA Link “HDAVI Control”?

VIERA Link “HDAVI Control” is a convenient function that offers linked operations of this unit, and a Panasonic TV (VIERA) or other device under “HDAVI Control”.

You can use this function by connecting the equipment with an HDMI cable. See the operating instructions for connected equipment for operational details.

Preparation

- ① Set “VIERA Link” to “On” (⇒ 26).
(The default setting is “On”.)
- ② Set the “HDAVI Control” operations on the connected equipment (e.g., TV).
- ③ Turn on all “HDAVI Control” compatible equipment and select this unit’s input channel on the connected TV so that the “HDAVI Control” function works properly.
Also when the connection or settings are changed, repeat this procedure.

Automatic input switching Power on link

When play starts on the unit, the TV will automatically switch the input channel and display the corresponding action. Additionally when the TV is off, the TV will automatically turn on.

Power off link

All connected equipment compatible with “HDAVI Control”, including this unit, automatically turns off when you switch the television off.



- This unit supports “HDAVI Control 1” function. This standard is compatible with Panasonic’s conventional HDAVI equipment.
- VIERA Link “HDAVI Control”, based on the control functions provided by HDMI which is an industry standard known as HDMI CEC (Consumer Electronics Control), is a unique function that we have developed and added. As such, its operation with other manufacturers’ equipment that supports HDMI CEC cannot be guaranteed.
- Please refer to individual manuals for other manufacturers’ equipment supporting VIERA Link function.

Playback menu

1 Press [DISPLAY].

e.g., BD-Video

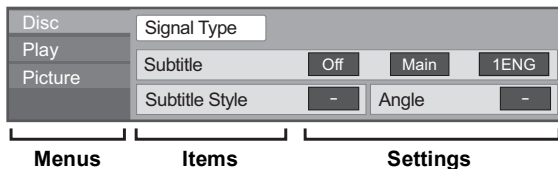

2 Press [\blacktriangle , \blacktriangledown] to select the menu and press [\blacktriangleright].

3 Press [\blacktriangle , \blacktriangledown , \blacktriangleleft , \blacktriangleright] to select the item and press [\blacktriangleright].

4 Press [\blacktriangle , \blacktriangledown] to select the setting.

Some items can be changed by pressing [OK].

To exit the screen

Press [DISPLAY].

Depending on the condition of the unit (playing, stopped, etc.) and media contents, there may be some items that you cannot select or change.

Regarding Language : (⇒ 32)

Disc

Signal Type

Primary Video	Video	The recording method of original video appears.
	Soundtrack	Select the type of audio or language.
Secondary Video	Video	Select on/off of images. The recording method of original video appears.
	Soundtrack	Select on/off of audio and the language.

Video

The recording method of original video appears.

Soundtrack

Show or change the soundtrack.

Subtitle

Turn the subtitle on/off, and change the language depending on the media.

Subtitle Style

Select the subtitle style.

Audio channel

Select the audio channel number.
(⇒ 14, "Changing audio")

Angle

Select the number of the angle.



- Some items may be changed only on the disc specific menu. (⇒ 14)

Play

Repeat Play

(Only when the elapsed time is being displayed on the unit's display.)

Select the item which you want to repeat. The items displayed differ depending on the type of media.

Select "Off" to cancel.

Random

Select whether or not to play random.

Picture

Mode

Select the picture quality mode during play.

- If you select "User", you can make further adjustments.
Press [▶] to select "Picture Adjustment" and press [OK].
-

Progressive

Select the method of conversion for progressive output to suit the type of material being played.

- If the video is disrupted when "Auto" is selected, select either "Video" or "Film" depending on the material to be played back.
-

Setup menu

Change the unit's settings if necessary. The settings remain intact even if you switch the unit to standby.

- 1 Press [HOME].
- 2 Press [OK] to select "Setup".
- 3 Press [◀] to select "Player Settings".

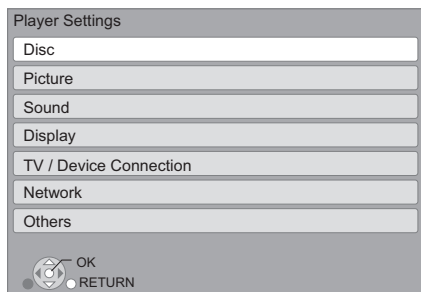

- 4 Press [▲, ▼] to select the menu and press [OK].
- 5 Press [▲, ▼] to select the item and press [OK].
If there are any other items, repeat these steps.
- 6 Press [▲, ▼, ◀, ▶] to select the option and press [OK].



- There may be differences in operation methods. If this happens, follow the on-screen instructions for the operation.

About the password

The following items use the same password.
Don't forget your password.

- "DVD-Video Ratings"
- "BD-Video Ratings"

Disc

DVD-Video Ratings

Set a ratings level to limit DVD-Video play.

- Follow the on-screen instructions. Enter a 4-digit password with the number buttons when the password screen is shown.

BD-Video Ratings

Set an age limit of BD-Video play.

- Follow the on-screen instructions. Enter the 4-digit password with the number buttons when the password screen is shown.

Soundtrack Preference

Choose the language for audio.

- If "Original" is selected, the original language of each disc will be selected.
- Enter a code (⇒ 32) with the number buttons when you select "Other ****".

Subtitle Preference

Choose the language for the subtitle.

- If "Automatic" is selected and the language selected for "Soundtrack Preference" is not available, subtitles of that language will automatically appear if available on that disc.
- Enter a code (⇒ 32) with the number buttons when you select "Other ****".

Menu Preference

Choose the language for the disc menus.

- Enter a code (⇒ 32) with the number buttons when you select "Other ****".

BD-Live Internet Access (⇒ 16)

You can restrict Internet access when BD-Live functions are used.

- If "Limit" is selected, Internet access is permitted only for BD-Live contents which have content owner certificates.

Mixed Data Disc Option

Select the playback contents on discs with both data files and Video.

- If "MP3/JPEG/DivX" is selected, the video menu function is unavailable.
- If "BD-RE/AVCHD" is selected, data file cannot be played back.

Subtitle Text

Select a suitable item according to the language used for DivX or MKV subtitles text (⇒ 15).

- This item is displayed only after playing back a file.



- BDAV is one of the video formats that are recorded on a BD-RE/BD-R.(⇒ 6)

Picture

NTSC Contents Output

Select PAL60 or NTSC output when playing NTSC discs.

Sound

Dynamic Range Compression

You can listen at low volumes but still hear dialog clearly. (Dolby Digital, Dolby Digital Plus and Dolby TrueHD only)

- “Auto” is effective only when playing Dolby TrueHD.
-

Digital Audio Output

Press [OK] to show the following settings.

Dolby D/Dolby D +/Dolby TrueHD DTS/DTS-HD

Select the audio signal to output.

- Select “PCM”, when the connected equipment cannot decode the respective audio format. This unit decodes the audio format and transmits to the connected equipment.
 - Not making the proper settings may result in noise.
-

BD-Video Secondary Audio

Select whether to mix or not mix the primary audio and secondary audio (including the button click sound). (⇒ 16)

- If “Off” is selected, the unit outputs the primary audio only.
-

Downmix

Select the downmix system of multi-channel to 2-channel sound.

- Select “Surround encoded”, when the connected equipment supports the virtual surround function.
 - There is no effect on “Bitstream” via HDMI AV OUT.
 - The audio will be output in “Stereo” in the following cases:
 - AVCHD playback
 - Playback of secondary audio (including the button click sound).
-

Display

On-Screen Messages

Choose whether to show status messages automatically.

On-Screen Language

Choose the language for menus and on-screen messages.

Screen Saver Function

This is to prevent burn-in on the screen.

- When this is set to “On”:
 - If there is no operation for 10 minutes or more, DIRECT NAVIGATOR screen switches to HOME menu automatically.
 - While playing and pausing, etc., this function is not available.
 - As for Music [CD-DA] or MP3, regardless of the setting, if there is no operation for a while, DIRECT NAVIGATOR screen switches to the other states automatically.
-

Front Panel Display

Changes the brightness of the unit’s display.

- If “Automatic” is selected the display is dimmed during playback and bright except during playback.
-

Software Licence



Information about the software used by this unit is displayed.

TV / Device Connection

TV Aspect

Set to match the type of television connected.

When connected to a 4:3 aspect television and playing 16:9 ratio image:

4:3 Pan & Scan	The sides are cut off so the picture fills the screen. When playing BD-Video, video is output as "4:3 Letterbox".	
4:3 Letterbox	Black bands appear at the top and bottom of the picture.	

When connected to a 16:9 widescreen television and playing 4:3 ratio image:

16:9	Video is displayed as a 4:3 ratio image in the centre of the screen.
16:9 full	Video is displayed as a horizontally stretched 16:9 image.

HDMI Connection

Press [OK] to show the following settings:

HDMI Video Format

The items supported by the connected devices are indicated on the screen as "*". When any item without "*" is selected, the images may be distorted.

- If "Automatic" is selected, automatically selects the output resolution best suited to the connected television.
- To enjoy high-definition video up-converted to 1080p, you need to connect the unit directly to 1080p compatible HDTV (High Definition Television). If this unit is connected to an HDTV through other equipment, the other must also be 1080p compatible.

24p Output

When this unit is connected to a TV supporting 1080/24p output using an HDMI cable, movies and other material recorded at 24p are output at 24p.

- When BD-Video images other than 24p are played, images are output at 60p.
- 24p :
A progressive image recorded at a rate of 24 frames per second (motion-picture film). Many BD-Video movie contents are recorded in 24 frames/second in accordance with the film materials.

HDMI Audio Output

This setting selects whether or not to output audio from HDMI.

VIERA Link

Set to use "HDMI Control" function when connected with an HDMI cable to a device that supports "HDMI Control".

- Select "Off" when you do not want to use "HDMI Control".

Deep Colour Output

This setting is for selecting whether to use Deep Colour Output when a television that supports Deep Colour is connected.

Contents Type Flag

Depending on the playback content, the TV will output adjusting to the optimal method when a TV that supports this function is connected.

TV System

Perform the setup so it matches the TV System of the connected TV.

- When NTSC contents are played, they are outputted in the signal format specified in the "NTSC Contents Output", irrespective of the settings here.

Network

Network Easy Setting (⇒ 11)

Network Settings

Perform network-related settings individually.

Press [OK] to show the following settings:

IP Address / DNS Settings

This is for checking the state of the network connection and setting the IP address and DNS-related. Press [OK] to show the respective setting.

- "Connection Speed Setting" is enabled only when "Connection Speed Auto-Config" is turned "Off".

Proxy Server Settings

This is for checking the state of connection with the Proxy server and performing settings.

Press [OK] to show the respective setting.

MAC Address

Displays the MAC address of this unit.

Remote Control

Change the remote control code if other Panasonic products react to this remote control.

Quick Start

Speed of startup from standby mode is increased.

- Internal control unit will be powered when it is set to "On" so compared to when the setting is "Off" the following will occur.
 - Idle power consumption will increase. (about the power consumption ⇨ 31)
-

Easy Setting

You can execute basic settings ("On-Screen Language", "TV Aspect", "Quick Start")

Default Settings

This returns all values in the Setup menu and the playback menu, except for "Remote Control", "On-Screen Language", "IP Address / DNS Settings", "Proxy Server Settings", "DVD-Video Ratings" and "BD-Video Ratings" etc. to the default settings.

DivX Registration (⇨ 17)

You need this registration code to purchase and play DivX Video-on-Demand (VOD) content.

System Information

Display firmware version of this unit.

Firmware Update (⇨ 12)

Press [OK] to show the following settings:

Automatic Update Check

When this equipment remains connected to the Internet, it will check for the latest firmware version when it is turned on and you can update it if necessary.

Update Now

You can update the firmware manually if a firmware update is available.

Troubleshooting guide

Before requesting service, please perform the following checks.
If the problem remains unresolved, consult your dealer for instructions.

Do you have the latest firmware installed?

Firmware updates may be released to correct operating irregularities that are discovered with certain movies.
(⇒ 12)

The following do not indicate a problem with this unit:

- Regular disc rotating sounds.
- Image disturbance during search.

■ Unit doesn't respond to remote control or front panel buttons.

Disconnect the AC mains lead, wait 1 minute, then reconnect the AC mains lead.

■ Cannot eject disc.

The unit may have a problem.

- ① While the unit is on, press and hold [OK], the yellow button and the blue button on the remote control at the same time for more than 5 seconds.
 - “00 rEt” is displayed on the unit's display.
- ② Repeatedly press [▶] (right) on the remote control or [⏏/I] on the unit until “06 FtO” is displayed on the unit's display.
- ③ Press [OK] on the remote control or [▲ OPEN/CLOSE] on the unit.

General operation

To return to the factory preset.

- Select “Yes” in “Default Settings” in the Setup menu.
(⇒ 27)

To return all settings to the factory preset.

- Reset the unit as follows:
- ① While the unit is on, press and hold [OK], the yellow button and the blue button on the remote control at the same time for more than 5 seconds.
 - “00 rEt” is displayed on the unit's display.
 - ② Repeatedly press [▶] (right) on the remote control or [⏏/I] on the unit until “08 Fln” is displayed on the unit's display.
 - ③ Press and hold [OK] on the remote control or [▲ OPEN/CLOSE] on the unit for at least 4 seconds.

The remote control doesn't work properly.

- Change the batteries in the remote control. (⇒ 4)
- The remote control and main unit are using different codes. If “SEt □” is displayed on the unit's display when a button is pressed on the remote control, change the code on the remote control. (⇒ 27)

The TV tuner mode is not displayed when the TV is switched on.

- This phenomenon may occur, depending on the TV setting, when “Quick Start” is set to “On”.
- Depending on the TV, this phenomenon may be prevented by reconnecting the HDMI cable to a different HDMI input terminal or by changing the HDMI auto connection setting.

You have forgotten your ratings password. You want to cancel the ratings level.

- The ratings level returns to the factory preset.
- ① While the unit is on, press and hold [OK], the yellow button and the blue button on the remote control at the same time for more than 5 seconds.
 - “00 rEt” is displayed on the unit's display.
 - ② Repeatedly press [▶] (right) on the remote control or [⏏/I] on the unit until “03 VL” is displayed on the unit's display.
 - ③ Press [OK] on the remote control or [▲ OPEN/CLOSE] on the unit.

This unit does not recognize the USB connection correctly.

- If inserted during playback the USB device may not be recognized by this unit.
- Disconnect and reconnect the USB cable. If it still does not recognize the connection, turn this unit off and on again.
- USB devices connected using a USB hub may not be recognized by this unit.
- If you connect USB HDD to this unit, use USB extension cable that is supplied with the HDD.

Picture

The images from this unit do not appear on the television.

Picture is distorted.

- An incorrect resolution is selected in “HDMI Video Format”. Reset the setting as follows:
 - ① While the unit is on, press and hold [OK], the yellow button and the blue button on the remote control at the same time for more than 5 seconds.
 - “00 rEt” is displayed on the unit’s display.
 - ② Repeatedly press [▶] (right) on the remote control or [⏏/I] on the unit until “04 PrG” is displayed on the unit’s display.
 - ③ Press and hold [OK] on the remote control or [▲ OPEN/CLOSE] on the unit for at least 4 seconds.
Set the item again. (⇒ 26)
- When Dolby Digital Plus, Dolby TrueHD, and DTS-HD audio are not output in bitstream, select “Yes” in “Default Settings” and make proper settings. (⇒ 27)
- The unit and television are using different video systems. Switch the setting as follows:
 - ① While the unit is on, press and hold [OK], the yellow button and the blue button on the remote control at the same time for more than 5 seconds.
 - “00 rEt” is displayed on the unit’s display.
 - ② Repeatedly press [▶] (right) on the remote control or [⏏/I] on the unit until “05 P/n” is displayed on the unit’s display.
 - ③ Press and hold [OK] on the remote control or [▲ OPEN/CLOSE] on the unit for at least 4 seconds.
The system switches from PAL to NTSC or vice versa.
- The system used on the disc doesn’t match your television.
 - PAL discs cannot be correctly viewed on an NTSC television.
 - This unit can convert NTSC signals to PAL60 for viewing on a PAL television (“NTSC Contents Output” in the “Picture”).

Video is not output in high-definition.

- Confirm that “HDMI Video Format” in the Setup menu are set properly. (⇒ 26)

A black band is displayed around the edge of the screen.

The aspect ratio of the screen is abnormal.

- Confirm the “TV Aspect” is set properly. (⇒ 26)
- Adjust the aspect setting on the television.

Audio

Cannot hear the desired audio type.

- Check the connections and the “Digital Audio Output” settings. (⇒ 9 , 25)
- To output audio from a device connected with an HDMI cable, set “HDMI Audio Output” to “On” in the Setup menu. (⇒ 26)

Playback

Disc cannot be played.

- The disc is dirty. (⇒ 4)
- Check the region code. (⇒ 7)

Still pictures (JPEG) do not playback normally.

- The images that were edited on the PC, such as Progressive JPEG, etc., may not playback.

I can’t playback BD-Live.

- Confirm that this unit is connected to the broadband Internet. (⇒ 9)
- Confirm the “BD-Live Internet Access” settings. (⇒ 24)
- Confirm a USB device is inserted into the USB port. (⇒ 13)

Network

I can’t connect to the network.

- Confirm the network connection and settings. (⇒ 9, 11, 26)
- Check the operating instructions for each device and connect accordingly.

Messages

The following messages or service numbers appear on the television or unit's display when something unusual is detected during startup and use.

On the television

Cannot play.

- You inserted an incompatible disc.

Cannot play on this unit.

- You tried to play a non-compatible image.

No disc is inserted.

- The disc may be upside down.

⊘ This operation is not available.

- Some operations are unsupported by the unit. For example;
 - Reverse slow-motion is not possible.

IP address is not set.

- The "IP Address" in "IP Address / DNS Settings" is "---. ---. ---. ---". Set the "IP Address", "Subnet Mask", and "Gateway Address". (Select the automatic address acquisition if necessary.)

On the unit's display

SEt □

("□" stands for a number.)

- The remote control and main unit are using different codes. Change the code on the remote control.

Press and hold [OK] and the indicated number button at the same time for more than 5 seconds.



H□□ or F□□

("□" stands for a number.)

- There is something unusual.
- Check the unit using the troubleshooting guide. If the service number does not disappear, do the following.
 - ① Disconnect the plug from the household mains socket wait a few seconds, then reconnect it.
 - ② Press [⏻/⏪] to turn the unit on. (The unit may be fixed.)If the service number does not disappear despite doing the above, request service from the dealer. Inform the dealer of the service number when requesting service.

Specifications

Signal system: PAL/NTSC

Operating temperature range: +5 °C to +35 °C

Operating humidity range: 10 % to 80 % RH (no condensation)

Video output: 1.0 Vp-p (75 Ω)/Pin jack: 1 system

Audio output: 2 Vrms (1 kHz, 0 dB)/Pin jack

Number of connectors : 2 channel: 1 system

HDMI AV output: Type A (19 pin) : 1 system

This unit supports "HDAVI Control 1" function.

USB slot: USB2.0 : 1 system

Ethernet: 10BASE-T/100BASE-TX : 1 system

LASER Specification

Class 1 LASER Product:

Wave length: 790 nm (CDs)/655 nm (DVDs)/405 nm (BDs)

Laser power: No hazardous radiation is emitted with the safety protection

Power supply: AC 220 to 240 V, 50 Hz

Power consumption: Approx. 12 W

Power consumption in standby mode: **Approx. 0.2 W**

Power consumption in quick start standby mode:

Approx. 3.6 W

Dimensions (W×D×H) Including the projecting parts:

430 mm×185 mm×35 mm

Mass: Approx. 1.6 kg

Specifications are subject to change without notice.

File format

File format	Extension	Reference
MP3	".MP3", ".mp3"	ID3 tags (Only titles and the names of artists)
JPEG	".JPG", ".jpg"	<ul style="list-style-type: none"> MOTION JPEG and Progressive JPEG is not supported. You may not be able to play back the file if you have edited the folder structure or the file name on a PC or other device.
DivX	".DIVX", ".divx", ".AVI", ".avi"	<ul style="list-style-type: none"> The video file and subtitles text file are inside the same folder, and the file names are the same except for the file extensions. Some DivX and MKV file may not be played back, depending on the video resolution and frame rate condition.
	Subtitles text file ".SRT", ".srt", ".SUB", ".sub", ".TXT", ".txt"	
MKV	".MKV", ".mkv"	
	Subtitles text file ".SRT", ".srt", ".SSA", ".ssa", ".ASS", ".ass"	

- With certain recording states and folder structures, the play order may differ or playback may not be possible.

Audio information

The audio output differs depending on the settings on the unit. (⇒ 25, Digital Audio Output)

- The number of channels listed is the maximum possible number of output channels when connected to amplifier/receiver compatible with the respective audio format.

Terminal	"Digital Audio Output"	
	"Bitstream"	"PCM" ²
HDMI AV OUT	Outputs using original audio ¹	BD-Video : 7.1ch PCM ¹ DVD-Video : 5.1ch PCM

¹ When "BD-Video Secondary Audio" is set to "On", the audio will be output as Dolby Digital, DTS Digital Surround or 5.1ch PCM.

² The maximum possible number of Dolby sound is 2ch PCM.

Supplemental information

■ TV code list

Brand	TV Code	Brand	TV Code
Panasonic	01/02/03/04	NEC	36
AIWA	35	NOBLEX	33
AKAI	27/30	NOKIA	25/26/27/60/61
BEKO	05/71/72/73/74	NORDMENDE	10
BENQ	58/59	OLEVIA	45
BRANDT	10/15	ONWA	30/39/70
BUSH	05	ORION	05
CENTREX	66	PEONY	49/69
CURTIS	05	PHILCO	41/48/64
DAEWOO	64/65	PHILIPS	05/06/46
DESMET	05	PHONOLA	05
DUAL	05	PIONEER	37/38
ELEMIS	05	PROVIEW	52
FERGUSON	10/34	PYE	05
FINLUX	61	RADIOLA	05
FISHER	21	SABA	10
FUJITSU	53	SALORA	26
FUNAI	63/67	SAMSUNG	32/42/43/65/68
GOLDSTAR	05/50/51	SANSUI	05
GOODMANS	05	SANYO	21/54/55/56
GRADIENTE	36	SCHNEIDER	05/29/30
GRUNDIG	09	SEG	05/69/75/76/77/78
HITACHI	05/22/23/40/41	SELECO	05/25
IRRADIO	30	SHARP	18
ITT	25	SIEMENS	09
JVC	17/30/39/70	SINUDYNE	05
KDS	52	SONY	08
KOLIN	45	TCL	31/33/66/67/69
KONKA	62	TELEFUNKEN	10/11/12/13/14
LG	05/50/51	TEVION	52
LOEWE	07/46	THOMSON	10/15/44
MAG	52	TOSHIBA	16/57
METZ	05/28/79	WHITE	05
MITSUBISHI	05/19/20/47	WESTINGHOUSE	05
MIVAR	24	YAMAHA	18/41

■ Display languages list

Display Language	Display Language	Display Language			
ENG	English	JPN	Japanese	ARA	Arabic
FRA	French	CHI	Chinese	HIN	Hindi
DEU	German	KOR	Korean	PER	Persian
ITA	Italian	MAL	Malay	IND	Indonesian
ESP	Spanish	VIE	Vietnamese	MRI	Maori
NLD	Dutch	THA	Thai	BUL	Bulgarian
SVE	Swedish	POL	Polish	RUM	Romanian
NOR	Norwegian	CES	Czech	GRE	Greek
DAN	Danish	SLK	Slovak	TUR	Turkish
POR	Portuguese	HUN	Hungarian	*	Others
RUS	Russian	FIN	Finnish		

■ Language code list

Language	Code	Language	Code	Language	Code
Abkhazian	6566	Gujarati:	7185	Rhaeto-Romance:	
Afar:	6565	Hausa:	7265	Romanian:	8277
Afrikaans:	6570	Hebrew:	7387	Russian:	8285
Albanian:	8381	Hindi:	7273	Samoan:	8377
Amharic:	6577	Hungarian:	7285	Sanskrit:	8365
Arabic:	6582	Icelandic:	7383	Scots Gaelic:	7168
Armenian:	7289	Indonesian:	7378	Serbian:	8382
Assamese:	6583	Interlingua:	7365	Serbo-Croatian:	8372
Aymara:	6589	Irish:	7165	Shona:	8378
Azerbaijani:	6590	Italian:	7384	Sindhi:	8368
Bashkir:	6665	Japanese:	7465	Singhalese:	8373
Basque:	6985	Javanese:	7487	Slovak:	8375
Bengali; Bangla:	6678	Kannada:	7578	Slovenian:	8376
Bhutani:	6890	Kashmiri:	7583	Somali:	8379
Bihari:	6672	Kazakh:	7575	Spanish:	6983
Breton:	6682	Kirghiz:	7589	Sundanese:	8385
Bulgarian:	6671	Korean:	7579	Swahili:	8387
Burmese:	7789	Kurdish:	7585	Swedish:	8386
Byelorussian:	6669	Laotian:	7679	Tagalog:	8476
Cambodian:	7577	Latin:	7665	Tajik:	8471
Catalan:	6765	Latvian, Lettish:	7686	Tamil:	8465
Chinese:	9072	Lingala:	7678	Tatar:	8484
Corsican:	6779	Lithuanian:	7684	Telugu:	8469
Croatian:	7282	Macedonian:	7775	Thai:	8472
Czech:	6783	Malagasy:	7771	Tibetan:	6679
Danish:	6865	Malay:	7783	Tigrinya:	8473
Dutch:	7876	Malayalam:	7776	Tonga:	8479
English:	6978	Maltese:	7784	Turkish:	8482
Esperanto:	6979	Maori:	7773	Turkmen:	8475
Estonian:	6984	Marathi:	7782	Twi:	8487
Faroese:	7079	Moldavian:	7779	Ukrainian:	8575
Fiji:	7074	Mongolian:	7778	Urdu:	8582
Finnish:	7073	Nepali:	7865	Uzbek:	8590
French:	7082	Norwegian:	7879	Vietnamese:	8673
Frisian:	7089	Oriya:	7982	Volapük:	8679
Galician:	7176	Pashto, Pushto:	8083	Welsh:	6789
Georgian:	7565	Persian:	7065	Wolof:	8779
German:	6869	Polish:	8076	Xhosa:	8872
Greek:	6976	Portuguese:	8084	Yiddish:	7473
Greenlandic:	7576	Punjabi:	8065	Yoruba:	8979
Guarani:	7178	Quechua:	8185	Zulu:	9085

■ Unit's display list

This list only contains displays that are difficult to read.

Display	Reading	Display	Reading
BYE	BYE	OPEN	OPEN
READ	READ	PLAY	PLAY
STOP	STOP	SETUP	SETUP
NET	NET	F99	F99
noPLAY	No PLAY	noUPdt	No UPDATE
SEt 2	SET □*	StArT	START
UPd 1-5	UPD□-5*	F In ISH	FINISH
St ILLP	STILLP	P-L ISt	P-LIST
SL IdE	SLIDE	rEPEArE	REPEAT
nod ISC	No DISC	noPLAY	No PLAY
noREAd	No READ	UnLOC	UNLOCK
bd-J	BD-J	d ISC	DISC
-----	UNSUPPORT		

* "□" stands for a number.

This product incorporates the following software:

- (1) the software developed independently by or for Panasonic Corporation,
- (2) the software owned by third party and licensed to Panasonic Corporation,
- (3) the software licensed under the GNU General Public License, Version 2 (GPL v2),
- (4) the software licensed under the GNU LESSER General Public License, Version 2.1 (LGPL v2.1) and/or,
- (5) open sourced software licensed under its applicable license terms including but not limited to ICU License, c-arse license.

For the software categorized as (3) and (4), please refer to the terms and conditions of GPL v2 and LGPL v2.1, as the case may be at <http://www.gnu.org/licenses/old-licenses/gpl-2.0.html> and <http://www.gnu.org/licenses/old-licenses/lgpl-2.1.html>. In addition, the software categorized as (3) and (4) are copyrighted by several individuals. Please refer to the copyright notice of those individuals at <http://www.am-linux.jp/dl/AWBP11>

The GPL/LGPL software is distributed in the hope that it will be useful, but WITHOUT ANY WARRANTY, without even the implied warranty of MERCHANTABILITY or FITNESS FOR A PARTICULAR PURPOSE.

At least three (3) years from delivery of products, Panasonic will give to any third party who contacts us at the contact information provided below, for a charge no more than our cost of physically performing source code distribution, a complete machine-readable copy of the corresponding source code covered under GPL v2/LGPL v2.1.

Contact Information
cdrequest@am-linux.jp

Source code is also freely available to you and any other member of the public via our website below.
<http://www.am-linux.jp/dl/AWBP11>

For Open Source Software Programs categorized as (5), please refer to the applicable license terms listed below and/or included in the "License" menu on Product.

ICU License - ICU 1.8.1 and later

COPYRIGHT AND PERMISSION NOTICE

Copyright (c) 1995-2010 International Business Machines Corporation and others

All rights reserved.

Permission is hereby granted, free of charge, to any person obtaining a copy of this software and associated documentation files (the "Software"), to deal in the Software without restriction, including without limitation the rights to use, copy, modify, merge, publish, distribute, and/or sell copies of the Software, and to permit persons to whom the Software is furnished to do so, provided that the above copyright notice(s) and this permission notice appear in all copies of the Software and that both the above copyright notice(s) and this permission notice appear in supporting documentation.

THE SOFTWARE IS PROVIDED "AS IS", WITHOUT WARRANTY OF ANY KIND, EXPRESS OR IMPLIED, INCLUDING BUT NOT LIMITED TO THE WARRANTIES OF MERCHANTABILITY, FITNESS FOR A PARTICULAR PURPOSE AND NONINFRINGEMENT OF THIRD PARTY RIGHTS. IN NO EVENT SHALL THE COPYRIGHT HOLDER OR HOLDERS INCLUDED IN THIS NOTICE BE LIABLE FOR ANY CLAIM, OR ANY SPECIAL INDIRECT OR CONSEQUENTIAL DAMAGES, OR ANY DAMAGES WHATSOEVER RESULTING FROM LOSS OF USE, DATA OR PROFITS, WHETHER IN AN ACTION OF CONTRACT, NEGLIGENCE OR OTHER TORTIOUS ACTION, ARISING OUT OF OR IN CONNECTION WITH THE USE OR PERFORMANCE OF THIS SOFTWARE.

Except as contained in this notice, the name of a copyright holder shall not be used in advertising or otherwise to promote the sale, use or other dealings in this Software without prior written authorization of the copyright holder.

All trademarks and registered trademarks mentioned herein are the property of their respective owners.

c-arse license

Copyright 1998 by the Massachusetts Institute of Technology.

Permission to use, copy, modify, and distribute this software and its documentation for any purpose and without fee is hereby granted, provided that the above copyright notice appear in all copies and that both that copyright notice and this permission notice appear in supporting documentation, and that the name of M.I.T. not be used in advertising or publicity pertaining to distribution of the software without specific, written prior permission.

M.I.T. makes no representations about the suitability of this software for any purpose. It is provided "as is" without express or implied warranty.

Java and all Java-based trademarks and logos are trademarks or registered trademarks of Sun Microsystems, Inc. in the United States and other countries.

Manufactured under license from Dolby Laboratories. Dolby and the double-D symbol are trademarks of Dolby Laboratories.

Manufactured under license under U.S. Patent #'s: 5,451,942; 5,956,674; 5,974,380; 5,978,762; 6,226,616; 6,487,535; 7,392,195; 7,272,567; 7,333,929; 7,212,872 & other U.S. and worldwide patents issued & pending. DTS and the Symbol are registered trademarks, & DTS-HD, DTS-HD Master Audio | Essential and the DTS logos are trademarks of DTS, Inc. Product includes software. © DTS, Inc. All Rights Reserved.

This item incorporates copy protection technology that is protected by U.S. patents and other intellectual property rights of Rovi Corporation. Reverse engineering and disassembly are prohibited.

HDMI, the HDMI Logo, and High-Definition Multimedia Interface are trademarks or registered trademarks of HDMI Licensing LLC in the United States and other countries.

This product is licensed under the AVC patent portfolio license and VC-1 patent portfolio license for the personal and non-commercial use of a consumer to (i) encode video in compliance with the AVC Standard and VC-1 Standard ("AVC/VC-1 Video") and/or (ii) decode AVC/VC-1 Video that was encoded by a consumer engaged in a personal and non-commercial activity and/or was obtained from a video provider licensed to provide AVC/VC-1 Video. No license is granted or shall be implied for any other use. Additional information may be obtained from MPEG LA, LLC. See <http://www.mpegla.com>.

HDAVI Control™ is a trademark of Panasonic Corporation.

"AVCHD" and the "AVCHD" logo are trademarks of Panasonic Corporation and Sony Corporation.

"DVD Logo" is a trademark of DVD Format/Logo Licensing Corporation.

MPEG Layer-3 audio coding technology licensed from Fraunhofer IIS and Thomson.

DivX®, DivX Certified® and associated logos are trademarks of DivX, Inc. and are used under license.

Windows is a trademark or a registered trademark of Microsoft Corporation in the United States and other countries.

DLNA, the DLNA Logo and DLNA CERTIFIED are trademarks, service marks, or certification marks of the Digital Living Network Alliance.

Information for Users on Collection and Disposal of Old Equipment and used Batteries



These symbols on the products, packaging, and/or accompanying documents mean that used electrical and electronic products and batteries should not be mixed with general household waste.

For proper treatment, recovery and recycling of old products and used batteries, please take them to applicable collection points, in accordance with your national legislation and the Directives 2002/96/EC and 2006/66/EC.

By disposing of these products and batteries correctly, you will help to save valuable resources and prevent any potential negative effects on human health and the environment which could otherwise arise from inappropriate waste handling.

For more information about collection and recycling of old products and batteries, please contact your local municipality, your waste disposal service or the point of sale where you purchased the items.

Penalties may be applicable for incorrect disposal of this waste, in accordance with national legislation.



For business users in the European Union

If you wish to discard electrical and electronic equipment, please contact your dealer or supplier for further information.

[Information on Disposal in other Countries outside the European Union]

These symbols are only valid in the European Union. If you wish to discard these items, please contact your local authorities or dealer and ask for the correct method of disposal.



Note for the battery symbol (bottom two symbol examples):

This symbol might be used in combination with a chemical symbol. In this case it complies with the requirement set by the Directive for the chemical involved.

Cd

CAUTION	- VISIBLE AND INVISIBLE LASER RADIATION WHEN OPEN. DO NOT STARE INTO BEAM. FDA 21 CFR/Class II (IIR)
CAUTION	- CLASS 1M VISIBLE AND INVISIBLE LASER RADIATION WHEN OPEN. DO NOT VIEW DIRECTLY WITH OPTICAL INSTRUMENTS. IEC60825-1 +A2/CLASS 1M
ATTENTION	- RAYONNEMENT LASER VISIBLE ET INVISIBLE, CLASSE 1M. EN CAS D'OUVERTURE, NE PAS REGARDER DIRECTEMENT A L'AIDE D'INSTRUMENTS OPTIQUES.
FORSIGTIG	- SYNLIG OG USYNLIG LASERSTRÅLING KLASSE 1M, NÅR LAGET ER ÅBENT; UNDGÅ AT SE LIGE PÅ MED OPTISKE INSTRUMENTER.
VARO	- AVATTAESSA OLET ALTTIINA LUOKAN 1M NÄKYVÄÄ JA NÄKYMÄTÖNTÄ LASERSÄTELYÄ. ÄLÄ KATSO OPTISELLÄ LAITTEELLA SUORAAN SÄTEESEEN.
VARNING	- KLASS 1M SYNLIG OCH OSYNLIG LASERSTRÅLNING NÅR DENNA DEL ÄR ÖPPNAD. BETRakta EJ STRÅLEN DIREKT GENOM OPTISKT INSTRUMENT.
VORSICHT	- SICHTBARE UND UNSICHTBARE LASERSTRHLUNG KLASSE 1M, WENN ABDECKUNG GEÖFFNET. NICHT DIREKT MIT OPTISCHEN INSTRUMENTEN BETRACHTEN.
注意	- 打开时有可见及不可见激光辐射。避免光束照射。
注意	- ここを覗くと可視及び不可視レーザー光が出ます。 ビームを見たり、触れたりしないでください。 VOL1V70

(Inside of product)
(Produktets innsida)



LUOKAN 1 LASERLAITE
KLASS 1 LASER APPARAT



Pursuant to at the directive 2004/108/EC, article 9(2)
Panasonic Testing Centre
Panasonic Marketing Europe GmbH
Winsbergring 15, 22525 Hamburg, Germany



Panasonic Corporation

Web Site: <http://panasonic.net>

© Panasonic Corporation 2011

En

VQT3A96
F011SS0