

Panasonic®

Operating Instructions & Installation Instructions Washing Machine (Domestic use)

Model No.

NA-140VG4

NA-148VG4



Read Before Using	4
SAFETY PRECAUTIONS	4
Washing Instructions	12
Optional Functions	20
Maintenance	22
Troubleshooting	25
Installation Instructions	30

Thank you for purchasing this appliance.

- For optimum performance and safety, please read these instructions carefully.
- Before connecting, operating or adjusting this appliance, please read the instructions completely. Please keep this manual for future reference.

Read Before Using

SAFETY PRECAUTIONS	4
Checking Your Washing Machine . . .	6
Your washing machine	6
Accessories	6
Before Washing	7
Checking before use	7
Before initial use	7
Preparing the laundry	7
Using the Buttons	8
Unlocking the door	9
Adding Detergent and Other	
Chemicals	10
Detergent compartment	10
Softener compartment	11
Prewashing compartment	11

Washing Instructions

Washing	12
Setting washing	12
Required time	13
Changing settings while washing . . .	13
Selecting the Programme	14
Details of Programmes	16
Tips for Washing	18
Wool, Silk/Lingerie, and Delicates	
programmes	18
Bedding programme	19
Outdoor programme	19
Optional Functions	20
Individual washing functions	20
Additional functions	20
Preset timer	21
Child safety lock	21
Setting the buzzer	21

Maintenance

Maintenance	22
Cleaning the outside of the	
appliance	22
Cleaning the drum	22
Cleaning the detergent drawer	22
Cleaning the door seal and window . .	23
Cleaning the drain filter	23
Cleaning the water supply filter	24
Preventing a frozen water supply	
hose	24

Troubleshooting

Fault Checklist	25
Error Display	29

Installation Instructions

Choosing the Right Location	30
Carrying the appliance	30
The right place for the appliance . . .	30
Installing the set-in appliance	31
Moving and Installing	32
Removing the anchor bolts	32
Moving the appliance	32
Levelling the appliance	33
Connecting Hoses and Power	
Supply	34
Hoses and cable lengths	34
Water supply hose	34
Water drain hose	35
Connecting to the power supply . . .	35
Checking after Installation	36
Installation checklist	36
Test run after installation	37
Consider the Environment	38
Power and Water Consumption	39
Specifications	40

SAFETY PRECAUTIONS

Read and follow these safety precautions.



WARNING

This describes issues which could cause death or serious injury.

General Use

- This appliance is not intended for use by persons (including children) with reduced physical, sensory or mental capabilities, or lack of experience and knowledge, unless they have been given supervision or instruction concerning use of the appliance by a person responsible for their safety.
- Children should be supervised to ensure that they do not play with the appliance.
- Do NOT place a stand or a chair close to the appliance.
Children may reach the control panel or climb onto or into the appliance.
- Turn off the water supply to the appliance if it will not be used for a prolonged period, such as during a holiday. This is particularly important if there is no drainage around the appliance.
If the water supply is left on, the water pressure may increase and result in a leak.
- Do NOT install the appliance in a damp location or in a location exposed to the weather.
This may result in product malfunction or deterioration, electric shock or fire.
- Do NOT spill water directly onto any part of the appliance.
This may result in malfunction, electric shock or fire.

- Keep sources of ignition, such as candles or cigarettes, away from the appliance.
They may cause a fire or damage to the appliance.
- Keep flammable materials away from the appliance, for example, gasoline, thinner, alcohol, or clothing soaked with these materials.
They may cause an explosion or a fire.

Power source and cable

- Unplug the mains lead when cleaning the appliance.
- Check the mains lead and mains plug for damage.
If the mains lead is damaged, it must be replaced by the manufacturer, its service agent or similarly qualified persons to avoid a hazard.
- Do NOT use a mains plug adaptor or extension cable. There is a possibility of overheating which may cause a fire. Use an unused household mains socket, fully rated at AC 220 V to 240 V. If you are not sure, contact a qualified electrician.
- ENSURE the mains plug is fully inserted into the household mains socket.
Otherwise, a loose connection may overheat and cause an electric shock or fire.
- Do NOT touch the mains lead or mains plug with wet hands.
Doing so may cause an electric shock.
- Do NOT pull the mains lead but hold the mains plug to unplug the appliance.
Otherwise, the mains lead may be damaged, which may lead to an electric shock or fire.

SAFETY PRECAUTIONS

To Prevent Injury

- The appliance should be installed by the manufacturer's dealer or service agent. If the installation, test run and inspection are not carried out following the installation method outlined in these instructions, the manufacturer will not be liable for any accident or damage caused.
- Do NOT dismantle, repair or modify the appliance. The appliance may malfunction, which may result in a fire or an injury. If repairs are needed, contact your local Customer Service Centre.
- Do NOT touch the laundry inside the drum until it has completely stopped, as there is a possibility of injury. Keep children away from the rotating drum.



CAUTION

This describes issues which could cause injury or damage your belongings.

General Use

- Prior to use, turn on the tap and check the hose and connections for any leaks. Improper connection could cause leaks.
- Use the new hose-sets supplied with the appliance and old hose-sets should not be reused.
- This appliance is only suitable for textiles labelled washing machine washable.
- Do NOT connect to the hot water supply. This appliance works ONLY with cold water.
- Do NOT apply pesticide, hair spray or deodorant to the appliance.

- Do NOT put any electrical equipment, for example, TV, radio or battery charger, on or near the appliance.
- Do NOT put excessive laundry or detergent into the appliance. This may cause damage to the appliance.
- REMOVE the anchor bolts using the supplied spanner or a similar tool before installing the appliance. The anchor bolts are used to transport the appliance. If the anchor bolts are not removed, the appliance will vibrate severely during use.

To Prevent Injury

- Do NOT climb onto the appliance. This may cause injury or damage to the appliance.
- Keep fingers away from the door hinge when opening and closing the door.
- Do NOT slide your hand (or unprotected foot) underneath the appliance when in use.
- Check all of the laundry and remove all objects such as nails, pins, coins, clips, metal wires, etc. They may cause damage to the laundry or the appliance.
- Do NOT use the appliance to wash waterproof sheets or clothing. There is a possibility of excessive vibration or failure during the spin cycle, which may result in an injury, damage to the appliance or a water leak.
- BE CAREFUL when draining hot water out of the drum.
- BE CAREFUL not to get laundry caught in the door seal when it is closed. This may result in a water leak or damage to the laundry during the wash cycle.

Checking Your Washing Machine

Your washing machine

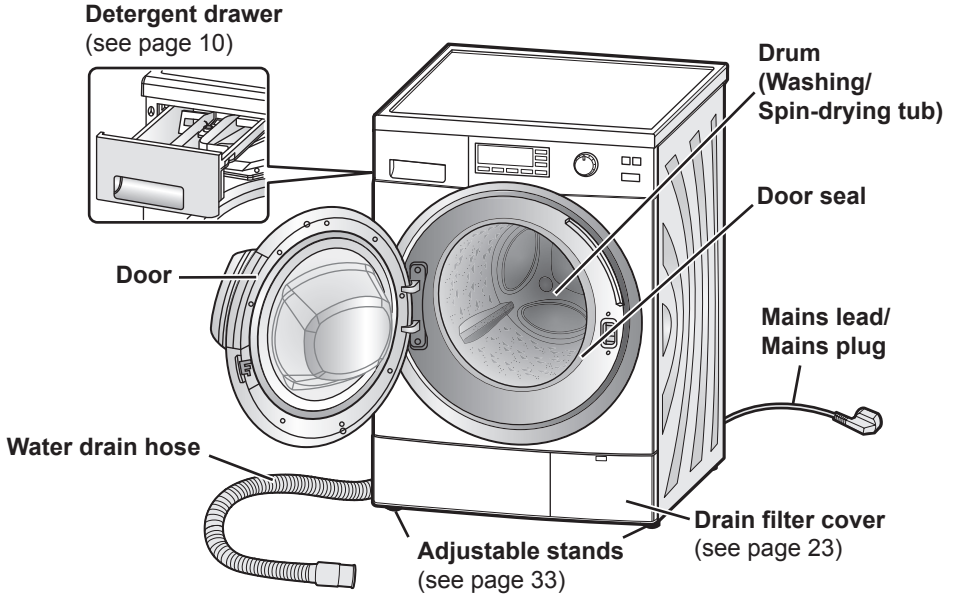

CAUTION

Do NOT bend the mains lead when the appliance is running.

Accessories

Make sure that all the accessories are supplied with the appliance.

Elbow (see page 35)

For fixing the water drain hose



Spanner (see pages 32-33)

End A is for adjusting the stand. End B is for the anchor bolts.



Cover cap (4) (see pages 32-33)

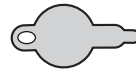

Water supply hose (see page 34)

Either one of these hoses is supplied with the appliance.

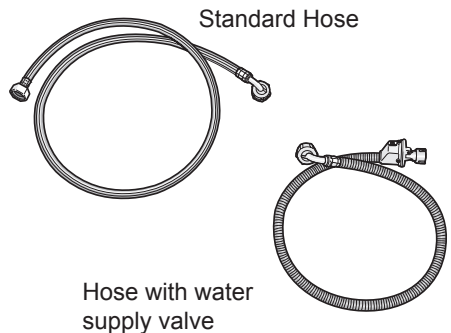

Before Washing

Checking before use

For the appliance's initial operation or after a prolonged period of non-operation, perform the following procedures:

1. **Secure the water supply hose.**
2. **Turn on the tap.**
3. **Connect the power supply.**
4. **Make sure that the water drain hose is positioned towards a drain.**

For more details, see page 35.

Before initial use

The default setting is the 40 °C Cotton programme. Before using the appliance for the first time, run the programme WITHOUT any detergent or clothing to rinse out residue or moisture.

NOTE

There may be residual water in the appliance due to the factory inspection prior to shipment. This is not a malfunction.

Preparing the laundry

Sorting the laundry

- Read clothing care labels to sort the laundry into different loads.
- Sort the laundry by colour, type of fabric and how soiled it is. Doing so will help you choose the correct programme and temperature for each wash.
- Clothes that are not colour fast should be washed separately. Wash denim separately.

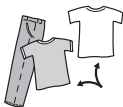

- You should put bras with metal wires, tights, lace clothing and small items into a laundry net to prevent them or the appliance from being damaged.

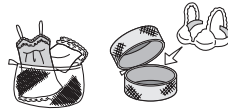

Treating stains

Apply stain remover to stained portions. For dirt and solid stains, wash lightly by hand first.

Checking clothing

- Check that the pockets on clothing do not contain any objects that may damage the clothes or the appliance.



- Tie up any loose strings on the clothing and close zippers. Turn clothing with raised fabrics and zippers inside out. Otherwise, the clothes may be damaged.

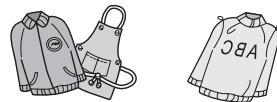

- Remove any hair, animal fur, sand and other materials with a brush before washing.



NOTE

Do not wash clothes heavily stained with large quantities of vegetable oil or cosmetic oil (aroma oil, etc.). Failure to observe this may result in the door seal swelling, causing the water to overflow and leading to malfunctions.

Using the Buttons

Model NA-148VG4

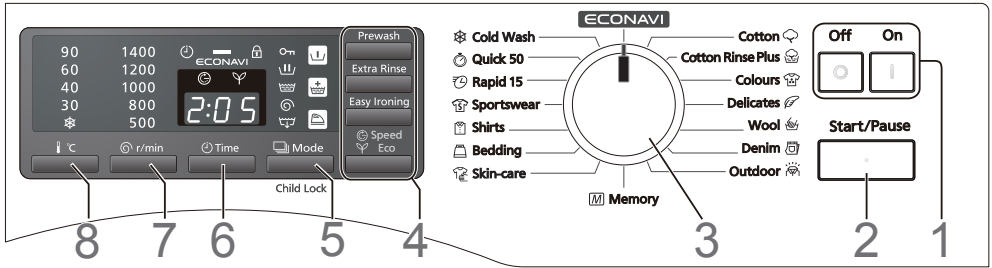

1. Power buttons

- If you do not press the Start button within 10 minutes after the appliance has been switched on, the appliance automatically switches itself off.
- The display below appears for 3 seconds after the appliance has been switched off. You cannot turn the appliance on until this display disappears.



2. Start/Pause button

Press this button to start or pause the wash programme.

3. Programme selection dial

Use this dial to choose the best programme for the laundry.
(See pages 14-15.)

4. Additional function buttons

Press these buttons to add functions to the programme to suit the laundry.
(See page 20.)

5. Mode/Child Lock button

- Press this button to select the function of processes, for example, the Rinse and Spin function or the Drain only function.
(See page 20.)
- Press and hold this button to set the child safety lock. The door and the controls will be locked.
(See page 21.)

6. Time button

Press this button to preset the time for when the programme finishes.
(See page 21.)

7. Spin speed button



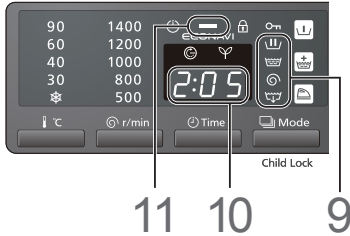

Press this button to see the spin speed (r/min) or to choose the spin speed for the programme you have selected.
(See page 17.)

8. Temperature button

Press this button to choose water temperatures ranging from cold to 90 °C. You can choose hotter temperatures for whites, cottons, or soiled laundry.



9. Process indicator

- This indicator shows the current process of the programme. The process consists of wash , rinse , spin , and drain .
- The light turns off when the programme is finished.

10. Remaining time indicator

- This indicator shows the approximate time until the programme finishes. For example, '2:05' means 2 hours and 5 minutes.
- The time is calculated from the weight of the laundry measured when washing starts.

11. ECONAVI lamp (See page 12.)

Unlocking the door

The door automatically locks while in use and the  symbol is shown in locked state. A click will be heard when the door locks or unlocks.

NOTE

- If the appliance is switched off with the door locked, or if there is a power interruption, the door remains locked until the appliance is turned on again.
- This is different from the child safety lock. (See page 21.)

Press the Start button to unlock the door during operation.

After approximately 1 minute, the drum stops spinning and the door will automatically unlock.

If the door does not open, see page 25.

CAUTION

If you have to unlock the door mid-programme, make sure that water from the drum does not overflow onto the floor.

Water and soap suds may come out of the door and the door opening. You may need a towel to soak them up.

Adding Detergent and Other Chemicals

Pull out the detergent drawer and add detergent or softener to the correct compartment. Check the packages for the recommended amounts.

CAUTION

Do NOT use the appliance when the detergent drawer is removed.

This may result in a water leak.

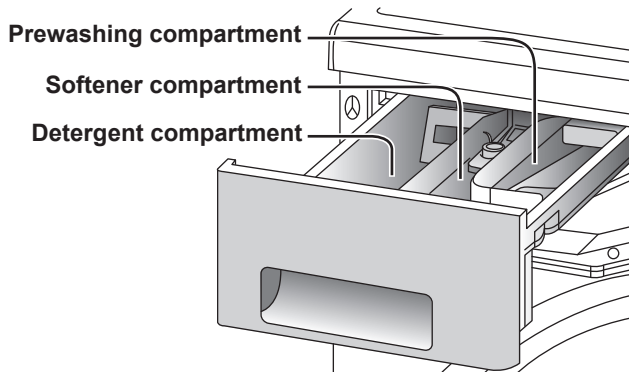

Detergent compartment

The following detergents and additives may be added to this compartment:

- Detergent
- Water softening agent
- Stain remover
- Tub cleaning detergent or bleach

If you use multiple chemicals in this compartment for washing, add them in the following order:

1. Detergent
2. Water softening agent
3. Stain remover

Detergent

Use only detergents that are recommended for fully-automated washing machines. Please use low suds detergents.

CAUTION

If the instructions on the package indicate that detergent should be placed in the drum, do NOT put it into the detergent drawer.

These detergents may not flow well and remain in the detergent drawer. Do not overfill with detergent. Failure to observe this may result in the detergent blocking the water supply, causing the water to overflow from the front of the detergent drawer and leading to malfunctions.

1. Liquid detergent

NOTE

Do NOT use liquid detergent with the Prewash function. It may flow away during the prewash.

For the Wool programme, use mild liquid detergent.

Adding Detergent and Other Chemicals

2. Powdered detergent

Detergent reaches the drum only when water flushes through the detergent drawer. Thus, if you have forgotten to add detergent, run the Drain only function using the Mode button.

Then, add detergent and start washing again.

To prevent powdered detergent from remaining in the drawer, perform the following:

- Dry the inside of the drawer with a cloth.
- Make sure that the detergent is not lumpy when you add it because this may cause a blockage over time.
- If the detergent remains in the detergent compartment, put it into the drum.

Amount of Detergent

The amount of detergent you should use depends on the following factors:

- How soiled the laundry is
- Amount of the laundry
- Water hardness

The amount of foam varies according to the amount and type of detergent, how soiled the laundry is, and the hardness and temperature of the water.

Water softening agent

If you live in a hard water area (total hardness of 1.3 mmol/L or higher), we recommend using a water softening agent. For more details on water hardness, contact your local water authority.

Use of a water softening agent can help reduce the amount of detergent required for each wash and help prevent the formation of limescale deposits, which may damage the appliance.

Softener compartment

Fabric Softener

To prevent static, add softener before you start washing. It will be automatically added in the final rinse cycle.

If the softer remains in the softener compartment, dilute the softener before adding it. Add up to only 130 ml to the compartment to avoid overflowing.

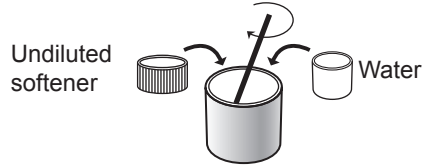

Rinse out the remaining softener with a splash of water or a damp cloth after washing. If it sticks to the compartment, pull out the drawer and clean it out. (See page 22.)

Prewashing compartment

Detergent for prewashing

Whenever you use programmes with the Prewash function, always put detergent for the prewash in this compartment.

Washing

Setting washing

Model NA-148VG4

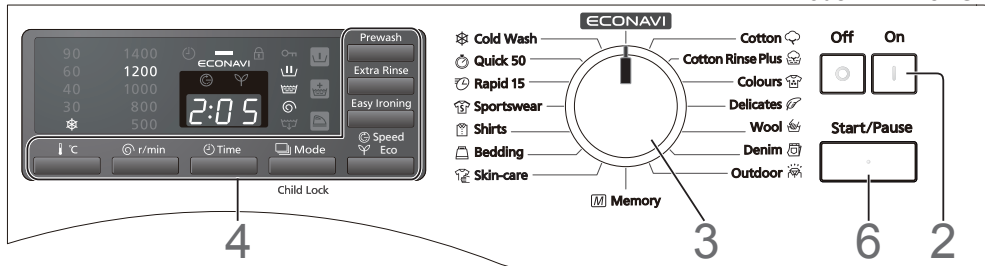

1. Open the door and put the laundry into the drum.

For details about preparing and sorting the laundry, see pages 7, 14, and 15.

NOTE

- **Make sure to place the laundry within the drum so that it does not get caught in the door.**

Failure to observe this may result in damage to the door seal, leading to malfunctions.



- **Do NOT overload the drum.**

This may cause excessive vibration or damage to the appliance.

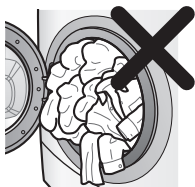

2. Close the door and press the On button.

3. Turn the programme selection dial in either direction to select the programme.

The programme time will be displayed.

ECONAVI programme

This programme detects the laundry amount and types (cotton, chemical fibre, etc.) and determines the best suited wash time and water amount to save energy and water.

The wash time and water amount can be saved more with smaller amount of laundry, larger amount of clothes that easily dry, such as chemical fibre, or with higher temperature.

- Lamp indications
Blinking: Detecting
Lighting: In ECONAVI operation
OFF: Not in ECONAVI operation

4. Select optional functions.

- Process selection (see page 20.)
- Additional functions (see page 20.)
- Temperature (see page 8.)
- Spin speed (see page 8.)

For more details about available functions and settings for each programme, see pages 16-17.

5. Add detergent to the detergent drawer.

(See pages 10-11.)

6. Press the Start button.

The appliance starts supplying water. After the appliance has started, the laundry is weighed. After approximately 5 seconds, a new programme time will be displayed. If you select the Wool, Silk/Lingerie, Rapid 15, Shirts, Sportswear, Bedding, Outdoor or Denim programmes, the laundry is not weighed.



The buzzer will sound when the programme has finished, and the door will unlock immediately.

Remove the laundry and rearrange where necessary. Do not leave it in the drum too long after the programme ends to prevent colour transfer.

CAUTION

After a high temperature wash, be careful not to burn yourself when handling the laundry or touching the inside of the drum.

NOTE

- If the detergent is not completely removed from the laundry by using the basic programme, use the Extra Rinse function.
- With the Eco and the Speed functions, if the load is big, the laundry may stick to the inside of the drum. This is normal.

Required time

Required time depends on the programme and temperature setting.









- Actual time may differ slightly from the displayed time.
- The displayed time includes the time needed for the water to fill up and to drain out, thus they vary depending on water pressure, drainage and amount of laundry.
- If you change the function setting while washing, the displayed time may change.
- If the laundry in the drum needs to be balanced, the time will be extended.

Changing settings while washing









After washing has started, the programme, temperature and preset time cannot be changed.

- To change the programme or temperature setting, turn the appliance off and then on again.
- To change the rinse or spin setting while washing, press the Pause button once the appliance is full of water.
- You can change the Spin speed, Extra Rinse and Easy Ironing function during the washing process.
- No settings can be changed after the washing process has finished.



















Selecting the Programme

Programme	Description	Max load	
		140VG4	148VG4
ECONAVI	For items with mixed fabrics, for example, cotton, linen and synthetic fibres. (For details about ECONAVI programme, see page 12.)	10 kg	8 kg
 Cotton	Daily washing for cotton, linen and cotton blend items. (For examples, T-shirts, underwear, towels, tablecloths.)	10 kg	8 kg
 Cotton Rinse Plus	Washing takes longer overall but rinsing is more thorough than the Cotton programme.	10 kg	8 kg
 Colours	For washing coloured cottons or coloured cotton blend items separately.	5 kg	4 kg
 Delicates	Gentle washing for synthetic fibres, textiles, satin, lace, etc.	5 kg	4 kg
 Wool	Gentle washing for hand wash only wool, machine washable wool, and wool blends.	2 kg	2 kg
 Silk/Lingerie	For lingerie and washable silk items. Washes gentler than the Wool programme.	2 kg	—
 Denim	The spray washing is used to prevent jeans from fading.	—	2 kg
 Mixed	For items with mixed fabrics, for example, cotton, linen and synthetic fibres.	10 kg	—
 Outdoor	For synthetic fabric outdoor wear and water-repellent clothing.	—	3 kg

Selecting the Programme

Programme	Description	Max load	
		140VG4	148VG4
 Memory	Programme based on the Cotton programme featuring selected optional functions and settings. Select Memory programme and set other settings, then run the programme.	10 kg	8 kg
 Baby-care	For babywear.	5 kg	—
 Skin-care	For items that need to be gentle to the skin, for example, underwear, sheets, towels, and baby clothes. Items are spray washed and thoroughly rinsed.	—	4 kg
 Bedding	For large items, for example, blankets, curtains, and bedspreads.	3 kg	3 kg
 Shirts	For shirts and blouses.	2 kg	2 kg
 Sportswear	For synthetic sportswear.	3 kg	3 kg
 Rapid 15	Washes a few lightly soiled items in 15 minutes.	2 kg	2 kg
 Quick 50	Washes lightly soiled items in 50 minutes.	5 kg	4 kg
 Cold Wash	Washes laundry without warming up water. For cottons and linen blends.	10 kg	8 kg

Details of Programmes

Programme	Available programme		Auto setting				
	140VG4	148VG4	Temperature	Number of rinses	Spin speed	Approximate 140VG4	
ECONAVI	✓	✓	Cold	2	1200	0:51 - 2:10	
 Cotton	✓	✓	40 °C	2	1200	1:15 - 2:15	
 Cotton Rinse Plus	✓	✓	40 °C	2	1200	1:22 - 2:12	
 Colours	✓	✓	40 °C	2	1200	0:58 - 1:23	
 Delicates	✓	✓	40 °C	2	800	0:55 - 1:00	
 Wool	✓	✓	30 °C	3	500	0:40	
 Silk/Lingerie	✓	—	30 °C	3	500	0:40	
 Denim	—	✓	30 °C	2	800	—	
 Mixed	✓	—	40 °C	2	1200	1:09 - 1:44	
 Outdoor	—	✓	30 °C	3	800	—	
 Memory	✓	✓	—	—	—	—	
 Baby-care	✓	—	40 °C	3	1200	1:29 - 2:04	
 Skin-care	—	✓	40 °C	3	1200	—	
 Bedding	✓	✓	30 °C	2	800	1:02	
 Shirts	✓	✓	40 °C	2	500	1:08	
 Sportswear	✓	✓	40 °C	2	800	1:30	
 Rapid 15	✓	✓	30 °C	1	800	0:15	
 Quick 50	✓	✓	40 °C	2	1200	0:46 - 0:49	
 Cold Wash	✓	✓	Cold	2	1200	1:37 - 2:42	

Details of Programmes

time	Manual setting		Additional functions			
	Temperature	Spin speed	Eco/Speed	Extra Rinse	Prewash	Easy Ironing
148VG4						
0:51 - 2:05	Cold - 60 °C	800 - 1400	—	—	—	—
1:15 - 2:10	Cold - 90 °C	500 - 1400	✓	✓	✓	✓
1:22 - 1:57	Cold - 90 °C	500 - 1400	✓	✓	✓	✓
0:58 - 1:13	Cold - 40 °C	500 - 1400	✓	✓	✓	✓
0:55 - 1:00	Cold - 40 °C	500 - 800	—	✓	✓	✓
0:40	Cold - 40 °C	500	—	✓	—	—
—	Cold - 40 °C	500	—	✓	—	—
0:55	Cold - 40 °C	500 - 1200	✓	✓	✓	✓
—	Cold - 40 °C	500 - 1400	✓	✓	✓	✓
1:48	Cold - 40 °C	800	✓	✓	✓	—
—	Cold - 90 °C	500 - 1400	✓	✓	✓	✓
—	Cold - 90 °C	500 - 1200	✓	✓	✓	✓
1:29 - 1:49	Cold - 90 °C	500 - 1200	✓	✓	✓	✓
1:02	Cold - 40 °C	500 - 800	—	✓	—	✓
1:08	Cold - 60 °C	500 - 800	✓	✓	✓	✓
1:30	Cold - 40 °C	500 - 1200	✓	✓	✓	✓
0:15	Cold - 30 °C	500 - 800	—	—	—	—
0:46 - 0:49	Cold - 60 °C	500 - 1400	—	✓	✓	✓
1:37 - 2:27	Cold	500 - 1400	—	✓	✓	✓

Tips for Washing

Wool, Silk/Lingerie, and Delicates programmes

The drum spins gently in these programmes.

Laundry loads

- Wool programme: 2 kg or less
- Delicates programme: 5 kg or less (140VG4), 4 kg or less (148VG4)
- Silk/Lingerie programme: 2 kg or less (140VG4)

Approximate weights

- Wool sweater: 400 g



- Silk blouse: 200 g



- Trousers: 400 g

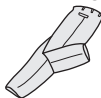

Putting laundry in the drum

Pile items one on top of each other.

Detergents

- For wool items, use a mild liquid detergent. Other detergents may damage the clothes.
- With Wool, Delicates, and Silk/Lingerie programmes, you may need to use the Extra Rinse function to remove excess detergent from the laundry. (See page 20.)

Hanging the laundry

- Hang out white or light-coloured wool and nylon items away from direct heat or sunlight.
- After washing, lay out wool and nylon clothes, and return them to their normal shape before hanging in the shade. This will help to reduce the ironing time.
- Hang wool items with creases smoothed out, or spread them out to dry.

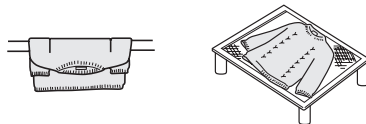

- Use hangers for shirts, blouses and trousers. You may wrap a towel around the hanger to approximate the clothing's shoulder width so that it will retain its shape as it dries.



If clothing shrinks in the wash

Spread the item out to its original size on an ironing board. Use dress pins to hold the size and shape. Then, use an iron to steam it and leave it to dry.



Bedding programme

- Make sure that the label of each item to be washed shows either the wash or hand-wash symbol (☰, ☱).
- Wash only one blanket at a time.

Available

- 100 % synthetic fibre blankets – up to 3 kg
- 100 % synthetic fibre futons and 100 % cotton blankets – up to 1.5 kg (single bed size)
- Sheets
- Bedspreads
- 100 % synthetic fibre undersheets

Not available

- 100 % wool blankets
- Long-piled blankets
- Electric blankets (including cover)

Putting bedding into the drum

1. Fold down the blanket or bedspread into a quarter of their original size.

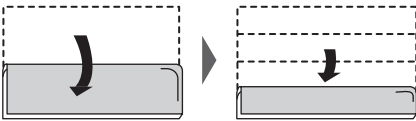

2. Put the blanket or bedspread into the drum.

Fold it while putting it into the drum.

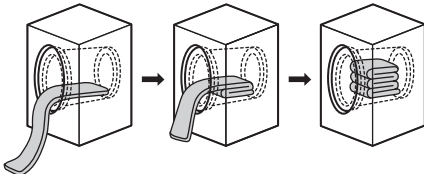

Both ends of the blanket should be face the rear of the drum.

CAUTION

Do NOT roll the blanket or bedspread into balls, or haphazardly fold them.

This may cause excessive vibration and damage the laundry or the appliance.

NOTE

Avoid using blanket nets. They prevent the laundry from spinning properly.

Outdoor programme

Make sure that the label of each item to be washed shows either the wash, handwash, or no dry cleaning symbol (☰, ☱, ☲).

Available

Synthetic fabric outdoor wear, for example, rainwear, outerwear jackets and trousers – up to 3 kg

Not available

- Clothing with cotton lining or padding, or down feathers
- Sleeping bags and synthetic fabric covers

NOTE

- Before washing, close any zippers and button up the clothing.
- Do not wash clothing in laundry nets by itself because the load will be unbalanced and not be smoothly washed.
- Water repellent finishes might be washed out over time. To restore water repellency, iron the garment with a low temperature setting, dry it in a dryer, or re-apply a commercially available water repellent treatment. If a treatment is used, follow the product's instructions, or the instructions in the garment.
- We recommend laying down towels in front of the appliance when taking out water-repellent clothing after the spin cycle because water may drip from the clothing.

Optional Functions

Individual washing functions







(Process selection)

You can select a single process, or combine several processes by selecting individual washing functions.

NOTE

You cannot select any mode functions in Rapid 15 programme.

Press the Mode button  to select a function.

Function	Description
Rinse only 	Rinse washed laundry (Rinse water remains)
Spin only 	Spin-dry washed laundry
Wash - Rinse  	Wash and rinse laundry (Rinse water remains)
Rinse - Spin  	Rinse and spin-dry washed laundry
Drain only 	Drain water from the drum

- Whenever you start washing, the process indication flashes to show which function is in progress.
- If water remains in the drum with the Rinse only, Spin only or Rinse - Spin function, the operation starts from the drain process.

Additional functions





Depending on the programme, you can combine different additional functions.

NOTE

Some additional functions cannot be used with certain programmes. (See pages 16-17.)

If you select an unavailable function, an error alarm will sound.

Press one or more of the function buttons  you wish to combine.

Function	Description
Eco 	Washing consumes less energy and water but takes longer.
Speed 	This function requires less time for washing and is suitable for lightly soiled laundry.
Extra Rinse 	Rinse your laundry more thoroughly with an extra rinsing process.
Prewash 	Prewash cycle for heavily soiled laundry
Easy Ironing 	<ul style="list-style-type: none"> - Make ironing easier by spin-drying your laundry more gently (at 800 r/min or less). - After the programme has finished, the laundry is rotated intermittently for up to 30 minutes or until the door is opened. - Reducing wrinkles helps to unravel tangled laundry.

You can activate or deactivate the Extra Rinse and Easy Ironing functions during a washing process but not after the process has finished.

Preset timer

Time function is available to preset the time for the programme to finish.

- You cannot preset the Wool and Silk/Lingerie programmes.
- The wash may finish before or after preset time depending on the kind of laundry, the temperature and conditions of water supply and drainage.

NOTE

Do NOT use detergent which does not dissolve thoroughly with the preset function because the detergent may cake up before the wash starts and does not flow out.

Setting a preset time

Press and hold the Time button until the desired preset time is displayed.

Changing a preset time

1. Press the Off button and then press the On button.
2. Choose the desired programme and optional functions.
3. Set a preset time.

Cancelling a preset time

Press the Off button. (All settings will be cancelled.)

Checking a preset time

Press the Time button.

Child safety lock

The child safety lock prevents children from climbing into the drum and getting trapped. This function keeps the door closed and locked even when the appliance is not in use. It also disables the control buttons.

Activating/deactivating child safety lock

1. Switch on the appliance.
2. Press and hold the Mode button for at least 5 seconds.
The  symbols light up to show that the child safety lock is activated.
3. To deactivate, hold down the Mode button again for 5 seconds (please ignore three beeps heard), and keep Mode button pressed until it unlocks.

Setting the buzzer

The buzzer that sounds when a programme finishes can be turned off.

1. Press the Start and On buttons at the same time.
2. Release the On button and keep pressing the Start button for 3 seconds. The buzzer setting will be turned off after a beep is heard.
If you wish to reset the setting, perform the same steps 1 and 2. The buzzer setting will be turned on after two beeps are heard.

Maintenance

Cleaning the outside of the appliance

Clean the outside of the appliance with a soft cloth and mild detergent, for example, kitchen detergent, and soapy water.

WARNING

- Do NOT splash water over the appliance.
- Do NOT use cream cleansers, thinners, or products containing alcohol or paraffin oil.

Cleaning the drum

If you keep using cold water in the appliance, bacteria may build up inside the drum and emit an odour. You can avoid this by running the 90 °C Cotton programme once a month. (When using a scale remover, follow the manufacturer's instructions.)

CAUTION

Viruses and bacteria are not killed in water temperature of 40 °C. Pathogens can spread via the mingling of clothes and thus transmit diseases.

Pathogens die at the temperature of at least 60 °C.

NOTE

Do NOT put laundry or laundry detergent into the appliance during cleaning.

If you use tub cleaning detergent or bleach, put it into the detergent drawer before starting the wash. The appropriate amount to be used is approximately 30 ml. (See pages 10-11.)

Cleaning the detergent drawer

Detergent residue soon builds up if the detergent drawer is not cleaned regularly. Detergent buildup may develop mould.

1. Pull out the detergent drawer.

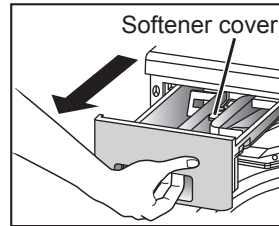

2. Remove the detergent drawer by simultaneously lifting and pulling it.

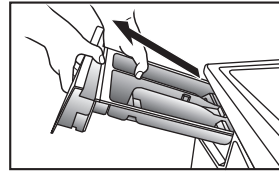

3. Put your finger on the tab near the front of the softener cover and pull it up to remove it from the detergent drawer.

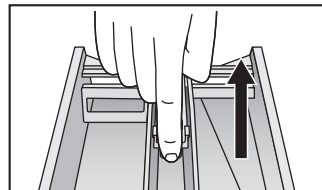

4. Wash out the detergent residue with water.

Use a cloth to wipe the water from the appliance.

5. Align the hole of the softener cover with the click of the detergent drawer to replace the softener cover in its original position. Then, insert the detergent drawer back to the main unit.

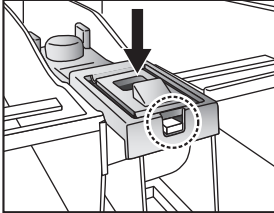

Cleaning the door seal and window

After each wash, perform the following:

- Remove any objects from the door seal.
- Wipe the window and seal to remove lint and stains.

Cleaning the drain filter

We recommend cleaning the drain filter once a month. The filter will have lint buildup, which may interrupt drainage water flow.

1. Switch off and unplug the appliance.
2. Open and remove the drain filter cover. Then, place a container underneath it to collect the drainage.

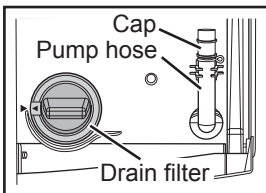

3. Pull out the pump hose and remove the cap to drain the water.

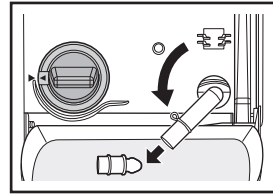

4. After all the water has drained away, loosen the drain filter.
5. Carefully loosen the drain filter. More water may drain out. This is normal.
6. Turn the drain filter anticlockwise to unscrew it. Then, remove it.

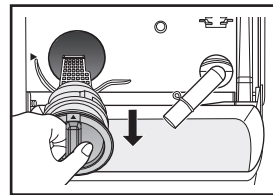
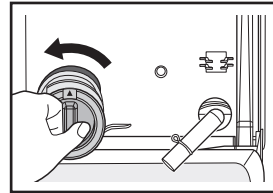

7. Remove any lint and debris.
8. Replace the drain filter.
9. Replace the cap and pump hose to the original position.

CAUTION

BE CAREFUL when draining hot water.

Maintenance

Cleaning the water supply filter

Clean the filter if water is not supplied properly.

1. Turn off the tap.
2. Switch on the appliance.
3. Select the Cotton programme, and then press the Start button.
4. After 1 minute, switch off the appliance. Water has drained out of the water supply hose.
5. Disconnect the water supply hose from the appliance.
6. Clean the filter, which is on the rear of the appliance.
Use a small brush, for example, a toothbrush.

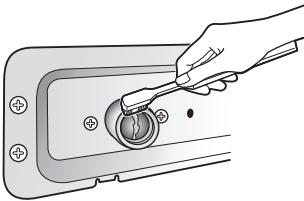

7. If the unit is supplied with the hose fitted with a water supply valve, turn off the tap supplying water to the appliance, disconnect the hose from the tap and then clean the filter on the hose in the same way.

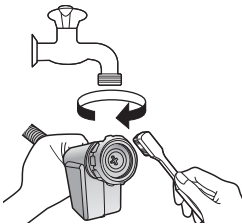

8. Reconnect the water supply hose.
Tighten the plastic joint firmly.

9. Turn on the tap and then check for leaks.

Preventing a frozen water supply hose

If the appliance is delivered in freezing weather conditions, after setting up, leave it at room temperature for 24 hours before using. This will ensure that the water supply hose does not become clogged with ice.

If your water supply hose freezes, perform the following procedures:

1. Wrap warm towels around the joints of the water supply hose.

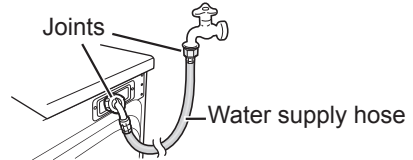

2. Add 2 to 3 litres of warm water to the drum.

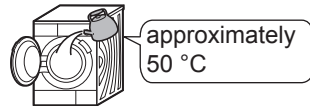

3. Start washing with the Drain only function, using the Mode button.
(See page 20.)

Fault Checklist

Problem		Cause
Washing machine	Buttons do not work.	<ul style="list-style-type: none"> - The programme, temperature and process settings cannot be changed while washing is in progress (the rinse and spin settings can be changed). - Child safety lock may be activated. (See page 21.)
	Door does not open.	<ul style="list-style-type: none"> - Door lock may be activated. (See page 9.) - Child safety lock may be activated. (See page 21.) - The water temperature or level may be too high.
	Unusual odour	<ul style="list-style-type: none"> - Rubber parts may give off a smell when you start using the appliance, but the smell will go away over time. You can wash the drum by running the 90 °C programme. (See page 22.)
Wash	No water going into the appliance.	<ul style="list-style-type: none"> - The water tap may be turned off. - The water supply hose may be frozen. (See page 24.) - The water supply may be disrupted. - The water supply filter may be clogged. (See page 24.)
	There is only a small amount of water.	<ul style="list-style-type: none"> - If you have paused the washing and then restart it, the appliance may drain out some water. Do NOT pour water in through the door.
	Water builds up during the wash process.	<ul style="list-style-type: none"> - This is normal; water is automatically supplied if the amount of water has decreased. For heavy loads, the water may fill up repeatedly.
	Water drains out during the wash process.	<ul style="list-style-type: none"> - This is normal; the water frequently drains out and builds up in order to wash away excess foam. This feature is called foam detection.

Fault Checklist

Problem		Cause
Rinse/Spin	No water flows into the appliance during the rinse process.	- Before rinsing, the appliance spins to drain out remaining water. The water will fill up after that.
	Rinsing begins before the spin process finishes.	- The appliance may have detected an unbalanced load, which is caused by the laundry shifting to one side of the drum, so rinsing started automatically to correct the imbalance. - After washing, excess foam may remain, so the water is drained out and refilled to wash it away. This feature is called foam detection.
	During spin-dry, the drum stops and rotates several times.	- This is normal; the appliance has detected an unbalanced load and is trying to correct it.
	Foam and water remain in the door or door seal.	- Although some foam and water may remain depending upon the state of the laundry and the amount of detergent used, rinse performance is unaffected.
	The spin process repeatedly starts and stops.	- This is normal; intermittent spinning of the tub helps the spin process to operate quietly. - The laundry may be too light. If so, add one or two bath towels.
Time	The displayed remaining time changes.	- The remaining time is estimated and corrected continually. Thus, the time displayed may change. - The remaining time increases if extra rinsing and spinning are required to correct an unbalanced load, which is caused by the laundry shifting to one side of the drum.

Fault Checklist

Problem		Cause
Detergent and foam	There is no foam or hardly any foam.	<ul style="list-style-type: none"> - The amount of foam varies, depending on the temperature, level and softness of the water. - You may have put powdered detergent directly into the drum; you must put it in the detergent drawer. - You may not be using enough detergent. - You may be using a reduced-foam type of detergent. - Heavily soiled laundry and larger loads of laundry may reduce the amount of foam.
	There is a lot of foam.	<ul style="list-style-type: none"> - The amount of foam varies, depending on the temperature, level and softness of the water. - You may have used too much detergent. - The type of detergent you are using may cause excess foam.
	Fabric softener overflows.	<ul style="list-style-type: none"> - The softener may have exceeded the MAX level of the detergent drawer. (See page 11.) - You may have spilt the liquid when closing the detergent drawer too strongly.
	After the wash has finished, powdered detergent residue remains.	<ul style="list-style-type: none"> - You may have put powdered detergent directly into the drum; you must put it in the detergent drawer.
Noise	There is an unusual noise or vibration.	<ul style="list-style-type: none"> - There may be metal items in the drum. - The anchor bolts may not have been removed. (See page 32.) - The appliance may be on a sloping or unstable surface. <p>If none of the above is the cause, contact your local Customer Service Centre.</p>
	There is noise when the water drains out.	<ul style="list-style-type: none"> - This is normal; it is noise generated by the operation of the drain pump.
	The fan makes noise.	<ul style="list-style-type: none"> - This is normal; the fan is cooling off the electrical parts.

Fault Checklist

Problem		Cause
Others	The electricity supply cuts out while the appliance is on.	- The appliance stops and will not start by itself when the power comes back on. You have to select a programme and start it again.
	A circuit breaker trips and the electricity supply is cut.	- The appliance stops and will not start by itself when you reset the breaker. You have to find out what caused the breaker to trip and solve it. Then, reset the breaker to turn the electricity supply back on and switch on the appliance again.
	The water supply is disrupted.	- When the water is supplied again, it may be impure at first. You have to disconnect the water supply hose and drain away the impure water through the tap. Make sure that the water supply hose has been reconnected before using the appliance.
	The display is not clear.	- The appliance may be in a brightly lit or sunlit area.

<p style="text-align: center;">U 11</p> <p style="text-align: center;">Unable to drain</p>	<p>What to do</p> <p>Check the drain hose for any of the following problems.</p> <ul style="list-style-type: none"> - It clogs up. - Its tip is immersed in water. - It extends further than 3 m. - The water is frozen. <p>Clean the drain filter if it clogs up. (See page 23.)</p> <p>After correcting the problem, open and close the door, and then start the wash again.</p>
<p style="text-align: center;">U 12</p> <p style="text-align: center;">Door is open</p>	<p>What to do</p> <p>Make sure that the door is shut properly.</p>
<p style="text-align: center;">U 13</p> <p style="text-align: center;">Unable to spin-dry</p>	<p>The appliance has been designed to detect unbalanced loads, particularly small loads, in order to ensure quiet operation and achieve the best results.</p> <p>This is not a malfunction. Perform any of the following solutions.</p> <p>What to do</p> <ul style="list-style-type: none"> - If the laundry is too heavy, untangle clumps of clothing. - If the laundry such as a blanket is too heavy, reduce the load. - If the laundry is too light, add one or two bath towels. - If the appliance is on an unstable or uneven surface, change the setting location. <p>After correcting the problem, open and close the door, and then start the wash again.</p>
<p style="text-align: center;">U 14</p> <p style="text-align: center;">Unable to supply water</p>	<p>What to do</p> <p>Check for any of the following problems.</p> <ul style="list-style-type: none"> - The tap is closed. - The water pipe or hose is frozen. - The water supply has been disrupted. - The water supply filter is clogged. (See page 24.) <p>After correcting the problem, open and close the door, and then start the wash again.</p> <p>If the red mark appears in the hose with a water supply valve, the water supply has stopped.</p> <p>You should replace with a new hose.</p> <p>Hose with water supply valve (AXW12C-7SR0)</p>
<p style="text-align: center;">H 01</p>	<p>An error display starting with H.</p> <p>What to do</p> <p>Press the Off button. If the display stays on, or if it reappears when you press the Start button, unplug the appliance and contact your local Customer Service Centre.</p>

Choosing the Right Location

Carrying the appliance

The appliance must be carried by 2 or more people.



Start by tilting the appliance backwards. One person should stand behind it, holding the rear of the top panel. The other person should grip the bottom stands in the front.

The right place for the appliance

Make sure that there is enough space for the appliance and that openings on the base are not obstructed by a carpet.

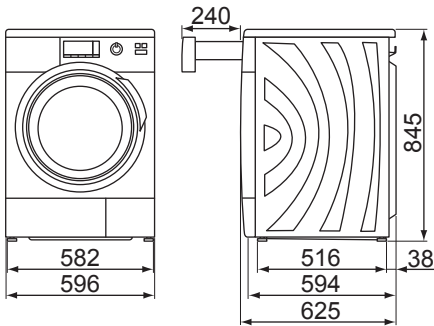

Dimensions in millimetres

CAUTION

- Install the appliance on a flat, stable surface to avoid excessive vibration and noise.
- Do NOT install the appliance in direct sunlight or in a place where temperatures reach freezing.
- Do NOT let metallic portions of the appliance come into contact with metal sinks or other appliances.

The installation shall be in accordance with the requirements of AS/NZS 3500.1.

Installing the set-in appliance

- You need a space of at least 60 cm wide.
Provide at least 2 mm of clearance on both sides and at least 3 mm of clearance both on the top and the back of the appliance.
- The counter above the appliance must be firmly fixed to the adjoining cupboards.
- Have a technician install a metal cover instead of the standard cover panel.
- The plug must be accessible after installation.

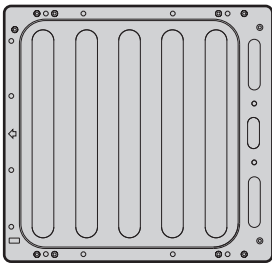
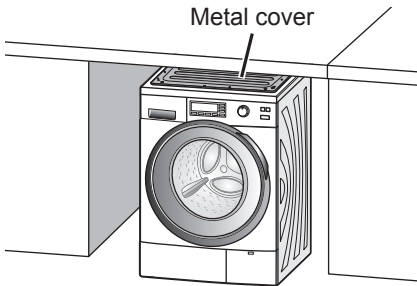

Metal cover (AXW4595-7SR0)

Moving and Installing

Removing the anchor bolts

Four anchor bolts keep the interior of the appliance in place while the appliance is being moved. Remove them before installation, using the spanner supplied with the appliance. Follow the instructions below.

NOTE

The anchor bolts must be removed before the appliance is operated. They may cause excessive vibration.

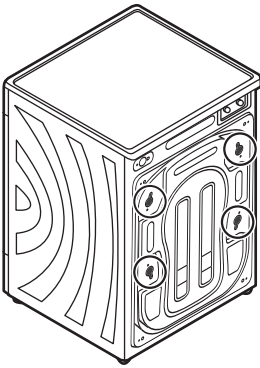

1. Use the 'B' end of the spanner to loosen the four bolts.

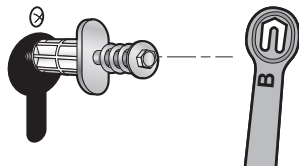

2. Pull the bolts out horizontally.

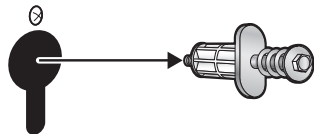

3. Remove the screws adjacent to the bolt holes.

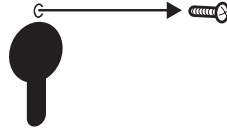

4. Attach each cover cap (included with the accessories) over each bolt hole, and then secure them with the screws removed in step 3.

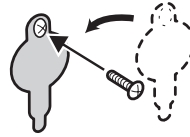

NOTE

- Make sure that you store the anchor bolts because they are used when transporting the appliance. If the appliance is passed on to another person, make sure to give the anchor bolts to that person.
- Make sure the bolt caps are attached. Failure to observe this may result in water entering the washing machine, leading to malfunctions.

Moving the appliance

NOTE

Make sure to install the anchor bolts in the appliance.

Before you move the appliance

- Shut the tap and run the appliance to drain the water. Drain remaining water from the pump hose. (See page 23.)
- Depressurize and remove the water supply hose.
- Disconnect the power cable.
- Install the anchor bolts. (See page 33.)

Moving and Installing

Installing the anchor bolts

1. Unscrew and remove each cover cap.

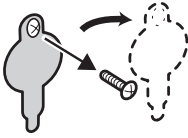

2. Pull the bolt out until the tip is level with the tip of the sleeve.

Have another person hold the top of the drum.

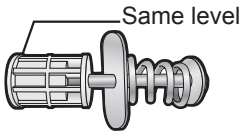

3. Insert each anchor bolt.

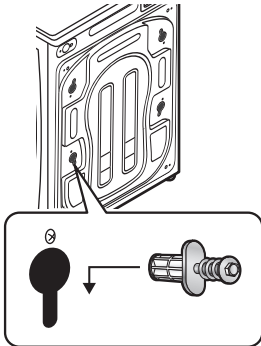

4. Tighten each bolt so that the spring extends out to the length of 26 mm.

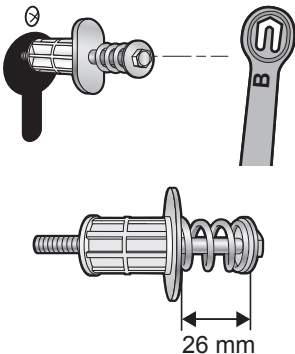

Levelling the appliance

Using a level enables ease in adjustments.

To adjust the stands, use the 'A' end of the spanner.

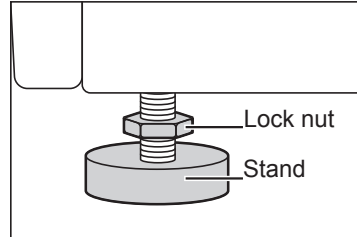

1. Loosen the lock nut on each stand by turning it clockwise.
2. Adjust each stand by turning it clockwise or anticlockwise.
3. Use a spirit level to make sure that the appliance is properly levelled.
4. Tighten each lock nut by turning it anticlockwise.

CAUTION

Make sure that all lock nuts are tightened securely and the stands are still securely bolted to the appliance.

If they are unbolted, the appliance will move around.

Connecting Hoses and Power Supply

Follow the instructions in this section to prevent water leaks. If you are unsure, ask a service agent to connect the hoses.

Hoses and cable lengths

Left side connections

Right side connections

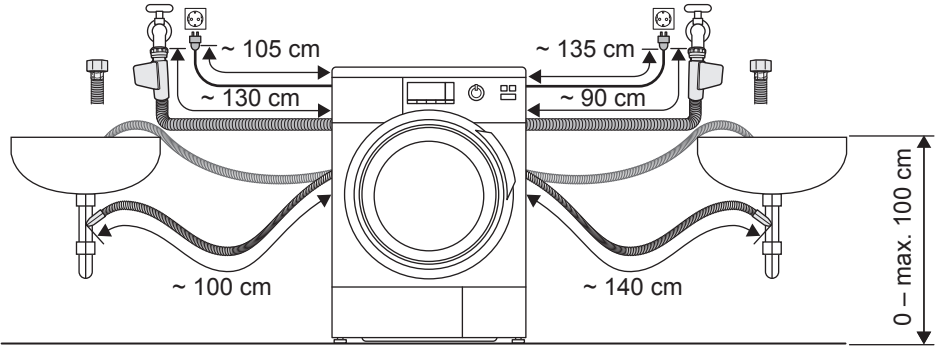

Water supply hose

CAUTION

- Do NOT connect the water supply hose to a combination tap.
- Do NOT twist, squash, modify or cut the hose.

- Optimum mains water pressure is 0.03 - 1.0 MPa. If the water pressure exceeds this value, install a pressure reducing valve.
- Waterflow from the tap should be more than 5 L/min.

Connecting the water supply hose

1. Attach one end of the hose to the water inlet on the back of the appliance and tighten the joint by hand.

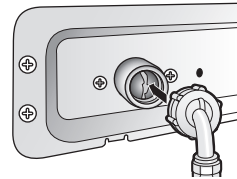

2. Attach the other end of the hose to the tap and tighten it the same way.

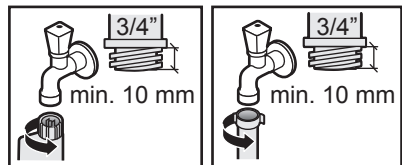

Hose with water supply valve

Standard hose

3. Open the tap slowly and make sure that there are no leaks around the joints.
The joints are subject to water pressure.

Connecting Hoses and Power Supply

Leak-proof System

The appliance is installed with the system that is designed to prevent water leaks. The system includes the following components.

1) Leak sensor

This sensor will cease operation of the appliance if it detects any leaks. It is located on the base plate of the appliance. If a leak has been detected, an error display starting with H, for example, H 01, will appear. In that case, contact your local Customer Service Centre.

2) Overflow detection

If water in the appliance increases to a certain level, this function stops the water supply and activates the drain pump.

Water drain hose

Draining to a sink or wash-basin

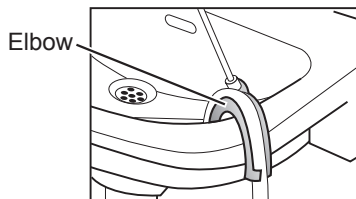

Draining to a drain hose

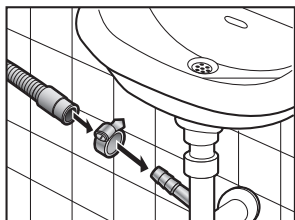

CAUTION

- Do NOT twist, pull out or bend the drain hose.
- Secure the water drain hose so that it will not come out of the basin.
- Do NOT block the drain outlet of the basin. Make sure that drainage into the drain is sufficient.
- Do NOT let the tip of the water drain hose dip into the drained water.
This can cause water to flow back into the appliance.

Connecting to the power supply

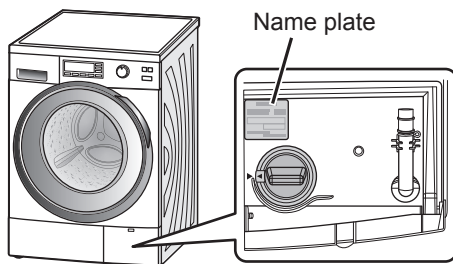

CAUTION

The name plate indicates the rated power that the appliance needs. Make sure that the power supply specifications in your residence match the information mentioned here.

Checking after Installation

Installation checklist

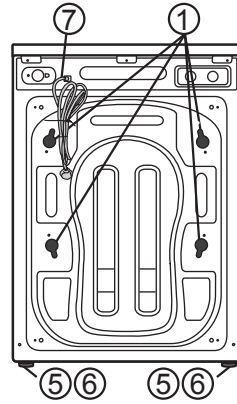
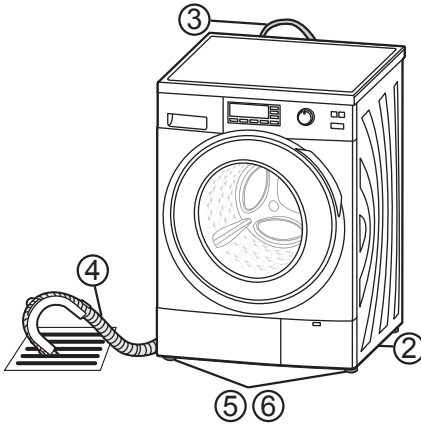

1) Anchor bolts

Have you removed them and attached the cover caps properly?

2) Location

Is the appliance on a flat, stable surface?
Does it run without vibrating?

3) Water supply hose

Is it free from leaks?
Is the water supply normal?

4) Water drain hose

Is it free from leaks?
Does it drain normally?

5) Adjustable stands

Are they bolted securely to the appliance?

6) Stand cushions

Are they standing flat?
If the appliance is not level, there may be abnormal sounds when water is drained out.

7) Power supply

Is the household dedicated mains socket fully rated at AC 220 V to 240 V?

Checking after Installation

Test run after installation

Check for water leakage, abnormal noise, and proper drainage.

Perform the following procedures WITHOUT laundry in the drum.

1. Turn on the tap.
2. Close the door.
3. Press the On button. You have to select “Quick 50” course and “Spin only” mode. Then, press the Start button.
After the water is drained, start a test run.
4. While holding down the Speed/Eco and Easy Ironing buttons, press the On button.



5. When the display appears as below (3 seconds), press the Speed/Eco button.



The remaining time is displayed as shown below.

0:03

The test is run for approximately 3 minutes.

- When the water pressure is low, the operation may stop for several minutes with “0:03” displayed.

Check the following:

- Is there any abnormal noise?
If so, make sure that the appliance is level.
- Is there any water leakage?
If so, make sure that the hoses are properly connected.

The following errors may occur:

U 11

- Are the hoses properly connected?
Is the drain clogged?

U 14

- Have you properly connected the water supply hose and turned on the tap?

After the appliance has recovered from an error, reopen and reclose the door to resume the test.

Consider the Environment

Disposing of packaging

The packaging used to protect the washing machine from damage during transportation is all recyclable. For information on recycling, contact your local authority.

Disposing of Waste Electrical & Electronic Equipment

Information on disposal for users of waste electrical & electronic equipment (private households)



This symbol on the products and/or accompanying documents means that used electrical and electronic products should not be mixed with general household waste.

For proper treatment, recovery and recycling, please take these products to designated collection points, where they will be accepted on a free of charge basis. Alternatively, in some countries you may be able to return your products to your local retailer upon the purchase of an equivalent new product.

Disposing of this product correctly will help to save valuable resources and prevent any potential negative effects on human health and the environment which could otherwise arise from inappropriate waste handling. Please contact your local authority for further details of your nearest designated disposable point.

Penalties may be applicable for incorrect disposal of this waste, in accordance with national legislation.

Information on disposal in other countries outside the European Union

This symbol is only valid in the European Union.

If you wish to discard this product, please contact your local authorities or dealer and ask for the correct method of disposal.

Eco-friendly Laundry

- Keep to the load limit of each programme.
- The washing machine automatically adjusts the operating time of each programme depending on the load.
- You only need to use a preliminary wash if your laundry is heavily soiled.
- Using the 60 °C Cotton programme instead of the 90 °C Cotton one will save energy and will remove ordinary stains.
- For lightly soiled laundry, using the Cold Wash programme instead of the 40 °C Quick 50 programme will save more energy.











Detergent amount

- Use the correct amount of detergent based on the detergent pack instructions and local water hardness.
- Adjust the amount of detergent depending on how soiled your laundry is.

When using a tumble dryer

To save energy, please select the correct spin speed according to the instruction of your tumble dryer.

Power and Water Consumption

Programme	Temperature	Additional function	Load	Power consumption ²⁾	Water consumption ²⁾	Time ²⁾
 Cotton	40 °C	—	10 kg	1.07 kWh	85 L	2:15
			8 kg	0.90 kWh	72 L	2:10
	60 °C ¹⁾	—	10 kg	2.10 kWh	85 L	2:40
			8 kg	1.85 kWh	72 L	2:20
	60 °C ¹⁾	Eco	10 kg	0.85 kWh	63 L	3:45
			8 kg	0.65 kWh	50 L	3:45
 Cotton Rinse Plus	60 °C	—	10 kg	1.55 kWh	87 L	3:02
			8 kg	1.48 kWh	74 L	2:22
	40 °C	Eco ³⁾	10 kg	0.83 kWh	80 L	3:23
			8 kg	0.67 kWh	68 L	2:53
 Wool	30 °C	—	2 kg	0.20 kWh	50 L	0:40
 Silk/Lingerie	30 °C	—	2 kg	0.22 kWh	60 L	0:40
 Denim	30 °C	—	2 kg	0.24 kWh	40 L	0:55
 Outdoor	30 °C	—	3 kg	0.27 kWh	58 L	1:48
 Shirts	40 °C	—	2 kg	0.42 kWh	35 L	1:08
 Sportswear	40 °C	—	3 kg	0.65 kWh	45 L	1:30
 Rapid 15	30 °C	—	2 kg	0.15 kWh	23 L	0:15
 Quick 50	40 °C	—	5 kg	0.48 kWh	50 L	0:49
			4 kg	0.45 kWh	40 L	0:49
 Cold Wash	Cold	—	10 kg	0.28 kWh	87 L	2:42
			8 kg	0.26 kWh	74 L	2:27

1) Results calculated based on the usage of the Eco function and the maximum spin speed comply with IEC 60456.

2) The power, water consumption and time indicated in the table may vary depending on variations in pressures, water hardness and temperatures, room temperatures, types and amounts of laundry, voltage fluctuations and functions to be used.

3) Cotton Rinse Plus, 40 °C, Eco, 1400 r/min is for normally cotton soiled load with AS/NZS 2040.1, AS/NZS 2040.2, AS/NZS 6400.

Specifications

	NA-140VG4	NA-148VG4
Rated voltage	220 - 240 V	
Rated frequency	50 Hz	
Maximum energy rated power input	2000 - 2350 W	
Heating energy rated power input	2000 W (230 V)	
Power consumption	Off-mode / Left On-mode 0.2 W	
Maximum spin speed	1400 r/min	
Product weight	74 kg	
Maximum mass of dry cloth	10 kg	8 kg
Product dimensions	596 mm (W) × 625 mm (D) × 845 mm (H)	
Water consumption	Refer to "Power and Water Consumption".	
Pressure of tap water	0.03 - 1 MPa	