



Panasonic[®]

Operating Instructions Plasma Television

Model No. **TH-42PZ80A**
TH-50PZ80A

VIERA

VIERA
Link

DVB[®]

DOLBY
DIGITAL

SD
HG[™]

HDMI[™]
HIGH-DEFINITION MULTIMEDIA INTERFACE

Please read these instructions before operating your set and retain them for future reference.
The images shown in this manual are for illustrative purposes only.

English

TQBC2346-1

Turn your own living room into a movie theatre!

Experience an amazing level of multi-

- Receives digital terrestrial broadcastings using an integrated DVB (Digital Video Broadcasting) tuner
- Sharp pictures with HDMI connection
- Links up and controls the connected equipment with “VIERA Link”

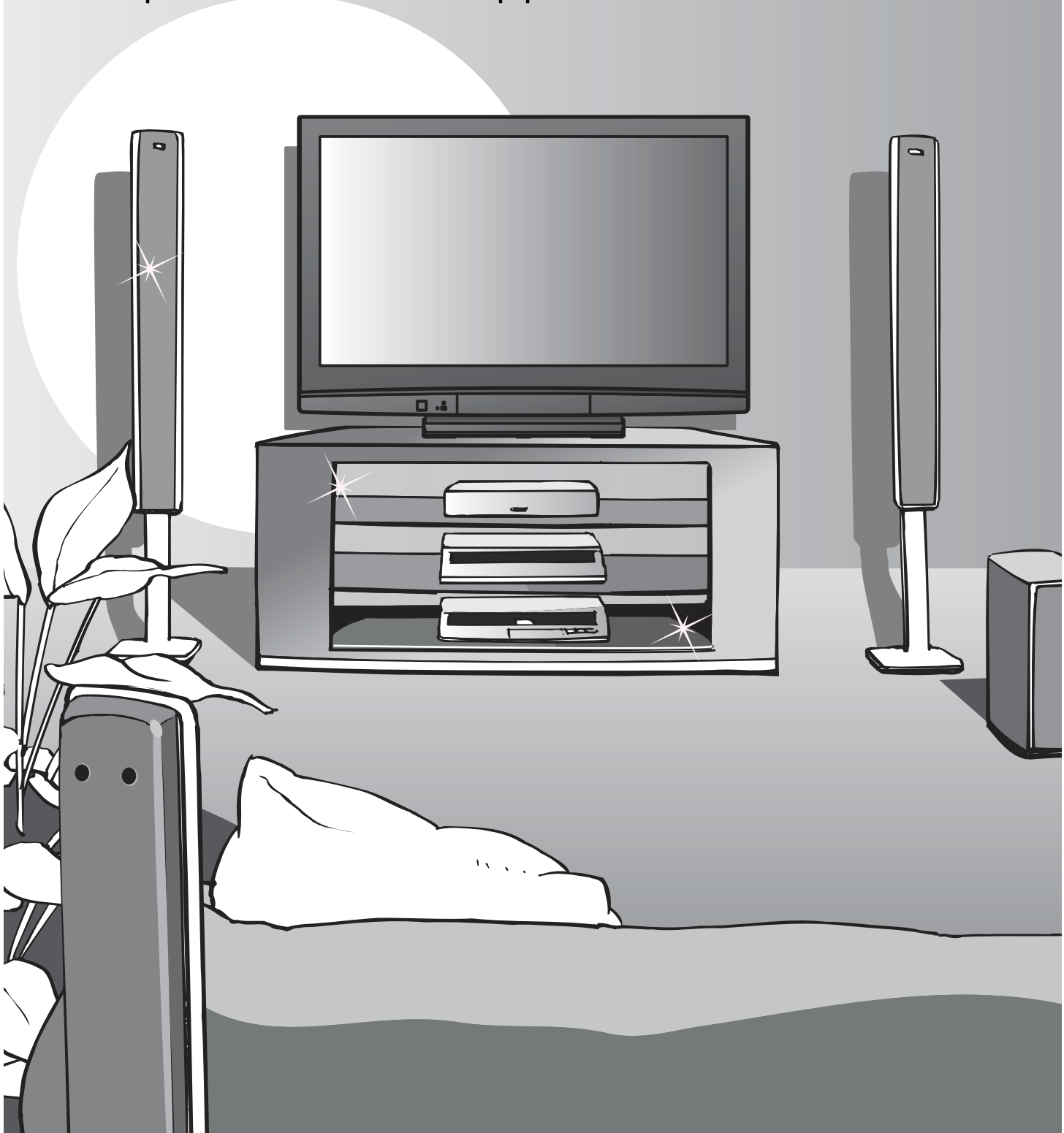

media excitement

Enjoy rich multi-media

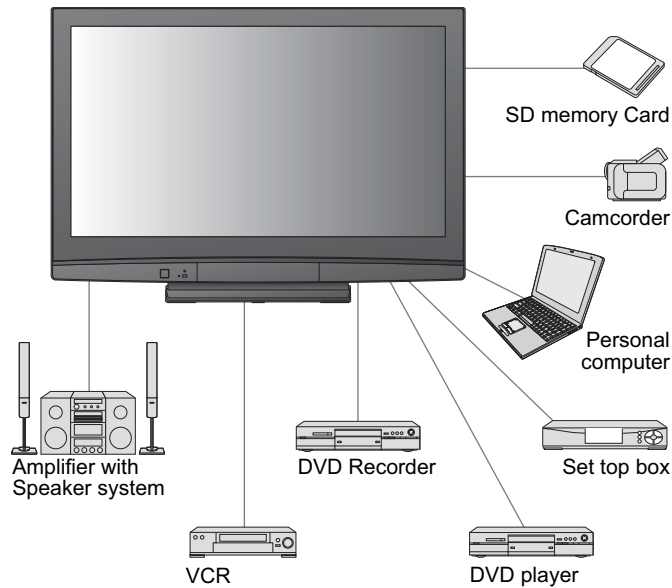

Contents

Be Sure to Read

- Safety Precautions 4
(Warning / Important Installation Notices)

Quick Start Guide

- Accessories / Options 6
- Basic Connection 8
- Identifying Controls 11
- Auto Tuning 12

Enjoy your TV!

Basic Features

- Watching TV 14
- Using TV Guide 17
- Viewing Teletext 18
- Watching Videos and DVDs 20

Advanced Features

- How to Use Menu Functions 22
(picture, sound quality, etc.)
- DVB Settings (DVB) 26
- Editing Programmes 28
- Tuning Programmes 30
- Restore Settings 32
- Input Labels 33
- Displaying PC Screen on TV 34
- HDMI Functions 35
- Viewing from SD Card (Photos) 36
- VIERA Link "HDAVI Control™" 38
- External Equipment 42

FAQs, etc.

- Technical Information 44
- FAQs 47
- Licence 49
- Maintenance 49
- Specifications 50
- WARRANTY 51

Safety Precautions

Warning

Handling the mains plug and lead

- Insert the mains plug fully into the socket outlet. (If the mains plug is loose, it could generate heat and cause fire.)
- Ensure that the mains plug is easily accessible.
- Ensure the earth pin on the mains plug is securely connected to prevent electrical shock.
- Do not touch the mains plug with a wet hand. (This may cause electrical shock.)
- Do not use any mains lead other than that provided with this TV. (This may cause fire or electrical shock.)
- Do not damage the mains lead. (A damaged lead may cause fire or electrical shock.)
 - Do not move the TV with the lead plugged in the socket outlet.
 - Do not place a heavy object on the lead or place the lead near a high-temperature object.
 - Do not twist the lead, bend it excessively, or stretch it.
 - Do not pull on the lead. Hold onto the mains plug body when disconnecting lead.
 - Do not use a damaged mains plug or socket outlet.

If you find any abnormality, remove the mains plug immediately!

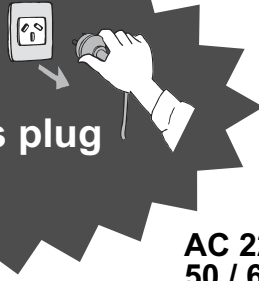

AC 220-240 V
50 / 60 Hz



Power source

- This TV is designed to operate on 220-240 V, 50 / 60 Hz AC.

Do not remove covers NEVER modify the TV yourself

(High-voltage components may cause serious electrical shock.)

- Have the TV checked, adjusted, or repaired at your local Panasonic dealer.

Keep liquids away from the TV

- To prevent damage which may result in fire or shock hazard, do not expose this appliance to dripping or splashing.
- Do not place containers with water (flower vase, cups, cosmetics, etc.) above the TV. (including on shelves above, etc.)

Do not expose to direct sunlight and other sources of heat

- Avoid exposing the TV to direct sunlight and other sources of heat. To prevent fire never place any type of candle or naked flame on top or near the TV.

Do not place foreign objects inside the TV

- Do not allow any objects to drop into the TV through the air vents (fire or electrical shock may result).

Do not place the TV on sloped or unstable surfaces

- The TV may fall off or tip over.

Use only the dedicated pedestals / mounting equipment

- Using an unapproved pedestal or other fixtures may make the TV unstable, risking injury. Be sure to ask your local Panasonic dealer to perform setup.
- Use approved pedestals / mounts (p. 6).

Do not allow children to handle SD Card

- As with any small object, SD Cards can be swallowed by young children. Please remove SD Card immediately after use and store out of reach of children.

Important Installation Notices

■ Install TV on a stable surface

If a television is not positioned in a sufficiently stable location, it can be potentially hazardous due to falling. Many injuries, particularly to children, can be avoided by taking simple precautions such as:

- Using cabinets or stands recommended by the manufacturer of the television.
- Only using furniture that can safely support the television.
- Ensuring the television is not overhanging the edge of the supporting furniture.
- Not placing the television on tall furniture (for example, cupboards or bookcases) without anchoring both the furniture and the television to a suitable support.
- Not standing the televisions on cloth or other materials placed between the television and supporting furniture.
- Educating children about the dangers of climbing on furniture to reach the television or its controls.

■ When cleaning the TV, remove the mains plug

- Cleaning an energized TV may cause electrical shock.

■ When the TV is not going to be used for a long period of time, remove the mains plug

- This TV will still consume some power even in the Off mode, as long as the mains plug is still connected to a live socket outlet.

■ Transport only in upright position

- Transporting the TV with its display panel facing upright or downward may cause damage to the internal circuitry.

■ Allow sufficient space around the TV for radiated heat

Minimum distance

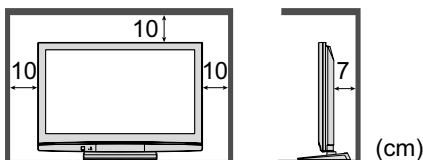

- When using the pedestal, keep the space between the bottom of the TV and the floor surface.
- In case of using Wall-hanging bracket, follow the manual of it.

■ Do not block the rear air vents

- Blocked ventilation by newspapers, table cloths, curtains, etc. may cause overheating, fire or electrical shock.

■ Do not expose your ears to excessive volume from the headphones

- Irreversible damage can be caused.

■ Auto power standby function

- If no signal is received and no operation is performed in Analogue TV mode for 30 minutes, the TV will automatically go to standby mode.

■ Keep the TV away from these types of equipment

- Electronic equipment
In particular, do not place video equipment near the TV (electromagnetic interference may distort images / sound).
- Equipment with an infrared sensor
This TV also emits infrared rays (this may affect operation of other equipment).

Do not display a still picture for a long time

This causes the image to remain on the plasma screen ("image retention"). This is not considered a malfunction and is not covered by the warranty.

Typical still images

- Programme number and other logos
- Image displayed in "4:3" mode
- Video game
- Computer image



To prevent image retention, contrast is lowered automatically after a few minutes if no signals are sent or no operations are performed. (p. 47)

Accessories / Options

Standard accessories

Check that you have the accessories and items shown

- Remote Control
- N2QAYB000228



- Batteries for the Remote Control (2)
- R6 (AA)



- Clamper
- ➔ p. 10

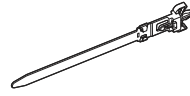

- Mains Lead
- ➔ p. 8

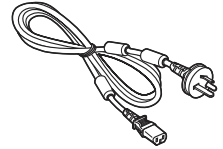

- Operating Instructions with Warranty statement

- Cleaning cloth



- Pedestal
- ➔ p. 7

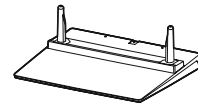

- This product contains possibly dangerous parts (such as plastic bags), that can be breathed in or swallowed by young children accidentally. Keep these parts out of reach of young children.

Optional accessories

Wall-hanging bracket (vertical)

- TY-WK42PV3W
- TY-WK42PV4W

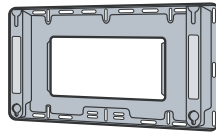

(angle)

- TY-WK42PR3W
- TY-WK42PR4W

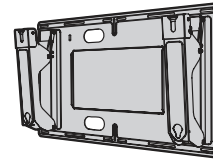

Caution

- In order to maintain the unit's performance and safety, be absolutely sure to ask your dealer or a licenced contractor to secure the wall-hanging brackets.
- Carefully read the instructions accompanying the pedestal, and be absolutely sure to take steps to prevent the TV from tipping over.
- Handle the TV carefully during installation since subjecting it to impact or other forces may cause product damage.

Installing remote's batteries

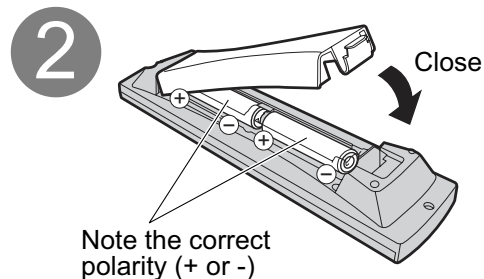
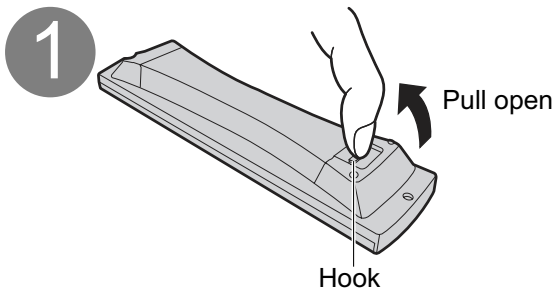

Caution

- Incorrect installation may cause battery leakage and corrosion, resulting in damage to the remote control.
 - Do not mix old and new batteries.
 - Do not mix different battery types (such as alkaline and manganese batteries).
 - Do not use rechargeable (Ni-Cd) batteries.
 - Do not burn or breakup batteries.
- Batteries must not be exposed to excessive heat such as sunshine, fire or the like.

Attaching the pedestal

Warning

Do not disassemble or modify the pedestal.

- Otherwise the TV may fall over and become damaged, and personal injury may result.

Caution

Do not use any other TV and displays.

- Otherwise the TV may fall over and become damaged, and personal injury may result.

Do not use the pedestal if it becomes warped or physically damaged.

- If you use the pedestal while it is physically damaged, personal injury may result. Contact your nearest Panasonic dealer immediately.

During set-up, make sure that all screws are securely tightened.

- If insufficient care is taken to ensure screws are properly tightened during assembly, the pedestal will not be strong enough to support the TV, and it might fall over and become damaged, and personal injury may result.

Ensure that the TV does not fall over.

- If the TV is knocked or children climb onto the pedestal with the TV installed, the TV may fall over and personal injury may result.

Two or more people are required to install and remove the TV.

- If two or more people are not present, the TV may be dropped, and personal injury may result.

- Ⓐ Assembly screw (4)
(silver)
● XYN5+F18FN

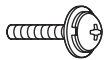

M5 × 18 mm

- Ⓑ Assembly screw (4)
(black)
● THEL060N

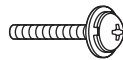

M5 × 25 mm

- Ⓒ Pole (2)
● L:TBLA3615
R:TBLA3614

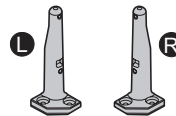

- Ⓓ Base
● TBLX0049-1
(TH-42PZ80A)
● TBLX0051-1
(TH-50PZ80A)

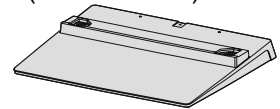

Assembling the pedestal

Use the four assembly screws Ⓐ to fasten the left and right poles to the base securely.

- Make sure that the screws are securely tightened.
- Forcing the assembly screws the wrong way will strip the threads.
- "L" or "R" mark is stamped on the bottom of the pole.

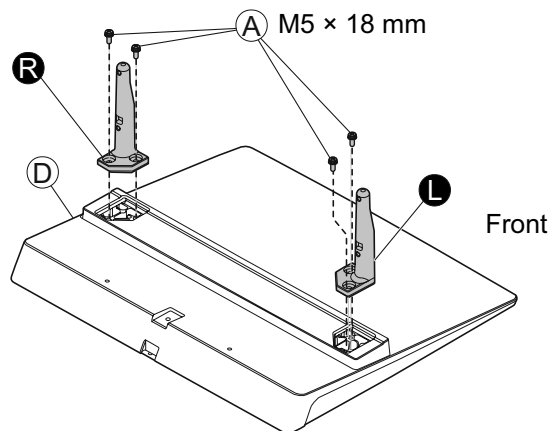

Securing the TV

Use the assembly screws Ⓑ to fasten securely.

- Make sure that the screws are securely tightened.
- Carry out the work on a horizontal and level surface.

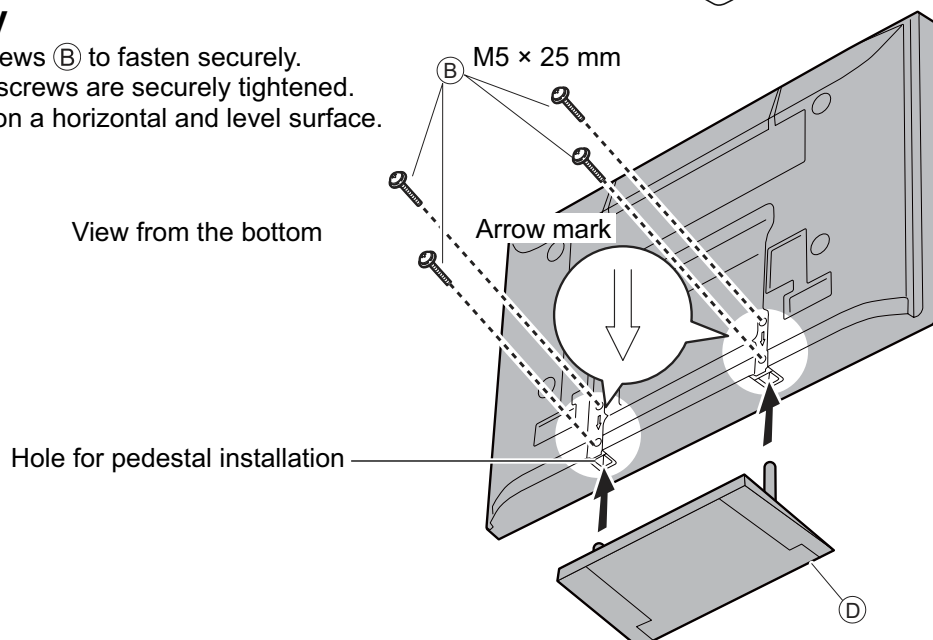

Basic Connection

External equipment and cables shown are not supplied with this TV.

Please ensure that the unit is disconnected from the mains socket before attaching or disconnecting any leads. When disconnecting the mains lead, be absolutely sure to disconnect the mains plug at the socket outlet first.

Example 1 Connecting aerial

TV only

Rear of the TV

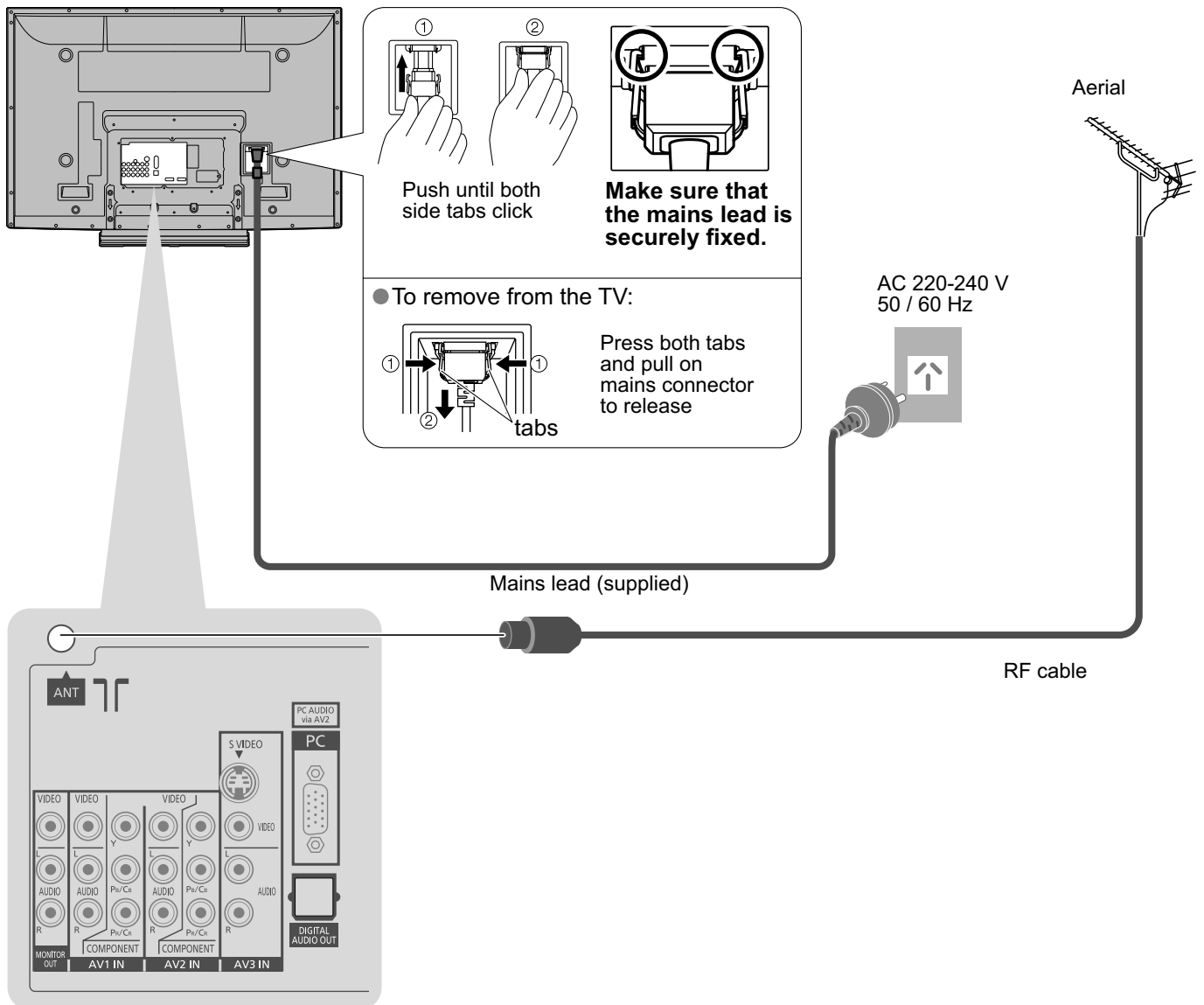

Note

- Do not put the RF cable close to the mains lead to avoid noise.
- Do not place the RF cable under the TV.
- To obtain optimum quality picture and sound, an Aerial, the correct cable (75 Ω coaxial) and the correct terminating plug are required.
- If a communal Aerial system is used, you may require the correct connection cable and plug between the wall Aerial socket and the TV.
- Your local Television Service Centre or dealer may be able to assist you in obtaining the correct Aerial system for your particular area and the accessories required.
- Any matters regarding Aerial installation, upgrading of existing systems or accessories required, and the costs incurred, are the responsibility of you, the Customer.

Example 2 Connecting DVD Recorder / VCR

TV, DVD Recorder or VCR

Rear of the TV

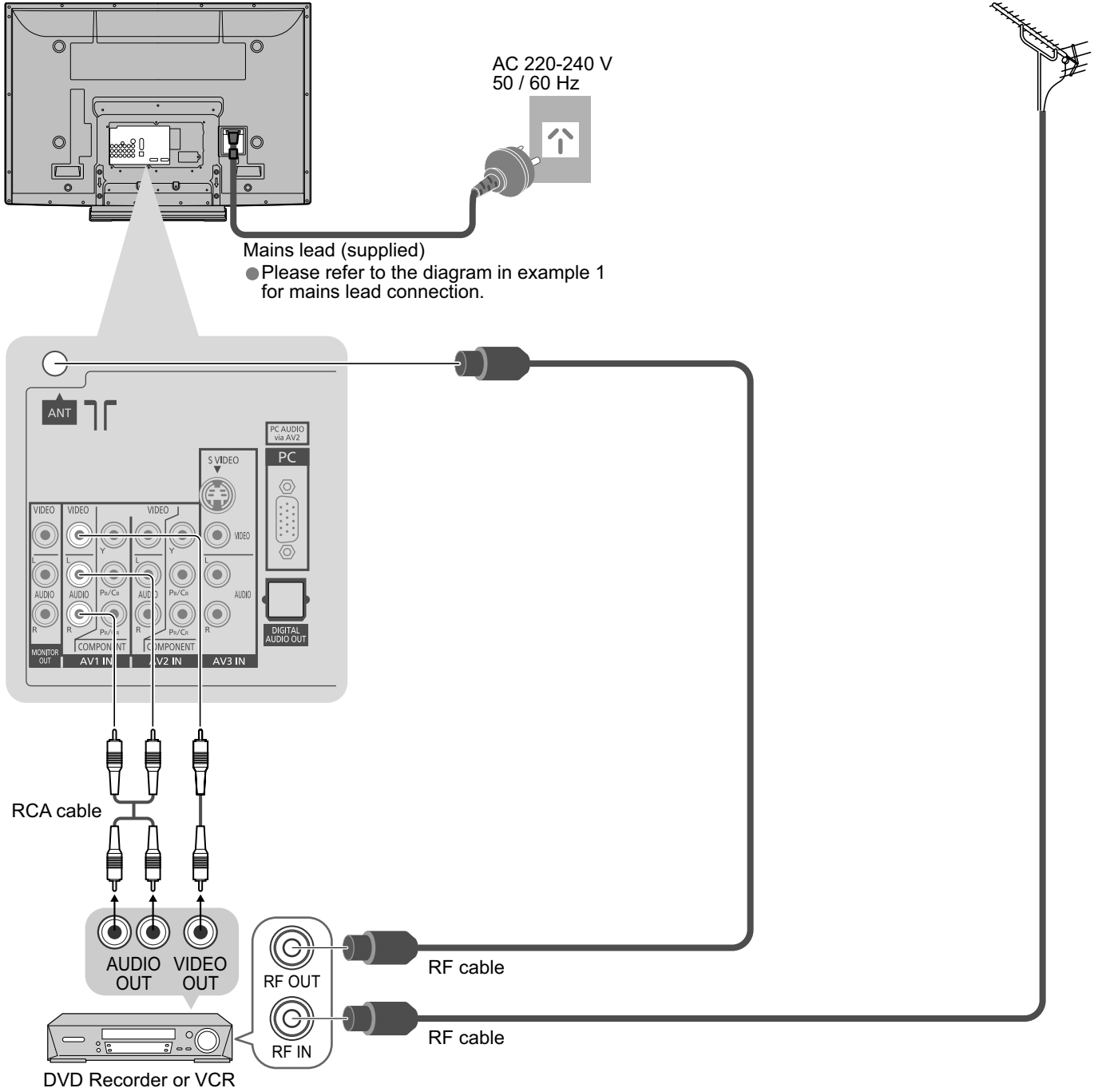

Note

- VIERA Link connection → p. 38
- If your recorder is not available for DVB → p. 48
- Read the manual of the equipment too.

Basic Connection

Example 3 Connecting DVD Recorder / VCR and Set top box

TV, DVD Recorder / VCR and Set top box

Rear of the TV

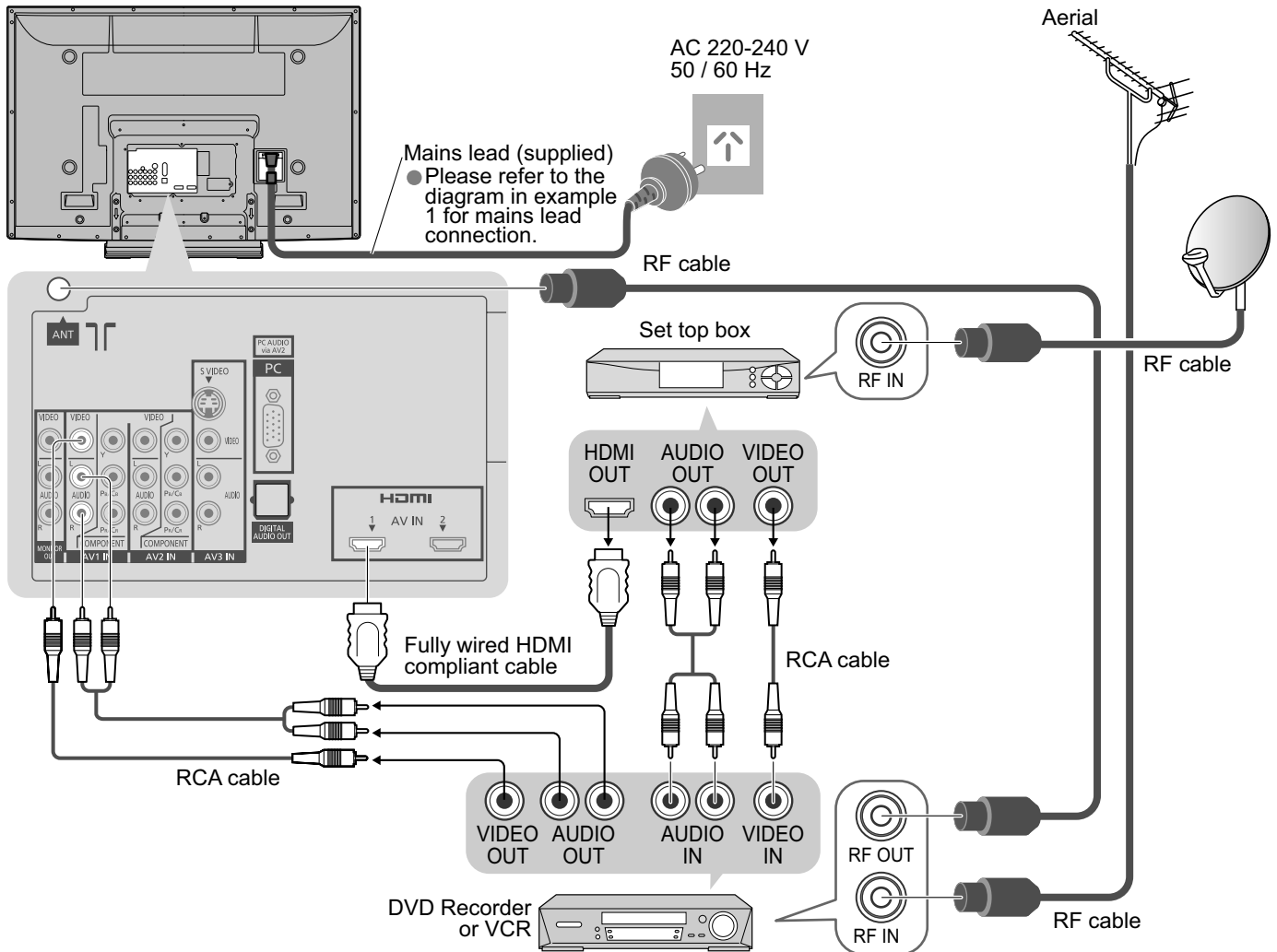

Using the clammer

Rear of the TV

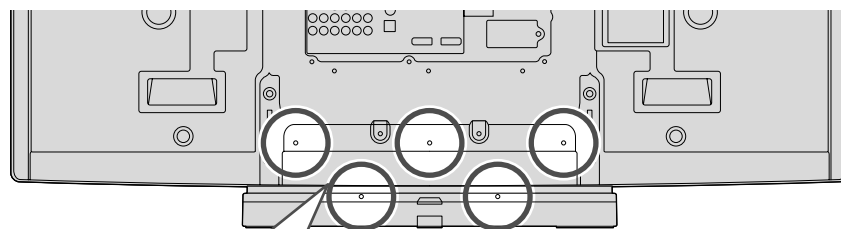

- Do not bundle the RF cable and mains lead together (could cause distorted image).
- Fix cables with clammers as necessary.
- When using the optional accessory, follow the option's assembly manual to fix cables.

■ Attach the clammer

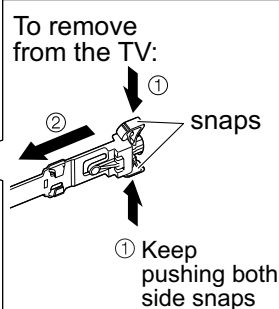
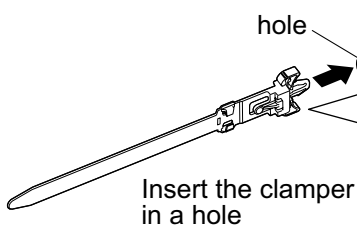

■ Bundle the cables

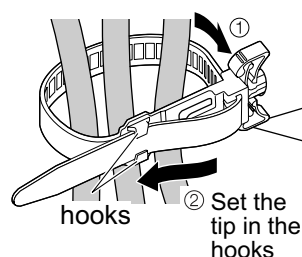

To loosen:

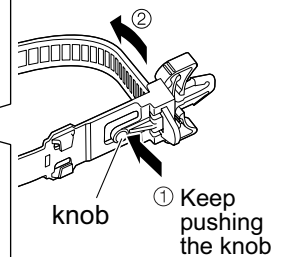

Identifying Controls

TV

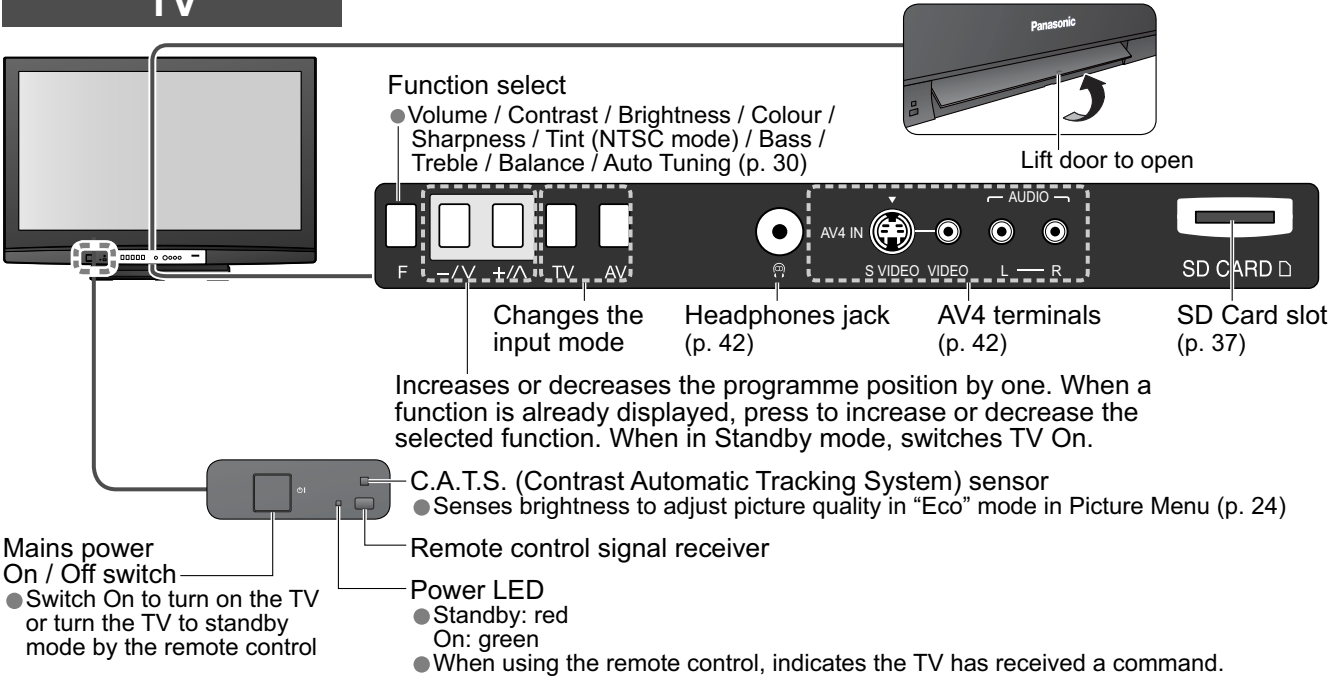

Remote Control

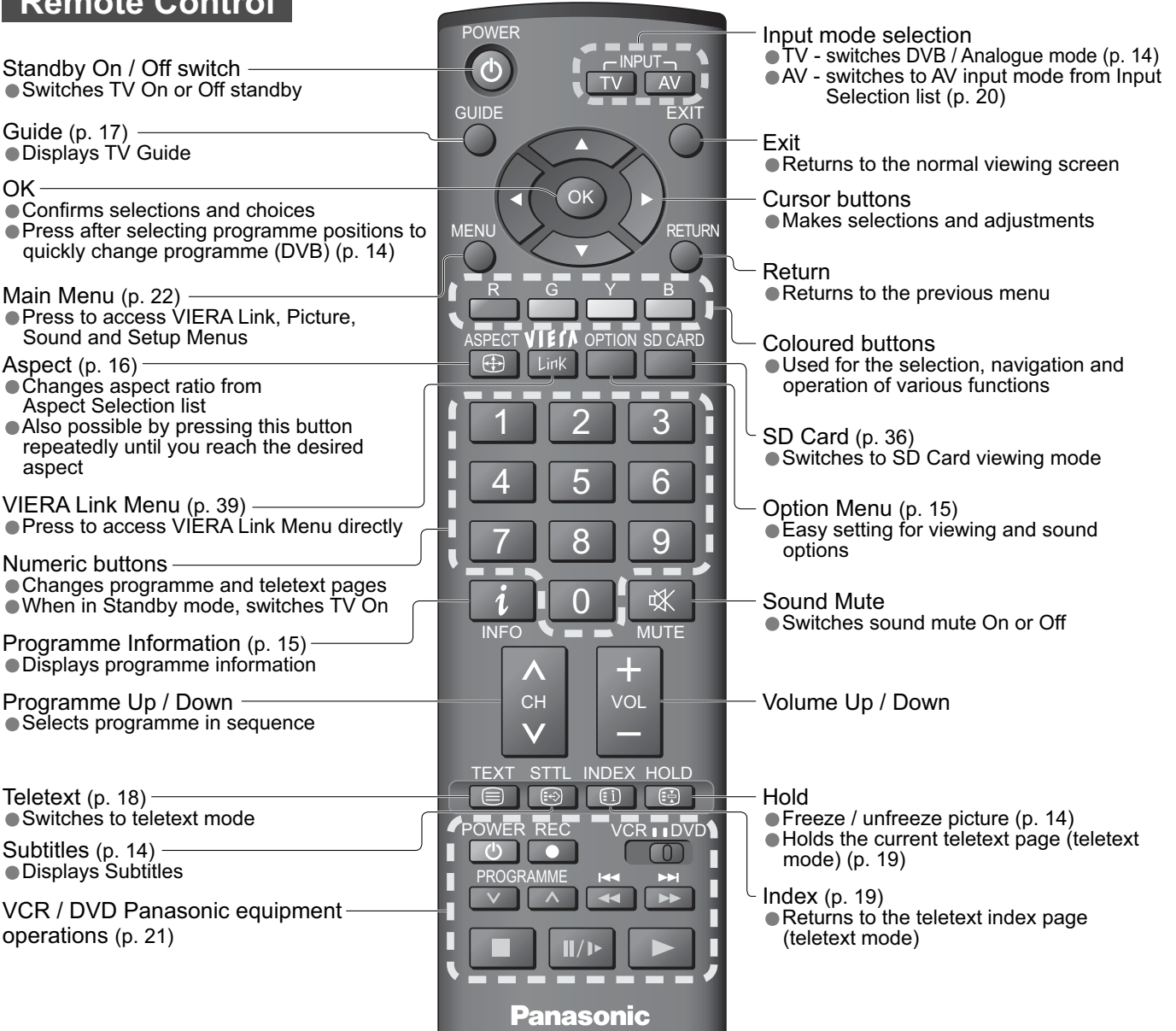

Auto Tuning

Search and store TV programmes automatically.

These steps are not necessary if the setup has been completed by your local dealer.

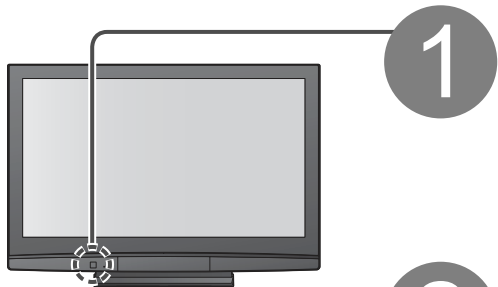

1 Plug the TV into mains socket and switch On
(Takes a few seconds to be displayed)

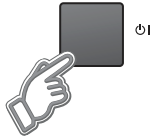

- You can now use the remote control to turn On the TV or turn the TV to standby mode. (Power LED: On)

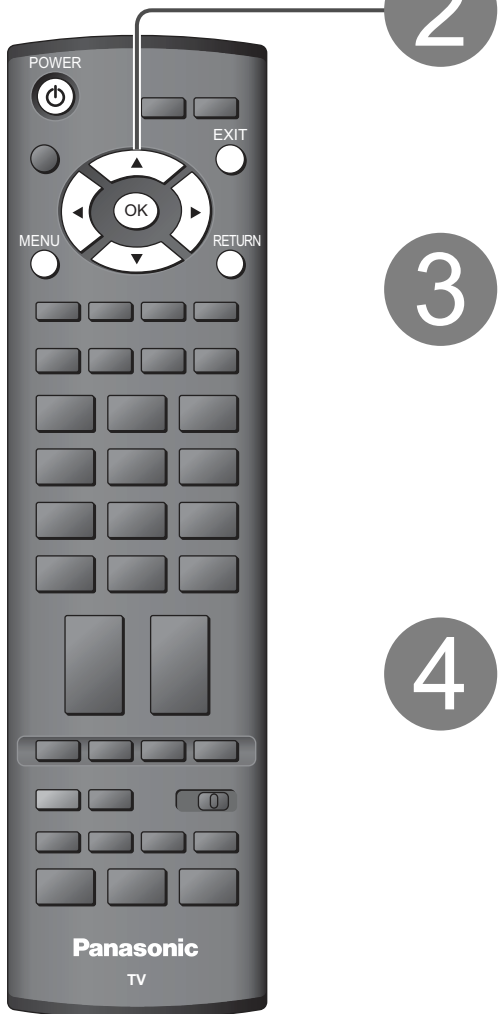

2 Select your state

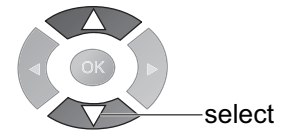
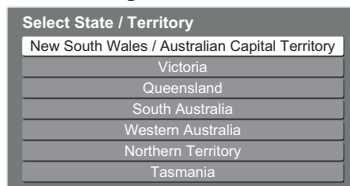

3

Start Auto Tuning

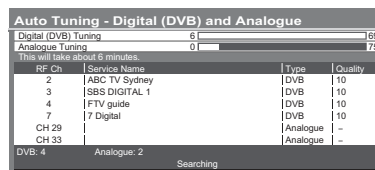

- Auto Tuning will start to search for TV programmes and store them in the numbered order as specified by the broadcasters.

4

Select the picture setting

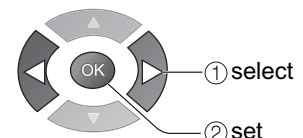
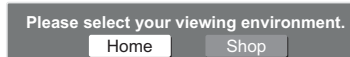

- "Home" is the recommended mode for viewing at home. Select "Home" for optimal picture / power consumption. "Shop" is for in-store display.
- If "Shop" is selected, the word "Shop" appears every time the TV is switched on. (p. 14)
Home: "Viewing Mode" is set as "Normal". (p. 24)
Shop: "Viewing Mode" is set as "Dynamic". (p. 24)

Auto Tuning is now complete and your TV is ready for viewing.









- To edit programmes
➔ "Editing Programmes" (p. 28)

Using the On Screen Displays

Many features available on this TV can be accessed via the On Screen Display menu.

■ How to use remote control

- 
Open the main menu
- 
Move the cursor / select the menu
- 
Move the cursor / adjust levels / select from a range of options
- 
Access the menu / store settings after adjustments have been made or options have been set
- 
Return to the previous menu
- 
Exit the menu system and return to the normal viewing screen

■ ON SCREEN HELP Instructions box
(example: Sound Menu)

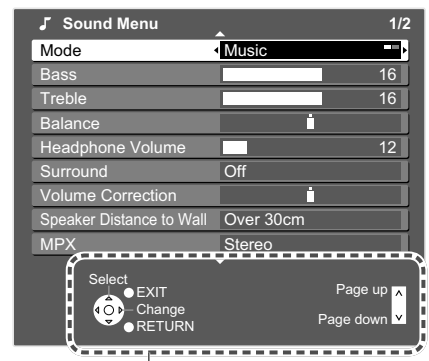

On-screen operation guide will help you.

Note

- If tuning has failed ➔ “Auto Tuning” (p. 31)
- To initialize all settings ➔ “Shipping Condition” (p. 32)
- If you turned the TV Off during Standby mode last time, the TV will be in Standby mode when you turn the TV On with Mains power On / Off switch.

Watching TV

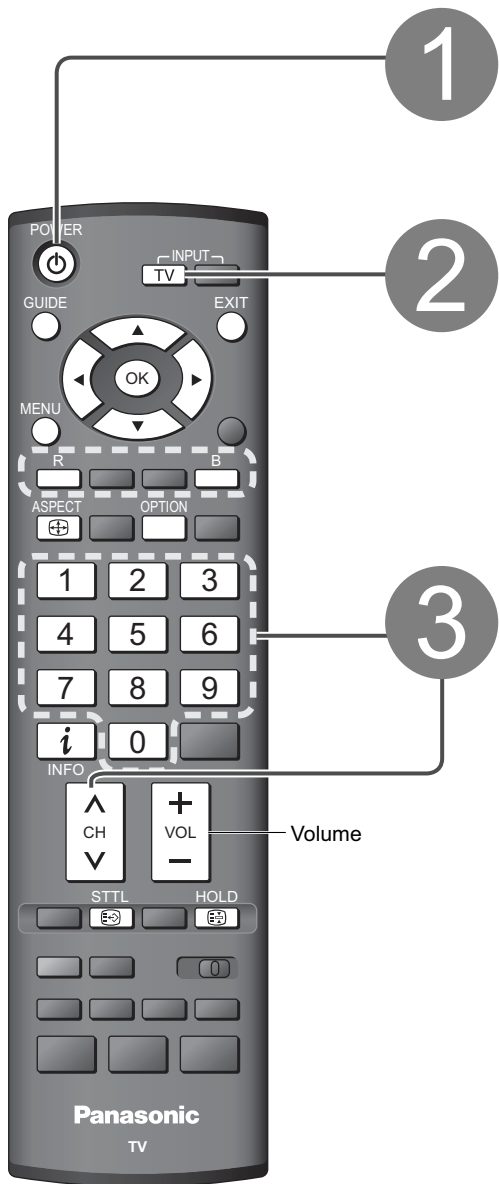

1 Turn power on

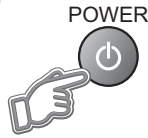

- Mains power On / Off switch should be On. (p. 11)
- If "Shop" is displayed on the top right of the screen, reset settings in "Shipping Condition" (p. 32), and select "Home" in "Auto Tuning" (p. 12).

2 Select DVB (Digital Video Broadcasting) or Analogue mode



- Also possible to select the mode using the TV button on the front panel of the TV. (p. 11)

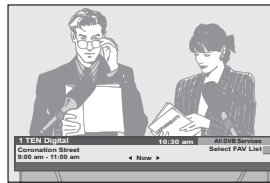

Information banner appears whenever you select a programme
 ● For details → p. 15

3 Select a programme

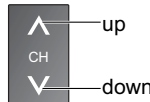

- To select the two or three-digit programme number, e.g. 39
 → 3 → 9 (in a short time)
- If one or two-digit programme number
 → OK → quickly changes the programme

- To select from the Programme List

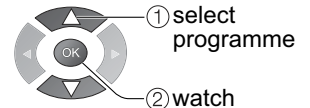
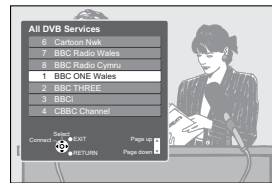

Note

- When the TV is switched to standby, there will be a clicking sound after a short delay. This is normal.

Select a programme using Information banner (p. 15)

Possible to confirm the programme name before selecting programmes.
 Display Information banner if it is not displayed

While the banner is displayed, select the programme

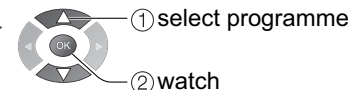

- Possible to set display timeout in "Banner Display Timeout" (p. 25).

Select a programme using TV Guide (p. 17)

Possible to confirm the TV Guide (EPG) before selecting programmes.

Display TV Guide



Select the programme

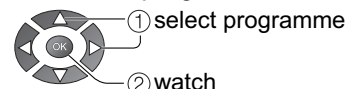

Other useful functions

Hold	Freeze / unfreeze picture	HOLD
Display subtitles	Display / hide subtitles (if available)	STTL

● Channel changing is also possible when this function is active.

■ Other useful functions

Display Information banner

Display Information banner



- Also appears when changing a programme

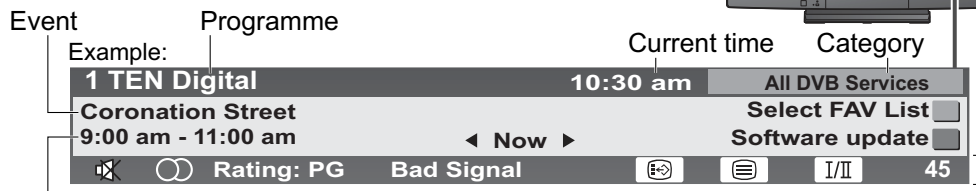

DVB: Event Start / Finish time
Analogue: Programme status

Features available / Message meanings

Sound mute On Audio mode (Analogue mode) (p. 45) Rating: Rating information (p. 44) Bad signal Poor TV signal quality Encrypted Scrambled programme	Subtitle service available Teletext service available Multiple audio available (DVB mode) 1 - 90 Off Timer remaining time ● For settings → see below
---	--

- To confirm another tuned programme name →
- To change the category (To select a Fav List if you have defined) →
- Information on the next event (DVB mode) →
- Extra information → (press again to hide the banner) (DVB mode)
- To watch the programme listed in the banner →
- To download new software to TV → "System Update Search Now" (p. 27)
- To hide →
- To set display timeout → "Banner Display Timeout" (p. 25)

Display the selectable settings for the current programme

Check or change the current programme status instantly



- To change → ② change ① select

MPX (Analogue mode)
→ Sound Menu (p. 24)

Audio selection (DVB mode)
→ Sound Menu (p. 24)
Allows you to select between alternative language for sound tracks (if available)

Volume Correction
Adjusts volume of individual programme or input mode

Note

- Also possible to change the settings in Menu list (p. 24 and p. 25).

Off Timer

Turn the TV off automatically after a fixed period

Display the menu

Select "Setup"

Select "Off Timer" and set the time

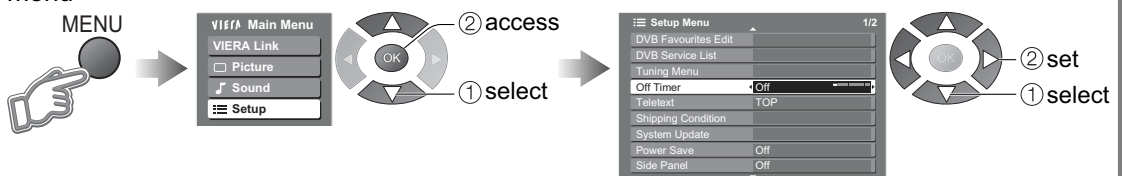

- To cancel → Set to "Off" or turn the TV off.
- To display the remaining time → Information banner (above)
- When the remaining time is within 3 minutes, the remaining time will flash on screen.

Watching TV

Other useful functions

Change the aspect ratio



Enjoy viewing the picture at its optimum size and aspect.

Display Aspect Selection list



While the list is displayed, select the mode

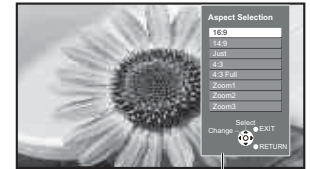
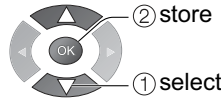

Aspect Selection list

- To change the mode using the ASPECT button only

➔ (Press repeatedly until you reach the desired mode)

Change aspect ratio



16:9

Directly displays the image at "16:9" without distortion (anamorphic).



14:9

Displays the image at the standard "14:9" without distortion.



Just

Displays a "4:3" image full-screen. Stretching is only noticeable at the left and right edges.

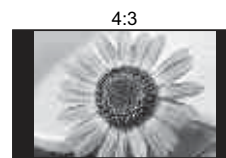

4:3

Displays the image at the standard "4:3" without distortion.

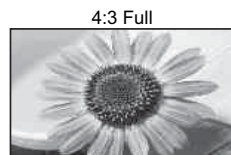

4:3 Full

Displays a "4:3" image enlarged horizontally to fit the screen.
● Only available in DVB mode or HD signal



Zoom1

Displays a "16:9" letterbox or "4:3" image without distortion.



Zoom2

Displays a "16:9" letterbox (anamorphic) image full-screen without distortion.



Zoom3

Displays a "2.35:1" letterbox (anamorphic) image full-screen without distortion. At "16:9", displays the image at its maximum (with slight enlargement).

Note

- Only "16:9" and "4:3 Full" are available in DVB mode.
- Only "16:9" and "4:3" are available in PC mode.
- Not available in teletext mode.
- Aspect mode can be memorized separately for SD (Standard definition) and HD (High definition) signals. (except DVB mode)

Using TV Guide

Using TV Guide enables you to select programme easily, view event informations, etc. TV Guide—Electronic Programme Guide (EPG) provides an on-screen listing of the programmes currently broadcast and the future broadcasts over the next seven days (depending on the broadcasters).

- Analogue programmes will be listed after DVB programmes. “D” means DVB programme and “A” means Analogue programme.

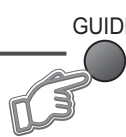

View TV Guide

Each time pressed, the layout will be changed. (Landscape / Portrait)

Example: **Current date and time** | **TV Guide date** | **TV Guide time** | **Event**

Time	3:00 am	3:30 am	4:00 am	4:30 am	5:00 am
D 1 TEN Digital	Eastender	DIY SOS	The Bill	Red Cap	Sports
D 2 ABC TV Sydney	Hot Wars		Horiday Program		Live junction
D 3 SBS D(G)ITAL	Emmerdal.	Coronation Street	The Bill		Drama
D 4 FTV guide	10 O' clock News BBC	Pepsi Char.	Good bye	NEWS	
D 7 7 Digital	Panorama	Sex And The City	Terminator	Hello	
D105 BBCi	I'm A Celebrity	Pop Idol	News	News	
D719 BBC Radi	Rugby	15 To 1	The Bill	Japan	

Service | Landscape (Displays by service)

Example:

Time	3:00 am - 3:30 am	3:30 am - 4:00 am	4:00 am - 4:30 am	4:30 am - 5:00 am	5:00 am - 5:30 am	5:30 am - 6:00 am	6:00 am - 6:30 am
D 1 TEN Digital	Eastender	DIY SOS	The Bill	Red Cap	Live junction	POP 100	Rugby

Portrait (Displays by time)

- To the previous day → R

- To the next day → G

- To watch the programme
Select the event or programme now on the air

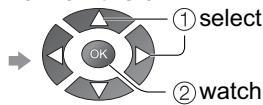

- To return to TV



- To view details of the event (DVB mode)

Select the event



● Press again to return to TV Guide.

- To view a programme list of the selected type (DVB mode)

(Type list)

Prog. type	All Types
All Types	
Movie	
News	
Entertainment	
Sport	
Children's	
Music	
...	

Y → select type → OK → view

- To view a programme list of the selected favourites list

(Favourites list)

Favourites	All Services
All Services	
All DVB Services	
All Analogue Services	
Fav List1	
Fav List2	
Fav List3	
Fav List4	

B → select a favourites list → OK → view

Only Analogue TV programmes are listed

To list favourite programmes → p. 29

Note

- When this TV is turned on for the first time, or the TV is switched off for more than a week, it may take some time before the TV Guide is completely shown.

Viewing Teletext

You can enjoy teletext broadcasting, including news, weather forecasts and subtitles, if this service is provided by the broadcasters.



What is FASTEXT mode?

In FASTEXT mode, four differently coloured subjects are situated at the bottom of the screen. To access more information about one of these subjects, press the appropriately coloured button. This facility enables fast access to information on the subjects shown.

What is TOP mode? (in case of TOP text broadcasting)

TOP is a particular improvement of the standard teletext service that results in an easier search and effective guide.

- Fast overview of the teletext information available
- Easy to use step-by-step selection of the topical subject
- Page status information at the bottom of the screen

Available page up / down →  

To select among subject blocks → 

To select next subject within the subject block
(After the last subject, it moves to the next subject block.) → 

What is List mode?

In List mode, four differently coloured page numbers are situated at the bottom of the screen. Each of these numbers can be altered and stored in the TV's memory. ("Store frequently viewed pages", p. 19)

■ **To change mode** → "Teletext" in Setup Menu (p. 25)







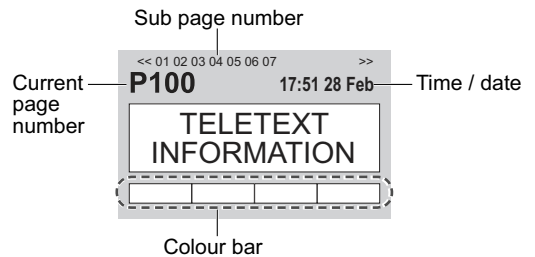

Switch to Teletext

 ● Displays Index (content varies depending on the broadcasters)

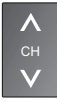





Select the page (up to page 899)









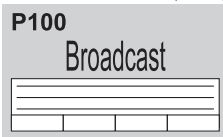
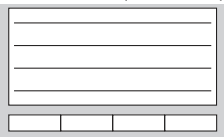
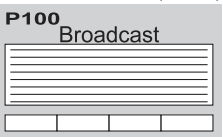







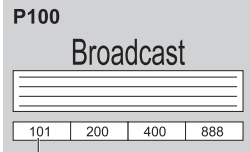

 or  or  or 
 (Corresponds to the colour bar)

■ **To adjust contrast** →  (Press three times) →  As the blue bar is displayed

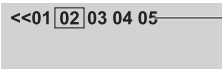
■ **To return to TV** →  or 

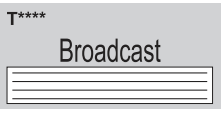
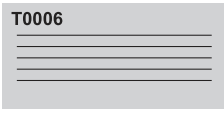
Using teletext conveniently

Reveal hidden data	Reveal hidden words e.g. quiz page answers  →  ■ Re-hide → 
FULL / TOP / BOTTOM	 →  <div style="display: flex; justify-content: space-around; align-items: center;"> <div style="text-align: center;"> <p>(TOP)</p>  (Expand the TOP half) </div> <div style="text-align: center;"> <p>(BOTTOM)</p>  (Expand the BOTTOM half) </div> <div style="text-align: center;"> <p>Normal (FULL)</p>  </div> </div>

HOLD	<p>Stop automatic updating (If you wish to hold the current page without updating)</p> <p>HOLD  To resume → HOLD </p>												
INDEX	<p>Return to the main index page</p> <p>INDEX </p>												
Call up subtitles	<p>Display subtitles</p> <p>STTL  <ul style="list-style-type: none"> ● Call up P801 (subtitle page) if available. ● If you press this button during P801 is displayed, teletext mode will be cancelled and return to TV. </p>												
View in multi window	<p>Watch TV and Teletext in two windows at once</p> <p>MENU  (Press twice) →  <ul style="list-style-type: none"> ● Select Picture and text On or Off <p>● Operations can be made only in Teletext screen.</p>  </p>												
Store frequently viewed pages	<p>Store frequently viewed pages in the colour bar (List mode only)</p> <p>As page is displayed  Corresponding colour button → OK  press and hold</p>  <p>The number changes to white.</p> <p>■ To change stored pages</p> <p>→  Colour button you want to change → Enter new page number</p> <table border="1" data-bbox="724 1240 863 1368"> <tr><td>1</td><td>2</td><td>3</td></tr> <tr><td>4</td><td>5</td><td>6</td></tr> <tr><td>7</td><td>8</td><td>9</td></tr> <tr><td>0</td><td></td><td></td></tr> </table> <p>→ OK  press and hold</p>	1	2	3	4	5	6	7	8	9	0		
1	2	3											
4	5	6											
7	8	9											
0													
View sub page	<p>View sub page (Only when teletext is more than one page)</p> <p>  Appears at top of the screen</p> <p>■ To view specific sub page</p> <p>→ MENU  → B </p> <p> Enter the 4-digit number</p> <p>example: P6 </p> <p>● Sub pages: The number of sub pages varies depending on the broadcasters (up to 79 pages). It may take some time for searching, during which time you can watch TV.</p>												
Watch TV while waiting for update	<p>View the TV picture while searching for a teletext page Teletext automatically updates itself when new information becomes available. Changes to TV screen temporarily</p> <p>MENU  → Y  →  Appears when updating is completed → Y  → View the updated page</p> <p>(You cannot change the programme.)</p> <ul style="list-style-type: none"> ● The news page provides a function that indicates arrival of latest news ("News Flash"). 												

Watching Videos and DVDs

Connect the external equipment (VCRs, DVD equipment, etc.) and you can watch the input.

● To connect the equipment → p. 8-10

The Remote Control is capable of operating some functions of selected Panasonic external equipment.

1 Display the Input select menu



2 Select the input mode connected to the equipment

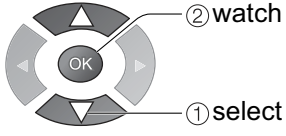

Input Selection
AV1
AV2
AV3
AV4
PC
HDMI1
HDMI2
TV

3 View
Displays the selected mode

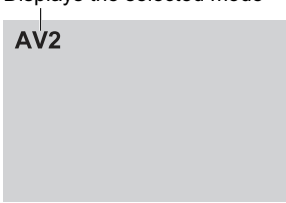

● You can also select the input using the AV button on the remote control or the front panel of the TV.
Press the button repeatedly until the desired input is selected.

● You can label or skip each input modes → "Input Labels" (p. 33)









■ To return to TV







Note

- If the external equipment has an aspect adjustment function, set to "16:9".
- For details, see the manual of the equipment or ask your local dealer.

Panasonic equipment connected to the TV can be directly operated with the remote control.

	<p>VCR / DVD switch* Select VCR to operate Panasonic VCR or DVD equipment Select DVD to operate Panasonic DVD equipment or Player home theatre</p>
	<p>Standby Set to Standby mode / Turn on</p>
	<p>Play Playback videocassette / DVD</p>
	<p>Stop Stop the operations</p>
	<p>Rewind / Skip / Search VCR: Rewind, view the picture rapidly in reverse DVD: Skip to the previous track or title Press and hold to search backward</p>
	<p>Fast-forward / Skip / Search VCR: Fast-forward, view the picture rapidly forward DVD: Skip to the next track or title Press and hold to search forward</p>
	<p>Pause Pause / Resume DVD: Press and hold to play at slow speed</p>
	<p>Programme Up / Down Select programme</p>
	<p>Record Start recording</p>

***Setting your remote control to operate Panasonic VCR, DVD, etc.**

- ① Set the VCR / DVD switch to the appropriate position → 
- ② Press and hold  during the following operations
 Enter the appropriate code for the equipment to be controlled, see table below
 → Press 

“VCR” position

Equipment	Code
VCR	10 (default)
DVD	11

“DVD” position

Equipment	Code
DVD	70 (default)
Player home theatre	71

Note

- Confirm if the remote control works correctly after changing the code.
- The codes will be reset to default values if batteries are replaced.
- “DVD” means DVD player, DVD recorders and Recorder home theatre.
- Some operations may not be possible on some equipment models.

How to Use Menu Functions

Various menus allow you to make settings for the picture, sound, and other functions.

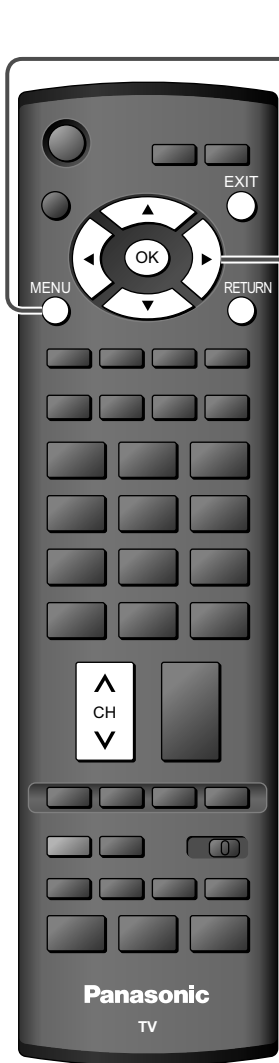

1

Display the menu

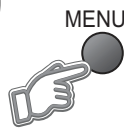

- Displays the functions that can be set (varies according to the input signal)

2

Select the menu

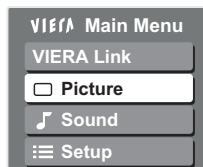

(example: Picture Menu)

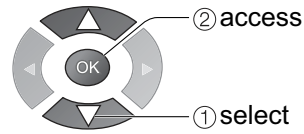

3

Select the item

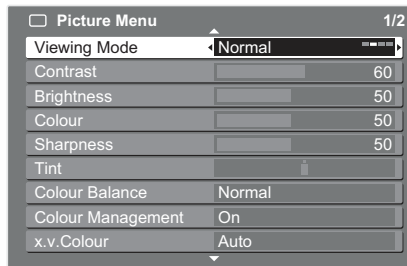

(example: Picture Menu)

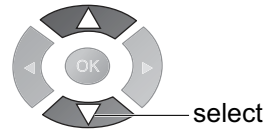

4

Adjust or select

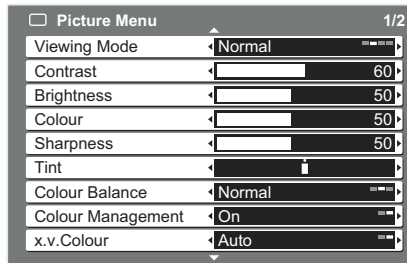

(example: Picture Menu)

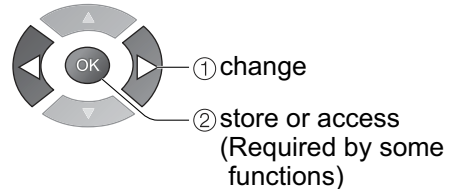

■ To return to TV at any time



■ To return to the previous screen



■ To change menu pages

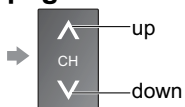

■ Choose from among alternatives

Number and positions of alternatives



Changed

■ Adjust using the slide bar



Moved

■ Go to the next screen



Displays the next screen

■ Enter characters by free input menu

You can enter names or numbers freely for some items.



Set characters

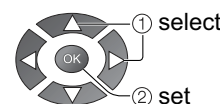

Store



■ To reset the settings

- To reset the picture settings only
➔ "Reset Picture Defaults" in Picture Menu (p. 24)
- To reset the sound settings only
➔ "Reset Sound Defaults" in Sound Menu (p. 24)
- To initialize all settings
➔ "Shipping Condition" in Setup Menu (p. 32)

■ Overview

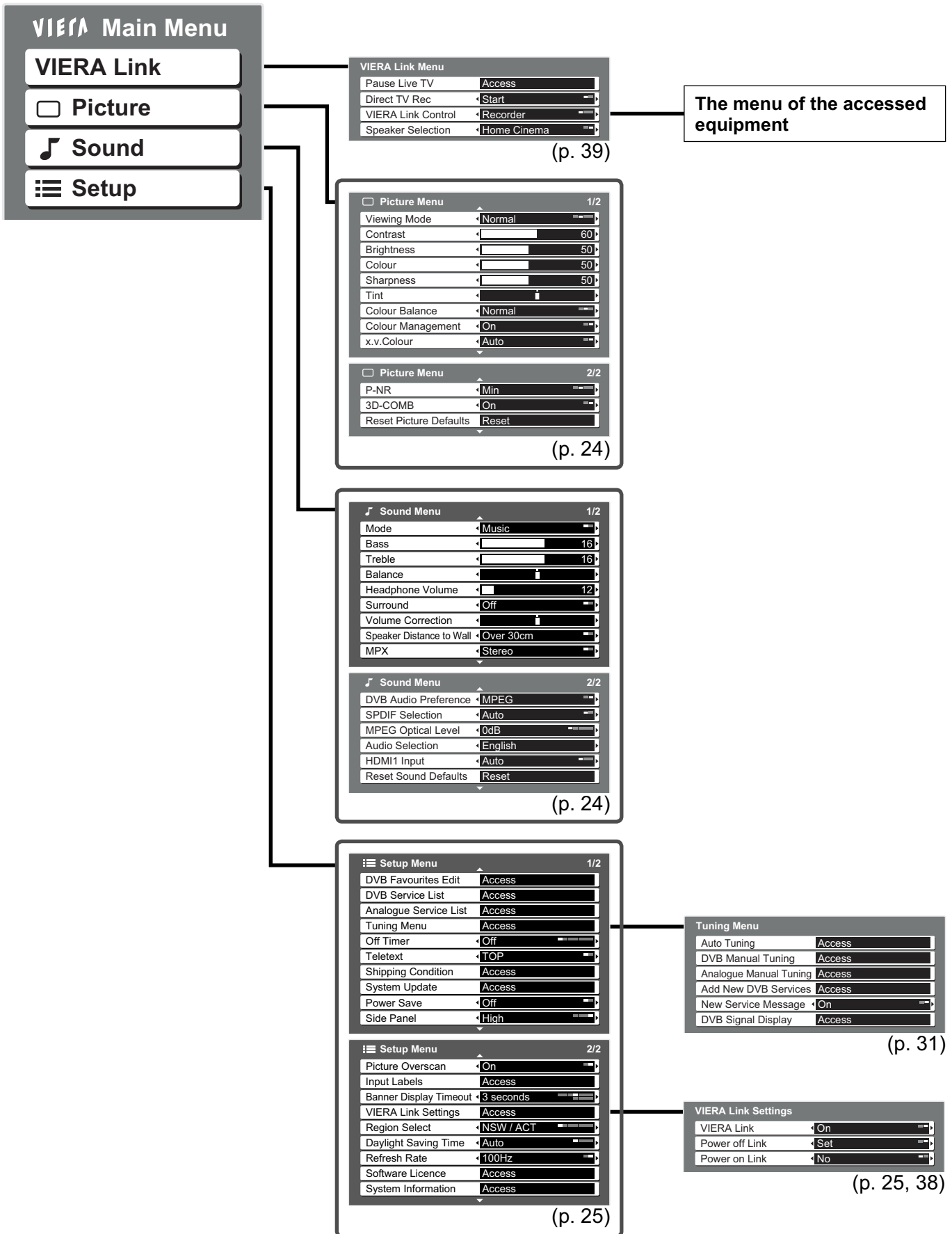

● How to Use Menu Functions
(picture, sound quality, etc.)

Advanced

● Depending on the received signals, available items are varied.

How to Use Menu Functions

■ Menu list

Menu	Item	Adjustments / Configurations (alternatives)
VIERA Link	Pause Live TV	Controls the connected equipment with VIERA Link function, and enables various convenient recording, playback, etc. (p. 39 - 41) ● You can also access VIERA Link Menu directly using the VIERA Link button on the remote control.
	Direct TV Rec	
	VIERA Link Control	
	Speaker Selection	
Picture	Viewing Mode	Basic picture mode (Dynamic / Normal / Cinema / Eco) Dynamic : Provides enhanced picture contrast and sharpness when viewing in a bright room Normal : Recommended for viewing under normal ambient room lighting conditions Cinema : For watching movies in a darkened room producing a cinema-like picture Eco : Adjusts picture settings automatically dependent on ambient lighting conditions ● Set for each input signal
	Contrast, Brightness, Colour, Sharpness	Increases or decreases the levels of these options according to your personal preference
	Tint	With an NTSC signal source connected to the TV, the picture hue can be adjusted to suit your taste ● For NTSC or Component / HDMI input signal reception only
	Colour Balance	Allows you to set the overall colour tone of the picture (Cool / Normal / Warm)
	Colour Management	Automatically adjusts colours to vivid ones (Off / On) ● Not valid on PC signal
	x.v.Colour	Increases the colour gradations (Off / Auto) This is effective when watching HD moving pictures with extended gamut (xvYCC) from external equipment. ● HDMI input mode only
	P-NR	Picture Noise Reduction Automatically reduces unwanted picture noise and flicker noise in the contoured parts of a picture (Off / Min / Mid / Max) ● Not valid on PC signal
	3D-COMB	Occasionally, whilst viewing still or slow moving pictures, colour patterning may be seen Set to "On" to display sharper and more accurate colours (Off / On) ● For PAL or NTSC signal reception only ● Not valid on S-Video, Component, PC, HDMI and SD Card
	Reset Picture Defaults	Press the OK button to reset Viewing Mode on all inputs to default settings.
Sound	Mode	Basic sound mode (Music / Speech)
	Bass	Increases or decreases level to enhance or minimise lower, deeper sound output
	Treble	Increases or decreases level to enhance or minimise sharper, higher sound output
	Balance	Adjusts volume level of right and left speakers
	Headphone Volume	Adjusts the volume of the headphones
	Surround	Surround sound settings (Off / On) Provides a dynamic enhancer to simulate improved spatial effects
	Volume Correction	Adjusts volume of individual programme or input mode
	Speaker Distance to Wall	Adjusts the low frequency sound (Over 30cm / Up to 30cm) ● If the back space between the TV and wall is over 30 cm, "Over 30cm" is recommended. ● If the back space between the TV and wall is within 30 cm, "Up to 30cm" is recommended. Select stereo / monaural (Mono / Stereo) (p. 45) ● Normally: Stereo ● Stereo signal cannot be received: Mono ● M1 / M2: Available while mono signal is transmitted ● Analogue mode only
	MPX	● Normally: Stereo ● Stereo signal cannot be received: Mono ● M1 / M2: Available while mono signal is transmitted ● Analogue mode only
	DVB Audio Preference	Selects the initial setting for Audio tracks (Dolby Digital / MPEG) If programme has both Dolby Digital and MPEG audio tracks, priority is given to what you select Dolby Digital: A method of coding digital signals developed by Dolby Laboratories. Apart from stereo (2ch) audio, these signals can also be multi-channel audio. MPEG: An audio compression method that compresses audio to small size without any considerable loss of audio quality. ● DVB mode only
	SPDIF Selection	Selects the initial setting for digital audio output signal from DIGITAL AUDIO OUT terminal (Auto / PCM) Auto: Dolby Digital is output as Dolby Digital Bitstream. MPEG is output as PCM. PCM: Dolby Digital is output as PCM. MPEG is output as PCM. ● DVB mode only
	MPEG Optical Level	You can adjust the audio level of MPEG output from DIGITAL AUDIO OUT terminal as the initial setting ● 0dB to -12dB in -2dB reductions ● DVB mode only
	Audio Selection	Selects the preferred language for DVB multi audio (depending on the broadcaster)
	HDMI1 Input	Select to fit the input signal (Auto / Digital / Analogue) (p. 35) Auto: Automatic detection of digital or analogue sound source Digital: HDMI cable connection Analogue: HDMI-DVI adapter cable connection ● HDMI input mode only ● HDMI2 terminal is for digital signal only ● No setting for HDMI2 available
Reset Sound Defaults	Press the OK button to reset the present Sound Mode to the default settings	

■ Menu list

Menu	Item	Adjustments / Configurations (alternatives)	
Setup	DVB Favourites Edit	Creates list of favourite programmes (p. 29)	
	DVB Service List	Skips the unwanted DVB programmes (p. 29)	
	Analogue Service List	Skips the unwanted Analogue programmes or edits Analogue programmes (p. 29)	
	Tuning Menu	Auto Tuning	Automatically sets the programmes received in the area (p. 31)
		DVB Manual Tuning	Sets the DVB programmes manually (p. 31)
		Analogue Manual Tuning	Sets the Analogue programmes manually (p. 31)
		Add New DVB Services	Adds new DVB services (p. 31)
		New Service Message	Selects whether to give a notification message when a new DVB service is found (Off / On) (p. 31)
		DVB Signal Display	Checks the DVB signal condition (p. 31)
	Off Timer	Sets the time the TV automatically turns Off (Off / 15 / 30 / 45 / 60 / 75 / 90 minutes)	
	Teletext	Teletext display mode (TOP (FASTEXT) / List) (p. 18)	
	Shipping Condition	Resets all settings, for example, when moving house (p. 32)	
	System Update	Downloads new software to TV (p. 27)	
	Power Save	Reduces brightness of picture to economise on power consumption (Off / On)	
	Side Panel	Increases the brightness of the side panel (Off / Low / Mid / High) ● The recommended setting is "High" to prevent panel "image retention"	
	Picture Overscan	Selects the screen area displaying the image (Off / On) On : Enlarged the image to hide the edge of the image. Off : Displayed the image in the original size. ● Set to "On" if noise is generated on the edge of the screen. ● This function is available when aspect is set to "16:9". ● This function can be memorized separately for "SD" (Standard definition) and HD (High definition) signals.	
	Input Labels	Labels or skips each input terminals (p. 33)	
	Banner Display Timeout	Sets how long the information banner (p. 15) stays on screen ● 0 (No display) to 10 sec. in 1-sec. increments	
	VIERA Link Settings	VIERA Link	Sets to use VIERA Link functions (Off / On) (p. 38)
		Power off Link	Sets to use Power off Link function (No / Set) (p. 38)
Power on Link		Sets to use Power on Link function (No / Set) (p. 38)	
Region Select	Selects the region where you live to adjust the standard time (NSW/ACT / Victoria / Queensland / South Australia / Western Australia / Northern Territory / Tasmania) (p. 27)		
Daylight Saving Time	Selects time offset from the standard time for Summer Time (Auto / Off / +1/2 Hr / +1 Hr) (p. 27) ● Set to "Auto" normally		
Refresh Rate	Changes the image processing of the panel (depending on the input signal) (50Hz / 100Hz) ● Set to "100Hz" normally		
Software Licence	Displays the software licence information		
System Information	Displays the system information of this TV		

- A different menu will be displayed while PC, DVI to HDMI adapter cable or SD Card is used. (p. 34-35 and p. 37)
- Only available items can be selected.

DVB Settings (DVB mode)

DVB Settings provide access to various advanced features.

1 If in Analogue mode
Select DVB

2 **Display the menu**

3 **Select "Setup"**

4 **Select "System Update", "Region Select" or "Daylight Saving Time"**

5 **Set**

■ **To return to TV**
EXIT

VIFF Main Menu

VIERA Link
Picture
Sound
Setup

Setup Menu 1/2

DVB Favourites Edit	
DVB Service List	
Tuning Menu	
Off Timer	Off
Teletext	TOP
Shipping Condition	
System Update	Access
Power Save	Off
Side Panel	Off

Setup Menu 2/2

Picture Overscan	On
Input Labels	
Banner Display Timeout	3 seconds
VIERA Link Settings	
Region Select	NSW / ACT
Daylight Saving Time	Auto
Refresh Rate	100Hz
Software Licence	
System Information	

Update TV's software system

System Update

Download new software to TV.
● For details → p. 44

If System Update is performed, the software will be updated (it may change TV functions). If you do not wish to do so, set "Auto Update Search in Standby" to Off.

Select "Auto Update Search in Standby" and then set "On" or "Off"

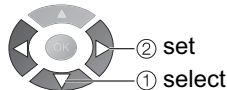
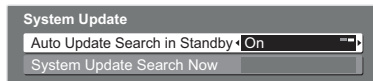

- On: Automatically performs a search in standby and downloads an update, if any software updates are available

Note

- When the TV is switched to standby, there will be a clicking sound after a short delay. Similar clicking sounds will also occur at 3:00 AM and 5:00 AM (p. 44) when "Auto update Search in Standby" is set to "On". These sounds are normal.

■ To update immediately

Select "System Update Search Now"

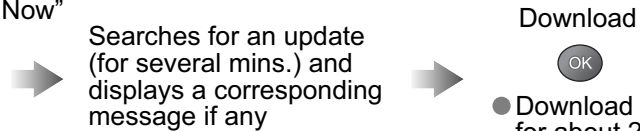
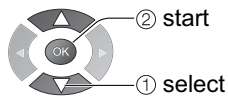

- Download may take for about 20 mins.

Note

- During downloading, the TV will display a blank screen for 40 to 50 seconds. Do not interrupt the TV during this procedure.

Adjust the standard time

Region Select

Select the region where you live to adjust the standard time.

- The time contained in the broadcast signal is UTC (Universal Time coordinated) formally known as GMT (Greenwich Mean Time).

Region	Standard time	Daylight Saving Time: Auto (During Summer Time)
NSW / ACT	+10:00	+11:00
Victoria		
Queensland	+10:00	
South Australia	+9:30	+10:30
Western Australia	+8:00	+9:00
Northern Territory	+9:30	
Tasmania	+10:00	+11:00

(Based on GMT)

Adjust for Summer Time

Daylight Saving Time

Select time offset from the standard time for Summer Time.

- Normally select "Auto".
- If there is a gap between displayed time and actual time, set this function.

Editing Programmes

You can make your favourite programme lists and skip unwanted programmes, etc.

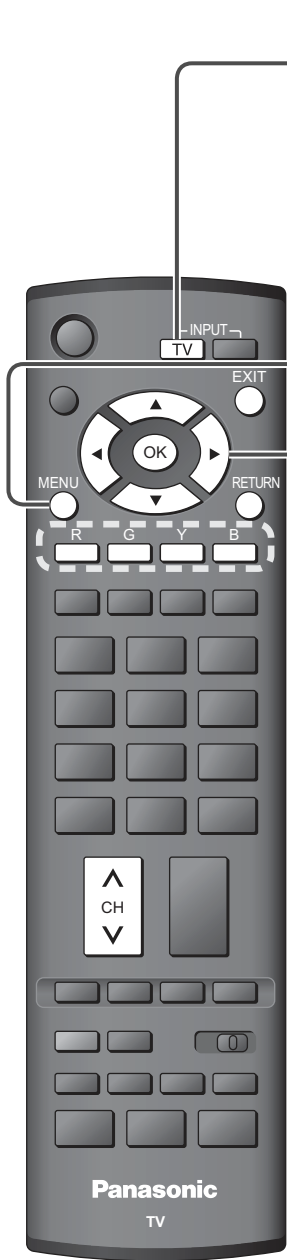

1

Select DVB or Analogue



- “DVB Favourites Edit” and “DVB Service List” are available in DVB mode only.
- “Analogue Service List” is available in Analogue mode only.

2

Display the menu

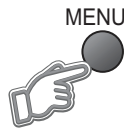

3

Select “Setup”

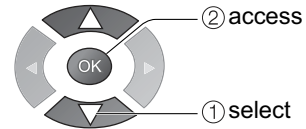
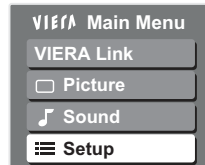

4

Select “DVB Favourites Edit”, “DVB Service List” or “Analogue Service List”

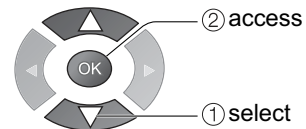
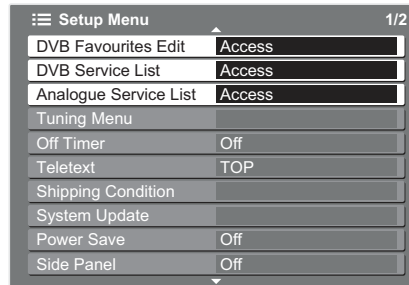

■ To return to TV



5

Set

List favourite programmes

DVB Favourites Edit

(DVB mode)

Create your favourite programme list from various broadcasters (up to 4: Fav List1 / Fav List2 / Fav List3 / Fav List4). The list is added to "Favourites" list in TV Guide (p. 17) and information banner (p. 15) and then easily accessed.

Select a programme and add it to the list

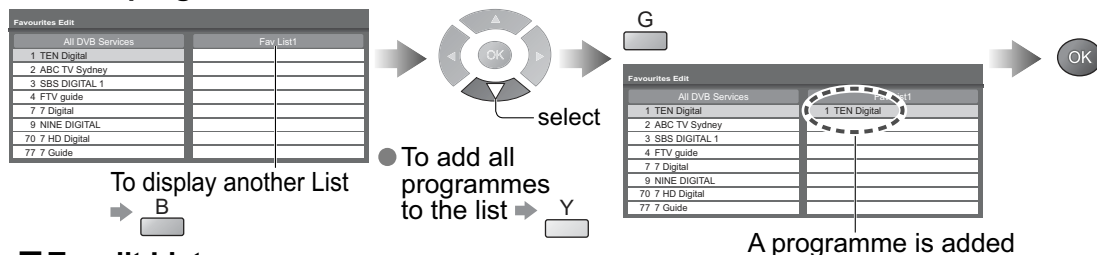

To edit List



Select the field of List to edit and:

- To name the List → R → Select the character → OK → RETURN
- To move the programme → G → Select the new position → Confirm → OK
- To delete the programme → Y → OK
- To delete all programmes → B → OK

Note

- Programme numbers (known as logical channel numbers) are defined by the broadcaster and cannot be changed.
- Hidden services (see below) can be selected but not viewed.

Skip unwanted programmes

DVB Service List

Analogue Service List

You can hide unwanted services. The deleted services cannot be displayed except in this function. Use this function to skip unwanted programmes.

- "DVB Service List" is listed all tuned DVB programmes in DVB mode.
- "Analogue Service List" is listed all tuned Analogue programmes in Analogue mode.

Select a service and add / delete

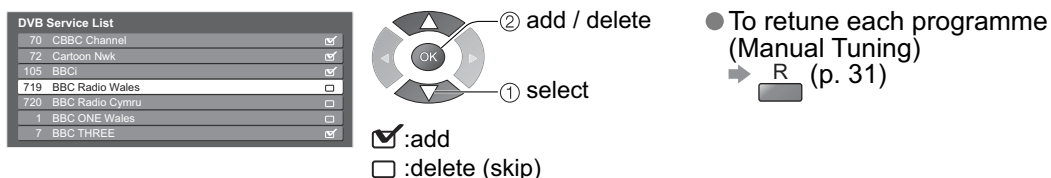

Edit analogue programmes (Change name, Move)

Analogue Service List

You can change the programme name and programme position for Analogue programmes.

- This function is available in Analogue mode.
- If a VCR is connected only with the RF cable, edit "VCR".

① **Select the programme to edit**

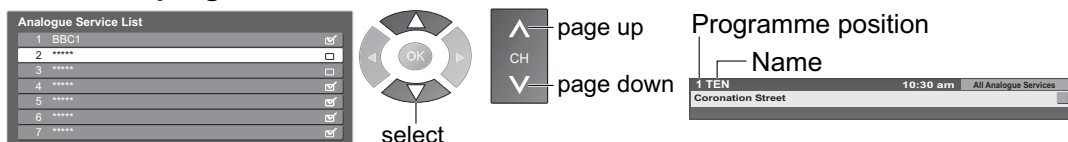

② **Edit**

To change the name displayed when selecting programmes

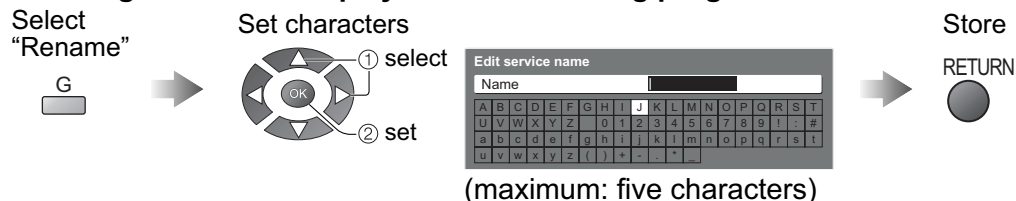

To move the programme position



Tuning Programmes

You can retune all the TV programmes when moving house or search for new services which may have recently started broadcasting.

- ### Select DVB or Analogue

 - “DVB Manual Tuning”, “Add New DVB Services”, “New Service Message” and “DVB Signal Display” are available in DVB mode only.
 - “Analogue Manual Tuning” is available in Analogue mode only.
- ### Display the menu
- ### Select “Setup”

VIERA Main Menu
VIERA Link
Picture
Sound
Setup
- ### Select “Tuning Menu”

Setup Menu	1/2
DVB Favourites Edit	
DVB Service List	
Tuning Menu	Access
Off Timer	Off
Teletext	TOP
Shipping Condition	
System Update	
Power Save	Off
Side Panel	Off
- ### Select a function

Tuning Menu	
Auto Tuning	Access
DVB Manual Tuning	Access
Analogue Manual Tuning	Access
Add New DVB Services	Access
New Service Message	On
DVB Signal Display	Access
- ### Set

① select
 ② access

① select
 ② access

① select
 ② access

To return to TV
 EXIT

■ **For Auto Tuning, using the buttons on the front of the TV (p. 11)**

① Press repeatedly until “Auto Tuning” appears



② Access “Auto Tuning”



③ Start “Auto Tuning”



● To return to TV →

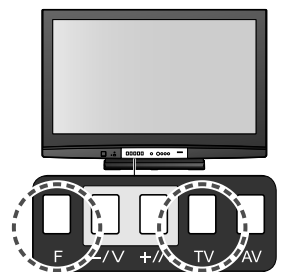

Set all DVB or Analogue programmes automatically

Auto Tuning

Automatically retune all DVB or Analogue programmes received in the area.

- Only DVB programmes are retuned in DVB mode.
- Only Analogue programmes are retuned in Analogue mode.

Start Auto Tuning

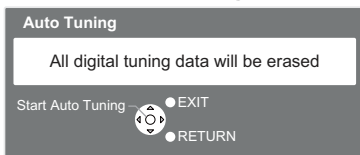

Settings are made automatically

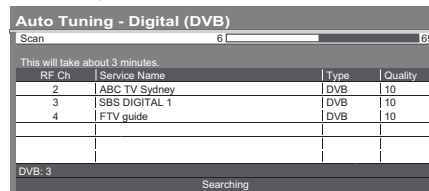

- All the previous tuning settings are erased.
- When the operation is completed, the programme at programme position "1" will be displayed.
- If tuning has not been done completely → "DVB Manual Tuning", "Analogue Manual Tuning"

Set DVB programme manually

DVB Manual Tuning

Normally use "Auto Tuning" or "Add New DVB Services" to add DVB programmes to your service list. If tuning has not been done completely or for adjusting the direction of the aerial, use this function.

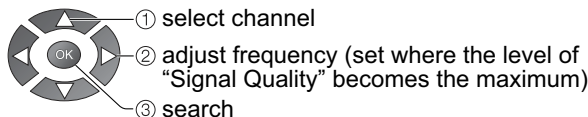
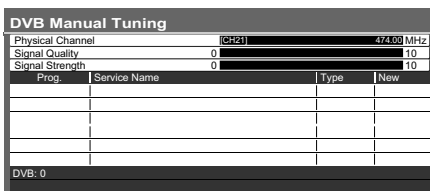

- All services found will be added to the DVB Service List.

Set Analogue programme manually

Analogue Manual Tuning

Set Analogue programme manually after Auto Tuning.

- If a VCR is connected only with the RF cable, select programme position "0".



Select the programme position



Select the programme



Search and store

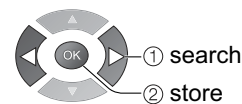

Add DVB programme automatically

Add New DVB Services

Any new services found will be added to the DVB Service List.

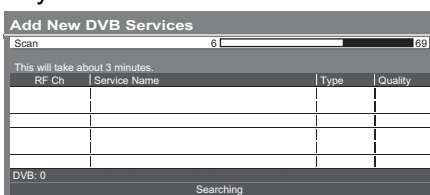

- The new service is added with the current settings saved as they are.

Display a notification message

New Service Message

Selects whether to give a notification message when a new DVB service is found. (Off / On)



Check DVB signal

DVB Signal Display

Selects a programme and checks the DVB signal condition.

- To change the programme

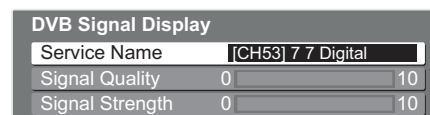

A good Signal Strength is not an indication of suitable signal for DVB reception. Please use the Signal Quality indicator as follows:

- Signal Quality:**
- Green bar → Good
 - Yellow bar → Poor
 - Red bar → Bad (Check the aerial)

Restore Settings

Resets the TV to its original condition, i.e. no programmes tuned in. All settings (programmes, picture, sound quality, etc.) are reset.

1 Display the menu

MENU

2 Select "Setup"

VIERA Main Menu
VIERA Link
Picture
Sound
Setup

② access
① select

3 Select "Shipping Condition"

Setup Menu	1/2
DVB Favourites Edit	
DVB Service List	
Tuning Menu	
Off Timer	Off
Teletext	TOP
Shipping Condition	Access
System Update	
Power Save	Off
Side Panel	Off

② access
① select

4 Set

■ To return to TV
EXIT

Restore Settings

Shipping Condition

① **Check the message and initialize**

Shipping Condition

Analogue & DVB tuning data will be erased
Are you sure?
Are you sure?

Confirm

● EXIT

● RETURN

② **Follow the on-screen instructions**

- "Auto Tuning" will automatically start when Mains power On / Off switch is next turned On. (p. 12)

■ **To retune TV programmes only, e.g. after moving house**

➔ "Auto Tuning" (p. 31)

Input Labels

For easier identification and selection of the input mode, you can label each input terminals or skip terminal that is not connected to any equipment.

● To select the input mode → p. 20



1 Display the menu

2 Select "Setup"

3 Select "Input Labels"

4 Select a input terminal and set

■ To return to TV
→ EXIT

The labels you set will be displayed in "Input Selection" menu (p. 20) or banner.
● If "Skip" is selected, you cannot select the mode.

■ **User input**
You can name each input terminals freely.

Select "User input" → Set characters → Store

(maximum: ten characters)

● Input Labels
● Restore Settings

Advanced

Displaying PC Screen on TV

The screen of the PC connected to the TV can be displayed on the TV.
You can also listen to PC sound with the audio cable connected.

● To connect PC → p. 42

1 Select the external input



2 Select "PC"



Input Selection

- AV1
- AV2
- AV3
- AV4
- PC**
- HDMI1
- HDMI2
- TV

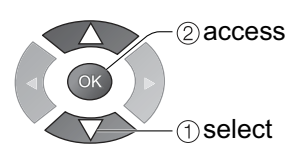

- Corresponding signals → p. 46
- If "H-freq." or "V-freq." is shown in red, the signals may not be supported.
- PC Audio input is via AV2 Audio connection. (p. 43)

■ **To return to TV**



■ **PC menu setting (changed as desired)**

● To make settings → "How to Use Menu Functions" ① to ④ (p. 22)

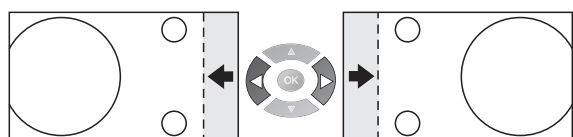
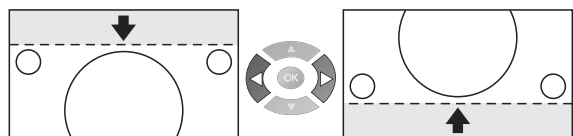
Menu	Item	Adjustments / Configurations (options)	
Picture	Advanced PC Settings	W/B High R	White balance of bright red area
		W/B High B	White balance of bright blue area
		W/B Low R	White balance of dark red area
		W/B Low B	White balance of dark blue area
		Gamma	(S Curve / 2.0 / 2.2 / 2.5)
	Reset PC Settings	Press the OK button to reset to the default Picture settings	
Setup	Input Resolution	Switches to a wide view ● VGA (640 × 480 pixels), WVGA (852 × 480 pixels), XGA (1,024 × 768 pixels), WXGA (1,366 × 768 pixels) ● Options change depending on signals	
	Clock	Set to the minimum level if noise occurs	
	H-pos	Adjusts horizontal position 	
	V-pos	Adjusts vertical position 	
	Clock Phase	Eliminates flicker and distortion ● Adjust after Clock adjustment ● Set to the minimum level if noise occurs	
	Sync	PC sync signal type (H & V / SOG) ● H & V : Horizontal and Vertical sync from your PC (Most common sync format) SOG : Sync on Green sync from your PC	
	Reset PC Settings	Press the OK button to reset to the default Setup settings	

HDMI Functions

HDMI (high-definition multimedia interface) allows you to enjoy high-definition digital images and high-quality sound by connecting the TV and the equipment.

HDMI-compatible equipment (*1) with an HDMI or DVI output terminal, such as a set top box, a DVD player or a game equipment, can be connected to the HDMI terminal using an HDMI compliant (fully wired) cable.

About connections, see “External Equipment” (p. 42).

Note

- HDMI is the world’s first complete digital consumer AV interface complying with a non-compression standard.
- Audio settings can be made on the “HDMI1 Input” menu screen. (p. 24)
- Applicable audio signal sampling frequencies (2ch L.PCM): 48 kHz, 44.1 kHz, 32 kHz
- HDMI2 terminal is for digital audio signal only.
- Use with a PC is not guaranteed. Only HDMI video formats in page 46 HDMI table are applicable.
- If the connected equipment has an aspect adjustment function, set the aspect ratio to “16:9”.
- These HDMI connectors are “type A”.
- These HDMI connectors are compatible with HDCP (High-Bandwidth Digital Content Protection) copyright protection.
- An equipment having no digital output terminal may be connected to the input terminal of either “COMPONENT”, “S-VIDEO”, or “VIDEO” to receive analogue signals.
- The HDMI input terminal can be used with only the following image signals: 480i, 480p, 576i, 576p, 720p, 1080i and 1080p. Match the output setting of the digital equipment.
- For details of the applicable HDMI signals, see p. 46.

DVI connection

- If the external equipment has only a DVI output, connect to the HDMI1 terminal via a DVI to HDMI adapter cable (*2).
- When the DVI to HDMI adapter cable is used, connect the audio cable to the audio input terminal (HDMI1: use AV2 IN AUDIO terminals).

DVI Position Settings

If the picture position is not fit to the screen during the DVI connection, adjust the position on “DVI Position Settings” in Setup Menu. The settings are memorized for each HDMI terminals and input signals.

- To make settings → “How to Use Menu Functions” ① to ④ (p. 22)

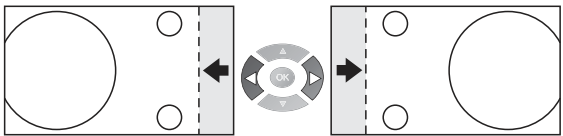
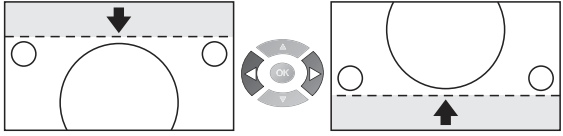
Menu	Item	Adjustments
Setup	DVI Position Settings	H-pos Adjusts horizontal position 
		V-pos Adjusts vertical position 
	Reset DVI Position Settings Press the OK button to reset to the default Setup settings	

(*1): The HDMI logo is displayed on HDMI-compliant equipment.
(*2): Enquire at your local digital equipment retailer shop.

Viewing from SD Card

Still images recorded by digital cameras will be displayed.

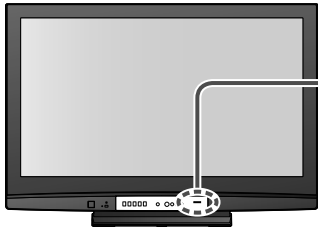

1

Insert the SD Card



2

Enter SD mode (Photo View Mode)



● All photos in SD Card are displayed by thumbnail.

3

Select the photo to be viewed

Selected photo Error display (images that could not be loaded, etc.)

Photo View Mode
All pictures
1/175

Filename p1010001
Date 23/10/2007
Pixel 1600 x 1200

Reading
Select EXIT
Select RETURN
View

Slide show Sort by Month Sort by Date

(Thumbnail)

● Slide show → p. 37

Selected photo information is displayed

- The maximum number of characters for Filename is 8.
- The photo without record of the date is shown "****/**/*****".

To sort by date or month recorded
(Sort by Month / Sort by Date)

Display the thumbnail grouped by the same date or the same month

Y (Sort by Month)

B (Sort by Date)

Select the group to be viewed

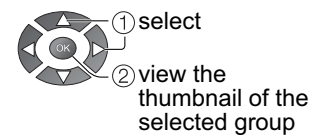

Note

- The group of the photos without record of the date is shown as "Unknown".

To return to TV



4

View

To display the operation guide → INFO or OPTION

Displayed one at a time

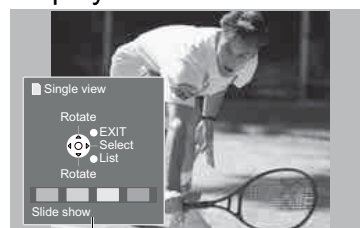

Operation guide

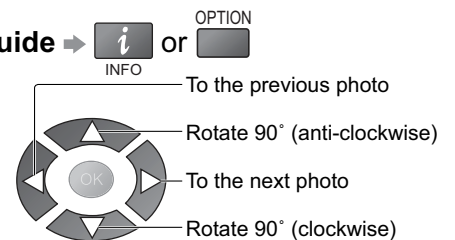

● To return to thumbnail



Caution

- During the operation, no signals are output from the monitor output terminals.

(Photos)

SD Card

● For details on SD Cards → p. 45

■ **To insert**

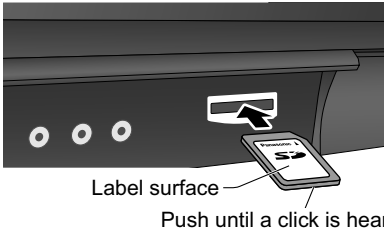

Label surface
Push until a click is heard

→

■ **To remove**

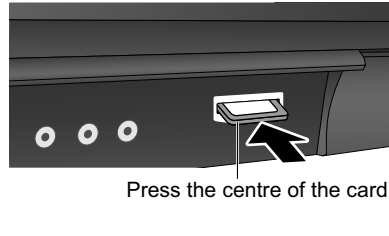

Press the centre of the card

Slide show

■ **Start Slide show** (operate in step ③ or ④)

- ① Select the photo for the first view ② Start Slide show



Note

● Slide show is done within the same group if started from the view of the group.

■ **Slide show settings** (operate in step ③ or ④)

- ① Display the menu ② Select "Viewing Setup" ③ Select the items and set

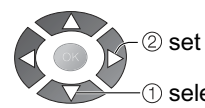
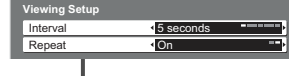
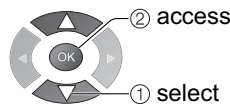
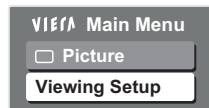

● "Picture Menu" (p. 24)

Menu	Item	Adjustments / Configurations (alternatives)
Viewing Setup	Interval	Select slide show interval (5 / 10 / 15 / 30 / 60 / 90 / 120 seconds)
	Repeat	Slide show repeat (Off / On)

Cautions in handling SD Card

- Do not remove the card while the TV is accessing data (this can damage card or TV).
- Do not touch the pins on the back of the card.
- Do not subject the card to a high pressure or impact.
- Insert the card in the correct direction (otherwise, card may be damaged).
- Electrical interference, static electricity, or erroneous operation may damage the data or card.
- Back up the recorded data at regular intervals in case of deteriorated or damaged data or erratic operation of the TV. (Panasonic is not liable for any deterioration or damage of recorded data.)

On screen messages

Message	Meaning / Action
Cannot read file	<ul style="list-style-type: none"> ● The file is broken or unreadable. ● The TV does not support the format. (For the applicable formats and data, see p. 45.)
Is SD Card in?	<ul style="list-style-type: none"> ● Insert a SD Card.
No valid file to play	<ul style="list-style-type: none"> ● The card has no data.
Over 9999 pictures found	<ul style="list-style-type: none"> ● Maximum valid number of photos is 9,999.

VIERA Link “HDAVI Control™”*

*Enjoy additional HDMI Inter-Operability with Panasonic products which have “HDAVI Control” function. This TV supports “HDAVI Control 3” function.

Connections to the equipment (DIGA Recorder, HD Video Camera, Player theatre, Amplifier, etc.) with HDMI cable allow you to interface them automatically.

These features are limited to models incorporating “HDAVI Control” and “VIERA Link”.

- Some functions are not available depending on the equipment’s version of HDAVI Control. Please confirm the connected equipment’s version of HDAVI Control.
- VIERA Link “HDAVI Control”, based on the control functions provided by HDMI which is an industry standard known as HDMI CEC (Consumer Electronics Control), is a unique function that we have developed and added. As such, its operation with other manufacturers’ equipment that supports HDMI CEC cannot be guaranteed.

Please refer to individual manuals for other manufacturers’ equipment supporting VIERA Link function. About applicable Panasonic equipment, consult your local Panasonic dealer.

Summary of VIERA Link functions

● Easy playback	● Power on link	● Power off link	● Speaker control
● Control the menu of the connected equipment by VIERA remote control (Available with the equipment which has “HDAVI Control 2” or “HDAVI Control 3” function.)			
● Pause Live TV programme (Available with the equipment which has “HDAVI Control 3” function.)		● Direct TV Recording	

Connections

Read the manual of the equipment, too.

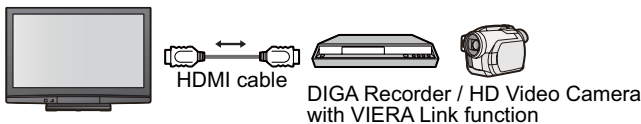

- HDMI cable
Use fully wired HDMI compliant cable. Non-HDMI-compliant cables cannot be utilized. Recommended Panasonic’s HDMI cable part number:
 - RP-CDHG10 (1.0 m)
 - RP-CDHG15 (1.5 m)
 - RP-CDHG20 (2.0 m)
 - RP-CDHG30 (3.0 m)
 - RP-CDHG50 (5.0 m)

- Connect the equipment supporting VIERA Link to the TV’s HDMI1 or HDMI2 terminals via fully wired HDMI cables.

For Speaker control (Home Cinema)

- To use Amplifier

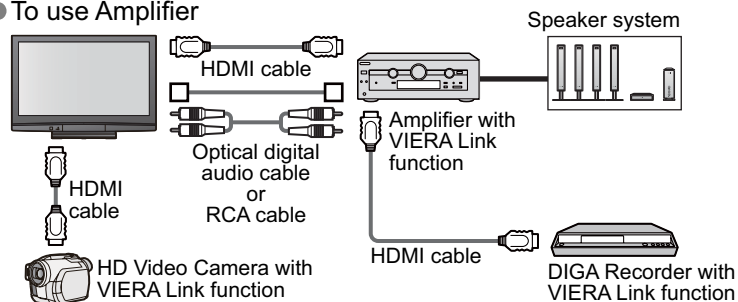

- To use Player theatre

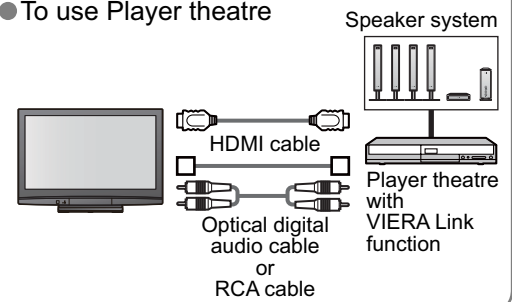

Preparations

- Connect the equipment supporting VIERA Link.
- Set up the connected equipment. Read the manual of the equipment.
- For optimal recording, the settings of the recorder might be required. For details, read the manual of the recorder.
- Set VIERA Link On in Setup Menu → “VIERA Link” (p. 22 - 23, 25)
- Set up the TV → **After connection, turn the equipment on and then switch the TV on. Select the input mode to HDMI1 or HDMI2 (p. 20), and make sure that an image is displayed correctly.**
This setup should be done each time when the following conditions occur:
 - for the first time / • when adding or reconnecting equipment / • when changing setup

Features available

Easy playback	Automatic Input switching - When the connected equipment is operated, input mode is switched automatically. When it is stopped operating, input mode is not returned.
Power on link	Set Power on Link “Set” in Setup Menu to use this function → “Power on Link” (p. 22 - 23, 25) When the connected equipment starts playback or direct navigator / function menu for the equipment are activated, the TV is automatically turned on. (Only when TV is in Standby mode.)
Power off link	Set Power off Link “Set” in Setup Menu to use this function → “Power off Link” (p. 22 - 23, 25) When TV is set to Standby mode, the connected equipment is also automatically set to Standby. <ul style="list-style-type: none"> ● This function will work even if the TV enters standby mode automatically by Off Timer function or auto power standby function.

- The TV remains on even if the “VIERA Link” compatible equipment is turned off.

■ Features available (Using VIERA Link Menu)

You can pause the live TV programme and resume later.

- This function is available with DIGA Recorder which has HDD and "HDAVI Control 3" function.
- If you cannot operate, check the settings and the equipment → "Preparations" (p. 38)
- Available conditions:
 - when watching TV programme
 - when watching the input from DIGA Recorder

Access and pause the live TV programme

Pause Live TV programme
(HDAVI Control 3 and Recorder with HDD)
Pause Live TV



① Display "VIERA Link Menu"



② Select "Pause Live TV" and pause

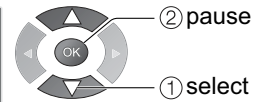
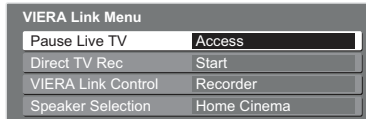

- Live TV programme is recorded on HDD from where it was paused.

■ **To resume (stop pause)**

Select "Pause Live TV" and access

- About the operations after resuming, read the manual of the equipment.

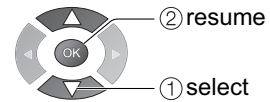

■ **To return to Live TV**

(cancel pause or resumed playback)

→ TV (change the input mode)

- If you cancel pause or resumed playback, the recorded programme will be deleted from HDD.

Recording the current programme in DIGA Recorder immediately.

- This function is available with DIGA Recorder which has "HDAVI Control 3" function.
- If you cannot operate, check the settings and the equipment → "Preparations" (p. 38)
- Available conditions:
 - when watching TV programme
- The recording is performed by using the tuner of DIGA Recorder. Changing programme, input mode or turning off the TV is available during the recording.

Direct TV Recording -
What you see is What you record
(HDAVI Control 3)
Direct TV Rec



① Display "VIERA Link Menu"



② Select "Direct TV Rec" and start recording

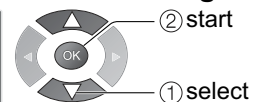

■ **To stop recording**

Select "Stop" in "Direct TV Rec" and access

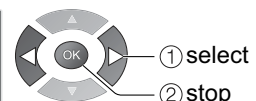

VIERA Link “HDAVI Control™”

■ Features available (Using VIERA Link Menu)

You can control some functions of the connected equipment with this TV remote control (point the remote control at the TV’s signal receiver).

- This function is available with the equipment which has “HDAVI Control 2” or “HDAVI Control 3” function.
- If you cannot operate, check the settings and the equipment → “Preparations” (p. 38)

Access and operate the menu of the equipment



① Display “VIERA Link Menu”



② Select “VIERA Link Control”

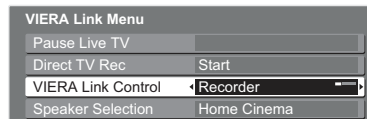

③ Select the equipment you want to access

- “Home Cinema” means Player theatre, Recorder theatre and Amplifier.

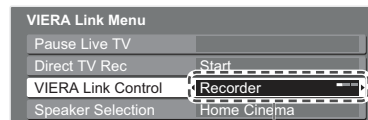

Recorder / Player / Home Cinema / Video Camera

The type of the connected equipment is displayed.

Select the type of the equipment and access.

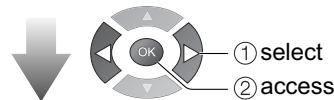

The menu of the accessed equipment
(Input mode will be changed automatically)

④ Operate the menu of the equipment

- Available VIERA remote control buttons (depending on the connected equipment):

	Move the cursor / select the menu
	Move the cursor / access / adjust
	Store / set / access
	Return to the previous menu
	Exit the menu
	Display the operation guide for the equipment / The same functions with the OPTION button of the equipment
	Access when the key words are displayed on colour bar

- About the operations for the equipment, read the manual of the equipment.

Control the menu of the connected equipment by VIERA remote control

(HDAVI Control 2)
(HDAVI Control 3)

VIERA Link Control

■ If you access the invalid equipment

When the equipment with “HDAVI Control” function is connected

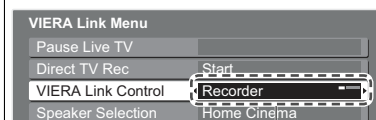

Recorder / Player / Home Cinema / Video Camera

The type of the connected equipment is displayed. But you cannot access it. Use its own remote control to operate the equipment.

When the equipment of other types or manufacturers is connected

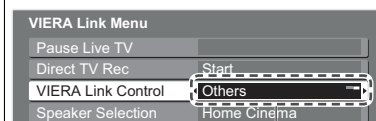

Others

“Others” is displayed. You cannot access it. Use its own remote control to operate the equipment.

■ Features available (Using VIERA Link Menu)

You can control the theatre speaker with this TV remote control (point the remote control at the TV's signal receiver).

- This function is available with the Amplifier or Player theatre which has "HDAVI Control" function.
- If you cannot operate, check the settings and the equipment → "Preparations" (p. 38)

Access and control the speaker volume

Speaker control

Speaker Selection

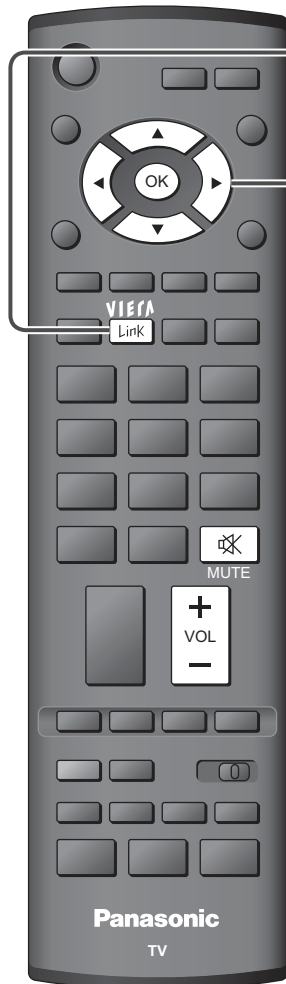

① Display "VIERA Link Menu"



② Select "Speaker Selection"

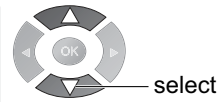
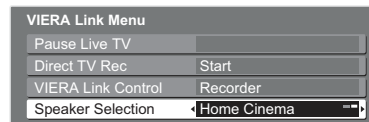

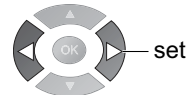

③ Set to "Home Cinema" or "TV"



■ Home Cinema

Amplifier or Player theatre will be automatically turned on if it is in Standby mode and the sound is from theatre speakers connected to the equipment.

- Volume up / down → 
- Mute → 
- The sound of TV speakers is mute.
- When the equipment is turned off, TV speakers will be active.

■ TV

TV speakers are active.

Note

- This function may not work properly depending on the connected equipment.
- Image or sound may not be available for the first few seconds when the playback starts.
- Image or sound may not be available for the first few seconds when Input mode is switched.
- Volume function will be displayed when adjusting the volume of the equipment.
- Easy playback is also available by using the remote control for Amplifier or Player theatre. Read the manual of the equipment.
- About HDMI cable for connecting Panasonic HD Video Camera, read the manual of the equipment.
- If more than one equipment of the same type are connected to the TV by HDMI cables, for example two DIGA Recorders to HDMI1 and HDMI2, VIERA Link will only be available for the lower terminal number, in this case HDMI1.
- "HDAVI Control 3" is the newest standard (current as of December, 2007) for HDAVI Control compatible equipment. This standard is compatible with conventional HDAVI equipment.
- To confirm this TV's version of HDAVI Control → "System Information" (p. 25)

External Equipment

These diagrams show our recommendations for how to connect the TV to your various equipment. For other connections, consult the instructions for each piece of equipment, the table below, and the specifications (p. 50).

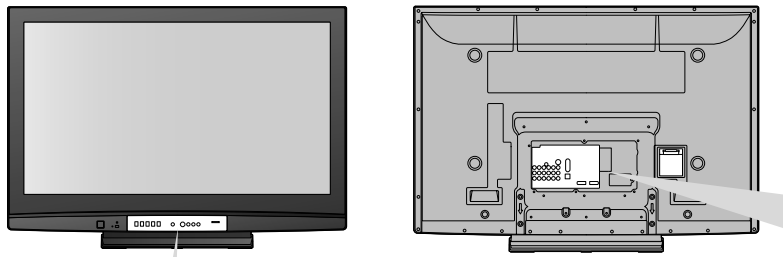

Camcorder / Game equipment

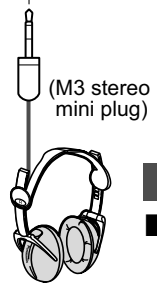
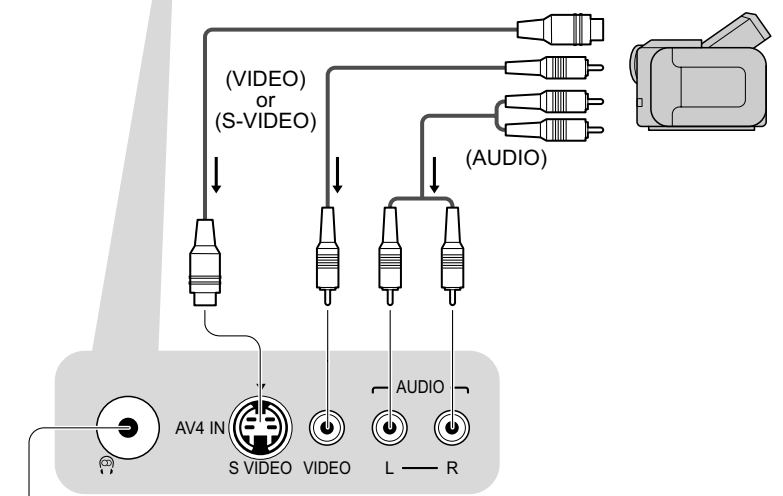

Headphones

- To adjust volume
 - ➔ "Headphone Volume" in the Sound Menu (p. 24)

To listen with speakers

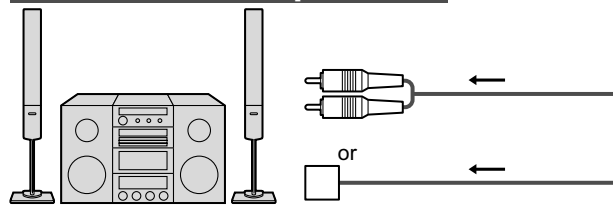

Amplifier with speaker system

Types of connectable equipment to each terminal

Terminal	AV1 IN	AV2 IN	AV3 IN	AV4 IN (Front of TV)
Recording / Playback (equipment)	VIDEO L Y AUDIO L R	VIDEO L Y AUDIO L R	S VIDEO VIDEO L AUDIO R	S VIDEO VIDEO L R
To record / playback videocassettes / DVDs (VCR / DVD recorder)	○	○	○	○
To watch DVDs (DVD player)	○	○	○	○
To watch camcorder images (Video camera)	○	○	○	○
To watch satellite broadcasts (Set top box)	○	○	○	○
To play games (Game equipment)	○	○	○	○
To use amplifier with speaker system				
VIERA Link				

○: Recommended Connection

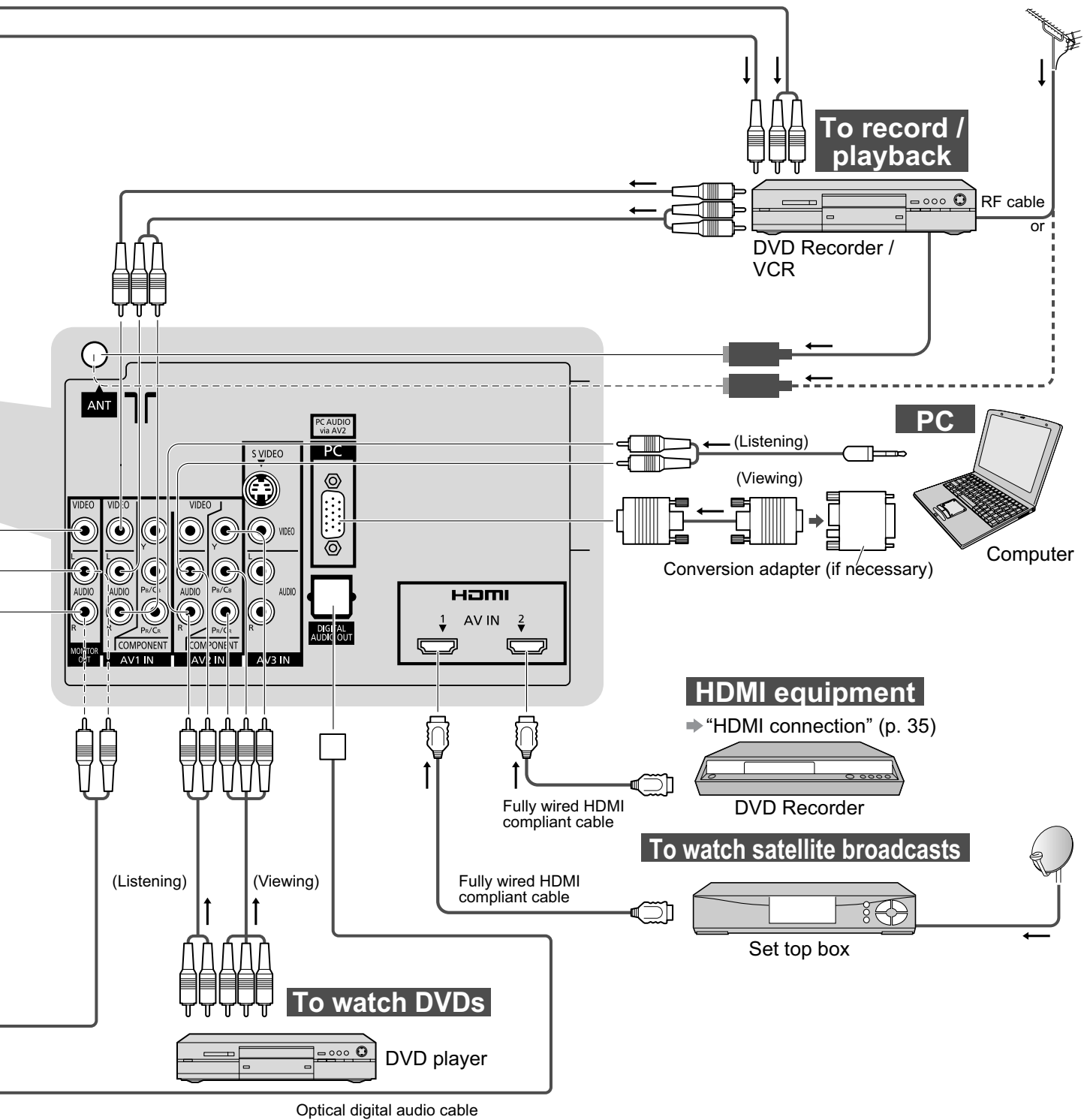

MONITOR OUT	DIGITAL AUDIO OUT	HDMI	
		1	2
VIDEO			
L			
AUDIO			
R			

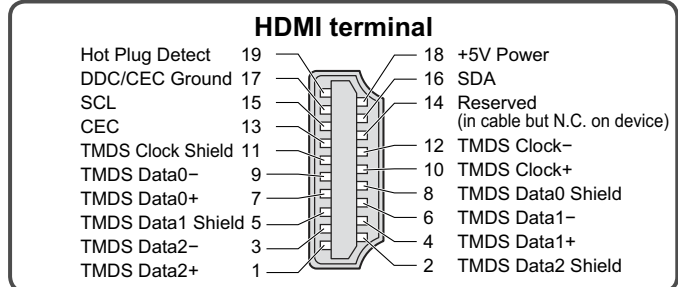
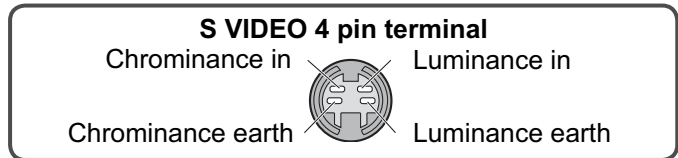

- Connect the S VIDEO or VIDEO terminal when using AV3 / AV4 IN terminals.
- Connect the COMPONENT or VIDEO terminal when using AV1 / AV2 IN terminals.

Technical Information

Programme Allocation (Analogue mode)

CH Display / Receive Programme	CH Display / Receive Programme	CH Display / Receive Programme
CH 0 } CH 5	S 6 } S 10	CH 10 } CH 12
S 2 } S 5	CH 6 } CH 9	S 11 } S 44
CH 5A	CH 9A	CH 20 } CH 75

Rating (DVB mode)

Rating	Meaning	Rating	Meaning
-	Not classified	M	Mature
P	Pre school	MA 15+	Mature Adult 15+
C	Children	AV 15+	Adult strong Violence 15+
G	General	R	Restricted 18+
PG	Parental Guidance recommended		

Updating the software system (DVB mode)

Update system software to ensure that you have latest version software.

If there is an update available, a notification banner is displayed when the service has the update information.

- To download new software, press "OK" → Downloading (approx. 20 mins.)
If you choose not to download, press "EXIT".

■ To update automatically

Set "Auto Update Search in Standby" to "On" (p. 27)

If there is a new version software being broadcast, the TV will download this automatically.

- The automatic updating sequence is carried out at 3:00 AM and 5:00 AM every morning under the following condition.
Standby (TV turned Off with the remote control)

■ To update manually

Perform "System Update Search Now" (p. 27)

If there is an update available, a notification banner is displayed.

- To download new software, press "OK" → Downloading (approx. 20 mins.)
If you choose not to download, press "EXIT".

Note

- During downloading, do not turn Off the TV or touch any buttons.
(The TV is automatically activated after downloading is completed.)
- When the TV is switched to standby, there will be a clicking sound after a short delay. Similar clicking sounds will also occur at 3:00 AM and 5:00 AM when "Auto update Search in Standby" (p. 27) is set to "On". These sounds are normal.

Data format for Card browsing

- Photo : Still images recorded with digital still cameras compatible with JPEG files of DCF* and EXIF standards
- Data format : Baseline JPEG (Sub-sampling 4:4:4, 4:2:2 or 4:2:0)
- Max. number of files : 9,999
- Image resolution : 160 × 120 to 10,000,000
- Transfer rate : 1.6 MB/Sec
- Compliant card type (maximum capacity): SDHC Card (16 GB), SD Card (2 GB), Multi Media Card (128 MB), miniSD Card (1 GB) (requiring miniSD adapter)
 - If miniSD Card is used, insert / remove it together with the adapter.
 - Check the latest information on the card type at the following website. (English only)
<http://panasonic.co.jp/pavc/global/cs/>
- *DCF (Design rule for camera file system): Unified standard established by Japan Electronics and Information Technology Industries Association (JEITA).

Note

- A JPEG image modified with a PC may not be displayed.
- Images imported from a PC must be compatible with EXIF (Exchangeable Image File) 2.0, 2.1, and 2.2.
- Partly degraded files might be displayed at a reduced resolution.
- Only “.JPG” extension can be read by this TV.
- The folder and file names may be different depending on the digital camera used.
- Do not use two-byte characters or other special codes.
- The card may become unusable with this TV if the file or folder names are changed.

Stereo / Bilingual Sound Selection (Analogue mode)

When you receive the stereo / bilingual sound system, sound output modes can be selected by “MPX” in the Sound Menu (p. 24).

Audio Signal	STEREO	MAIN I	SUB II	MONO
Mode Indicator	∞	I	II	▽

NICAMUsed in New Zealand, Singapore, Hong Kong etc.

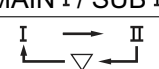
Type of broadcast	Regular broadcast (Standard Audio)	Regular + NICAM MONO I (MAIN I)	NICAM STEREO	NICAM DUAL MONO (MAIN I / SUB II)
Mode Indicator	No Indicator ↔ ▽	I ↔ ▽	∞ ↔ ▽	

A2(German)Used in Australia, Malaysia etc.

Type of broadcast	Regular broadcast (Standard Audio)	BILINGUAL or DUAL MONO: MAIN I / SUB II	STEREO
Mode Indicator	No Indicator ↔ ▽	I ↔ II	∞ ↔ ▽

Note

- If the stereo signal is poor or the receiving conditions are not optimum or if STEREO:MONO automatic switching occurs, it is recommended you switch from STEREO to MONO.
- Even when the contents of the receiving signal undergo changes, selection mode is kept intact.
- When the receiving conditions deteriorate, listening will be easier if the mode is set to the MONO position.
- DUAL, also known as DUAL MONO or as BILINGUAL is not currently transmitted in some countries.

Technical Information

PC connection

A PC may be connected to this TV so that the PC screen is displayed and sound is heard from the TV.

- PC signals that can be inputted: Horizontal scanning frequency 31 to 69 kHz; vertical scanning frequency 59 to 86 Hz (more than 1,024 signal lines could result in incorrect display of the image).
- A PC adapter is not necessary for the DOS/V-compliant D-sub 15-pin connector.

Note

- Some PC models cannot be connected to this TV.
- When using PC, set the colour display quality of PC to the highest position.
- For details of the applicable PC signals, see below.
- Max. display resolution

Aspect	4:3	1,440 × 1,080 pixels
	16:9	1,920 × 1,080 pixels

- D-sub 15-pin connector signal

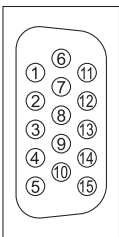

Pin No.	Signal Name	Pin No.	Signal Name	Pin No.	Signal Name
①	R	⑥	GND (Ground)	⑪	NC (not connected)
②	G	⑦	GND (Ground)	⑫	NC (not connected)
③	B	⑧	GND (Ground)	⑬	HD
④	NC (not connected)	⑨	NC (not connected)	⑭	VD
⑤	GND (Ground)	⑩	GND (Ground)	⑮	NC (not connected)

Input signal that can be displayed

COMPONENT (Y, P_B/C_B, P_R/C_R), HDMI

* Mark: Applicable input signal

Signal name	COMPONENT	HDMI
480i (60 Hz)	*	*
480p (60 Hz)	*	*
576i (50 Hz)	*	*
576p (50 Hz)	*	*
720p (60 Hz)	*	*
720p (50 Hz)	*	*
1,080i (60 Hz)	*	*
1,080i (50 Hz)	*	*
1,080p (60 Hz)		*
1,080p (50 Hz)		*
1,080p (24 Hz)		*

PC (D-sub 15P)

Signal name	Horizontal frequency (kHz)	Vertical frequency (Hz)
640 × 400 @70 Hz	31.47	70.07
640 × 480 @60 Hz	31.47	59.94
640 × 480 @75 Hz	37.50	75.00
800 × 600 @60 Hz	37.88	60.32
800 × 600 @75 Hz	46.88	75.00
800 × 600 @85 Hz	53.67	85.06
852 × 480 @60 Hz	31.44	59.89
1,024 × 768 @60 Hz	48.36	60.00
1,024 × 768 @70 Hz	56.48	70.07
1,024 × 768 @75 Hz	60.02	75.03
1,024 × 768 @85 Hz	68.68	85.00
1,280 × 1,024 @60 Hz	63.98	60.02
1,366 × 768 @60 Hz	48.39	60.04
Macintosh13" (640 × 480)	35.00	66.67
Macintosh16" (832 × 624)	49.73	74.55
Macintosh21" (1,152 × 870)	68.68	75.06

Note

- Signals other than above may not be displayed properly.
- The above signals are reformatted for optimal viewing on your display.
- Applicable input signal for PC is basically compatible to VESA standard timing.
- PC signal is magnified or compressed for display, so that it may not be possible to show fine detail with sufficient clarity.

FAQs

Before requesting service or assistance, please follow these simple guides to resolve the problem. If the problem still persists, please contact your local Panasonic dealer for assistance.

White spots or shadow images (noise)

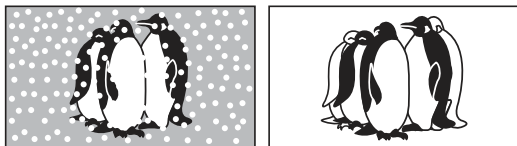

- Check the position, direction, and connection of the aerial.

Neither image nor sound is produced

- Is the TV in "AV mode"?
- Is the mains lead plugged into the socket outlet?
- Is the TV turned On?
- Check Picture Menu (p. 24) and volume.

An error message appears

- Follow the message's instructions.
- If the problem persists, contact the authorized Service Centre.

"VIERA Link" function does not work and an error message appears

- Confirm the connection.
- Turn the connected equipment on and then switch the TV on. (p. 38)

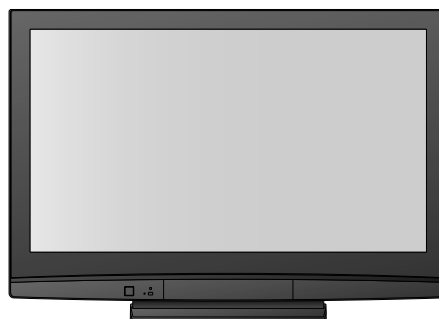

Contrast is reduced

- Contrast is lowered in the following conditions without any user operation for a few minutes:
 - no signal in DVB or AV mode
 - selected invalid programme
 - selected radio service
 - displayed menu
 - Thumbnail or still picture in SD Card mode

Pixel Statement

- An image on a LCD or Plasma TV screen is created by many small groups of dots known as pixels (which is similar to the image in a newspaper). It also naturally follows that higher panel resolutions contain more pixels. To create a colour image, each pixel consists of three tiny coloured dots (known as sub-pixels), one each of red, green and blue. Each one of these dots is precisely controlled by the electronics of the TV to produce the picture. Whilst Panasonic maintains the highest standards in manufacturing technology and processes in the construction of these panels, there are a number of allowable pixel/sub-pixel failures that still allow the panel to be defined as a good panel. It is not possible to guarantee absolutely no pixel loss.

	Problem	Actions
Screen	Chaotic image, noisy	<ul style="list-style-type: none"> ● Set "P-NR" in the Picture Menu (to remove noise). (p. 24) ● Check nearby electrical products (car, motorcycle, fluorescent lamp).
	No image can be displayed	<ul style="list-style-type: none"> ● Is "Colour" or "Contrast" in the Picture Menu set to the minimum? (p. 24)
	Blurry or distorted image (no sound or low volume)	<ul style="list-style-type: none"> ● Reset programme. (p. 31)
	Unusual image is displayed	<ul style="list-style-type: none"> ● Turn off the TV with Mains power On / Off switch, then turn it on again.
	"Shop" appears on screen at switch on	<ul style="list-style-type: none"> ● "Shop" was selected in "Auto Tuning" (p. 12). Reset settings in "Shipping Condition" (p. 32), then select "Home" in "Auto Tuning" (p. 12).
Sound	No sound is produced	<ul style="list-style-type: none"> ● Is "Sound mute" active? (p. 11) ● Is the volume set to the minimum?
	Sound level is low or sound is distorted	<ul style="list-style-type: none"> ● Sound signal reception may be deteriorated. ● Set "MPX" (p. 24) in the Sound Menu to "Mono".

FAQs

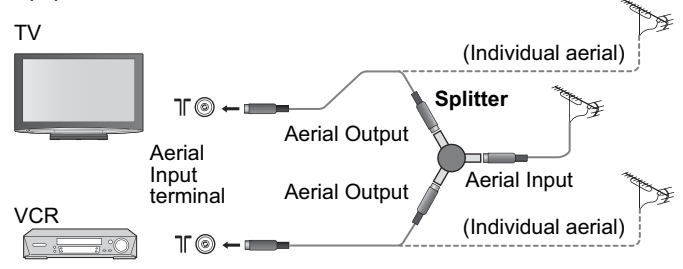
	Problem	Actions
HDMI	Sound is unusual	<ul style="list-style-type: none"> ● Set the sound setting of the connected equipment to "2ch L.PCM". ● Check the "HDMI1 Input" setting in the Sound Menu. (p. 24) ● If digital sound connection has a problem, select analogue sound connection. (p. 35)
	Pictures from external equipment are unusual when the equipment is connected via HDMI	<ul style="list-style-type: none"> ● Is the HDMI cable connected properly? (p. 42) ● Turn Off the TV and equipment, then turn them On again. ● Check an input signal from the equipment. (p. 46) ● Use an equipment compliant with EIA/CEA-861/861B.
	<ul style="list-style-type: none"> ● Digital TV reception technology requires high quality, robust DTV signals which in some domestic aerial installations, may be relatively poor despite good analogue reception. 	
DVB	Aerial connection when using DTV and VCR / DVD Recorder	<ul style="list-style-type: none"> ● To maintain optimum signal quality from TV aerial, use a TV aerial splitter (as illustrated) when connecting two or more equipments to the same aerial. 
	After DVB Auto Tuning only some or no DVB services are found	<ul style="list-style-type: none"> ● Check to ensure your area is covered by DVB transmissions. ● Check that the aerial and antenna cable are designed for DVB. For your safety, the aerial and cable should be inspected / installed by a licenced installer that should comply with Australian Standard AS1417.1. Note: If you live within 5-10 Km of DVB transmission towers, a combined VHF / UHF aerial should be adequate. Outside this area, separate VHF and UHF aerials provide superior reception performance. ● If you live in a unit or apartment, check to ensure the Master Antenna TV (MATV) system is designed for analogue and DVB-T reception. Please consult your body corporate.
	Picture regularly breaks up on some programmes, or "No Signal" message	<ul style="list-style-type: none"> ● Check "Signal Display". (p. 31) If "Signal Quality" or "Signal Strength" are displayed in red or constantly changing, check aerial. If problem persists consult your local TV aerial installer. ● Check that the aerial and antenna cable are designed for DVB. For your safety, the aerial and cable should be inspected / installed by a licenced installer that should comply with Australian Standard AS1417.1. ● Interference (known as impulse noise) from household appliances such as light switches, fridges etc may cause picture break up and / or audio distortion. Use high quality quad shielded coaxial cable fly lead between TV and antenna wall socket to minimise impulse noise pickup. If problem persists consult your local TV aerial installer. ● When "No Signal" message is displayed check TV aerial connection. ● The received signal may be too weak to allow the TV to reliably lock to the desired "No Signal" programme to generate a stable picture. Repeat the tuning procedure (p. 31). If problem persists consult your local TV aerial installer.
	Picture very infrequently breaks up on some or all programmes	<ul style="list-style-type: none"> ● Electrical atmospheric interference caused by local or distant lighting storms or heavy rain with wind in "leafy" locations may cause pictures to break up and audio to mute or distort momentarily. ● Impulse noise interference from an infrequently used electrical appliance, or a passing vehicle or lawn mower with a "noisy" ignition system.

	Problem	Actions
Other	TV takes so long to turn on	<ul style="list-style-type: none"> ● Like your computer, the TV has to run a number of diagnostic and software checks before it can display any programmes.
	The programme cannot be changed	<ul style="list-style-type: none"> ● Is the TV in Teletext mode? (p. 18)
	The programme cannot be selected	<ul style="list-style-type: none"> ● Is the programme skipped? (p. 29)
	TV goes into "Standby mode"	<ul style="list-style-type: none"> ● Off Timer function is activated. (p. 25) ● The TV enters "Standby mode" about 30 mins. after analogue broadcasting ends.
	The remote control does not work	<ul style="list-style-type: none"> ● Are the batteries installed correctly? (p. 6) ● Has the TV been switched On?

Licence

- DVB is a trademark of the DVB Digital Video Broadcasting Project (1991 to 1996).
- VGA is a trademark of International Business Machines Corporation.
- Macintosh is a registered trademark of Apple Inc., USA.
- S-VGA is a registered trademark of the Video Electronics Standard Association.
Even if no special notation has been made of company or product trademarks, these trademarks have been fully respected.
- SDHC Logo is a trademark.
- HDMI, the HDMI Logo and High-Definition Multimedia Interface are trademarks or registered trademarks of HDMI Licensing LLC.
- HDAVI Control™ is a trademark of Panasonic Corporation.
- Manufactured under license from Dolby Laboratories.
Dolby and the double-D symbol are trademarks of Dolby Laboratories.



Trade Mark of the DVB Digital Video Broadcasting Project (1991 to 1996)
TH-42PZ80A Declaration of Conformity No. 5726, 18 June 2008
TH-50PZ80A Declaration of Conformity No. 5725, 18 June 2008

Maintenance

First, remove the mains plug from the socket outlet.

Display panel

Regular care: Gently wipe the surface clean of dirt by using a soft cloth.

Major contamination: Wipe the surface clean using a soft cloth dampened with clean water or diluted neutral detergent (1 part detergent to 100 parts water). Then, using a soft dry cloth, evenly wipe the surface clean until it is dry.

Caution

- The surface of the display panel has been specially treated and may be easily damaged.
Do not tap or scratch the surface with your fingernail or other hard object.
- Take care not to subject the surface to insect repellent, solvent, thinner, or other volatile substances (this may degrade surface quality).

Cabinet, Pedestal

Regular care: Wipe the surface clean using a soft dry cloth.

Major contamination: Dampen a soft cloth with clean water or water containing a small amount of neutral detergent. Then, wring the cloth and wipe the surface clean with it. Finally, wipe the surface clean with a dry cloth.

Caution

- Take care not to subject the TV's surfaces to detergent. (A liquid inside the TV could lead to product failure.)
- Take care not to subject surfaces to insect repellent, solvent, thinner, or other volatile substances (this may deteriorate the surface by peeling the paint).
- Do not allow the cabinet and pedestal to make contact with a rubber or PVC substance for a long time.

Mains plug

Wipe the mains plug with a dry cloth at regular intervals. (Moisture and dust may lead to fire or electrical shock.)

Specifications

		TH-42PZ80A	TH-50PZ80A
Power Source		AC 220-240 V, 50 / 60 Hz	
Power Consumption	Power rating	475 W	555 W
	Standby condition	0.4 W	
Display panel	Aspect Ratio	16:9	
	Visible screen size	106 cm (diagonal)	127 cm (diagonal)
		922 mm (W) × 518 mm (H)	1,106 mm (W) × 622 mm (H)
Number of pixels	2,073,600 (1,920 (W) × 1,080 (H)) [5,760 × 1,080 dots]		
Sound	Speaker	160 mm × 42 mm × 2 pcs, 8 Ω	
	Audio Output	20 W (10 W + 10 W), 10% THD	
	Headphones	M3 (3.5 mm) stereo mini Jack × 1	
PC signals		VGA, SVGA, XGA, SXGA Horizontal scanning frequency 31 - 69 kHz Vertical scanning frequency 59 - 86 Hz	
Receiving Systems / Band name		PAL B/G Reception of Off air broadcasts DVB-T 7 MHz VHF / UHF (Australia) free-to-air TV broadcast reception PAL 60 Hz Playback of NTSC tape from some PAL Video recorders (VCR) M.NTSC Playback from M. NTSC Video recorders (VCR) NTSC Playback from NTSC Video recorders (VCR)	
Aerial - Rear		Standard Belling & Lee connector	
Operating Conditions		Temperature : 0 °C - 35 °C Humidity : 20 % - 80 % RH (non-condensing)	
Connection Terminals	AV1 Input	AUDIO L - R	RCA PIN Type × 2 0.5 V[rms]
		VIDEO	RCA PIN Type × 1 1.0 V[p-p] (75 Ω)
		COMPONENT	Y P _B /C _B , P _R /C _R 1.0 V[p-p] (including synchronization) ±0.35 V[p-p]
	AV2 Input	AUDIO L - R	RCA PIN Type × 2 0.5 V[rms]
		VIDEO	RCA PIN Type × 1 1.0 V[p-p] (75 Ω)
		COMPONENT	Y P _B /C _B , P _R /C _R 1.0 V[p-p] (including synchronization) ±0.35 V[p-p]
	AV3 Input	AUDIO L - R	RCA PIN Type × 2 0.5 V[rms]
		VIDEO	RCA PIN Type × 1 1.0 V[p-p] (75 Ω)
		S VIDEO	Mini DIN 4-pin Y:1.0 V[p-p] (75 Ω) C:0.286 V[p-p] (75 Ω)
	AV4 Input	AUDIO L - R	RCA PIN Type × 2 0.5 V[rms]
		VIDEO	RCA PIN Type × 1 1.0 V[p-p] (75 Ω)
		S VIDEO	Mini DIN 4-pin Y:1.0 V[p-p] (75 Ω) C:0.286 V[p-p] (75 Ω)
	Monitor Output	AUDIO L - R	RCA PIN Type × 2 0.5 V[rms] (high impedance)
		VIDEO	RCA PIN Type × 1 1.0 V[p-p] (75 Ω)
	Others	HDMI1 / 2 Input	TYPE A Connectors ● This TV supports "HDAVI Control 3" function.
		PC Input	HIGH-DENSITY D-SUB 15PIN R, G, B/0.7 V[p-p] (75 Ω) HD, VD/TTL Level 2.0 - 5.0 V[p-p] (high impedance) (PC AUDIO via AV2 Input Audio L-R)
DIGITAL AUDIO OUT Card slot		PCM / Dolby Digital, Fiber optic SD Card slot × 1	
Dimensions (W × H × D)		1,020 mm × 727 mm × 327 mm (With Pedestal) 1,020 mm × 679 mm × 95 mm (TV only)	1,210 mm × 844 mm × 387 mm (With Pedestal) 1,210 mm × 790.5 mm × 95 mm (TV only)
Mass		31.5 kg Net (With Pedestal) 29.5 kg Net (TV only)	40.0 kg Net (With Pedestal) 38.0 kg Net (TV only)

Note

- Design and Specifications are subject to change without notice. Mass and Dimensions shown are approximate.
- Pedestal: ST-42R4-WG / ST-50R4-WG (For safety approval)

WARRANTY - Australia only

1. The product is warranted for 12 months from the date of purchase. Subject to the conditions of this warranty Panasonic or its Authorised Service Centre will perform necessary service on the product without charge for parts or labour if, in the opinion of Panasonic, the product is found to be faulty within the warranty period.
2. This warranty only applies to Panasonic products purchased in Australia and sold by Panasonic Australia or its Authorised Distributors or Dealers and only where the products are used and serviced within Australia or its territories. Warranty cover only applies to service carried out by a Panasonic Authorised Service Centre and only if valid proof of purchase is presented when warranty service is requested.
3. This warranty only applies if the product has been installed and used in accordance with the manufacturer's recommendations (as noted in the operating instructions) under normal use and reasonable care (in the opinion of Panasonic). The warranty covers normal domestic use only and does not cover damage, malfunction or failure resulting from use of incorrect voltages, incorrect installation, accident, misuse, neglect, build-up of dirt or dust, abuse, maladjustment of customer controls, mains supply problems, thunderstorm activity, infestation by insects or vermin, tampering or repair by unauthorised persons (including unauthorised alterations), exposure to abnormally corrosive conditions or any foreign object or matter having entered the product.
4. This warranty does not cover the following items unless the fault or defect existed at the time of purchase:

(a) Video or Audio Tapes	(d) Cabinet Parts	(g) Microwave Oven cook plates.
(b) Video or Audio Heads and Stylis resulting from wear and tear in normal use	(e) User replaceable Batteries	(h) Kneader mounting shaft unit (bread bakery)
(c) Shaver Heads or Cutters	(f) Thermal Paper, Toner/Ink Cartridges, Drums, Developer, Film (Ink/Ribbon), Film Cartridge, Printer Heads	
5. If warranty service is required you should:
 - Telephone Panasonic's Customer Care Centre on 132600 or visit our website and use the Service Centre Locator for the name/address of the nearest Authorised Service Centre.
 - Send or bring the product to a Panasonic Authorised Service Centre together with your proof of purchase receipt as a proof of purchase date. Please note that freight and insurance to and / or from your nearest Authorised Service Centre must be arranged by you.
 - Note that home or pick-up/delivery service is available for the following products in the major metropolitan areas of Australia or the normal operating areas of the nearest Authorised Service Centres:

(a) Picture tube (CRT) based Television Receivers (screen sizes greater than 66cm); Rear Projection TV's; Plasma/LCD televisions / displays (screen size greater than 103 cm)	(b) Convection/Combination Microwave Ovens
	(c) Whiteboard (except portable type)
6. The warranties hereby conferred do not extend to, and exclude, any costs associated with the installation, de-installation or re-installation of a product, including costs related to the mounting, de-mounting or remounting of any screen, (and any other ancillary activities), delivery, handling, freighting, transportation or insurance of the product or any part thereof or replacement of and do not extend to, and exclude, any damage or loss occurring by reason of, during, associated with, or related to such installation, de-installation, re-installation or transit.

Panasonic Authorised Service Centres are located in major metropolitan areas and most regional centres of Australia, however, coverage will vary dependant on product. For advice on exact Authorised Service Centre locations for your product, please telephone our Customer Care Centre on 132600 or visit our website and use the Service Centre Locator.

Unless otherwise specified to the consumer the benefits conferred by this express warranty are additional to all other conditions, warranties, guarantees, rights and remedies expressed or implied by the *Trade Practices Act 1974* and similar consumer protection provisions contained in legislation of the States and Territories and all other obligations and liabilities on the part of the manufacturer or supplier and nothing contained herein shall restrict or modify such rights, remedies, obligations or liabilities.

November 2005

THIS WARRANTY CARD AND THE PURCHASE DOCKET (OR SIMILAR PROOF OF PURCHASE) SHOULD BE RETAINED BY THE CUSTOMER AT ALL TIMES

If you require assistance regarding warranty conditions or any other enquiries, please visit the **Panasonic Australia website **www.panasonic.com.au** or by phone on 132 600**
If phoning in, please ensure you have your operating instructions available.

Panasonic Australia Pty. Limited

ACN 001 592 187 ABN 83 001 592 187

Locked Bag 505, Frenchs Forest, NSW 2086
www.panasonic.com.au

PRO-031-F01 Issue: 3.0

23-11-2005

Customer's Record

The model number and serial number of this product may be found on its rear panel. You should note this serial number in the space provided below and retain this book, plus your purchase receipt, as a permanent record of your purchase to aid in identification in the event of theft or loss, and for Warranty Service purposes.

Model Number _____

Serial Number _____

Panasonic Corporation

Web Site: <http://panasonic.net/>

© Panasonic Corporation 2008

Printed in China