

Operating Manual

PistenBully 200

From WKU 5 823 MA 5 L 010839

For WKU

EN



PistenBully®



KÄSSBOHRER GELÄNDEFahrZEUG AG

Kässbohrer Geländefahrzeug AG
Kässbohrerstraße 11
D-88471 Laupheim

CALIFORNIA _____

Proposition 65 Warning _____

Diesel engine exhaust and some of its constituents are known _____

to the State of California to cause cancer, birth defects, and _____

other reproductive harm. _____

Printed in Germany

Copyright ©

Not to be reprinted, translated or duplicated either wholly or in part without written permission.

Technical details might not necessarily be exactly as described or illustrated in this operating manual.

Printed on environmentally compatible paper (bleached without chlorine, recyclable).

INTRODUCTION TO THE OPERATING MANUAL

00	INTRODUCTION TO THE OPERATING MANUAL	3
	– Safety symbols used	8
01	TECHNICAL AFTER-SALES SERVICE AND SPARES DEPARTEMENT	9
02	VEHICLE AND ENGINE NUMBER.	10
03	USE OF GENUINE PARTS	11
04	SAFETY SPECIFICATION FOR:	
	– Operation	12
	– Driver	12
	– Danger area	13
	– Driving	13
	– Operation under unusual conditions	15

	– Driving with people	16
	– Maintenance	16
	– Monitoring	17
	– Inspection	17
	– First-aid box	18
	– Fire extinguisher	18
	– Warning plates	19

10	PRE-DRIVING PREPARATION/ DAILY INSPECTION WORK	25
-----------	---	----

11	PRE-DRIVING PREPARATION/ WEEKLY INSPECTION WORK	31
-----------	--	----

13	FLUIDS AND LUBRICANTS.	35
	– Diesel fuel	35
	– Coolant	35
	– Fluids and lubricants table	37

DRIVER'S CAB

20	DRIVER'S CAB	39
	– Overview	39
	– Driver's seat	56
21	ELECTRICAL SYSTEM	59
	– Fuses	59
	– Emergency actuation of appliance hydraulics	62
	– Vehicle battery	65
	– Jump-starting kit	64
	– Battery isolator	65
	– Lighting	65
22	ACTUATION OF DRIVE HYDRAULICS – AUXILIARY EQUIPMENT	69
23	ACTUATION OF FRONT / REAR AUXILIARY HYDRAULICS	71

24	FUN PARK/ JOY STICK	74
25	TILTING LOAD BRIDGE OF DRIVER'S CAB.	85
	– Electrical	91
26	EMERGENCY STOP	90
	-- Towing away / towing hitch	91
27	TECHNICAL DATA	92
28	PERMISSIBLE WEIGHT RANGE OF FRONT ATTACHMENTS	94

DRIVING – BRAKING – STOPPING

30	DIESEL ENGINE	97
	– Starting engine	98
	– Adjusting air intake	98
	– Warming-up phase	98
	– Most fuel-efficient engine speed range.	99
31	DRIVING – BRAKING – STOPPING	101
32	ENDING JOURNEY	105
33	DRIVING TIPS AND NOTES ON ECONOMIC DRIVING AND ENVIRONMENT-FRIENDLY USE	107
	– Overview of economic driving	107
	– Medium snow	108
	– Conversion table % in \sphericalangle °	111
	– Gradeability	111
	– Driving with Pisten Bully	113

DRIVE ELECTRONICS

40	FAULT IN DRIVE ELECTRONICS – EMERGENCY SWITCH	115
42	DIGITAL DRIVING AND ROTARY PLOUGH ELECTRONICS	116

AUXILIARY EQUIPMENT

50	FITTING/CONNECTING UP AUXILIARY EQUIPMENT	116
51	PISTE PREPARATION	119
52	SCRAPER PLATE / PARKBLADE	121
53	REAR-MOUNTED ATTACHMENT/SMOOTHER	124

54 ROTARY SNOW PLOUGH 2000 126

55 MULTIFLEX ROTARY SNOW PLOUGH 128

ACCOMPANYING DOCUMENTS:

- Driver's log book
- Fluids and Lubricants Specifications
- Maintenance manual
- Operating Manual for Kahlbacher front-mounted rotary snow plough (special equipment).
- Operating Manual for capstan winch (special equipment).

**YOUR OPINION IS IMPORTANT
TO US!**

To ensure that you always receive
the best possible operating Manual.

Sender:

.....

Tel:

Fax:

To:

Kässbohrer Geländefahrzeug AG

Kässbohrerstraße 11

D-88471 Laupheim

For the attention of. Mr. Peter Görlich

Fax no.: 07392/900122

E-mail: peter.goerlich @ pistonbully.com

Quality of translation:

Correctly translated

Translation containing errors

Comments:

.....

.....

.....

Diagrams and photos:

Provide good explanations

Diagrams with better explanations required

Comments:

.....

A CD-ROM would be good!

This operating manual provides information about:

- how to handle, maintain and care for your Pisten Bully.
- important instructions concerning correct and economical operation.
- warnings so that you recognise dangers in good time and avoid them.



Make sure that the operating manual is always in the oddments tray in the driver's cab.

ABBREVIATIONS USED

e.g.. . . . = for example

M_A = tightening torque

SP no. . . = order number for spare part

min./max.= minimum/ maximum

pos. =position.

SYMBOLS USED



WARNING!

Safety instructions, danger to life and limb. Failure to follow safety instructions can lead to death or serious injury.



CAUTION!

If you fail to follow instructions bearing this symbol, this could result in damage to the machinery or material!



Important instructions and recommendations.



Environment protection instructions and instructions for environment-friendly operation.

Technical customer service (TKD)

	Telephone number at work	Mobile number
Management of entire service GSMr. Knab	+49(0)7392/900-101	0171-4338602
Departmental manager of TKD Mr. Strähle	+49(0)7392/900-103	0171-5769732
Regional manager of TKD Mr. Stockinger	+49(0)7392/900-106	0171-4066984
Regional manager of TKD Mr. Braun	+49(0)7392/900-105	0171-4066982
Regional manager of TKD Mr. Arbogast	+49(0)7392/900-118	0171-4338395
Regional manager of TKD Mr. Bohnet	+49 (0)7392/900-116	0171-4439069
	Fax +49(0)7392/900-100	

24-hour emergency number: Tel. 0171/7124096

Spare parts department (ET)

ETV management Mr. Kristen +49(0)7392/900-135 Fax+49(0)7392/900-140

Emergency number for sales of spare parts: Tel. 0171/3732230

Contact at my national office:

Name of Technical customer service :Telephone number :

Name of Spare parts department :Telephone number:.....

Name of Repairs fitter:Telephone number:.....



Always quote the vehicle number when making enquiries and ordering spare parts.

TKD centrally controls the use of customer service engineers.

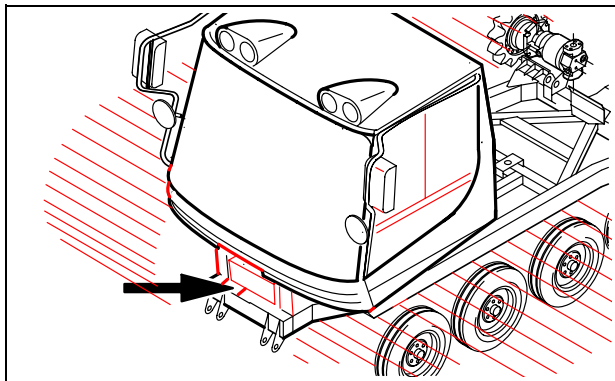

The vehicle identification number (VIN) is embossed on the front of the outside face of the right-hand side of the chassis.

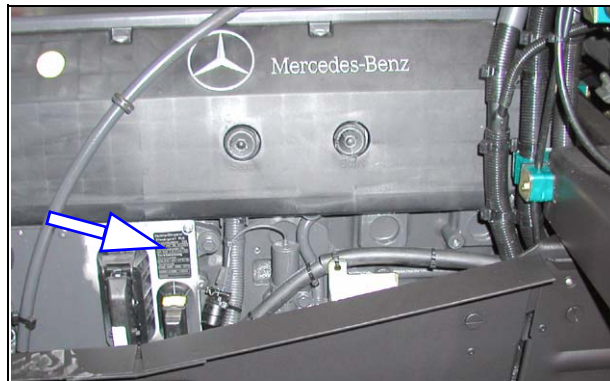

The engine number is embossed on the type plate on the engine.



In your own interest please note the following: we recommend that you use the **genuine components** from **Kässbohrer Geländefahrzeug AG** and the conversion and auxiliary components approved specifically for your vehicle type. These components have undergone a special inspection procedure which tested their reliability, safety and suitability for Kässbohrer Off-Road Vehicles. Despite ongoing studies of the market, we are unable to assess whether this is the case for other products – even if they have passed a TÜV approval test or have official approval. We therefore cannot vouch for such products.

Genuine components and approved conversion and auxiliary components can be obtained from your **Kässbohrer Geländefahrzeug AG** service support centre. There you will also receive comprehensive advice, including about permissible technical modifications, and our trained staff will carry out the fitting of parts.

The use of any non-genuine components renders all warranty claims invalid. We do not recognise liability for secondary damage resulting from this.

KÄSSBOHRER GELÄNDEFahrZEUG AG

OPERATION

Correct usage:

Snow groomers may only be operated as specified in the manufacturer's operating manual.

The Pisten Bully may be used for the following purposes only:

- grooming ski-slopes.
- removing snow from paths and tracks in the countryside. Not on public roads.
- grooming Nordic ski-runs.
- transporting people in the special people-carrier cabin (optional extra).

If you wish to use the vehicle for any other purpose, you must apply for written approval from the manufacturer.

DRIVERS

- Drivers must be specifically appointed to drive snow groomers.
- You may appoint people to drive the snow groomers on their own only when you are certain that they will be able to reliably fulfill the tasks assigned to them.

In particular, they must satisfy the following:

- be at least 18 years old.
- be physically and mentally suitable.
- be trained in how to drive the snow groomer and have proven their driving ability to the operator.
- be familiar with the characteristics of the snow and the characteristics of operating ski-slopes.
- be familiar with the area where the vehicle is to be used, especially with regard to particularly dangerous areas.
- be familiar with first-aid procedures in the event of an accident.

- if avalanches pose a threat in the area where snow groomers are to be used, in addition to the aforementioned conditions, drivers must also be instructed about how avalanches are started, the consequences of them and how to behave when there is a risk of avalanches.

DANGER ZONE FOR PERSONS

- No-one is permitted to enter the snow groomer's immediate danger zone.
- The driver may only operate and drive the snow groomer provided that there is no-one in the immediate danger zone.
- The driver must issue warnings when in dangerous circumstances.
- Special protection measures must be taken if the snow groomer is being used in an area where the driver does not have a clear view of the surrounding area and people may unintentionally enter the danger zone. Depending on the circumstances of each case, these measures may take the form of warning signs, closed runs or off-limit markers.

DRIVING THE VEHICLE

- Never leave the vehicle unattended with the engine running.
- Risk of poisoning from exhaust gases. Never leave the engine running in enclosed spaces.
- The driver may only start and/or move the snow groomer when seated in the driver's seat, after fastening the seat belt.
- Never try to adjust the driver's seat and steering wheel when driving.
- Snow groomers must be used and operated in a manner which ensures their stability.
- Drivers may only drive the snow groomer at a speed which they can continually control. They must adapt the speed to the snow, terrain and visibility conditions and to the characteristics of the snow groomer. If necessary, they must take account of the auxiliary equipment used.
- The driver must not exceed a safe speed for prevailing visibility. This does not apply to steep

slopes where the vehicle cannot be stopped as a result of the angle of the terrain. Drivers may only drive on such steep slopes once certain that they can do so without putting themselves and others at risk.

- Never drive the Pisten Bully with open doors.
- Loads must be correctly secured.
- When driving past people, slow down, keep at a safe distance and always bear in mind that the people may behave unexpectedly.
- Always come to a complete stop before reversing the vehicle.
- Ensure that the area behind the machine is clear.
- Avoid crossing slopes at an angle because the Pisten Bully may slip downhill.
- When driving a tracked vehicle, the traction is so great that the vehicle may be driven well beyond the point at which it should start to tilt and then suddenly tip over.

- Risk of damage to the electronics of the Pisten Bully! The use of mobile phones in the cab while the diesel engine is running is prohibited.

ENTERING / STOPPING / PARKING

- Danger of slipping on the track when entering and exiting the driver's cab.
- When parking on a slope, be particularly careful when opening the door. The door opens at an angle.
- Do not park the vehicle where it cannot be seen.
- Lower front- and rear-mounted auxiliary equipment to the ground, switch off snow blower, set the direction-of-travel switch to "neutral", apply the parking brake.
- Never leave the vehicle unattended with the engine running and do not leave the engine running in an enclosed space. Switch off the engine, remove the key when you exit the vehicle, and lock the cab
- Risk of injury: PistenBully with sticks. Raise the driver's seat armrests/sticks before exiting the cockpit.

OPERATION UNDER UNUSUAL CONDITIONS

- Before using the snow groomer, check that the area can be traversed.

RISK OF BREAK-THROUGH



- Driving on frozen rivers and lakes is very dangerous. We would therefore advise against this.

SNOWDRIFTS



DANGER OF AVALANCHES DANGER OF FALLING STONES



- The driver must be accompanied by a co-driver when driving in areas where the vehicle cannot be seen and when the weather is bad, unless several vehicles are working together as a team. This does not apply if the driver uses a radio to remain in constant contact with someone at the base who can send out a rescue team should an accident occur.
- When using snow groomers at night-time, handheld search-lights must also be used.
- The driver must be secured by means of the safety belt when the winch is in operation.

DRIVING WITH PASSENGERS

- Only 1 co-driver may sit in the driver's cab.
- The co-driver must be seated on the co-driver's seat at all times when the vehicle is in motion.
- When persons travel in the PB people carrier cabin, they must sit on their seats with their safety belts correctly fastened, and hold tight.
- The retaining screws of the people carrier cabin must be checked every day to ensure that they are tight.

Do not drive the vehicle with people on:

- the load platform
- the auxiliary driven machinery
- an attachment

MAINTENANCE

- Snow groomers must be maintained by trained staff specifically appointed by the operator.
- Do not perform maintenance work under movable parts in their open or raised positions unless they have been secured to prevent them from slamming closed or dropping.
- Snow groomers and raised equipment must be secured before maintenance work is started to prevent them from accidentally moving.
- Markings, warning signs and information plates on the PistenBully and auxiliary equipment must not be removed or covered over or made illegible in any other way.
- Compliance with the manufacturer's maintenance instructions is mandatory.
- Faults which could affect safety levels must be rectified immediately.

MONITORING

- Before starting off, the driver must check the function of the vehicle parts which assure safe operation, e.g. by testing the brakes, switching on the lighting, checking the function of the warning devices. Operation of the controls for auxiliary equipment must also be checked.
- If radios are required to ensure safe operation of the snow groomer, before starting off checks must be performed to ensure that the radio is functioning correctly and that there is a radio connection.
- The driver must immediately report defects to the supervisor and, on vehicle handover, to the replacement driver.
- In the event of damage, defects or changes that endanger operational safety, the driver must immediately cease operation of the vehicle.
- The supervisor must be notified immediately in the event of accidents involving injury to persons or damage to property or to the vehicle.
- The supervisor must perform random checks in order to ensure that the snow groomer is operated in a safe manner.

10839.en

INSPECTION

The operator must ensure that the snow groomers are inspected whenever necessary, at least once a year and after maintenance work. This inspection must ensure that the snow groomers are safe and must be performed by a skilled specialist.

Skilled specialists are people who have an extensive knowledge about vehicle technology as a result of their specialist training and experience. They are also sufficiently familiar with the appropriate national safety at work legislation, accident prevention guidelines, directives and generally accepted rules of engineering practice (e.g. DIN sheets, VDE requirements) to ensure that they can judge whether snow groomers are in a condition suitable for operation..

The results of the inspection must be recorded in writing and filed.

FIRST-AID KIT

The fire extinguisher is stowed behind the driver's seat.



Note expiry date.

Always make sure that the first-aid kit is complete.

FIRE EXTINGUISHER

The fire extinguisher is stowed behind the driver's seat.



Note expiry date.

Replace used fire extinguishers immediately.



WARNING PLATES**WARNING!**

Strictly observe all warning plates fitted to the Pisten Bully and the auxiliary equipment!

**WARNING!**

Always replace damaged or lost warning plates immediately!

WARNING PLATE:

Fitted to: **Engine cover**
KGG No. 8.762.658.000E

Text: **Caution! Riding on the load platform is strictly prohibited.**

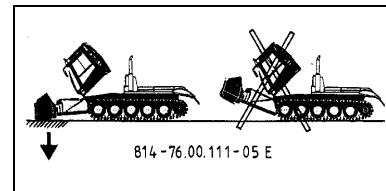
WARNING PLATE:

Fitted to: **Steering wheel**
KGG No. 814.76.00.111.05E

Text: **Tilting driver's cab and lowering equipment carrier (risk of collision).**

WARNING PLATE:

Fitted to: **driver's cab / parking brake.**

KGG No.8.765.311.058E

Text: **Caution! Apply parking brake before leaving the driver's cab.**

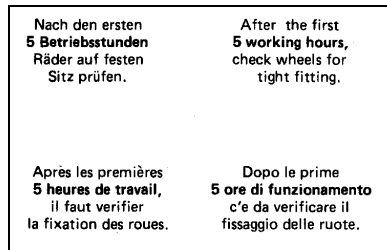
WARNING PLATE:

Fitted to: **Windshield.**

KGG No. 8.762.430.057E

Text: **After the first 5 operating hours, check that wheels are securely mounted.**

WARNING PLATE:

Fitted to: **Diesel engine**

KGG No. 8.312.085.064

Text: **Warning! Do not use starter fluids or ether when switching on the diesel engine (risk of explosion).**

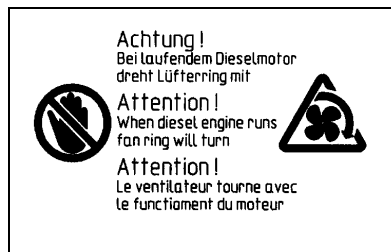
WARNING PLATE:

Fitted to: **Fan / engine**
KGG No. 8.762.634.054E

Text: **Caution! When the diesel engine is running, the fan rotor turns.**



Protect fan against damage.

WARNING PLATE:

Fitted to: **Console / driver's cab**
KGG No. 8.765.246.000E (**D**)
KGG No. 8.765.246.001E (**F**)
KGG No. 8.765.246.005E (**GB**)
KGG No. 8.765.246.008E (**I**)
KGG No. 8.765.246.011E (**E**)

Text: **Caution! In manual mode (digital electronics switched off), vehicle sets off immediately. Zeroise the drive potentiometer.**

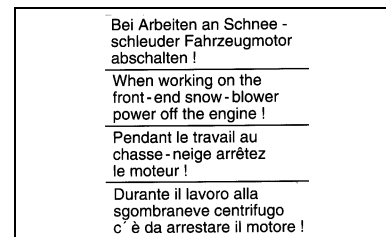
WARNING PLATE:

Fitted to: **KFS**
KGG No. 8.762.435.058E

Text: **Always switch off the engine before working on the rotary snow blower!**

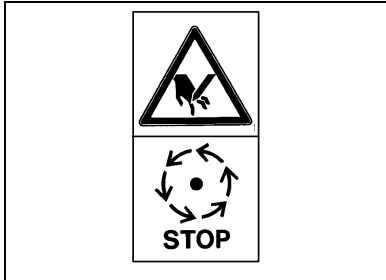
WARNING PLATE:

Fitted to: **rotary plough**
KGG No. 8.762.638.058E

Text: **Do not touch mechanical components until they have come to a complete stop!**

WARNING PLATE:

Only fitted with KFS: **Steering wheel.**

KGG No. 8.765.679.000E (**D**)
KGG No. 8.765.679.001E (**F**)
KGG No. 8.765.679.005E (**GB**)
KGG No. 8.765.679.008E (**I**)
KGG No. 8.765.679.011E (**E**)

Text: **Reversing with inching potentiometer is not permitted! Comply with Operating Manual.**

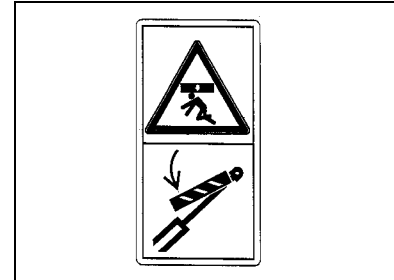
WARNING PLATE:

Fitted to: **Engine cover**
KGG No. 8.762.643.000E

Text: **Standing in the danger area (load bridge) is prohibited unless the lifting cylinder inhibit has been enabled!**

WARNING PLATE

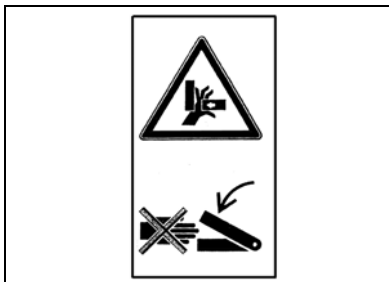

Attached to: **auxiliary equipment**
KGG no. 8.762.660.000 E

Text:
Warning!
Do not reach into crushing zone while parts there may be moving!

WARNING PLATE:

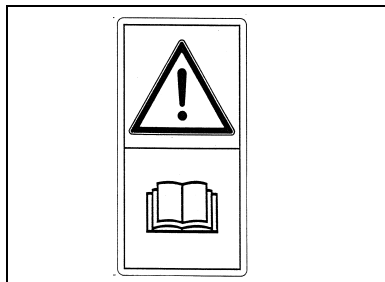

Fitted to: **Driver's cab**
KGG No. 8.762.642.000E

Text: **Before driving the vehicle, read and follow the Operating Manual and safety instructions!**

WARNING PLATE:

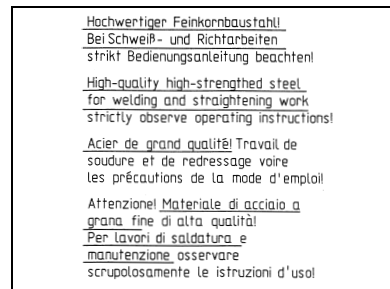

Fitted to: Chassis
KGG No. 8.762.531.058 E

Text: **High-quality fine-grain construction steel. Always consult Operating Manual before carrying out any welding or straightening work!**



For further details, please consult the relevant Workshop Information Bulletin!

WARNING PLATE:

Achtung!	Attention!
Vor dem An- oder Abkuppeln der Hydr.-Schläuche unbedingt den Dieselmotor abstellen.	Before connecting or disconnecting hydraulic hoses, diesel engine must be shut down.

Fitted to: **rotary plough**
KGG No. 8.762.271.053C

Text: **Caution!**
Always switch off diesel engine before connecting / disconnecting hydraulic lines!

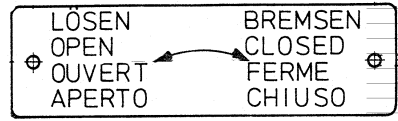
Information plate:

Attached to: **parking brake**
KGG no. 8.761.994.058E

Text:
Release parking brake.
Actuate parking brake.

Information plate:

Attached to: **frame**
KGG no. 8.762.689.000 E

Text:
Raising and lowering lever positioning for driver's cab and loading bridge.

GENERAL INSPECTION AND MAINTENANCE INSTRUCTIONS



WARNING!

While engine is running maintain a safe distance from rotating parts.

Always carry out essential inspection work before operation.

Carry out inspection work with engine switched off and on a horizontal parking area.



The oil and coolant marks measured (dipstick, overflow plug etc.) must be strictly adhered to.

TOPPING UP OR CHANGING FLUIDS AND LUBRICANTS

Fluids and lubricants:

- do not bring into contact with skin (wear safety gloves, change any clothing they have touched).
- do not breathe in or drink (danger of poisoning).
- do not mix different sorts of fluids and lubricants.



Fluids and lubricants nicht spill (danger of polluting soil and ground water). Dispose of carefully (comply with national legislation).

CHECKING COOLANT LEVEL



Check and top up coolant only when it is cold.

- Check coolant level on sight glass of expansion tank.
The water level must be between the min. and max. marks.
- Check the anti-freeze of the coolant, (refer to fluids and lubricants specification).
- Check that connecting hoses in the cooling and heating systems are sealed.

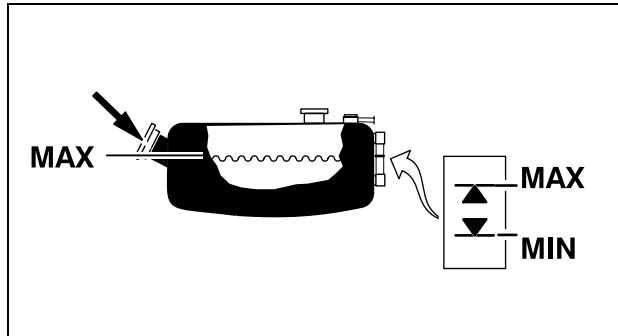
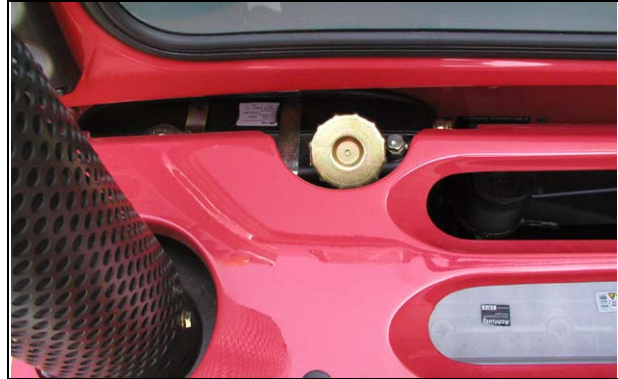

CHECKING ENGINE OIL LEVEL

- You use the oil dipstick to undertake the oil level check.
- Top up oil when engine is at standstill and when the PistenBully is standing on level horizontal ground. The oil level must be between the min. and max. marks on the oil dipstick.



Only top up with approved engine oils (refer to fluids and lubricants specifications).

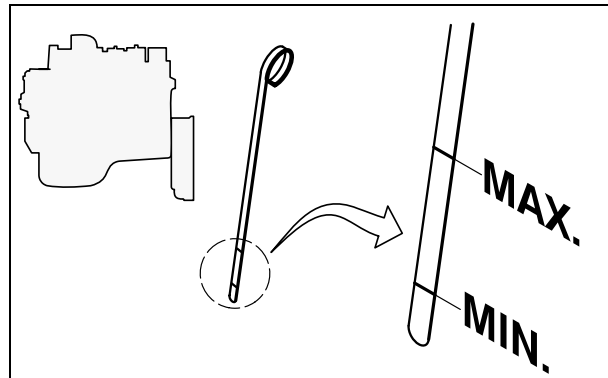
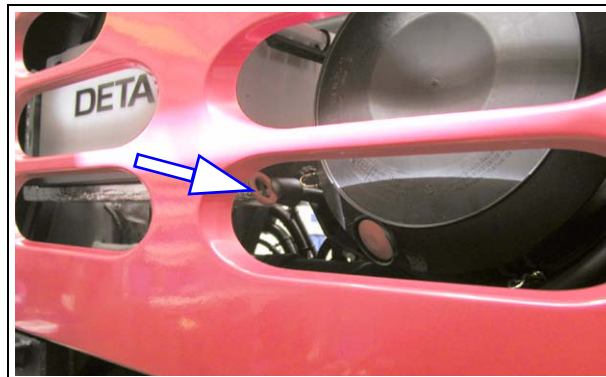

CHECKING HYDRAULIC OIL LEVEL

- Check hydraulic oil level using sight glass of hydraulic oil tank.

The sight glass is visible from the outside through opening in the side panel.



Only top up using approved hydraulic oil (refer to fuel specifications).

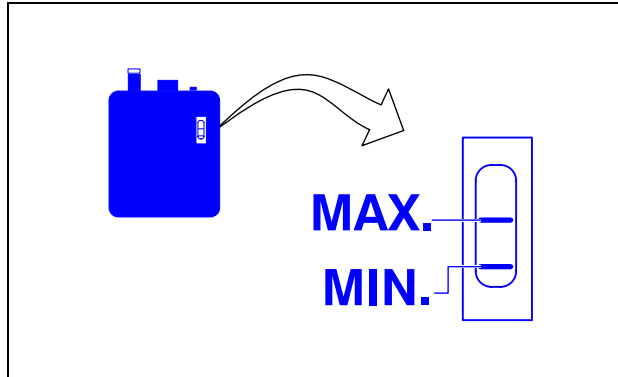

Adjusting air intake:

There is a risk of ice particles damaging the turbocharger blades:

- at temperatures below -10°C
- powder snow or very fine snow
- when air humidity is high



At temperatures above 0°C , move intake air flap to pos. **2**, otherwise power will be lost on the diesel engine.

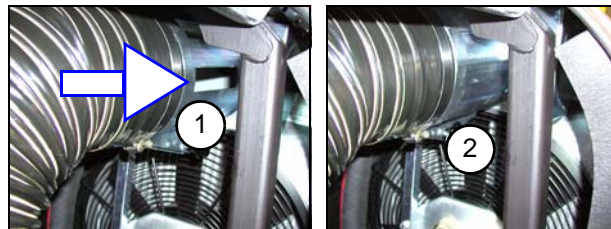
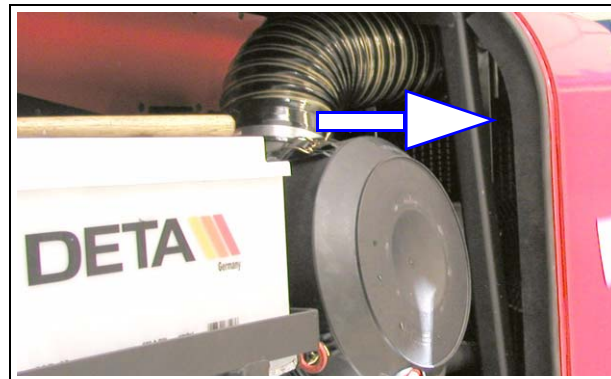

Setting intake air flap

- in pos. **1** = engine compartment air intake.
- in pos. **2** = fresh air (cold air).

CHECKING THE ELECTRICAL SYSTEM

- Monitor lighting and turn signals and rotary beacon. Repair when necessary. While doing so, follow instructions for the rotary beacon (high-voltage).
- Replace defect bulbs and fuses.
- Windshield wipers, horn and reversing alarm.



WARNING!

Never operate PistenBully without properly functioning warning and rotary beacon systems.

VISUAL INSPECTIONS

- Carry out visual inspection of tracks and wheels. Look for damage to tyres.
- Carry out visual inspection of attachment of auxiliary equipment (cotter pins, bolts, nuts).

- Carry out visual inspection of hydraulic system (vehicle and auxiliary hydraulics) hydraulic lines, couplings, hoses, appliance cylinders. Look for signs of leakage and chafing.

CHECKING PARKING BRAKE

- Start engine – apply parking brake: telltale lights up.
- Move direction of travel switch / speed range selector lever to "Forwards" and rev engine up briefly to approx. 2000 rpm.



WARNING!

The PistenBully must not move forwards! Never drive with defective parking brake.

- When parking brake is released, telltale in instrument cluster must go out.
- Carry out daily inspection work
- Check drive belt on engine (viscous fan, 3-phase alternator) for belt tension and damage (refer to engine manufacturer's Operating Manual).

CHECKING FUEL DELIVERY FILTER

- Unscrew filter housing **1** remove filter **2** and clean with diesel fuel using soft brush.



Replace very dirty and/or damaged filters.

- Check filter housing seal and replace if necessary.
- Place filter in filter housing and screw it in. Tightening torque 10 Nm.

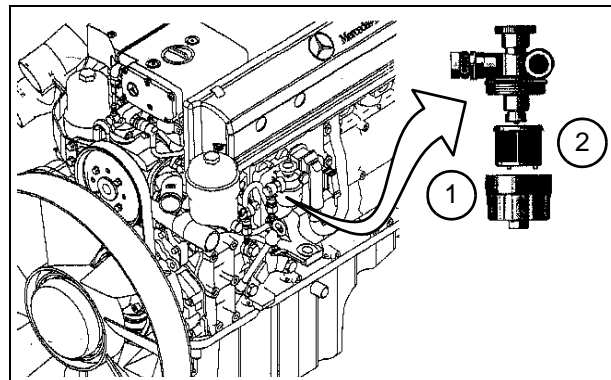

Ensure seal is in correct position.



Comply with national guidelines when disposing of used filters and remaining fuel.

TRACK TENSION

Checking track tension:



PistenBully must not be loaded.

- Park PistenBully on horizontal ground covered with snow.
- Lower auxiliary equipment.
- Balance out track tension by driving backwards and forwards.

The correct track tension is in place when the upper section of the track can be raised by approx. 40 – 50 mm.

- Check condition of track belts, locks, brackets and cleats, replace damaged parts.

ROCKER SWITCH WITH LOCKING DEVICE

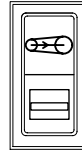

Track tensioning:

Pressed at top + unlocked: Track tensioning in operation.

Button pressed: Detension track
Indicator lamp flashes.
(Refer to chapter 21)



Before releasing the track, park vehicle on level ground and chock to prevent it from rolling away. Engage the parking brake.

If the PistenBully is to be left standing for an extended period of time, release track tension to avoid any unnecessary stretching of track cleats.

CHECK THE WHEELS

- Check that wheels are securely mounted, and check tyre pressures.

Tightening torque / Tyre pressure

Type	Track tensioing axle	Tyre pressure Track tensioning axle	Idler axle	Tyre pressure Idler axle
PistenBully 200	300 Nm	-----	300 Nm	7.0 bar

○

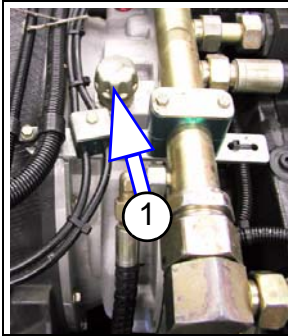

TRANSFER BOX

- Tilt the load platform.
- Use the dipstick to check the engine oil level.
- Brass cap **1** w/f 36; measure with oil dipstick set on (screw threads not engaged).
- The oil level must be between the min. and max. marks on the oil dipstick.
- Use only approved oil for transfer cases (see fluids and lubricants specifications).

TEST RUN

- Check operation and test all instruments and indicators.
 - Check running gear and engine / transmission unit for abnormal noises.
 - Visually inspect for smoke at the exhaust.
- Check the air filter element if the exhaust is smoky.
- Check operation and test all instruments and indicators.
 - Check running gear and engine / transmission unit for abnormal noises.
 - Visually inspect for smoke at the exhaust.



Check the air filter element if the exhaust is smoky.

DIESEL FUEL

- When using diesel fuels with a sulphur content comprising 0.5 % of volume, the oil change intervals must be twice as frequent.
- When using diesel fuels with a sulphur content comprising 1 % of volume, the oil change intervals must be three times as frequent.

Diesel fuels at low temperatures

Select the diesel fuel's resistance to the cold in accordance with the temperature characteristics in the area of use and source the fuel from the fuel supplier (refer to MB Fluids and Lubricants Specifications 137.0 and 137.1)

CHANGING COOLANT

Water quality:

Free from contamination (grease, dirt, lime...)

If not observed: reduction in heat transfer capability and formation of deposits and blockages in coolant ducts.

Note: drinking water often satisfies the water quality requirements.

Changing coolant:

Note: Filling container and funnel must not contain any residue from other fluids and lubricants.

1. Select antifreeze agent

Only use antifreeze agents as defined in **MB fluids and lubricants specification 325.2.**

The coolant is mixed for the whole year using a mixture containing 50% water + 50 vol.% antifreeze agent. Antifreeze guaranteed to down to approx. -37^oC (refer to MB Fluids and Lubricants Specification 310).



CAUTION!

Risk of engine overheating!

Do not exceed 55 vol.% of antifreeze agent.

Antifreeze agent change interval

At least: every 3 years

After engine operating hours: every 3600 hours

Other antifreeze agents



CAUTION!

Engine overheating!

Risk of coolant foaming and therefore engine overheating.

- The use of other antifreeze agents for topping up and antifreeze changes is strictly forbidden.

Remedy: If foaming occurs in cooling system

- Drain out all coolant. Fill cooling system with tap water and bring up to operating temperature.
- Drain out coolant (repeat process until coolant no longer foams).
- Fill cooling system with specified antifreeze agent mix.

Group	Designation	Grade	Fill quantity	Change intervals
01	Mercedes Benz engine OM 926 LA	MB sheet 228.5 SAE 10W 40/ 5W 40	28 litres	at least: every year every 800 hours
		MB sheet 228.3		at least: every year every 600 hours.
		If a different quality engine oil is used to fill up the engine, the maintenance interval for the lower oil quality applies.		
02	Fuel tank		180 litres	at least: every year Drain condensate.
	Fuel filter			every 800 hours
03	Air filter			at least: every year every 1200 hours
04	Cooling / heating system	50 % water + 50 % antifreeze agent	30 litres	at least: every 3 years every 3600 hours
06	Transfer box	Poly Alpha Oleofin (PAO) - CLP HCVG 150 / VG 220 ISO VG 220 (for summer operation) - API-GL4 SAE 75 W 90	3,2 litres 1,7 litres SW36	at least: every year every 800 hours new vehicle 100 hours
06	Planetary gearbox	Poly Alpha Oleofin (PAO) - CLP HCVG 150 / VG 220 ISO VG 220 (for summer operation) - API-GL4 SAE 75 W 90	2 litres	at least: every year every 400 hours new vehicle 100 hours

Group	Designation	Grade	Fill quantity	Change intervals
07	Hydraulics Travelling drive + auxiliary device	HVLPD DIN 51524 DEXRON II D / III F ATF Type A Suffix A	approx. 47 litres	at least: every year every 1200 hours
	Hydraulic oil filter			at 100 hours every 1200 hours
18	Hydrostatic vehicle drive refer to Lubricants Chap.	OKS 250		
	Lubricate hubs and swinging arms.	Calcium saponified grease Aviacal 2 LD KP2K-20, DIN 51502		every 400 hours
	Other lubrication points refer to Lubricants Chap.	Calcium saponified grease Aviacal 2 LD KP2K-20, DIN 51502		every 100 hours
24	Electrical system Battery terminals	Boschfett FT 40V1		
	Alternator with staufer bush	Boschfett FT 1V34		every 1200 hours
	Servo adjustment device for Moog valves	Insulation oil DIN 57370 / VDE 0370		



Capacities as stated are approximates.
Check level with dipstick or overflow plug.
10839.en

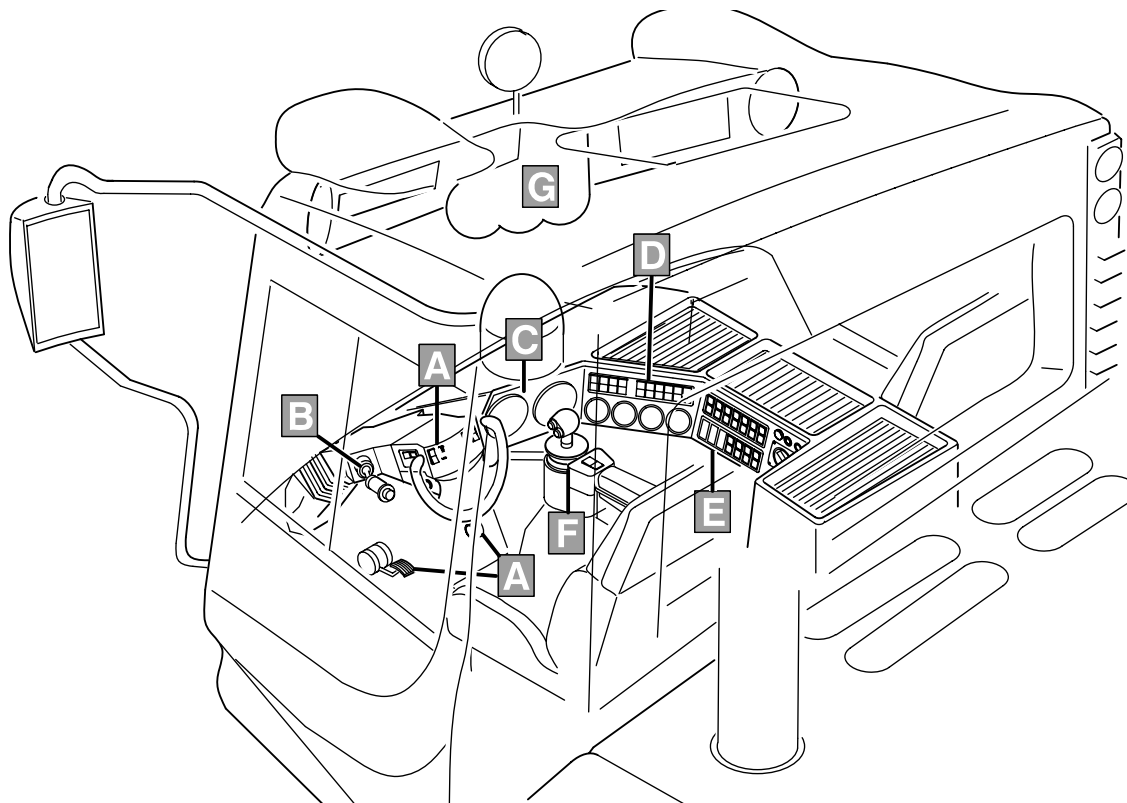

Notes in text such as: **refer to D 17** = driver's cab **section D, Pos. 17**

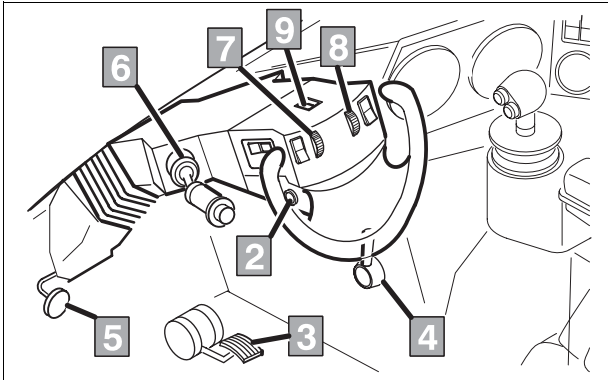
**2 KEY**

During activation, single actuation of front and rear screen wipers.

3 ACCELERATOR**4 PARKING BRAKE**

Always engage parking brake when parking or leaving vehicle.
Buzzer check sounds if a brake is not applied or a door is open.

5 LOCKING DEVICE

For adjustment of steering column

6 COMBI SWITCH

Refer to section B

7 KNURLED WHEEL

Reducing driving speed

8 KNURLED WHEEL

Reducing rotary shaft speed

9 BUTTON

Swiveling rear equipment carrier
Refer to chapter 23.

3 SETTING SWITCH

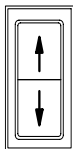

Selector switch for direction of travel
 Pressed at top = **Forwards**
 Centre = **Neutral**
 Pressed at bottom = **Backwards with re-verse travel warning!**

3 SETTING BUTTON

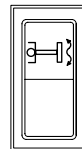

Pressed upwards = **equipment carrier float position vertical.**
 Centre neutral = **carrier plate locked in position**
 Pressed downwards = **centering rear equipment carrier.**

ROCKER SWITCH

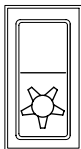

3. Adjustment pump – rotary plough drive
 On/Off
 Indicator lamp **C1.13** comes on.
 refer to chapter 24



When the parking brake is engaged, the rotary plough drive is automatically deactivated (telltale C1.12 flashes). Once the parking brake has been released, the rotary plough drive remains deactivated. To activate the rotary plough, the toggle switch has to be switched off and on again .

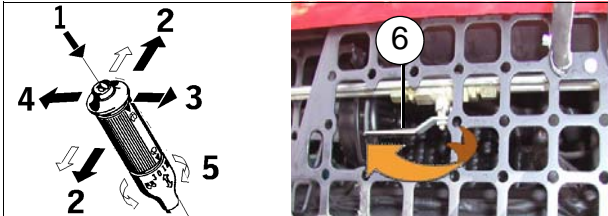

1 HORN

Press button

2 Flashing turn indicators

Left or right without automatic cancellation. Move control stalk past stop until it locks in position.

3 HEADLIGHT FLASHER

Push stalk to the right

4 HIGH-BEAM/LOW-BEAM HEADLIGHTS

High beam – Push stalk to the left until it locks in position.

Low beam – Push stalk to the right until it locks in position.

5 WIPERS

Turn control stalk sleeve:

Position II = fast

Position I = normal

Position 0 = off

Position INT = intermittent wipe

Windscreen wipers heated: (*optional equipment*)

Swivel stalk **6** at front in the direction indicated by the arrow.



Programming new intermittent-wipe time

- Set multipurpose control **2** to position 0.
- Briefly press button **1**.

Wipers perform one sweep.

- Wait for intermittent -wipe time required and move multipurpose control **2** to the INT position.

The time you waited between pressing the button and moving the switch back to INT is the programmed intermittent -wipe time.

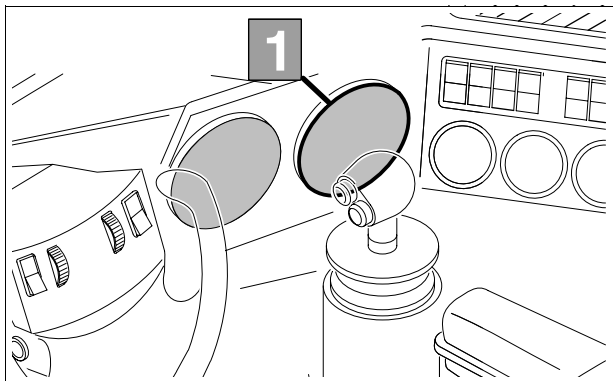

1 WARNING AND INDICATION SYMBOLS

1.1 ORANGE TELLTALE ILLUMINATED:



Caution! Rotary plough shaft turning

1.2 RED WARNING LIGHT ILLUMINATED:



ILLUMINATED IF **DRIVER'S CAB LOCKING SYSTEM** IS NOT ACTUATED.

1.3 ORANGE TELLTALE



Emergency driving mode
Warning! Changed from electronic to manual throttle.

Refer to chapter 40

1.4 RED LOAD TELLTALE ILLUMINATED:

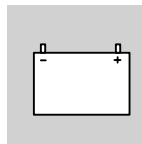

If the **telltale** is illuminated **during driving operation:**
stop driving – locate cause.

Refer to chapter 31

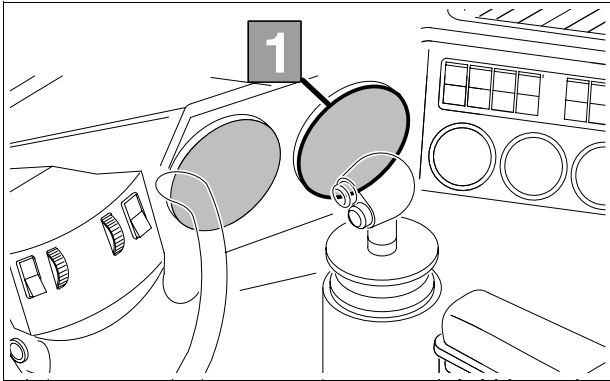

1.5 RED WARNING LIGHT ILLUMINATED:



Engine oil pressure has fallen to an unacceptable level.

Additional acoustic warning provided by **buzzer! Stop driving** (refer to chapter 30/31).

1.6 GREEN TELLTALE ILLUMINATED:

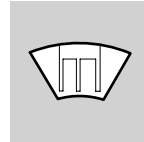

Electrical heating for windshield is switched on.

1.7 BLUE TELLTALE ILLUMINATED:

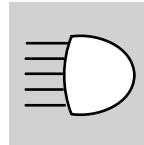

Headlight main beam switched on

1.8 GREEN TELLTALE FLASHES

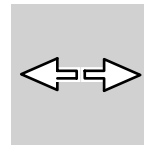

Direction indicator check left / right

1.9 RED WARNING LIGHT ILLUMINATED:

Hydraulic system oil level below min.

Additional acoustic warning provided by **buzzer! Stop driving**

Refer to chapter 31

1.10 RED WARNING LIGHT ILLUMINATED:

Hydraulic oil temperature too high

Additional acoustic warning provided by **buzzer! Stop driving.**

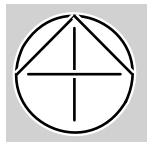
1.11 NOT ASSIGNED**1.12 RED WARNING LIGHT ILLUMINATED:**

Brake venting check on parking brake release pressure has dropped below 120 bar and/or parking brake applied.

1.13 RED TELLTALE ILLUMINATED:

Caution! Rotary plough drive switched on.

 **WARNING!**

If acoustic signal (buzzer) sounds, then the operating status has attained the min. or max. permissible value: **Stop vehicle – apply parking brake – locate cause! No driving mode permitted.**

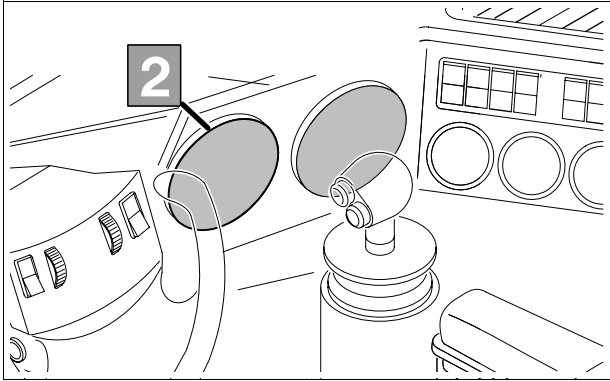

2 TACHOMETER

Refer to chapter 30.

3 ENGINE SETTING - TELLTALE

illuminated if there are engine control defects



If the telltale lights up, drive vehicle to nearest workshop. Only trained staff can perform repair work.

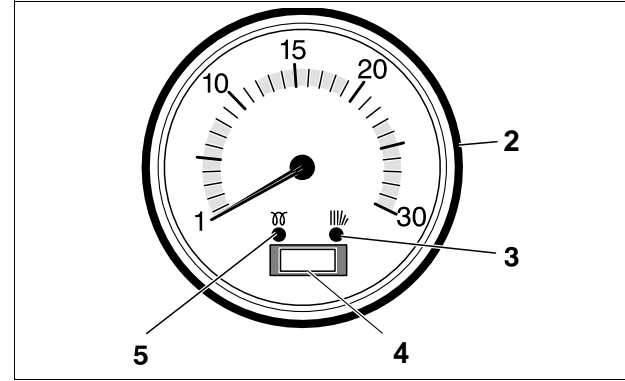

4 OPERATING HOUR COUNTER

5 INTAKE AIR PREHEATING

Refer to chapter 30.

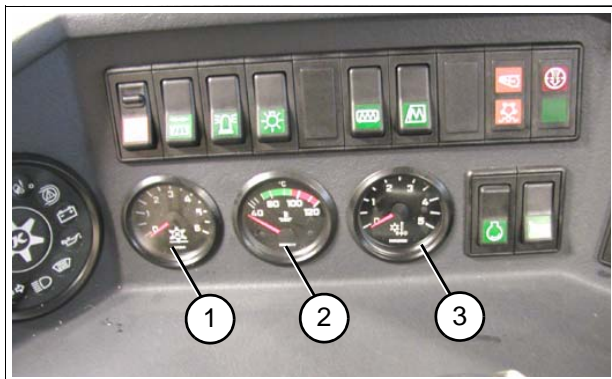

1 SHAFT DEPTH- DISPLAY

0=min. / 6=max.

2 COOLANT TEMPERATURE - ENGINE:



WARNING!

If an excessively high operating temperature is reached, an acoustic signal is provided by the buzzer.

3 SNOW-FLAP POSITION FOR TILLER



WARNING!

If the acoustic signal sounds (buzzer), then the operating status has reached the minimum or maximum permissible value: stop vehicle – apply parking brake – locate cause! No driving mode permitted.

ROCKER SWITCH WITH LOCKING DEVICE

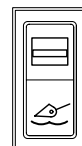

Carrier plate float position at front

Locking device in position - float position
Refer to chapter 22

Pushbutton



ParkBlade

Top section pressed = Retract
Centred = Neutral position
Bottom section pressed = Extend
See Section 30 / 52

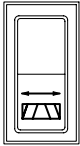
ROCKER SWITCH: SPECIAL EQUIPMENT

Move Kahlbacher **Front-mounted rotary snow plough** to one side – press down and move manual throttle **F1** to left/ right to actuate.

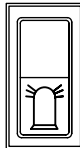
ROCKER SWITCH**Rotating warning beacon**

Pressed at top = OFF

Pressed at bottom = ON

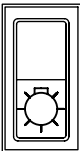
ROCKER SWITCH**Headlight low beam**

Pressed at top = OFF

Centre = Parking light

Pressed at bottom =Dipped beam

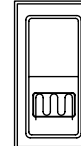
ROCKER SWITCH**Front windshield heating**

Pushed at bottom = ON

Telltale **C1.6** illuminated

Note: Cut-in duration is limited to approx. 10 minutes if engine is running. If a longer cut-in duration is required, press button again.

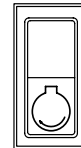
PUSHBUTTON**Controlling diesel engine idle speed**

Pushed at top = increase speed

Pushed at bottom = reduce speed

Note: speed display **C2**

TOGGLE SWITCH**Acoustic warning alarm**

Pressed at top: warning alarm ON during forwards travel.

Pressed at bottom: warning alarm OFF for forwards travel

ROCKER SWITCH

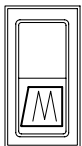

Side windshield heating

External mirror heating

Pressed at top = OFF

Pressed at bottom = ON

Side ventilation flap- direct heating to side window on passenger side, otherwise there is a risk of window icing up.

ROCKER SWITCH



Special equipment:
belt locking device

WARNING LIGHT



AIR-FILTER MONITOR

Check the air filter and replace if necessary.

COOLANT LEVEL (*optional equipment*)
below the minimum level

WARNING LIGHT FLASHES

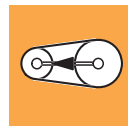

Track relief actuated.



WARNING!

Not permissible to drive the vehicle
(*rocker switch, see Section 21*)

INDICATOR LIGHT



Floating position, rear
raise / lower (vertical)

Flashing
Tiller is centred



MOBILE MOUNTING



CAUTION!

Electronic damage to Pisten Bully!
Mobile phones must not be used in the driver's cab when the diesel engine is running.



Use pushbutton (see arrow) to clamp mobile into place.

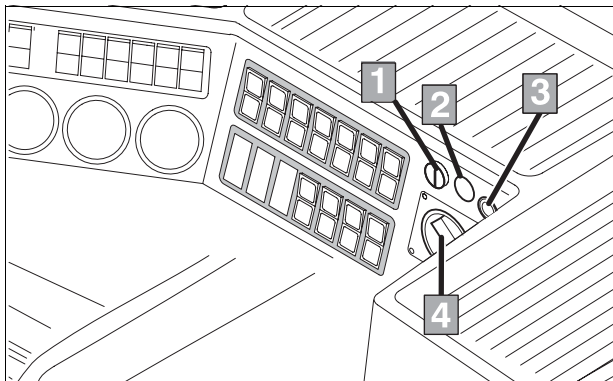

1 IGNITION LOCK:

- 0 Inserting and removing ignition key. Switching off engine.
- I Readiness for operation/driving
- II Starting

2 STAGE SWITCH

Heating fan

3 SOCKET

24 Volt

10839.en

4 WARM WATER CONTROL

Heating

HAZARD WARNING LIGHT LIGHTS UP:

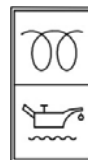

- Intake air preheating ON.

refer to chapter 30

- not assigned

CONTROL BUTTON: SPECIAL EQUIPMENT

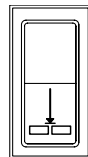

Rigid setting - multiflex

Refer to chapter 55

3 X PUSHBUTTON: SPECIAL EQUIPMENT

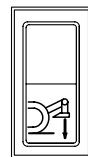

Raise/ lower track plate

View from left:

!.Pushbutton - left track plate

2.Pushbutton - central track plate

3.Pushbutton - right track plate

ROCKER SWITCH

Rear windshield heating

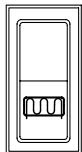
**ROCKER SWITCH**

Rear operating light

Pressed at top = OFF

Middle = dipped beam

Pressed at bottom = high beam

**ROCKER SWITCH**

Rear windshield wiper

Pressed at top = OFF

Middle = intermittent wipe

Pressed at bottom = ON

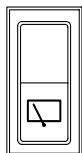
**PUSHBUTTON: SPECIAL EQUIPMENT**

6 meter smoother

Lower/raise right external part

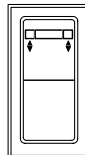
**PUSHBUTTON: SPECIAL EQUIPMENT**

6 meter smoother

Raise/lower left outside section

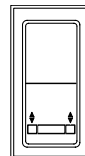
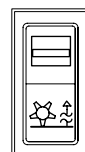
**ROCKER SWITCH WITH LOCKING DEVICE****Automatic raising** of auxiliary equipment at rear when travelling backwards. (Locking device engaged).**Automatic raising when not in use.** Release locking device and operate switch. (Refer to **Chap. 23**).

ROCKER SWITCH

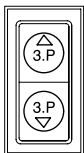

Hydraulic drive system for auxiliary equipment at front and rear.

Pressed at top = front ON

Middle = OFF

Pressed at bottom = rear ON

Note: this is a function at engine speeds of 1100 rpm or more.

ROCKER SWITCH SPECIAL EQUIPMENT

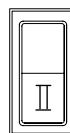

two-stage speed

ROCKER

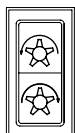

Rotary plough – running in/against direction of travel

– Top depressed: In direction of travel

– Bottom depressed: Against direction of travel

PUSHBUTTON



Snow-flap position for tiller

Top section pressed = Retract snow flap

Bottom section pressed = Extend snow flap

((see the section entitled "Multiflex tiller"))

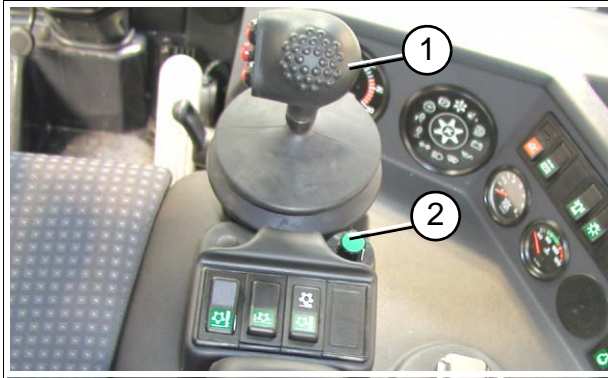

1 MANUAL THROTTLE

for front hydraulics with pushbutton
(refer to chapter 23).

2 Potentiometer

Tiller down pressure/up pressure
(refer to chapter 23).

PUSHBUTTON/ ROCKER SWITCH

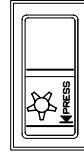

Raising/ lowering rotary plough

Pressed at top = raise equipment carrier
Middle = equipment carrier in neutral
Pressed at bottom = apply pressure
refer to chapter 23

PUSHBUTTON

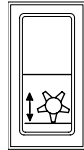

Shaft depth adjustment

Depth display given by instrument **D1**.
Refer to chapter 23

PUSHBUTTON

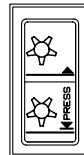

Tool carrier adjustment

Pressed up = disengage rotor
Centre = rotor in floating position
Pressed down = engage rotor
refer to Section 24

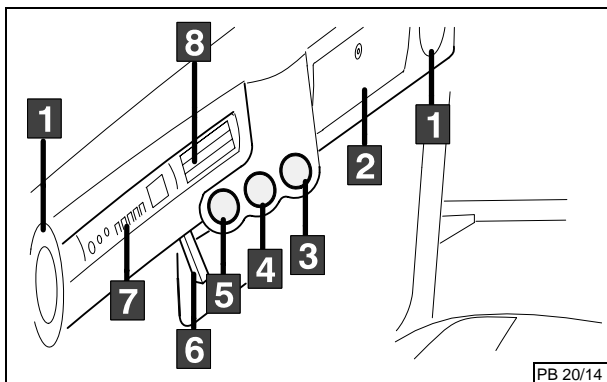

6 SEARCHLIGHT

7 RADIO – PREPARED FOR INSTALLATION

**8 RADIO UNIT – PREPARED FOR
INSTALLATION**

1 LOUDSPEAKER

2 GLOVE COMPARTMENT

3 EXTERNAL TEMPERATURE

4 FUEL SUPPLY -DISPLAY

5 CLOCK



Functional description:

1 Head-restraint cushion

Height and angle are adjustable.

2 Release button

For folding the backrest forward.

3 Knob

For adjusting the side wings for optimum lateral support.

4 Knob

For variable adjustment of backrest rake.

5 -3-stop lever

For limiting float to

- 150 mm travel
- 90 mm travel
- 75 mm travel (no-float position)

6 Knob

For variable adjustment of the seat cushion through 8°.

7 Knob

For variable weight and height adjustment.

8 Horizontal fore-and-aft adjustment

By locking rails on both sides.

9 Knob for adjusting side wings

For optimizing lateral support.

10 Stepless adjustment of seat depth

from 495 to 570 mm with knob.

11 Seatbelt

12 Lumbar support

With height adjustment, electrically operated.

13 Rocker switch for curvature

14 Rocker switch for height

15 Switch for two-stage control

Heating, seat cushion and backrest

16 Indicator light for heater

17 Armrest holder

Armrest, left, heated

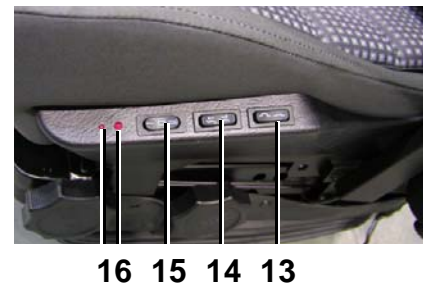

Instructions for use:

Turn knob (6) clockwise or counter-clockwise to adjust the angle of the seat cushion variably through 8°.



The angle of seat tilt is correct when the pedals can be operated without the seat applying excessive pressure to the underside of the thighs.

Lumbar support with electrically operated adjustment for curvature and height (12).

Use rocker switch (13) to adjust curvature.

Use rocker switch (14) to adjust height.

Heating for **Seat cushion and backrest**

Use switch (15) to select either of the two heating stages.

- Both indicator lights ON = Heater at full power
- Only one indicator light ON = Heater at reduced power.

Armrest, left, heated, with holder (17)

The angle of tilt of the armrest can be adjusted by means of a knurled screw on the underside. Armrest holder (17) can be moved 30 mm forward or to the rear.



When the vehicle is laid up for the summer, set the seat to the no-float position to take the strain of the spring. The side wings of the seat are adjustable by mechanical elements. Consequently, do not sit on the wings.

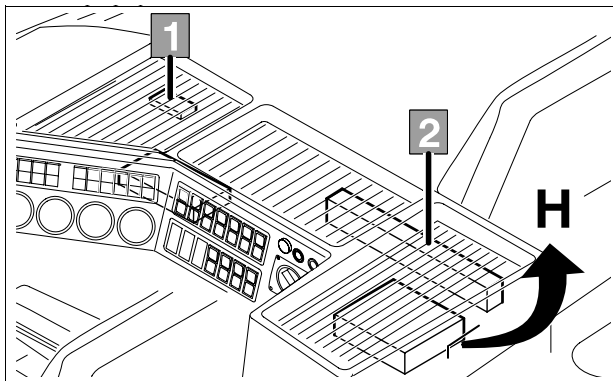

Central console **H** raised by means of recessed grip.
Locked by a pneumatic spring support.

1 CONSOLE SWITCH:

ROCKER SWITCH WITH LOCKING DEVICE

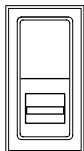

Emergency switch for drive electronics
Indicator lamp **C1.3** comes on.
(Refer to chapter 40).

ROCKER SWITCH WITH LOCKING DEVICE

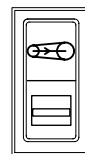

Track tensioning:

Pressed at top + unlocked: Track tensioning in operation.

Button pressed: Detension track
Indicator lamp flashes.

2 FUSES / SMALL RELAYS

Changing fuses:

Fuses prevent excessive current from entering the electrical system.



WARNING!

Risk of short circuiting and cable going on fire – do not bridge, repair or replace fuses with others with higher amp ratings!



Fuses without specification, 10 amps.

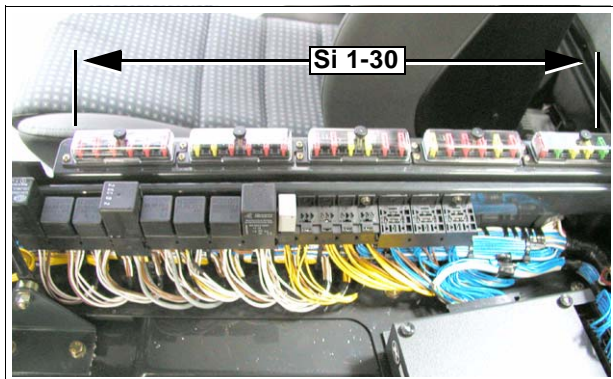

Fuse configuration (fuse):

- | | | | | | |
|----------|--------|--|-----------|--------|--|
| 1 | (10 A) | High-beam headlights and telltale | 10 | (10 A) | Steering wheel (power supply) |
| 2 | (10 A) | Low-beam headlights | 11 | (10 A) | Front snow blower |
| 3 | (10 A) | Overhead spotlight, left | 12 | (10 A) | Rear wiper, finisher board |
| 4 | (10 A) | Overhead spotlight, right | 13 | (10 A) | Front wiper, radio |
| 5 | (10 A) | Instrument lighting, parking light/tail light, right. | 14 | (10 A) | Instruments, telltales |
| 6 | (10 A) | Instrument-panel lighting, parking light/tail light, left. | 15 | (20 A) | Reversing light, searchlight |
| 7 | (20 A) | Xenon fog lights | 16 | (20 A) | Working hydraulics |
| 8 | (20 A) | Rear spotlights. | 17 | (10 A) | Flashing indicators, horn, headlight flasher, grid heater |
| 9 | (10 A) | Propulsion/snow-blower electronics | 18 | (10 A) | Start |
| | | | 19 | (20 A) | Cab heater |
| | | | 20 | (10 A) | Engine electronics |
| | | | 21 | (10 A) | Engine electronics |
| | | | 22 | (10 A) | Engine electronics |
| | | | 23 | (10 A) | 24/12 V converter, driver's seat, PB 300 central locking system. |
| | | | 24 | (10 A) | Engine electronics |
| | | | 25 | (10 A) | Socket |
| | | | 26 | (30 A) | Starter relay |
| | | | 27 | (20 A) | Voltage with engine running, mirror heating, side-window heating |
| | | | 28 | (20 A) | Rear-window heater |
| | | | 29 | (30 A) | Front windscreen heater |
| | | | 30 | (20 A) | Rotating beacon, clock, interior light |

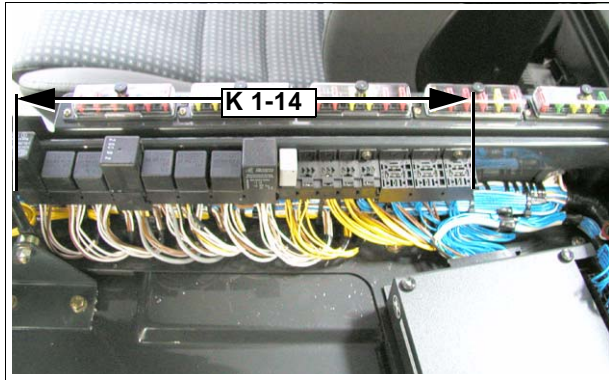

- 10-13 Front snow blower
- 14 Propulsion stage II
- 15 Emergency-Stop



Miniature relays are not interchangeable.!

Small relay (K):

- 1 Flashing indicators
- 2 Horn
- 3 Voltage with engine running.
- 4 Parking lights
- 5 Driving lights
- 6 Reversing light
- 7
- 8 Rear-window heater
- 8 Wiper interval, front wipers

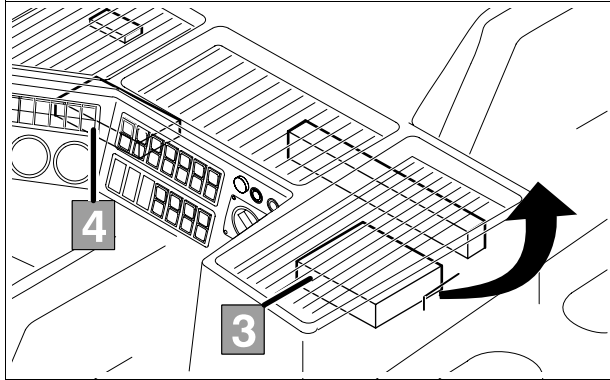

3 APPLIANCE HYDRAULICS CONTROL

4 DIGITAL DRIVING AND ROTARY PLOUGH ELECTRONICS

(refer to chapter 42).

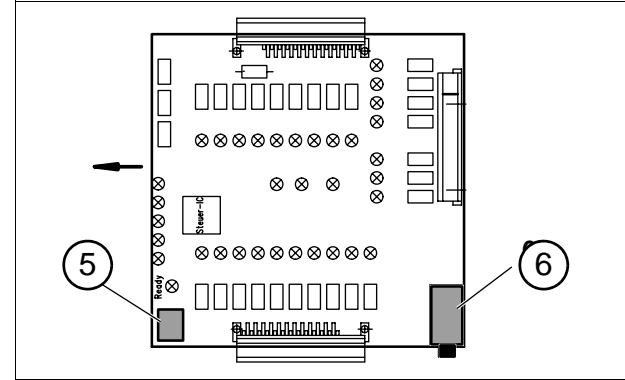

Emergency actuation of appliance hydraulics:

! WARNING!

Switch off rotary plough!

If there is a failure in the control unit, the auxiliary hydraulics should be raised using the **emergency button (5)**.

Voltage supply via the **circuit breakers 16A (6)**.

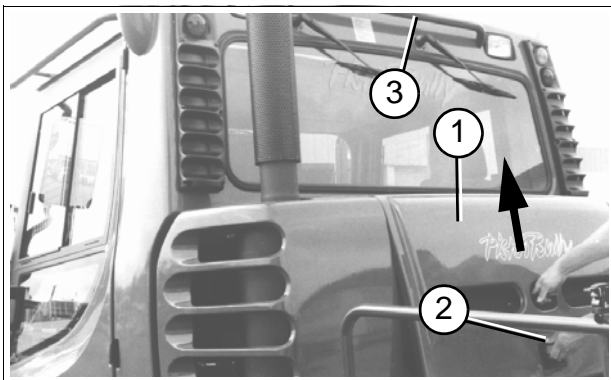

Vehicle batteries are located behind cover 1.

- Open lock 2 and, using both hands, put cover in direction of arrow.
- Re-position cover on retaining rod 3.

The batteries (2 x 12 V 135 Ah/600 A) are installed on a removable carriage on the upper frame.

WARNING!

The battery and battery carriage must be held in place using the securing device!
Never bring a naked flame close to the battery – risk of explosion through build up of explosive gas.
Do not put metal parts on the battery.

Topping up battery fluid:



WARNING!

Take care when handling battery acid – risk of burns – wear protective goggles and gloves.

- Remove screw-on lid
- Top-up distilled water to maximum mark.

Charging battery:



WARNING!

- When connecting a recharger, ensure batteries are not electrically connected to the vehicle!
Do not confuse polarity of connections.
- Do not let the terminals come into contact with one another.
- Ensure battery charge area is well ventilated (build up of explosive gas).

10893.en

JUMP LEADS:



WARNING!

If jump start is performed incorrectly, danger of fatal electric shock or burns!

- Do not let terminals come into contact with one another!
- Do not connect jump start lead to connecting bridge of both batteries.

Connecting jump start leads:

- From + pole PB battery to + pole jump start battery (24 V).
- From – pole PB battery to – pole jump start battery (24 V).

Battery isolator

The battery isolator should be actuated:

- if there is a defect on the electronics.
- to conserve the battery during long periods of standstill.



CAUTION!

Peaks in voltage.

If the engine is running, the battery isolator should only be actuated during emergencies.



CAUTION!

Data loss from the digital electronics for engine and grooming equipment.

Remedy:

- switch off ignition.
- wait 30 seconds.
- only then may you actuate the battery isolator.

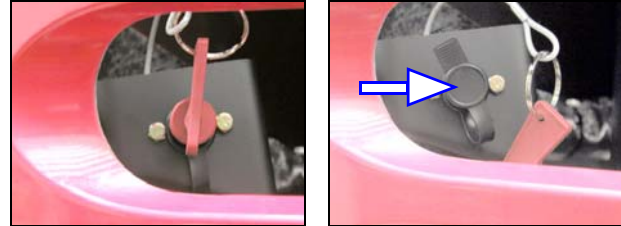

Actuating battery isolator:

- Pull off protective cap 1.
 - Plug in shift cable 2 and turn to until it snaps in.
- The battery is isolated from the electrical circuit.

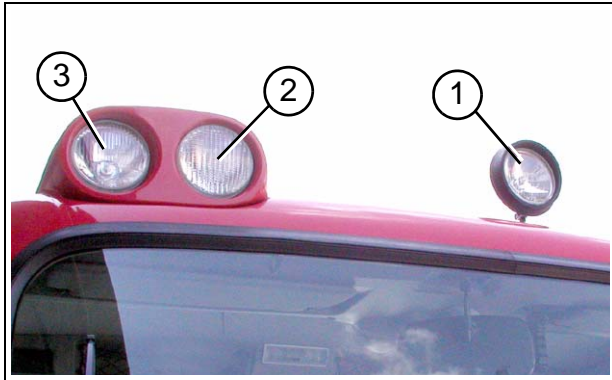
**LIGHTING:**

Do not grip halogen bulbs on glass bulb!

1 SEARCHLIGHT

2 HIGH BEAM

3 DIPPED BEAM

10893.en

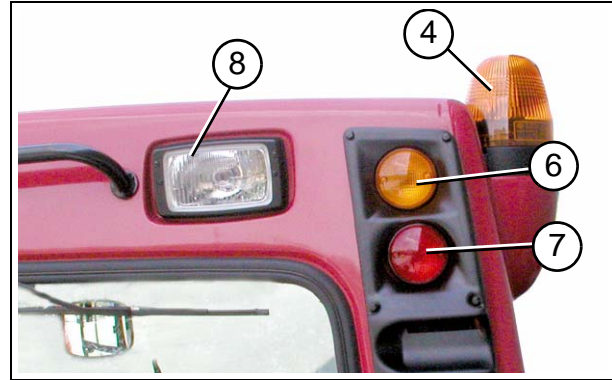

4 ROTARY BEACON

6 FLASHING LIGHTS

7 REAR TAIL LIGHT

8 REAR OPERATING LIGHTS



XENON HEADLAMP

WARNING!

**Bright light may damage eyes!
Do not look directly at the bright light.**

WARNING!

**Gases may put health at risk!
If the xenon lamp smashes in an enclosed room,
the room must be aired and not entered for at
least 20 minutes.**

CAUTION!

**Electronic damage to power supply unit!
Persistent starting problems, indicated by a flickering of the gas discharge lamp, may result in the electronics of the power supply unit being destroyed.
Switch off engine immediately if this lamp flickers!**

CAUTION!

**Risk of the glass breaking!
Do not use liquid to clean heated glass.**

- Occasionally clean glass when cold.
- Do not use aggressive or scratching cleaning agents.

Safety instructions for changing xenon lamp:

- Headlamp must always be switched off and disconnected from the voltage supply before changing the lamp.
- Do not reach into the lamp mounting.
- The electrical connection between the headlamp and power supply unit is a high-voltage connection and must not be disconnected.

- The power supply unit must never be operated without the lamp because dangerous peaks in voltage may occur on the lamp mounting and result in damage.
- Allow the lamp to cool before changing.
- Wear protective glasses and safety gloves when changing lamps.
- The glass body of the xenon lamp is pressurised (risk of shattering).
- Only handle lamp by its base.
- Only operate xenon lamp in a closed headlamp.



Dispose of the old xenon lamp as waste requiring special attention.

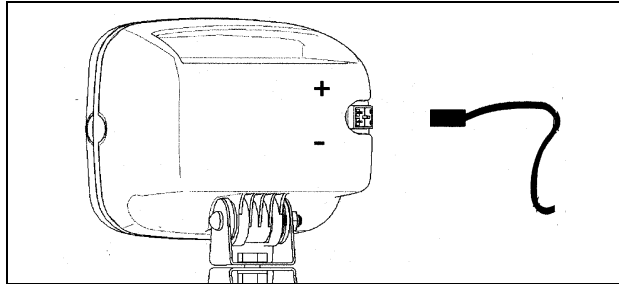

Electrical connection:

- Before connecting up, always interrupt the power supply using the battery isolator.

Only ever use the pre-installed line for the electrical connection.

Requirements for drive hydraulics to start operating:

- Driver's cab must be completely lowered and locked.
- Load bridge must be completely lowered
- Rear rotary plough must be no more than 500 mm away from the piste
- The connector for the auxiliary equipment must be connected (socket E).



Failure to observe above guidelines will lead to there being no electronically controlled speed reduction.

- Diesel engine speed must be equal to or greater than the driving off speed of 1 200 rpm.

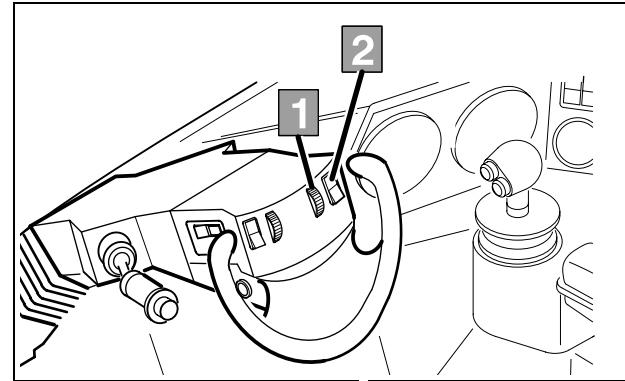

1 KNURLED WHEEL: REDUCION OF ROTARY SHAFT SPEED.

2 ROCKER SWITCH: 3. SETTING PUMP – ROTARY PLOUGH DRIVE

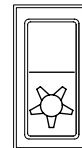

Pressed at top: **OFF**

Pressed at bottom: **ON**

Indicator lamp **C1.13** comes on.



For safety reasons, when the rear auxiliary equipment is raised to approx. 50 cm, the drive hydraulics are switched off.



If there is a leak in the drive hydraulics, always switch off the diesel engine and rectify the fault(s)!

ROTARY PLOUGH - RUNNING IN - AGAINST DIRECTION OF TRAVEL

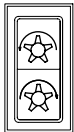

Rotary plough - running in/against direction of travel

Pressed at top: in direction of travel

Pressed at bottom: against direction of travel





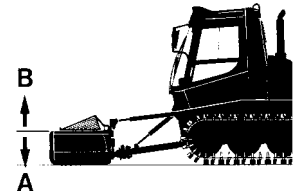
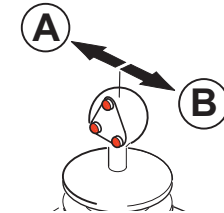
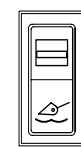
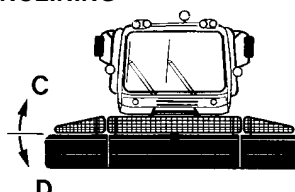
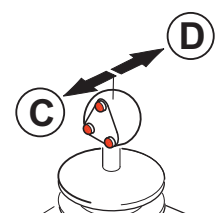
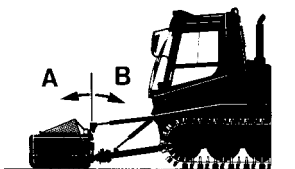
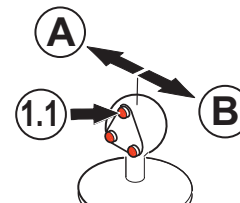

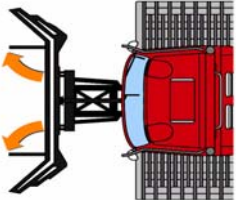

Running against direction of travel is not suited to uphill drive since this requires higher power levels.

Function	Manual throttle electrical / hydraulic	Lever setting	Pushbutton or Rocker switch	Hydraulic connection: carrier plate front
Scrapper plate RAISING - LOWERING 		A - lower B - raise	Float position. 	B1 - light grey A1 - white
INCLINING 		C - left D - right		A4 - yellow B4 - red
TILTING 		A - advance B - retract	1.1	B2 - brown A2 - light green

ACTUATION OF FRONT AUXILIARY HYDRAULICS

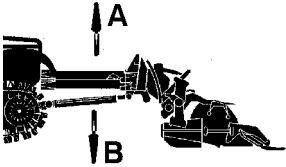
Function Scraper plate	Manual throttle electrical / hydraulic	Lever setting	Pushbutton or Rocker switch	Hydraulic connection: carrier plate at front
SWIVELING 		C - swivel left. D - swivel right.	1.1	A3 - ochre B3 -
LEFT SIDE SECTION 		A - side section, inwards. B - side section, outwards.	1.2	A6 - dark green B6 - blue
RIGHT SIDE SECTION 		C - side section, inwards. D - side section, outwards.	1.2	A5 - silver B5 - black

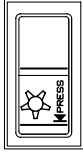
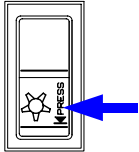
Function Front blade	Joystick electric / hydraulic	Pushbutton	Function
<p>PARKBLADE</p> 			<p>Pushbutton Top section pressed = Retract Centred = Neutral position Bottom section pressed = Extend (see Section 28)</p>

Carrier plate for rear auxiliary equipment	Action	Pushbutton or Rocker switch	Pushbutton
<p>RAISING - LOWERING</p>  <p>VARIANT 2 RAISE - LOWER</p> <p>VARIANT 2.1 1.3 pressed for longer than 1 second = Raise rotary plough Release 1.3 = Hold rotary plough in position 1.3 pressed again = Lower rotary plough.</p>	<p>Pressed at top: A - raise</p> <p>Centre setting: held in place</p> <p>Pressed at bottom: B - lower</p> <p>VARIANT 2 1.3 briefly pressed = Raise rotary plough to full 120 cm Press 1.3 again = Lower rotary plough</p>  <p>Press before rotary plough is fully raised = Hold rotary plough in position.</p>	<p>Rocker switch / pushbutton</p>  <p>Pressed at bottom: B - lower</p> 	

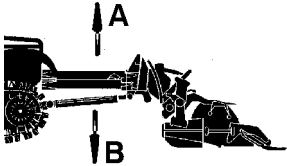
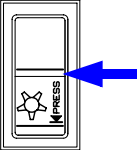
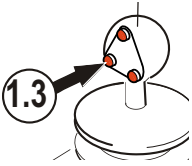
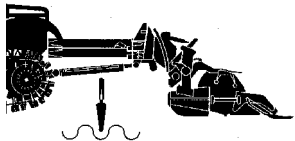
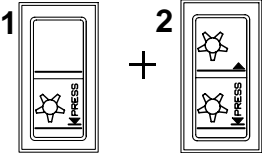
Carrier plate for rear auxiliary equipment	Action	Pushbutton or Rocker switch	Pushbutton
<p>RAISING - LOWERING</p> 	<p>VARIANT 3 Briefly press 1.3 = Raise rotary plough Press 1.3 again = Hold rotary plough in position</p> <p>VARIANT 3.1 Press 1.3 for longer than 1 second = Raise rotary plough Release 1.3 = Hold rotary plough in position Press 1.3 again = Raise rotary plough</p>		
<p>FLOAT POSITION</p> 	<p>1 Pressed at bottom: Float position</p> <p>2 Centre = rotor in floating position</p>	<p>Rocker switch</p> 	

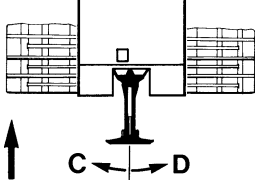
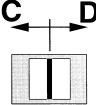
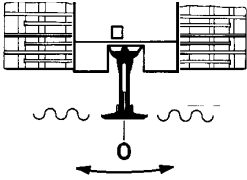
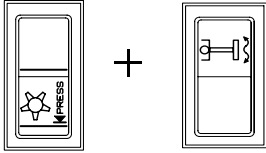
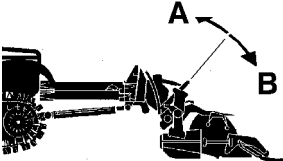
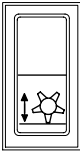
Carrier plate for rear auxiliary equipment	Action	Pushbutton or Rocker switch	Pushbutton
<p>SWIVEL HORIZONTALLY</p> 	<p>Swiveling equipment carrier to left - right</p>	<p>Pushbutton</p> 	
<p>FLOAT POSITION</p> 	<p>Pushed at top: left/right float position Centre setting: held in place Pushed at bottom: centering rear equipment carrier. Manual throttle in rest position.</p>	<p>Pushbutton</p> 	
<p>DEPTH ADJUSTMENT</p> 	<p>Pressed at top: release pressure Pressed at bottom: apply pressure Depth setting is displayed using instrument D1</p>	<p>Pushbutton</p> 	

AUTOMATICALLY RAISE AUXILIARY EQUIPMENT WHEN REVERSING:

Tilt switch (refer to driver's cab section E).

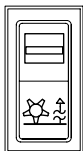

Automatic raising of auxiliary equipment at rear when travelling backwards. (Locking device engaged).

Automatic raising when not in use. Release locking device and operate switch.

Tilt switch (refer to Driver's cab section A)

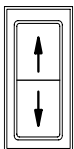

Selector switch for direction of travel

- Top depressed = **Forwards**
- Centre = **Neutral**
- Bottom depressed = **Reverse with reversing alarm!**

In tilt switch setting “**Automatic raising**”, when changing over the **drive direction switch** to “**Reverse**” direction, the following hydraulic circuits are piloted simultaneously:

- ◆ Float position for vertical and horizontal OFF.
- ◆ Carrier plate moves into central position.

- ◆ Carrier plate raises the auxiliary equipment approx. 1.2 m from the piste
- ◆ When the rotary plough is operating over 0.5 m above the piste, the rotary plough drive is switched off.

In tilt switch position “**Automatic raise**” when drive direction switch is changed over to direction of travel “**Forwards**” the following hydraulic circuits are activated together:

- ◆ Carrier plate lowers automatically.
- ◆ If a float position was engaged beforehand, this is reselected.
- ◆ When a rotary plough is fitted, it cuts back in when it is lowered to 0.5 m above the piste.
- ◆ Carrier plate remains fixed in centre position. If a different position is wished for, it has to be reselected first.

If the driver does not wish for **automatic raising** of the auxiliary equipment when reversing, e. g. when changing auxiliary equipment, the interlock on the **tilt switch** can be released and the function **Automatic Raising** can be disabled.



1 JOY STICK

2 POTENTIOMETER

Tiller down pressure/up pressure
(refer to chapter 24).

PUSHBUTTON

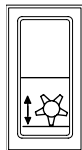

Shaft depth adjustment

Depth display given by instrument **D1**.
Refer to chapter 24

CONTROL BUTTON

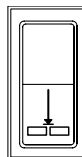

Rigid setting - multiflex

Refer to chapter 55



For safety reasons, the drive hydraulics auxiliary equipment is switched off when the rear auxiliary equipment is raised to approx. 50 cm. When using the Fun Park version, you can switch on the drive hydraulics auxiliary equipment when raised. Pay particular care therefore to ensuring that there is no-one in the danger area.

ROTARY PLOUGH SYNCHRONOUS ROTATION - CONTRAROTATION

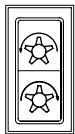

Rotary plough - synchronous rotation / contrarotation

Pressed at top: synchronous rotation

Pressed at bottom: contrarotation



Contrarotation should not be used when driving uphill because increased levels of power are required.

Switching on the rotary plough when raised

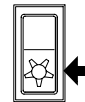

○ Rotary plough drive **ON rocker switch**

The rotary plough telltale lamp lights up.

○ Diesel speed above 1100 rpm.

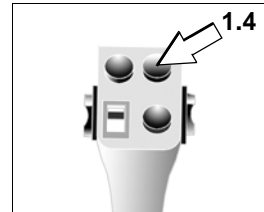

○ Button **1.4** pressed

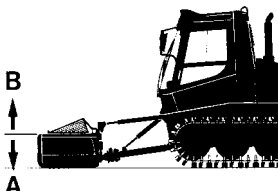
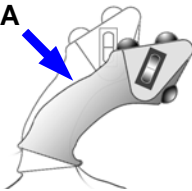
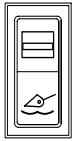
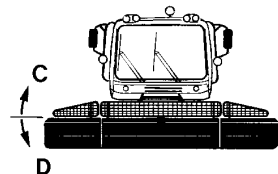
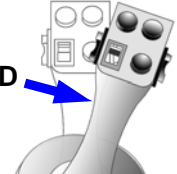
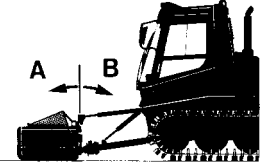
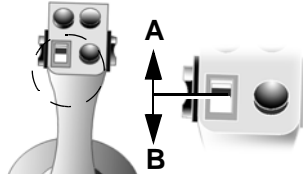
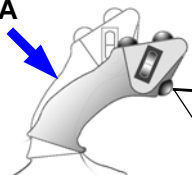

The rotary plough is switched on.

Function of scraper plate	Manual control sensor electrical / hydraulic	Lever position	Button or rocker switch	Hydraulic connection: front equipment carrier.
RAISE - LOWER 		A - lower B - raise	Float position. 	B1 - bright grey A1 - white
TIP 		C - to the left D - to the right		A4 - yellow B4 - red
TILT 	1ST VARIANT 	A - forwards B - back-wards	2ND VARIANT 	B2 - brown A2 - bright green

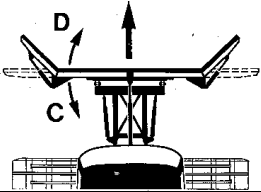
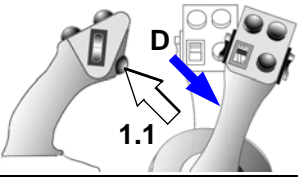
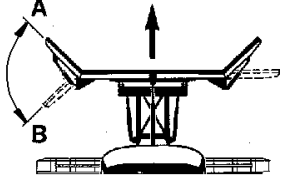
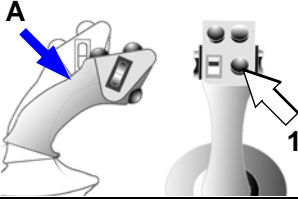
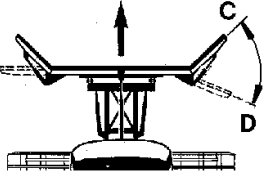
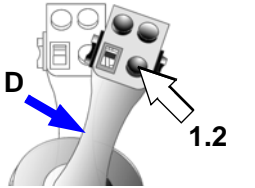
Function of scraper plate	Manual control sensor electrical / hydraulic	Lever position	Button or rocker switch	Hydraulic connection: front equipment carrier.
<p>SWIVEL</p> 		<p>D - swivel to the right. C - swivel to the left.</p>	<p>1.1</p>	<p>A3 - ocre B3 -</p>
<p>LEFT SIDE SECTION</p> 		<p>A - side section inwards. B - side section outwards.</p>	<p>1.2</p>	<p>A6 - dark green B6 - blue</p>
<p>RIGHT SIDE SECTION</p> 		<p>D - side section outwards. C - side section inwards.</p>	<p>1.2</p>	<p>A5 - silver B5 - black</p>

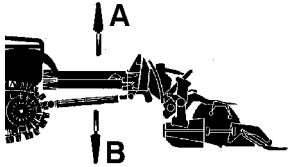
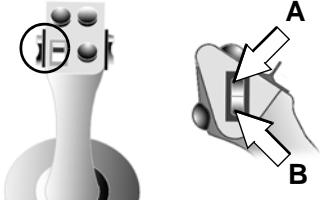
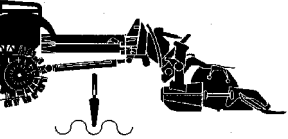
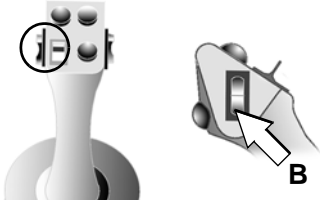
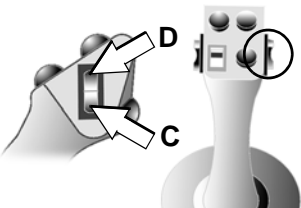
Equipment carrier for rear auxiliary equipment	Manual control sensor electrical / hydraulic	Action	Button or rocker switch
<p>RAISE - LOWER</p> 		<p>Pressed at top: A - raise</p> <p>Central position: fixed</p> <p>Pressed at bottom: B - lower</p>	
<p>RELIEVE LOAD - CONTACT PRESSURE</p> 		<p>Position B pressed</p>	
		<p>D- Pressed up = disengage rotor. Poti F2</p> <p>Centre = rotor in floating position</p> <p>C- Pressed down = engage rotor. Poti F2</p>	

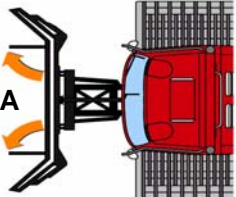
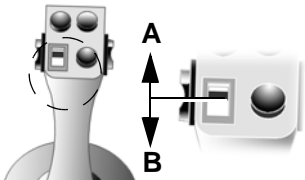
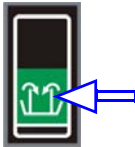
Function Front blade	Joystick electric / hydraulic	Joystick position	Pushbutton or rocker switch	Hydraulic connection: Carrier plate, front
<p>PARKBLADE</p> 		<p>A - Extend ParkBlade</p> <p>B - Retract ParkBlade</p>		

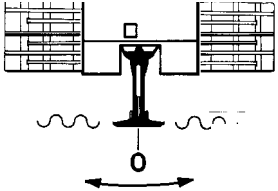
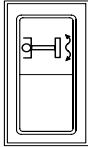
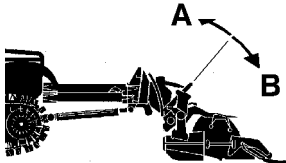
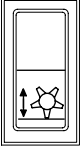
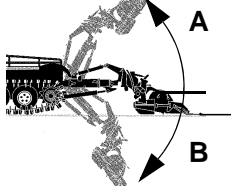
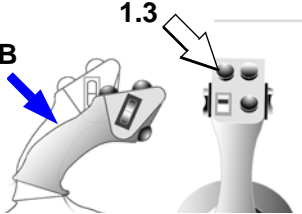
Equipment carrier for rear auxiliary equipment	Manual control sensor electrical / hydraulic	Action	Button or rocker switch
<p>FLOAT POSITION</p> 		<p>Pressed at top: left / right float position Central position: fixed Pressed at bottom: centring of rear equipment carrier. Manual control sensor in detent position (zero position).</p>	<p>Button</p> 
<p>DEPTH ADJUSTMENT</p> 		<p>Pressed at top - relieve load Pressed at bottom - contact pressure Depth setting can be viewed via instrument D1.</p>	<p>Button</p> 
<p>POWER ANGLE</p> 		<p>A- raise B - lower</p>	<p>1.3</p>

Requirement:

- Before tilting the driver's cab or the load bridge, remove any loose parts!
- Park vehicle on as horizontal a piece of ground as possible.
- Engage the parking brake.



- Switch off grooming drive .



- Move direction of travel switch into neutral position.

- Lower rear and front auxiliary equipment.



Non-compliance will result in risk of collision between load bridge or driver's cab and auxiliary equipment!

- Exit driver's cab
- Close doors



Non-compliance will result in a risk of accident caused by the doors banging shut.

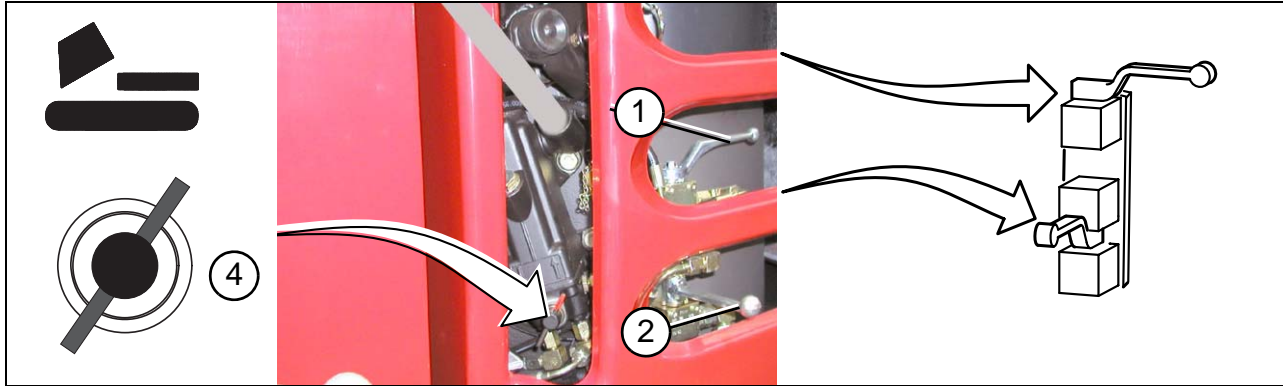

TILTING DRIVER'S CAB AND LOAD BRIDGE

- Unscrew knurled screws **3** from load bridge.
- Move lever of block ball cock **1** and **2** into position (refer to illustration above).
- Adjustment valve **4** in position. (refer to illustration above).

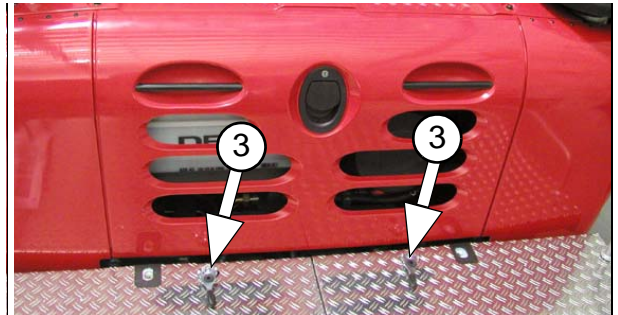

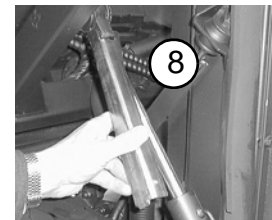
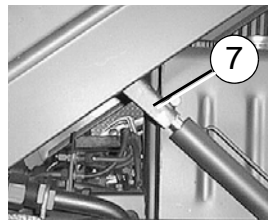
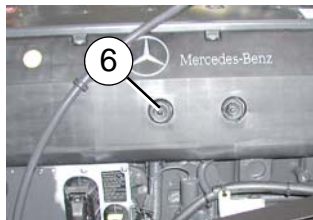

- Press button **5**
The driver's cab and load bridge are raised.



The tilting process is interrupted by releasing the button.

Indicator lamp in instrument cluster lights up. Driver's cab lock not engaged.

- Switch off the engine by pressing button **6** for stop.
- Unlock and swivel down the supports on the cylinder piston rod **7**. (Lock so that the load bridge cannot independently swivel down).

- To prevent driver's cab from lowering independently, connect bracket **8** (in service tools) to piston rod on cylinder.



Install bracket **8** as demonstrated in above Figure, otherwise the bracket and/or the cylinder scraper bar will be damaged.

LOWERING DRIVER'S CAB AND LOAD BRIDGE

- Swivel load bridge supports up until they lock into the spring clip.
- Remove bracket 8



- Turn valve lever to the left, press and turn to right until it locks.
- Press button

The driver's cab and the load bridge are lowered.
Indicator lamp goes out.

- Screw knurled screws onto load bridge.



The rear hydraulics will not function if the driver's cab lock is not engaged or if the load bridge is not fully lowered.

TILTING THE DRIVER'S CAB

Load bridge remains screwed onto intermediate console with **knurled screws**.

Further steps as when tilting driver's cab and load bridge.

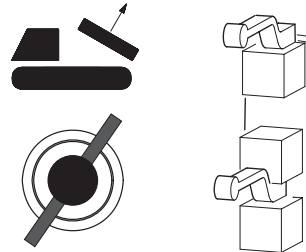

TILTING THE LOAD BRIDGE

- Move lever of block ball cock into position.

Further steps as when tilting driver's cab and load bridge.

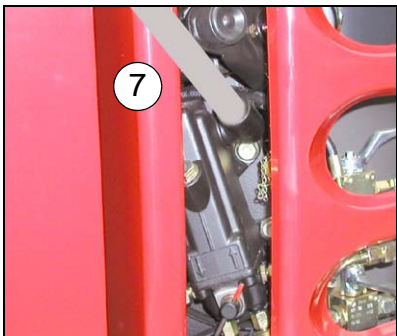

TILTING AND LOWERING WITH MANUAL PUMP

- Diesel engine OFF

Preparation as when tilting with engine hydraulics.

- Connect tube (on-board toolkit) to manual pump 7 and actuate.
- Further steps as when tilting and lowering driver's cab and load bridge.



Initiate an emergency stop:

- in dangerous situations.



The vehicle comes to a stop and cannot be steered.

- Immediately engage the parking brake.
- Move the direction of travel switch to the "neutral" position.
- Switch off diesel engine.

Operating after an emergency stop

- Turn emergency stop pushbutton **2** and pull upward.
- The PistenBully is again ready for operation.

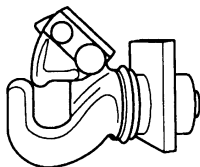

Towing the PistenBully

- Only trained, qualified persons are permitted to operate the emergency release of the parking brake.
- Towing a PistenBully is an operation requiring extensive safety measures. Please consult your nearest Service Support Center.

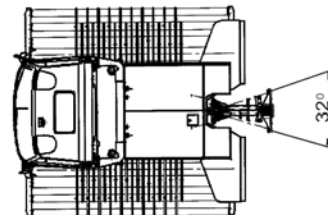

Approved load for towing hitch

Permissible towed weight

- Max. towed weight 3000 kg.
- Max. off-centre angle for descents 16° to left or right.



CAUTION!

The towed load must be secured to ensure that it cannot skew beyond the maximum permissible off-centre angle on descents or when inclines are crossed

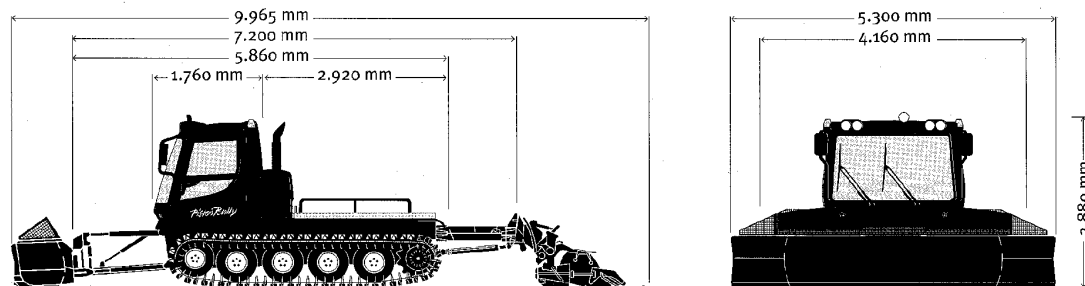

Dimensions:

Width:

without tracks	2,500 mm
across aluminium tracks	4,160 mm
across steel tracks	4,160 mm
across tiller 2000	4,900 mm
across Multiflex tiller	5,400 mm

Height 2,880 mm

Weight:

Dead weight with aluminium tracks	5,600 kg
Dead weight with steel tracks . . .	5,900 kg
Permissible gross weight with auxiliary equipment	7,400 kg
Payload of load area without auxiliary equipment.	1,500 kg

Height with cab tilted	3,325 mm		
Ground clearance	approx. 350 mm		
Load area	2200 x 1920		
Electrical:		Engine: OM 926 LA	
Light-current circuit	24 volts	Number of cylinders	6
Generator	28V / 100A	Displacement	7,200 cc
Batteries	2 x 12V / 135 Ah	Power to ECE.....	240 kW (330 ECE-HP)
Cold-start power	600 A	Max. torque	1300 Nm/1200 rpm
Operating parameters:		Oil capacity with filter	23 l
Continuously variable speed . . .	0 - 20 km/h	Fuel consumption approx.	16 - 18 l/h
Spec. ground pressure with alumin- ium tracks	0.042 kg/cm ²	Tank capacity	190 l
Spec. ground pressure with steel tracks	0.044 kg/cm ²	Brakes:	
Production rate with tiller	81,000 m ² /h	Wear-free (hydrostatic)	
Garage:		2 multi-plate brakes	
Suggested garage dimensions			
Length	11,000 mm		
Width	6,000 mm		
Height	3,500 mm		

PERMISSIBLE WEIGHT RANGE OF FRONT ATTACHMENTS

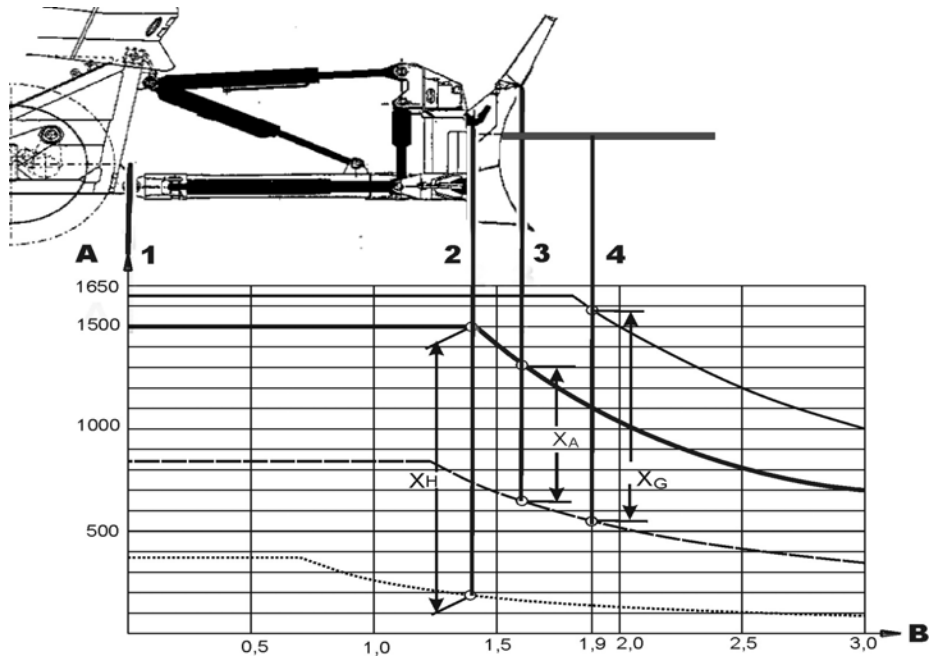

Key:

A = Counterweight (kg)

B = Projection (m)

- 1 = Pivot point
(main frame, quick-change system).
- 2 = Hook plane, quick-change system
- 3 = End face, front blade centre
- 4 = Fork, length 400 mm (ParkBlade)

- _____ Maximum short-term attachment moment under restricted operating conditions (M = 30000 Nm).
Maximum long-term attachment moment (M = 21000 Nm)
- Max. long-term attachment moment (M = 2100 Nm)
- Attachment moment of the quick-change system with front blade (M = 10350 Nm)
- Attachment moment of the quick-change system (M = 2600 Nm)

Example:

Attachment at hook plane, quick-change system **2**
 $X_H = 1315$ kg maximum long-term attachment weight.

Attachment to quick-change system with front blade **3**
 $X_A = 665$ kg maximum long-term attachment weight.

Attachment to fork **4**, length 400 mm
 $X_G = 1000$ kg maximum short-term attachment weight.

Safety instructions

- Attaching excessively heavy machinery or machinery with an excessively high moment voids the vehicle manufacturer's warranty and excludes liability on the part of the vehicle manufacturer. The only exceptions to this rule are those items of auxiliary equipment for which the vehicle manufacturer has issued approval.

Short-term attachment moment under restricted operating conditions:

- Speed for transport and operation limited to max. 10 km (set potentiometer A7 to position 7 on the scale).
- The high moment of the auxiliary equipment restricts the manoeuvrability of the vehicle, so the route to the work zone must be through easily accessible terrain.
- It is essential to comply with the instructions regarding the transport position of the auxiliary equipment (see the operating instructions for the auxiliary equipment).
- Operation with an item of auxiliary equipment is restricted to the intended purpose and is subject to the limit of the time required for said purpose (short-term).

Safety instructions, ParkBlade**WARNING!**

**Risk of injury by crushing:
when extending / retracting the forks.
Make sure there is no-one in the danger zone.**

- The transport of persons is prohibited.
- Do not permit the load to obstruct the driver's field of vision.
- The load must be adequately secured to ensure that it cannot shift.
- Always retract the forks when they are not needed.
- When the forks are extended, the side section of the front blade must be pivoted all the way out.
- Alterations to the forks are prohibited.
- The load must be suitable for lifting with the forks.
- Make sure that the weight of the load is evenly distributed across both forks.
- Risk of toppling.
Check the terrain and make sure it is suitable for driving.
- Reduce speed to allow for the extra weight of the equipment.

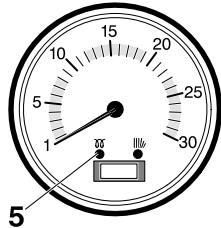
**STARTING ENGINE:****WARNING!**

Additional starting aids (e.g. start pilots) are not permitted due to the risk of explosion

- Apply parking brake
- Direction of travel switch in neutral position.
- Switch of electrical consumer.
- Turn ignition key to stage I
 - ◆ The telltales light up:
 - ◆ Load telltales
 - ◆ Engine oil pressure control
 - ◆ Brake venting check

- ◆ Engine control
- ◆ Intake air preheating
- ◆ Intake air preheating hazard warning light

Situational help

The warning light for air-intake preheating may stay lit for up to approx. 3 minutes after the engine starts.

**CAUTION!**

Damage to electronics

If the warning light for air-intake preheating lights up during operation:

- Cease operations and proceed to the nearest workshop.
- Switch off the battery master switch.

Start procedure

- Ignition ON



Depending on the ambient temperature, the intake-air preheating light goes out after approx. 2 seconds (no preheating) or within 30 seconds (maximum preheating time).

When the intake-air preheating light goes out:

- Start the engine
- Do not depress the accelerator pedal.
 - Operate the starter until the engine is turning at 700 rpm
 - maximum duration of start attempt 30 seconds

Engine refuses to start:

Immediately repeat the start attempt (do not repeat the preheating procedure).

Duration of start attempt, max. 30 seconds

If it is necessary to repeat the reheating procedure:

- Ignition OFF
- Wait for 5 - 10 seconds
- Ignition ON

10893.en

WARMING-UP PHASE:

Air temperature between 0° C and -20° C



- Let diesel engine run (idling while stationary) for approx. 3 minutes.
- Drive off using partial throttle.
- Full throttle can be used as of a coolant temperature of + 80° C.

Air temperature below -20° C



- Let diesel engine run (idling while stationary) for approx. 6 minutes.
- Drive off using partial throttle.
- Full throttle can be used as of coolant temperature of + 80° C.

RUNNING-IN SPECIFICATIONS:

Up to 40 operating hours

Run in with care, only using a max. of 3/4 full throttle speed

From 40 operating hours

Slowly increase to full power

MOST FUEL-EFFICIENT ENGINE SPEED RANGE:



The diesel engine consumes minimum levels of fuel at the range between 1200 and 1600 rpm (green range in tachometer).

On steep gradients:

- Select engine speed outside favourable engine speed range.

Driving on extreme conditions of terrain:

- Use potentiometer **A7** to reduce driving speed.

The speed of the auxiliary equipment remains constant.

PistenBully slows down because of reduced drive performance:

- Switch auxiliary equipment to synchronous running mode.
- Reduce speed of auxiliary equipment with potentiometer **A8**.



NOTES

<hr/> <hr/> <hr/> <hr/> <hr/> <hr/> <hr/> <hr/> <hr/> <hr/> <hr/> <hr/> <hr/> <hr/> <hr/>	<hr/> <hr/> <hr/> <hr/> <hr/> <hr/> <hr/> <hr/> <hr/> <hr/> <hr/> <hr/> <hr/> <hr/> <hr/>
---	---

Driving



Set diesel engine speed
Idling while stationary 800 - 900 rpm



WARNING

When the engine idling speed is above 1000 rpm, the vehicle cannot brake down to a standstill.



Before setting off, ensure that there is no-one in the danger area.



On full steering lock, the Pisten Bully executes a pivot turn.

- Tip direction of travel switch into the direction of travel required: when reverse travel is selected, an acoustic signal sounds (reverse travel alarm).



The driver must still check behind him, even though the vehicle is fitted with a reverse travel alarm. When driving backwards, always keep an eye on the area behind the vehicle.

- Use the accelerator to increase the engine speed above the engine speed when setting off: the Pisten Bully starts to move.

As engine speed rises, the Pisten Bully will accelerate, up to maximum speed if so desired, doing so in direct proportion to engine speed and the electronically controlled hydraulic ratio of the hydrostatic drive unit.

During operation, the electronic control unit monitors the engine speed set by the accelerator and selects the most appropriate hydraulic ratio for engine load so that the set engine speed remains at a constant level and only the vehicle speed changes.



WARNING

When steering, ensure that the right and left drive hydraulics are switched to contra-rotation just before full steering lock. This causes the Pisten Bully to execute a pivot turn.

- Watch the instrument panel when driving!

Engine oil pressure: If there is a drop in oil pressure or if the diesel engine is switched on, the warning light is lit up.

- If there is a drop in oil pressure when driving, stop immediately, switch off engine and look for cause (not enough oil in the oil pan?).

Engine operating temperature: Engine operating temperature is approx. 90 °C. Maximum temperature must not exceed 95 °C!

- If the engine remains at this temperature, locate cause. (Is display unit operating correctly? Not enough coolant in system? Is outside of radiator dirty? Tension in vee belt? Viscous fan?).
- **Fuel level:** Check fuel level at regular intervals and

top-up when necessary. This will prevent fuel running out when negotiating steep slopes where the engine might cut out at a bad time.

- **Battery charge telltale:** If battery charge telltale lights up when engine is running, alternator is no longer charging the starter batteries. Find cause and repair damage (loose cable connections? Alternator dirty? Belt slipping or torn?).

Warning light hydraulic oil level: Occasional flashing when driving downhill does not indicate a fault.

- **Parking brake telltale:** When telltale lights up, check parking brake.

Braking and stopping:

The vehicle is braked without mechanical wear using the hydrostatic drive. By releasing pressure on the accelerator, the engine speed drops, the hydraulic ratio changes and driving speed is reduced.

If the engine speed falls below the initial speed, both variable displacement pumps of the drive electronics will go back to the zero position and the Pisten Bully will come to a halt.



WARNING

Do not operate direction of travel switch when driving or the PistenBully will brake to a complete stop.

A parking brake which controls both drive wheels has also been added (spring accumulator brake) which is operated with the hand lever.



WARNING

Only use parking brake as a handbrake, i.e. when stationary. Do not stop or park in areas outwith field of view.



WARNING

Before leaving PistenBully, always apply parking brake, move direction of travel switch into neutral position and lower the auxiliary equipment.



WARNING

If engine cuts out for whatever reason, apply parking brake immediately.



NOTES



CAUTION!

Turbocharger - risk of overheating!

Do not immediately switch off the diesel engine if it has been run with a full throttle. Drive using partial throttle for approx. 2 minutes and then switch off.

- Lower auxiliary equipment, switch off rotary plough.
- Direction of travel switch to "neutral".
- Apply parking brake.
- Before switching off the engine, let it run at idling speed for approx. 1 – 2 minutes (prevents coolant overflow).
- Do not leave the engine running if it is not attended.



WARNING

Risk of poisoning from exhaust gases.

Do not leave engine running in an enclosed area.

- Switch off engine by actuating ignition key.
- Enter journey details in log book
- Remove ignition key and lock cabin.



WARNING

Risk of slipping on the track when climbing into and out of driver's cab.



WARNING

**Risk of injury: PistenBully with sticks.
Raise the driver's seat armrests/sticks before exiting the cockpit**



WARNING

When parking in sloped areas, be particularly careful when opening the door. The door opens at an angle.

- Refuel the PistenBully straight after travel to prevent condensate forming in the tank.
- Then remove as much snow and ice as possible from the tracks, driven wheels and drive wheels to prevent them freezing fast and possibly thereby preventing damage when next starting up the machine.

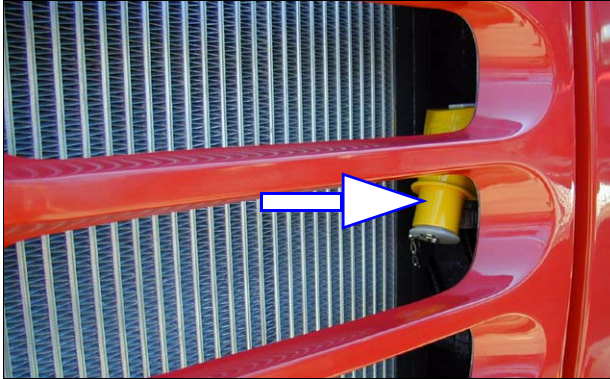

The 1 - 2 hours of preheating before a start does not improve the cold start. Undertake preheating immediately after parking the vehicle.



Only use external power supply units which comply with national legislation.

- Secure raised auxiliary equipment.
- Connect coolant preheating (special equipment).

The connection to the external power source 1 110/220 V provides the option of using the thermostatically controlled preheater to heat up the coolant system and/or preheating the hydraulic fluids as an additional feature.

SUMMARY OF ECONOMICAL DRIVING

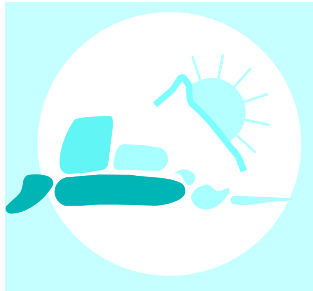

Low fuel consumption/low pollutant emissions

- **Diesel engine speed** 1,200 – 1,800 rpm (green range in tachometer). Max. torque 1,100 Nm at 1,300 rpm.
- **Use potentiometer to regulate rotary shaft speed (infinitely variable)**, taking due account of snow conditions. Max. level control of rotary pump at 1,400 rpm.

- **Use button and instrument cluster to adapt shaft depth** to current snow conditions (infinitely variable). Do not plough at a greater depth than is absolutely necessary.
- **Use control potentiometer to adjust contact pressure exerted by rear-mounted attachment on snow.** Drive at the minimum pressure the current snow conditions will allow.

MEDIUM SNOW

Snow is formed from water droplets in the atmosphere at temperatures of -4°C or below.

Ice crystals form in a range of different shapes:

Sleet consists of snow crystals which are enlarged by being covered by ice. They are usually either round or cone-shaped.

Rime is the result of water vapour and precipitation on very cold objects (fences, hedges, surface of snow).

Hoar frost occurs when very cold water droplets are deposited by wind on solid objects.

Fresh snow initially forms a crystalline structure containing a lot of air which bonds to a greater or lesser extent.

However, the original forms are already beyond recognition a few days after any fresh fall of snow.

Certain natural changes cannot be controlled (shrinkage results from the combined effects of wind pres-

sure, freezing and evaporation; volume increases due to the temperature gradient i.e. the temperature differential between surface of ground below snow layer and air temperature at surface of snow). Nevertheless, always comply with the following guidelines:



When working with snow, cause as little damage as possible. The crystalline structure of snow breaks down completely if worked on too aggressively with auxiliary equipment e.g. the rotary plough. It loses its bonding capacity and turns into slush (all too familiar in the entries to garages and lifts and confined spaces).

Grooming of new snow

New snow/powder snow consists of loosely connected snow crystals which therefore include a lot of air. The grooming process removes some of this air and compresses the crystals. This results in a snow layer capable of bearing weight.

Mogul pistes

Some of the crystals melt due to the film of water created by passing skiers. This results in ice patches and softer areas.

When the uppermost layer is broken in the course of time by the skiers, mogul pistes are formed.

When these pistes are groomed, older and relatively "fresh" snow (snow crystals) are mixed, which results in long snow durability.

At sufficiently low temperatures, the snow freezes into lumps – **when this happens, only the rear-mounted rotary plough can create an aesthetically pleasing piste.**

The shaft's teeth break the lumps up into slush which fills the hollow areas at the piste's surface. The slush is made aesthetically pleasing by the finisher and is bonded by the formation of water film. The crystalline structure is also destroyed when lumps are broken up. Only a limited amount of bonding can take place. Therefore, only ice slush and never powder snow can be created from ice.



Only a mixture including fresh snow or untouched older snow which lay beneath the snow's surface can produce a durable piste.

Ice pistes/ice sheets

Only break up an ice piste if layer is sufficiently deep or if fresh snow has fallen. The slush thus formed can only bond with new snow or with water – in this case turning back into ice. Therefore, we recommend that you only roughen up the surface of ice pistes to make them navigable again for skiers. You can work on ice sheets on otherwise good pistes by mixing them with underlying snow crystals.



The more the snow is tilled and the crystals destroyed, the less they will bond.

Wet snow/Sugar snow

High levels of humidity and the water film build up on the finisher can lead to a relatively hard surface which causes great difficulties to less experienced skiers.

Therefore, Kässbohrer has created the angled setting option of the rear-mounted attachment. Special finishers can alter the uniform surface structure and thereby create a "powder snow" effect.

Extreme sugar snow in spring

We recommend the use of the smoother here because driving the rotary plough might cause snow to bank along the edges. For more effective use, Kässbohrer offers an extra wide smoother with side swivel option – this enables you to groom the piste to either side of the Pisten Bully in turn.

If **sugar snow** prevents you from creating optimum piste conditions, we recommend that you wait for two to three hours until temperatures change again. In the meantime, you can groom pistes at different altitudes.



Leave snow so that crystals can be formed.

CONVERSION TABLE % (PERCENT) IN \angle° (DEGREES)

Generally, you talk about the angle of a piste in percent.

1 = CANNOT BE DRIVEN ON WITH PB.

GRADEABILITY

Pisten Bully's ability to climb depends on snow's limit of adhesion. The machine's centre of gravity also affects gradeability. It is important that the driver should ensure that as much of each track as possible is in contact with snow, otherwise there is a risk of the Pisten Bully tipping over. The danger limits largely depend on use, payload, prevailing conditions of terrain and the skill of the driver.

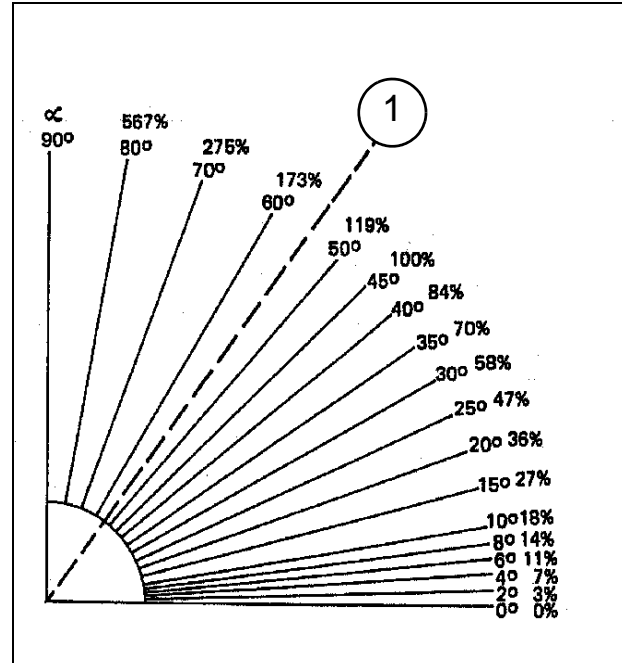

S = CENTRE OF GRAVITY

H = GRAVITY EXERTED BY SLOPE



Carefully consider every situation of potential use. Never assume that simply because a vehicle has driven on certain terrain, that the same terrain can be driven on now.

Learner drivers should first acquaint themselves with the vehicle before attempting difficult tasks

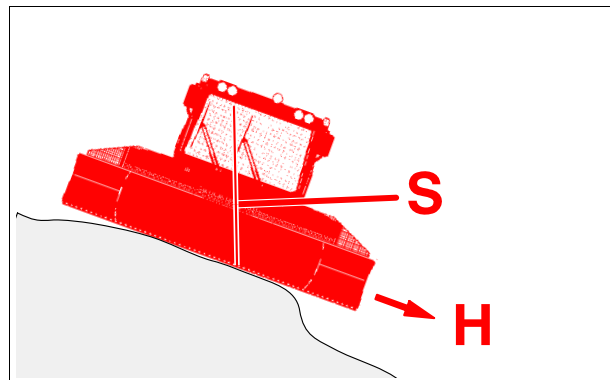
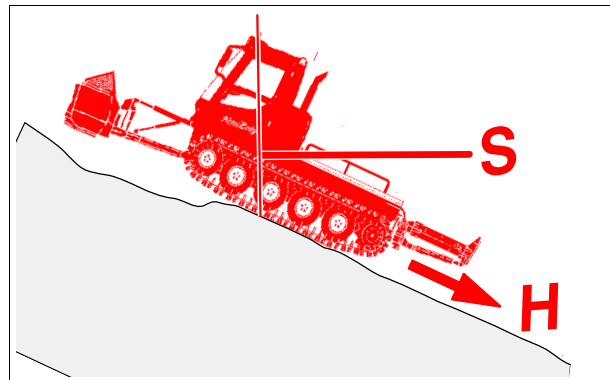

DRIVING WITH THE PISTENBULLY



The basic rule of thumb is: Only drive on snow-covered areas where it is not possible to damage the turf.

The aim of piste preparation is to create a quality of piste which is aesthetically pleasing:

At critical locations, build up reserves of snow in good time which can be used to patch up thin areas.

When driving and turning, smooth out any holes or bumps created straightaway.

If you drive too fast, the tracks and auxiliary equipment will throw snow to one side, covering the piste you have already groomed.

Remove all snow from the load platform at regular intervals. This reduction in weight helps to improve fuel economy.

Always drive in the fuel-efficient engine speed range (marked in green on tachometer).

The drive electronics ensure that vehicle speed is matched to prevailing engine speed.

Driving: Uphill

Always look for the easiest point to set off before driving uphill. Do not set off at the steepest point. It is often better to reach the slope's summit via a detour and to groom the first lane from top to bottom.

Where possible, drive on slopes up the fall line and keep steering to a minimum.

Never drive with more engine power than is necessary; ensure good track grip (traction). Excessive engine power causes tracks to spin and vehicle will dig itself in. If tracks begin to dig in, stop immediately and look for a new route.



Digging in destroys the piste and base of the slope.

Turning

To preserve the piste, turn at its edge or outside the skiable area. Look for turning areas where there is no vegetation (do not use protected areas or any similar areas.)

Before turning, always raise the auxiliary equipment at the front and back!

Turning using contra-rotation:

Contra-rotating the tracks allows vehicle to execute a pivot turn. Because this makes the machine dig in slightly, only use this method for turning when there is sufficient depth of snow. We recommend that you use this form of turning only in exceptional circumstances. Pivot turns exert very high loads on the rubber track belts and track cleats.

Driving: downhill

When driving downhill, ensure that you are driving at moderate speed. This stops the engine from over-revving, the machine from drifting off out of control and the snow from being torn up. If necessary, reduce vehicle speed using the drive speed.

When driving, keep steering to a minimum. Ensure

that both tracks are turning.

When driving over bulges, reduce speed so that Pisten Bully's forward tilting can be controlled. This ensures that the scraper plate does not "stick in" and the tracks do not spin.

Only drive down slopes after ensuring that:

- snow adhesion is good enough.
- there is a safe runout from the base of the slope.
- there are no skiers in the danger area.

If, when driving downhill, Pisten Bully slides and drifts off to the right or left (i.e. if the longitudinal axis is at an oblique angle to fall line), immediately steer in the opposite direction until tracks start to contra-rotate (move steering wheel to left or right limit position.) This will bring the longitudinal axis back into the same direction as fall line. Also increase engine speed for a short time. If vehicle slips in the fall line, reverse the direction of rotation of the rotary plough and carefully lower the scraper plate to slow down the slipping motion to the point where the vehicle has stabilized once again.

WARNING

Failure to comply with the following procedure entails a risk of an accident because the vehicle would be able to set off at any time without warning.

- Apply parking brake!
- Shift direction of travel switch into neutral position.
- Turn vehicle speed potentiometer to 0.

WARNING

Vehicles equipped for a Kahlbacher rotary plough:

When you actuate the steering wheel, the vehicle will move, even if the vehicle speed potentiometer is set to "0". For this, the accelerator pedal must raise engine speed to a value exceeding the drive-off speed and the direction of travel switch must be actuated.

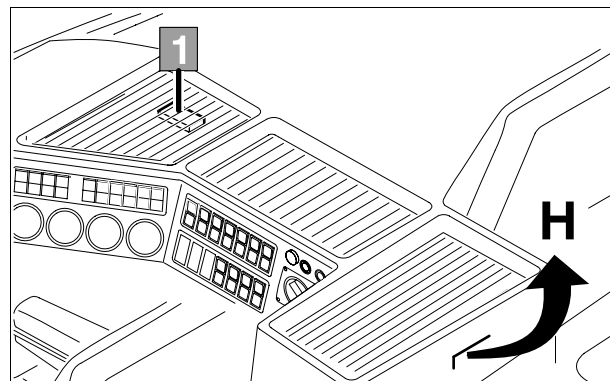

- Fold up centre console **H**.
- Unlock the tilt switch **1** "Emergency mode" and switch to manual control – the telltale C1.3 lights up.
- Switch on diesel engine and increase speed to approx. 2,000 rpm.
- Move direction of travel switch into the desired direction of travel.
- Release parking brake.

- Slowly turn vehicle speed potentiometer to 9 – the Pisten Bully starts to move off.



WARNING

If the electronic control unit fails, you are only permitted to drive as far as the nearest workshop (in emergency driving mode).

- Only drive at low speed. Here, pay attention to engine speed: The engine can be stalled by reciprocating loads (i.e. alternately depressing and releasing the accelerator pedal).
- To brake, turn back the vehicle speed potentiometer.



WARNING

Putting direction of travel switch to neutral position brings vehicle to a halt!



WARNING

When engine stops, immediately apply parking brake.

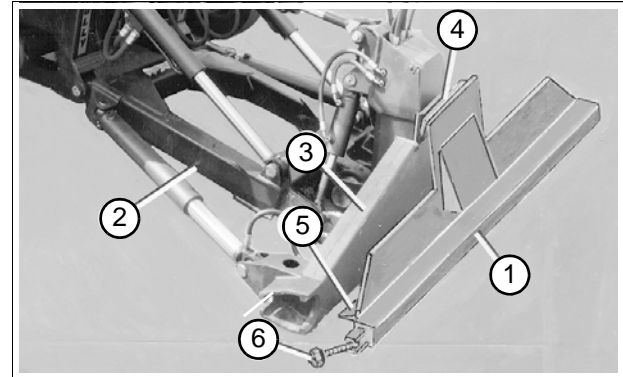
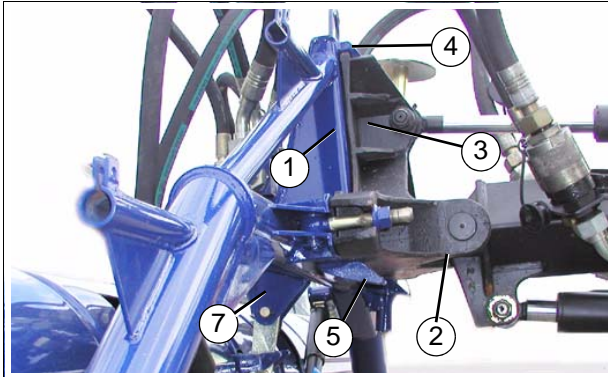

Fitting auxiliary equipment

- Clean snow and ice off equipment attachment plate and centring head of auxiliary equipment.

WARNING

Ensure that no one is between the vehicle and auxiliary equipment when engine is running!

- Lower the equipment carrier or the mounting for front-mounted equipment 2.

- Tilt the attachment plate 3.
- Drive PistenBully up to the auxiliary equipment, which should now be ready to attach.
- Apply parking brake.
- Slowly raise equipment carrier and/or mounting for front-mounted equipment 2.

The attachment plate 3 locates in the mounting hooks 4, the equipment attachment plate 1 closes in against the attachment plate 3 and, at the same time, centres itself on the two centring tapers 5 on the attachment plate 3.

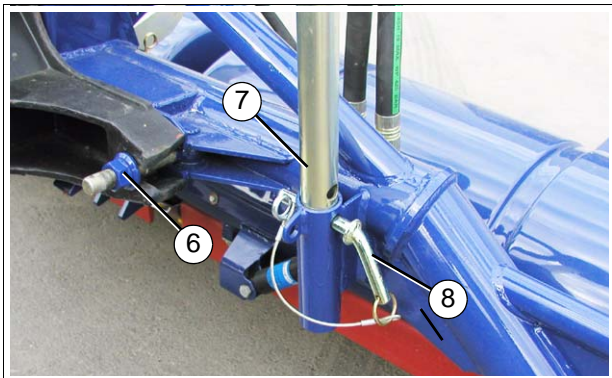

- Only raise equipment carrier and/or mounting for front-mounted equipment **2** until the auxiliary equipment makes contact with the attachment plate **3**. If the centring tapers **5** do not slide under the attachment plate **3**, you can jolt the auxiliary equipment into the correct position by a series of brisk movements. Switch off engine!
- Swivel eye bolts **6** inwards and tighten down nuts (tightening torque 250 Nm).



WARNING

After operating the equipment for approx. 10 minutes, tighten the nuts down again!

- Unlock the support, swivel support base **7** completely upwards and secure with pin **8**.
- Lower auxiliary equipment



Remove rear auxiliary equipment in protracted over-run operations

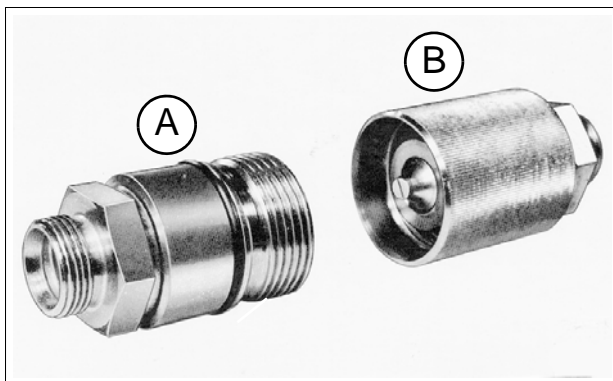

Connect up hydraulic coupling for auxiliary equipment.

The screw-mounted **high-pressure couplings** are used for connecting and separating filled lines. When the couplings are opened/closed, valves are actuated automatically. They open up or close down the flow of hydraulic fluid. To link up the high-pressure coupling between the coupling connector and the coupling sleeve, screw down the hand-tightened nut on the connector section as far as the mark.

A = vehicle end
B = equipment end

WARNING

Before linking up/disconnecting auxiliary equipment, always: switch off engine! Apply parking brake!

- depressurise hydraulic lines by actuating the appropriate functions.



When connecting up couplings, ensure that both ends of the coupling are completely clean.

- Connect up hydraulic hoses, ensuring that colour codes are matched up and that the hydraulic couplings are perfectly seated. Tighten down hydraulic couplings using suitable tools.
- Insert electrical connector of auxiliary equipment in the receptacle of the Pisten Bully and tighten down firmly. The connector closes the electrical circuit which detects the presence of auxiliary equipment.

- Function test of auxiliary equipment.



WARNING

No one in danger area!

- Check auxiliary equipment for oil leaks and, if necessary, have it repaired by trained staff.

Removing auxiliary equipment

- Lower auxiliary equipment onto firm, level ground with jockey struts folded out and locked in position.
- Auxiliary equipment is removed in reverse order to the installation sequence.



If the auxiliary equipment stands outside for protracted periods, protect it from direct sunlight.

When grooming the piste, ensure that the side finishers overlap the groomed piste to ensure there is a seamless transition from one grooming track to the next.

Notes on ploughing depth:

Correct setting of rotary shaft depth yields the following benefits:

- aesthetically pleasing piste.
- an undisturbed firm base under piste.
- optimum fuel economy.
- minimum stress and strain for the Pisten Bully and rotary plough.

The effects of incorrect setting of rotary shaft depth:

- Insufficient shaft depth: plough does not perform.
- No signs of piste grooming on hard areas.
- Excessive shaft depth: not enough snow passing through the plough blades, causing snow to flow to either side of the plough where it forms side walls.

- Bonding of snow crystals and the quality of the base are adversely affected.
- More engine power required – uneconomical.

Contra-rotation in rotary plough shaft:

On Pisten Bullys with electronic rotary plough regulation it is possible to run the plough shafts backwards as well as forwards (standard direction of rotation).



Reverse direction can, for example, be employed as a braking aid when descending steep sections of terrain.

Operator errors and remedial action

Summary of remedial action:

Build-up of side-walls on left and right:

- Vehicle speed too high.
- Speed too high.
- Depth setting too deep.

- Contact pressure setting selected instead of float setting.
- Cylinder on equipment carrier misaligned.
- Rotary shafts stationary.

Piste not in aesthetically pleasing condition – only partly prepared:

- Rotary plough set too high (shallow depth setting).
- Engine speed too low.
- Lever not in detent position (float setting).
- Vehicle speed too high.
- No flat surface with U-scraper plate (rotary plough standing on a bump).

Vehicle is at a near standstill, engine under load:

- Rotary plough too deep.
- Speed too high.

- Cylinder on equipment carrier accidentally misaligned.
- Contra-rotation.
- Rotary plough shafts stationary – blocked, jammed, frozen over.

High levels of vibration in vehicle after rotary plough is switched on:

- Shaft not balanced, tooth broken off – arrange for trained staff to repair it.
- Snow frozen onto surface – remove it.



WARNING

Imbalance causes vibration – the screws become loose, the bearings are damaged – rectify imbalance!

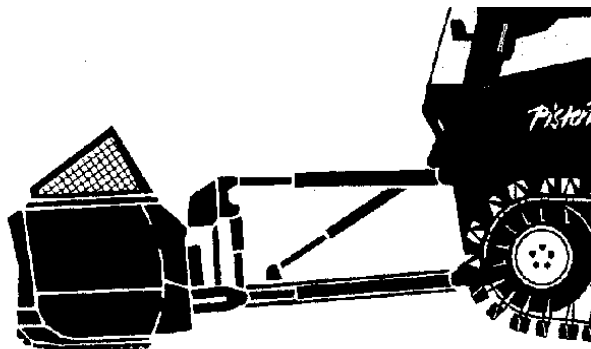

Applications:

- Use of scraper plate on steep slopes of fresh snow
- Levelling washed out pistes
- Levelling mogul pistes
- Making a track



CAUTION!

During bulldozer work (i.e. when pushing snow with ploughblade), fully raise rear device carrier.

To perform modern piste-grooming activities, these vehicles have to be fitted with a front – mounted scraper plate.

This plate can be used to level mogul pistes and to move aside snow. In addition, the scraper plate is an important climbing aid on fresh snow. It also protects the vehicle from slipping backwards. For this reason, never remove the scraper plate.

Levelling mogul pistes

To level low moguls or undulations, drive with the scraper plate in what is referred to as the float setting. In this setting, the scraper plate is only just in contact with the ground – no hydraulic pressure is applied.

The tilt cylinder is used to set the scraper plate into a range of progressively more "aggressive" operating positions. This must be done very carefully since, if the blade is tilted too sharply, it would dig into the ground too deeply.

Drive at large moguls at about half-height, and not in float setting, to ensure that snow drops forwards into the depression behind each mogul. We recommend that you set cutting depth with tilt cylinder here also, instead of by raising and lowering the scraper plate. This will ensure that you leave a smooth piste in your wake.



Under ideal conditions, a roll of snow forms in front of the scraper blade which automatically compensates for any irregularities in the surface of the piste.

Making a trail

The best idea is to approach any slippery slope from above at an oblique angle, and to create a flat track with the scraper blade swivelled to one side.

It is advisable to start with very little snow, gathering more snow as you proceed forwards. In this way, you can make your way across the entire width of the piste. The snow pushed out towards the valley inevitably widens the track and makes the route safer for skiers.

Use of scraper plate on steep pistes covered with fresh snow

When grooming fresh snow, you need the scraper plate both to push the snow and also to achieve good distribution of weight and uniform surface pressure.

You can use the scraper plate as a climbing aid on steep slopes by briefly bringing Pisten Bully to a halt just before it digs in and then reversing with scraper

plate lowered. This flattens the step. When setting off again, you can drive for several metres with scraper plate raised in order to overcome inclines which are difficult to negotiate.

Levelling washed out pistes

A consequence of modern skiing is that skiers tend to wear away the snow layer, causing it to accumulate at the bottom of pistes. The aim of piste-grooming is to cover the piste with a blanket of snow which is as uniform as possible. To do so, the snow must be pushed back up the slope. If required, use Pisten Bully with a winch.

When the scraper plate is swivelled, an oblique setting is created. The snow can slide off and get between the vehicle and its scraper blade. This lateral build-up problem can be improved by adjusting the side wings of the 12-way scraper plate to an appropriate angle. By using the whole range of possible adjustments, the scraper plate can be ideally adapted to the terrain. This leads to effective movement of snow.

The learner driver should note that quantity and speed are not always of the essence. Drivers must decide for themselves on the basis of terrain conditions whether bulldozing downhill is worthwhile or not, or whether it would in fact lead to further loss of snow.

PARKBLADE (FUNPARK)



Correct usage:

The ParkBlade is designed for constructing and maintaining funparks and boarder crosses.

Funpark obstacles such as funboxes and rails can be transported on the forks.

(See Section 30)

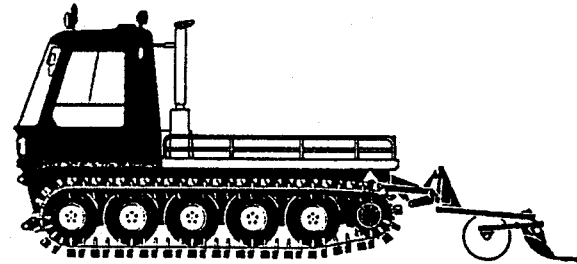
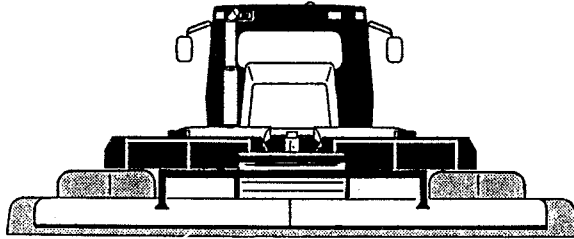

The rear-mounted attachment is an item of auxiliary equipment which should mostly be used with fresh snow and soft spring snow: It packs the snow, smoothes the pistes and obliterates marks left by the tracks. The roller packs the snow in the area between the tracks.

The rear-mounted attachment consists of a frame with a quick-change system. The smoother can be adjusted to a steeper or flatter setting.

Advantages:

- Pistes are groomed faster.
- Rear-mounted attachment does not use up any of

the vehicle's power.

- Fuel consumption is reduced. Environment-friendly use.

Use of rear-mounted attachment

If the smoother setting is too steep, this leads to what is known as a raking effect. This can cause snow piles which are too undulating.

If smoother setting is too flat, too little snow will be transported. Potential holes in piste will not be filled.

The correct smoother setting is determined by the conditions of the snow.

A well-groomed piste has no piles of snow, no snow walls and is aesthetically pleasing.



Always raise rear-mounted attachment when pushing snow or crossing streets and similar areas.

Special equipment in 6 m smoother.

PUSHBUTTON

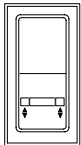

When actuating **side section**, fold smoother **in/out**.

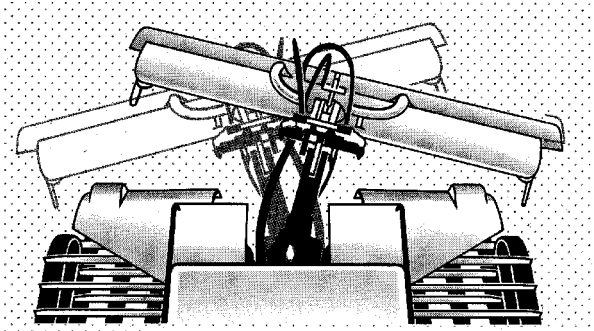

The rotary plough 2000 is hydrostatically driven and is used to loosen up pistes after use by a lot of skiers. It is also used to reduce lumps of snow and ice and to mix up old and fresh snow.

You can hydraulically adjust the depth at which the rotary plough shaft is used from driver's cab. In addition, the rotary plough shaft can be operated in either contra-rotating or synchronous running mode. Both of the rotary plough's shafts can be swapped over quickly and can be replaced by other shaft versions, if this is required by the prevailing snow conditions.

The rotary snow plough 2000 can be fitted or removed

by 1 person thanks to its quick-change system. The rotary snow plough 2000 is an item of auxiliary equipment which can be used with all types of snow if the snow is deep enough.

- Regrooming of pistes covered in fresh snow.
- Dealing with mogul pistes (using scraper plate).
- Roughening up icy pistes.
- Breaking up hard lumps of snow.
- Penetrating ice sheet.
- Mixing old and fresh snow.
- Packing wet snow.
- Dealing with glacier ice (in summer).

Adjusting depth of rotary plough

- Lift rotary plough completely out of the snow with rotary plough depth adjustment pushbutton.

The only part of the rotary plough in contact with piste is the finisher.

- Operate rotary plough at medium speed and set off.
- Slowly increase depth of shaft when driving.



The optimum shaft depth is reached when the piste surface behind the finisher is aesthetically pleasing

When driving uphill, ensure that the rotary plough is in synchronous running mode and drive at a speed which creates the piste conditions required. If the rotary plough is operated at excessively high speeds, then a correspondingly high level of power is required which will no longer be available for driving the PistenBully. When driving downhill at a steep gradient, the rotary shaft can be set in contra-rotation mode in order to stabilize the Pisten Bully.

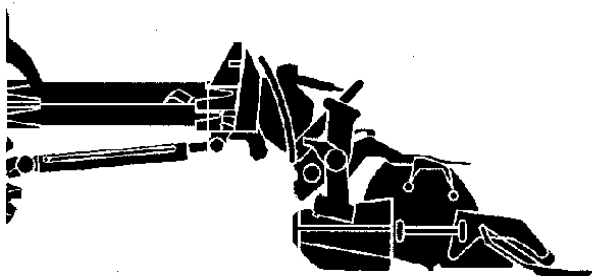

The Multiflex rotary snow plough is a further development of the tried and tested rotary snow plough 2000 which is even more piste-friendly when tilling the snow.

It adapts to the natural contours of the terrain with adjustable tilt angle of up to 20°.

Both of the rotary plough's components are guided across the ground with a three-point mounting. This creates pistes which look very natural.

Both rotary plough shafts are driven by a hydraulic mo-

tor and are connected by a synchronous propeller shaft to ensure that they move at the same speed and have the same torque.

The specially constructed rotary plough shafts and finisher distribute the snow in an optimum manner so that the piste always looks groomed no matter what the conditions of use are.

Rigid setting of the Multiflex rotary plough

If you want to achieve a flat area (and not adapt to the terrain), the Multiflex rotary plough can be placed in a rigid setting.

Hydraulic actuation for "set to rigid" (FunPark)

- Set down the Multiflex tiller on a firm, level surface.
- Operate pushbutton for **rigid setting of rotary plough** (special equipment) until hydraulic cylinder is completely extended.

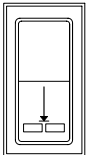

Tilt switch – rigid setting

Push upwards = rigid setting "OFF"

Press downwards = rigid setting "ON"

Cancelling "set to rigid" (unlock)

- Set down the Multiflex tiller on a firm, level surface.

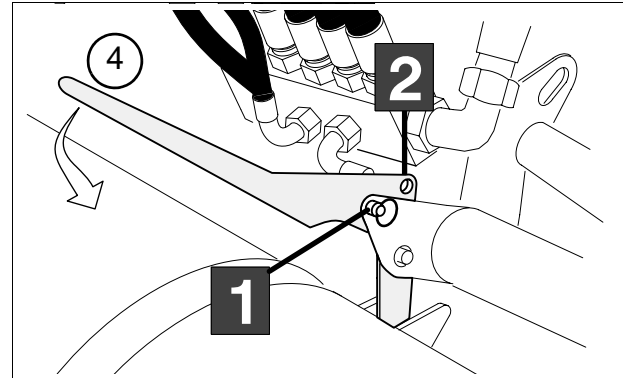

- Actuate pushbutton rotary plough in rigid setting until hydraulic cylinder is completely retracted.

Manual rigid setting (series):

- Adjustment lever 4 in pos.1
- Secure with retaining pin.

Cancel rigid setting:

- Adjustment lever 4 in pos.2
- Secure retaining pin

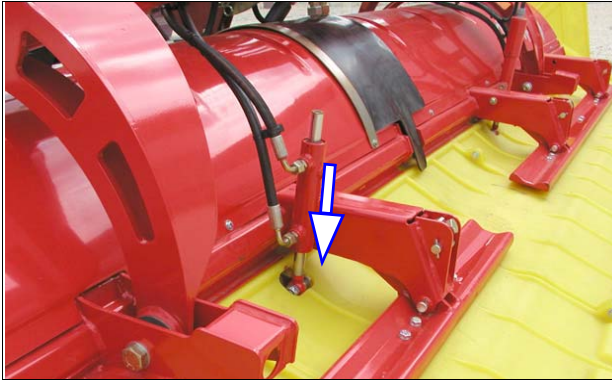

Snow-flap Adjuster - Tiller

The snow-flap adjuster enables you to vary the snow path through the tiller by means of pushbutton controls.

Snow-flap **retract**

With the snow flap set to this position when the vehicle is used on an ice-covered slope, for example, chunks of ice will be forced to pass the tiller shaft several times and this will help ensure optimum processing.

PUSHBUTTON



Snow-flap position for rotary plough

Top section pressed = Extend snow flap
 Bottom section pressed = Retract snow flap
 (see the section entitled "Multiflex rotary plough")

See Snow-flap position indicator

- When **ascending**, always set the tiller shaft to forward operation and use a suitable working speed until the ski slope has been prepared to specification.

An attempt to operate the tiller shaft at too high a speed will divert too much output power from the engine, with the result that the engine will not be able to develop enough power to propel the PistenBully.

- When **descending** extremely steep gradients, the tiller shaft can be set to counter-rotate so as to help stabilize the PistenBully.