



PostBase Mini

Franking machine



Operator Manual

First steps

About this Manual

Please read this manual before installing and using the PostBase Mini franking machine. Please keep this manual near PostBase Mini for quick reference.

This Operator Manual is directed at the users of the PostBase Mini.

This manual describes installation and commissioning of the PostBase Mini franking machine and gives basic information on operating the PostBase Mini. Functions that are described here but are not available for each PostBase Mini (among other things because of postal requirements in the individual countries) are identified as *(not available in all countries)*.

Further documents

For complete specifications of the PostBase Mini, refer to the **Operator Manual PostBase Mini** (Reference Guide) – available as a download from Francotyp-Postalia.

The **Installation instructions** (flyer) shows an overview of the steps during installation.

Information on country-specific features and particularities can be found in the **Addendum to the Operator Manual** *(if available in your country)*.

Safety tips

The following keywords and signs identify the safety tips in this manual:



Warning! indicates a potential hazard that may result in injury.



Caution! indicates a potential hazard that may result in damage to the machine or impair the franking process.

PostBase Mini

In this manual, the product name appears in its plain form 'PostBase Mini'.

Text features and symbols

The following symbols and text features are used in this manual:

- Bullets precede instructions.
- Dashes precede list items.

Menu names and options from the operating menu are written in small capitals, e.g. MENU.



A tip offers advice or additional suggestions for improving the operation.

Illustrations

The display figures in this manual are generic examples that may differ from the actual display on your PostBase Mini. As currency, Euro is used exemplarily.

About this Manual	2
1 Safety tips	4
2 A short description of the PostBase Mini	6
3 Installation and commissioning	9
Step 1: Unpacking and checking the contents of the package	9
Step 2: Assembling PostBase Mini	10
Step 3: Connecting PostBase Mini	11
Step 4: Turning the PostBase Mini on	12
Step 5: Installing PostBase Mini	12
4 The basics of operation	18
4.1 Turning the PostBase Mini on / off	18
4.2 Standby	19
4.3 Screen elements and operation philosophy	20
4.3.1 The touch screen	20
4.3.2 The Home screen	22
4.3.3 The Product calculation menu	23
4.3.4 The Menu	25
4.3.5 Lists	25
4.3.6 Adjustment menus	26
4.3.7 Pop-up windows	27
4.3.8 Procedures (wizards)	28
5 Franking	29
5.1 Setting the franking imprint	29
5.2 Positioning and franking a letter	30
Appendix	
Connection settings (Overview)	31
Technical Data	35
Declaration of conformity	38
License	39
Security Declaration for data usage	41
United States Patents	41
Customer Support / Warranty	43

1 Safety tips

PostBase Mini is a digital franking machine with ink-jet print technology for franking mail. PostBase Mini complies with the pertinent safety regulations for office information equipment.

Please observe the following tips for your own safety:

Prevention of electrical hazards

- Operate the PostBase Mini only on a grounded single-phase power socket. Make sure your office power supply conforms to the power requirements indicated on the power supply unit's serial number plate.
- Make sure the socket for connecting the PostBase Mini is close by and easily accessible at all times.
- Unplug the mains plug in case of an emergency. Call the Customer Support.
- Take special care that no foreign objects or liquids penetrate the interior of the PostBase Mini.
- Unplug the mains plug prior to cleaning the PostBase Mini.

Prevention of mechanical hazards

- Do not remove any equipment related to safety or protection. Do not make them inoperative or unable to function.
- Do not remove any parts of the housing.

Accessories and consumables

- We recommend to use only approved FP equipment and FP original parts. The manufacturer FP has established reliability, safety and applicability. The manufacturer cannot assess the reliability, safety and applicability for products not approved by FP, and therefore not vouch for such products.
- Use the power supply unit provided with the PostBase Mini or approved by Francotyp-Postalia. Make sure that the power supply unit is not damaged.
- Use the supplied cables or cables that have been approved by Francotyp-Postalia. Make sure that cables are not damaged.

- Ingestion of the ink can be hazardous to health. Avoid contact with the eyes. Keep the ink cartridges away from children. Further instructions for use are enclosed with the ink cartridge.
- We recommend to use only the batteries provided by Francotyp-Postalia. The manufacturer FP has established reliability, safety and applicability. Observe the instructions enclosed with the battery for correct use and disposal.

General safety tips

- Install the PostBase Mini according to the instructions.
- When you move the PostBase Mini from a cold environment (i.e. below 10 °C / 50 °F): Unpack the PostBase Mini and wait at least two hours before connecting the PostBase Mini. The PostBase Mini requires this period to adapt to the ambient conditions. Any condensation evaporates.
- Have maintenance and repair work done only by qualified personnel authorised by Francotyp-Postalia. Otherwise, your warranty may become void.

2 A short description of the PostBase Mini

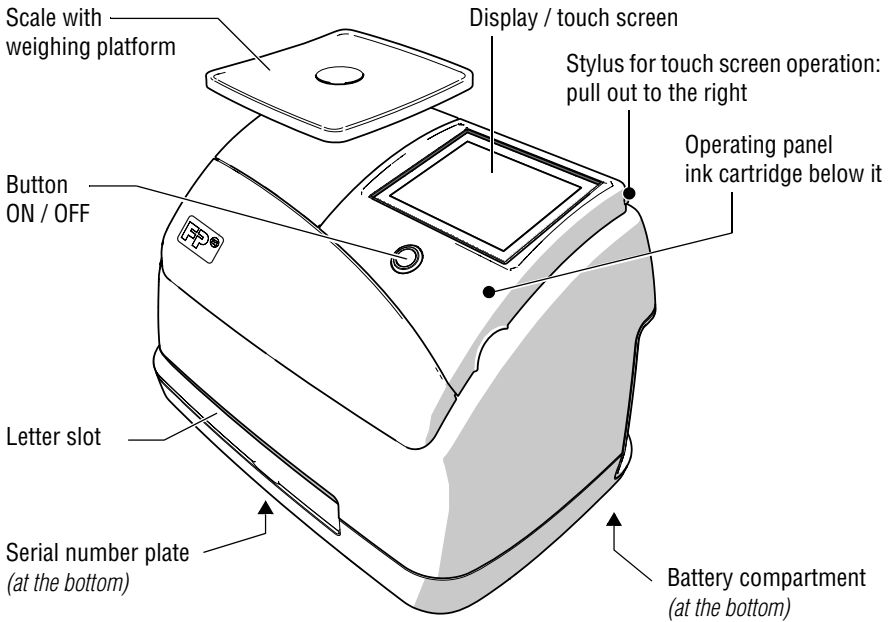

Connections (view from the right)

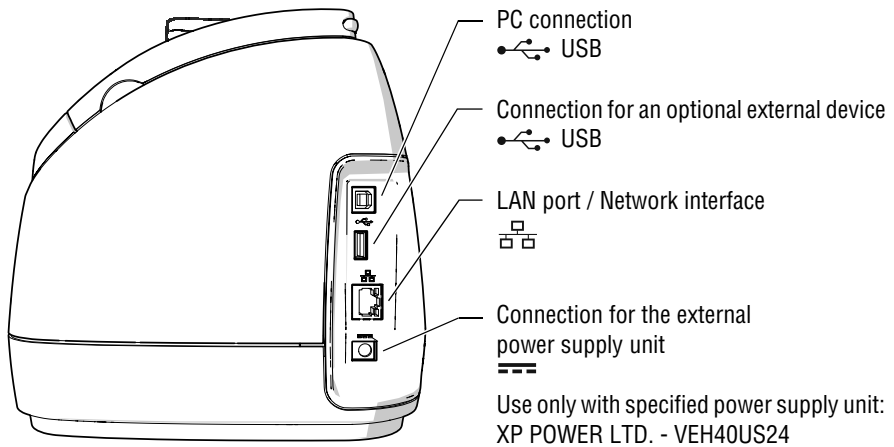

Things worth knowing about PostBase Mini

PostBase Mini is a digital franking machine for small mail volumes featuring a touch screen. It stands out due to its compact design and intuitive handling. The reliable ink-jet technology delivers clean franking imprints.

Intuitive handling

PostBase Mini makes do with only a single button, arranged in the centre: for switching on and off. For all other operations, the clearly designed user interface in the 3.5 inch colour display guides you fast and easy to the desired destination.

Franking

Simply switch on the PostBase Mini, select a postal product, position a letter – done!

Franking is possible on mail pieces made of ink-absorbing material – postcards to 6 mm (0.23") thick letters in ISO B4 format – and special self-adhesive labels.

Letters as advertising medium

In addition to printing postage, you can print an advertisement of your choice on every mail piece you send.

When using the optional PC control software, this can also be a text message (*if available in your country*).

Download postage

You conveniently download the postage for franking online from the data centre into your franking machine. If desired, PostBase Mini can also, by itself, make sure there is always sufficient postage available and prompt you automatically to download postage.

(Availability and handling of features relating to postage accounting depend on the respective countries.)

Remote Services: flexible and up to date

The PostBase Mini ensures you are always using the current postal rates. Whether new postage rates, new adverts or a software update – the franking machine downloads current data from the data centre.

Additional functions

Weighing – the space saving, integrated scale quickly and reliably determines the weight of letters and parcels. The determined weight directly affects the product settings.

Account function – PostBase Mini allows for registration and billing of postage costs to accounts.

Access control – PostBase Mini can be protected against unauthorised use via a PIN (Personal Identification Number).

Controlling PostBase Mini via PC software (*optional*).

Francotyp-Postalia offers software for controlling and administration of the PostBase Mini franking machine via PC, e.g. NavigatorBasic, NavigatorPlus, RemoteOne, ReportOne (*not available in all countries*).

3 Installation and commissioning

Step 1: Unpacking and checking the contents of the package



Warning! Do not start operating PostBase Mini if parts are damaged or missing. Please contact the Customer Support.



Caution! Carry out the steps exactly in the given order. Also, consult the installation instructions (fold-out).

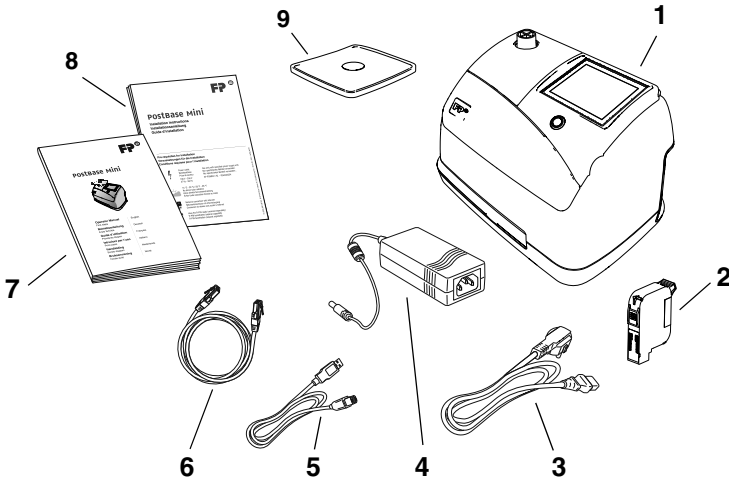

- 1 PostBase Mini franking machine
- 2 Ink cartridge
- 3 Power cable
- 4 Power supply unit
- 5 USB cable (*optional*)
- 6 Ethernet cable
- 7 'First steps' manual
- 8 Installation instructions (flyer)
- 9 Weighing platform (*version as ordered*)

- Unpack the packages.
- Check that the contents of the packages are complete and free from any damage.



Keep the packing. Use it again when you need to transport PostBase Mini or send it in to service.

Step 2: Assembling PostBase Mini



Caution! When you move PostBase Mini from a cold environment (i.e. below 10 °C / 50 °F): Unpack the PostBase Mini and wait at least 2 hours before connecting PostBase Mini. PostBase Mini requires this period to adapt to the ambient conditions.

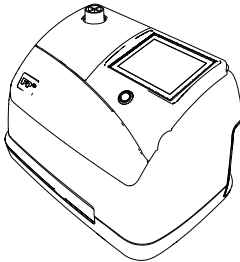

- Choose an installation site with the following ambient conditions:
 - room temperature: 15 °C to 35 °C (59 °F to 95 °F)
 - no direct sunlight
 - power socket in the immediate vicinity
 - network connection with internet access.
- Place PostBase Mini on a firm, level, low vibration and horizontal base

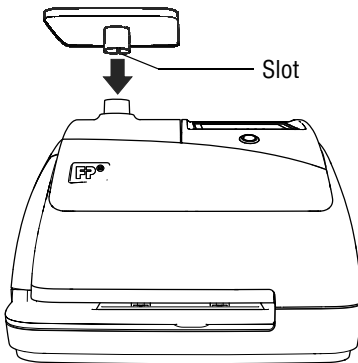

Mounting the weighing platform

- Hold the weighing platform such that the slot in the weighing platform foot points to the back.
- Place the weighing platform onto the scale receptacle from above. The slot of the weighing platform must slide in the counterpart on the scale receptacle.
- Press down slightly on the weighing platform with your flat hand.

Step 3: Connecting PostBase Mini



Warning! Use the power supply unit provided with the PostBase Mini or approved by Francotyp-Postalia. Make sure that the power supply unit is not damaged.

Use the cables provided with the PostBase Mini or approved by Francotyp-Postalia. Make sure that cables are not damaged.

Connect PostBase Mini only to a grounded single-phase power socket. Make sure your office power supply conforms to the power requirements indicated on the power supply unit's serial number plate.

Make sure the socket for connecting PostBase Mini is close by and easily accessible at all times.

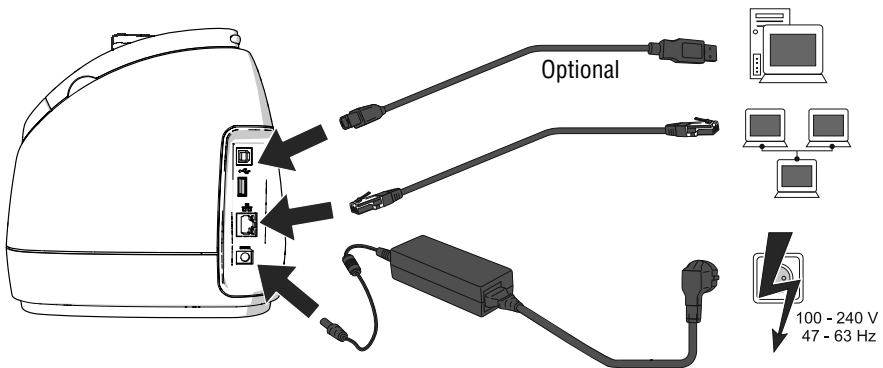

- Connect the franking machine to a local area network (LAN).
- Connect the franking machine to a PC (optional).
- Plug the mains plug of the power supply unit into the power connection of the franking machine. Connect the power cable to the power connection of the power supply unit. Only then, plug the power cable into the power socket.

Step 4: Turning the PostBase Mini on

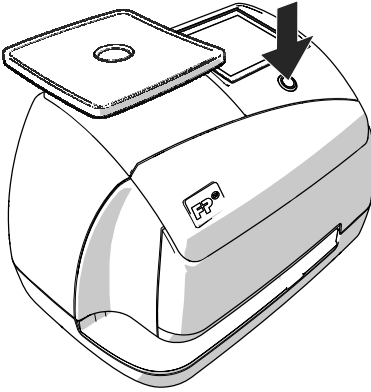

- Press the button on the operating panel.

The display lighting and button illumination switch on. PostBase Mini performs a self test and then starts the installation procedure.

Step 5: Installing PostBase Mini

PostBase Mini will guide you step by step through the installation procedure. This chapter covers a selection of the most important steps. Follow the instructions on the display.



For information on handling the touch screen and an overview of screen elements, please read chapter 4.3.

- Have the R-PIN ready (received separately).
- Touch the button with the desired **language**.
- Confirm with the ➤ button and continue the installation procedure.

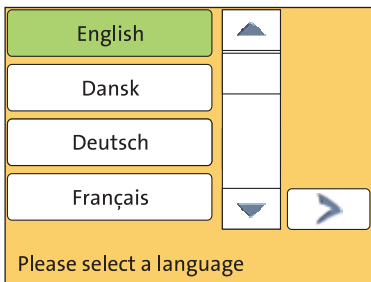

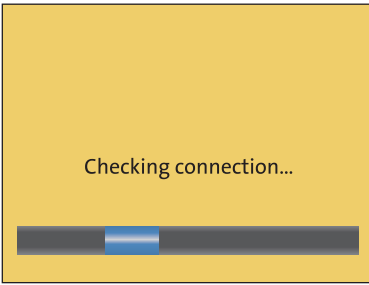

PostBase Mini comes with pre-set connection settings that should work in most cases.

- Press the  button to use these settings.

PostBase Mini tests the connection to the FP Infrastructure.

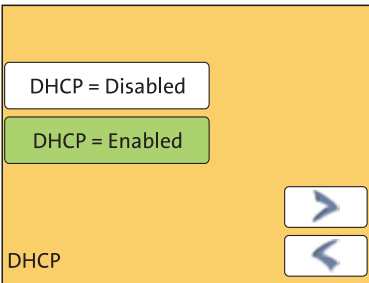

If no connection can be established, the wizard for entering connection parameters is opened.

- If necessary: Enter the connection parameters. If need be, ask your network administrator for details.



For an overview of the connection parameters, please read “Connection settings (Overview)” on page 31.



Caution! PostBase Mini may reboot several times during installation. Do not unplug the machine!

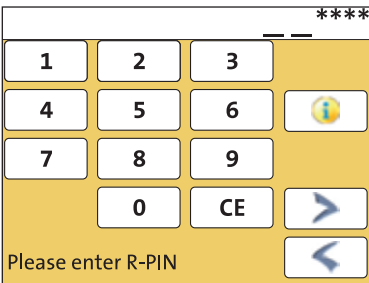

- Enter the **Repository-PIN** (R-PIN).
- Confirm with the .

PostBase Mini now downloads the software and data, then reboots.

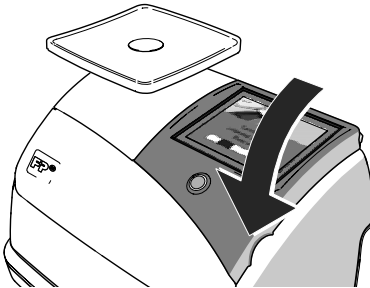
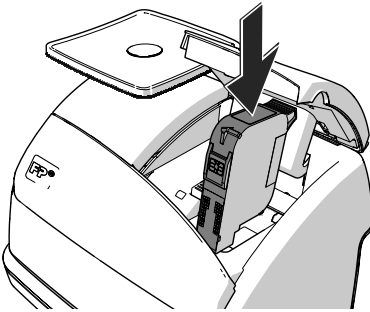
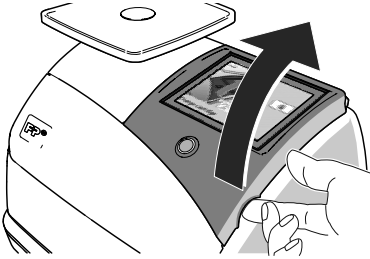

PostBase Mini then asks you to **insert the ink cartridge**.

- Lift up the operating panel as far as it goes. You can feel it engage.
- Remove the ink cartridge from the packing.
- Remove the nozzle protection.

For details, please refer to the instruction leaflet that comes with every cartridge.

- Hold the ink cartridge so the contacts are facing to the front of the franking machine.
- Insert the ink cartridge into the socket.
- Push the ink cartridge all the way down. You can feel the ink cartridge engage.

- Lower the operating panel back into position.

PostBase Mini calibrates the cartridge ...

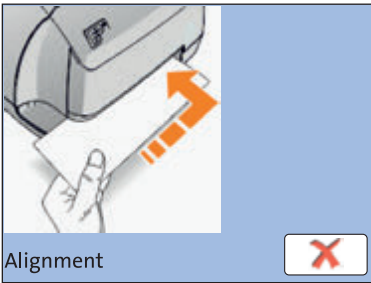

... and prompts you to perform a **test print**.

- Place an empty envelope at the right hand edge of the letter slot and push in as far as it goes.

As soon as the sensor (in the back right hand corner of the letter slot) detects the envelope, the PostBase Mini grips the envelope tightly and prints the test print.

Test print (example)

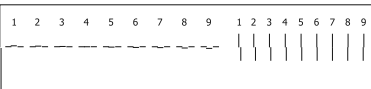

- On the test print, determine the numbers where
 - the horizontal lines are as exactly next to each other as possible and
 - the vertical partial lines are as exactly above each other as possible.

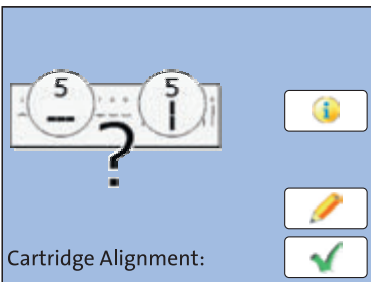

The ink cartridge is correctly aligned when horizontal and vertical partial lines form one line each at number 5.

- Confirm with the button.

When horizontal and / or vertical partial lines do not form one line each at number 5:

- Press to continue the procedure of ink cartridge alignment.

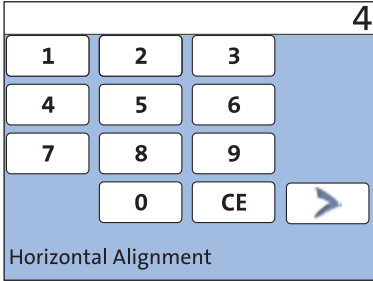
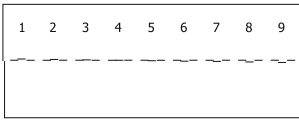

Adjust cartridge: horizontal line

- Type the number where the horizontal partial lines are as exactly next to each other as possible.
In the example, this is number '4'.
(If necessary: Press CE to clear the displayed number.)
- Confirm and continue with .

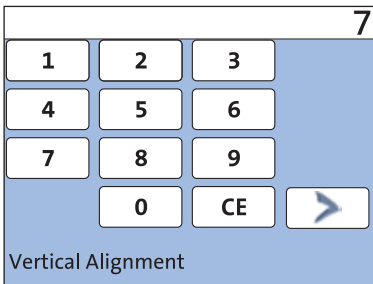
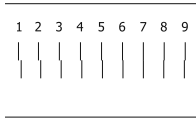

Adjust cartridge: vertical line

- Type the number where the vertical partial lines are as exactly above each other as possible.
In the example, this is number '7'.
(If necessary: Press CE to clear the displayed number.)
- Confirm and continue with .

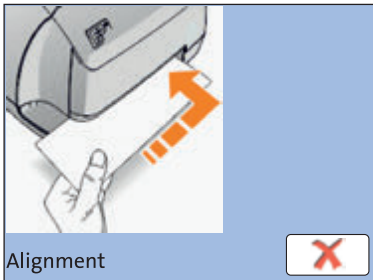

- Place an empty envelope for another test print.
- Assess the test print. If necessary, repeat the alignment procedure until a correct alignment has been obtained.

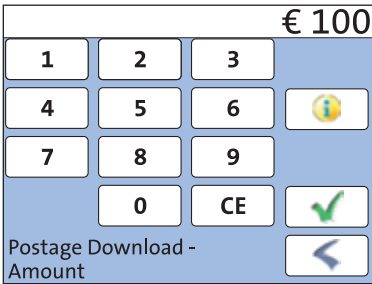

- Contact to the data centre / load postage.

To be able to frank with your PostBase Mini, the PostBase Mini must have the corresponding **postage credit** available. For this, a connection to the data centre is necessary. The exact process, permissible loading amounts, as well as postage accounting depend on postal regulations of the respective countries.

Home screen (example)

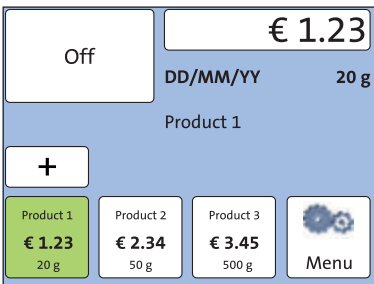

PostBase Mini shows the Home screen.

Installation is complete.



In the MENU, you can configure the system settings of your PostBase Mini to your liking (display brightness, tone signals, standby time, access control via PIN ...). You also have access to the account function of the PostBase Mini in the MENU.

4 The basics of operation

In this chapter, you will learn about the basic functions of the PostBase Mini and how to handle the touch screen.

4.1 Turning the PostBase Mini on / off

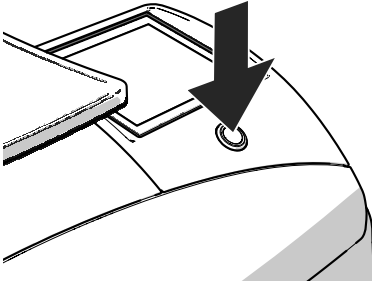

Turning on

- Press the button on the operating panel.

The display lighting and button illumination switch on. The PostBase Mini performs a self test and then displays the Home screen.

When access control is active, PostBase Mini prompts you to enter the PIN during the start routine.

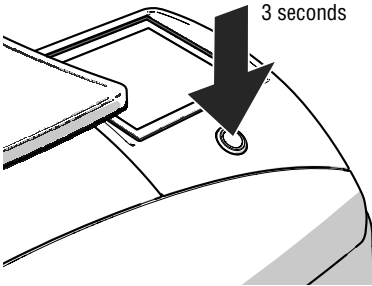

Turning off

- Press the button for **three seconds**.

The PostBase Mini will complete any current actions and then switches off. The display light and button illumination go out and the touch screen is deactivated.

Disconnecting from mains



Caution! Make sure to always turn the PostBase Mini off before disconnecting the PostBase Mini from mains. Never pull the mains plug or separate the power supply in any other way before the printing system has reached its sealed position. This is the only way to prevent drying up and to ensure a permanently high print quality

- Press the button ON/OFF for **three seconds** to turn the franking machine off.

The display light and button illumination go out.

- Unplug the mains plug of the power supply unit from the socket.

4.2 Standby

The PostBase Mini franking machine will go to standby automatically if it is not used for some time.

The display is dark and the button is illuminated in standby. The touch function is inactive.

You can 'wake up' PostBase Mini by briefly pressing the button.

4.3 Screen elements and operation philosophy

This chapter covers the user interface of the PostBase Mini franking machine. You will learn how to operate the touch screen, the screen elements and the menus, window types and symbols.

4.3.1 The touch screen

The touch screen is active when the display is lit. To operate the PostBase Mini, simply touch the screen elements with your finger.

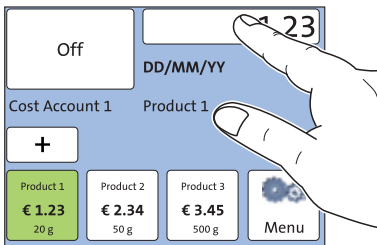

General operation philosophy

You briefly touch the desired screen element (in the example: the postage button) with your finger. PostBase Mini performs the corresponding action.

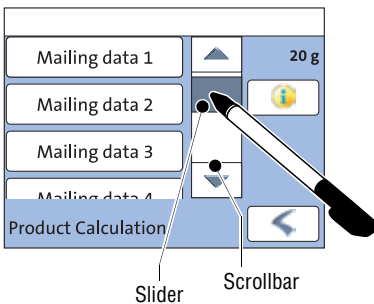

You can operate scrollbars with the arrows or by touching the slider and moving it. The setting is updated when you lift your finger off.

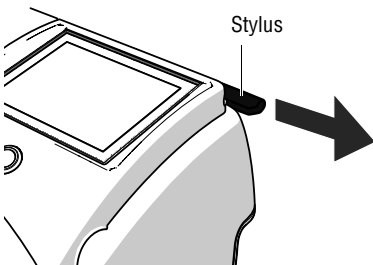

Stylus

You can also use the supplied stylus instead of your finger. The stylus is located behind the operating panel. You can pull it out to the right.

Buttons

You distinguish buttons from the screen background by a frame. They can have various states, depending on the function:



Button can be pressed / is active.



Button is selected.



Button is being pressed.

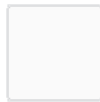

Button cannot be pressed / is deactivated.

Standard buttons

The term 'standard button' refers to common functions like:



OK / Save – confirm an entry, a message, a security prompt.
Save the displayed setting.



Cancel – abort entry / function.



Back – to the previous window / higher-level menu. Go back one step / level.



Continue – acknowledge a message, accept the current setting and proceed to the next step.

4.3.2 The Home screen

The Home screen appears after the machine was turned on and the start routine has been successfully completed. It shows the current franking settings at a glance.

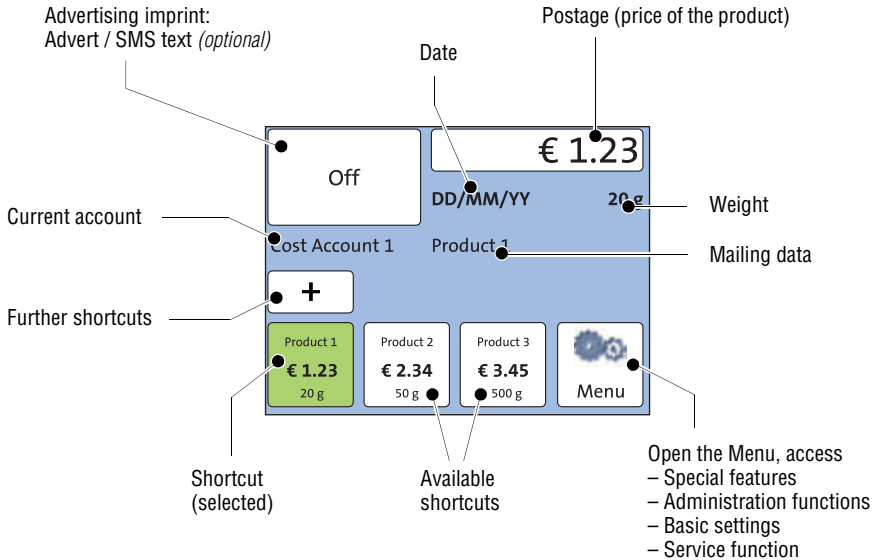

Functions

In the Home screen

- you have access to all franking imprint settings
- you frank your mail pieces
- you can weigh your mail pieces
- you can open the Menu
- current settings are displayed.

Operation philosophy

A function can be edited or selected by simply touching its button. Depending on the respective function, the PostBase Mini opens a list, an adjustment menu or a menu offering further options. In the chapters to follow, you will be introduced to each of the menu and window types and their operation.

4.3.3 The Product calculation menu

In the Product calculation menu, you set the product for franking.

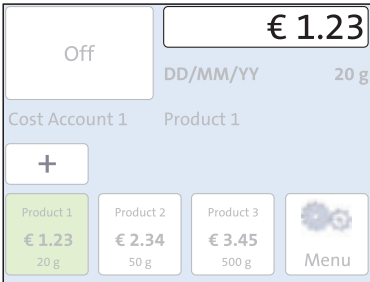

Calling up the Product calculation menu

You open the Product calculation menu by pressing the button showing the postage value.

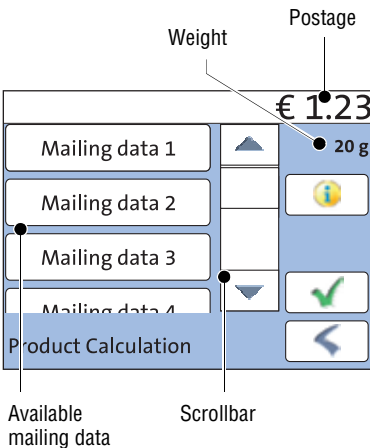

The left area of the display shows the available mailing data.

You can scroll the list with the scroll bar if more than three options are available.

The set weight for product calculation appears to the right in the display.

The postage and the  button only appear if all necessary mailing data were selected.

You can view the selected mailing data with the  button.

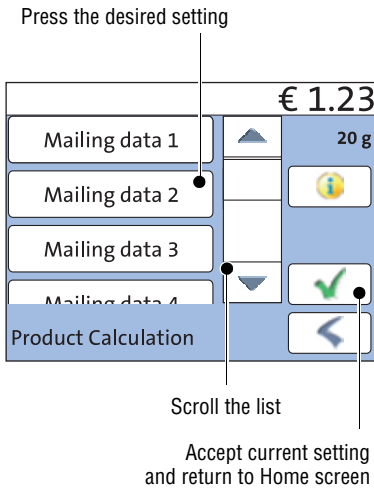

Selecting mailing data

You select the mailing data for a product by pressing the button with the desired setting.

PostBase Mini applies your selection and shows the next available mailing data to the left in the display. PostBase Mini guides you through the postage calculation process step by step.

Press the ✓ button to accept the current setting and to return to the Home screen.

Deselecting mailing data

You can erase the mailing data step by step with the ← button.

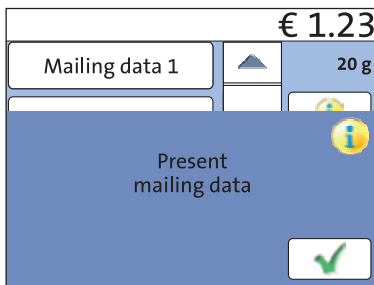

Display current mailing data

To view the selected mailing data, press the ⓘ button.

PostBase Mini displays the current mailing data in a pop-up window.

Close the pop-up window with the ✓ button.

Set product for franking

Returning to the Home screen

With the ✓ button, you set the selected product for franking and return to the Home screen.

Cancel Product calculation menu

Deselect all mailing data and cancel the Product calculation menu with the ← button. The product set last remains set in the Home screen.

4.3.4 The Menu

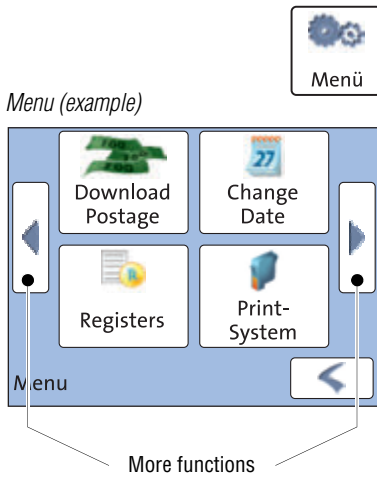

Use the MENU button to open the Menu. From this Menu, you can access the basic settings, administration, and service functions.

Use the arrow buttons to scroll to the next page and back in the Menu.

4.3.5 Lists

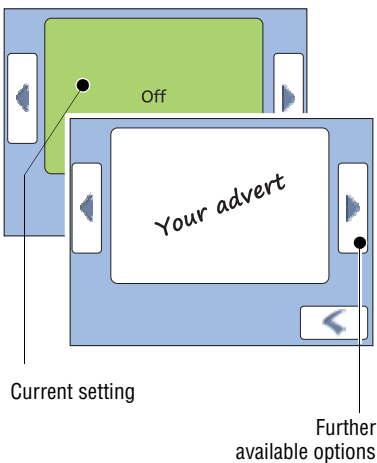

Lists (e.g. for adverts) offer all available settings. The current setting is shown with a green background.

Use the arrow buttons to scroll forward or backward.

Press the respective button to select one of the provided settings.

4.3.6 Adjustment menus

A separate menu each opens for editing and selecting settings. There are different types of adjustment menus, for example lists where you select a setting or menus with a keypad for entering figures or letters.

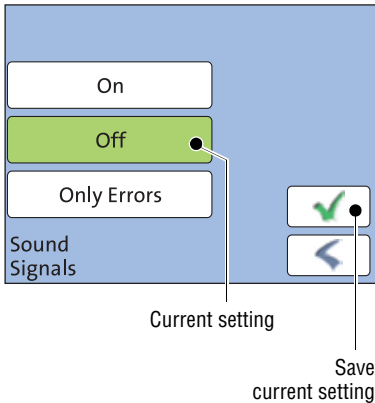

Lists

The left area of the display shows the available settings. The current setting is shown with a green background.

You can scroll the list with a scroll bar if more than four options are available.

Press the button to save the current setting and to quit the adjustment menu.

Press the button to leave the adjustment menu without saving any changes.

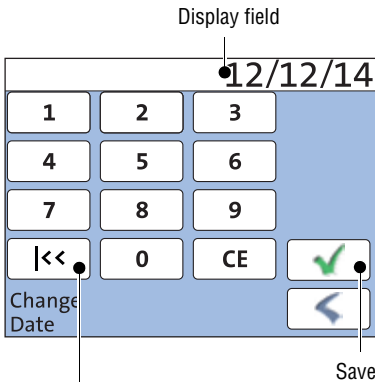

Button assigned according to function (here: reset to current date)

Input via keypad

Use the keypad to input values. The display field indicates your input.

The keypad is always matched to the respective situation: The button labels change accordingly, depending on whether you must type figures or figures and letters.

The bottom left button is assigned a special function matched to the current operation. In the adjustment menu for setting the franking date, for example, this is 'reset to current date'.

Press CE to clear input.

Press the button to save the current setting and to quit the adjustment menu.

Press the button to leave the adjustment menu without saving any changes.

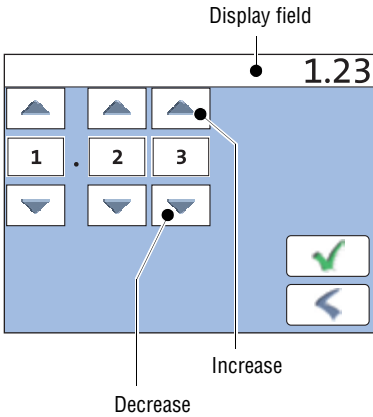



Input using the counter principle

(not in all countries)

For some particular settings, PostBase Mini may require you to enter values via a counter principle.

Mode of operation: Use the arrow buttons to increase or decrease the figure in each digit until the desired amount is displayed in the top of the display.

Press the  button to save the displayed amount.

Press the  button to leave the adjustment menu without saving any changes.

4.3.7 Pop-up windows

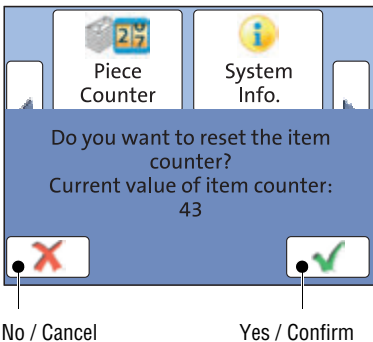

For some settings, a window covering parts of the current window opens (pop-up window). The pop-up prompts you for an action. Messages and the 'PC Mode' (using the PC control software for PostBase Mini) also appear as a pop-up.

Some pop-up messages feature auto-confirmation, i.e. they automatically close after some time.

4.3.8 Procedures (wizards)

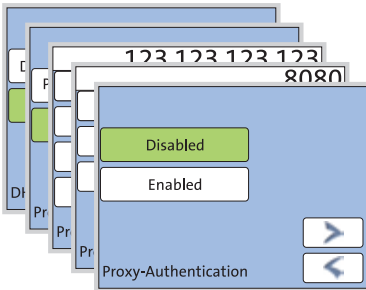

For more complex settings, e.g. when setting up connection data, PostBase Mini guides you through all necessary actions step by step. Different window types are used, depending on requirements.

Press the  button to accept the current settings and to go to the next step.

You can press the  button to return to previous steps.

Pressing the  button in the first screen of the procedure will discard all settings and close the procedure.

5 Franking

5.1 Setting the franking imprint

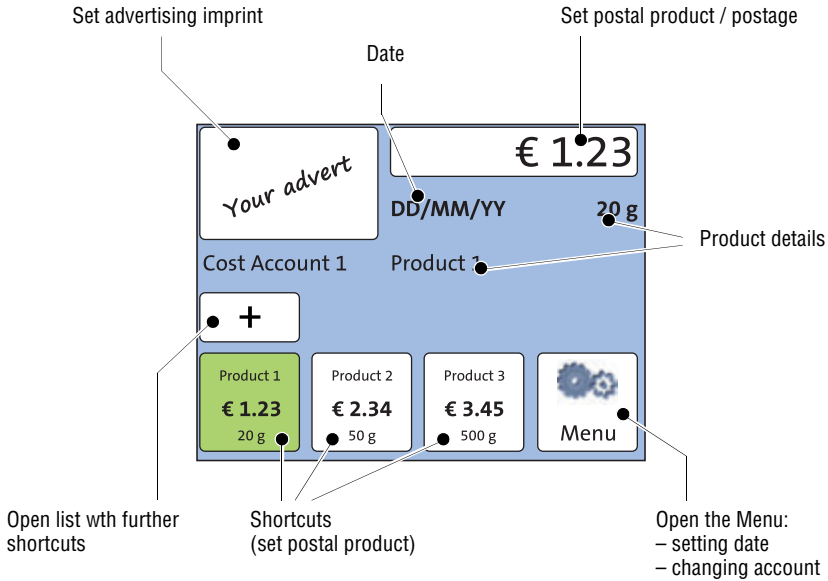

Detailed information on the franking imprint of your postal service can be found in the country-specific addendum *(if available in your country)*.



For information on how to use the optional PC control software from Francotyp-Postalia (e.g. Navigator, RemoteOne) to set the franking imprint, please refer to the manual provided with the software.

5.2 Positioning and franking a letter

You can use the PostBase Mini to frank postcards and letters up to a thickness of 6 mm (0.23"). For thicker mail pieces, frank the empty envelope or use the special franking labels of at least 140 mm (5.5") length. You can order suitable labels for the PostBase Mini from Francotyp-Postalia.

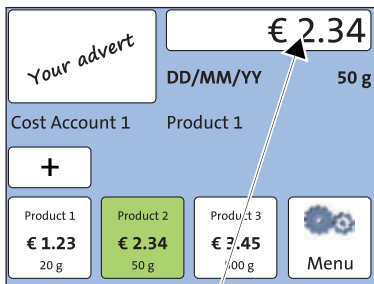

PostBase Mini is ready for franking

You can feed mail pieces to frank when the Home screen displays the desired settings for franking.

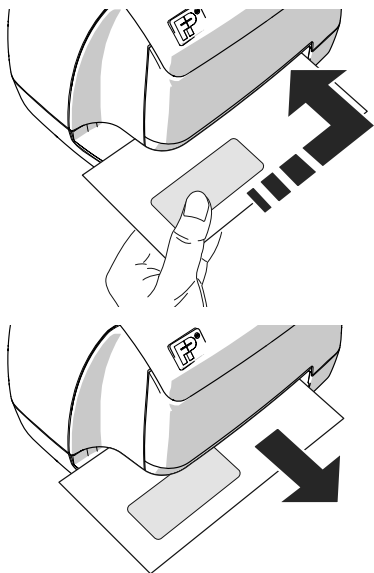

- Insert the letter:
 - side to be printed face up
 - top edge first.
- Place the letter at the right hand edge of the letter slot and push in as far as it goes.

As soon as the sensor (in the back right hand corner of the letter slot) detects the letter, the PostBase Mini grips the letter tightly and prints (franks) it.

During franking, a message informs you about the printing process.

Do not remove the letter until the Home screen reappears and the PostBase Mini releases the letter.

Connection settings (Overview)

The chart on the following pages gives an overview of the possible connection settings and parameters.



For further details, you may also refer to the Connectivity Guide for PostBase on the FP homepage.

Connection Type	
ETHERNET	<p>LAN connection. PostBase Mini connects to the Francotyp-Postalia Infrastructure (FPI) via the internet.</p> <p><i>(default setting, not changeable)</i></p>
DHCP	
DHCP = ENABLED	<p>Dynamic Host Configuration Protocol. Networking protocol that allows automatic connection to a network.</p> <p>Select this setting if your network supports DHCP.</p> <p><i>(default setting)</i></p>
DHCP = DISABLED	<p>Select this setting if your network does not support DHCP.</p> <p>During manual configuration, you will need to enter the following parameters:</p> <ul style="list-style-type: none"> – Static IP address for your PostBase Mini – Subnet mask – Default gateway – IP address of the DNS server. <p>Please contact you network administrator for details.</p> <p>Note: When entering IP addresses, you have to enter the dots, too.</p>

Proxy-Server	Intermediary server that facilitates access to the internet.
PROXY = DISABLED	Select this setting if your network does not use a proxy server. <i>(default setting)</i>
PROXY = ENABLED	Select this setting if your network uses a proxy server. You will need to enter the following parameters: – IP address of the proxy or its alias – Port number Please contact you network administrator for details.
Proxy-Authentication <i>(only when Proxy = Enabled)</i>	Access control to the proxy server (user name and password).
DISABLED	Select this setting if your proxy server does not require authentication (user name and password). <i>(default setting)</i>
ENABLED	Select this setting if your proxy server does require authentication. You will need to enter the following parameters: – User name for proxy access – Password. Please contact you network administrator for details.



In case your network only supports explicitly authorised devices, your network administrator will require the MAC address of your PostBase Mini. You can find it in the System Information in the Menu.

Reference Information for Network Administrators

The PostBase Mini requires (preferably) an Ethernet connection, with a minimum of 10 Mbit/sec, in order to be able to download postal funds from a Francotyp-Postalia server. Ethernet cables of class CAT5E are recommended. For this it normally uses TCP/IP (v4 only) through an https connection using TLS v1.2 over **port 443**. In certain cases it may also use an http connection over **port 80**.

These two ports must therefore be enabled in any firewall. It will attempt to make a connection to *.francotyp.com.

Technical Data

Dimensions	
– Length	310 mm (12.2")
– Width / Depth	205 mm (8.1")
– Height	230 mm (9.1")
Weight	3,0 kg (6.6 lbs)
Power supply	24 VDC / 0.7 A (using an external power supply unit) Protection class III
Power connection	External Power Supply Unit: XP POWER LTD. - VEH40US24 100 - 240 V / 0,93 A / 47 - 63 Hz
Power consumption	40 W (Energy Star certification intended) <1 W (switched off) <7 W (standby)
Battery	3,6 V / 2 Ah / 20 mA (order no. 90.4701.8004.00)
Display	TFT, 320 x 240 pixels, with touch panel, backlit
Print system	
– Print technology	Ink-jet, 1 ink cartridge
– Printing area	133 mm x 25 mm (5.2" x 1")
– Print resolution	300 dpi
Weighing area	3 g to 2.000 g / 0.1 oz to 5 lb
Performance	Up to 15 letters/minute
Noise emission	54.5 dB(A)
Operating conditions	+15 °C to +35 °C (59 °F to 95 °F) Only use in closed rooms Do not expose to direct sunlight Rel. humidity 15 % to 80 %, non-condensing

Subject to short-term modification.

Equipment

Integrated Scale	Yes
Interfaces	USB, Ethernet/LAN
Rate table	Yes
Remote services (download postage, update rate table, software, ...)	Yes
Access control via PIN	Yes
Shortcuts for postal products	10
Accounts	5 / 10 (optional)
Advertisements, maximum number	10
SMS-text messages, number (only with PC control software)	2
PC control software (NavigatorBasic / USA: RemoteOne)	Optional
PC control software & account management (NavigatorPlus / USA: ReportOne)	Optional
FP Portal access	Yes

Subject to short-term modification.

Ink cartridge

Ink cartridge FP ink cartridge for PostBase Mini
(ink colour depending on country)

Operating and storage conditions +15 °C to +35 °C (59 °F to 95 °F)
Only use in closed rooms
Do not expose to direct sunlight
Rel. humidity 20 % to 70 %, non-condensing



Safety data sheet for users available at <http://www.francotyp.com/en/mail-management/material-safety-data-sheets-msds.html>.

Mail piece specifications

Format Postcard to ISO B4 envelope

Thickness Up to 6 mm (up to 0.23")

Material Ink-absorbent material (suitable for ink-jet printing)
No dark paper
No glossy coating on the surface to frank
No corrugated board
No extremely fibrous paper on which the franking imprint could smear

Labels Self-adhesive labels for PostBase Mini,
minimum label size 140 mm x 85 mm (5.5" x 3.4")

Subject to short-term modification.

EC DECLARATION OF CONFORMITY FOR ELECTRICAL PRODUCTS

(According to Annex III B of the Low Voltage Directive)

Manufacturer: Francotyp-Postalia GmbH

Address: Prenzlauer Promenade 28, 13089 Berlin, Germany

herewith declares that the Franking System

PostBase Mini

.....
(Type or Model designation)

which this declaration refers to, is in accordance with the conditions of
the Low Voltage Directive 2006/95/EC
and the EMC Directive 2004/108/EC.

This product is in conformity with following harmonized standards:

EN 60950-1: 2006 + A1: 2010

EN 55022: 12.2011, Class B

EN 55024: 09.2011

EN 61000-4-2: 12.2009

EN 61000-4-3: 04.2011

EN 61000-4-4: 04.2013

EN 61000-4-5: 06.2007

EN 61000-4-6: 12.2009

EN 61000-4-8: 11.2010

EN 61000-4-11: 02.2005

November 3, 2014



Hans Szymanski
Managing Director



Uwe Hübler
Head of R&D Hardware

(Legally binding signatures for the company)

License

This is a copy of the current LICENSE file inside the CVS repository.

```
LICENSE ISSUES
=====
```

```
The OpenSSL toolkit stays under a dual license, i.e. both the conditions of
the OpenSSL License and the original SSLeay license apply to the toolkit.
See below for the actual license texts. Actually both licenses are BSD-style
Open Source licenses. In case of any license issues related to OpenSSL
please contact openssl-core@openssl.org.
```

```
OpenSSL License
-----
```

```
/* =====
 * Copyright (c) 1998-2011 The OpenSSL Project. All rights reserved.
 *
 * Redistribution and use in source and binary forms, with or without
 * modification, are permitted provided that the following conditions
 * are met:
 *
 * 1. Redistributions of source code must retain the above copyright
 * notice, this list of conditions and the following disclaimer.
 *
 * 2. Redistributions in binary form must reproduce the above copyright
 * notice, this list of conditions and the following disclaimer in
 * the documentation and/or other materials provided with the
 * distribution.
 *
 * 3. All advertising materials mentioning features or use of this
 * software must display the following acknowledgment:
 * "This product includes software developed by the OpenSSL Project
 * for use in the OpenSSL Toolkit. (http://www.openssl.org/)"
 *
 * 4. The names "OpenSSL Toolkit" and "OpenSSL Project" must not be used to
 * endorse or promote products derived from this software without
 * prior written permission. For written permission, please contact
 * openssl-core@openssl.org.
 *
 * 5. Products derived from this software may not be called "OpenSSL"
 * nor may "OpenSSL" appear in their names without prior written
 * permission of the OpenSSL Project.
 *
 * 6. Redistributions of any form whatsoever must retain the following
 * acknowledgment:
 * "This product includes software developed by the OpenSSL Project
 * for use in the OpenSSL Toolkit (http://www.openssl.org/)"
 *
 * THIS SOFTWARE IS PROVIDED BY THE OpenSSL PROJECT ``AS IS'' AND ANY
 * EXPRESSED OR IMPLIED WARRANTIES, INCLUDING, BUT NOT LIMITED TO, THE
 * IMPLIED WARRANTIES OF MERCHANTABILITY AND FITNESS FOR A PARTICULAR
 * PURPOSE ARE DISCLAIMED. IN NO EVENT SHALL THE OpenSSL PROJECT OR
 * ITS CONTRIBUTORS BE LIABLE FOR ANY DIRECT, INDIRECT, INCIDENTAL,
 * SPECIAL, EXEMPLARY, OR CONSEQUENTIAL DAMAGES (INCLUDING, BUT
 * NOT LIMITED TO, PROCUREMENT OF SUBSTITUTE GOODS OR SERVICES;
 * LOSS OF USE, DATA, OR PROFITS; OR BUSINESS INTERRUPTION)
 * HOWEVER CAUSED AND ON ANY THEORY OF LIABILITY, WHETHER IN CONTRACT,
 * STRICT LIABILITY, OR TORT (INCLUDING NEGLIGENCE OR OTHERWISE)
 * ARISING IN ANY WAY OUT OF THE USE OF THIS SOFTWARE, EVEN IF ADVISED
 * OF THE POSSIBILITY OF SUCH DAMAGE.
 * =====
 *
```

```

* This product includes cryptographic software written by Eric Young
* (eay@cryptsoft.com). This product includes software written by Tim
* Hudson (tjh@cryptsoft.com).
*
*/

```

```

Original SSLeay License
-----

```

```

/* Copyright (C) 1995-1998 Eric Young (eay@cryptsoft.com)
* All rights reserved.
*
* This package is an SSL implementation written
* by Eric Young (eay@cryptsoft.com).
* The implementation was written so as to conform with Netscapes SSL.
*
* This library is free for commercial and non-commercial use as long as
* the following conditions are aheared to. The following conditions
* apply to all code found in this distribution, be it the RC4, RSA,
* lhash, DES, etc., code; not just the SSL code. The SSL documentation
* included with this distribution is covered by the same copyright terms
* except that the holder is Tim Hudson (tjh@cryptsoft.com).
*
* Copyright remains Eric Young's, and as such any Copyright notices in
* the code are not to be removed.
* If this package is used in a product, Eric Young should be given attribution
* as the author of the parts of the library used.
* This can be in the form of a textual message at program startup or
* in documentation (online or textual) provided with the package.
*
* Redistribution and use in source and binary forms, with or without
* modification, are permitted provided that the following conditions
* are met:
* 1. Redistributions of source code must retain the copyright
* notice, this list of conditions and the following disclaimer.
* 2. Redistributions in binary form must reproduce the above copyright
* notice, this list of conditions and the following disclaimer in the
* documentation and/or other materials provided with the distribution.
* 3. All advertising materials mentioning features or use of this software
* must display the following acknowledgement:
* "This product includes cryptographic software written by
* Eric Young (eay@cryptsoft.com)"
* The word 'cryptographic' can be left out if the rouines from the library
* being used are not cryptographic related :-).
* 4. If you include any Windows specific code (or a derivative thereof) from
* the apps directory (application code) you must include an acknowledgement:
* "This product includes software written by Tim Hudson (tjh@cryptsoft.com)"
*
* THIS SOFTWARE IS PROVIDED BY ERIC YOUNG ``AS IS'' AND
* ANY EXPRESS OR IMPLIED WARRANTIES, INCLUDING, BUT NOT LIMITED TO, THE
* IMPLIED WARRANTIES OF MERCHANTABILITY AND FITNESS FOR A PARTICULAR PURPOSE
* ARE DISCLAIMED. IN NO EVENT SHALL THE AUTHOR OR CONTRIBUTORS BE LIABLE
* FOR ANY DIRECT, INDIRECT, INCIDENTAL, SPECIAL, EXEMPLARY, OR CONSEQUENTIAL
* DAMAGES (INCLUDING, BUT NOT LIMITED TO, PROCUREMENT OF SUBSTITUTE GOODS
* OR SERVICES; LOSS OF USE, DATA, OR PROFITS; OR BUSINESS INTERRUPTION)
* HOWEVER CAUSED AND ON ANY THEORY OF LIABILITY, WHETHER IN CONTRACT, STRICT
* LIABILITY, OR TORT (INCLUDING NEGLIGENCE OR OTHERWISE) ARISING IN ANY WAY
* OUT OF THE USE OF THIS SOFTWARE, EVEN IF ADVISED OF THE POSSIBILITY OF
* SUCH DAMAGE.
*
* The licence and distribution terms for any publically available version or
* derivative of this code cannot be changed. i.e. this code cannot simply be
* copied and put under another distribution licence
* [including the GNU Public Licence.]
*/

```

Security Declaration for data usage

Product Description: PostBase Mini franking machine

The PostBase Mini franking machine is connected to the user's local network through an Ethernet interface to share data with the Francotyp-Postalia Data Centre using both the local network and a suitable available internet connection provided by the user.

Francotyp-Postalia guarantees that the PostBase Mini franking machine does not utilise, transmit, or sort any data from the user's network which is not relevant for the operation of this equipment.

United States Patents

US-Patent-Nr. 5.671.146, 6.579.019, 6.594.648, 6.615.196, 6.623.189, 6.692.166, 6.709.087, 6.771.179, 6.821.040, 7.043.631, 7.103.583, 7.322.764, 7.343.359, 7.606.264, 7.694.010, 7.724.905, 7.996.884, 8.131.959, 8.205.088

Customer Support

Every PostBase Mini is thoroughly checked before leaving the factory. Should any faults occur with your PostBase Mini in spite of our extensive quality control, please contact Francotyp-Postalia help line.

**FP INC. US**

Consumable order phone number: 800-341-6052

Service phone number: 800-341-6052

Internet: www.fp-usa.com

Customer Resource Center:

<http://www.fp-usa.com/postbasemini.cfm>

ReportOne/RemoteOne Download Center:

<http://www.fp-usa.com/remotone.cfm>

**FP Canada Inc.**

Please contact your local FP-partner

Customer Resource Center:

<http://www.francotyp.ca/support/postbasemini.htm>

**Francotyp-Postalia Ltd.**

Consumable order phone number: please contact your local FP-partner

Customer Support phone number: 0344 225 2233

Internet: www.fpmailing.co.uk

Customer Resource Centre: <http://www.postbasemini.co.uk>

fp-francotyp.com

Warranty

For warranty information, refer to the country-specific addendum to the PostBase Mini Operator Manual (*if available in your country*).

51.0053.3800.00 Rev. 00

2014-10 / xxx / helbig berlin