

*** TM 55-1520-228-10**

TECHNICAL MANUAL

**OPERATOR'S MANUAL
ARMY MODEL OH-58 A/C
HELICOPTER**

DISTRIBUTION STATEMENT A: Approved for public release; distribution is unlimited.

*** THIS MANUAL SUPERSEDES TM 55-1520-228-10 AND TM 55-1520-235-10, 7 APRIL 1978, INCLUDING ALL CHANGES.**

HEADQUARTERS, DEPARTMENT OF THE ARMY

17 JANUARY 1989

WARNING

An operating procedure, practice, etc., which, if not correctly followed, could result in personnel injury or loss of life.

CAUTION

An operating procedure, practice, etc., which, if not strictly observed, could result in damage to or destruction of equipment.

NOTE

An operating procedure, condition, etc., which it is essential to highlight.

WARNING

PRECAUTIONARY DATA

Personnel performing operations, procedures and practices which are included or implied in this technical manual shall observe the following warnings. Disregard of these warnings or precautionary information can cause serious injury or loss of life.

WARNING

STARTING ENGINE

Coordinate all cockpit actions with ground observer. Ensure that rotors and blast areas are clear and re guard is posted, if available.

WARNING

FIRE EXTINGUISHER

Exposure to high concentrations of monobromotribluoromethane (CF Br) extinguishing agent or toxic fumes produced by the agent should be avoided. The liquid should not be allowed to come into contact with the skin, as it may cause frostbite or low temperature burns.

WARNING

GROUND OPERATION

Engines will be started and operated only by authorized personnel. Reference AR 95-1.

WARNING

ELECTROLYTE

Battery electrolyte is harmful to the skin and clothing. Neutralize any spilled electrolyte by ushing contacted areas thoroughly with water.

WARNING

CARBON MONOXIDE

When smoke, suspected carbon monoxide fumes, or symptoms of anoxia exist, the crew should immediately ventilate cabin and shut off heater.

WARNING

HANDLING FUEL AND OILS

Turbine fuels and lubricating oil contain additives which are poisonous and readily absorbed through the skin. Do not allow them to remain on skin longer than necessary.

WARNING

HANDLING HYDRAULIC FLUID (MIL-H-83282)

Prolonged contact with liquid or mist can irritate eyes and skin. After prolonged contact with skin, immediately wash contacted area with soap and water. If liquid contacts eyes, flush immediately with clean water. If liquid is swallowed, do not induce vomiting; get immediate medical attention. Wear rubber gloves when handling liquid. If prolonged contact with mist is likely, wear an appropriate respirator. When fluid is decomposed by heating, toxic gases are released.

WARNING

HAZARDOUS CARGO

Items of cargo possessing dangerous physical properties, such as explosives, acids, flammable, etc., must be handled with extreme caution and in accordance with established regulations. Refer to TM 38-250.

WARNING

NOISE

Sound pressure levels in this aircraft during some operating conditions exceed the Surgeon General's hearing conservation criteria as defined in TB MED 501. Hearing protection devices, such as the aviator helmet or earplugs are required to be worn by all personnel in and around the aircraft during its operation.

CHANGE

NO. 17

Headquarters
Department of the Army
Washington, D.C., 19 FEBRUARY 2010

**OPERATOR'S MANUAL
ARMY MODEL OH-58A/C HELICOPTER**

DISTRIBUTION STATEMENT A: Approved for public release; distribution is unlimited.

TM 55-1520-228-10, 17 January 1989, is changed as follows:

1. Remove and insert pages as indicated below. New or changed text material is indicated by a vertical bar in the margin. An illustration change is indicated by a miniature pointing hand.

Remove Pages

A through C/(D blank)
9-7 and 9-8

Insert Pages

A through C/(D blank)
9-7 and 9-8

2. Retain this sheet in front of manual for reference purposes.

By Order of the Secretary of the Army:

Official:



JOYCE E. MORROW
*Administrative Assistant to the
Secretary of the Army*

1003405

GEORGE W. CASEY, JR.
*General, United States Army
Chief of Staff*

Distribution:

To be distributed in accordance with the initial distribution number (IDN) 310230 requirements for TM 55-1520-228-10.

CHANGE

NO. 16

Headquarters
Department of the Army
Washington, D.C., 30 September 2009

**OPERATOR'S MANUAL
ARMY MODEL OH-58A/C HELICOPTER**

DISTRIBUTION STATEMENT A: Approved for public release; distribution is unlimited.

TM 55-1520-228-10, 17 January 1989, is changed as follows:

1. Remove and insert pages as indicated below. New or changed text material is indicated by a vertical bar in the margin. An illustration change is indicated by a miniature pointing hand.

Remove Pages

A through C/(D blank)
9-7 and 9-8

Insert Pages

A through C/(D blank)
9-7 and 9-8

2. Retain this sheet in front of manual for reference purposes.

By Order of the Secretary of the Army:

Official:



JOYCE E. MORROW
*Administrative Assistant to the
Secretary of the Army*

0921 i €

GEORGE W. CASEY, JR.
*General, United States Army
Chief of Staff*

Distribution:

To be distributed in accordance with the initial distribution number (IDN) ~~HF6HE~~
requirements for TM ~~11~~-1520-2G~~1~~-10.

CHANGE
NO. 15

Headquarters
Department of the Army
Washington, D.C., 24 December 2007

OPERATOR'S MANUAL ARMY MODEL OH-58A/C HELICOPTER

DISTRIBUTION STATEMENT A: Approved for public release; distribution is unlimited.

TM 55-1520-228-10, 17 January 1989, is changed as follows:

1. Remove and insert pages as indicated below. New or changed text material is indicated by a vertical bar in the margin. An illustration change is indicated by a miniature pointing hand.

Remove Pages

A through C/(D blank)
5-7 and 5-8
7-81 through 7-85/(7-86 blank)
8-7 and 8-8
9-5 and 9-6
9-13 through 9-15/(9-16 blank)
A-1 and A-2
Glossary-1 and Glossary-2

Insert Pages

A through C/(D blank)
5-7 and 5-8
7-81 through 7-83/(7-84 blank)
8-7 and 8-8
9-5 and 9-6
9-13/(9-14 blank)
A-1/(A-2 blank)
Glossary-1 and Glossary-2

2. Retain this sheet in front of manual for reference purposes.

By Order of the Secretary of the Army:

Official:

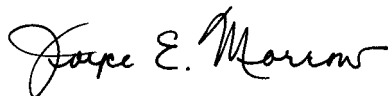

JOYCE E. MORROW
*Administrative Assistant to the
Secretary of the Army*
0733129

GEORGE W. CASEY, JR.
*General, United States Army
Chief of Staff*

DISTRIBUTION:

To be distributed in accordance with Initial Distribution Number (IDN) 310230, requirements for TM 55-1520-228-10.

CHANGE
NO. 14

Headquarters
Department of the Army
Washington, D.C., 31 March 2006

OPERATOR'S MANUAL ARMY MODEL OH-58A/C HELICOPTER

DISTRIBUTION STATEMENT A: Approved for public release; distribution is unlimited.

TM 55-1520-228-10, 17 January 1989, is changed as follows:

1. Remove and insert pages as indicated below. New or changed text material is indicated by a vertical bar in the margin. An illustration change is indicated by a miniature pointing hand.

Remove Pages

a and b
A and B
2-1 through 2-4
2-7 through 2-10
2-13 and 2-14
2-23 and 2-24
2-29 and 2-30
2-35 through 2-38
2-46.1 and 2-46.2
2-49 through 2-52
2-57 and 2-58
3-3 and 3-4
5-1 and 5-2
(5-3 blank)/5-4 through 5-12
6-1 and 6-2
8-5 through 8-8
8-11 through 8-14
9-1 through 9-13/(9-14 blank)

Insert Pages

a and b
A and B
2-1 through 2-4
2-7 through 2-10
2-13 and 2-14
2-23 and 2-24
2-29 and 2-30
2-35 through 2-38
2-46.1 and 2-46.2
2-49 through 2-52
2-57 and 2-58
3-3 and 3-4
5-1 and 5-2
(5-3 blank)/5-4 through 5-12
6-1 and 6-2
8-5 through 8-8
8-11 through 8-14
9-1 through 9-13/(9-14 blank)

Retain this sheet in front of manual for reference purposes.

By Order of the Secretary of the Army:

PETER J. SCHOOMAKER
General, United States Army
Chief of Staff

OFFICIAL:



JOYCE E. MORROW
Administrative Assistant to the
Secretary of the Army

TM 55-1520-228-10
C14

DISTRIBUTION: To be distributed in accordance with Initial Distribution Number (IDN) 310230, requirements for TM 55-1520-228-10.

CHANGE
NO. 13

Headquarters
Department of the Army
Washington, D.C., 30 August 2005

OPERATOR'S MANUAL ARMY MODEL OH-58A/C HELICOPTER

DISTRIBUTION STATEMENT A: Approved for public release; distribution is unlimited.

TM 55-1520-228-10, 17 January 1989, is changed as follows:

1. Remove and insert pages as indicated below. New or changed text material is indicated by a vertical bar in the margin. An illustration change is indicated by a miniature pointing hand.

Remove Pages

A and B
2-11 and 2-12
(5-3 blank) and 5-4

Insert Pages

A and B
2-11 and 2-12
(5-3 blank) and 5-4

Retain this sheet in front of manual for reference purposes.

By Order of the Secretary of the Army:

PETER J. SCHOOMAKER
General, United States Army
Chief of Staff

OFFICIAL:



SANDRA R. RILEY
Administrative Assistant to the
Secretary of the Army

0519202

DISTRIBUTION: To be distributed in accordance with Initial Distribution Number (IDN) 310230, requirements for TM 55-1520-228-10.

CHANGE
NO. 12

Headquarters
Department of the Army
Washington, D.C., 10 June 2005

OPERATOR'S MANUAL ARMY MODEL OH-58A/C HELICOPTER

DISTRIBUTION STATEMENT A: Approved for public release; distribution is unlimited.

TM 55-1520-228-10, 17 January 1989, is changed as follows:

1. Remove and insert pages as indicated below. New or changed text material is indicated by a vertical bar in the margin. An illustration change is indicated by a miniature pointing hand.

Remove Pages

a and b
A and B
2-1 through 2-12
2-27 and 2-28
2-37 and 2-38
2-43 and 2-44
2-49 through 2-52
2-55 through 2-60
2-63 and 2-64
(5-3 blank)/ 5-4
7-79 and 7-80
8-7 and 8-8
9-7 and 9-8

Insert Pages

a and b
A and B
2-1 through 2-12
2-27 and 2-28
2-37 and 2-38
2-43 and 2-44
2-49 through 2-52
2-55 through 2-60
2-63 and 2-64
(5-3 blank)/ 5-4
7-79 and 7-80
8-7 and 8-8
9-7 and 9-8

Retain this sheet in front of manual for reference purposes.

By Order of the Secretary of the Army:

PETER J. SCHOOMAKER
General, United States Army
Chief of Staff

OFFICIAL:



SANDRA R. RILEY
Administrative Assistant to the
Secretary of the Army

0512202

DISTRIBUTION: To be distributed in accordance with Initial Distribution Number (IDN) 310230, requirements for TM 55-1520-228-10.

CHANGE
NO. 11

Headquarters
Department of the Army
Washington, D.C., 1 April 2003

OPERATOR'S MANUAL ARMY MODEL OH-58A/C HELICOPTER

DISTRIBUTION STATEMENT A: Approved for public release; distribution is unlimited.

TM 55-1520-228-10, 17 January 1989, is changed as follows:

1. Remove and insert pages as indicated below. New or changed text material is indicated by a vertical bar in the margin. An illustration change is indicated by a miniature pointing hand.

Remove Pages

a and b
A and B
i through iv
1-1 and 1-2
2-1 through 2-4
2-11 through 2-14
2-17 through 2-20
2-23 through 2-26
2-27 through 2-30
2-33 and 2-34
2-43 and 2-44
2-46.1 and 2-46.2
2-47 through 2-54
2-57 and 2-58
2-61 through 2-67/(2-68 blank)
3-1 through 3-8
3-8.1/(3-8.2 blank)
—
3-11 through 3-14
3-17 through 3-20
3-23 and 3-24
3-24.1/(3-24.2 blank)
3-27 and 3-28
3-31 and 3-32
3-32.1 and 3-32.2
—
3-33 through 3-36
5-1 through 5-10
6-1 through 6-7/(6-8 blank)
7-1 through 7-6
7-59 through 7-62
7-79 and 7-80
7-83 and 7-84
8-1 through 8-8
8-8.1/(8-8.2 blank)
8-9 through 8-12
8-15 through 8-17/(8-18 blank)
9-1 and 9-2
9-7 and 9-8
9-11 through 9-14
A-1/(A-2 blank)

Insert Pages

a and b
A and B
i through iv
1-1 and 1-2
2-1 through 2-4
2-11 through 2-14
2-17 through 2-20
2-23 through 2-26
2-27 through 2-30
2-33 and 2-34
2-43 and 2-44
2-46.1 and 2-46.2
2-47 through 2-54
2-57 and 2-58
2-61 through 2-67/(2-68 blank)
3-1 through 3-8
3-8.1 and 3-8.2
3-8.3 and 3-8.4
3-11 through 3-14
3-17 through 3-20
3-23 and 3-24
3-24.1/(3-24.2 blank)
3-27 and 3-28
3-31 and 3-32
3-32.1 and 3-32.2
(3-32.3 blank)/3-32.4
3-33 through 3-36
5-1 through 5-10
6-1 through 6-7/(6-8 blank)
7-1 through 7-6
7-59 through 7-62
7-79 and 7-80
(7-83 blank)/7-84
8-1 through 8-8
—
8-9 through 8-12
8-15 through 8-17/(8-18 blank)
9-1 and 9-2
9-7 and 9-8
9-11 through 9-14
A-1 and A-2

Remove Pages

Insert Pages

Index-1 through Index-9/(Index-10
blank)

Index-1 through Index-9/(Index-10 blank)

Retain this sheet in front of manual for reference purposes.

By Order of the Secretary of the Army:

ERIC K. SHINSEKI
General, United States Army
Chief of Staff

OFFICIAL:

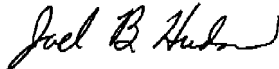

JOEL B. HUDSON
Administrative Assistant to the
Secretary of the Army

0304901

DISTRIBUTION: To be distributed in accordance with Initial Distribution Number (IDN) 310230, requirements for TM 55-1520-228-10.

CHANGE
NO. 10

Headquarters
Department of the Army
Washington, D.C., 28 July 2000

OPERATOR'S MANUAL ARMY MODEL OH-58A/C HELICOPTER

DISTRIBUTION STATEMENT A: Approved for public release; distribution is unlimited.

TM 55-1520-228-10, 17 January 1989, is changed as follows:

1. Remove and insert pages as indicated below. New or changed text material is indicated by a vertical bar in the margin. An illustration change is indicated by a miniature pointing hand.

Remove Pages

a and b
A/(B blank)
i through iv
1-1 and 1-2
2-3 through 2-12
2-17 and 2-18
2-21 and 2-22
—
2-23 and 2-24
—
2-27 through 2-36
2-39 through 2-44
2-49 and 2-50
2-55 and 2-56
2-63 and 2-64
2-65/(2-66 blank)
—
3-1 through 3-4
3-7 and 3-8
—
3-23 and 3-24
3-24.1/(3-24.2 blank)
3-25 through 3-30
3-33/(3-34 blank)
—
4-1 through 4-20
5-1 and 5-2
5-3 and 5-4
5-5 through 5-12
6-1 through 6-6
6-7 and 6-8
6-9/(6-10 blank)
7-1 through 7-4
7-7 through 7-14
7-15/(7-16 blank)
7-17 through 7-46
7-55 and 7-56
7-59 through 7-62
7-77 and 7-78
8-3 through 8-8
—
8-9 through 8-16

Insert Pages

a and b
A and B
i through iv
1-1 and 1-2
2-3 through 2-12
2-17 and 2-18
2-21 and 2-22
2-22.1/(2-22.2 blank)
2-23 and 2-24
2-26.1 and 2-26.2
2-27 through 2-36
2-39 through 2-44
2-49 and 2-50
2-55 and 2-56
2-63 and 2-64
2-65 and 2-66
2-67/(2-68 blank)
3-1 through 3-4
3-7 and 3-8
3-8.1/(3-8.2 blank)
3-23 and 3-24
3-24.1/(3-24.2 blank)
3-25 through 3-30
3-33 through 3-36
3-37/(3-38 blank)
4-1/(4-2 blank)
5-1 and 5-2
(5-3 blank)/5-4
5-5 through 5-12
6-1 through 6-6
6-7/(6-8 blank)
6-9/(6-10 blank)
7-1 through 7-4
7-7 and 7-8
—
—
7-55 and 7-56
7-59 through 7-62
7-77 and 7-78
8-3 through 8-8
8-8.1/(8-8.2 blank)
8-9 through 8-16

Remove Pages

8-17/(8-18 blank)
9-1 and 9-2
9-7 through 9-10
9-13 and 9-14
9-15/(9-16 blank)
A-1/(A-2 blank)
Index-1 through Index-8
Index-9/(Index-10 blank)

Insert Pages

8-17/(8-18 blank)
9-1 and 9-2
9-7 through 9-10
9-13/(9-14 blank)
9-15/(9-16 blank)
A-1/(A-2 blank)
Index-1 through Index-8
Index-9/(Index-10 blank)

Retain this sheet in front of manual for reference purposes.

By Order of the Secretary of the Army:

ERIC K. SHINSEKI
General, United States Army
Chief of Staff

OFFICIAL:

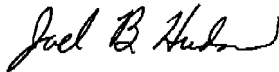

JOEL B. HUDSON
Administrative Assistant to the
Secretary of the Army

0011522

DISTRIBUTION: To be distributed in accordance with Initial Distribution Number (IDN) 310230, requirements for TM 55-1520-228-10.

URGENT

CHANGE
NO. 9

Headquarters
Department of the Army
Washington, D.C., 18 July 1997

OPERATOR'S MANUAL ARMY MODEL OH-58A/C HELICOPTER

DISTRIBUTION STATEMENT A: Approved for public release; distribution is unlimited.

TM 55-1520-228-10, 17 January 1989, is changed as follows:

1. Remove and insert pages as indicated below. New or changed text material is indicated by a vertical bar in the margin. An illustration change is indicated by a miniature pointing hand.

Remove Pages

2-33 and 2-34
3-23 and 3-24
—
3-31 and 3-32
—
8-5 and 8-6

Insert Pages

2-33 and 2-34
3-23 and 3-24
3-24.1/(3-24.2 blank)
3-31 and 3-32
3-32.1 and 3-32.2
8-5 and 8-6

Retain this sheet in front of manual for reference purposes.

By Order of the Secretary of the Army:

ERIC K. SHINSEKI
General, United States Army
Chief of Staff

OFFICIAL:

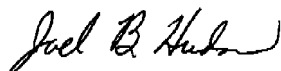

JOEL B. HUDSON
Administrative Assistant to the
Secretary of the Army

03872

DISTRIBUTION: To be distributed in accordance with Initial Distribution Number (IDN) 310230, requirements for TM 55-1520-228-10.

URGENT

CHANGE
NO. 8

Headquarters
Department of the Army
Washington, D.C., 25 June 1996

OPERATOR'S MANUAL ARMY MODEL OH-58A/C HELICOPTER

DISTRIBUTION STATEMENT A: Approved for public release; distribution is unlimited.

TM 55-1520-228-10, 17 January 1989, is changed as follows:

1. Remove and insert pages as indicated below. New or changed text material is indicated by a vertical bar in the margin. An illustration change is indicated by a miniature pointing hand.

Remove Pages

i and ii
2-29 and 2-30
5-7 and 5-8
8-5 and 8-6
9-15/(9-16 blank)

Insert Pages

i and ii
2-29 and 2-30
5-7 and 5-8
8-5 and 8-6
9-15/(9-16 blank)

Retain this sheet in front of manual for reference purposes.

By Order of the Secretary of the Army:

DENNIS J. REIMER
General, United States Army
Chief of Staff

OFFICIAL:

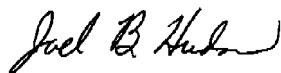

JOEL B. HUDSON
Administrative Assistant to the
Secretary of the Army

01878

DISTRIBUTION: To be distributed in accordance with DA Form 12-31-E, block no. 0230, requirements for TM 55-1520-228-10.

URGENT

URGENT

CHANGE
NO. 7

Headquarters
Department of the Army
Washington, D.C., 30 June 1994

OPERATOR'S MANUAL ARMY MODEL OH-58A/C HELICOPTER

DISTRIBUTION STATEMENT A: Approved for public release; distribution is unlimited.

TM 55-1520-228-10, 17 January 1989, is changed as follows:

1. Remove and insert pages as indicated below. New or changed text material is indicated by a vertical bar in the margin. An illustration change is indicated by a miniature pointing hand.

Remove Pages

2-47 and 2-48
2-51 through 2-54
5-7 and 5-8
8-5 through 8-8

Insert Pages

2-47 and 2-48
2-51 through 2-54
5-7 and 5-8
8-5 through 8-8

Retain this sheet in front of manual for reference purposes.

By Order of the Secretary of the Army:

GORDON R. SULLIVAN
General, United States Army
Chief of Staff

OFFICIAL:

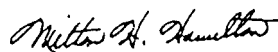

MILTON H. HAMILTON

*Administrative Assistant to the
Secretary of the Army*

06750

DISTRIBUTION: To be distributed in accordance with DA Form 12-31-E, block no. 0230, requirements for TM 55-1520-228-10.

URGENT

CHANGE
NO. 6

Headquarters
Department of the Army
Washington, D.C., 15 April 1992

OPERATOR'S MANUAL ARMY MODEL OH-58A/C HELICOPTER

DISTRIBUTION STATEMENT A: Approved for public release; distribution is unlimited.

TM 55-1520-228-10, 17 January 1989, is changed as follows:

1. Remove and insert pages as indicated below. New or changed text material is indicated by a vertical bar in the margin. An illustration change is indicated by a miniature pointing hand.

Remove Pages

Insert Pages

2-27 and 2-28

2-27 and 2-28

Retain this sheet in front of manual for reference purposes.

By Order of the Secretary of the Army:

GORDON R. SULLIVAN
General, United States Army
Chief of Staff

OFFICIAL:

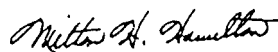

MILTON H. HAMILTON

*Administrative Assistant to the
Secretary of the Army*

00747

DISTRIBUTION: To be distributed in accordance with DA Form 12-31-E, block no. 0230, -10 and CL maintenance requirements for TM 55-1520-228-10.

URGENT

URGENT

CHANGE
NO. 5

Headquarters
Department of the Army
Washington, D.C., 22 July 1991

OPERATOR'S MANUAL ARMY MODEL OH-58A/C HELICOPTER

DISTRIBUTION STATEMENT A: Approved for public release; distribution is unlimited.

TM 55-1520-228-10, 17 January 1989, is changed as follows:

1. Remove and insert pages as indicated below. New or changed text material is indicated by a vertical bar in the margin. An illustration change is indicated by a miniature pointing hand.

Remove Pages

3-27 and 3-28
5-11 and 5-12
8-17/8-18

Insert Pages

3-27 and 3-28
5-11 and 5-12
8-17/8-18

Retain this sheet in front of manual for reference purposes.

By Order of the Secretary of the Army:

GORDON R. SULLIVAN
General, United States Army
Chief of Staff

OFFICIAL:

PATRICIA P. HICKERSON
Colonel, United States Army
The Adjutant General

DISTRIBUTION: To be distributed in accordance with DA Form 12-31-E, block no. 0230, -10 and CL maintenance requirements for TM 55-1520-228-10.

URGENT

URGENT

CHANGE
NO. 4

Headquarters
Department of the Army
Washington, D.C., 31 July 1990

OPERATOR'S MANUAL ARMY MODEL OH-58A/C HELICOPTER

DISTRIBUTION STATEMENT A: Approved for public release; distribution is unlimited.

TM 55-1520-228-10, 17 January 1989, is changed as follows:

1. Remove and insert pages as indicated below. New or changed text material is indicated by a vertical bar in the margin. An illustration change is indicated by a miniature pointing hand.

Remove Pages

2-21 and 2-22

2-45 and 2-46

—

3-23 and 3-24

3-25 and 3-26

Insert Pages

2-21 and 2-22

2-45 and 2-46

2-46.1 and 2-46.2

3-23 and 3-24

3-25 and 3-26

Retain this sheet in front of manual for reference purposes.

By Order of the Secretary of the Army:

CARL E. VUONO
General, United States Army
Chief of Staff

OFFICIAL:

WILLIAM J. MEEHAN II
Brigadier General, United States Army
The Adjutant General

DISTRIBUTION: To be distributed in accordance with DA Form 12-31, block no. 0230, -10 and CL maintenance requirements for TM 55-1520-228-10.

URGENT

URGENT

CHANGE
NO. 3

Headquarters
Department of the Army
Washington, D.C., 6 March 1990

OPERATOR'S MANUAL ARMY MODEL OH-58A/C HELICOPTER

DISTRIBUTION STATEMENT A: Approved for public release; distribution is unlimited.

TM 55-1520-228-10, 17 January 1989, is changed as follows:

1. Remove and insert pages as indicated below. New or changed text material is indicated by a vertical bar in the margin. An illustration change is indicated by a miniature pointing hand.

Remove Pages

Insert Pages

6-7 and 6-8

6-7 and 6-8

Retain this sheet in front of manual for reference purposes.

By Order of the Secretary of the Army:

CARL E. VUONO
General, United States Army
Chief of Staff

OFFICIAL:

WILLIAM J. MEEHAN II
Brigadier General, United States Army
The Adjutant General

DISTRIBUTION: To be distributed in accordance with DA Form 12-31, block no. 0230, -10 and CL maintenance requirements for OH-58A and OH-58C Helicopter, Observation.

URGENT

URGENT

CHANGE
NO. 2

Headquarters
Department of the Army
Washington, D.C., 11 October 1989

OPERATOR'S MANUAL ARMY MODEL OH-58A/C HELICOPTER

DISTRIBUTION STATEMENT A: Approved for public release; distribution is unlimited.

TM 55-1520-228-10, 17 January 1989, is changed as follows:

1. Remove and insert pages as indicated below. New or changed text material is indicated by a vertical bar in the margin. An illustration change is indicated by a miniature pointing hand.

Remove Pages

5-11 and 5-12
8-13 and 8-14

Insert Pages

5-11 and 5-12
8-13 and 8-14

Retain this sheet in front of manual for reference purposes.

By Order of the Secretary of the Army:

CARL E. VUONO
General, United States Army
Chief of Staff

OFFICIAL:

WILLIAM J. MEEHAN II
Brigadier General, United States Army
The Adjutant General

DISTRIBUTION: To be distributed in accordance with DA Form 12-31, block no. 0230, -10 and CL maintenance requirements for OH-58A and OH-58C Helicopter, Observation.

URGENT

CHANGE
NO. 1

Headquarters
Department of the Army
Washington, D.C., 1 February 1990

OPERATOR'S MANUAL ARMY MODEL OH-58A/C HELICOPTER

DISTRIBUTION STATEMENT A: Approved for public release; distribution is unlimited.

TM 55-1520-228-10, 17 January 1989, is changed as follows:

1. Remove and insert pages as indicated below. New or changed text material is indicated by a vertical bar in the margin. An illustration change is indicated by a miniature pointing hand.

Remove Pages

a through c/d
i through iv
1-1 and 1-2
2-1 through 2-4
2-7 through 2-14
2-21 and 2-22
2-25 and 2-26
2-29 and 2-30
2-41 and 2-42
2-51 and 2-52
2-57 and 2-58
3-3 through 3-8
4-1 and 4-2
4-5 through 4-20
5-7 and 5-8
6-1 and 6-2
6-7 and 6-8
—
8-1 through 8-8
9-1 and 9-2
9-9 through 9-15/9-16
A-1/A-2
Index 1 through Index 9/10

Insert Pages

a through c/d
i through iv
1-1 and 1-2
2-1 through 2-4
2-7 through 2-14
2-21 and 2-22
2-25 and 2-26
2-29 and 2-30
2-41 and 2-42
2-51 and 2-52
2-57 and 2-58
3-3 through 3-8
4-1 and 4-2
4-5 through 4-20
5-7 and 5-8
6-1 and 6-2
6-7 and 6-8
6-8.1/6-8.2
8-1 through 8-8
9-1 and 9-2
9-9 through 9-15/9-16
A-1/A-2
Index 1 through Index 9/10

Retain this sheet in front of manual for reference purposes.

By Order of the Secretary of the Army:

CARL E. VUONO
General, United States Army
Chief of Staff

OFFICIAL:

WILLIAM J. MEEHAN II
Brigadier General, United States Army
The Adjutant General

TM 55-1520-228-10
C1

DISTRIBUTION: To be distributed in accordance with DA Form 12-31, block no. 0230, -10 and CL maintenance requirements for OH-58A and OH-58C Helicopter, Observation.

LIST OF EFFECTIVE PAGES

Dates of issue for original and changed pages are:

Original 17 January 1989	Change 9 18 July 1997
Change 1 1 February 1990	Change 10 28 July 2000
Change 2 11 October 1989	Change 11 1 April 2003
Change 3 6 March 1990	Change 12 10 June 2005
Change 4 31 July 1990	Change 13 30 August 2005
Change 5 22 July 1991	Change 14 31 March 2006
Change 6 15 April 1992	Change 15 24 December 2007
Change 7 30 June 1994	Change 16 30 September 2009
Change 8 25 June 1996	Change 17 19 February 2010

TOTAL NUMBER OF PAGES IN THIS PUBLICATION IS 266, CONSISTING OF THE FOLLOWING:

Page No.	*Change No.	Page No.	*Change No.
Cover	0	2-26	11
a	12	2-26.1	10
b	14	2-26.2	10
A	17	2-27	0
B	17	2-28	12
C	17	2-29	0
D Blank	17	2-30	14
i	0	2-31	10
ii	18	2-32	10
iii	14	2-33	11
1-1	11	2-34	11
1-2	10	2-35	10
2-1	14	2-36	14
2-2	12	2-37	14
2-3	10	2-38	12
2-4	14	2-39	0
2-5	12	2-40	10
2-6	0	2-41	10
2-7	14	2-42	10
2-8	14	2-43	12
2-9	10	2-44	12
2-10	14	2-45	4
2-11	13	2-46	4
2-12	12	2-46.1	11
2-13	14	2-46.2	14
2-14	0	2-47	11
2-15	0	2-48	11
2-16	0	2-49	14
2-17	0	2-50	0
2-18	11	2-51	14
2-19	11	2-52	7
2-20	11	2-53	11
2-21	10	2-54	7
2-22	0	2-55	12
2-22.1	10	2-57	0
2-22.2 Blank	10	2-57	11
2-23	14	2-58	14
2-24	11	2-59	0
2-25	0	2-60	12

*Zero in this column indicates an original page.

LIST OF EFFECTIVE PAGES (Cont)

Page No.	*Change No.	Page No.	*Change No.
2-61	11	3-37	0
2-62	0	3-38 Blank	0
2-63	12	4-1	10
2-64	10	4-2 Blank	0
2-65	10	5-1	14
2-66	11	5-2	11
2-67	10	Blank	0
2-68 Blank	0	5-3	14
3-1	11	5-5	14
3-2	10	5-6	14
3-3	14	5-7	15
3-4	14	5-8	10
3-5	11	5-9	11
3-6	0	5-10	14
3-7	10	5-11	2
3-8	11	5-12	14
3-8.2	11	6-1	11
3-8.2	11	6-2	14
3-8.3	11	6-3	11
3-8.4	0	6-4	10
3-9	0	6-5	11
3-10	0	6-6	0
3-11	11	6-7	11
3-12	11	6-8 Blank	0
3-13	11	6-8.1	1
3-14	11	6-8.2 Blank	1
3-15	0	6-9	10
3-16	0	6-10 Blank	0
3-17	11	7-1	11
3-18	11	7-2	11
3-19	11	7-4	0
3-20	11	7-6	11
3-21	0	7-6	0
3-22	0	7-7	0
3-23	11	7-8	0
3-24	11	7-47	0
3-24.1	11	7-48	0
3-24.2 Blank	11	7-49	0
3-25	0	7-50	0
3-26	0	7-51	0
3-27	11	7-52	0
3-28	0	7-53	0
3-29	10	7-54	0
3-30	0	7-55	0
3-31	11	7-56	0
3-32	11	7-57	0
3-32.1	11	7-58	0
3-32.2	11	7-59	0
Blank	11	7-60	0
3-32.3	11	7-61	11
3-33	11	7-63	0
3-34	10	7-64	0
3-35	11	7-65	0
3-36	0	7-66	0

*Zero in this column indicates an original page.

LIST OF EFFECTIVE PAGES (Cont)

Page No.	*Change No.	Page No.	*Change No.
7-67	0	8-12	14
7-68	0	8-13	14
7-69	0	8-14	14
7-70	0	8-15	11
7-71	0	8-16	10
7-72	0	8-17	11
7-73	0	8-18 Blank	0
7-74	0	9-1	14
7-75	0	9-2	14
7-76	0	9-3	14
7-77	10	9-4	0
7-78	10	9-5	14
7-79	0	9-6	15
7-80	12	9-7	17
7-81	0	9-8	17
7-82	15	9-9	14
7-83	15	9-10	14
7-84 Blank	0	9-11	14
8-1	0	9-12	14
8-2	11	9-13	14
8-3	11	9-14 Blank	0
8-4	10	A-1	15
8-5	14	A-2 Blank	0
8-6	11	B-1	18
8-7	14	B-2 Blank	0
8-8	15	Glossary-1	0
8-9	11	Glossary-2	15
8-10	11	Index-1	0
8-11	14	Index-2 Blank	0

*Zero in this column indicates an original page.

OPERATOR'S MANUAL ARMY MODEL OH-58 A/C HELICOPTER

REPORTING ERRORS AND RECOMMENDING IMPROVEMENTS

REPORTING OF ERRORS AND RECOMMENDING IMPROVEMENTS You can improve this manual. If you find any mistakes or if you know of a way to improve these procedures, please let us know. Mail your letter or DA Form 2028 (Recommended Changes to Publications and Blank Forms), located in the back of this manual, directly to: Commander, U.S. Army Aviation and Missile Command, ATTN: AMSAM-MMC-MA-NP, Redstone Arsenal, AL 35898-5000. A reply will be furnished to you. You may also send in your comments electronically to our E-mail address: 2028@redstone.army.mil or by fax 256-842-6546/DSN 788-6546. For the World Wide Web use: <https://amcom2028.redstone.army.mil>. Instructions for sending an electronic 2028 may be found at the back of this manual immediately preceding the hard copy 2028.

TABLE OF CONTENTS

	Page
CHAPTER 1 INTRODUCTION	1-1
CHAPTER 2 HELICOPTER AND SYSTEMS DESCRIPTION AND OPERATIONS	2-1
Section I HELICOPTER	2-1
Section II EMERGENCY EQUIPMENT	2-18
Section III ENGINES AND RELATED SYSTEMS	2-18
Section IV FUEL SYSTEM	2-28
Section V FLIGHT CONTROLS	2-30
Section VI HYDRAULIC SYSTEM	2-32
Section VII POWER TRAIN SYSTEM	2-33
Section VIII MAIN AND TAIL ROTOR GROUPS	2-34
Section IX UTILITY SYSTEM	2-35
Section X HEATING AND VENTILATION	2-35
Section XI ELECTRICAL POWER SUPPLY AND DISTRIBUTION SYSTEM	2-40
Section XII LIGHTING	2-43
Section XIII FLIGHT INSTRUMENTS	2-45
Section XIV SERVICING, PARKING, AND MOORING	2-48
CHAPTER 3 AVIONICS	3-1
Section I COMMUNICATIONS	3-5
Section II NAVIGATION	3-17
Section III TRANSPONDER AND RADAR	3-24.1
Section IV AN/ARC-201 SINGARS RADIO SET	3-34
CHAPTER 4 MISSION EQUIPMENT	4-1
Section I MISSION AVIONICS	4-1
Section II ARMAMENT	4-1
CHAPTER 5 OPERATING LIMITS AND RESTRICTIONS	5-1
Section I GENERAL	5-1
Section II SYSTEMS LIMITS	5-1
Section III POWER LIMITS	5-7
Section IV LOAD LIMITS	5-8
Section V AIRSPEED LIMITS	5-8

TABLE OF CONTENTS (Cont)

	Page
Section VI	5-10
Section VII	5-12
CHAPTER 6	6-1
Section I	6-1
Section II	6-9
CHAPTER 7	7-1
Section I	7-1
Section II	7-6
Section X	7-47
Section XI	7-56
Section XII	7-60
Section XIII	7-62
Section XIV	7-76
Section XV	7-78
Section XVI	7-82
CHAPTER 8	8-1
Section I	8-1
Section II	8-2
Section III	8-11
Section IV	8-11
Section V	8-14
CHAPTER 9	9-1
Section I	9-1
Section II	9-12
GLOSSARY	Glossary-1
INDEX	Index-1

LIST OF ILLUSTRATIONS

Figure	Title	Page
2-1	General Arrangement A	2-2
2-2	General Arrangement C Typical	2-4
2-3	Compartment Diagram A	2-6
2-4	Pilot and Copilot/Observer Station Diagram	2-8
2-5	Principal Dimensions	2-11
2-6	Turning Radius and Ground Clearance	2-13
2-7	Float Gear Equipped Helicopter A	2-14
2-8	Locking Devices for Doors	2-15
2-9	WSPS Configuration	2-17
■ 2-11	Engine	2-20
2-12	Overhead Console	2-22
2-12.1	Overhead Console with AN/ARC-201 (Typical)	2-22.1
2-13	Instrument Panel and Console (Typical) A	2-25
■ 2-14	Instrument Panel and Console C	2-26
2-14.1	Instrument Panel and Console with AN/ARC-201 A (Typical)	2-26.1
2-14.2	Instrument Panel and Console with AN/ARC-201 C (Typical)	2-26.2
2-15	Auxiliary Fuel System	2-29
2-16	Heating and Ventilation A	2-36
■ 2-17	Heater Control and Vent Pull Knobs C	2-38
2-18	Electrical System Schematic	2-41
2-18.1	AAU-32/A Altitude Encode/Pneumatic Altimeter	2-46
2-19	Warning and Caution Panels	2-47

LIST OF ILLUSTRATIONS (Cont)

Figure	Title	Page
2-20	Servicing Diagram A	2-49
2-21	Servicing Diagram C	2-51
2-22	Gravity Refueling With Closed Circuit Receiver	2-59
2-23	Refueling Receptacle	2-61
2-24	Ground Handling Equipment, Covers, Rotor Tiedowns, and Mooring Diagram	2-66
2-25	Paved Surface Mooring Conf guration (OH-58A/C)	2-67
3-1	Antenna Locations	3-4
3-2	Communication System Control Panel C-6533/ARC	3-6
3-3	AN/ARC-114 and AN/ARC-114A Control Panel	3-7
3-4	AN/ARC-115 Control Panel	3-9
3-5	AN/ARC-116 Control Panel	3-10
3-6	UHF/AM Radio Sets AN/ARC-164, RT-1167/ARC-1164(V), and RT-1167C/ARC-1164(V)	3-11 ■
3-8	Voice Security Equipment T/SEC KY-58	3-15
3-9	AN/ARN-89 (ADF) Control Panel	3-18 ■
3-10	Radio Bearing Heading Indicator	3-20
3-11	CONUS Navigation Receiver Control Panel C	3-22
3-12	Course Deviation Indicator (CDI) C	3-23
3-13	Transponder APX-72 Control Panel A	3-26
3-14	Transponder Set Control Panel C	3-29
3-16	Radar Altimeter	3-31 —
3-17	Radar Signal Detecting Set AN/APR-39A(V)1	3-32.4
3-7	AN/ARC-201 Control Panel & Zeroize Switch	3-37
5-1	Instrument Markings A	5-2 —
5-2	Instrument Markings	5-4 —
5-3	Airspeed Operating Limits Chart	5-9 —
5-4	Practice Autorotation Landing Limits Crosswind Components	5-11
6-1	Helicopter Station Diagram	6-1
6-2	Center of Gravity Limit Chart	6-3 —
6-3	Cargo Space	6-4 —
6-4	Fuel Loading Chart	6-5 —
6-5	Personnel Loading	6-6
6-8	Cargo Moment Chart	6-8.1
7-1	Temperature Conversion Chart	7-7
7-11	Maximum Torque Available (30 Minute Operation) Chart C	7-48
7-12	Torque Available (Continuous Operation) Chart C	7-52
7-13	Hover Chart C	7-57
7-15	Cruise Chart C	7-63
7-16	Drag Chart	7-77 ■
7-17	Climb-Descent Chart C	7-79
7-18	Climb Performance C	7-81
7-19	Idle Fuel Flow Chart C	7-83
8-1	Exterior Check Diagram	8-4
8-2	Effects of Wind Azimuth On Aircraft	8-13
9-1	Emergency Exits and Equipment	9-3
9-2	Autorotational Glide Characteristics Chart	9-5
9-3	9-6

CHAPTER 1

INTRODUCTION

1-1. GENERAL.

These instructions are for use by the operator. They apply to Army OH58-A/C Helicopters.

1-2. WARNINGS, CAUTIONS, AND NOTES DEFINED.

Warnings, cautions, and notes are used to emphasize important and critical instructions and are used for the following conditions:

WARNING

Highlights an essential operating or maintenance procedure, practice, condition, statement, etc. which if not strictly observed, could result in injury to, or death of, personnel or long term health hazards.

CAUTION

Highlights an essential operating or maintenance procedure, practice, condition, statement, etc., which, if not strictly observed, could result in damage to or destruction of equipment or loss of mission effectiveness.

NOTE

Highlights an essential operating or maintenance procedure, condition, or statement.

1-3. DESCRIPTION — MANUAL

This manual contains the complete operating instructions and procedures for the Army OH-58A/C helicopter. The primary mission of this helicopter is that of observation and is designed for landing and take off from prepared and unprepared surfaces. The observance of procedures is mandatory except when modification

is required because of multiple emergencies, adverse weather, terrain, etc. Your flying experience is recognized, and therefore, basic flight principles are not included. It is required that THIS MANUAL BE CARRIED IN THE HELICOPTER AT ALL TIMES.

1-4. APPENDIX A, REFERENCES.

Appendix A is a listing of official publications cited within the manual applicable to and available for flight crews.

1-5. INDEX.

The index lists, in alphabetical order, every titled paragraph, figure (F), and table (T) contained in this manual, Chapter 7 performance data has an additional index within the chapter.

1-6. ABBREVIATIONS.

Designator symbols and abbreviations shall be used in conjunction with text contents, headings, and titles to show effectivity of the material. Chapter 7 contains a list of abbreviations used in this publication.

1-7. ARMY AVIATION SAFETY PROGRAM.

Reports necessary to comply with the safety program are prescribed in AR 385-40.

1-8. DESTRUCTION OF ARMY MATERIAL TO PREVENT ENEMY USE.

For information concerning destruction of Army material to prevent enemy use, refer to TM 750-244-1-5.

1-9. FORMS AND RECORDS.

Army aviators flight record and helicopter maintenance records which are to be used by crewmembers are prescribed in DA PAM 738-751 and TM 55-1500-342-23.

1-10. HELICOPTER DESIGNATION SYSTEM.

The designation system prescribed by AR 70-50 is used in helicopter designations as follows:

EXAMPLE OH-58A

The designation system prescribed by AR 70-50 is used in helicopter designations as follows:

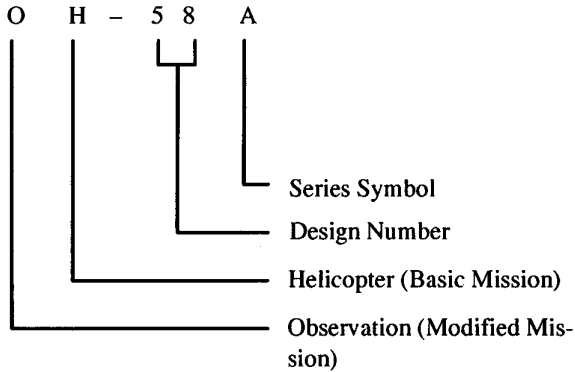

1-11. DESIGNATOR SYMBOLS.

NOTE

All OH-58A and OH-58C model aircraft are now equipped with the T63-A-720 Engine.

Designator symbols **A** OH-58A and **C** OH-58C are used in conjunction with text contents, text headings and illustrations titles to show limited effectivity of the

material. One or more designator symbols may follow a text heading or illustration title to indicate proper effectivity, unless the material applies to all series and configurations within the manual. If the material applies to all series and configurations, no designator symbols will be used. Where practical, descriptive information is condensed and combined for all models to avoid duplication.

NOTE

Armament subsystems are no longer applicable to OH-58A/C aircraft. All references to armament subsystems have been removed from this manual.

1-12. USE OF WORD SHALL, SHOULD, AND MAY.

Within this technical manual the word "shall" is used to indicate a mandatory requirement. The word "should" is used to indicate a non-mandatory, but preferred, method of accomplishment. The word "may" is used to indicate an acceptable method of accomplishment.

CHAPTER 2

HELICOPTER AND SYSTEMS DESCRIPTION AND OPERATIONS

SECTION I HELICOPTER

2-1. GENERAL.

The OH-58A/C helicopter (figure 2-1 **A** and figure 2-2 **C**) is a single engine, observation type helicopter designed for landing and takeoff from prepared or unprepared surfaces. The fuselage consists of the forward section, intermediate or transition section, and the aft or tailboom section. The forward section provides the cabin and fuel cell enclosure as well as pylon support. Entrance to the cabin is provided by two doors on each side. The pilot station (figure 2-3 **A** and figure 2-4 **C**) is located on the right and the copilot/observer station is located on the left side of the helicopter. The area aft of the pilot and copilot may be used as a cargo/passenger compartment. The intermediate section supports the engine and includes the equipment and electronic compartment. The tailboom supports the horizontal stabilizer, vertical stabilizer, and tail rotor. The basic structure of the forward section consists of a lower-curved honeycomb sandwich panel and an upper longitudinal aluminum beam. The core of the sandwich structure is aluminum alloy throughout. The faces are aluminum alloy except in the fuel cell region, where they are fiberglass. The aluminum alloy sandwich panel is capable of withstanding the specified design cargo loadings, while the fiberglass sandwich supports the fuel cell pressures. The rotor, transmission, and engine are supported by the upper longitudinal beam. The upper and lower structures are interconnected by three fuselage bulkheads and a centerpost to form an integrated structure. The most forward and aft bulkheads act as carry-through structure for the skid landing gear crosstubes. The tailboom is a monocoque structure with aluminum skin and aluminum substructure.

a. Dimensions. Principal dimensions of the helicopter areas are shown in figure 2-5.

b. Turning Radius and Ground Clearance. (Refer to figure 2-6.)

c. Weights. The helicopter weight empty and gross operating weight will change according to the configuration or equipment installed for the type of mission to be performed. Refer to Chapter 6, Weight/Balance and Loading.

d. Crew Configuration. The crew consists of the pilot alone, pilot and copilot, or pilot and observer.

2-2. PASSIVE DEFENSE.

The armor protection is a combination of ceramic and fiberglass composite with a small amount of dual hardness steel. The armor protection is removable.

Crew Protection. Armor protection is furnished for the pilot and copilot and consists of panels on seat bottom, seat back, and outboard side of each seat.

2-3. LANDING GEAR SYSTEM.

a. Standard System. The landing gear system is a skid type, consisting of two laterally mounted arched crosstubes, attached to two formed longitudinal skid tubes. Then landing gear structure members are made from formed aluminum alloy tubing with steel skid shoes to minimize skid wear. The gear assembly is attached with straps/clamps at four points to the fuselage structure, therefore, gear removal for maintenance can easily be accomplished. The manually retractable and quickly removable wheel assemblies have been provided to facilitate helicopter ground handling operations.

b. High Skid Gear. The high skid gear, when installed, will provide an approximate additional 14 inches of ground clearance. This will improve landings to be accomplished in snow and rough terrain areas.

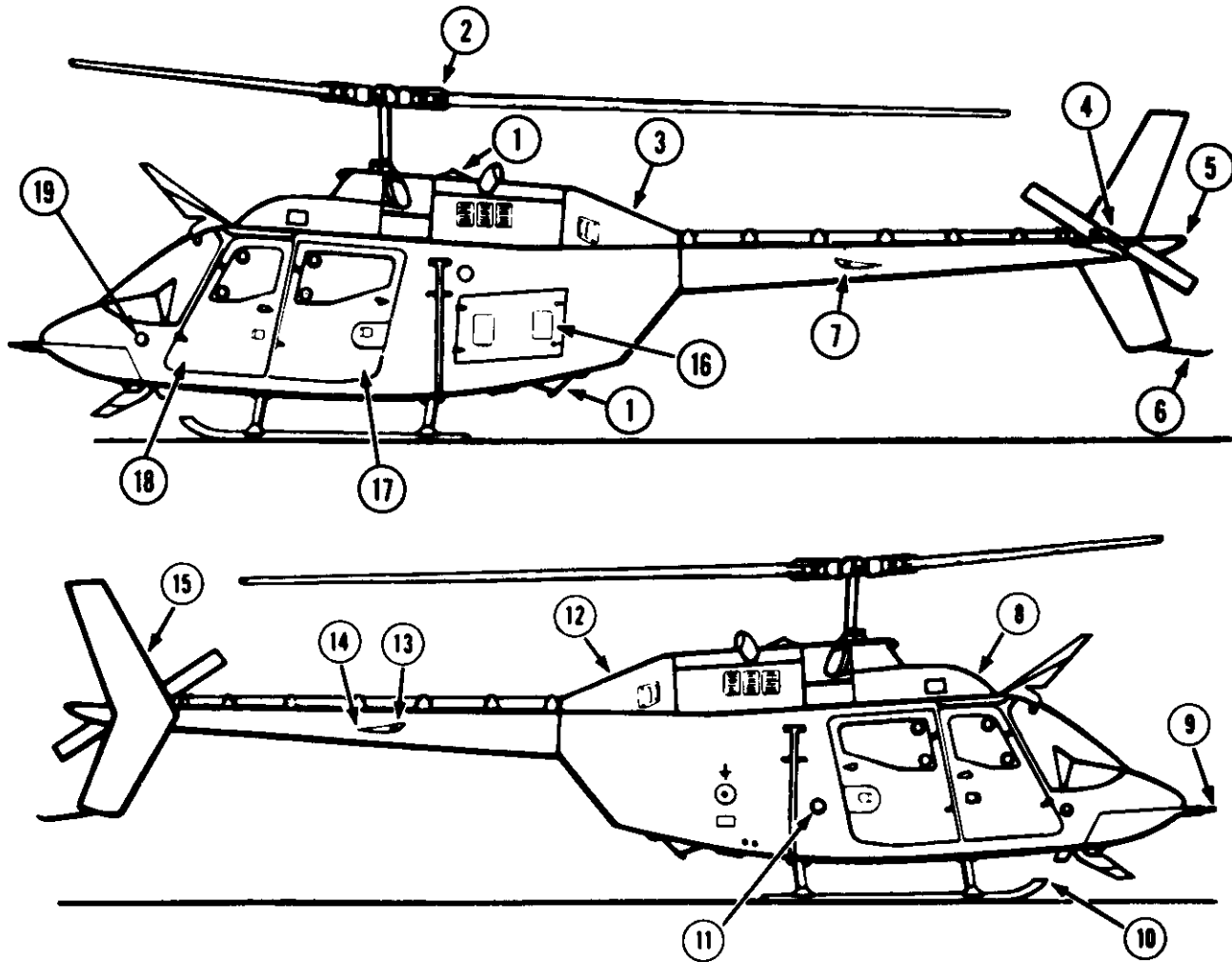

MS026059

- | | |
|--------------------------------------|---|
| 1. Anti-Collision Light | 11. Fuel Filler Cap |
| 2. Main Rotor Hub and Blades | 12. Aft Engine Cowling |
| 3. Engine Oil Tank Drain Access Door | 13. Position Light (Green) |
| 4. Tail Rotor Hub and Blade | 14. Horizontal Stabilizer |
| 5. Position Light (White) | 15. Vertical Fin |
| 6. Tail Skid | 16. Battery and Avionics Compartment Door |
| 7. Position Light (Red) | 17. Passenger Door (Left) |
| 8. Forward Transmission Fairing | 18. Copilot Door |
| 9. Pitot Tube | 19. Left Static Port |
| 10. Landing Gear | |

Figure 2-1. General Arrangement (Sheet 1 of 2)

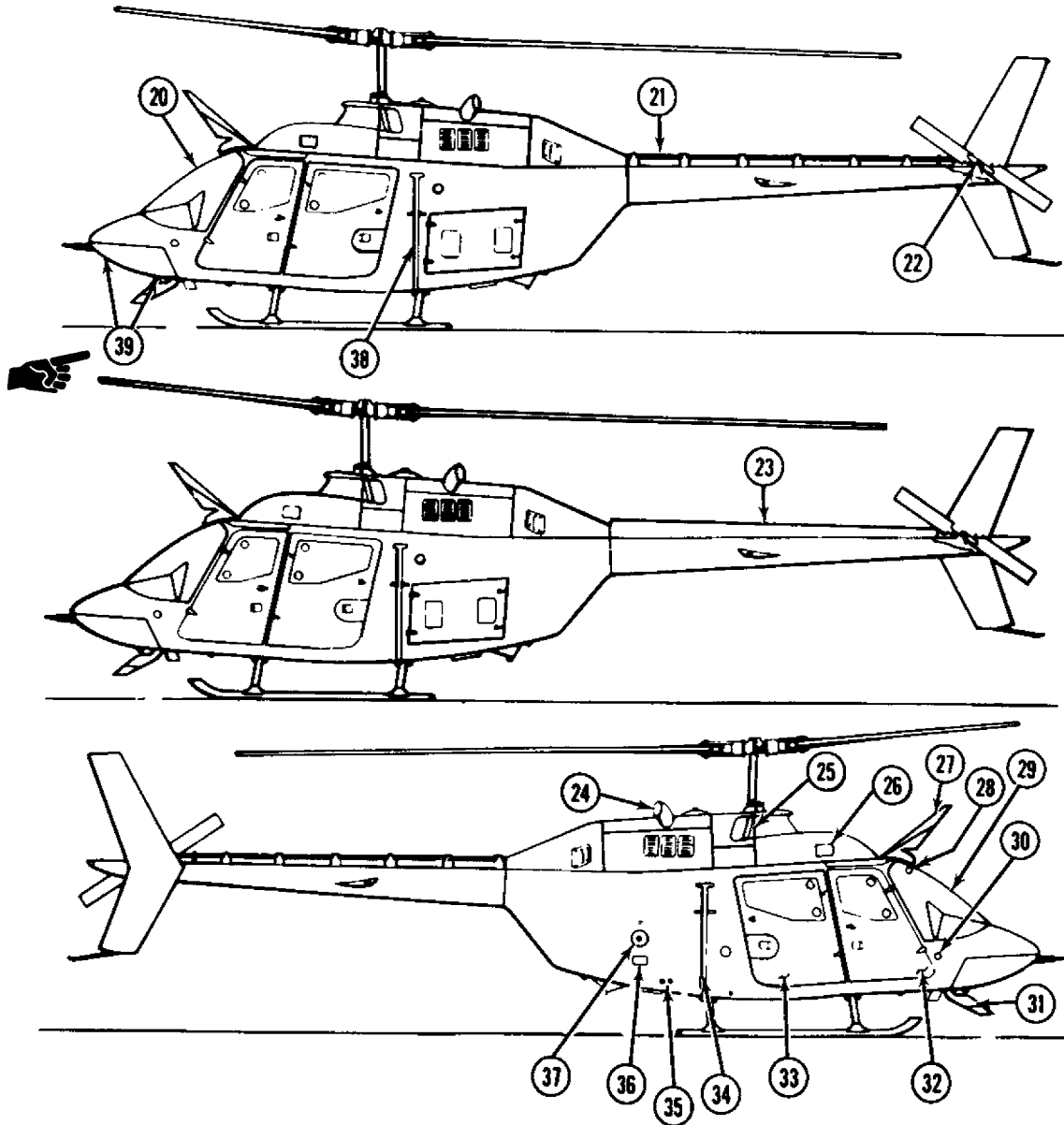

MS026060

- | | |
|--|------------------------------------|
| 20. Windshield | 31. Lower Cutter Assembly |
| 21. Tail Rotor Driveshaft | 32. Pilot Door |
| 22. Tail Rotor Gearbox | 33. Passenger Door (Right) |
| 23. Tail Rotor Driveshaft and Cover (if installed) | 34. FM Homing Antenna (Right Side) |
| 24. Engine Exhaust | 35. Battery Vent |
| 25. Engine Air Inlet | 36. External Power Receptacle |
| 26. Forward Transmission Fairing Inspection Door | 37. Ground Receptacle |
| 27. Upper Cutter Assembly | 38. FM Homing Antenna (Left Side) |
| 28. Free Air Temperature (FAT) Gage | 39. Landing Light |
| 29. Windshield Defector/Cutter Assembly | |
| 30. Right Static Port | |

Figure 2-1. General Arrangement A (Sheet 2 of 2)

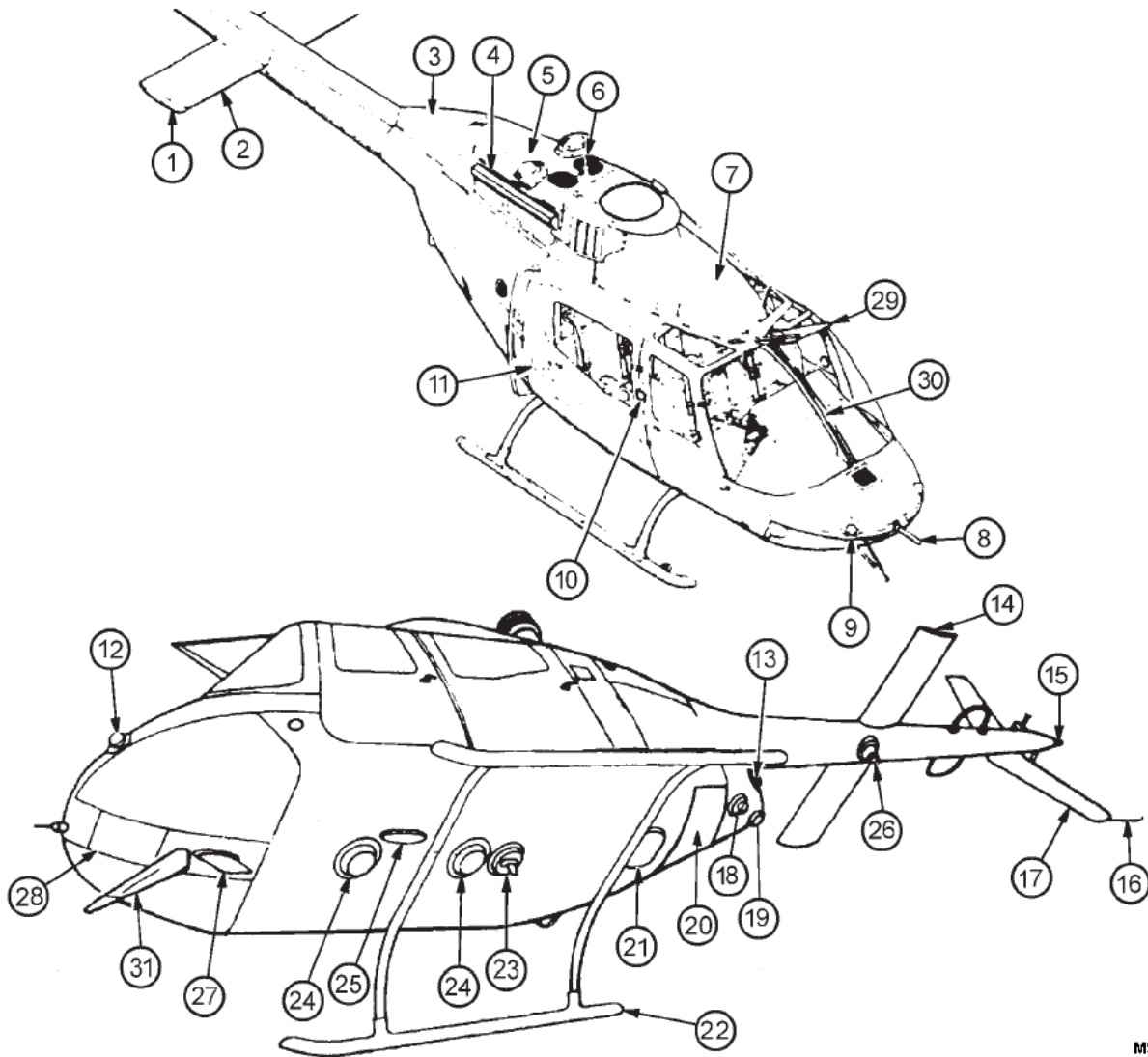

MS019055

- | | |
|--|--|
| 1. Position Light (Green) | 17. Vertical Fin |
| 2. Horizontal Stabilizer | 18. Lower Anti-Collision Light |
| 3. Aft Engine Cowling | 19. Aft Proximity Warning Antenna |
| 4. Infrared Suppression Shield | 20. ADF Sensor Antenna |
| 5. Aft Engine Cowling | 21. ADF Loop Antenna |
| 6. Upper Anti-Collision Light | 22. Landing Gear |
| 7. Forward Transmission Fairing | 23. Radar Warning Blade Antenna |
| 8. Pilot Tube | 24. Radar Altimeter Antenna |
| 9. Right Forward Radar Warning Antenna | 25. Marker Beacon Antenna |
| 10. Door Lock | 26. Transponder Antenna |
| 11. Fuel Filler Cap | 27. UHF Antenna |
| 12. Left Forward Radar Warning Antenna | 28. Landing Light |
| 13. Left Aft Radar Warning Antenna | 29. Upper Cutter Assembly |
| 14. Position Light (Red) | 30. Windshield Deflector/Cutter Assembly |
| 15. Position Light (White) | 31. Lower Cutter Assembly |
| 16. Tail Skid | |

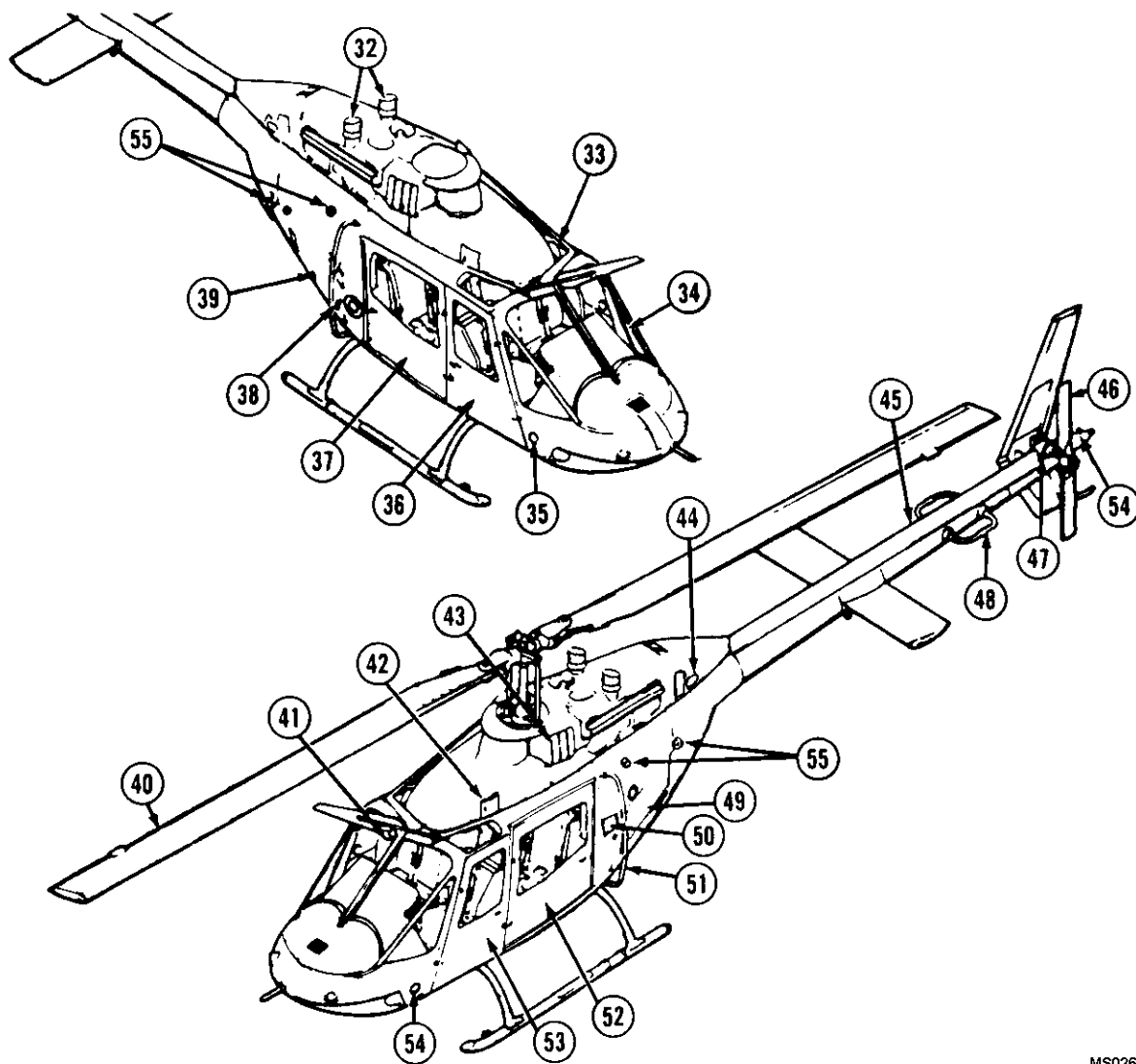

MS026061

- | | |
|--|---|
| 32. Infrared Engine Exhaust | 45. Tail Rotor Driveshaft Cover |
| 33. FM No. 2 Antenna | 46. Tail Rotor Blade and Hub |
| 34. Windshield (Flat Glass) | 47. Tail Rotor Gearbox |
| 35. Right Static Port | 48. VOR Antenna |
| 36. Pilot Door | 49. Battery and Avionics Compartment Door |
| 37. Passenger Door | 50. Step |
| 38. Battery Vent | 51. FM Homing Antenna |
| 39. External Power Receptacle | 52. Passenger Door |
| 40. Main Rotor Blades and Hub | 53. Copilot Door |
| 41. Free Air Temperature (FAT) Gage | 54. Left Static Port |
| 42. Forward Transmission Fairing Inspection Door | 55. NVG Position Lights |
| 43. Engine Air Inlet | 56. Tail Cone |
| 44. Engine Oil Tank Drain Access Door | |

Figure 2-2. General Arrangement  Typical (Sheet 2 of 2)

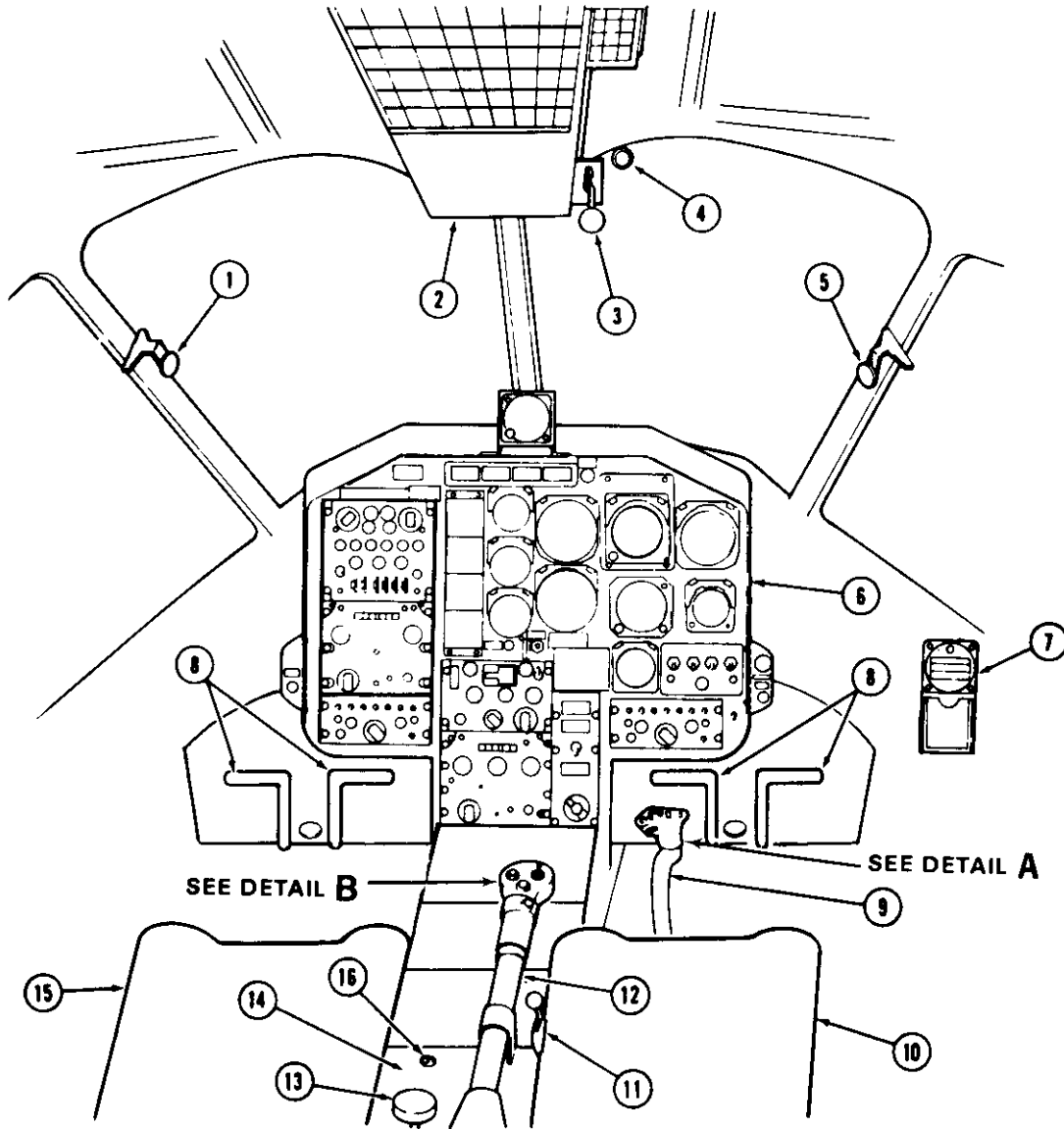

MS026062

- | | |
|---|--|
| 1. Copilot Door Emergency Jettison Handle | 9. Pilot Cyclic Stick |
| 2. Overhead Console | 10. Pilot Seat |
| 3. Fuel Shutoff Valve | 11. Inertia Reel Control Handle |
| 4. Free Air Temperature (FAT) Gage | 12. Pilot Collective Stick |
| 5. Pilot Door Emergency Jettison Handle | 13. Collective Friction Control Adjustment |
| 6. Instrument Panel | 14. Pedestal |
| 7. Magnetic Compass | 15. Copilot Seat |
| 8. Anti-Torque Pedals | 16. Ignition Key Lock Switch |

Figure 2-3. Compartment Diagram A (Sheet 1 of 2)

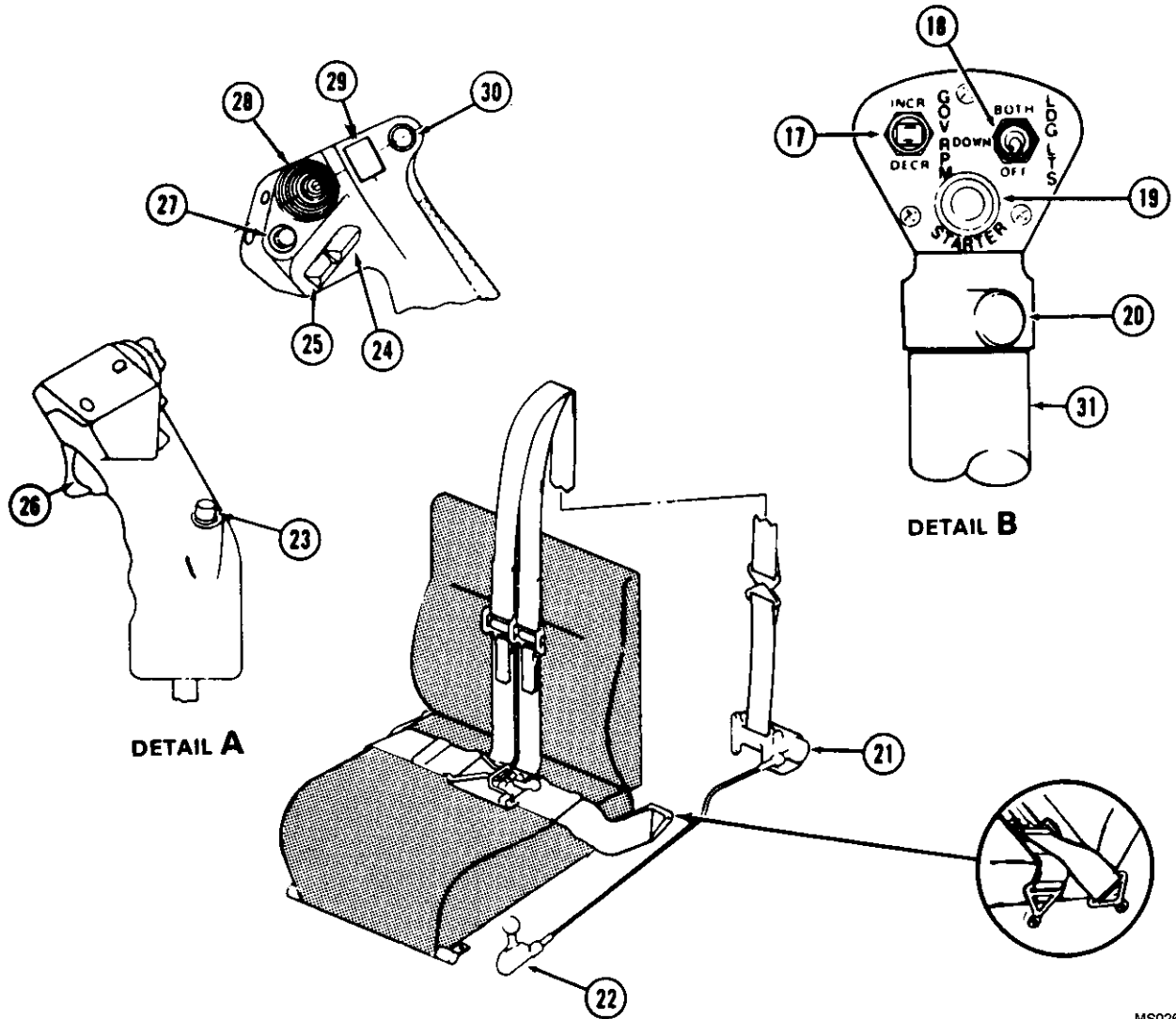

MS026063

- | | | | |
|-----|-----------------------------|-----|-----------------------------------|
| 17. | Governor RPM Switch | 25. | Radio Transmit Switch |
| 18. | Search/Landing Lights | 26. | Not Used |
| 19. | Starter Switch | 27. | Not Used |
| 20. | Engine Idle Release Control | 28. | Not Used |
| 21. | Inertia Reel | 29. | Not Used |
| 22. | Inertia Reel Control Handle | 30. | Force Trim Switch |
| 23. | Not Used | 31. | Throttle |
| 24. | ICS Switch | 32. | Controllable Landing Light Switch |

Figure 2-3. Compartment Diagram A (Sheet 2 of 2)

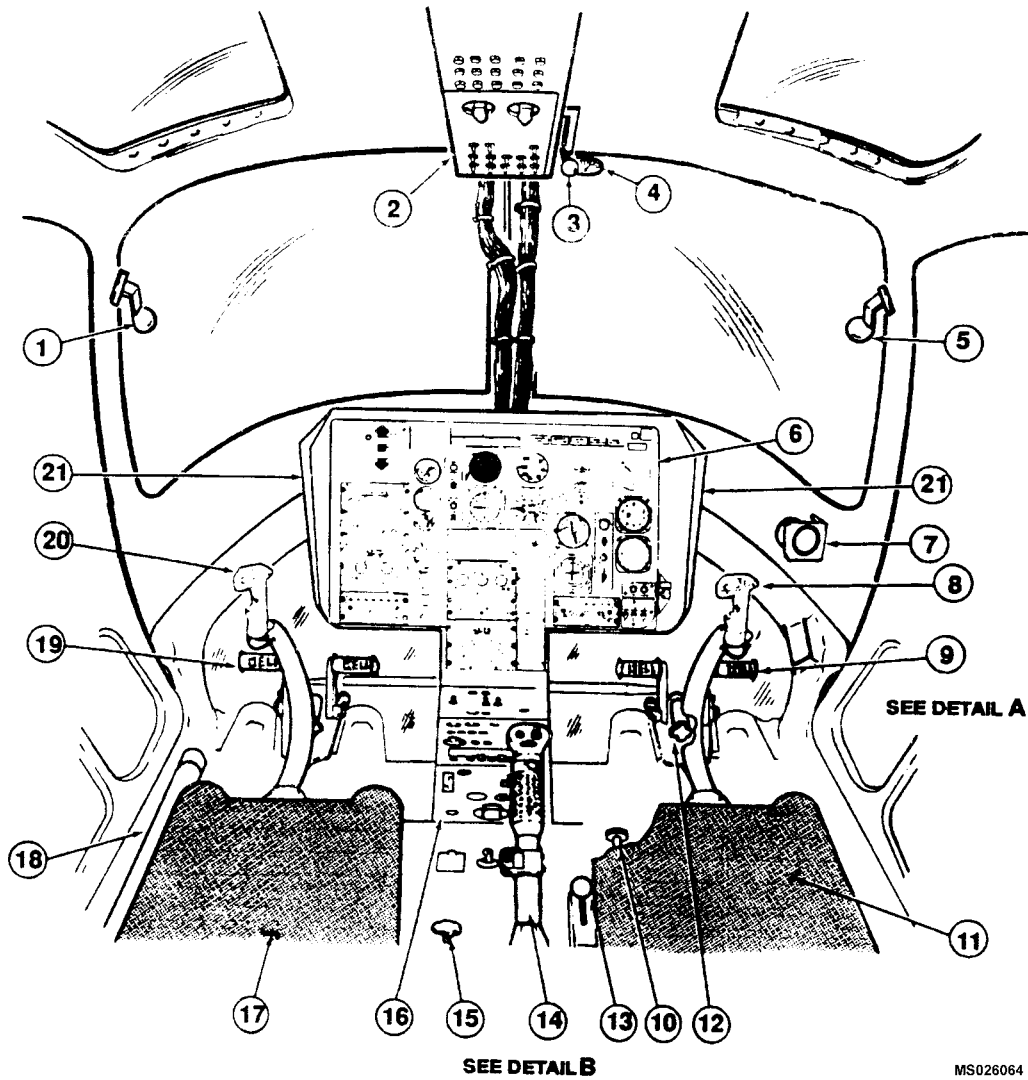

MS026064

NOTE

Round glass model shown

- | | |
|---|--|
| 1. Copilot Door Emergency Jettison Handle | 12. Anti-Torque Pedal Adjuster |
| 2. Overhead Console | 13. Inertia Reel Control Handle |
| 3. Fuel Shutoff Valve | 14. Pilot Collective Stick |
| 4. Free Air Temperature (FAT) Gage | 15. Collective Friction Control Adjustment |
| 5. Pilot Door Emergency Jettison Handle | 16. Console |
| 6. Instrument Panel | 17. Copilot Seat |
| 7. Magnetic Compass | 18. Copilot Collective Stick |
| 8. Pilot Cyclic Stick | 19. Copilot Anti-Torque Pedals |
| 9. Pilot Anti-Torque Pedals | 20. Copilot Cyclic Stick |
| 10. Cyclic Friction Control Adjustment | 21. Glareshield |
| 11. Pilot Seat | |

Figure 2-4. Pilot and Copilot/Observer Station Diagram (Sheet 1 of 3)

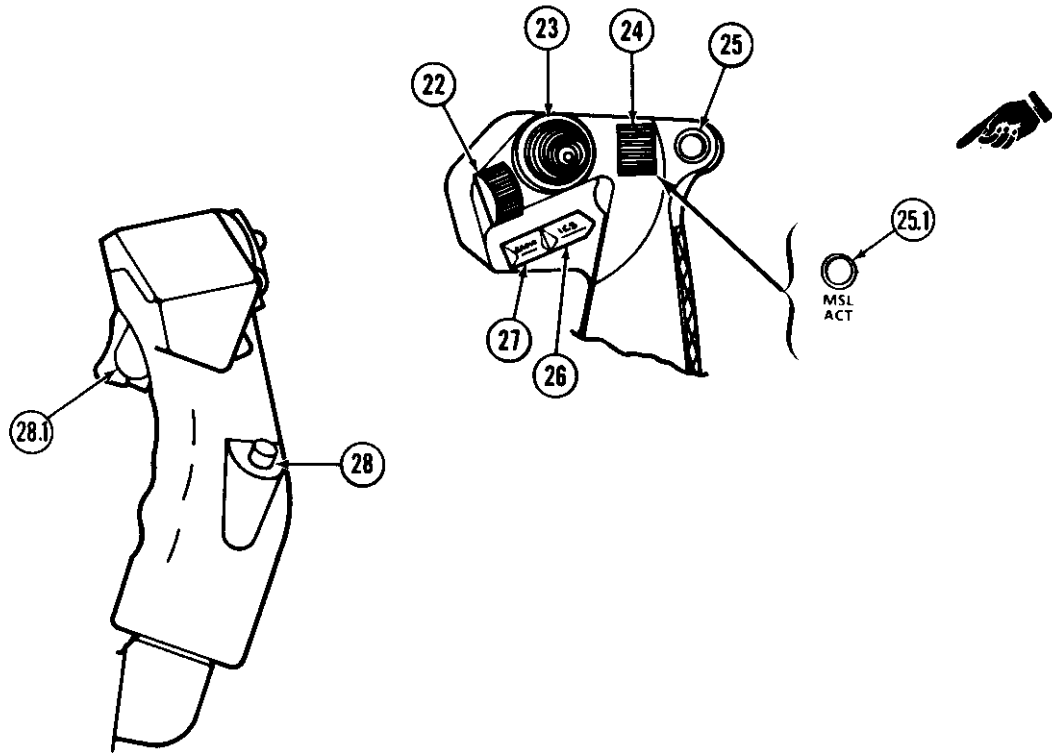

DETAIL A

MS026065

- | | | |
|-----------------------|---------------------------|---|
| 22. Not Used | 26. ICS Switch | ■ |
| 23. Not Used | 27. Radio Transmit Switch | |
| 24. Not Used | 28. Not Used | ■ |
| 25. Force Trim Switch | 28.1 Not Used | ■ |
| 25.1 Not Used | | ■ |

Figure 2-4. Pilot and Copilot/Observer Station Diagram (Sheet 2 of 3)

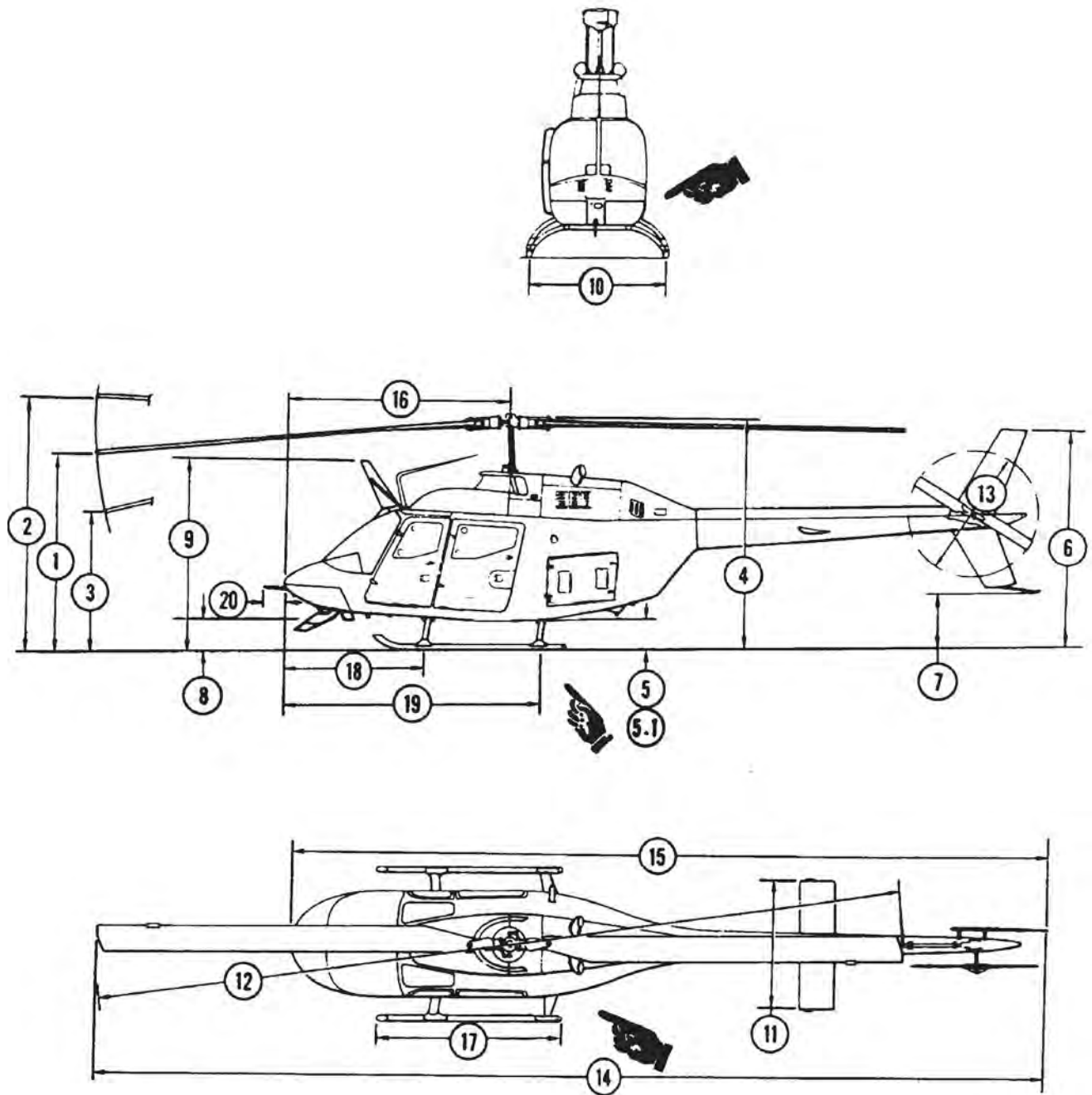

MS019056

Figure 2-5. Principal Dimensions (Sheet 1 of 2)

	HEIGHT	STANDARD SKID GEAR	HIGH SKID GEAR	FLOAT GEAR ^A
1.	Forward Tip of Main Rotor (Static Position to Ground with Droop)	9 ft. 6.0 in.	10 ft. 0.0 in.	9 ft. 7.9 in.
2.	Forward Tip of Main Rotor to Ground (Tie-Down) .	12. ft. 0.0 in.	12 ft. 6.0 in.	12 ft. 1.9 in.
3.	Forward Tip of Main Rotor to Ground (Tie-Down) .	6 ft. 8.0 in.	7 ft. 2.0 in.	6 ft. 10.0 in.
4.	Ground to Top of Main Rotor Reservoirs	9 ft. 7.0 in.	10 ft. 9.0 in.	10 ft. 10.0 in.
5.	Bottom of Cabin	13.0 in.	27.0 in.	28.0 in.
6.	Top of Vertical Stabilizer	8 ft. 1.5 in.	10 ft. 1.5 in.	11 ft. 1.0 in.
7.	Tail Skid to Ground	1 ft. 4.4 in.	3 ft. 4.4 in.	4 ft. 4.0 in.
8.	Lower Cutter to Ground	12.0 in.	2 ft. 2.0 in.	2 ft. 3.0 in.
9.	Upper Cutter to Ground	7 ft. 9.5 in.	9 ft. 9.5 in.	9 ft. 10.5 in.
WIDTH				
10.	Skid Gear	6 ft. 5.4 in.	7 ft. 3.0 in.	11 ft. 6.1 in.
11.	Horizontal Stabilizer	6 ft. 5.2 in.	No Change	No Change
DIAMETERS				
12.	Main Rotor	35 ft. 4.0 in.	No Change	No Change
13.	Tail Rotor	5 ft. 5.0 in.	No Change	No Change
LENGTH				
14.	Overall (Main Rotor Fore and Aft) to Aft End of Tail Skid	40 ft. 11.8 in.	No Change	No Change
15.	Nose of Cabin to Aft End of Tail Skid	32 ft. 2.0 in.	No Change	No Change
16.	Nose of Cabin to Center Line 8 ft. 10.1 of Main Rotor	8 ft. 10.1 in.	No Change	No Change
17.	Skid Gear	8 ft. 1.3 in.	10 ft. 4.2 in.	19 ft. 5.0 in.
18.	Nose of Cabin to Center Line of Forward Cross Tube	6 ft. 0.0 in.	5 ft. 9.4 in.	5 ft. 11.7 in.
19.	Nose of Cabin to Center Line of Aft Forward Cross Tube	10 ft. 9.0 in.	10 ft. 6.3 in.	10 ft. 8.7 in.
20.	Pitot Tube	6.8 in.	No Change	No Change
* Check antennas that may protrude lower				

Figure 2-5. Principal Dimensions (Sheet 2 of 2)

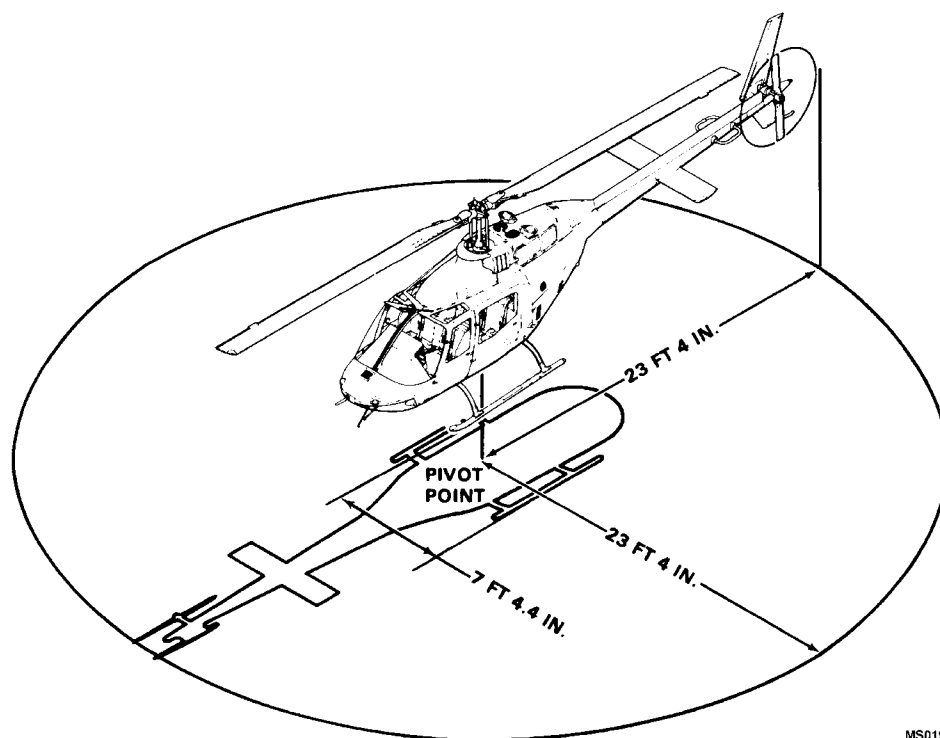

MS019057

Figure 2-6. Turning Radius and Ground Clearance

c. **Float Gear.** The float landing gear (figure 2-7) consists of two streamlined multi-cell inflatable floats, float support tubes, crosstubes, and necessary fittings required to equip the helicopter for water landings. A triangular plate is attached to the tail skid for added controllability and protection of the tail rotor in the event of a tail low water landing. Landing may be made on smooth surfaces that do not have protrusions that could damage floats.

d. **Tail Skid.** A tubular steel tail skid is attached to the lower section of the vertical fin and provides protection for the tail rotor in landings by indicating a tail low condition.

2-4. COCKPIT AND CABIN DOORS.

WARNING

Inadvertent jettisoning of cockpit doors is possible if jettison handle is utilized as a handhold, or hand rest during flight.

Four entrance doors are provided for access to the aircraft interior. The doors are of bonded sheet metal construction with acrylic plastic windows. Each door may be jettisoned by means of emergency jettison handle. All four doors are provided with door lock devices. The pilot door has a padlock while the other three doors have loop locking devices (figure 2-8).

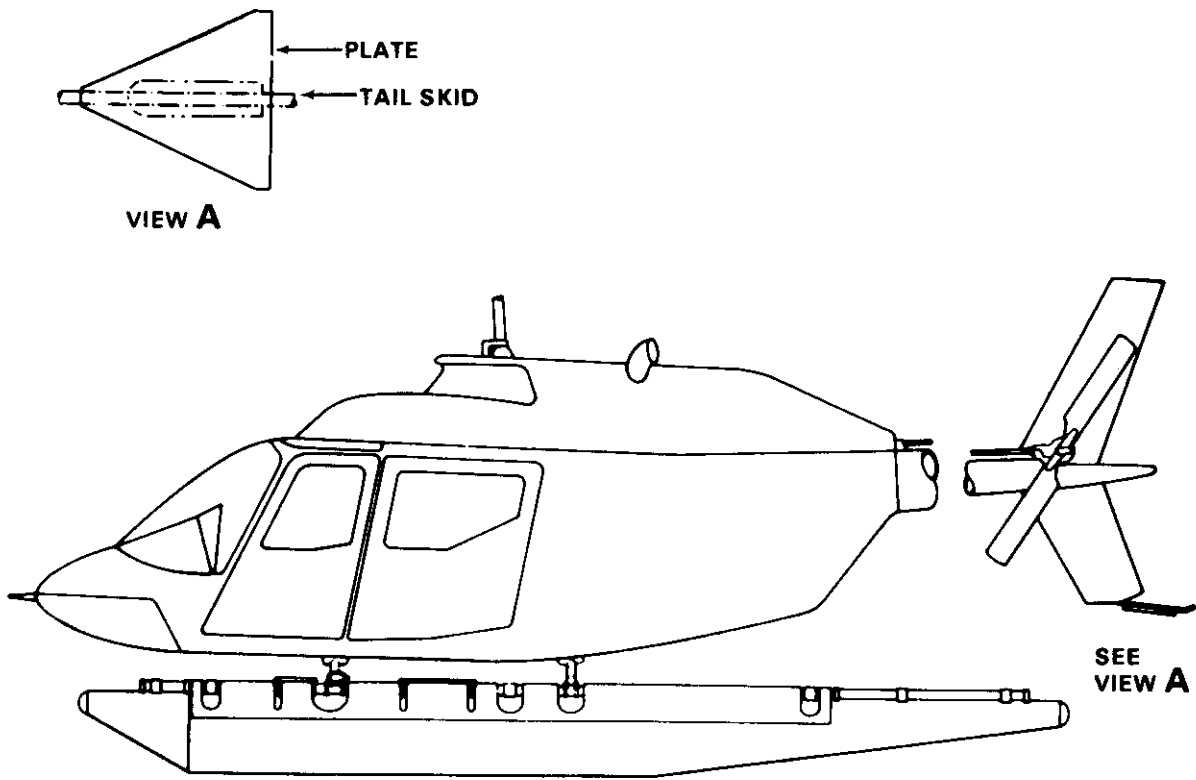

MS026083

Figure 2-7. Float Gear Equipped Helicopter **A**

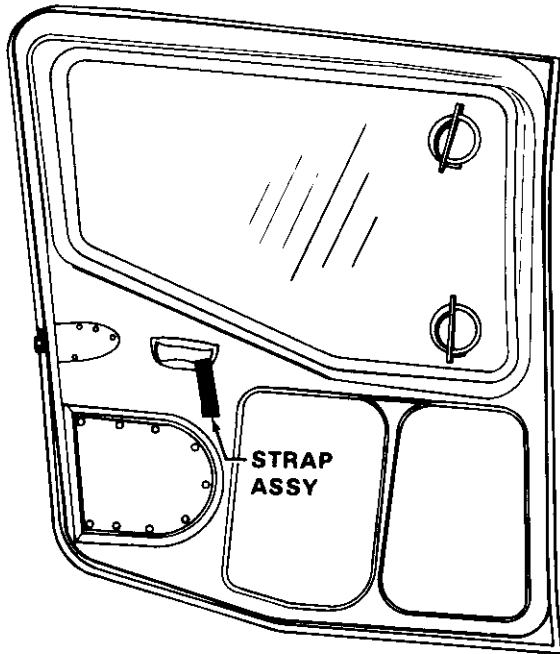

LEFT CABIN DOOR

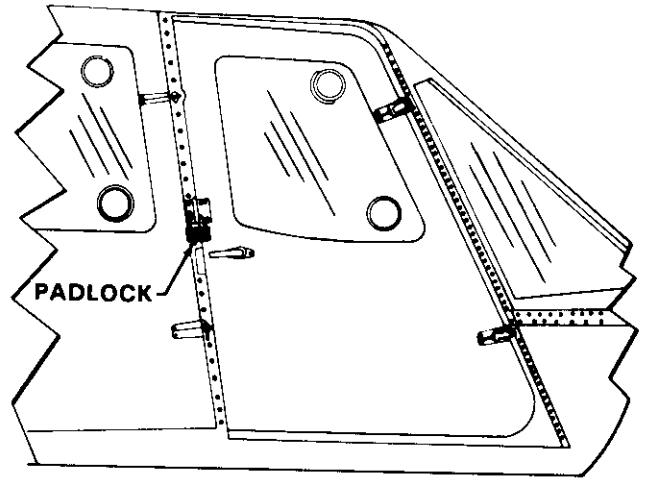

PILOT DOOR

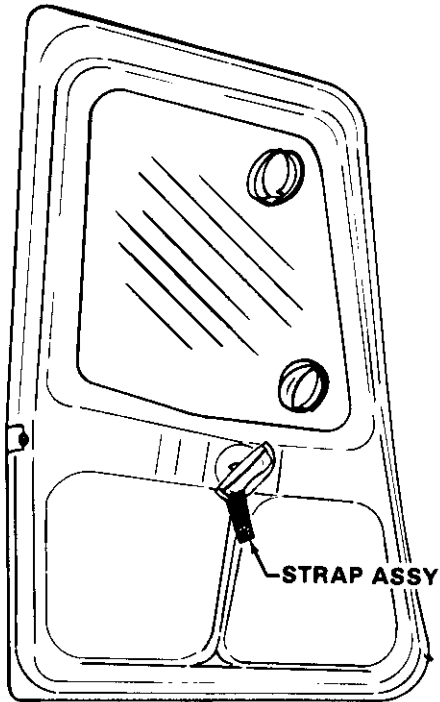

COPILOT/OBSERVER DOOR

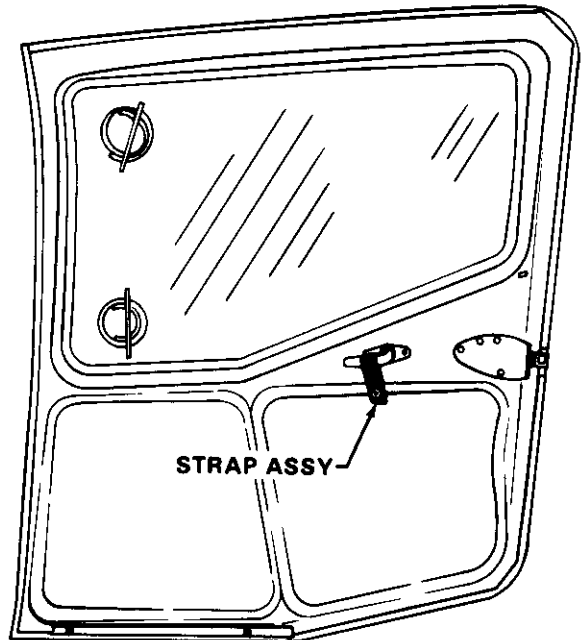

RIGHT CABIN DOOR

MS026068

Figure 2-8. Locking Devices for Doors

2-5. SEATS.

a. Pilot and Copilot/Observer Seats. The pilot and copilot/observer seats are constructed of tubing and stretched nylon material. Each seat is equipped with provisions for cushions, safety belts, and shoulder harness. An inertia reel, with a manually operated control handle, is incorporated on each seat. The inertia reel is a mechanical restraining device that is designed to hold pilot in a normal seated position during any maneuver which would tend to pitch the pilot forward. Each reel is connected to a shoulder harness with a web strap. An automatic locking mechanism, a webbing roller, and a manual control are incorporated in each unit (figure 2-3).

b. Passenger Seats. The passenger seats are constructed of aluminum honeycomb panels and form an integral part of the airframe. The center panel of the seat back is removable to gain access to fuel cell. Seats are equipped with shoulder harness, safety belts, and cushions. Seating is provided for two passengers or without seats, space is provided for cargo (figure 2-3).

2-6. WIRE STRIKE PROTECTION SYSTEM (WSPS).



Flight with the landing light in other than the fully stowed position on OH-58A/C aircraft may degrade the effectiveness of the Wire Strike Protection System (WSPS). When use of the controllable landing light is not anticipated, it should be in the fully stowed position.

The WSPS provides protection against frontal impacts with horizontally strung mechanical and power trans-

mission wires. The basic system consists of an upper cutter assembly, a windshield deflector/cutter assembly, and a lower cutter assembly (figure 2-1 and figure 2-2). The windshield deflector/cutter assembly, consisting of a sawtooth equipped aluminum extrusion, provides deflection mechanism into the upper cutter while simultaneously abrading thus weakening wire and provides additional structural support for the upper cutter mounting. The mechanical cutter assembly (upper and lower) (figure 2-9) consists of a sawtooth equipped deflector section, providing deflection/abrading feature similar to the windshield deflector section, leading into the primary wire cutting mechanism — wedge type cutting blades positioned to provide the necessary mechanical advantage to cut the design objective wires while minimizing load input into the airframe. The lower cutter assembly features a “Breakaway Tip” designed to shear when relatively large ground contact forces are experienced and before the helicopter structural damage is incurred. However, the tip shear rivets are designed to withstand the smaller forces experienced during wire strikes and the tip will still effectively deflect wires into the cutter blades.

a. Wire Strikes. If avoidance is not possible or not effective a wire strike will occur. The protection provided by the WSPS is 90% of frontal area. The cable impact/deflection/cutting sequence of the design objective cables does not have a significant effect on aircraft performance, control, crew functioning or blade flapping.

b. Avoidance. The most effective defense against wire strikes is avoidance. Because of the many different encounters that can occur, it is not possible to provide a procedure to cover every situation. The success in coping with emergency depends on quick analysis of the condition and selection of the proper evasive maneuvers.

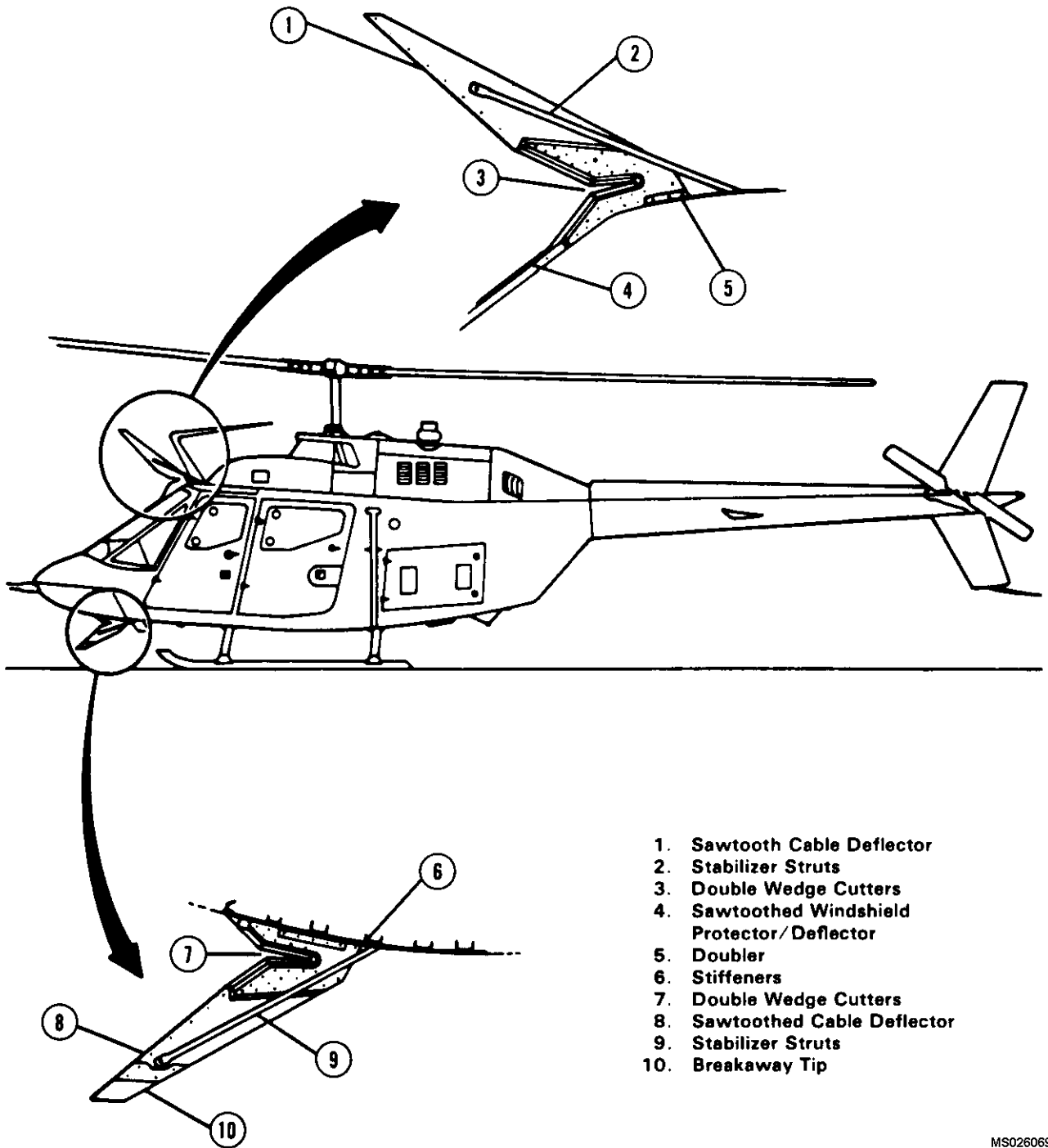

MS026069

Figure 2-9. WSPS Configuration

SECTION II EMERGENCY EQUIPMENT

2-7. FIRST AID KIT.

An aeronautical type first aid kit is located on the right side of the center support column.

A portable fire extinguisher is mounted in a bracket located on the right side of the center support column (figure 9-1).

2-8. FIRE EXTINGUISHER.

SECTION III ENGINES AND RELATED SYSTEMS

2-9. ENGINE.

The OH-58A/C helicopter is equipped with a T63-A-720 turbine engine (figure 2-11). The engine is designed for low fuel consumption, light weight, minimum size, maximum reliability and ease of maintenance. The engine is installed aft of the mast and the passenger compartment. The engine cowl aft of the engine air inlet is removable as a single unit or the hinged section the length of the engine on either side may be opened individually. The aft fairing covers the engine oil cooler, provides tail rotor driveshaft access and provides air intake for the engine oil cooler. The major engine components are as follows:

a. Compressor. Air enters the engine through the particle separator to the compressor inlet and is compressed by six axial compressor stages and one centrifugal stage. The particle separator removes dirt and other contaminants from the incoming air and ejects the dirt out ducts on either side of the fairing. This allows cleaned air to enter the engine compressor section. The compressed air is discharged through the scroll type diffuser into two external ducts which convey the air to the combustion section.

b. Combustion Section. The combustion section consists of the outer combustion case and the combustion liner. A spark igniter and a fuel nozzle are mounted in the aft end of the outer combustion case. Air enters the single combustion liner at the aft end, through holes in the liner dome and skin. The air is mixed with fuel sprayed from the fuel nozzle and combustion takes

place. Combustion gasses move forward out of the combustion liner to the first-stage gas producer turbine nozzle.

c. Turbine. The turbine consists of a gas producer turbine support, a power turbine support, a turbine and exhaust collector support, a gas producer turbine rotor, and a power turbine rotor. The turbine is mounted between the combustion section and the power and accessory gearbox. The two-stage gas producer turbine drives the compressor and accessory gear train. Gas discharged from the gas producer turbine drives the two-stage power turbine which furnishes the output power of the engine. The gas from the power turbine discharges in an upward direction through twin ducts in the turbine and exhaust collector support.

d. Power and Accessories Gearbox. The main power and accessory drive gear train are enclosed in a single gear case. The gear case serves as a structural support of the engine. All engine components including engine mounted accessories are attached to the case. A two-stage helical and spur gear set is used to reduce rotational speed from the power turbine to the output drive spline. Accessories driven by the power turbine gear train (N2) are the power turbine (N2) tachometer-generator, power turbine governor, and torque meter. The gas producer (N1) drives the compressor, and through an associated gear train drives the fuel pump, gas producer (N1) tachometer-generator, gas producer fuel control, starter-generator, and engine oil pump.

■ Figure 2-10. HAS BEEN DELETED.

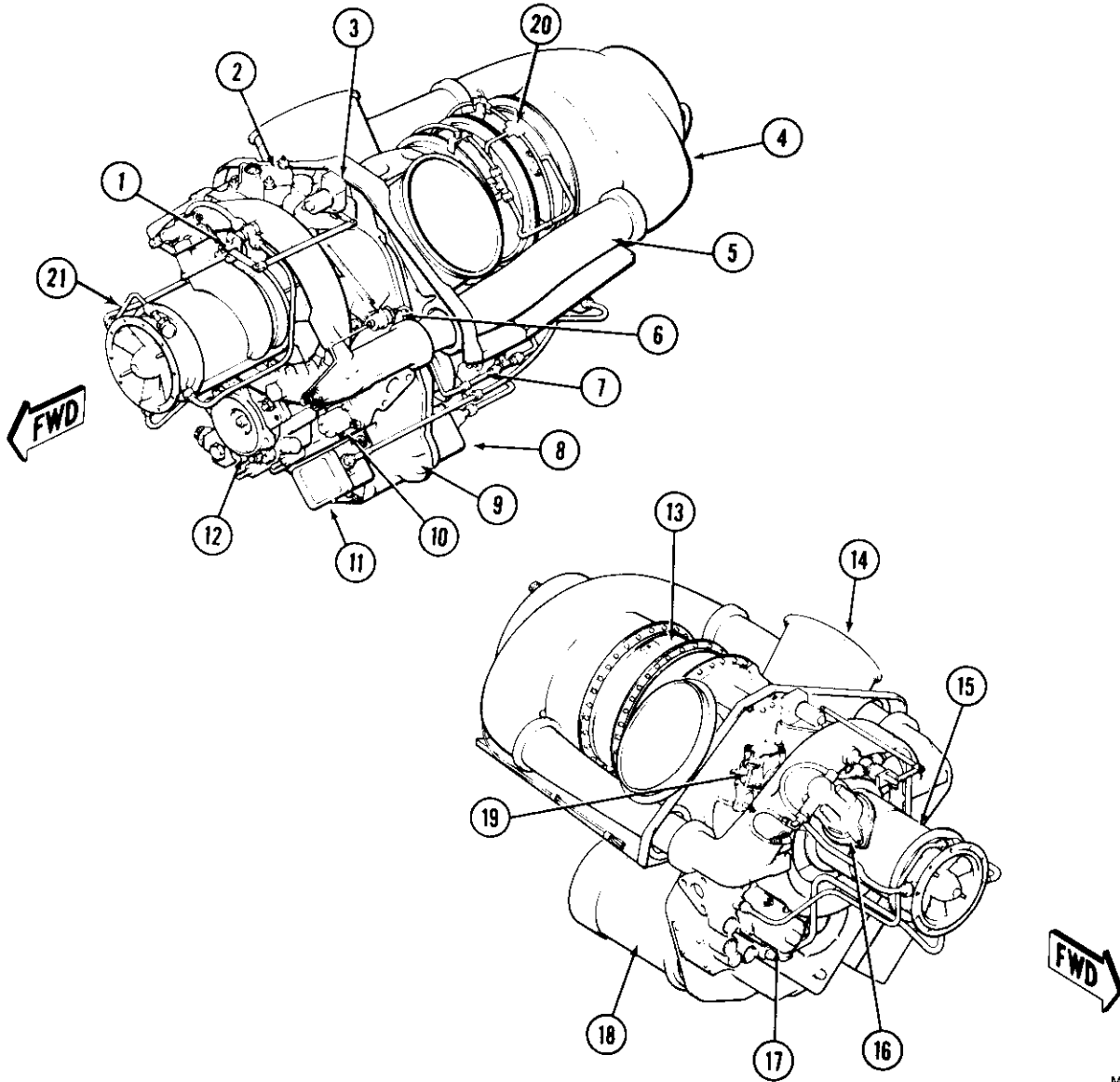

MS026070

- | | |
|--|---|
| 1. Anti-Ice Valve | 12. Freewheeling Unit |
| 2. Oil Filter | 13. Turbine Section |
| 3. Anti-Ice Control Actuator | 14. Exhaust Stack |
| 4. Combustion Section | 15. Compressor Section |
| 5. Compressor Discharge Tubes | 16. Compressor Bleed Valve Assembly |
| 6. Air Filter | 17. Tachometer Generator (Gas Producer) |
| 7. Power Turbine Governor | 18. Starter Generator |
| 8. Fuel Pump and Filter | 19. Oil Pressure Regulator |
| 9. Accessory Gearbox | 20. TOT Harness |
| 10. Tachometer Generator (Power Turbine) | 21. Engine Oil Lines |
| 11. Ignition Exciter Assembly | |

Figure 2-11. Engine

2-10. ENGINE COMPARTMENT COOLING.

Openings are provided on both sides of the engine and top cowling for compartment cooling. The center cowl section houses the engine air inlet, the inlet bellmouth and the forward firewall. Suspended below the engine is a stainless fire shield. Below the fire shield is a titanium floor which acts as a drip pan and also gives insulation from heat.

2-11. INDUCTION SYSTEM.

The engine air inlet system consists of an induction fairing with inlets on each outboard side. This fairing provides mounting for the particle separator. The particle separator removes dirt and other contaminants from the incoming air and ejects the dirt out eductor tubes on either side of the fairing. This allows cleaned air to enter the engine compressor section. Removable reverse flow inlet fairings may be installed over the air inlets on modified induction fairings. These reverse flow fairings minimize ram effect of falling or blowing snow, thus permitting effective operation of the particle separator and preventing engine flame-out caused by ingestion of snow.

a. Intake Ducting. The engine air intake ducting consists of louvered openings and a large circular air inlet opening. The louvered openings are located on left and right cowl panels.

b. Particle Separator. Foreign matter is removed from the engine inlet air by a centrifugal-type particle separator. The particle separator consists of a group of separator tube assemblies arranged in rows and positioned in a front and rear sheetmetal panel and a scavenge system. The separator tube assemblies consist of an inlet tube, a swirl tube which is bonded inside the inlet tube, and an outlet tube. The scavenge system consists of a bleed air manifold, bleed air nozzles, and ejector tubes which are contained in two ejector boxes located beneath the separator tube assemblies. The bleed air manifold is attached to the ejector boxes and is connected directly to the engine compressor scroll with bleed air inlet fittings. Air enters the inlet tube and is spun by the swirl tube. Clean air then enters the engine inlet plenum chamber through the outlet tube while for-

ign material is centrifuged into the scavenge system. The foreign material is ejected overboard by the vacuum-cleaner effect created by engine bleed air as it is discharged through venturies in the eductor tubes. Reverse flow inlet fairings may be attached to the engine air inlets. These sheet metal fairings make it impossible for air to enter the plenum chamber without first making two 180° turns. These abrupt changes in airflow greatly reduce the probability of engine flame-out associated with snow ingestion.

2-12. ENGINE INLET ANTI-ICING SYSTEM

The compressor inlet guide vanes and front bearing support hub are the only engine components with anti-icing provision. Anti-icing is provided by the use of compressor bleed air. Anti-icing is actuated by placing ENG DEICE switch on overhead console (figure 2-12) to ENG DEICE position.

2-13. ENGINE FUEL CONTROL SYSTEM.

The system controls engine power output by controlling the gas producer speed. Gas producer speed levels are established by the action of the power turbine fuel governor which senses power turbine speed. The power turbine (load) speed is selected by the operator and power required to maintain this speed is automatically maintained by power turbine governor action on metered fuel flow. The power turbine governor lever schedules the power turbine governor requirements. The power turbine governor schedules the gas producer speed to a changed power output to maintain output shaft speed.

a. Deleted.

b. Throttle. Rotating the throttle (figure 2-4) to the full open position allows the power turbine governor to maintain a constant rpm. Rotating the throttle toward the closed position will cause the rpm to be manually selected instead of automatically selected by the power turbine governor. Rotating the throttle past the engine-idle stop to the fully closed position shuts off fuel flow. A manually operated idle stop is incorporated to prevent inadvertent throttle closure. The idle stop is controlled by the engine idle release control (figure 2-4).

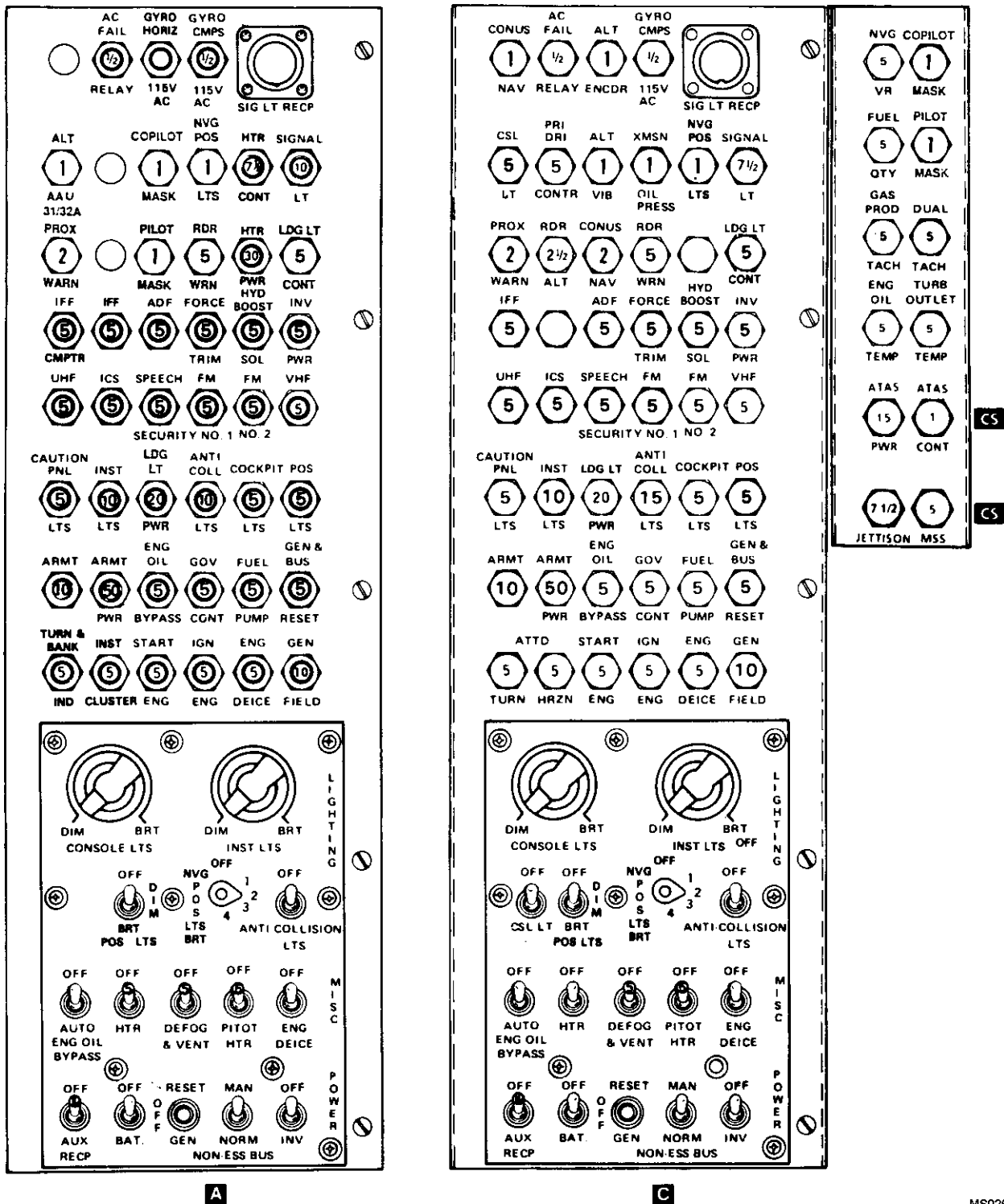

Figure 2-12. Overhead Console

MS026132

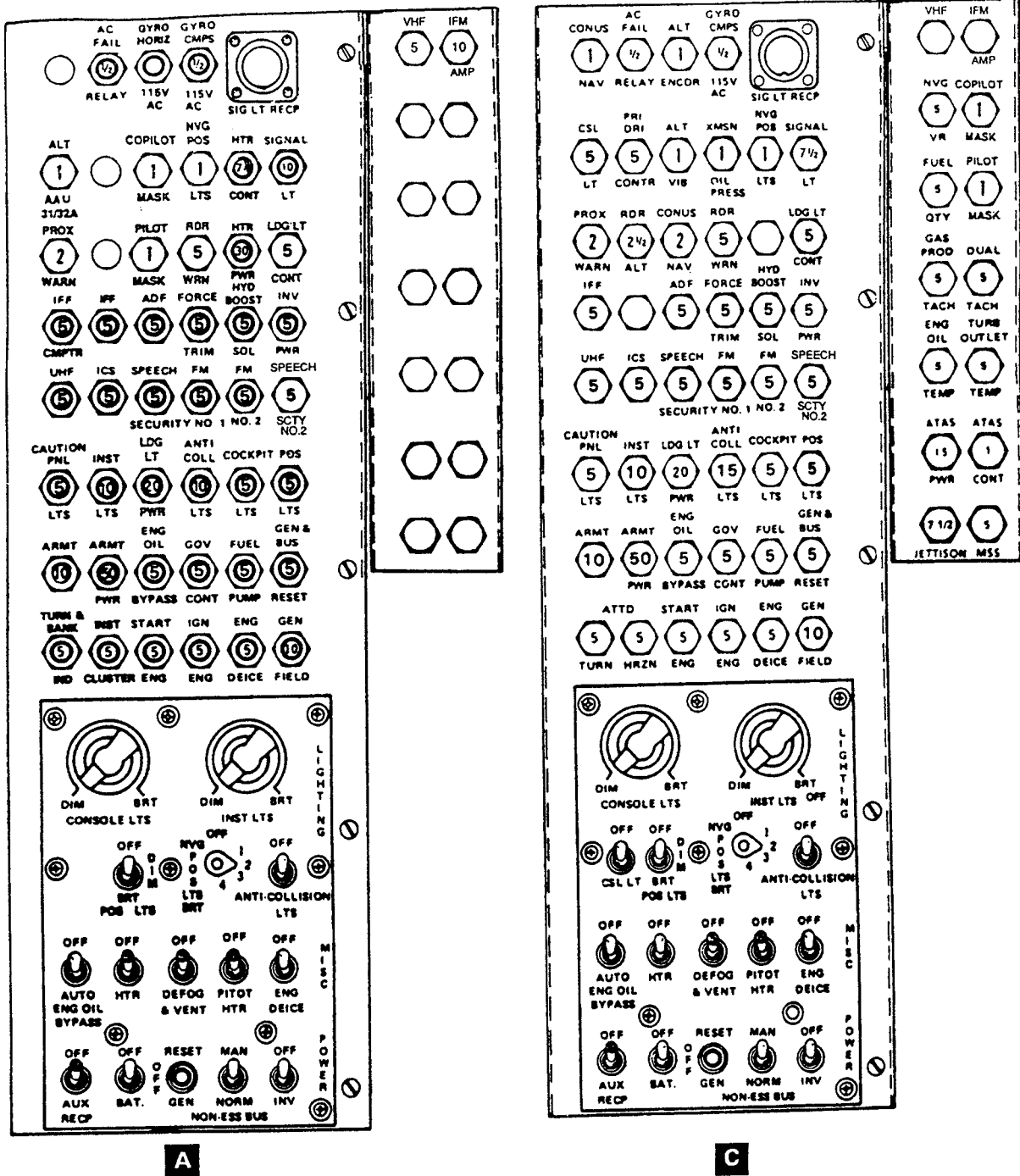

Figure 2-12.1. Overhead Console with AN/ARC-201 (Typical)

MS027891

c. Droop Compensator. A droop compensator maintains engine rpm (N2) as power demand is increased. The compensator is a direct mechanical linkage between the collective stick and the speed selector lever on the N2 governor. Droop is defined as the speed change in N2 rpm as power is increased from a no-load condition. Without droop compensation, instability would develop as engine output is increased, resulting in N1 speed overshooting or hunting the value necessary to satisfy the new power condition. If N2 power is allowed to droop, other than momentarily, the reduction in rotor speed could become critical.

d. Engine Idle Release Control. The engine idle release is a spring loaded plunger mounted on the switch box of the pilot collective stick (figure 2-3 and figure 2-4). The plunger prevents the pilot from accidentally retarding the throttle beyond engine idle position. This acts as a safety feature by preventing inadvertent engine shutdown. The plunger need not be depressed when performing an engine start or runup; however, the plunger must be depressed when accomplishing an engine shutdown or when it is desired to retard the power control below the engine idle position.

e. Governor RPM Switch. The GOV INCR/DECR switch is mounted on the pilot collective stick (figure 2-3 and 2-4). The switch is a three-position momentary type and is held in the INCR position (FWD) to increase the power turbine (N2) speed or DECR position (AFT) to decrease the power turbine (N2) speed. Regulated power turbine speed may be adjusted in flight through the operating range by movement of the switch as required.

f. Gas Producer Fuel Control. The gas producer fuel control has a bypass valve, metering valve, acceleration bellows, governing and enrichment bellows,

manually operated cutoff valve, maximum pressure relief valve, and a torque tube seal and lever assembly. A maximum pressure relief valve is incorporated to protect the system from excessive fuel pressure.

g. Power Turbine Governor. The power turbine speed is scheduled by the power turbine governor lever and the power turbine speed scheduling cam. The cam sets a governor spring load which opposes a speed-weight output. Overspeed protection of the power turbine governor becomes effective at approximately 108% N2. This governing action will result in a pulsating increase/decrease of engine power.

h. Deleted.

i. Fuel Pump and Filter Assembly. The fuel pump and filter assembly incorporates a single gear-type pumping element, a low pressure barrier filter, a filter bypass valve, and a bypass pressure regulating valve. Fuel enters the engine fuel system at the inlet port of the pump and passes through the low pressure filter before entering the gear element. The filter bypass valve allows fuel to bypass the filter element if it becomes clogged. The bypass return flow from the fuel control is passed back to the inlet of the gear element through a pressure regulating valve which maintains the bypass flow pressure above inlet pressure.

j. Deleted.

k. Fuel Nozzle. The fuel nozzle is a single-entry dual orifice type unit which contains an integral valve for dividing primary and secondary flow.

l. Deleted.

2-14. INFRARED SUPPRESSION SYSTEM.

The infrared suppression system is specially formulated to reduce detection of IR-seeking missiles. The system consists of two exhaust stacks located at the top of the engine cowling and two shields located on the side engine cowling (figure 2-2). The exhaust stacks have cooling fins and a shield around them to reduce the infrared signature of the hot engine exhaust. The shields on the side engine cowling prevent detection of the hot engine area from the sides.

2-15. TEMPERATURE MEASUREMENT SYSTEM.

The temperature measurement system consists of four chromel-alumel single junction thermocouples in the gas producer turbine outlet and an associated integral harness. The voltages of the four thermocouples are electrically averaged in the assembly lead to the airframe terminal block for reference to the engine temperature indicating system.

2-16. COMPRESSOR BLEED AIR SYSTEM.

The 5th stage compressor bleed valve permits rapid engine response. The system consists of a compressor discharge pressure sensing port on the scroll, tubing from the sensing port to the bleed valve, a compressor bleed control valve, and a bleed air manifold on the compressor case. Elongated slots between every other vane in the compressor 5th stage bleeds compressor air into a manifold which is an integral part of the compressor case. The manifold forms the mounting flange for the compressor bleed control valve when the compressor case halves are assembled. Compressor discharge air pressure sensing for bleed control valve operation is obtained at a sensing port of the compressor scroll. The bleed control valve is normally open. It is closed by compressor discharge pressure.

2-17. ENGINE OIL SUPPLY SYSTEM.

The lubricating system is a dry sump type with an external reservoir and heat exchanger. A gear type pressure and scavenge pump assembly is mounted within the power and accessory gearbox. The oil filter, filter bypass valve, and pressure regulating valve are in a unit which is located in the upper right side of the power and accessory gearbox housing and are accessible from the top of the engine. The oil tank is mounted aft of the engine rear firewall on top of the intermediate cabin section. A check valve is located between the housing and the filter unit. Probe type magnetic chip detectors are installed at the bottom of the power accessory gearbox and the engine oil outlet connection. All engine oil sys-

tem lines and connections are internal with the exception of pressure and scavenge lines to the front compressor support, the gas producer turbine support, and the power turbine support. The oil cooler blower is an integral part of the tail rotor drive and is located aft of the freewheeling unit and adjacent to the oil tank.

2-17.1. ENGINE OIL SUPPLY SYSTEM – EXTERNAL SCAVENGE OIL FILTER (AFTER COMPLIANCE WITH MWO 55-1520-228-50-44).

The in-line external scavenge oil filter is located above the tail rotor drive shaft, behind the engine oil tank. The filter assembly consists of a filter element, oil bypass indicator, and bypass valve. When the filter element becomes clogged, it will give a warning by extending the oil bypass (red) indicator. The indicator extends when a set differential pressure across the filter is exceeded. When in the reset position, the indicator will be hidden from view. If the indicator is extended, it can be reset by pressing in. An extended indicator is not sufficient reason to ground the helicopter. If filter bypass indicator (red button) is showing, reset indicator, ground run engine, and reinspect. If indicator red button is not showing after ground run, aircraft may be released for operation. If indicator red button is showing, do not fly aircraft, notify maintenance.

2-18. IGNITION SYSTEM.

a. The engine ignition system consists of a keylock ignition switch, a low tension capacitor discharge ignition exciter, a spark igniter lead, and a shunted surface gap spark igniter. The system derives its input power from the helicopter 28-volt DC electrical system.

b. The keylock ignition switch (figure 2-13 and figure 2-14) locks out the starter system and prevents unauthorized use of the helicopter, thereby preventing possible injury to personnel and/or damage to the equipment.

2-19. STARTER SWITCH.

The starter switch (figure 2-3 and figure 2-4), located in the collective stick switch box, is a push button type switch. When the switch is pressed, the circuit to the starter relay actuating coil, the igniter unit, and the fuel boost pump are energized. The switch is released when the engine start cycle is completed or abort start procedure is completed. The keylock ignition switch must be ON to complete the ignition circuit. The circuit is protected by the START ENG, IGN ENG and FUEL PUMP circuit breakers.

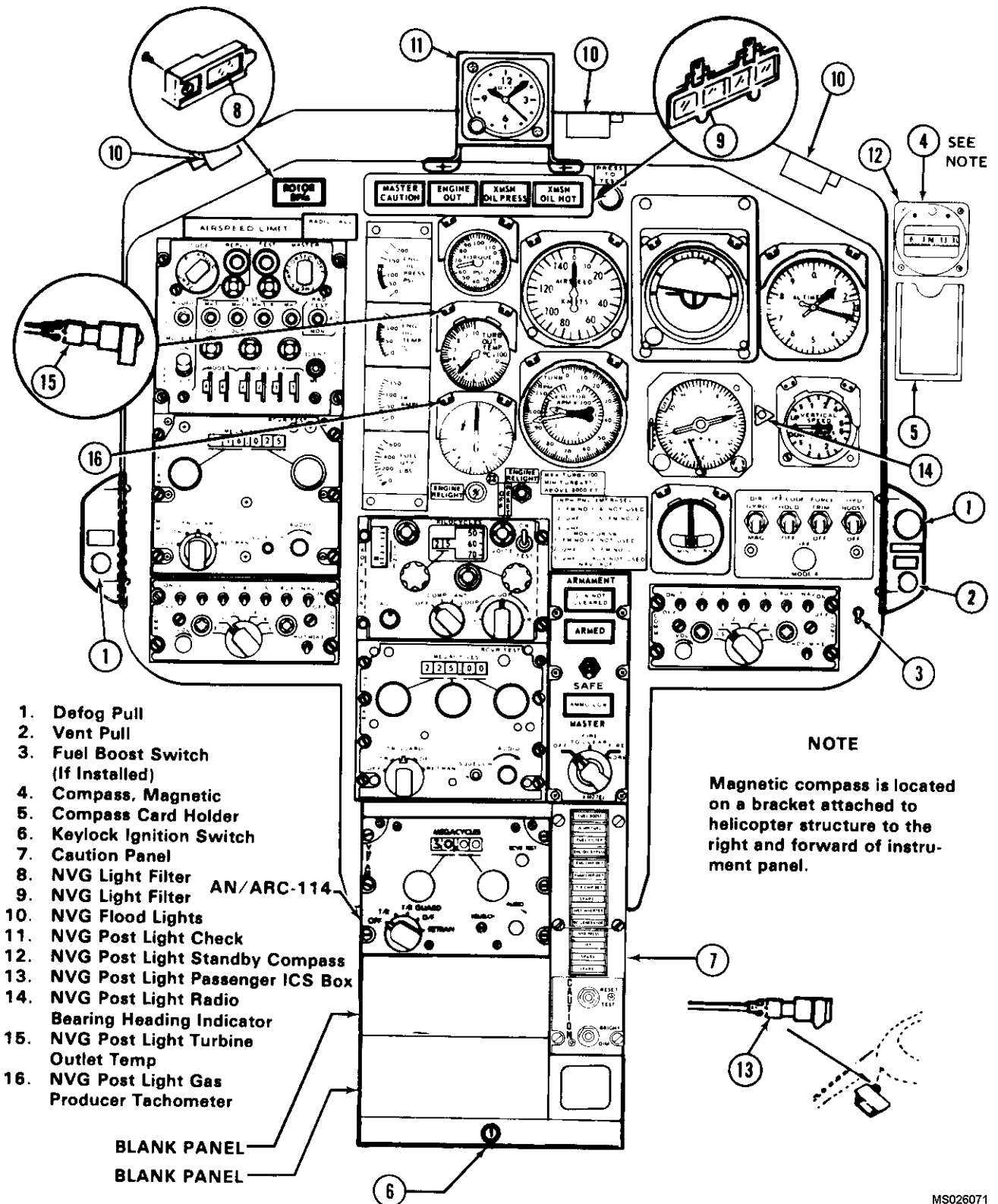

Figure 2-13. Instrument Panel and Console (Typical) A

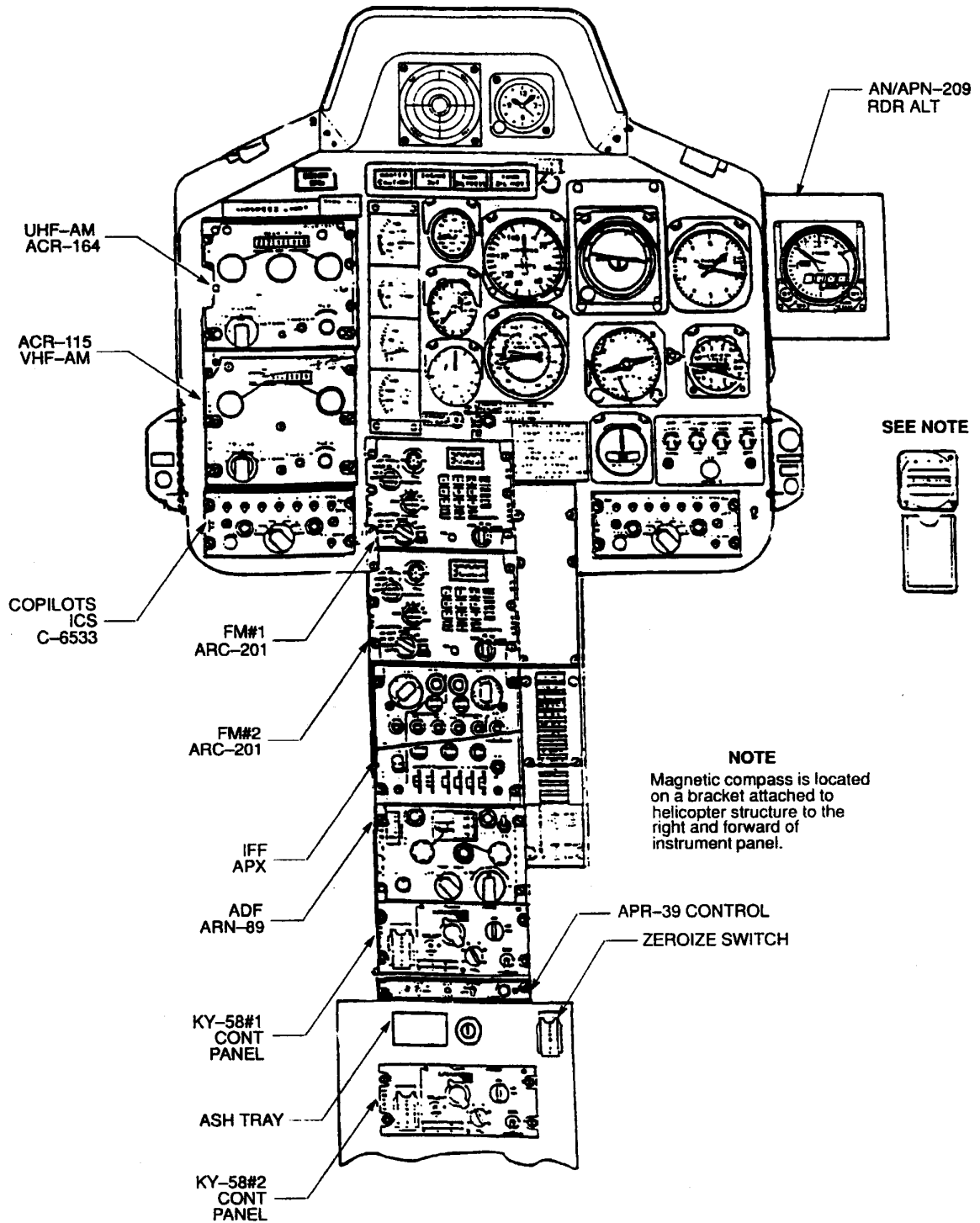

Figure 2-14.1. Instrument Panel and Console with AN/ARC-201 (Typical)

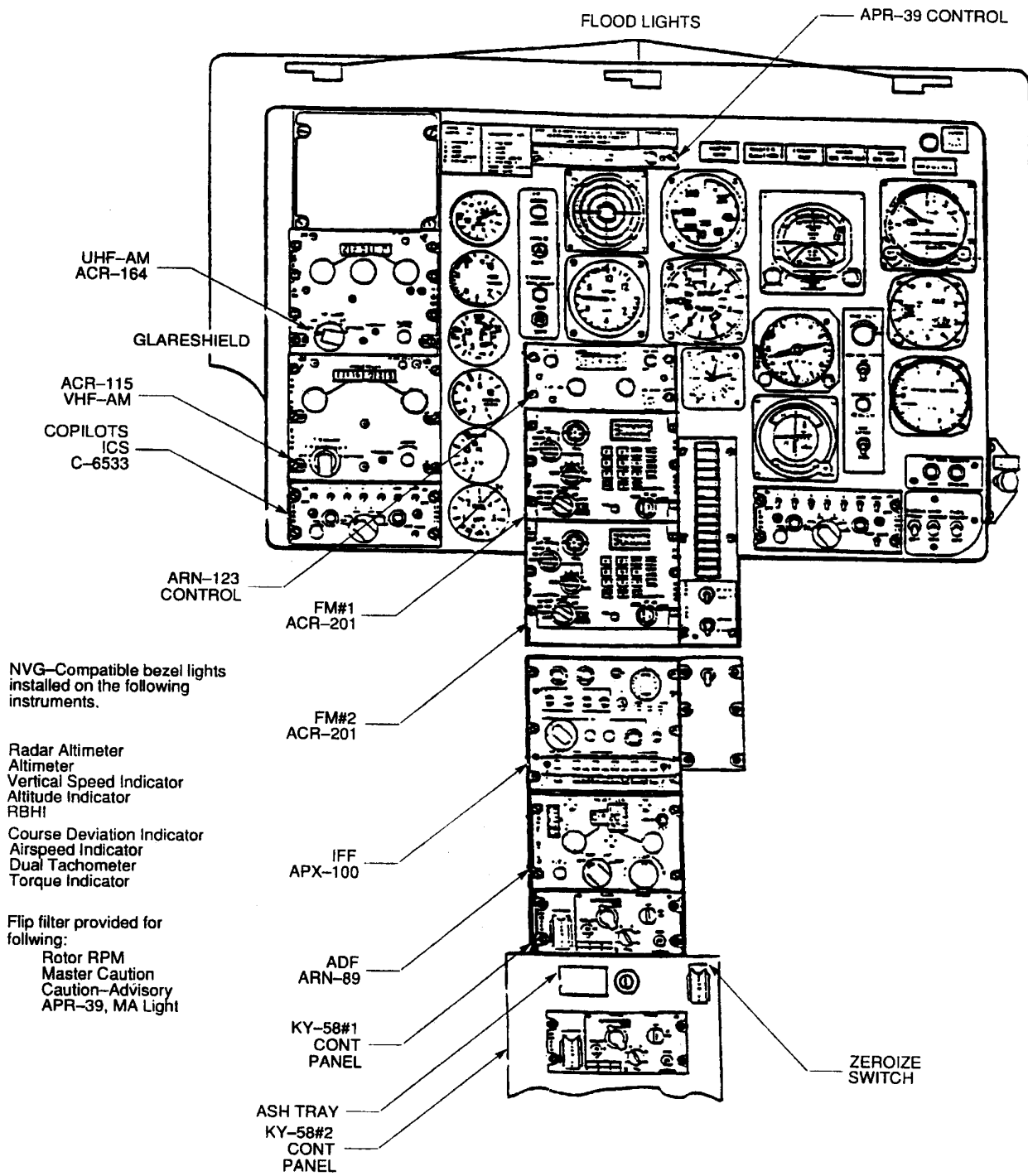

Figure 2-14.2. Instrument Panel and Console with AN/ARC-201 (Typical)

2-20. ENGINE AUTOMATIC RELIGHT SYSTEM (NOT USED).

An ENGINE RELIGHT ON/OFF switch and an ENGINE RELIGHT light may be found on the instrument panel. The automatic relight system has been deactivated and is not functional. There is no approved functional system for the OH-58A/C helicopter.

2-21. ENGINE INSTRUMENTS AND INDICATORS.

The engine instruments and indicators are mounted in the instrument panel or the caution panel in the lower console. They are described in the following paragraphs and shown in figure 2-13 and figure 2-14.



a. Engine Out Warning. An RPM sensor is connected to the gas producer tachometer. Power is supplied from the CAUTION PNL LTS circuit breaker and connections are made to the ENGINE OUT warning light (figure 2-13 and figure 2-14), and to a tone generator which produces a tone in the pilot headset. The warning system is activated when N1 is below $55 \pm 3\%$ and is deactivated above that N1 speed. The audio signal is the same as the low rotor audio signal.



b. Engine Out Audio Warning. A switch connected to the collective lever disables the engine out audio warning when the collective lever is in the full down position.

c. Torquemeter. The torquemeter (figure 2-13 and figure 2-14), located in the instrument panel, displays percent of torque produced by the engine. The torquemeter is a direct reading, wetline indicator.

d.  Turbine Outlet Temperature Gage. A thermocouple harness assembly with four integral probes is used to sense the temperature of the gases on the outlet side of the gas producer turbine rotor. A DC voltage which is directly proportional to the gas temperature it senses, is generated by each thermocouple. The thermocouple and thermocouple harness provide an average of the four voltages representative of the turbine outlet temperature (TOT) and this is the temperature indication on the TOT gage on the instrument panel.

e.  Turbine Outlet Temperature Indicator. The turbine outlet temperature (TOT) indicator (figure 2-14), located in the instrument panel, displays temperature in degrees Celsius of the exhaust gases in the N1 turbine outlet area. The indicator is powered by 28 Vdc and protected by TURB OUTLET TEMP circuit breaker.

f. Gas Producer Tachometer. The gas producer tachometer generator, located on the engine, generates an AC voltage with a frequency that is a function of gas producer turbine rotor N1 RPM. The output of the tachometer generator is delivered to the gas producer tachometer indicator which indicates the frequency in terms of percent RPM of gas producer turbine speed. The power for the gas producer tachometer is engine generated . The helicopter electrical system powers the  model and is protected by a gas producer tach circuit breaker.

g. Dual Tachometer. The dual tachometer (figure 2-13  and figure 2-14 ) located in the instrument panel displays percent RPM of the engine and rotor. The outer scale is marked Engine and the inner scale is marked Rotor. The OH-58A indicators are direct reading instruments which are not dependent of the electrical system. The OH-58C tach indicators are 28v DC-powered and protected by the DUAL TACH and GAS PROD TACH circuit breakers.

h.  Oil Pressure Gage. The oil pressure indicator, located on the instrument panel, is a direct-reading, wet-line system. Pressure from the pressure side of the oil pump is indicated in psi. Refer to figure 2-13.

i.  Oil Temperature Gage. The engine oil temperature gage, located on the instrument panel, is connected to an electrical resistance type thermocouple and indicates the temperature of the oil at the oil tank outlet.

j.  Oil Pressure/Temperature Indicator. The engine oil pressure/temperature indicator (figure 2-14), located in the instrument panel, displays engine oil pressure in psi and temperature in degrees Celsius. The temperature circuit is powered by 28 Vdc and protected by ENG OIL TEMP circuit breaker. The oil pressure portion of the indicator is a direct reading wetline system.

WARNING

Illumination of the engine oil bypass light may indicate a severe leak is present or developing, which could result in total loss of engine oil in a short period of time.

k. Engine Oil Bypass Caution Light. The ENG OIL BYPASS caution light (figure 2-13 and figure 2-14), located on the caution panel, will illuminate when the oil tank level is approximately 3 pints low. With the ENG OIL BYPASS switch (figure 2-12) in the AUTO position the engine oil will bypass the oil cooler. A significant rise in engine oil temperature will occur and engine failure can occur in a few minutes due to excessive engine oil temperature and/or engine oil loss. The switch in AUTO position is designed for combat operations only

(due to the potential for damage to the oil cooler by hostile fire) to provide the pilot a little additional time to fly out of the immediate enemy danger area only. The switch should be in the OFF position for operation in noncombat environment. The circuit is powered by 28 Vdc and is protected by the CAUTION PNL LTS circuit breaker.

l. Engine Chip Detector. There are two electrical engine chip detectors located in the accessory gear case, one at the lowest part and one on the forward right side by the oil pump. The ENG CHIP DET caution light (figure 2-14), located on the caution panel will illuminate when sufficient metal chips to complete the electrical circuit are collected from the engine oil. The system is powered by 28 Vdc and protected by CAUTION PNL LTS circuit breaker.

SECTION IV**FUEL SYSTEM****2-22. FUEL SUPPLY SYSTEM.****CAUTION**

Manual fuel shutoff valve should only be used in emergencies and maintenance procedures that require its use. Alert maintenance personnel anytime engine is shut down by using manual fuel shutoff valve by making an entry on DA Form 2408-13-1.

The OH-58A/C helicopters are equipped with a self-sealing Crashworthy Fuel System. This system is designed to retain fuel in a crash and provide improved ballistic protection, and is located below and aft of the passenger seat. In addition, the fuel lines are self-sealing. Mounted in the bottom of the cell is one boost pump, one fuel quantity transmitter, one low fuel transmitter, and one fuel sump drain. Installed in top of the cell is one fuel quantity transmitter, a vent line, and a boost pump pressure switch. A fuel filler cap is located on the right side just aft of the passenger door. The fuel shut off valve is mounted on the right side of the aircraft above the fuel cell cavity and is manually operated by the fuel valve handle on the overhead console. A connector for an auxiliary fuel cell is located on the forward side of the fuel cell beneath the seat. Helicopters with crashworthy fuel systems also incorporate the closed circuit refueling provision.

2-22.1. AIRFRAME MOUNTED FUEL FILTER ASSEMBLY. After compliance with MWO 1-1520-228-50-48.

The OH-58A/C helicopters have been equipped with an airframe mounted fuel filter. The fuel filter is a cylindrical unit mounted on the engine deck on the left side of the engine compartment. The fuel filter has a 10 micron (nominal) disposable filter element and electrical means of indicating any impending bypass condition which may occur. Fuel enters the inlet port of the filter from the fuel supply system and routes the fuel through the filter element, then exiting the outlet port of the filter to the engine fuel pump. If a clogging condition should develop in the filter element, a normally-open switch is closed by differential pressure, lighting FUEL FILTER caution panel as warning that further clogging may cause fuel to flow through the bypass valve in the filter and on to the engine pump with filtration.

2-23. AUXILIARY FUEL SYSTEM.

An auxiliary fuel cell (figure 2-15) can be installed in the helicopter. The auxiliary fuel cell, when installed, is secured in the passenger compartment on the right half of the cargo platform. The auxiliary fuel cell is a self-supporting, crashworthy self-sealing bladder type.

a. This fuel is delivered to the main fuel system by gravity only; the pilot has no control over the flow of fuel from the auxiliary cell into the main fuel cell.

b. The auxiliary fuel cell can be filled either at the main fuel cell filler or at a filler cap on the auxiliary fuel cell. The preferred method is to service the helicopter with fuel at the main fuel filler.

c. When the auxiliary fuel cell is installed, a fuel calibration card must be used to determine the amount of fuel on board (figure 2-15).

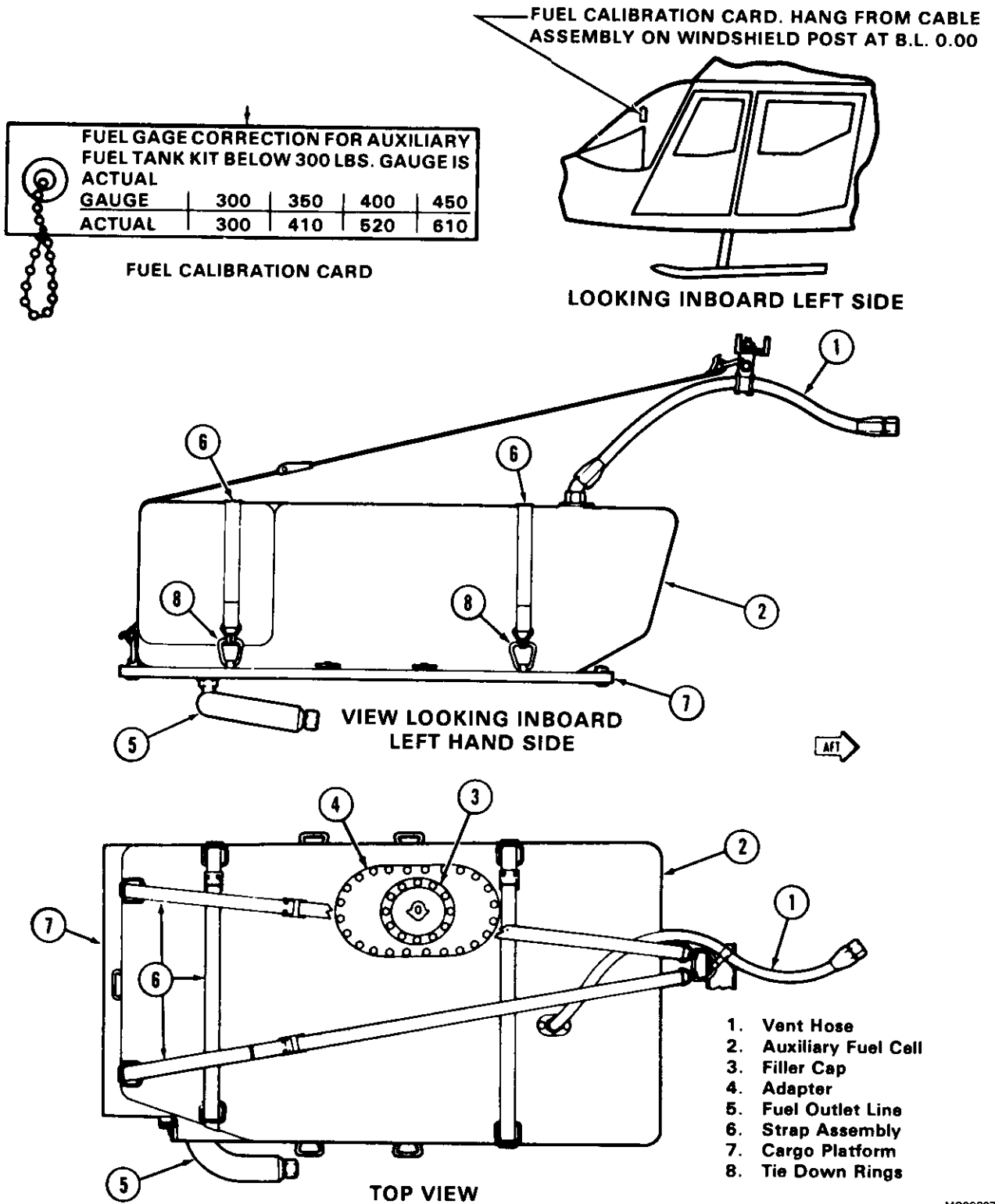

MS026073

Figure 2-15. Auxiliary Fuel System

2-24. CONTROLS AND INDICATORS.

a. Fuel Quantity Indicator. The FUEL QTY indicator (figure 2-13 and 2-14) is located in the instrument panel and displays the quantity of fuel in the fuel cell in pounds (0 to 600 lbs.). The indicator is powered by 28 Vdc and protect by INST CLUSTER circuit breaker **A**, FUEL QTY circuit breaker **C**.

b. Fuel Boost Caution Light. The FUEL BOOST caution light (figure 2-13 and 2-14) is located on the caution panel and illuminates if the fuel boost pressure is below safe operating limits when fuel boost switch is in the ON position. The system is powered by 28 Vdc and protected by CAUTION PANEL LTS circuit breaker.

c. Fuel Boost Pump Switch. The FUEL BOOST switch (figure 2-13 and figure 2-14) is located in the lower right corner of the instrument panel. The fuel boost switch will be in the fuel boost position for all normal conditions when the engine is operating and for starting. The system is powered by 28 Vdc and protected by FUEL PUMP circuit breaker.

NOTE

Low fuel caution systems alert the pilot that fuel in the tank has reached a specified level (capacity). Differences in fuel densities due to temper-

ature and fuel type will vary the weight of fuel remaining and actual time aircraft engine may operate. Differences in fuel consumption rates, aircraft altitude and operational condition of the fuel subsystem will also affect actual time aircraft engine may operate.

d. Low Fuel Quantity Caution Light. The LOW FUEL caution light, (figure 2-13 and figure 2-14), located in caution panel, should illuminate when there is approximately 20 minutes or 65 to 98 pounds of fuel remaining. The illumination of this light does not mean a fixed time remains. When the 20 minute fuel caution light is on, the fuel remaining may not be available except when the aircraft is in level or coordinated flight. The 20 minute fuel caution light in conjunction with a fuel boost caution light may indicate impending fuel starvation. The system is powered by 28 VDC and projected by Caution PNL LTS circuit breaker.

e. Fuel Filter Caution Light. The FUEL FILTER caution light (figure 2-13 and figure 2-14), located in the caution panel, will illuminate when the filter in the fuel supply line becomes partially obstructed. The system is powered by 28 Vdc and protected by CAUTION PNL LTS circuit breaker. The light may illuminate momentarily when the boost pump is turned on, but it should extinguish within approximately ten seconds.

SECTION V FLIGHT CONTROLS

2-25. DESCRIPTION.



When carrying non-rated passengers unfamiliar with operation of the helicopter, pilot should evaluate the mission as to advantages and disadvantages of stowing copilot controls or accepting the responsibility of the potential hazard when leaving the controls in place.

The flight control system is a positive mechanical type, actuated by conventional helicopter controls which, when moved, directs the helicopter in various modes of flight. Dual flight controls are provided. The system includes; the cyclic control stick, used for fore and aft and lateral control; the collective pitch control lever, used for vertical control; and the tail rotor anti-torque control pedals, used for heading control. The con-

trol forces of the main rotor flight control system are reduced to a near zero pounds force, to lessen pilot fatigue, by hydraulic servo cylinders connected to the control system mechanical linkage and powered by the transmission driven hydraulic pump. Force trims (force gradients) connected to the cyclic controls are electrically operated mechanical units used to induce artificial control feeling into the cyclic controls and to prevent the cyclic stick moving from a pre-set position.

2-26. CYCLIC CONTROL.

The pilot cyclic grip (figures 2-3 and 2-4) contains the following switches: force trim release switch, ICS switch, and RADIO transmit switch. The cyclic control system controls the fore, aft, and lateral movement of the helicopter. Control feel is provided by the force trim units.

NOTE

Removal of copilot cyclic stick can cause pilot cyclic stick to creep slightly aft.

a. Copilot Cyclic Stick Storage.

NOTE

Force trim will be lost when the electrical connector is disconnected when stowing or removing the copilot cyclic stick. Removal is authorized by the pilot and/or commander (Fuel quantity gage cannot be monitored with cyclic stick stowed ).

- (1) Unscrew retaining nut on cyclic stick.
- (2) Secure cyclic stick on stowage pin and strap located on the left outboard side of the center console.

b. Copilot Cyclic Stick Installation.

- (1) Remove cyclic stick from stowage.
- (2) Insert cyclic stick into pivot assembly on torque tube.
- (3) Secure cyclic stick in pivot assembly with knurled nut.
- (4) Ensure electrical connector is installed.

2-27. COLLECTIVE PITCH CONTROL.

WARNING

Do not use deck under collective for storage. This could cause interference in the full down position.

The pilot collective pitch control is located in the left of the pilot position and controls the vertical mode of flight. A rotating grip-type throttle and a switch box assembly are located in the forward end of the pilot collective pitch lever (figure 2-3 and figure 2-4). The switch box assembly contains the starter, governor engine idle release and landing lights switches. Friction can be induced into the collective system by rotation a friction device located between the pilot and copilot seats. The copilot collective lever, located on the left of the copilot position, con-

tains only a twist type throttle at the forward end of the control.

a. Copilot Collective Pitch Control Stowage.

- (1) Remove the boot around copilot stick shaft.
- (2) Loosen knurled nut at base of copilot stick. Remove stick.
- (3) Stow stick in clips located on forward side of copilot seat.

b. Copilot Collective Pitch Control Installation.

- (1) Remove stick from stowage clips and insert stick in jackshaft elbow assuring engagement of throttle tube.
- (2) Secure stick in elbow with knurled nut.
- (3) Secure boot around stick shaft.

2-28. ANTI-TORQUE (DIRECTION) CONTROL.

Anti-torque control pedals (figure 2-3 and figure 2-4) alter the pitch of the tail rotor blades and thereby provide the means of directional control. Pedal adjustments are located at the base of the pedals at floor level. Adjuster knobs enable adjustment of pedal distance for individual comfort.

a. Deleted.

b. Deleted.

2-29. FORCE TRIMS (FORCE GRADIENT).

Force gradient devices are incorporated in the controls. These devices are installed in the flight control system between the cyclic stick and the hydraulic power cylinder (servo). The devices act to furnish a force gradient of feel to the cyclic control stick. However, these forces can be reduced to zero by depressing the force trim button on the cyclic stick (figure 2-3 and figure 2-4). The gradient is accomplished by means of springs and magnetic brake release assemblies which enable the pilot to trim the controls, as desired, for any condition of flight. A FORCE TRIM toggle switch is installed in the control panel to activate the force trim system.

2-30. HORIZONTAL STABILIZER.

The horizontal stabilizer (figure 2-1 and figure 2-2) is located near the center of the tail boom and is installed in a predetermined fixed position. The horizontal stabilizer aids in trimming the helicopter in level flight and increases usable CG range.

2-31. VERTICAL FIN.

The vertical fin is located to the right of the tail rotor and is installed in a predetermined fixed position.

SECTION VI HYDRAULIC SYSTEM

2-32. DESCRIPTION.

The hydraulic system consists of a variable delivery pump and reservoir, servo actuators with irreversible valve circuits for cyclic and collective controls, a pressure line filter, a return line filter, and a solenoid shutoff valve. The pump is located on the transmission. The hydraulic system provides for fully powered flight controls during authoritative flight.

2-33. CONTROL.

A hydraulic system switch (HYD BOOST) is located on the lower right portion of the instrument panel and controls the activation and deactivation of the hydraulic system. (Refer to figure 2-13 and figure 2-14.)

2-34. CAUTION INDICATOR.

A caution indicator is located on the caution panel to indicate when hydraulic pressure is low (figure 2-13 and figure 2-14).

SECTION VII POWER TRAIN SYSTEM

2-35. TRANSMISSION.

The transmission is mounted on the cabin roof deck, forward of the power plant. The transmission transfers engine power to the main rotor through the mast assembly. The tail rotor is driven through the freewheeling unit, tail rotor driveshafts and tail rotor gearbox. Transmission lubrication is provided by a pump, relief valves, two each filters, spray jets, temperature bulb, and an oil cooler. The pump is a constant volume type driven by the accessory gear. An oil level sight gage is located on the right side of the transmission case. A breather type filler cap and two electrical magnetic chip detector drain plugs are incorporated. The transmission also furnishes lubrication for the freewheeling unit mounted in the engine accessory gearbox. Transmission oil is cooled by the oil cooler blower.

2-36. PYLON SUPPORT STRUCTURE.

a. The OH-58A/C has a design feature called a focused pylon mounting system for its pylon. This support concept differs from conventional four or five point spring mounting arrangements as follows:

(1) The pylon bi-pod supports aim or focus pylon input loads at the fuselage vertical center of gravity. The purpose is to reduce cabin vibration by eliminating pylon induced rolling moment about the center of gravity.

(2) Rigid mounting in the vertical plane minimizes vertical vibration.

(3) Vibration should not increase with mount aging as is possible with conventional spring mounted pylon supports.

b. The elastomeric mount provides pylon static centering.

2-37. PYLON SUSPENSION SYSTEM.

a. The main transmission is supported and attached at its lower rear section by an isolation mount. Bolted to the lower rear section by an isolation mount. Bolted to the lower aft part of the transmission case is the drag pin which bolts to the elastomeric isolation mount.

b. The drag pin has a metal pin which is commonly referred to as the spike. The drag pin or spike physically

is mounted so that "rides" inside the square metal opening of the transmission mount support.

c. The isolation mount is used to dampen pylon to fuselage vibration and limit pylon rock. Movement of the transmission and isolation mount is limited by means of the drag pin (spike) which extends down into the transmission mount support mounted on the deck.

d. Contact between the drag pin and the transmission mount produces a noise known as spike knock.

2-38. FREEWHEELING ASSEMBLY.

The freewheeling unit is mounted in the accessory gearbox. Engine power is transmitted through the freewheeling unit to the main driveshaft and tail rotor driveshafts to provide power to the main and tail rotors respectively. During autorotation the freewheeling unit provides engine disconnect and the transmission drives the tail rotor.

2-39. TAIL ROTOR GEARBOX.

The gearbox is located near the vertical fin and provides a 90 degree change of direction of the tail rotor driveshaft. A breather type filler cap, electrical chip detector drain plug and an oil level sight gage are provided.

2-40. DRIVESHAFTS.

a. **Main Driveshaft.** The main driveshaft connects the engine output to the transmission.

b. **Tail Rotor Driveshaft.** The tail rotor driveshaft is made up of four sections; the forward short shaft, the oil cooler fan shaft, the aft short shaft, and the long shaft.

2-41. INDICATORS.

a. **Transmission Chip Detectors.** There are three chip detectors located within the transmission lubricating system. Two electrical chip detectors are located on the base of the transmission and are wired to the XMSN CHIP DET caution light and the MASTER CAUTION light. One magnetic chip detector is located on the freewheeling unit and is not connected to the caution lighting system. All three are provided to give evidence of ferrous metal particles in the transmission lubrication system.

b. Tail Rotor Gearbox Chip Detector. The chip detector is located in the lower section of the tail rotor gearbox. The chip detector is wired to the T/R CHIP DET caution light and the MASTER CAUTION light. The caution light is activated when a sufficient amount of metal particles has been collected on the chip detector to close the circuit.

c. Transmission Oil Pressure Warning Light. The XMSN OIL PRESS warning light (figure 2-13 and figure 2-14) is located in the upper center section **A**, and upper right corner **C** of the instrument panel. The XMSN OIL PRESS light will illuminate steady until oil pressure is above 36 psi. Normal operating pressure is 30 to 60 psi with warning light

actuation at 30 ± 2 psi on decreasing pressure. The transmission oil pressure switch is located on the left side of the cabin roof near the transmission. The light is protected by the CAUTION PNL LTS circuit breaker.

d. Transmission Oil Temperature Warning Light. The XMSN OIL HOT warning light (figure 2-13 and figure 2-14) is located in the upper center section **A**, and upper right corner **C** of the instrument panel. The XMSN OIL HOT light will illuminate steady until oil temperature is below 110°C. The transmission oil temperature sensor is located on the transmission oil filter head. The light is protected by the CAUTION PNL LTS circuit breaker.

SECTION VIII MAIN AND TAIL ROTOR GROUPS

2-42. MAIN ROTOR.

The main rotor assembly is a two blade, semi-rigid, seesaw type rotor called an underslung feathering axis hub. The blades are mounted in the hub assembly grips with blade retaining bolts which have hollow shanks for installation of weights to balance the hub and blade assembly. Pitch change and pillow block bearings are lubricated with grease. The rotor blades are all metal, consisting of an extruded aluminum alloy nose block, aluminum alloy trailing edge and an aluminum honeycomb filler. The main rotor is driven by the mast which is connected to the transmission. The rotor RPM is governed by the engine RPM during powered flight. The rotor tip path plane is controlled by the cyclic stick. The rotor pitch is controlled by the collective lever.

tachometer generator mounted on and driven by the transmission and is independent of the helicopter electrical system. **C** Model aircraft require 28 VDC and are protected by the DUAL TACH circuit breaker.

2-44. RPM WARNING SYSTEM.

A ROTOR RPM warning system is installed to provide a visual and audio indication of low rotor RPM. A RPM sensor is connected to the rotor tachometer. Power is supplied from the CAUTION PNL LTS circuit breaker and connections are made to the ROTOR RPM warning light and to a tone generator which provides an audible tone in the crews headsets. The warning system is activated when the rotor RPM drops below 95% ± 1.4%.

2-43. MAIN ROTOR RPM INDICATOR.



The same audio tone is used for both the rotor rpm warning and engine out warning. Check the visual indicators to determine corrective action necessary.

The rotor tachometer indicator (figure 2-13 **A**, figure 2-14 **C**) is part of the dual tachometer and is located on the instrument panel. The rotor RPM reading is indicated on the inner scale and the pointer needle is marked with an R. The indicator is powered by a

2-45. TAIL ROTOR.

The tail rotor is driven by the inner shaft of the freewheeling unit through tail rotor driveshaft and the tail rotor gearbox. The tail rotor hub and blade assembly consists of an aluminum alloy forged yoke and aluminum alloy blades. The spherical bearings provide for pitch change of the blades. The hub and blade assembly are mounted on the tail rotor gearbox shaft by means of a splined trunnion, mounted in bearings in the yoke, to provide a flapping axis for the assembly. The tail rotor gearbox has a breather type filter cap, electrical chip detector and oil level sight gage, all accessible from ground level. Tail rotor blade pitch is controlled by the anti-torque pedals.

SECTION IX UTILITY SYSTEM

2-46. PITOT HEATING SYSTEM.

a. Description. The pitot heater is installed on the pitot head and functions to prevent ice forming in the pitot tube. Electric power for the pitot heater operation is supplied from the 28 VDC helicopter electrical system. Circuit protection is provided by a 5 ampere circuit breaker switch on the overhead console.

The pitot heater is controlled by a switch located on the overhead console (figure 2-12) labeled PITOT HTR.

b. Operation. The pitot heater switch should be in PITOT HTR position to prevent ice forming in pitot tube. To shut off pitot heater, position switch to OFF.

SECTION X HEATING AND VENTILATION

2-47. BLEED AIR HEATING SYSTEM.

a. Description. The bleed air heater is installed in the equipment compartment aft of the electrical shelf behind the passenger seat. A HTR switch (figure 2-12) located on the overhead console actuates the heater. The pilot may select air temperature by means of a HEAT control knob (figure 2-17) located above and aft of his head. This knob operates a control cable in the cabin roof to adjust an air temperature sensor mounted in the heater discharge duct. Adjusting the sensor mixes the fresh and bleed air to obtain the air temperature selected by the pilot. The bleed air heating ducts are connected to windshield defog nozzles at the bottom of the forward windshield through blowers mounted in the fuselage nose. The blowers are activated by DEFOG & VENT circuit breaker switch (figure 2-12) located on the overhead console to increase airflow velocity over the windshield. Lower nose window defog is continuous and automatic when HTR switch is turned on. Outside fresh air from an intake on the top of the fuselage nose is directed through the windshield defog nozzles mounted on the lower windshield frame. A VENT PULL control on the right side of the instrument panel (figure 2-16) opens and closes the fresh air intake.

b. Operation A circuit breaker switch labeled HTR on the overhead console (figure 2-12) actuates a solenoid valve.

The switch in the ON position permits air from the engine compressor section to pass through the bleed air nozzle. A venturi working in conjunction with the bleed air nozzle draws in outside air through the outside air vent. Bleed air and outside air is fed into the mixing valve where a sensor determines the mixing ratio produce the desired temperature. Bleed air forces heated air through the duct system to registers under the seat and/or to the defroster nozzles. Temperature is regulated by a manual control knob labeled HEAT located above and to the rear of the pilot's head, and connected to a variable remote sensor in the heater compartment. The sensor has a bimetallic element which controls the mixing valve. The defogging and vent system is installed in the nose and consists of a ram air intake, two blower fans, defroster nozzles and ducts. The bleed air system is also connected to the defogging and vent system. Outside airflow to the cabin and defogging nozzles is controlled by manual push-pull type controls labeled VENT and DEFOG located on each side of the instrument panel (figure 2-16). The blowers direct air to the defogging nozzles and are controlled by a 5 AMP circuit breaker switch, labeled DEFOG & VENT, on the overhead console. (Refer to figure 2-12.)

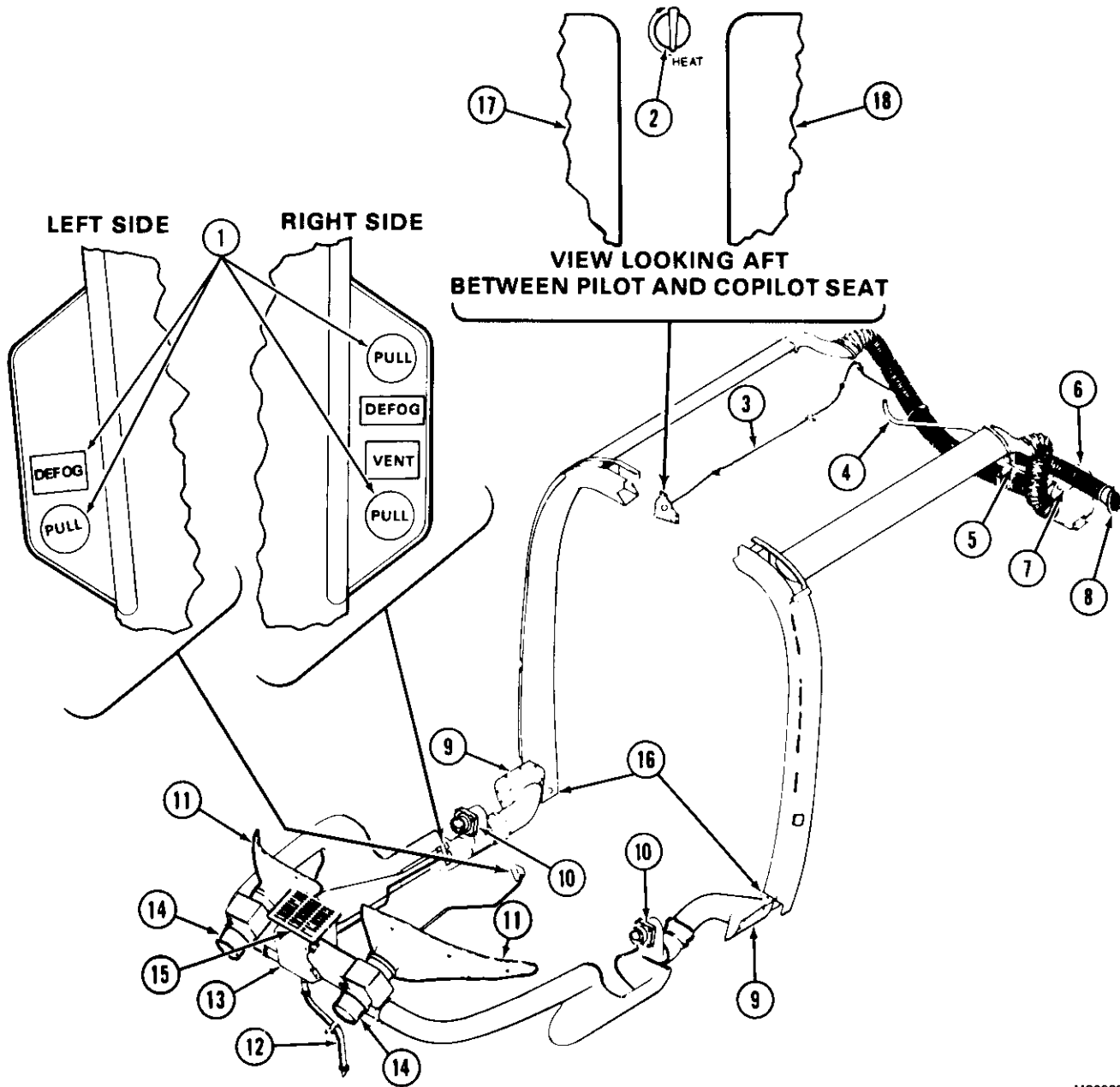

MS026074

- | | | |
|--|-----------------------------|--|
| 1. Vent and Defog Control (Instrument Panel) | 7. Remote Sensor | 14. Ventilation and Defogging Blower |
| 2. Heater Control Knob | 8. Fresh Air Inlet | 15. Ram Air Intake Grill |
| 3. Heat Control Cable | 9. Post Plenum | 16. Air Distribution Vents
Cargo / Passenger Area |
| 4. Bleed Air Tube | 10. Air Distribution Valves | 17. Pilot Seat Back (REF) |
| 5. Mixing Valve | 11. Windshield Defog Nozzle | 18. Copilot Seat Back (REF) |
| 6. Plenum | 12. Plenum Drain | |
| | 13. Plenum Valve Assembly | |

Figure 2-16. Heating and Ventilation **A** (Sheet 1 of 2)

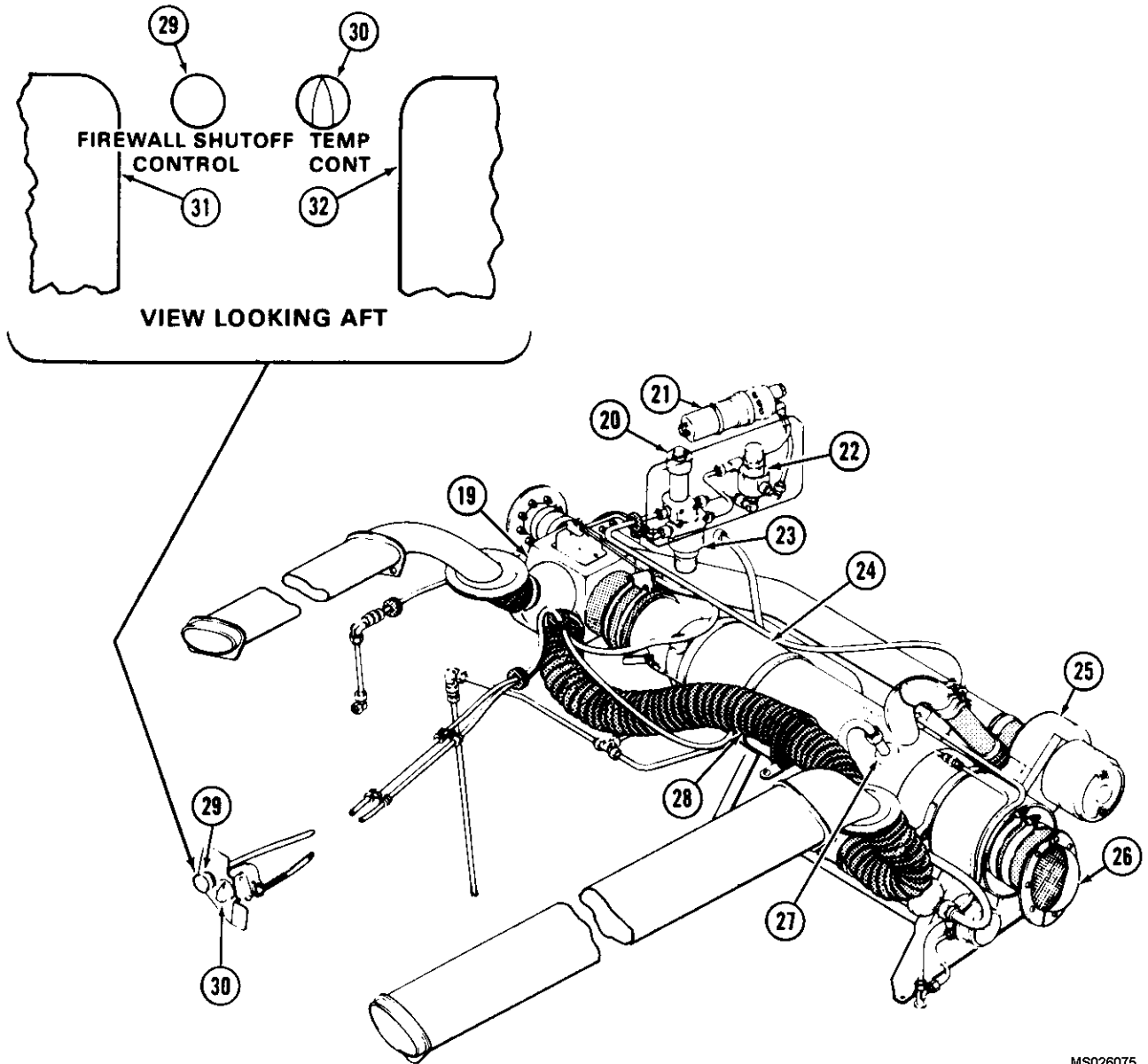

MS026075

- | | | | |
|-----|----------------------------|-----|--------------------------|
| 19. | Combustion Heater Plenum | 26. | Fresh Air Inlet |
| 20. | Fuel Shutoff Valve | 27. | Igniter Plug |
| 21. | Fuel Pump | 28. | Duct |
| 22. | Fuel Pressure Relief Valve | 29. | Firewall Shutoff Control |
| 23. | Fuel Filter | 30. | Heat Control knob |
| 24. | Heater | 31. | Pilot Seat Back |
| 25. | Combustion Blower | 32. | Copilot Seat Back |

Figure 2-16. Heating and Ventilation (Sheet 2 of 2)

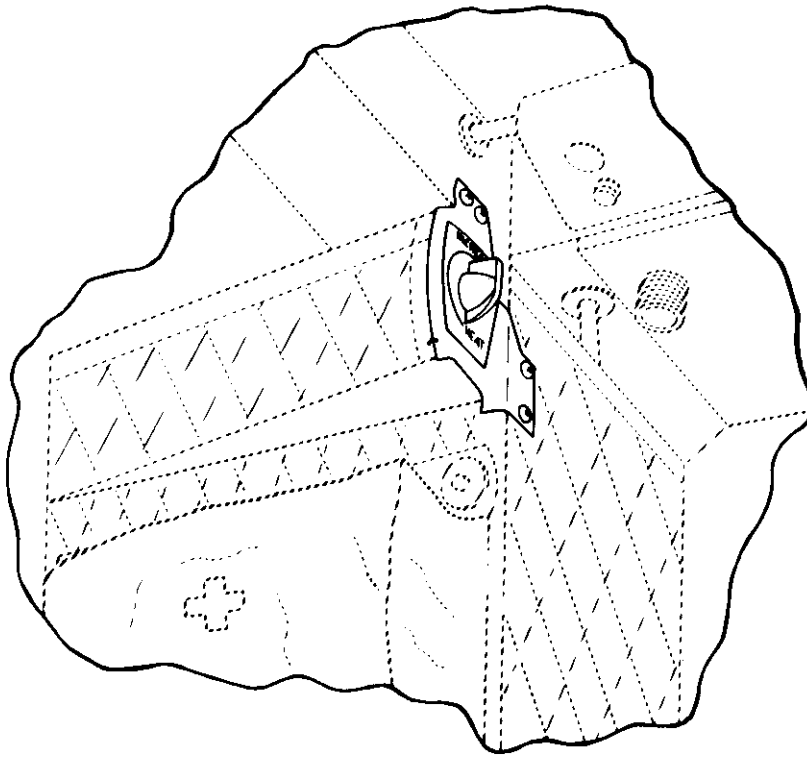

HEATER CONTROL KNOB

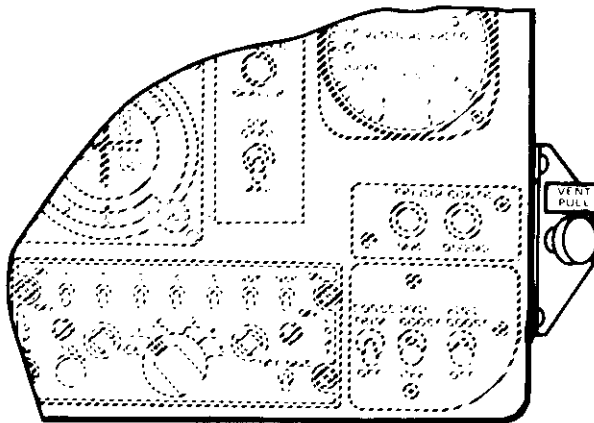

VENT AND DEFOG CONTROL

MS026076

Figure 2-17. Heater Control and Vent Pull Knobs

2-48. A COMBUSTION HEATER.

a. Description. A combustion heater is installed on the electrical shelf behind the passenger seat, on helicopter serial Nos. 70-15263 thru 70-15278, in the aft equipment compartment. Fuel for heater operation is supplied by the helicopter fuel system and routed through the heater fuel filter, pump, relief valve, and shutoff valve. Ignition is supplied by a heater mounted ignition assembly which converts 28 volts DC to high voltage, producing a continuous spark during heater operation. Air is supplied by a blower through a port on the right side of the helicopter and routed to the combustion chamber. Heater exhaust gases are piped overboard through a shrouded exhaust pipe. Heated air is distributed by a heater mounted ventilating air blower and routed through ducts to the forward and aft cabin compartments. Two adjustable distribution valves are provided in the pilot compartment and two fixed openings for the passenger compartment. Controls for heater starting are located on the overhead panel and two controls are mounted on the vertical column on pilot seat back. The left side control is for temperature and the right side control operates the heater shutoff valve in the event of fumes, fire, or heater malfunction. A heater fail light is mounted on the console and will indicate heater malfunction. Consumption of fuel is 3.5 gallons per hour for 30,000 BTU heater and 4.5 gallons per hour for the 50,000 BTU heater. (Refer to figure 2-16.)

b. Combustion Heater Pre-Start Check.

- (1) FUEL PUMP circuit breaker — In.
- (2) HTR PWR circuit breaker — In.
- (3) HTR CONT circuit breaker — In.
- (4) FIREWALL SHUT-OFF CONTROL — In.

- (5) BAT switch — BAT.
- (6) FUEL VALVE — ON.
- (7) HEAT-OFF-VENT switch — OFF.

c. Normal Operation.

(1) HEAT-OFF-VENT switch — ON. Check that combustion air and vent blowers operate and HEATER FAIL caution light is on.

(2) HTR START switch — Press and hold, Ignition should occur with 5 to 10 seconds. HEATER FAIL caution light should go off.

(3) TEMP CONT knob — Regulate for desired temperature.

(4) HEAT-OFF-VENT switch — OFF, to shut down heater

NOTE

HEAT-OFF-VENT switch in OFF position, the combustion air and vent blowers will continue to operate, cooling and purging the heater, and will cut off automatically when the heater has cooled. If manual cooling and purging is desired place switch in VENT position, then return switch to OFF.

d. Emergency Shutdown.

(1) FIREWALL SHUT-OFF CONTROL knob — Release and pull out.

- (2) HEAT-OFF-VENT switch — OFF.

SECTION XI ELECTRICAL POWER SUPPLY AND DISTRIBUTION SYSTEM

2-49. DIRECT CURRENT PRIMARY POWER.

The OH-58A/C helicopter is equipped with a 28-volt direct current dual bus (essential and non-essential) system supplied by a starter-generator and battery (figure 2-18). Components of the direct current power system include battery, starter-generator, voltage regulator, relays, switches, and circuit breakers. All circuits in the electrical system are single wire with common ground return. The negative terminals of the starter-generator and the battery are grounded to the helicopter structure. In the event of generator failure, with the NON-ESS BUS switch in the NORM position, the non-essential bus is automatically deactivated. The battery then supplies power to the essential bus load. The non-essential bus may be manually reactivated by placing the NON-ESS BUS to the MAN position. In the event of engine failure, generator power will be lost.

a. Indicators and Controls.

(1) DC System Indicator. The ammeter is mounted in the instrument cluster on the instrument panel and indicates the ampere load being used. The circuit is protected by two circuit breakers, labeled LOADMETER in the aft electrical compartment.

(2) DC Power Control. The DC power is controlled by the BAT switch, GEN switch, NON-ESS BUS switch, and circuit breakers labeled GEN & BUS RESET and GEN FIELD.

(3) Battery Switch. The Battery switch is located in the overhead console and is a two-position toggle switch, labeled BAT and OFF. Battery electrical power is supplied to the helicopter electrical system when the switch is in the BAT position. When the switch is in the BAT position, it closes the circuit to the actuating coil of the battery relay and battery power is then delivered from the battery to the essential bus. When the switch is placed in the OFF position, it opens the circuit to the actuating coil of the battery relay and no power is delivered from the battery to the essential bus.

(4) Generator Switch. The generator switch is located on the overhead console and is a three-position

switch. This switch is labeled GEN in the forward position, OFF in the center position, and RESET in the aft position. The RESET position is spring-loaded to return to the OFF position when released. Therefore, to reset the generator, the switch must be held in RESET position momentarily, and then moved to the forward position.

(5) Non-Essential Bus Switch. The non-essential bus switch is located in the overhead console and is a two-position switch labeled NON-ESS BUS NORM and MAN. When the switch is in the NORM position, power is supplied to the non-essential bus provided the generator is operating or when external power is applied. When the switch is in the MAN position, power is supplied to the non-essential bus regardless of generator operation.

b. Circuit Breakers. The DC circuit breaker panel (figure 2-12) is located in the overhead console. Each individual circuit breaker is clearly labeled for particular electrical circuits protected. In the event a circuit is overloaded, the circuit breaker protecting that circuit will deactivate. The circuit is reactivated by pushing the circuit breaker button.

c. External Power Receptacle. During ground operations, external power may be connected to the electrical system through an external power receptacle located on the lower right side of the helicopter just aft of the rear landing gear crosstube. The GEN and BAT switches should be in the OFF position when external power is connected. The external power relay closes automatically and connects the ground unit to the essential and non-essential buses. A GPU power of 300 to 750 amperes and 28 vdc is recommended.

d. Auxiliary Power Receptacle. The auxiliary power receptacle is mounted on a bulkhead aft of the copilot seat and provides power take off of 28 Vdc to operate miscellaneous auxiliary equipment. The circuit is powered by 28 Vdc essential bus and is controlled and protected by AUX RECP circuit breaker switch on the overhead console.

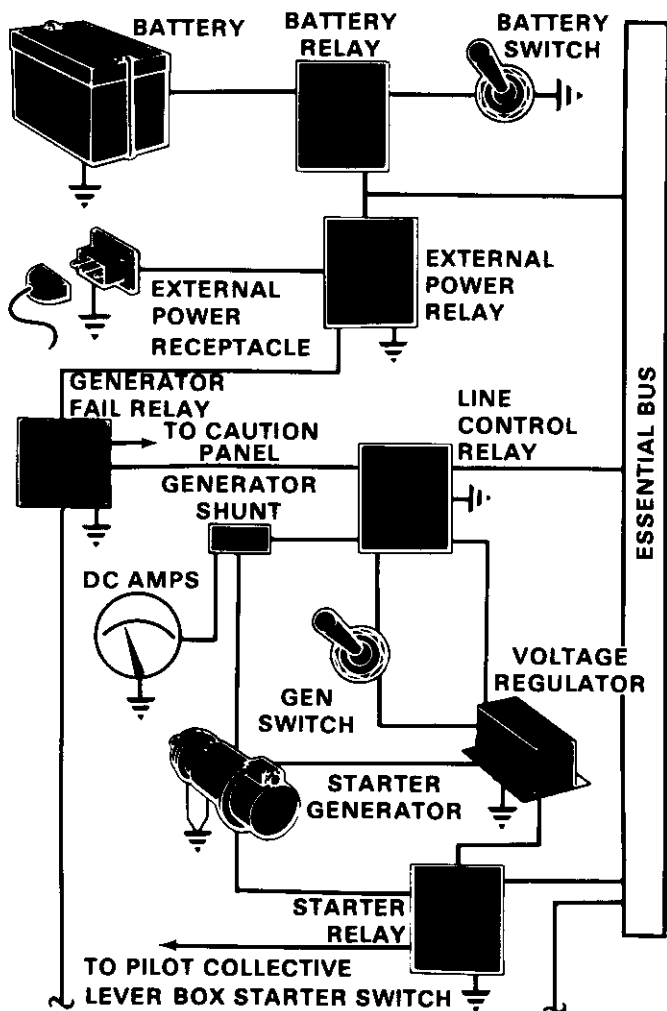

(SEE SHEET 2)

- NAV POSITION LIGHTS (NVG POS LTS) **C**
- SRCH/LANDING LT CONTROL (SRCH LT CONT) **C**
- AMMETER (AMM) **C**
- FUEL QUANTITY INDICATOR (FUEL QTY) **C**
- DUAL TACHOMETER (DUAL TACH) **C**
- GAS PRODUCER TACHOMETER (GAS PROD TACH) **C**
- TURBINE OUTLET TEMPERATURE INDICATOR (TURB OUTLET TEMP) **C**
- ENGINE OIL TEMPERATURE INDICATOR (ENG OIL TEMP) **C**
- PRIMARY DIRECTIONAL CONTROL (PRI DRI CONTR) **C**
- TRANSMISSION OIL PRESSURE (XMSN OIL PRESS) **C**
- CONSOLE LIGHT (CSL LT) **C**
- CONUS NAVIGATION (CONUS NAV) **C**
- ALTIMETER VIBRATOR (ALT VIB) **C**
- RADAR ALTIMETER (RDR ALT) **C**
- RADAR WARNING SYSTEM (RDR WRN) **C**
- GENERATOR FIELD (GEN FIELD)
- GENERATOR & BUS RESET (GEN & BUS RESET)
- CAUTION PANEL (CAUTION PNL LTS)
- SIGNAL LIGHT (SIGNAL LT)
- INSTRUMENT LIGHTS (INST LTS)
- ANTI-COLLISION LIGHTS (ANTI-COLL LTS)
- SRCH/LANDING LT POWER (SRCH LT PWR) **C**
- ENGINE OIL BYPASS (ENG OIL BYPASS)
- GOVERNOR CONTROL (GOV CONT)
- FUEL BOOST PUMP (FUEL PUMP)
- STARTER (START ENG)
- IGNITER AND AUTO RELIGHT (IGN ENG)
- ENGINE ANTI-ICE (ENG DEICE)
- ATTITUDE SYSTEM (ATTD TURN) **C**
- ATTITUDE SYSTEM (ATTD HRZN) **C**
- FORCE TRIM (FORCE TRIM)
- HYDRAULIC BOOST SOLENOID (HYD BOOST SOL)
- INSTRUMENT CLUSTER (INST CLUSTER) **A**
- IFF (IFF)
- ADF (ADF)
- UHF (UHF)
- ICS (ICS)
- ARMAMENT (ARMT)
- ARMAMENT POWER (ARMT PWR)
- PITOT HEATER (PITOT HTR)
- AUXILIARY POWER (AUX RECP)
- PROXIMITY WARNING (PROX WARN) **C**
- LANDING LIGHTS (LDG LTS) **A**
- TURN AND SLIP INDICATOR (TURN & BANK IND) **A**
- IFF COMPUTER (IFF CMPTR) **A**
- JETTISON POWER (JETTISON) **CS**



MS026077

Figure 2-18. Electrical System Schematic (Sheet 1 of 2)

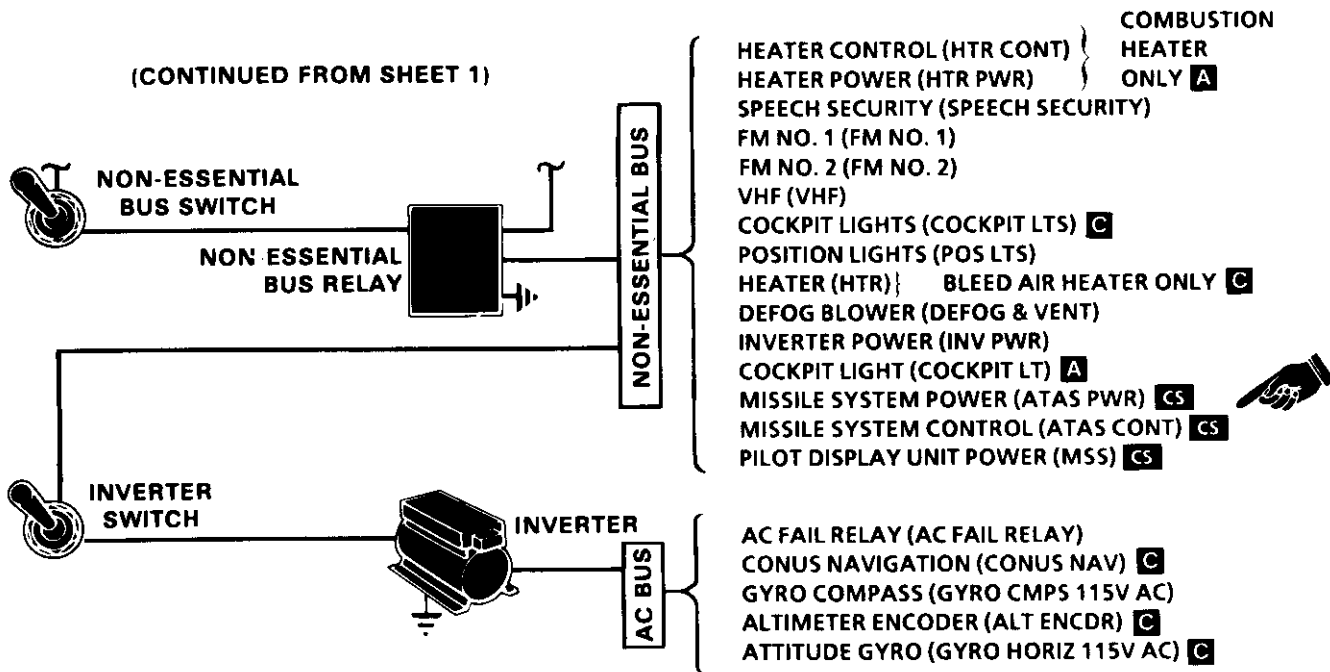

Figure 2-18. Electrical System Schematic (Sheet 2 of 2)

2-50. ALTERNATING CURRENT POWER SUPPLY.

The OH-58A/C helicopter is equipped with a solid state inverter powered from the non-essential 28 volt DC bus through a 5 ampere INV PWR circuit and is manually controlled by an INV switch (figure 2-12). The inverter delivers 115 volt AC 400 Hz to the 115 volt AC bus. A caution panel segment INST INVERTER will illuminate when AC power is lost.

a. Controls. The AC power is controlled by the INV switch and AC circuit breakers. The inverter switch is located in the overhead console and is a two-position

toggle switch labeled INV and OFF. AC electrical power is provided to the electrical system when the switch is in the forward position. DC power to the inverter is supplied by the non-essential bus; therefore, to have AC power, electrical power must be available at the non-essential bus. When the switch is in the OFF position it opens the circuit to the inverter.

b. Circuit Breakers. The AC circuit breakers are on the aft end of the overhead console. In the event of a circuit overload, the circuit breaker protecting that circuit will pop out. The circuit is reactivated by pushing in the circuit breaker button.

SECTION XII LIGHTING

2-51. POSITION LIGHTS.

The position lights consist of three lights (figure 2-1 and figure 2-2). A green light is located on the right horizontal stabilizer tip, a red light on the left horizontal stabilizer tip, and a white light on the aft end of the tailboom. Electrical power is supplied from the 28-volt DC non-essential bus. Circuit protection is provided by the POS LTS circuit breaker on the overhead console. The position lights are controlled by the POS LTS switch on the overhead console (figure 2-12). The switch is a three-position toggle switch with BRT (forward) DIM (center) and OFF (aft) positions.

2-52. NVG POSITION LIGHTS.

Five, white IR position lights (NVG position lights) are mounted on the aircraft. Two forward NVG position lights (figure 2-2) are mounted forward of the FM homing antenna on both sides of the aircraft. Two lower NVG position lights (figure 2-2) are mounted forward of the APR-39 antenna support. One aft NVG position light is located on top of the tail light support assembly. Power for NVG position lights is provided by the NVG POS LTS circuit breaker (figure 2-12). Operation of the NVG position lights is controlled by a five-position rotary switch, NVG POS LTS, (figure 2-12) located on the overhead console. In position 1, the lights are at minimum intensity, in position BRT, the lights are at maximum intensity.

2-53. ANTI-COLLISION LIGHTS.

The anti-collision lights are located one on top of the engine cowling and one centered at the lower section of the fuselage aft of the avionics compartment. Electrical power for the anti-collision lights is provided by the 28-volt DC electrical system essential bus. The anti-collision light switch is located on the overhead console (figure 2-12). The switch is a two-position toggle type labeled ANTI-COLLISION LTS and OFF. The forward position energizes the anti-collision light circuit.

Float equipped helicopters have lower light relocated from boom station 88.0 to boom station 103.0.

2-54. LANDING LIGHTS.

IR/White (Dual) Landing/Searchlight. A dual light assembly with a white light on one side and IR light on the other side is mounted in the lower nose section of the helicopter (figure 2-2).

CAUTION

Do not illuminate IR light with light assembly fully retracted. Doing so may cause light to overheat, resulting in damage to electrical components of the helicopter.

Power for the light assembly is provided by the SRCH LT CONT and SRCH LT PWR circuit breakers. One three-position switch and one four-position switch, co-located on the pilot collective lever (figure 2-4), are used to operate the light assembly.

CAUTION

DELETED

The three-position switch LDG LT (ON-NVG-OFF) controls illumination of the white light (ON position) and the IR light (NVG position).

NOTE

White light will automatically extinguish when light rotates 90° right or left of center, if extended less than 60°.

The four-position switch LDG LT (EXT-RETR-L-R) provides extension, 360° rotation and retraction.

2-55. DELETED.

2-56. INSTRUMENT LIGHTS.

The instrument lights are all on one circuit and are controlled by a rheostat switch labeled INST LTS on the overhead console (figure 2-12). Clockwise rotation of the rheostat knob activates the instrument panel circuit and increases brilliance. Counterclockwise rotation of the knob dims, with final movement (OFF) deactivating the electrical circuit from the essential bus.

NVG compatible bezel lights and postlights provide instrument panel lighting (figure 2-4). The instrument panel lighting is controlled by the INST LT rheostat control (figure 2-12) and is powered by the INST LTS circuit breaker.

2-57. CONSOLE LIGHTS.

The console lights are all on one circuit, and are controlled by a rheostat switch labeled CONSOLE LTS on the overhead console (figure 2-12). Clockwise rotation of the rheostat knob activates the console panel circuit and increases brilliance. Counterclockwise rotation of the knob dims, with final movement (OFF) deactivating the circuit, located on the essential bus.

a. Night Vision Features (for Flights Using Night Vision Goggles (NVG)). A hinged light filter is attached to the instrument panel so it can be adjusted over the ROTOR RPM warning light of the warning panel (figure

2-13, items 8 and 9) for flights using NVG, and adjusted away from the ROTOR RPM warning light for flights not using NVG. A hinged light filter is also attached to the instrument panel for the other warning lights, and master caution lights for use in the same manner.

b. NVG-compatible panel lights provide lighting of the ICS boxes KY28 and the ADF REVR located in the aircraft. The console lighting is controlled by the CONSOLE LT rheostat (figure 2-12) and is powered by the CSL LT circuit breaker.

2-58. SIGNAL LIGHT RECEPTACLE.

A plug-in type receptacle (figure 2-12) for a hand held signal light, is located at the aft end of the overhead console. Power is supplied from the essential bus.

2-59. COCKPIT UTILITY LIGHT.

a. Cockpit Utility Lights. Two cockpit utility lights are located within easy reach of either crew member. One is located on the center post and the other on the overhead center beam behind the copilot. One has a light filter for use with flights using NVG when necessary. The lights may be hand held or positioned in their holder for direct beam direction. A rheostat switch is part of each light assembly. Power is supplied from the non-essential bus through the COCKPIT LTS circuit breaker.

b. Supplementary NVG-compatible cockpit lighting is provided by a utility light and three floodlights. The

utility light is attached to a flexible gooseneck extension mounted on the centerpost between the pilot and copilot seats (figure 2-4). The flexible gooseneck holds the utility light in the position selected by the pilot or copilot. An extension cord allows removal of the utility light from the gooseneck for manual use. The light is equipped with a self-contained rheostat and has a rheostat override push button that provides full lamp output regardless of knob setting. Power for the light is provided by the COCKPIT LTS circuit breaker. Three NVG-compatible floodlights are mounted on the glareshield (figure 2-4). Floodlight intensity is controlled by the CONSOLE LT rheostat. The floodlights are powered by CSL LTS circuit breaker (figure 2-12).

2-60. NVG-COMPATIBLE FILTERS.

WARNING

NVG-compatible filters are to remain in the open position (unfiltered) during day flight and night flight without night vision goggles.

NVG-compatible filters are mounted next to the master caution, caution advisory, RPM, and radar warning indicators (figure 2-13 and figure 2-14). The filters are positioned closed for NVG flight only.

SECTION XIII FLIGHT INSTRUMENTS

2-61. AIRSPEED INDICATOR.



The airspeed indicator (figure 2-13 and figure 2-14) displays the air speed of the helicopter indicated in knots. The airspeed is obtained by measuring the difference between impact air pressure from the pitot tube and the static air pressure from the static ports.

2-62. AAU-31 / A PNEUMATIC ALTIMETER.

1. Description. The AAU-31/A pneumatic counter-drum-pointer altimeter is a precision pressure altimeter (figure 2-14). Pressure altitude is displayed by a 100-foot drum and a single pointer indicating hundreds of feet on a circular scale, with 50' center markings. Below an altitude of 10,000 feet, a diagonal warning symbol will appear on the 10,000-foot counter.

A barometric pressure setting knob is provided to insert the desired altimeter setting in inches of Hg. A DC powered vibrator operates inside the altimeter whenever aircraft power is on.

2. Operation

a Normal Operation. The ALT VIB  or ALT AAU 31/32A  circuit breaker must be in. The altimeter indicates pneumatic altitude reference to the barometric pressure level as selected by the pilot. A vibrator, powered by the DC essential bus, is contained in the altimeter and requires a minimum of one minute warmup prior to checking or setting the altimeter.

b Abnormal Operation. If the altimeter's internal vibrator becomes inoperative due to internal failure of DC power failure, the pointer and drum may momentarily hang up when passing from "9" through "0" (climbing) or from "0" through "9" (descending). This hang-up will cause lag, the magnitude of which will depend on the vertical velocity of the aircraft and the friction in the altimeter. Pilots should be especially watchful for this type failure when the minimum approach altitude lies within the "8" — "1" part of the scale (800-100, 1800-2100, etc.).

2-62.1. ALTITUDE ENCODER/PNEUMATIC ALTIMETER AAU-32/A

a. Description. The AAU-32/A pneumatic counter-drum-pointer altimeter is a self-contained unit which consists of a precision pressure altimeter combined with an altitude encoder (figure 2-18.1). The display indicates and the encoder transmits, simultaneously, pressure altitude reporting. Altitude is displayed on the altimeter by a 10,000 foot counter, a 1,000 foot counter and a 100 foot drum. A single pointer indicates hundreds of feet of a circular scale, with 50 foot center markings. Below an altitude of 10,000 foot a diagonal warning system will appear on the 10,000 foot counter. A barometric pressure setting knob is provided to insert the desired altimeter setting in inches of Hg. A DC powered vibrator operates in-

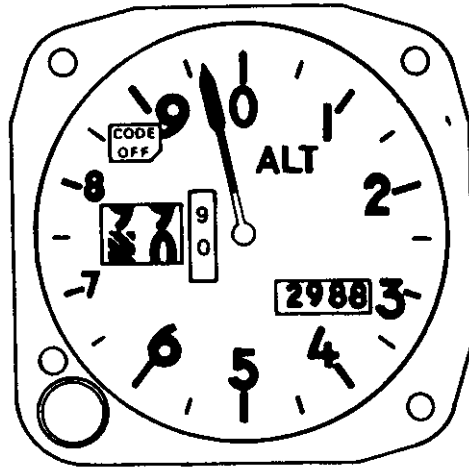

MS026131

Figure 2-18.1. AAU-32/A Altitude Encode/Pneumatic Altimeter

side the altimeter whenever the aircraft power is on. The vibrator is powered through the ALT AAV31/32A[A] or ALT VIB[C] circuit breaker. The encoder is DC powered with the vibrator through the ALT AAU31/32A circuit breaker [A] or separately AC powered through the ALT ENCDR circuit breaker [C]. If power to the altitude encoder is lost, a warning flag placarded CODE OFF will appear in the upper left portion of the instrument face indicating that the altitude encoder is inoperative and that the system is not reporting altitude to ground stations. The CODE OFF flag monitors only the encoder function of the altimeter. It does not indicate transponder condition. The altitude reporting function may be inoperative without the AAU-32/A CODE OFF flag showing, in case of the transponder failure or improper control settings. It is also possible to get a "good" MODE C test on the transponder control with the CODE OFF flag showing. Display of the CODE OFF flag only indicates an encoder power failure or a CODE OFF flag failure. In this event, check that encoder power is available and that the circuit breakers are in. If the flag is still visible, radio contact should be established with a ground radar site to determine whether the altitude reporting function is operative, and the remainder of the flight should be conducted accordingly.

b. Operation.

(1) Normal Operation. The ALT AAU31/32[A] or ALT VIB and ALT ENCDR[C] circuit breakers should be in prior to flight. The Mode C switch (M-C) on the transponder control should be switched to ON for altitude reporting during flight. The AAU-32/A altimeter indicates pneumatic altitude reference to the barometric pressure level as selected by the pilot. At ambient pressure, altimeters should agree with ± 70 feet of the field elevation when the proper barometric pressure setting is set in the altimeter. A red flag marked CODE OFF is located in the upper left portion of the altimeters face. In order to supply Mode C information to the IFF transponder, the CODE OFF flag must not be visible. A vibrator, powered by the DC essential bus, is contained in the altimeter and requires a minimum of one minute warm up prior to checking or setting the altimeter.

(2) Abnormal Operation.

(a) If the altimeters internal vibrator becomes inoperative due to internal failure or DC power failure, the pointer and drum may momentarily hang-up when

passing from 9 through 0 (climbing) or from 0 through 9 (descending). This hang-up will cause lag, the magnitude of which will depend on the vertical velocity of the aircraft and the friction in the altimeter.

(b) If the CODE OFF flag is visible, the encoder power is not available, the circuit breaker is not in, or there is an internal altimeter encoder failure.

(c) If the altimeter indicator does not correspond within 70 feet of the field elevation (with proper local barometric setting) the altimeter needs rezeroing or there has been an internal failure.

(d) If the baro set knob binds or sticks, abnormal force should not be used to make the setting as this may cause internal gear failure resulting in altitude errors. Settings can sometimes be made by backing off and turning at a slower rate.

2-63. PRESSURE ALTIMETER.

NOTE

Not applicable after MWO 55-1520-228-50-24 is applied.

A The pressure altimeter (figure 2-13) furnishes direct readings of height above mean sea level when properly adjusted.

2-64. ATTITUDE INDICATOR.

A The attitude indicator (figure 2-13) displays the attitude of the helicopter. The indicator is self contained and is connected through circuit breakers on the overhead console to the 115-volt AC bus.

C The attitude indicator (figure 2-14) displays the helicopter pitch and roll attitudes in relation to the earth horizon. Pitch attitude is displayed by the motion of the sphere with respect to the miniature airplane. Roll attitude is displayed by the motion of the roll pointer with respect to the fixed roll scale. The sphere can be adjusted to zero indication by the pitch trim knob. The rate of turn pointer indicates in which direction and at what rate the helicopter is turning. The inclinometer indicates when the helicopter is in trim, either in a coordinated turn

or in straight and level flight. The warning flag, attitude (ATT) and rate of turn pointer provide indication of system malfunctions. When the gyro is being caged or when 28 Vdc power is interrupted, the ATT flag will be in full view. The rate of turn pointer will be biased out of view when 28 Vdc is interrupted. The circuit is powered by 28 Vdc essential bus and protected by ATTD HRZN and ATTN TURN circuit breakers. The rate-of-turn pointer is driven by 115 VAC internal circuitry that derives rate-of-turn from the output synchro transmitter of the directional gyro magnetic compass.

2-65. TURN AND SLIP INDICATOR.

A The turn and slip indicator (figure 2-13) is controlled by a direct current electrically actuated gyro. This instrument has a needle (turn indicator) and a ball (slip indicator). Although needle and ball are combined in one instrument and are normally read and interpreted together, each has its own specific function and operates independently of the other. The ball indicates when the helicopter is in directional balance either in a turn or in straight and level flight. If the helicopter is yawing or slipping, the ball will be off center. The needle indicates in which direction and at what rate the helicopter is turning.

2-66. FREE AIR TEMPERATURE INDICATOR.

The bi-metal free air temperature indicator (figure 2-13 and figure 2-14) is in the windshield, and provides a direct reading of the outside air temperature.

2-67. MAGNETIC COMPASS.

The magnetic compass (figure 2-13 and figure 2-14) is a standard, non-stabilized, magnetic type instrument mounted on a support which is attached to the right side of the cabin structure forward of the pilot. The compass is used in conjunction with a compass correction card that is located near the compass. In aircraft with low reflective painted interior, the compass correction card will be located in the front of the logbook.

2-68. VERTICAL SPEED INDICATOR.

The vertical speed indicator (figure 2-13 and figure 2-14) displays the helicopter ascent and descent speed in feet per minute. The indicator is actuated by the rate of atmospheric pressure change.

2-69. CONUS NAVIGATION SYSTEM (AN/ARN-123).

Refer to Chapter 3.

2-70. RADAR ALTIMETER (AN/APN-209).

Refer to Chapter 3.

2-71. RADAR WARNING SYSTEM.

Refer to Chapter 3.

2-72. MISCELLANEOUS INDICATORS.

Instruments and indicators that are independent or are linked with more than one system are the clock and master caution and warning system (figure 2-12).

a. Clock. The clock (figure 2-13 and figure 2-14) has a sweep-second pointer and a minute totalizer hand to indicate elapsed time. The control knob in the upper right corner of the case starts, stops, and returns the pointers to the 12 o'clock position when actuated.

b. Caution System. The caution system (figure 2-13 and figure 2-14) is a segment wording type, consisting of a segment wording CAUTION panel (figure 2-19) on the lower console and a remote MASTER CAUTION segment on the instrument panel. The purpose of the CAUTION system is to provide visual indication suitable for day or night operation, that a fault condition has occurred. In addition, a positive signal is provided to illuminate the remote MASTER CAUTION indicator. Each fault condition, as it occurs, is indicated by **A**, flashing of the lettering on the segment involved and by a flashing of the MASTER CAUTION indicator. **B**, steady illumination of the lettering on the segment involved and by a steady illumination of the MASTER CAUTION indicator. A momentary positioning of RESET-TEST switch to RESET extinguishes the MASTER CAUTION light so that it will illuminate for the next fault indication; also, the fault segment will be steadily ON. Segments will remain lighted as long as the fault condition(s) exist. Momentarily pressing the RESET-TEST switch to TEST will check if all caution lights are operational. Testing of the system will not change the existing fault conditions. The BRIGHT-DIM



WARNING PANEL

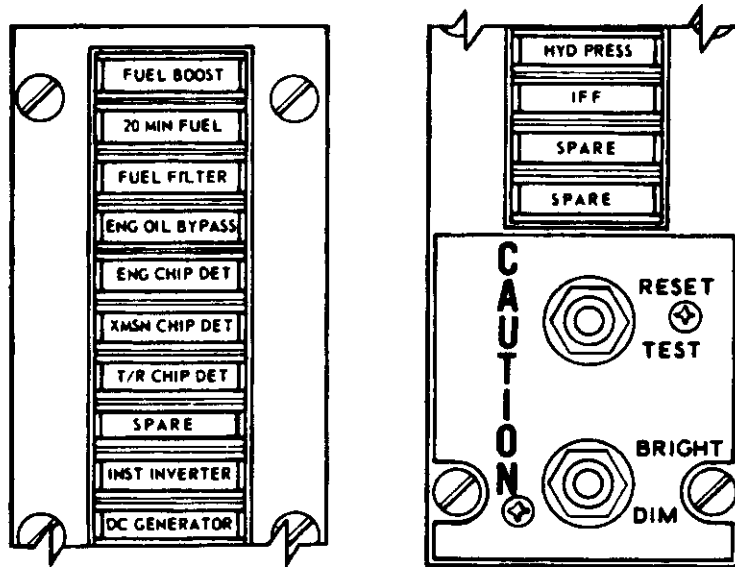

CAUTION PANEL

CAUTION PANEL WORDING	FAULT CONDITIONS
<p>FUEL BOOST 20 MIN FUEL FUEL FILTER ENG OIL BYPASS</p> <p>ENG CHIP DET XMSN CHIP DET T/R CHIP DET INST INVERTER DC GENERATOR HYD PRESS IFF</p>	<p>Fuel boost pump pressure is low. Fuel quantity is below approximately 65 to 98 lbs. Fuel filter is partially obstructed. Engine oil is at dangerously low level and/or oil is bypassing oil cooler. Metal particles are in engine. Metal particles are in transmission. Metal particles are in tail rotor gearbox. Ac inverter has failed. Dc generator has failed. Hydraulic pressure is low. IFF system is inoperative.</p>

NOTE: WITH NVG FLIP FILTERS INSTALLED 

MS026079

Figure 2-19. Warning and Caution Panels

switch (figure 2-19) controls the brightness of the caution panel lights and the MASTER CAUTION light. The INST LTS switch must be moved from the DIM position before the caution panel lights can be dimmed. The system is so designed that after each initial application of power, the lamps will illuminate in the bright condition.

c. Warning System. The warning system consists of five individually illuminated warning light segments mounted in the MASTER CAUTION and warning light panel (figure 2-19) on the instrument panel. The purpose of this system is to provide visual indication for day or night operation that any of the five conditions or combinations thereof has occurred. Each fault condition as it occurs is indicated by a steady illumination of the lettering on the particular segment. In addition, an audio signal sounds when the ENGINE OUT or ROTOR RPM segment is illuminated and the collective pitch is not in the full down position. The warning indicator segment remains illuminated until the fault condition is corrected.

ENGINE OUT	Engine N1 speed below 55 ± 3%.
XMSN OIL PRESS	Transmission oil pressure dangerously low.
XMSN OIL HOT	Transmission dangerously hot.
ROTOR RPM	Rotor rpm low.
MASTER CAUTION	Fault condition in caution panel.

The WARNING LTS TEST switch (figure 2-13 and figure 2-14) is pressed to check for illumination of all the warning lights.

SECTION XIV SERVICING, PARKING, AND MOORING

2-73. SERVICING.

a. Servicing Diagram. Refer to figure 2-20 and figure 2-21.

b. Fuels, Oils, Fluids, Specifications, and Capacities. Refer to table 2-1.

2-74. APPROVED FUELS, OILS, AND FLUIDS.

a. Fuels. Refer to table 2-2.

b. Oils. Refer to table 2-3.

c. Fluids. Refer to table 2-4.

2-75. FUEL TYPES. See table 2-2.

a. JP-4. This fuel contains icing inhibitor blended at the refinery. Commercial Jet B is a JP-4 type fuel; its mixture may or may not contain icing inhibitors.

b. JP-5 and JP-8. These fuels contain icing inhibitors blended at the refinery. Jet A and Jet A1 are JP-5 type fuels without icing inhibitors.

c. Emergency Fuel. Aviation gasolines (MIL-G-5572) without Tricresyl Phosphate (TCP) are designated as the emergency fuels to be used in this aircraft.

2-76. USE OF FUELS.

a. JP-4. There is no special limitation on the use of JP-4 fuel, but limitations are imposed when fuels other than JP-4 are used.

b. JP-5, JP-8, Jet A, and Jet A1. These fuels may be added to JP-4 and to each other in any quantities.

c. Emergency Fuels. Aviation gasoline may also be added to turbine engine fuels in any quantity. Fuel mixtures containing any amount of Aviation Gasoline must be recorded in the Remark Section of DA Form 2408-13-1 as an emergency fuel, noting the type of fuel, additives, and duration of operation. The 6 hour total engine operation limitation applies.

d. Refer to fuel operation limits, Chapter 5, when fuels other than JP-4 are used.

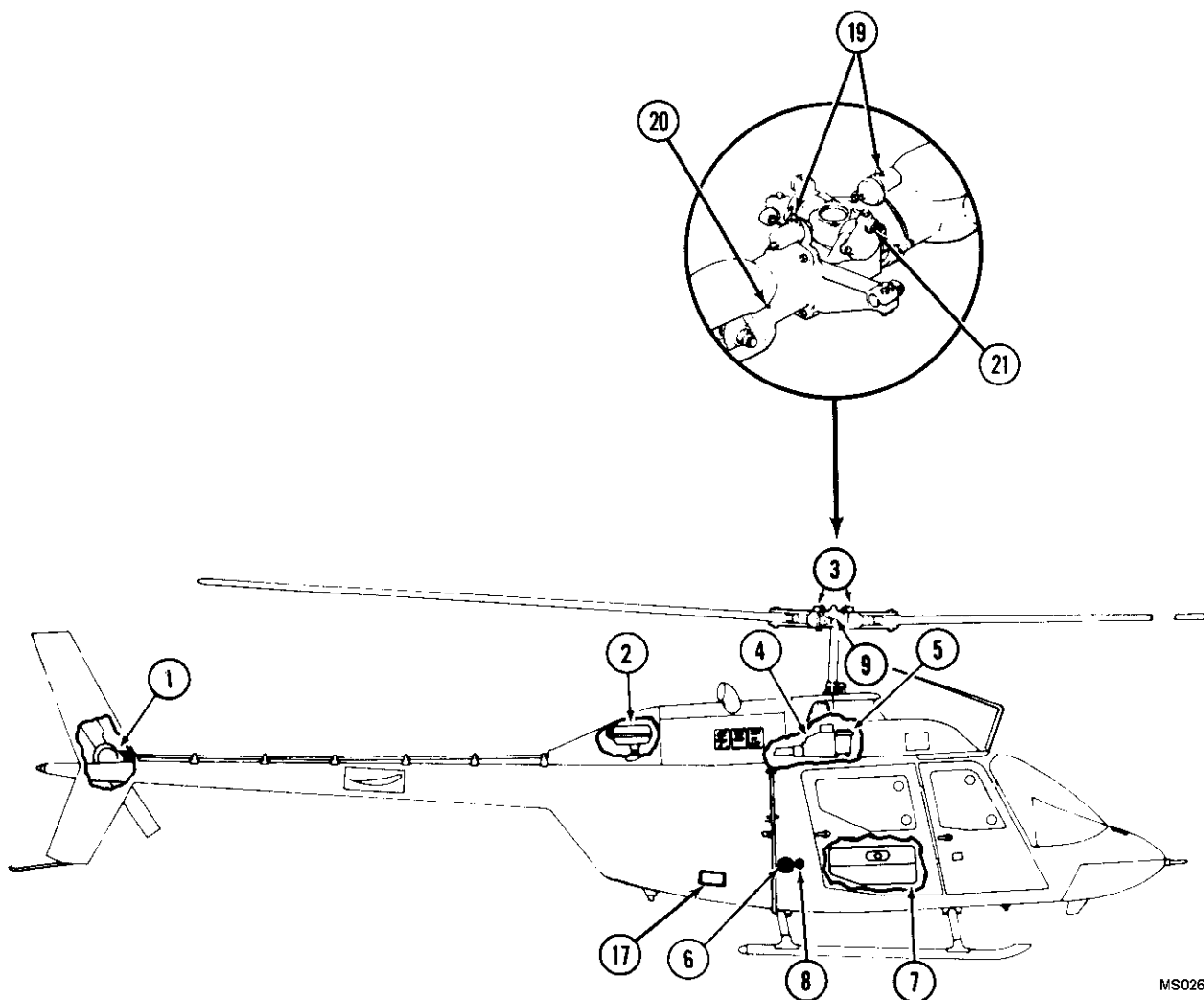

MS026080

- | | |
|-----------------------------|--|
| 1. Tail Rotor Gearbox | 12. Deleted |
| 2. Engine Oil Tank | 13. Deleted |
| 3. Grip Reservoirs | 14. Tail Rotor Gearbox Filler |
| 4. Transmission | 15. Engine Oil Tank Filler |
| 5. Hydraulic Reservoir | 16. Hydraulic Reservoir Filler |
| 6. Fuel Tank Filler | 17. External Power Receptacle |
| 7. Auxiliary Fuel Cell | 18. Fuel Cell Sump Drain Valve |
| 8. Static Ground Receptacle | 19. Relief Valve |
| 9. Pillow Block Reservoirs | 20. Fitting Lubrication (Grease Lubrication) |
| 10. Transmission Oil Filler | 21. Fitting Lubrication (Grease Lubrication) |
| 11. Transmission Oil Filter | |

Figure 2-20. Servicing Diagram A (Sheet 1 of 2)

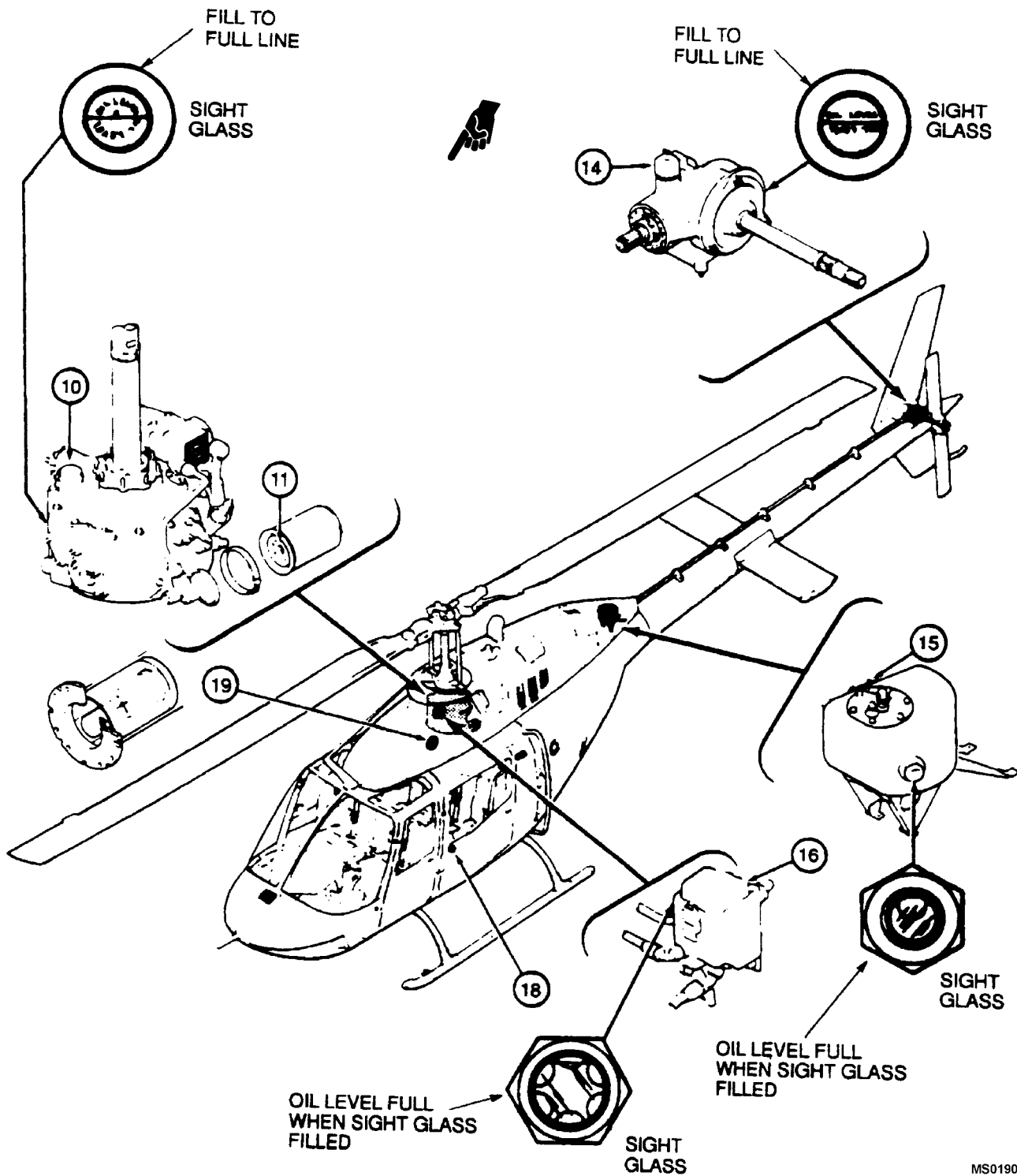
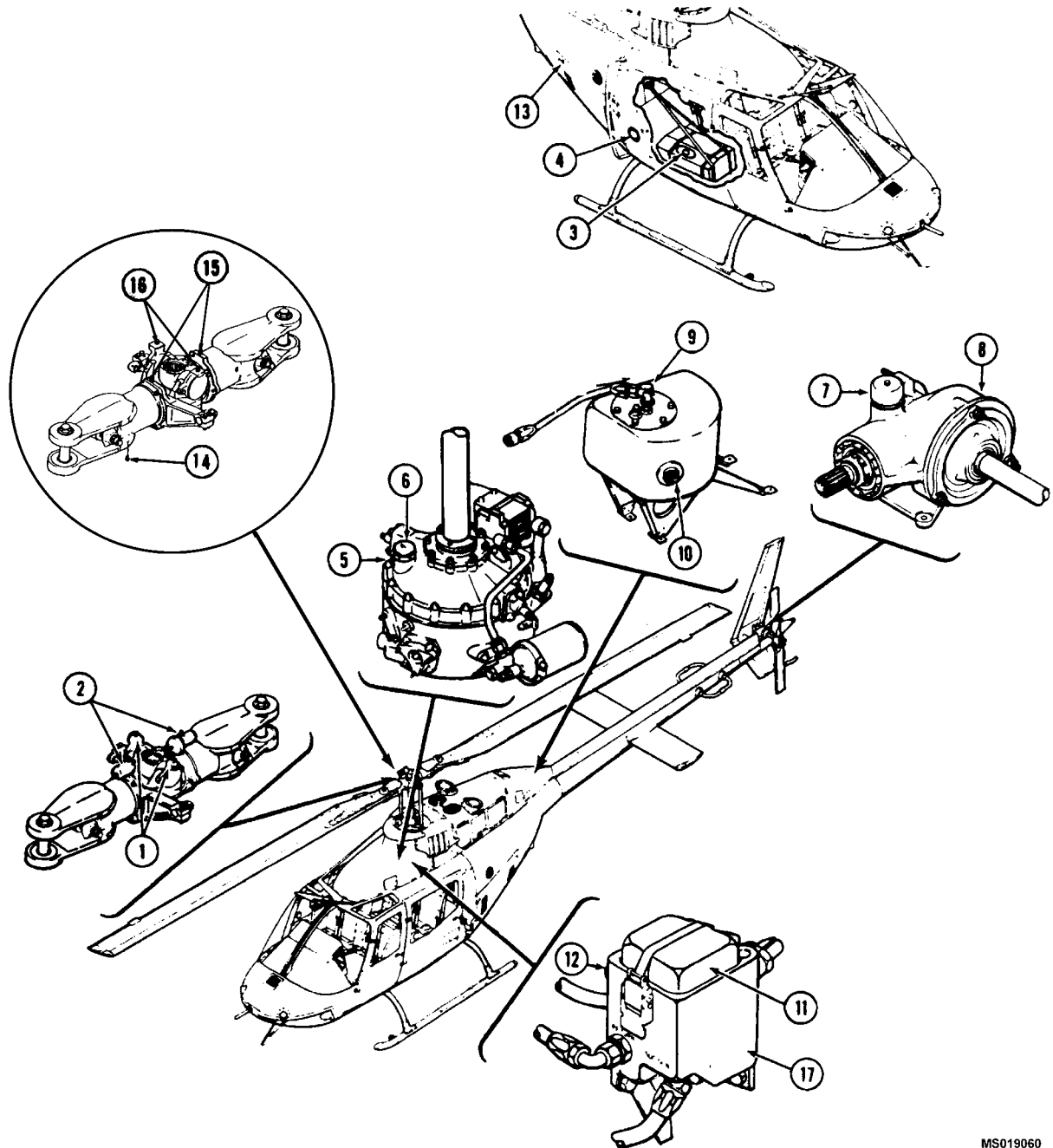

Figure 2-20. Servicing Diagram A (Sheet 2 of 2)



MS019060

- | | |
|---|---|
| 1. Pillow Block Reservoir Grease Fittings | 10. Engine Oil Tank Sight Glass |
| 2. Grip Reservoir | 10.1. Deleted |
| 3. Auxiliary Fuel Filler Cap | 11. Hydraulic Filler Cap |
| 4. Closed Circuit Refueling Receiver | 12. Hydraulic Sight Glass |
| 5. Transmission Sight Glass | 13. Grounding Point |
| 6. Transmission Filler Cap | 14. Fitting Lubrication (Grease Lubricated Hub) |
| 7. Tail Rotor Gearbox Filler Cap | 15. Relief Valve (Grease Lubricated Hub) |
| 8. Tail Rotor Gearbox Sight Glass | 16. Fitting Lubrication (Grease Lubricated Hub) |
| 9. Engine Oil Filler Cap | 17. Hydraulic Reservoir |

Figure 2-21. Servicing Diagram

Table 2-1. Fuels, Oils, Fluids, Specifications, and Capacities

SYSTEM	SPECIFICATION	CAPACITY
Fuel (Note 1)	MIL-T-5624 (JP-4) MIL-T-5624 (JP-5) MIL-T-83133 (JP-8) MIL-G-5572 (without TCP) Emergency Fuel	71.5 U.S. Gal (70.3 usable)
Fuel(Auxiliary Fuel Cell)(Note 1)	MIL-T-5624 (JP-4) MIL-T-5624 (JP-5) MIL-T-83133 (JP-8) MIL-G-5572 (without TCP) Emergency Fuel	23.9 U.S. Gal

WARNING

If DOD-L-85734 oil is added to any turbine engine or engine lubricated gearboxes, the engine/gearbox should be drained and flushed with proper lubricant when it becomes available.

CAUTION

*Lubrication oil made to MIL-L-7808 by Shell Oil Company under their part number 307, qualification number 7D-1, shall not be used in OH-58A/C engine or helicopter systems. It contains additives which are harmful to seals in the systems.

Engine Oil(Note 2)	*MIL-L-7808 NATO Code is 0-148 For use in ambient temperatures below minus 32°C/25° F MIL-L-23699 NATO Code is 0-156 For use in ambient temperatures above minus 32°C/25° F	11.2 U.S. Pt
--------------------	--	--------------

CAUTION

*Lubrication oil made to MIL-L-7808 by Shell Oil Company under their part number 307, qualification number 7D-1, shall not be used in OH-58A/C engine or helicopter systems. It contains additives which are harmful to seals in the systems.

Transmission Oil(Note 2)	*MIL-L-7808 NATO Code is 0-148 For use in ambient temperatures below minus 32°C/25° F MIL-L-23699 NATO Code is 0-156For use in ambient temperatures above minus 32°C/25° F DOD-L-85734 for use in ambient temperatures above -40°C/40°F	4.0 U.S. Qts.
--------------------------	---	---------------

Table 2-1. Fuels, Oils, Fluids, Specifications, and Capacities — Continued

SYSTEM	SPECIFICATION	CAPACITY
CAUTION		
<p>*Lubrication oil made to MIL-L-7808 by Shell Oil Company under their part number 307, qualification number 7D-1, shall not be used in OH-58A/C engine or helicopter systems. It contains additives which are harmful to seals in the systems.</p>		
Tail Rotor Transmission Oil (Note 2)	<p>*MIL-L-7808 NATO Code is 0-148 For use in ambient temperatures below minus 32°C/25° F MIL-L-23699 NATO Code is 0-156 For use in ambient temperatures above minus 32°C/25° F DOD-L-85734 for use in ambient temperatures above -40°C/40°F</p>	0.375 U.S. Pt. (6 oz)
Deleted		
WARNING		
<p>Prolonged contact with hydraulic fluid liquid or mist can irritate eyes and skin. After any prolonged contact with skin, immediately wash contacted area with soap and water. If liquid contacts eyes, flush immediately with clear water. If liquid is swallowed, do not induce vomiting; get immediate medical attention. Wear rubber gloves when handling liquid. If prolonged contact with mist is likely, wear an appropriate respirator. When fluid is decomposed by heating, toxic gases are released.</p>		
Hydraulic Fluid Reservoir	MIL-H-5606 (Note 3) MIL-H-83282 (Note 4)	Fill to overfill lip in reservoir
NOTE		
<ol style="list-style-type: none"> 1. See Chapter 5 for operating limits. 2. When oil is mixed or changed from one type to the other enter on DA Form 2408-13-1. Oil shall be drained and system serviced with approved oil within six hours of operation. 3. For use in ambient temperatures below -40°F 4. Mixing of hydraulic fluids is authorized only in emergency situations. An entry in the remarks section of DA Form 2408-13-1 is required. 5. The temperature limitations of DOD-L-85734 oil are identical to that of MIL-L-23699. It should be noted that DOD-L-85734 oil is a direct replacement for MIL-L-23699 oil, and not for MIL-L-7808 oil. 		

Table 2-2. Approved Fuels

SOURCE			
US MILITARY NATO CODE NO.	JP-4 (MIL-T-5624) F40 (WIDE CUT TYPE)	JP-5 (MIL-T-5624) or JP-8 (MIL-T-83133) F-44 or F-34 (HIGH FLASH TYPE)	
COMMERCIAL FUEL	JET B	JET A	MET A-1 NATO F-34
ASTM-D-1655			
American Oil Co.	American JP-4	American Type A	
Atlantic Richfield	Arcojet B	Arcojet A Richfield A	Arcojet A-1 Richfield
Richfield Div			A-1
B.P. Trading	B.P.A.T.C		B.P.A.T.K.
Caltex Petroleum Corp.	Caltex Jet B		Caltex Jet A-1
Cities Service Co.		CITGO A	
Continental Oil Co.	Conoco JP-4	Conoco Jet-50	Conoco Jet-60
Gulf Oil	Gulf Jet B	Gulf Jet A	Gulf Jet A-1
EXXON Co. USA	EXXON Turbo Fuel B	EXXON A	EXXON A-1
Mobil Oil	Mobil Jet B	Mobil Jet A	Mobil Jet A-1
Phillips Petroleum	Philjet JP-4	Philjet A-50	
Shell Oil	Aeroshell JP-4	Aeroshell640	Aeroshell 650
Sinclair		Superjet A	Superjet A-1
Standard Oil Co.		Jet A Kerosene	Jet A-1 Kerosene
Chevron	Chevron B	Chevron A-50	Jet A-1
Texaco	Texaco Avjet B	Avjet A	Avjet A-1
Union Oil	Union JP-4	76 Turbine Fuel	
FOREIGN FUEL	NATO F-40	NATO F-44	
Belgium	BA-PF-2B		
Canada	3GP-22F	3-6P-24e	
Denmark	JP-4 MIL-T-5624		
France	Air 3407A		
Germany (West)	VTL-9139-006	UTL-9130-007/UTL-9130-010	
Greece	JP-4 MIL-T-5624		
Italy	AA-M-C-1421	AMC-143	
Netherlands	JP-4 MIL-T-5624	D. Eng Rd 2493	
Norway	JP-4 MIL-T-5624		
Portugal	JP-4 MIL-T-5624		
Turkey	JP-4 MIL-T-5624		
United Kingdom (Britain)	D. Eng Rd 2454	D. Eng Rd 2498	

NOTE

Anti-icing and Biocidal Additive for Commercial Turbine Engine Fuel – The fuel system icing inhibitor shall conform to MIL-I-27686. The additive provides anti-icing protection and also functions as a biocide to kill microbial growths in aircraft fuel systems. Icing inhibitor conforming to MIL-I-27686 shall be added to commercial fuel, not containing an icing inhibitor, during refueling operations, regardless of ambient temperatures. Refueling operations shall be accomplished in accordance with accepted commercial procedures. This additive (prist or ec.) is not available in the Army Supply System, but will be locally procured when needed.

Table 2-3. Approved Oils

APPROVED COMMERCIAL MIL-L-7808 TYPE OILS

MANUFACTURER'S NAME	MANUFACTURER'S DESIGNATION
American Oil and Supply Co. Humble Oil and Refining Co. Mobil Oil Corp.	PQ Turbine Oil 8365 ESSO/ENCO Turbo Oil 2389 RM-184A/RM-201A



Do not use Shell Oil Co., Part No 307, Qualification No. 7D-1 oil (MIL-L-7808). It can be harmful to seals made of silicone.

APPROVED COMMERCIAL MIL-L-23699 TYPE OILS

MANUFACTURER'S NAME	MANUFACTURER'S DESIGNATION
American Oil and Supply Co.	PQ Turbine Lubricant 5247/6423/6700/7731/8878/9595
Bray Oil Co.	Brayco 899/899-G/899-S
Castrol Oil Co.	Castrol 205
Chevron International Oil Co., Inc	Jet Engine Oil 5
Crew Chemical Corp.	STO-21919/STO-21919A/STD 6530
W.R. Grace and Co. (Hatco Chemical Div.)	HATCOL 3211/3611
Exxon	Turbo Oil 2380 (WS-6000)/2395 (WS-6459)/ 2392/2393
Mobile Oil Corp.	RM-139A/RM-147A/Avrex S Turbo 260/Avrex S Turbo 265
Royal Lubricants Co.	Royco 899 (C-915)/899SC/Stauffer Jet II
Shell Oil Co., Inc.	Aeroshell Turbine Oil 500
Shell International Petroleum Co., Ltd.	Aeroshell Turbine Oil 550
Standard Oil Co., of California	Chevron Jet Engine Oil 5
Stauffer Chemical Co.	Stauffer 6924/Jet II
Texaco, Inc.	SATO 7377/7730 TL-8090
Royal Lubricants Co., Inc.	Aeroshell/Royco Turbine Oil 500
Castrol Endurance Tech.	Castrol 5050

APPROVED COMMERCIAL DOD-L-85734 TYPE OILS

MANUFACTURER'S NAME	MANUFACTURER'S DESIGNATION
Royal Lubricants Co.	Royco Turbine Oil 555
Exxon Company, USA	Exxon Turbo Oil 25
ARPOL Petroleum Co.	Arpolube 85734

Table 2-4. Approved Fluids

APPROVED COMMERCIAL MIL-H-5606 TYPE FLUIDS

MANUFACTURER'S NAME	MANUFACTURER'S DESIGNATION
American Oil and Supply Co.	"PO" 4226
Bray Oil Co.	Brayco 757B Brayco 756C Brayco 756D
Castrol Oils, Inc.	Hyspin A
Humble Oil and Refining Co.	Univis J41
Mobile Oil Corp.	Aero HFB
Pennsylvania Refining Co.	Petrofluid 5606B Petrofluid 4607
Royal Lubricants Co.	Royco 756C/DDS-437
Shell Oil Co.	XSL 7828
Standard Oil Co., of California	PED 3565 PED 3337
Texaco, Inc.	TL-5874
Stauffer Chemical Co.	Aero Hydroil 500
Union Carbide Chemical Co.	YT-283
Union Carbide Corp.	FP-221

NOTE

Mixing of hydraulic fluids is authorized only in emergency situations. An entry in the remarks section of DA Form 2408-13 DA Form 2408-13 is required.

APPROVED COMMERCIAL MIL-H-83282 TYPE FLUIDS

MANUFACTURER'S NAME	MANUFACTURER'S DESIGNATION
Bray Oil Co.	Micronic 882
Royal Lubricants Co.	Royco 782
Hanover Processing Co.	Hanover R-2HF 832

APPROVED COMMERCIAL MIL-H-83282 TYPE FLUIDS (cont)

MANUFACTURER'S NAME	MANUFACTURER'S DESIGNATION
Gulf Oil Chemicals Co.	TS 741
Penreco	Petrofluid 822
Shell International Petroleum Co.	Aeroshell Fluid 31
American Oil and Supply Co.	PQ3883PQ4219PQ4268PQ4362CPQ4401
NYCO S.A.	Hydraunycoil FH2
Emery Industries, Inc.	Emery 2946
Hatco Chemical Co.	Hatcol 4283

Table 2-4. Approved Fluids — Continued

WARNING

Prolonged contact with liquid or mist can irritate eyes and skin. After any prolonged contact with skin, immediately wash contacted area with soap and water. If liquid contacts eyes, flush immediately with clear water. If liquid is swallowed, do not induce vomiting; get immediate medical attention. Wear rubber gloves when handling liquid. If prolonged contact with mist is likely, wear an appropriate respirator. When fluid is decomposed by heating, toxic gases are released.

NOTE

Mixing of hydraulic fluids is authorized only in emergency situations. An entry in the Remarks Section of DA Form 2408-13 is required.

■ Table 2-4.1 HAS BEEN DELETED.

2-77. FUEL SYSTEM SERVICING. (POWER OFF)

a. Precaution.

NOTE

Servicing personnel shall comply with all safety precautions and procedures in FM 10-67-1.

(1) Be sure battery switch is in OFF position and external power is disconnected before fueling or defueling the helicopter.

(2) Ground the helicopter at the receptacle located adjacent to the filler cap on the helicopter to the filler-nozzle before removing filler cap.

(3) Servicing unit shall be grounded (servicing unit to ground and servicing unit to helicopter). The helicopter should be grounded to the same ground point as is the servicing unit.

(4) After completion of servicing, remove nozzle, reinstall cap and disconnect all grounds from helicopter. Wash down and remove any spillover of jet fuel. This fuel does not evaporate as rapidly as gasoline, and constitutes a fire hazard for a much longer time. Cleaning materials or clothing which have become saturated with jet fuel shall be disposed of well away from the helicopter or hangar.

b. Servicing.

CAUTION

Internal fuel cell hoses and clamps can be jarred loose with fuel nozzles. Insert nozzle carefully in a generally downward direction, avoiding contact with internal fuel hoses. Fuel nozzles must be hand held during servicing.

(1) Fill tank cells with specified fuel. Refer to table 2-1.

WARNING

In the event of major spillage of fuel, all powered equipment will be shut down. All personnel will leave the vicinity and be positioned to prevent any sources of possible ignition from entering area. The fire department will be summoned to the area to render safety.

NOTE

Settling time for AVGAS is 15 minutes per foot of tank depth and one hour per foot depth for jet (JP) fuels. Allow the fuel to settle for the prescribed period before any fuel samples are taken. (Approximately three hours for JP fuel.)

(2) Refer to 2-1 for fuel tank capacity.

c. Closed Circuit Refueling.

CAUTION

The closed circuit refueling receptacle is subject to damage at the gravity refueling port. Refer to figure 2-22. This damage can cause external fuel leakage during subsequent closed circuit refueling operations. To preclude damage to the receptacle, the closed circuit nozzle will be used if possible when refueling. If, however, the receptacle has been previously damaged and leakage occurs, the following must be observed:

Closed circuit refueling operations with a leaking receptacle shall be discontinued. Gravity refueling method shall be used until the receptacle can be replaced or repaired.

NOTE

If the nozzles do not reduce the fuel pressure to less than 25.5 PSIG, the receiver is designed to shut off fuel flow.

(1) Ground the helicopter at the receptacle located adjacent to the filler cap on the helicopter to the filler-nozzle and remove filler cap.

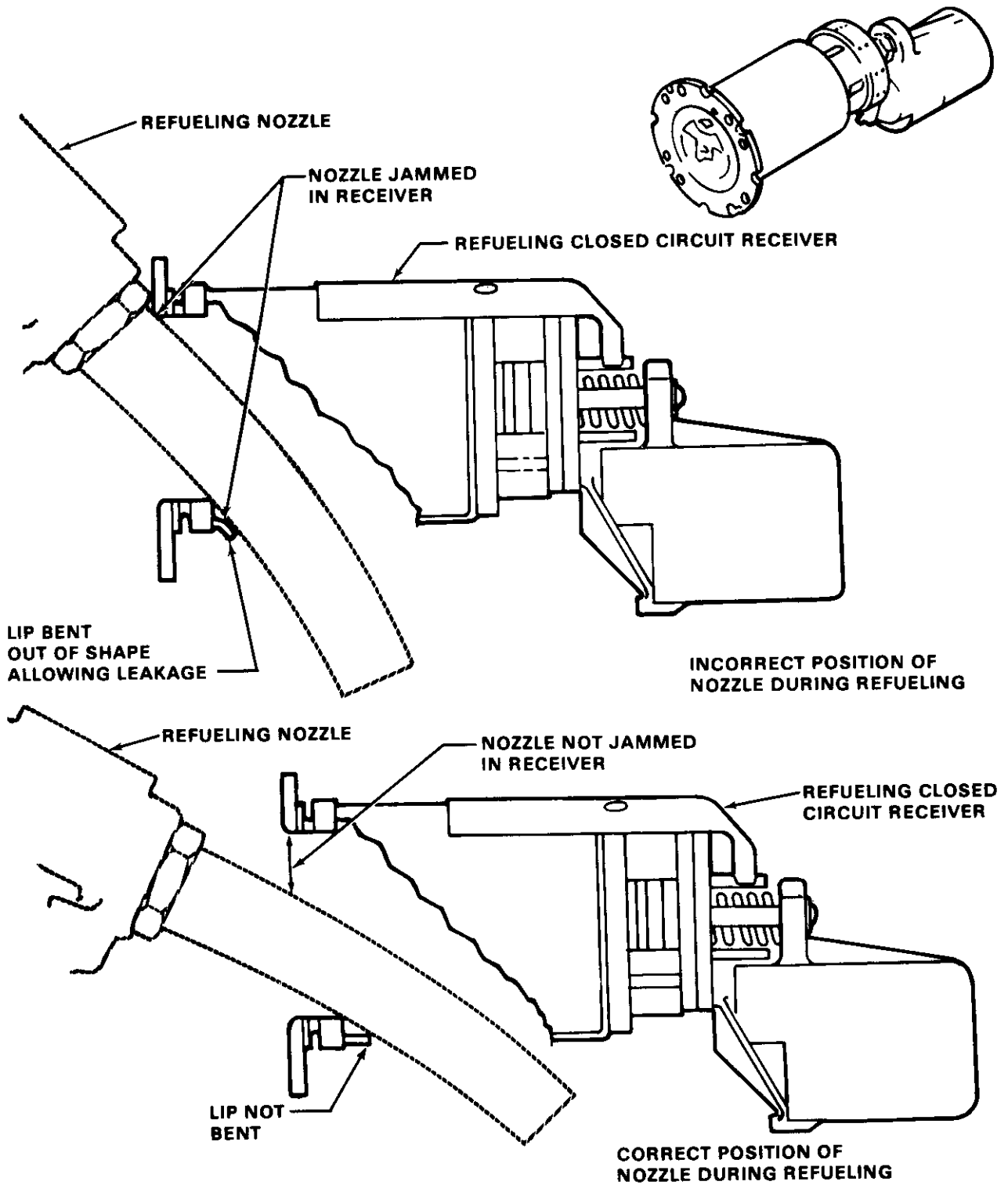

MS026081

Figure 2-22. Gravity Refueling With Closed Circuit Receiver

(2) Ensure that gravity refueling port is closed. If not, rotate inner sleeve counterclockwise until gravity refueling port is closed and flange of sleeve is in contact with rivet at base or receiving cylinder. Refer to figure 2-23.

CAUTION

Ensure that servicing unit pressure is not above 125 PSI while refueling.

(3) Insert fueling nozzle into receiver and actuate automatic nozzle lever to ON or FLOW position. Pin at base of nozzle will momentarily indicate when fuel flow stops.

(4) Fuel flow will automatically shut off when normal fuel level is reached. Just prior to normal shut off, fuel flow may cycle several times as fuel level is reached. Gage on servicing unit will indicate when flow is stopped.

(5) When fuel flow has stopped, actuate lever on nozzle to OFF, disconnect nozzle from receiver and replace filler cap.

(6) Disconnect fuel nozzle ground and rewind hose assembly.

(7) Disconnect servicing unit ground at helicopter.

(8) Disconnect servicing unit ground at grounding stake.

CAUTION

If helicopter is equipped with closed circuit refueling system and fuel servicing unit is not equipped with related nozzle for closed circuit refueling, a gravity system may be used providing the servicing nozzle does not exceed 1.75 inches outside diameter. To refuel utilizing the gravity nozzle, it is necessary to position the inner sleeve of receiver until slot is lined up with fuel port in bottom of receiver. Position nozzle into port in order to bypass closed circuit refueling system if caution is not used to prevent damage to inner sleeve of receiver at fuel port through improper use of nozzle.

d. Gravity Refueling.

(1) Ground the helicopter at the receptacle located adjacent to the filler cap on the helicopter to the filler-nozzle and remove filler cap.

(2) Rotate inner sleeve clockwise until sleeve clears port in bottom of fuel receiver. Refer to figure 2-23.

(3) Position nozzle into port of fuel receiver.

(4) Fill to specified level.

(5) Remove nozzle and rotate inner sleeve counterclockwise until gravity refueling port is closed and flange of inner sleeve is in contact with rivet at base of receiver cylinder.

(6) Reinstall filler cap.

(7) Disconnect fuel nozzle ground and rewind hose.

(8) Disconnect servicing unit ground at helicopter.

(9) Disconnect servicing unit ground at grounding stake.

2-78. FUEL SYSTEM SERVICING. (RAPID (HOT) REFUELING).

WARNING

When it is determined that rapid (hot) refueling is required (prescribed in FM 10-68), proper grounding of aircraft must be accomplished.

a. Precautions.

NOTE

Servicing personnel shall comply with all safety precautions and procedures in FM 10-68 FM 10-68.

NOTE

If the nozzles do not reduce the fuel pressure to less than 25.5 PSIG, the receiver is designed to shut off fuel flow.

(1) Ground the helicopter at the receptacle located adjacent to the filler cap on the helicopter to the filler-nozzle before removing filler cap.

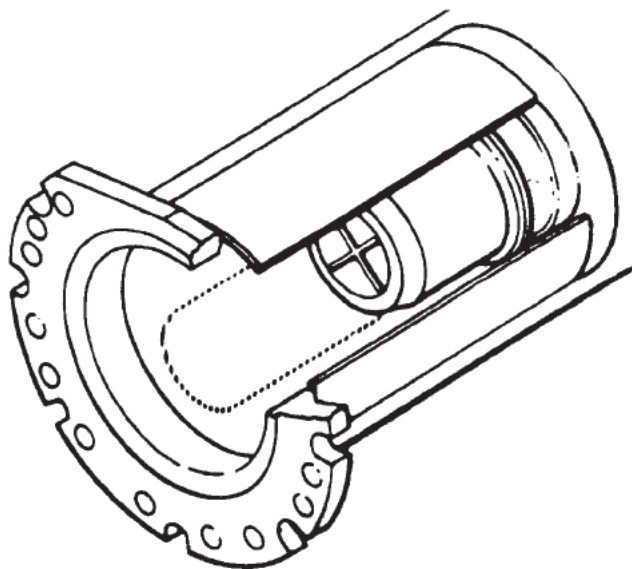

**SLEEVE POSITION WHEN USING CLOSED
CIRCUIT REFUELING SYSTEM**

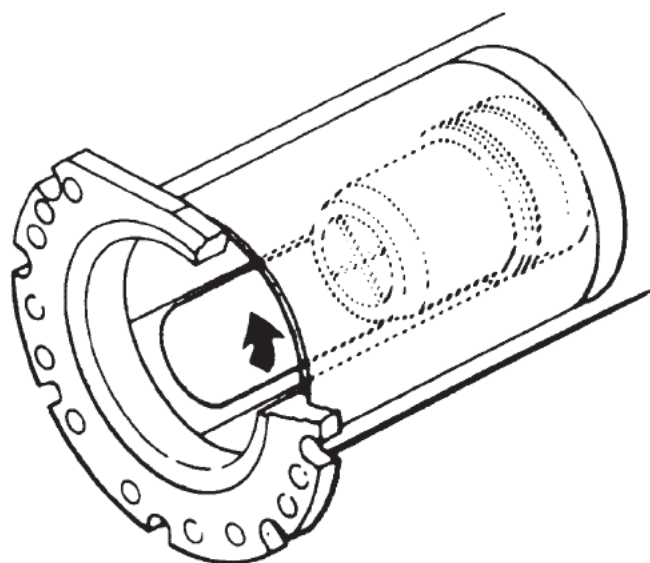

**SLEEVE POSITION WHEN USING GRAVITY
REFUELING SYSTEM**



MS019061

Figure 2-23. Refueling Receptacle

(2) Servicing unit shall be grounded (servicing unit to ground and servicing unit to helicopter). The helicopter should be grounded to the same ground point as is the servicing unit.

(3) After completion of servicing, remove nozzle, reinstall cap, and disconnect all grounds from helicopter.

b. Servicing.

(1) Fill tank cells with specified fuel. Refer to table 2-1.

(2) Refer to table 2-1 for fuel tank capacity.

c. Before Rapid (Hot) Refueling:

WARNING

Only emergency radio transmission should be made during rapid refueling. In case of aircraft fire, observe fire emergency procedures in Chapter 9. Do not attempt to fly the aircraft.

(1) Minimum crew will remain at the controls.

(2) Throttle — Idle.

(3) Force Trim — ON or controls frictioned.

(4) Passengers shall depart the aircraft and remain clear of the helicopter.

(5) No smoking allowed during refueling operations.

(6) A crew member, if available, should observe the refueling operation (performed by authorized refueling personnel) and stand fire guard as required.

d. During Rapid (Hot) Refueling.

(1) Closed Circuit Refueling.

(a) Ground the helicopter at the receptacle located adjacent to the filler cap on the helicopter to the filler-nozzle and remove filler cap.

(b) Ensure that gravity refueling port is closed. If not, rotate inner sleeve counterclockwise until

gravity refueling port is closed and flange of sleeve is in contact with rivet at base of receiver cylinder. Refer to figure 2-23.

CAUTION

Ensure that servicing unit pressure is not above 125 PSI while refueling.

(c) Insert fueling nozzle into receiver and actuate automatic nozzle lever to ON or FLOW position. Pin at base of nozzle will momentarily indicate when fuel flow stops.

(d) Fuel flow will automatically shut off when normal fuel level is reached. Just prior to normal shut off, fuel flow may cycle several times as fuel level is reached. Gage on servicing unit will indicate when flow is stopped.

(e) When fuel flow has stopped, actuate lever on nozzle to OFF, disconnect nozzle from receiver and replace filler cap.

(f) Disconnect fuel nozzle ground and rewind hose assembly.

(g) Disconnect servicing unit ground at helicopter.

(h) Disconnect servicing unit ground at grounding stake.

CAUTION

If helicopter is equipped with closed circuit refueling system and fuel servicing unit is not equipped with related nozzle for closed circuit refueling, a gravity system may be used providing the servicing nozzle does not exceed 1.75 inches outside diameter. To refuel utilizing the gravity nozzle, it is necessary to position the inner sleeve of receiver until slot is lined up with fuel port in bottom of receiver. Position nozzle into port in order by bypass closed circuit valve. Damage could result to the closed circuit refueling system if caution is not used to prevent damage to inner sleeve of receiver at fuel port through improper use of nozzle.

(2) Gravity Refueling.

(a) Ground helicopter at receptacle located adjacent to filler cap on helicopter to filler-nozzle and remove filler cap.

(b) Rotate inner sleeve clockwise until sleeve clears port in bottom of fuel receiver. Refer to figure 2-23.

(c) Position nozzle into port of fuel receiver.

(d) Fill to specified level.

(e) Remove nozzle and rotate inner sleeve counterclockwise until gravity refueling port is closed and flange of inner sleeve is in contact with rivet at base of receiver cylinder.

(f) Reinstall filler cap.

(g) Disconnect fuel nozzle ground and rewind hose.

(h) Disconnect fuel nozzle ground and rewind hose.

(i) Disconnect servicing unit ground at grounding stake.

e. After Rapid Refueling.

(1) The pilot shall be advised by the refueling crew that fuel cap(s) are secure and ground cable have been removed.

(2) Crew members and passengers can enter aircraft.

f. Defueling and Draining.

(1) Remove fuel cap; rotate inner sleeve clockwise until end of sleeve clears port in bottom of fuel receiver.

(2) Insert a suction pickup from a defueler vehicle into fuel filler opening and remove all possible fuel.

(3) To complete defueling, drain remaining fuel into a suitable container by opening fuel cell sump drain.

2-79. ENGINE OIL SYSTEM SERVICING.**CAUTION**

An engine high oil level coupled with a transmission low oil level condition indicates a possible failure of engine gearbox seal(s) which is allowing oil to transfer from the transmission through the freewheeling unit.

Engine oil tank is located aft of engine and oil cooler fan. Oil level is checked by a "trapped ball" sight gage on tank (figure 2-20 and figure 2-21). Ball must be seen floating in oil for safe oil level. Refer to table 2-1 for authorized oil.

2-80. TRANSMISSION AND GEARBOX OIL SYSTEM SERVICING.

a. Transmission. A sight glass located on transmission housing (figure 2-20 and figure 2-21) is used to check oil level in transmission. Oil level must be visible in sight glass. If oil is visible, additional oil is not required. If oil is not visible in sight glass, add oil to center dot only. Refer to table 2-1 for authorized oil.

b. Gearbox. A sight glass is provided for ease in checking oil level. Refer to table 2-1 for authorized oil. Fill to the line for standard gear. Fill to 1/8-inch below line when high gear or floats are installed.

2-81. HYDRAULIC SYSTEM SERVICING.

The hydraulic reservoir (figure 2-20 and figure 2-21) is located on forward side of transmission. A sight glass with ball float or line level is provided to determine low quantity of fluid in reservoir. Fill to overflow lip in reservoir. Refer to table 2-1 for authorized fluid.

2-82. BLADE GRIPS AND PILLOW BLOCKS SERVICING.

Grease Lubricated Hub. Blade grips and pillow blocks on main rotor hub are lubricated with grease through lubrication fittings. The grips have a relief valve located on each pitch horn.

2-83. GROUND HANDLING.

Towing. Tow rings are provided on forward inboard portion of each landing gear skid (figure 2-24) for attachment of a standard aircraft tow bar. Helicopter is towed on ground handling wheel assemblies mounted on the landing skids.

2-84. PARKING.

- a. Retract ground handling wheels and allow helicopter to rest on skid type landing gear.
- b. Install main rotor blade tie-down (figure 2-24).
- c. Install engine air inlet shield assemblies in engine inlets and covers on engine exhausts.

2-85. COVERS.

a. Engine Inlet and Pitot Tube. An engine inlet and pitot cover (figure 2-24) is provided to prevent entrance of dust etc., into engine inlet and pitot system when helicopter is parked. When stowed in helicopter, stow engine inlet shields and pitot covers securely in helicopter cabin only.

b. Engine Exhaust. Individual covers (figure 2-24) are provided for exhaust stacks to prevent entrance of foreign objects into engine exhaust when helicopter is parked. When stowed in helicopter, stow engine exhaust covers securely in helicopter cabin only.

c. Main Rotor Tie-Down.

NOTE

Ensure strap side of main rotor tie-down boot is on top side of blade and drain hole is positioned at bottom of blade.

A rotor tie-down (figure 2-24) is provided for use in mooring the aft main rotor blade. The tie-down prevents the rotor from see-sawing when the helicopter is parked. When stowed in helicopter, stow rotor tie-down securely in helicopter cabin only.

2-86. MOORING.



Structural damage can occur from flying objects during high wind conditions. Helicopter should be hangared or evacuated to a safe weather area when wind conditions above 50 knots are expected.



The mooring hardware is to be carried in the fly-away kit. Flying the OH-58 with mooring hardware installed may result in damage to aircraft's honeycomb surface. Retain all installation hardware together for each separate OH-58A/C helicopters; due to wear, the bushings may not be interchangeable. For additional information, refer to TM 1-1500-250-23-1.

a. If a paved ramp with suitable tie-down rings is available, position the aircraft on the mooring pad with the longitudinal centerline of the aircraft directly above and parallel to longitudinal axis of pad as shown in figure 2-25. The forward mooring rings are to be located 5 feet 4 inches aft of first mooring point as shown.

NOTE

It will be necessary to attach a mooring clevis to each of the three jack/mooring points. The clevis provided with the aircraft will not be large enough to accept the hooks on the mooring chains provided with mooring pad. Mooring rings are to be installed on aircraft as shown in figure 2-25.

b. Place the hook-ends of mooring chains into the appropriate clevis rings. Adjust the chains using the adjusting devices provided on the mooring pad. Chains should be adjusted to a point where the slack has been removed.

c. If suitable spaced ramp tie-downs are not available, park the helicopter on an unpaved parking area headed in the direction from which the highest forecast winds are expected and retract ground handling wheels. Use mooring anchors to make "dead man" anchors. Moor helicopter as described in step a.

2-86.1. ROTOR BLADE TIE-DOWN.

Secure the tie-down ropes carefully. Do not damage the skin by flipping the strap weights around the tailboom.

NOTE

Ensure that strap side of main rotor tie-down boot is on top side of blade and drain hole is positioned at bottom of blade.

a. To tie-down the aft blade, securely tie the straps of the boot to the 1/2 inch polyester rope near the boot. Ensure the ropes are long enough to cross and tie in position.

b. The forward blade shall also be tied down using the same boot strap/rope arrangement device. The ropes shall be routed between the base and side support struts of the forward lower cutter and tied at the rear of the base. In the final tie-position the blades must be in a level position.

c. Install covers on pitot tube, engine exhaust, and engine inlets.

d. An alternate method of installing pitot and engine inlet covers will aid in preventing marring and scratching of windshields and is accomplished as follows:

(1) Route strap from pitot tube through lower front edge of pilot door near lower hinge, and then out the top edge of pilot door to engine air inlets.

(2) Cut strap connecting pitot cover to engine shields strap at both ends. Pitot tube cover may be held in place with the nylon cord and/or a scrapped packing of proper diameter. If a packing is used, it may be permanently attached to pitot tube cover to prevent its loss when the cover is removed. The strap connecting the engine shields should also be shortened.

e. Position collective control full down, and tighten friction.

f. Center cyclic control and tighten friction.

g. Close all windows, doors, and access panels.

h. Fill fuel tank to capacity with prescribed fuel.

i. Secure all ground handling equipment.

2-87. MOORING — FLOAT EQUIPPED HELICOPTER.

Float equipped helicopters may be moored using same procedures as are used for skid gear equipped helicopters. Surface of mooring area must be smooth and free of any objects which may damage or penetrate floats.

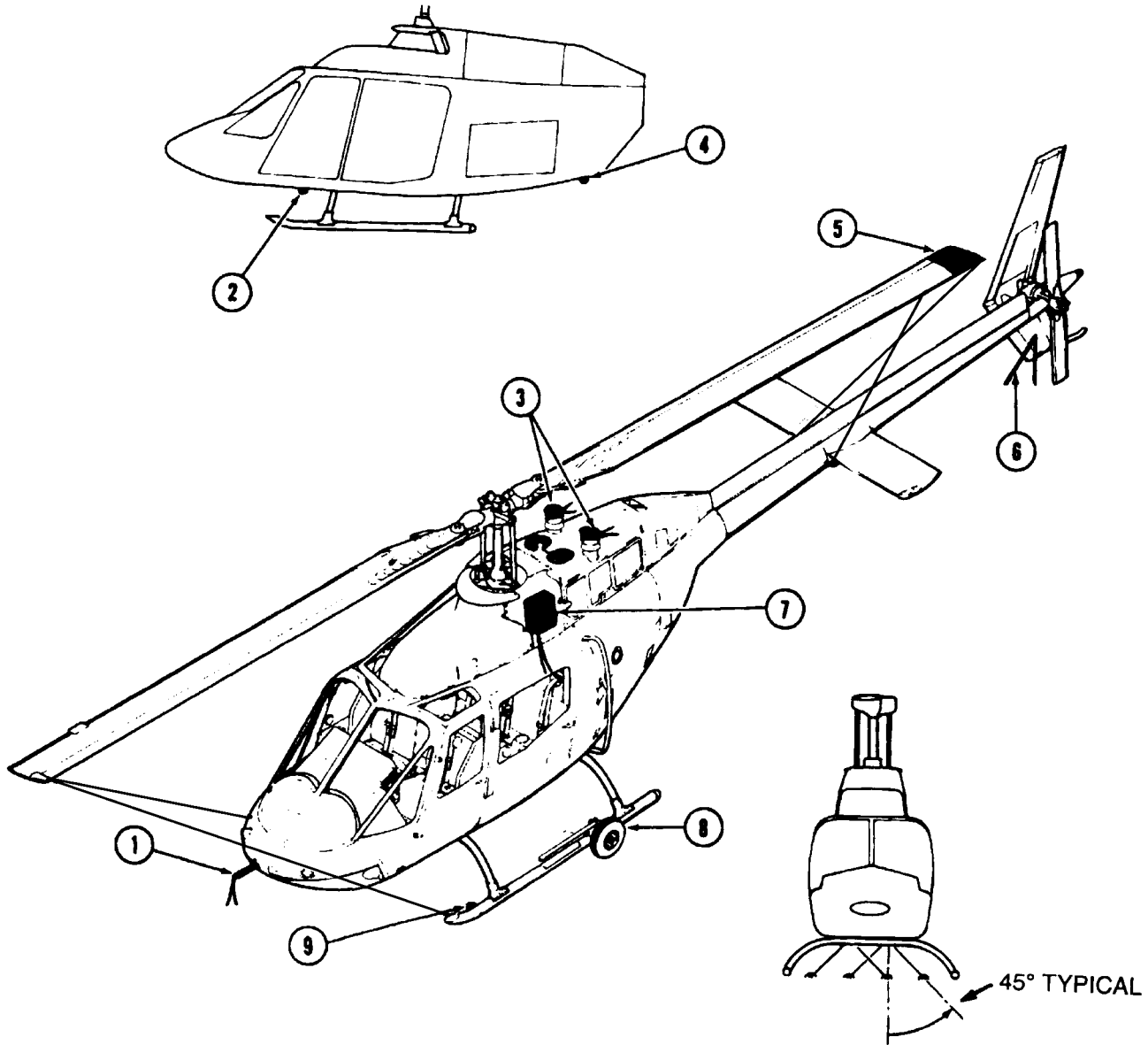

MS019062

- | | |
|--|----------------------------|
| 1. Pitot Tube Cover | 6. Tail Rotor Tiedown |
| 2. Forward Jacking and Tiedown Fitting | 7. Engine Air Inlet Shield |
| 3. Exhaust Covers | 8. Ground Handling Gear |
| 4. Aft Jacking and Tiedown Fitting | 9. Towing Ring |
| 5. Main Rotor Blade Tiedown | |

Figure 2-24. Ground Handling Equipment, Covers, Rotor Tiedowns, and Mooring Diagram

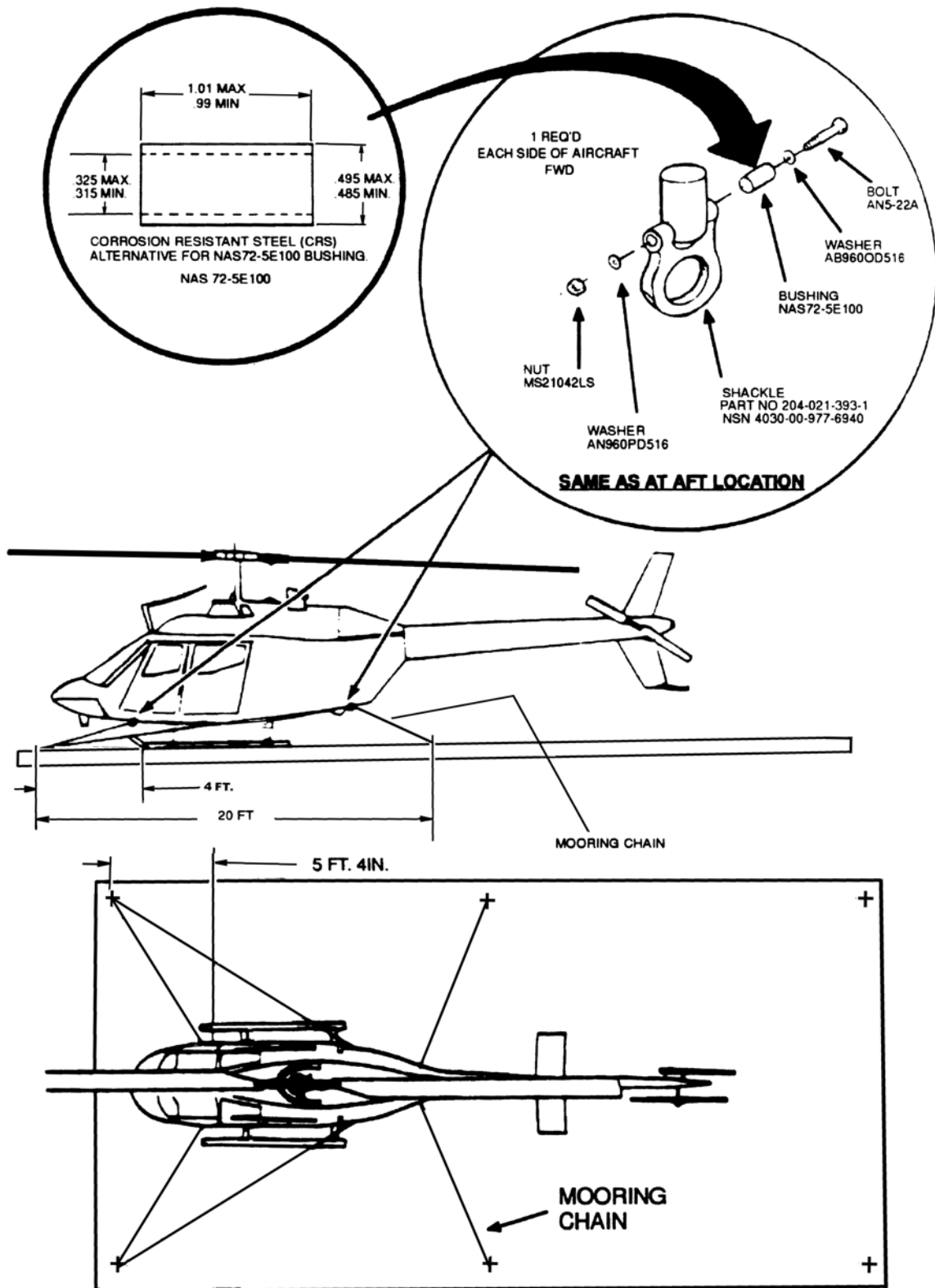

MS019063

Figure 2-25. Paved Surface Mooring Configuration (OH-58A/C)

CHAPTER 3 AVIONICS

3-1. GENERAL. This chapter contains all information relevant to the avionics equipment installed in the Army Model OH-58A/C helicopter. Included information consists of description, technical characteristics, capability, location of each major component and operation instructions for the system.

3-2. DELETED.

3-3. NOMENCLATURE AND COMMON NAMES. Avionics equipment installed in the he-

licopter, with common names, use, and operational range, is presented in Table 3-1. Antenna locations are shown in figure 3-1.

3-4. DELETED.

3-5. POWER SUPPLY.

Refer to figure 2-18.

Table 3-1. Communications and Associated Electronics Equipment

NOMENCLATURE	COMMON NAME	USE	RANGE
Communication System Control C-6533/ARC	Communication Control	Interphone for pilot and crew, Integrates all communication equipment	Stations within helicopter.
Radio Set AN/ARC114FM	FM Radio Set	Two-way Voice Communications in frequency range of 30.00 to 75.95 MHz	Line of sight
Radio Set AN/ARC114A VHF-FM	FM Radio	Two-way Voice Communications in frequency range of 30.00 to 75.95 MHz	Line of sight
Radio Set AN/ARC115VHF-AM	VHF Radio Set	Two-way Voice Communications in frequency range of 116.00 to 149.975 MHz	Line of sight
Radio Set AN/ARC116UHF-AM (or AN/ARC-164)	UHF Radio Set	Two-way Voice Communications in the frequency range of 225.00 to 399.95 MHz	Line of sight
Directional Finder/Set AN/ARN-89	ADF	Radio Range Navigation and position fixing Automatic direction finding and homing in the frequency range of 100 to 3.000 KHz	150 to 200 miles average depending on terrain interference noise.

Table 3-1. Communications and Associated Electronics Equipment — Continued

NOMENCLATURE	COMMON NAME	USE	RANGE
Communication Security Set TSEC/KY-58	Secure-Voice encoder-decoder	In conjunction with FM radio set to provide secure two-way voice communication	
Gyromagnetic Compass Set AN/ASN-43	Gryomagnetic Compass	Navigational Aid provides accurate heading information	
Transponder Set AN/APX-72	Transponder Set	Transmit a special coded reply to ground based IFF radar interrogator system	
Radio Set AN/ARN-123(V)1	Conus Navigation Receiver	With appropriate instrumentation provides: VHF omni-directional range (VOR), localizer (LOC), glideslope (GS), and marker beacon (MB) position information	Line of sight
Radar Altimeter AN/APN-209	Radar Altimeter	Provides altitude indication above terrain. Permits selected altitude limits and visual warning when altitude is above or below selected limits	0 to 1500 feet above terrain.
Transponder Set AN/APX-100	IFF Transponder Radio	Transmits a special coded reply for radar interrogator systems	Line of sight

Table 3-1. Communications and Associated Electronics Equipment — Continued

NOMENCLATURE	COMMON NAME	USE	RANGE
Indicator, Heading- Radio Bearing ID-1351C/A	RHBI	Provides magnetic heading, VOR or ADF bearing, and homing information.	
Indicator, Course Deviation ID-1347C/ARN	CDI	Provides VOR course deviation, localizer and glideslope signal information.	
Command Radio Set Control C-6287	Control/Indicator C-6287		
Secure-Voice Control Indicator	Control/Indicator C-8157/ARC		
Computer Kit 1A/TSEC	IFF Computer		
Radar Warning AN/APR-39	Radar Warning Set	Visual and Audible Warning when a high radar threat environment is encountered.	Line of sight
SINCGARS Radio Set AN/ARC-201	FM Radio Set	Two-way Voice Communications in frequency range of 30 to 87.975 MHz	Line of sight
IFM Amplif er AN-7189/A	FM RF Amplif er	Improves FM communication during NOE flight envelopes.	Line of sight

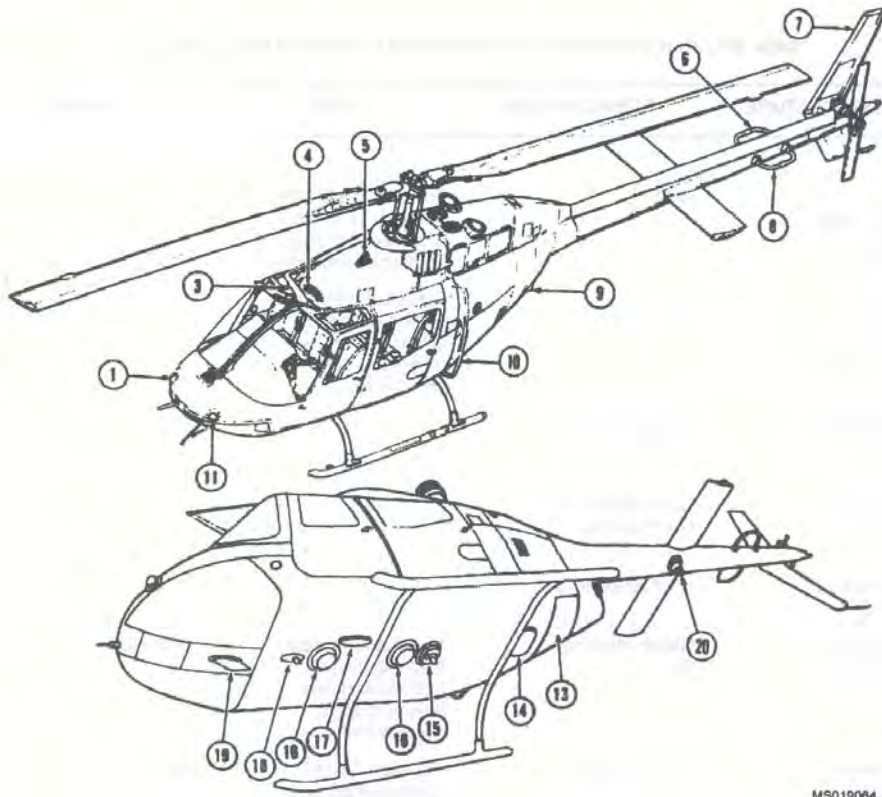

MS019054

- | | |
|--|--|
| 1. Antenna, Radar Warning – Fwd Right Side | 11. Antenna, Radar Warning – Fwd Left Side |
| 2. Deleted | 12. Deleted |
| 3. Antenna, FM | 13. Antenna, ADF Sense |
| 4. Antenna, Glideslope | 14. Antenna, ADF Loop |
| 5. Antenna, Top Transponder | 15. Antenna, Radar Warning – Blade |
| 6. Antenna, VOR – Right Side | 16. Antenna, Radar Altimeter |
| 7. Antenna, VHF/FM | 17. Antenna, Radar Altimeter C |
| 8. Antenna, VOR – Left Side | 18. Antenna, Bottom Transponder A |
| 9. Antenna, Radar Warning – Aft Side Shown,
Aft Right Side Opposite | 19. Antenna, UHF |
| 10. Antenna, FM Homing – Left Side Shown
Right Side Opposite | 20. Antenna, Bottom Transponder |

Figure 3-1. Antenna Locations

SECTION I COMMUNICATIONS

3-6. COMMUNICATIONS SYSTEM CONTROL, C-6533/ARC.

3-7. DESCRIPTION — COMMUNICATIONS SYSTEM CONTROL.

The communication system control, C-6533/ARC (figure 3-2) provides an intercommunications capability and control of radio communications. Two of the control panels are installed on the instrument panel, one each for the pilot and another crew member. Another control panel is installed on the right side overhead in the passenger compartment. The control panels may be used in any one of three different modes as determined by the setting of switches and controls on the panel.

3-8. CONTROLS AND FUNCTIONS — COMMUNICATION SYSTEM CONTROL.

Refer to figure 3-2.

3-9. OPERATING PROCEDURES — COMMUNICATIONS SYSTEM CONTROL.

a. Modes of Operation. The three modes of operation are two-way radio communication, radio receiver monitoring, and intercommunications within the helicopter.

b. Operation.

- (1) Receiver switches — As desired.
- (2) VOLUME control — Adjust.
- (3) HOT MIKE switch — As desired.
- (4) Transmit-Interphone Selector — As required.

3-10. VHF/FM RADIO SET.

3-11. DESCRIPTION — VHF/FM RADIO SET.

The AN/ARC-114 and AN/ARC-114A radio sets provide two way frequency modulated (FM) narrow band voice communications and homing capability (Number one unit only) within frequency range of 30.00 to 75.95 MHz on 920 channels for a 50-mile distance as limited by line of sight. A guard receiver incorporated in the set is fixed tuned to 40.50 MHz. Retransmission of voice, CW or X-mode communications is possible when a second set is installed in the helicopter. The radio sets are marked VHF/FM COMM and are installed in the center console. Antenna location is located as shown in figure 3-1.

3-12. CONTROLS AND FUNCTIONS — FM RADIO SET.

Refer to figure 3-3.

NOTE

When transmitting and/or receiving on VHF (FM) in secure mode, do not key or transmit simultaneously on any other transmitter.

3-13. OPERATING PROCEDURES — FM RADIO SET.

a. Transmit/Receive

- (1) Function selector — As desired.
- (2) Frequency — Select.
- (3) RCVR TEST — Press to test.
- (4) AUDIO — Adjust.
- (5) Transmit.
 - (a) Transmit-Interphone selector — Number 1 position (Number 5 position for second FM set).
 - (b) RADIO transmit switch — Press.

b. Homing.

NOTE

FM homing capability is not provided for ATAS equipped helicopters.

- (1) Function selector — HOMING.
- (2) AUDIO — Adjust.
- (3) Observe homing indications on the radio bearing heading indicator.

c. Retransmission.

NOTE

Crew transmission may also be made while in RETRAN mode.

- (1) Frequencies — Select (Both FM sets).

NOTE

Frequencies must have a minimum of five MHz difference, such as 30.00 MHz and 35.00 MHz.

- (2) Communications — Establish with each facility by selecting number 1 position and then number 5 position on the Transmit-Interphone selector.

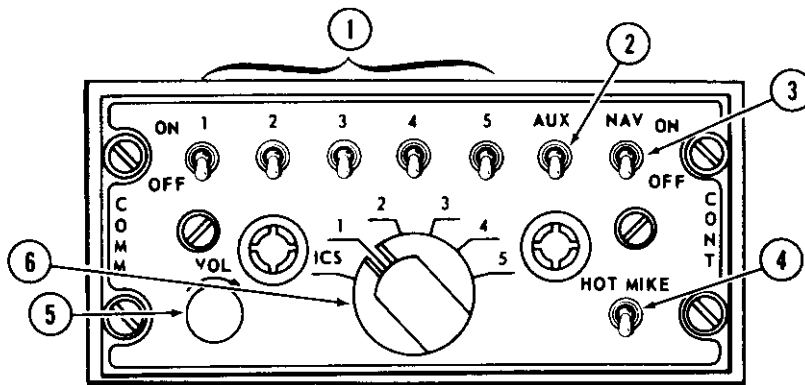

MS026084

CONTROL/INDICATOR	FUNCTION
1. Receiver Switches	Connect (ON) or disconnect (OFF) communications receivers from the headsets.
1-FM	
2-UHF	
3-VHF	
4-Not used	
5-FM (When second FM set is installed)	
2. AUX Receiver Switch	Not Used A . Connects (ON), or disconnects (OFF), VOR set receiver ARN-123(V)1 from the headset B .
3. NAV Receiver Switch	Connects (ON) or disconnects (OFF) navigation receiver ARN-89 from the headset.
4. HOT MIKE Switch	Permits hand-free intercommunications regardless of the position of the transmit-interphone selector. Permits hand-free intercommunications with transmit-interphone selector in the ICS position C .
5. VOL Control	Adjust volume from receivers. Adjust intercommunications volume.
6. Transmit-Interphone Selector	Selects transmitter to be keyed and connects microphone to transmitter.
1-FM	
2-UHF	
3-VHF	
4-Not used	
5-FM (When second FM set is installed)	
ICS	Connects the microphone to the intercommunications system only, disconnecting microphone from transmitters.

Figure 3-2. Communication System Control Panel C-6533/ARC

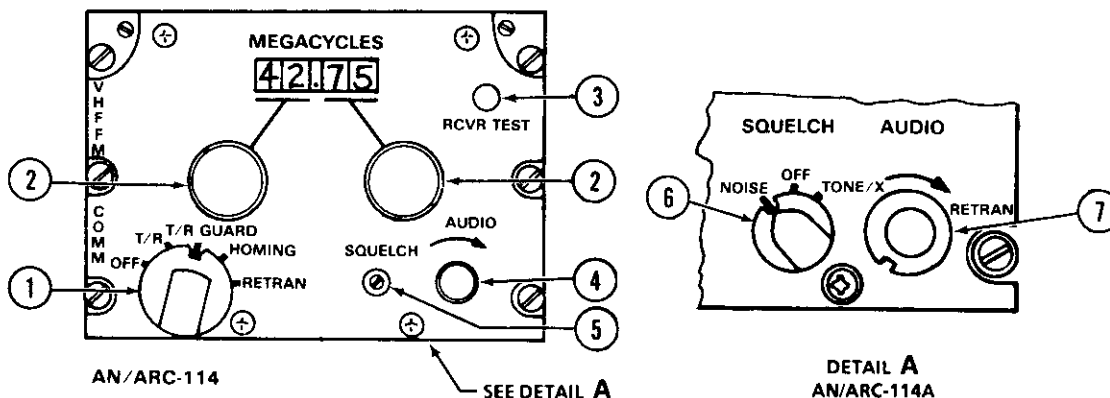

MS026085

CONTROL/INDICATOR	FUNCTION
1. Function Selector	
OFF	Power off.
T/R	Receiver — On; Transmitter — Standby.
T/R GUARD	Receiver — On; Transmitter — Standby; Guard Receiver — On.
HOMING	NOTE: Reception on guard frequency is unaffected by frequencies selected for normal communications.
HOMING	Activates the homing mode and display on the radio bearing heading indicator. May be used also for normal voice communications.
RETRAN	Activates the retransmission mode when second FM set is installed in the aircraft. May be used also for normal voice communications.
2. Frequency Selectors	
Left Selector	Selects first two digits of desired frequency.
Right Selector	Selects third and fourth digits of desired frequency.
3. RCVR TEST	When pressed, audible signal indicates proper receiver performance.
4. AUDIO	Adjusts receiver volume.
5. SQUELCH	Squelch control adjusted by maintenance personnel only.
6. SQUELCH	
OFF	Disables squelch.
NOISE	Activates noise squelch.
TONE/X	Activates tone squelch for secure voice mode.
7. AUDIO	Adjusts receiver volume. Control is set to white RETRAN segment for proper audio output during retransmission operations.

Figure 3-3. AN/ARC-114 and AN/ARC-114A Control Panel

(3) Function selectors — RETRAN (Both FM sets).

(4) Receiver switches — Number 1 and number 5 positions as desired for monitoring.

d. **Stopping Procedures.** Function Selector — OFF.

3-14. VHF/AM RADIO SET — AN/ARC-115.

3-15. DESCRIPTION — VHF/AM RADIO SET (AN/ARC-115). The ARC-115 (figure 3-4) provides two-way VHF amplitude modulated (AM) narrow band voice communications within the frequency range 116.00 to 149.975 MHz on 1360 channels for a distance range of approximately 50 miles line of sight. A guard receiver is incorporated in the set and is fixed tuned to 121.50 MHz. The radio set is marked VHF AM COMM and is mounted on the left side of the instrument panel. Antenna installation is shown in figure 3-1.

3-16. CONTROLS AND FUNCTIONS — VHF/AM RADIO SET (AN/ARC-115). Refer to figure 3-4.

3-17. OPERATING PROCEDURES — VHF/AM RADIO SET (AN/ARC-115).

a. **Transmit/Receive.**

- (1) Function selector — As desired.
- (2) Frequency — Select.
- (3) RCVR TEST — Press to test.
- (4) AUDIO — Adjust.
- (5) Transmit.

(a) Transmit-interphone selector — Number 1 or Number 5 position, as desired.

(b) RADIO transmit switch — PRESS.

b. **Stopping Procedure.** Function Selector — OFF.

3-18. UHF/AM RADIO SET (AN/ARC-116 OR AN/ARC-164).

3-19. DESCRIPTION —(AN/ARC-116 OR AN/ARC-164). The UHF-AM radio set AN/ARC-116 (of AN/ARC-164) (figures 3-5 and 3-6) provides two-way UHF amplitude modulated (AM) narrow band voice communications within the frequency range of 225.00 to 399.95 MHz on 3500 channels for a distance of approximately

50 miles as limited by conditions. A guard receiver is incorporated in the set and is fixed tuned to 243.00 MHz. Both receivers are disabled during transmitter operation. The radio set is marked UHF AM COMM and is mounted in the bottom center section of the instrument panel. The UHF radio transmitter and main receiver operate on the same frequency and are simultaneously tuned by frequency selector knobs on the panel. The set utilizes position number 2 of the C-6533/ARC intercommunications control panel. The AN/ARC-164 provides for twenty preset channels in addition to the manual selection of channels. Preset selection is accomplished by positioning the mode switch to PRESET and function selector to MAIN. Select the desired frequency with the frequency selector knobs and press the PRESET push-button located under the access cover upper left portion of radio.

3-20. CONTROLS AND FUNCTIONS — UHF/AM RADIO SET (AN/ARC-116 OR AN/ARC-164). Refer to figures 3-5 and 3-6.

3-21. OPERATING PROCEDURE — UHF/AM RADIO SET (AN/ARC-116).

NOTE

Determined by radio set serial number the following channels of the AN/ARC-116 Radio Set are degraded and unusable as communication frequencies.

1. 230.20 MHz	11. 320.05
2. 235.15	12. 335.15
3. 243.40	13. 336.80
4. 250.00	14. 350.00
5. 274.65	15. 360.00
6. 286.80	16. 366.20
7. 290.00	17. 370.05
8. 290.30	18. 385.15
9. 300.00	19. 386.80
10. 320.00	20. 390.00

For AN/ARC-116 Radio Set (Serial Number 137 and subsequent):

- 1. 274.65 MHz
- 2. 300.00
- 3. 366.20

a. Transmit/Receive.

- (1) Function selector – As desired.
- (2) Frequency– Select.
- (3) RCVR TEST– Press to test.
- (4) Audio – Adjust.
- (5) Transmit.

(a) Transmit – Interphone selector – Number 2 position.

(b) RADIO transmit switch– PRESS.

b. Stopping Procedures. Function Selector - OFF.

3-22. OPERATING PROCEDURES – UHF/AM RADIO SET (AN/ARC-164).

a. Transmit/receive.

- (1) Function selector — As desired.
- (2) Frequency – Select.
- (3) TONE – Press to test.
- (4) VOL – Adjust.
- (5) Transmit.

(a) Transmit – Interphone selector – Number 2 position.

(b) RADIO transmit switch – PRESS.

b. Stopping Procedure. Function Selector – OFF.

3-23. UHF/AM RADIO SET (RT-1167/ARC-164(V) OR RT-1167C/ARC-164(V)).

3-24. DESCRIPTION – UHF/AM RADIO SET (RT-1167/ARC-164(V) OR RT-1167C/ARC-164(V)).

a. RT-1167/ARC-164(V). The Receiver-Transmitter Radio RT-1167/ARC-164(V) (figure 3-6) is an airborne, ultra-high frequency (UHF), amplitude-modulated (AM), radio transmitting-receiving (transceiver) set. It contains a multichannel, electronically-tunable transceiver and a fixed-tuned guard receiver. The transceiver operates on any one of 7,000 channels spaced in 0.025 MHz units in the 225.000 to 399.750 MHz UHF military band. The guard receiver is tunable in the 238.000 to 248.00 MHz frequency range with crystal replacement and realignment (usually 243.000 MHz). The radio set primarily is used for voice communication. An additional radio set capability, although not functional is ADF. Power to operate the ARC-164(V) radio is from the 28 vdc emergency bus through a circuit breaker marked UHF-AM on the pilot overhead circuit breaker panel. UHF/AM Antenna location is shown in figure 3-1.

b. RT-1167/ARC-164(V). The Receiver-Transmitter Radio RT-1167/ARC-164(V) (figure 3-6)

has the same functions and capabilities as the RT-1167/ARC-164(V), plus a HAVE QUICK mode of operation. HAVE QUICK is an antijamming mode which uses a frequency hopping scheme to change channels many times per second. Because the HAVE QUICK mode depends on a precise time of day, both HAVE QUICK radios must have synchronized clocks. UHF/AM Antenna location is shown in figure 3-1.

3-25. CONTROLS AND FUNCTIONS – UHF/AM RADIO SET (RT-1167/ARC-164(V) OR RT-1167C/ARC-164(V)).

a. RT-1167/ARC-164(V). Controls for the RT-1167/ARC-164(V) are on the front panel of the unit (figure 3-6). The function of each control is as follows:

CONTROL	FUNCTION
Frequency selector switch 1	Selects 100's digit of frequency (either 2 or 3) in MHz
Frequency selector switch 2	Selects 10's digit of frequency (0 through 9) in MHz
Frequency selector switch 3	Selects units digit of frequency (0 through 9) in MHz
Frequency selector switch 4	Selects tenths digit of frequency (0 through 9) in MHz
Frequency selector switch 5	Selects hundredths digit of frequency (00, 25, 50, 75) in MHz
Preset channel selector switch	Selects one of 20 preset channels
MANUAL-PRESET-GUARD selector	Selects method of frequency selection
MANUAL	Any of 7,000 frequencies is manually selected using the five frequency selector switches
PRESET	A frequency is selected using the preset channel selector switch for selecting any one of 20 preset channels as indicated on the CHAN indicator
GUARD	The main receive and transmitter are automatically tuned to the guard frequency. Blocks out any frequency set either manually or preset
SQUELCH ON-OFF switch	Turns squelch of main receive on or off

— Continued

VOL control	Adjusts volume
TONE switch	Enables transmission and headset monitoring of a 1,020-Hz tone on selected frequency for maintenance check only
Mode selector switch	Selects operating mode:
OFF	Turns power off
MAIN	Enables the transceiver
BOTH	Enables transceiver and guard receiver
ADF	Not operational

b. RT-1167C/ARC-164(V). The controls and functions of the RT-1167C/ARC-164(V) are identical to the RT-1167/ARC-164(V) with the exception of the following:

CONTROL	FUNCTION
Frequency selector switch 1 (T-2- 3-A)	Selects 100's digit of frequency (either 2 or 3) in MHz. The A position selects the HAVE QUICK mode. The T position (spring-loaded) allows the radio to receive a new time of day

3-26. OPERATING PROCEDURE— UHF/AM RADIO SET (RT-1167/ARC-164(V) OR RT-1167C/ARC-164(V)).

a. Modes of Operation. Depending on the settings of the operating controls, the radio set can be used for these modes of operation:

(1) Control (Mode) Settings.

(a) MAN mode: two-way voice communications

(b) BOTH Mode: utilizing the transceiver constant monitoring of guard receiver without losing the use of the transceiver.

(c) Transmission of 1,020 Hz TONE signal

(2) Transmit/Receive (MAIN) mode.

(a) Set OFF-MAIN-BOTH-ADF selector switch to MAIN.

(b) Set MANUAL-PRESET-GUARD selector switch to MANUAL for manual frequency selection or to PRESET for preset channel selection.

(c) To manually select a frequency, rotate the five MHz selector switches until desired frequency is displayed in indicator window.

NOTE

Clockwise rotation of the MHz selector switches increases frequency.

(d) To select a preset channel, rotate preset channel selector switch until desired channel is displayed in preset CHAN indicator window.

NOTE

Clockwise rotation of preset channel selector switch will increase the desired channel number (1 to 20).

(3) Transmit/Receive/Guard Monitor (BOTH) mode.

(a) Set OFF-MAIN-BOTH-ADF selector switch to BOTH.

NOTE

The BOTH position turns on the transceiver and the guard receiver. The guard receiver will remain turned to 243 MHz regardless of manual or preset frequencies selected.

(b) Select desired manual frequency or preset channel. Refer to steps 3-26.a.(2)(c) and (d).

NOTE

If reception on the selected frequency interferes with guard reception, detune the set by selecting an open frequency or place MANUAL-PRESET-GUARD selector switch to GUARD.

(4) 1020 Hz TONE Signal Transmission (MAIN) mode.

(a) Set OFF-MAIN-BOTH-ADF selector switch to MAIN.

(b) Select a desired frequency for TONE transmission. Refer to steps 3-26.a.(2)(c) and (d).

(c) Push the TONE switch to transmit the 1020Hz signal.

NOTE

Tone-modulated signal may be used to check out the radio set and isolate faulty microphone circuitry.

(5) HAVE QUICK mode (RT-1167C/ARC-164(V) only).

The HAVE QUICK mode can be activated in one of two ways:

(a) Set MANUAL-PRESET-GUARD switch to MANUAL and set frequency selector switch 1 to A.

(b) Set MANUAL-PRESET-GUARD switch to PRESET and set preset channel selector switch to channel 20.

b. HAVE QUICK System Operation.

(1) A-3-2-T Knob (HAVE QUICK System Only).

- A - Selects AJ mode
- 3 - Allows manual selection of frequencies.
- 2 - Allows manual selection of frequencies
- 1 - Momentary position which enables the radio to accept a new TOD for up to 60 seconds after selection. Also used in conjunction with the emergency startup of the TOD clock when TOD is not available from an external source.

(2) TONE Button (HAVE QUICK). Depressing the TONE button in normal or AJ mode interrupts reception and transmits a tone signal and TOD on the selected frequency. Simultaneously pressing the TONE button in conjunction with the A-3-2-T knob in the T position starts the emergency startup of the TOD clock.

(3) HAVE QUICK System. The HAVE QUICK (HQ) system provides a jam resistant capability through a frequency hopping technique. Frequency hopping is a technique in which the frequency being used for a given channel is automatically changed at some rate common to the transmitter and receiver. The jam resistance of the system is due to the automatic frequency changing and the pseudorandom pattern of frequencies used. In order to defeat this communications system, the jammer must find the frequency being used, jam it and then predict

or find the next frequency. The HAVE QUICK modification adds the frequency hopping capability, yet it does not remove any of the previous capabilities of the radio. The HAVE QUICK modified radios retain the standard, single frequency UHF voice mode of operations. This is referred to as the normal mode, while frequency hopping operation is called the anti-jam (AJ) mode. Several ingredients are necessary for successful system operations. These are:

1. Common frequency
2. Time synchronization
3. Common hopping pattern and rate
4. Common net number

The common frequencies have been programmed into all HAVE QUICK radios. Time synchronization is provided via UHF radio and/or hardware by external time distribution system. A time-of-day (TOD) signal must be received from the time distribution system for each time the radio is turned on. The hopping pattern and hopping rate are determined by the operator inserted word-of-day (WOD). The WOD is a multi-digit code, common worldwide to all HAVE QUICK users. In the AJ mode, a communications channel is defined by a net number instead of a signal frequency as in the normal mode. Before operating in the AJ mode, the radio must be primed. This consists of setting the WOD, TOD, and the net number. The AJ mode is then selected by placing the A-3-2-T knob to A.

(4) WORD OF DAY (WOD). The WOD entry is normally entered before flight, but it is possible to enter it in flight. WOD is entered by using one or more of the six preset channels which are 20-15. For a new WOD entry, start at channel 20 use the same method as in entering preset frequencies in the normal mode with the frequency knobs and the PRESET button. After each entry, a single beep is heard until channel 15 entry; a double beep is heard indicating that the radio has accepted all six WOD entries.

(5) WOD TRANSFER. Select the preset mode and, starting with preset channel 20, rotate the preset knob CCW. At channel 20, a single beep is heard. A single beep indicates that channel 20 data has been transferred and accepted. After the single beep is heard, select remaining channels (19-15) in the same manner until a double beep is heard indicating the WOD transfer is complete.

(6) TIME-OF-DAY (TOD) transmission. The TOD entry is normally entered before flight, but it is possible to enter it in flight. It is possible to transmit timing information in both normal and AJ modes by momentarily pressing the TONE button. In the normal

mode, a complete TOD message is transmitted, while in the AJ mode, only an abbreviated time update is transmitted. A mode time transmission allows a time update if one radio has drifted out of synchronization.

(7) TIME -OF-DAY Reception. Reception is possible in both normal and AJ modes. The radio automatically accepts the first TOD message after the radio is turned on and WOD transferred. Subsequent messages are ignored unless the T position is selected with the A-3-2-T knob. The radio then accepts the next TOD update in either normal or AJ mode, provided the TOD update arrives within 60 seconds of the time the T position has been selected. To receive time in the normal mode, rotate the A-3-2-T knob to the T position and return to a normal channel in either the manual or

preset mode. To receive a time update in AJ mode, rotate the A-3-2-T knob to the T position and then back to the A position. A TOD update (time tick) can be received on the selected AJ net.

(8) Net Numbers. After WOD and TOD are entered, any valid AJ net number can be selected by using the manual frequency knob.

(9) Anti-Jamming Mode Operation. A tone is heard in the headset if an invalid AJ net is selected, if TOD was not initially received, or if WOD was not entered. If the function knob is set to both and the AJ mode is selected, any transmission on the guard channel takes precedence over the AJ mode.

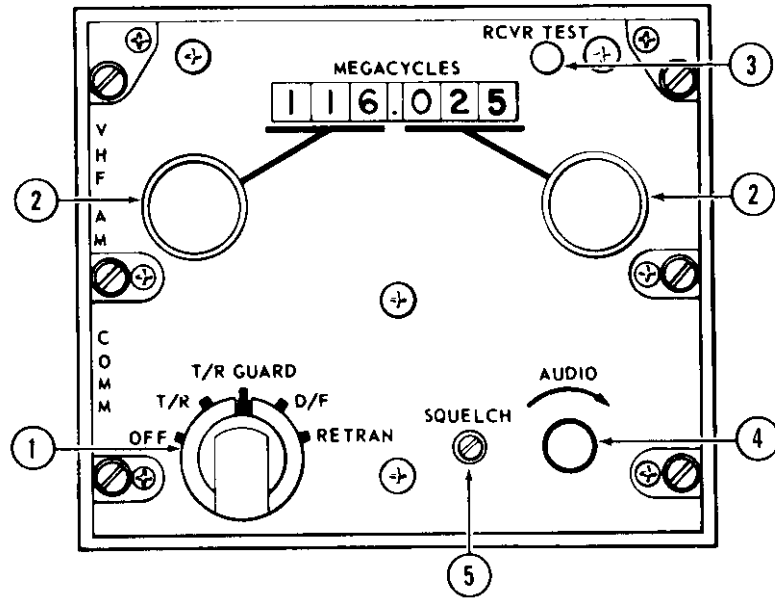

MS026086

CONTROL/INDICATOR	FUNCTION
1. Function Selector	
OFF	Power off.
T/R	Receiver — On; Transmitter — Standby.
T/R GUARD	Receiver — On; Transmitter — Standby; Guard Receiver — On.
	NOTE
	Reception on guard frequency is unaffected by frequencies selected for normal operations.
D/F	Not Used.
RETRAN	Not Used.
2. Frequency Selectors	
Left Selector	Selects first three digits of desired frequency
Right Selector	Selects fourth, fifth and sixth digits of desired frequency.
3. RCVR TEST	When pressed, audible signal indicates proper receiver performance.
4. AUDIO	Adjusts receiver volume.
5. SQUELCH	Squelch control adjusted by maintenance personnel only.

Figure 3-4. AN/ARC-115 Control Panel

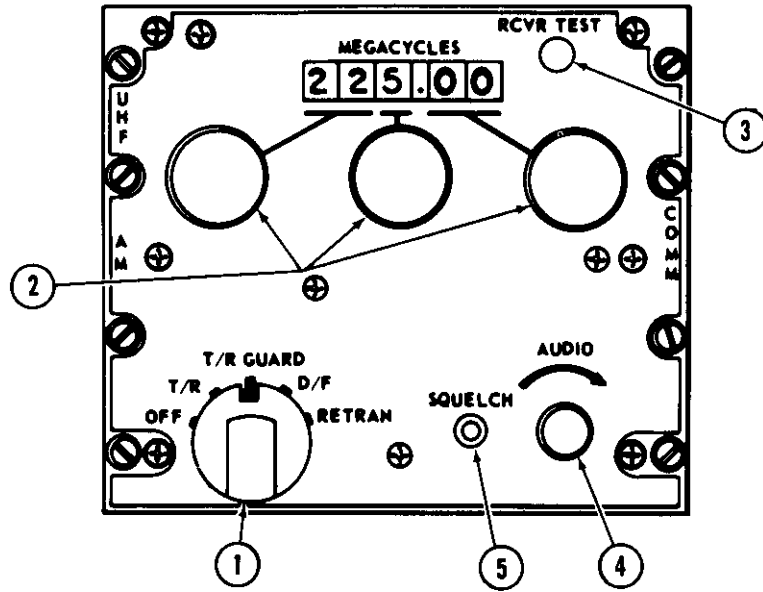

MS026087

CONTROL/INDICATOR	FUNCTION
1. Function Selector	
OFF	Power off.
T/R	Receiver — On; Transmitter — Standby.
T/R GUARD	Receiver — On; Transmitter — Standby; Guard Receiver — On.
	NOTE
	Reception on guard frequency is unaffected by frequencies selected for normal operations.
D/F	Not Used.
RETRAN	Not Used.
2. Frequency Selectors	
Left Selector	Selects first three digits of desired frequency.
Center Selector	Selects third digit (1 MHz steps) of desired frequency.
Right Selector	Selects last two digits of desired frequency.
3. RCVR TEST	When pressed, audible signal indicates proper receiver performance.
4. AUDIO	Adjusts receiver volume.
5. SQUELCH	Squelch control adjusted by maintenance personnel only.

Figure 3-5. AN/ARC-116 Control Panel

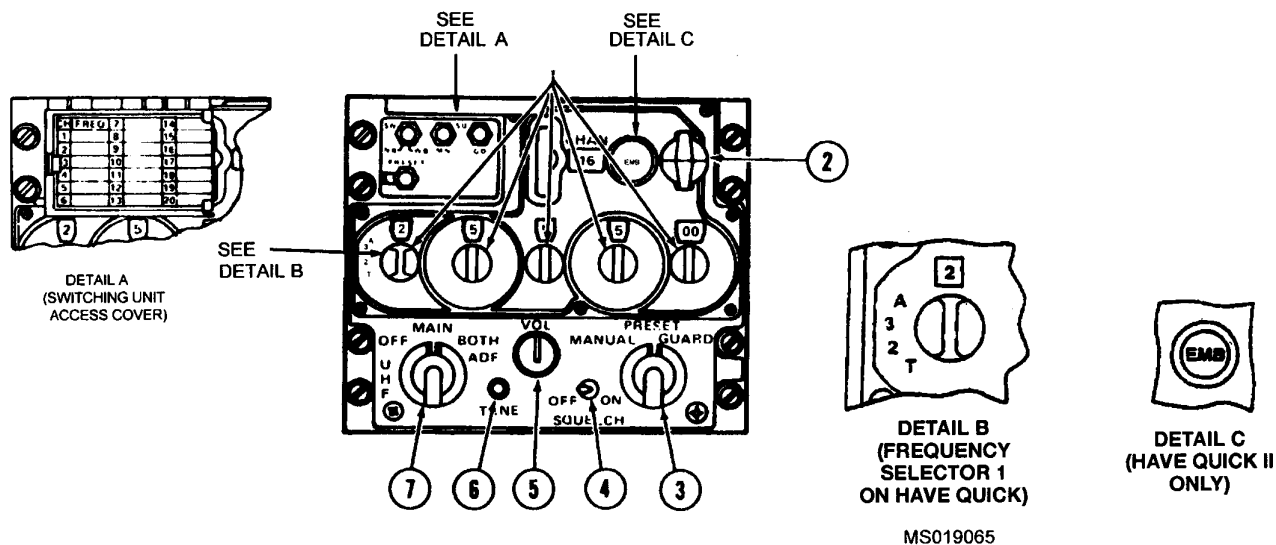

CONTROL/INDICATOR	FUNCTION
1. Frequency Selectors	
Hundreds	Selects first digit of desired frequency.
Tens	Selects second digit of desired frequency.
Units	Selects third digit (1 MHz) of desired frequency.
Tenths	Selects fourth digit of desired frequency
Hundredths	Selects last two digits of desired frequency.
2. CHAN	Selects preset channels.
3. Mode Selector	
MANUAL	Frequency selected with frequency selector knobs.
PRESET	Selects preset channel as desired by CHAN selector.
GUARD	Frequency is automatically positioned to guard channel (243.00 MHz).
4. SQUELCH	Adjusts receiver volume.
OFF	Received unsquelched.
ON	Received squelch operating.
5. VOL Control	Adjust receiver audio volume.
6. TONE	When pressed, audible tone indicates proper receiver/transmitter performance (transmits on selected frequency).
7. Function Selector	
OFF	Power off.
MAIN	Receiver — On; Transmitter — Standby
BOTH	Receiver — On; Transmitter — Standby; Guard Receiver — On.
ADF	Not Used.

Figure 3-6. UHF/AM Radio Sets AN/ARC-164, RT-1167/ARC-1164(V), and RT-1167C/ARC-1164(V)

b. Radio Set ARC-164(V) Operation.

(1) TOD Transfer.

(a) Transfer WOD IAW paragraph 3-26.(5).

(b) Set up RT to receive TOD.

1 With external TOD equipment.

a Select manual mode on MODE switch.

b Set TOD frequency in manual frequency windows.

c Set A-3-2-T to A, after TOD beep is heard. If tone is heard with the A-3-2-T in the A position, reinitialize radio IAW steps in paragraph 3-26.(6).

2 Without external TOD equipment:

Emergency start-up of TOD clock:

a Set and hold A-3-2-T switch to T.

b Press the TONE button.

NOTE

When using this method, the flight commander or lead aircraft should emergency-start his TOD clock. Lead aircraft would then transfer TOD to other aircraft in flight. Aircraft using this method will not be able to communicate with valid TOD signal in the AF mode. A valid TOD signal must be transferred to all aircraft that have invalid TOD time before effective AJ communications can be achieved.

(2) HAVE QUICK Checklist ARC-164. Loading Word-of-Day (WOD)

(a) "T, 2, 3, A" switch — Not in A position.

(b) Functional selector switch — Both.

(c) Manual, preset, guard switch — Preset.

(d) Manual frequency display — Set WOD

15.

(e) Preset channel select — Set to 15.

(f) Preset button (under frequency cover) — Press.

16. **(g)** Manual frequency display — Set WOD

(h) Preset channel select — Set to 16.

(i) Preset button — Press.

19. **(j)** Repeat steps g thru i to store WOD 17, 18,

(k) Manual frequency display — Set 300.050.

(l) Preset channel select — Set to 20.

(m) Preset button — Press.

(n) Rotate preset select down 19, 18, 17, 16, 15, (hear 1 beep 20 — 16, 2 beeps on 15).

(3) Receiving Time from Net Control Aircraft.

(a) Manual, preset, guard switch — Manual.

(b) Set to internal frequency to receive the time.

(c) Hear net control aircraft state: "Standby for time".

(d) Rotate "T, 2, 3, A" switch to "T" and return to established manual frequency, hear.

(e) Hear net control aircraft state: "Go active 0 point one".

(f) Set A00.100 in manual window and complete commo check; if loud tone is heard, repeat timing.

(4) Sending Time (Net Control Aircraft).

(a) Manual, preset, guard switch — Manual.

(b) Set to internal frequency.

(c) Rotate "T, 2, 3, A" switch to "T" on hold.

(d) Press tone button and hold to (hear no tone).

(e) "T, 2, 3 A" to internal frequency (.25 second beep, then tone)

(f) Call other aircraft to send time.

(g) Press tone button to send time.

NOTE

Recall today's WOD by reselecting presets 20 down thru 15, and hear beeps.

■ Figure 3-7. HAS BEEN DELETED.

3-27. VOICE SECURITY EQUIPMENT (TSEC/KY-58).

a. Description. The voice security equipment is used with the FM Command Radio to provide secure two way communication. The equipment is controlled by the control-indicator (Z-AHP) mounted in the lower console. The POWER switch must be in the ON position, regardless of the mode of operation, whenever the equipment is installed.

b. Controls and Functions. Refer to Figure 3-8.

3-28. OPERATING PROCEDURES. Normal operation will exist without the TSEC/KY-58 and the control-indicator (Z-AHP) being installed in the helicopter. Refer to the following procedures to operate the equipment in any particular mode.

3-29. SECURE VOICE PROCEDURES.

NOTE

To talk in secure voice, the KY-58 must be "Loaded" with any number of desired variables.

- a. Set to MODE switch to OP.
- b. Set the FILL switch to the storage register which contains the crypto-net variable (CNV) you desire.
- c. Set the POWER switch to ON.
- d. Set the PLAIN C/RAD switch to C/RAD.
- e. If the signal is to be retransmitted, set the DELAY switch to (ON).

f. At this time a crypto alarm, and background noise, in the aircraft audio intercom system should be heard. To clear this alarm, press and release PTT in the aircraft audio/intercom system. Secure voice communication is now possible.

NOTE

When operating in either secure or clear (plain) voice operations, the VOLUME must be adjusted on the aircraft radio and intercom equipment to a comfortable operating level.

3-30. CLEAR VOICE PROCEDURES.

- a. Set the PLAIN-C/RAD switch to PLAIN.
- b. Operate the equipment.

3-31. ZEROIZING PROCEDURES.



Instructions should originate from the Net Controller or Commander as to when to zeroize the equipment.

To zeroize the KY-58: (Power must be on).

- a. Lift the red ZEROIZE switch cover on the RCU.
- b. Lift the spring-loaded ZEROIZE switch. This will zeroize positions 1-6.
- c. Close the red cover.
The equipment is now zeroized and secure voice communications are no longer possible.

3-32. AUTOMATIC REMOTE KEYING PROCEDURE.

NOTE

Automatic Remote Keying (AK) causes an “old” crypto-net variable (CNV) to be replaced by a “new” CNV. Net Controller simply transmit the “new” CNV to your KY-58.

- a. The Net Controller will use a secure voice channel, with directions to stand by a for an AK transmission. Calls should not be made during this stand by action.
- b. Several beeps should now be heard in your headset. This means that the “old” CNV is being replaced by a “new” CNV.
- c. Using this “new” CNV, the net controller will ask you for a “radio check.”
- d. After the “radio check” is completed, the Net Controller instructions will be to resume normal communications. No action should be taken until the net controller requests a “radio check.”

3-33. MANUAL REMOTE KEYING PROCEDURES. The Net Controller will make contact on a secure voice channel with instructions to stand by for a new crypto-net variable (CNV) by a Manual Remote Keying (MK) action. Upon instructions from the Net Controller:

- a. Set the Z-AHP FILL switch to position 6. Notify the Net Controller by radio, and stand by.
- b. When notified by the Net Controller, set the Z-AHP MODE switch to RV (receive variable). Notify the Net Controller, and stand by.
- c. When notified by the Net Controller, set the Z-AHP FILL switch to any storage position selected to receive the new CNV (may be unused or may contain the variable being replaced). Notify the Net Controller, and stand by.

NOTE

When performing Step c. the storage position (1 through 6) selected to receive the new CNV may be unused, or it may contain the variable which is being replaced.

- d. Upon instructions from the Net Controller:

- (1) Listen for a beep on your headset.
- (2) Wait two seconds.
- (3) Set the RCU MODE switch to OP.
- (4) Conf rm.

e. If the MK operation was successful, the Net Controller will now contact you via the new CNV.

f. If the MK operation was not successful, the Net Controller will contact you via clear voice (plain) transmission; with instructions to set your Z-AHP FILL selector switch to position 6, and stand by while the MK operation is repeated.

3-34. KY-58 AUDIO TONES. It is important to be familiar with certain KY-58 audio tones. Some tones indicate normal operation, while others indicate equipment malfunction. These tones are:

a. Continuous beeping, with background noise, is cryptoalarm. This occurs when power is frst applied to the KY-58, or when the KY-58 is zeroized. This beeping is part of normal KY-58 operation. To clear this tone, press and release the PTT button on the Z-AHQ (after the Z-AHQ LOCAL switch has been pressed). Also the PTT can be pressed in the cockpit.

b. Background noise indicates that the KY-58 is working properly. This noise should occur at TURN ON of the KY-58, and also when the KY-58 is generating a cryptovvariable. If the background noise is not heard at TURN ON, the equipment must be checked out by maintenance personnel.

c. Continuous tone, could indicate a “parity alarm.” This will occur whenever an empty storage register is selected while holding the PTT button is. This tone can mean any of three conditions:

- (1) Selection of an empty storage register.
- (2) A “bad” cryptovvariable is present.

(3) Equipment failure has occurred. To clear this tone, follow the “Loading Procedures” in TM 11-5810-262-OP. If this tone continues, have the equipment checked out by maintenance personnel.

d. Continuous tone could also indicate a cryptoterror. If this tone occurs at any time other than in 3-34.c above, equipment failure may have occurred. To clear this tone, repeat the "Loading Procedures" in TM 11-5810-262-OP. If this tone continues, have the equipment checked out by maintenance personnel.

e. Single beep, when RCU is not in TD (Time Delay), can indicate any of three normal conditions:

(1) Each time the PTT button is pressed when the KY-58 is in C (cipher) and a filled storage register is selected, this tone will be heard. Normal use (speaking) of the KY-58 is possible.

(2) When the KY-58 has successfully received a cryptovisible, this tone indicates that a "good" cryptovisible is present in the selected register.

(3) When you begin to receive a ciphered message, this tone indicates that the cryptovisible has passed the "parity" check, and that it is a good variable.

f. A single beep, when the RCU is in TD (Time Delay) occurring after the "preamble" is sent, indicates that you may be speaking.

g. A single beep, followed by a burst of noise after which exists a seemingly "dead" condition indicates that your receiver is on a different variable than the distant transmitter. If this tone occurs when in cipher text mode: Turn RCU FILL switch to the CNV and contact the transmitter in PLAIN text and agree to meet on a particular variable.

SECTION II NAVIGATION

3-35. DIRECTION FINDER SET — (AN/ARN-89).

3-36. DESCRIPTION — DIRECTION FINDER SET(AN/ARN-89). The direction finder set (ADF) AN/ARN-89 (figure 3-9) is used in conjunction with gyromagnetic compass and intercommunications systems. ADF bearing information is indicated on the heading-radio bearing indicator (figure 3-10). The bearing pointer displays either the ADF bearing or the VOR bearing depending on the position selected on the RMI BRG PNTR switch. The ADF set operates in the 100 to 3000 KHz frequency range and is used to receive continuous wave (cw) or amplitude modulated (am) radio frequency signals. The three modes of operation for the ADF set include automatic homing in the COMPASS mode, manual homing in the LOOP mode, and as a communications receiver in the ANTenna mode. A beat frequency oscillator is included to provide an audible indication for identification and tuning and is activated by the CW switch. The radio set control unit is marked ADF RCVR and is mounted in the center section of the instrument panel. Antenna locations are shown in figure 3-1.

3-37. CONTROLS AND FUNCTIONS — DIRECTION FINDER SET (AN/ARN-89).

Refer to figure 3-9.

3-38. OPERATING PROCEDURES — DIRECTION FINDER SET (AN/ARN-89).

a. COMPASS Mode.

(1) Function selector COMP.

(2) Frequency — Select. Tuning may be accomplished with function selector in COMP, ANT, or LOOP positions; however, less noise is encountered in the ANT position.

(3) AUDIO — Adjust.

(4) TUNE meter — Select. Tune for maximum up deflection of needle.

(5) CW VOICE TEST switch — TEST then release.

(6) Observe ADF needle indications.

b. LOOP Mode.

(1) Function selector — LOOP.

(2) AUDIO — Adjust.

(3) CW VOICE TEST switch — CW.

(4) LOOP switch — Move left and right as required to obtain aural null.

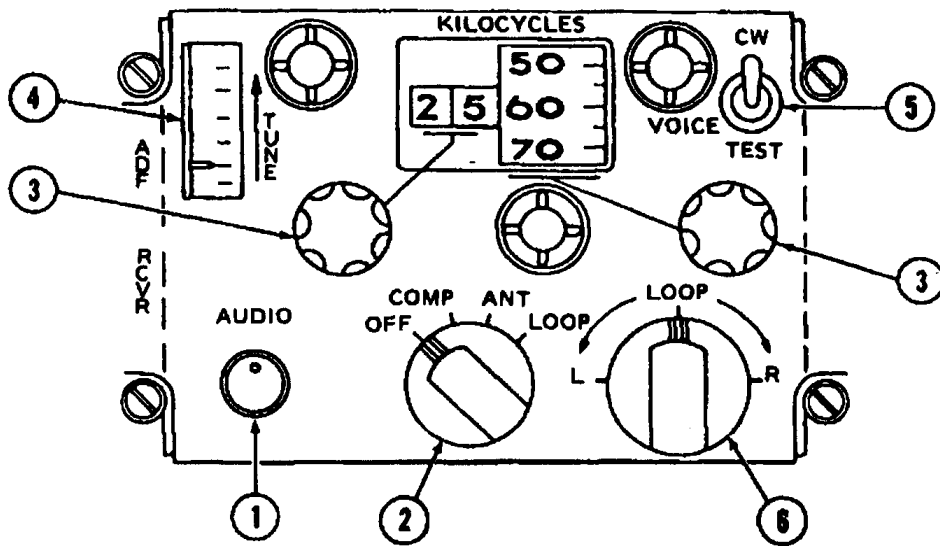

CONTROL/INDICATOR	FUNCTION
1. AUDIO	Adjusts receiver volume.
2. Function Selector	
OFF	Power off.
COMP	Activates the ADF pointer on the radio bearing heading indicator . Activates bearing pointer on HBI.
ANT	Receiver provides aural information only.
LOOP	Receiver operates using only the loop antenna.
3. Frequency Selectors	
Left Selector	Selects first two digits of desired frequency.
Right Selector	Selects third and fourth digits of desired frequency.
4. TUNE Meter	Up deflection of the needle indicates most accurate tuning of the receiver when function selector is in the COMP position.
5. CW VOICE TEST Switch	
CW	Provides tone that may be used for identification, tuning, or for loop operation.
VOICE	Permits normal aural reception.
TEST	Rotates ADF needle 180° from original bearing to provide a check of needle accuracy with function selector in the COMP position. Inoperative in LOOP and ANT position. The switch is spring loaded away from TEST position.
6. LOOP Switch	Used to rotate loop antenna by moving switch left or right. Direction and degree of turn are shown on the radio bearing heading indicator. Function selector must be in LOOP position.

Figure 3-9. AN/ARN-89 (ADF) Control Panel

c. Preliminary.

- (1) Interphone control panel receiving NAV switch — ON.
- (2) RMI BRG PTR switch — ADF.
- (3) Function selector — COMP.
- (4) Frequency — Select.
- (5) AUDIO — Adjust.
- (6) TUNE meter — tune for maximum up needle deflection.

d. Manual Operation.

- (1) Function selector — LOOP.
- (2) VOICE CW switch — CW.
- (3) Rotate LOOP control for maximum reception and retune.
- (4) Rotate LOOP control to find audible null position and adjust volume for a 5 to 8 degree null width.
- (5) Check for ambiguity — The ADF bearing pointer will either read the magnetic bearing to the station or be 180 degrees out.

e. Stopping Procedure. Function Selector — OFF.

3-39. GYRO MAGNETIC COMPASS SET — AN/ASN-43.**3-40. DESCRIPTION — GYRO MAGNETIC COMPASS SET.**

The gyro magnetic compass set provides accurate heading information, referenced to a free directional gyro heading when operated in the DIR gyro mode (free gyro), or slaved to the earth's magnetic field when operated in the MAG mode (magnetically slaved). It provides heading information in the form of a synchro output to the radio bearing heading indicator (and by presenting the magnetic heading as a reference signal to the VOR ).

3-41. CONTROLS AND FUNCTIONS — GYRO MAGNETIC COMPASS SET.



Refer to paragraph 3-42.

3-42. OPERATING PROCEDURES — GYRO MAGNETIC COMPASS SET.

a. DIR GYRO/MAG switch — DIR GYRO for free gyro mode operation.

b. DIR GYRO/MAG switch — MAG for slaved mode operation.

3-43. RADIO BEARING HEADING INDICATOR — ID-1351A.

3-44. DESCRIPTION — RADIO BEARING HEADING INDICATOR. The ID-1351/A  (ID-1351C/A ) indicator is mounted on the instrument panel and provides magnetic heading information and radio bearings by displaying information from the gyromagnetic compass set, ADF, (VOR ) and FM radios. Additionally, it provides visual indications of gyromagnetic compass failure, compass synchronization and approach to a radio station. The compass correction card for this instrument will be located in the front of the aircraft logbook.

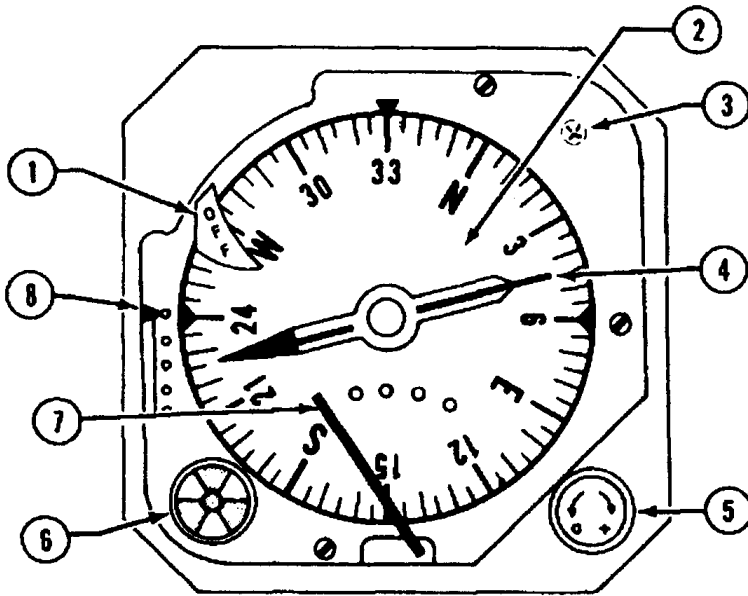

ID-1351/A **A**

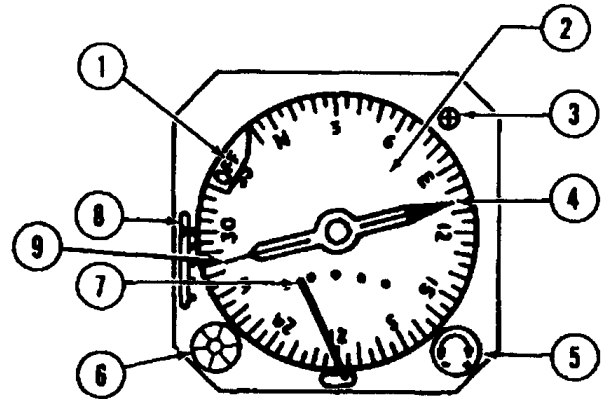

ID-1351 C/A **C**

CONTROL/INDICATOR	FUNCTION
1. Power Warning Indicator	Indicates when AC power is not being supplied to the gyromagnetic compass. Indicates when AC power is being supplied to the gyromagnetic compass or when the AN/ASN-43 AC power supply is inoperative.
2. Heading Dial	Indicates the helicopter magnetic heading under the index.
3. Annunciator	Indicates by means of a dot (•) or cross (+) the direction the synchronizing knob (item 5) should be turned to give immediate and accurate synchronization.
4. ADF Pointer	Indicates bearing of radio station from helicopter .
5. Synchronizing Knob	Determines the heading synchronization.
6. Signal Strength Indicator	Indicates the presence or absence of FM radio signal.
7. Steering Indicator	Indicates helicopter deviation from a direct approach to the FM radio transmitter.
8. Station Approach Indicator . . .	Indicates aircraft's approach to a FM radio transmitter.
9. Bearing Pointer C	Indicates bearing of radio station from helicopter (VOR or ADF as selected by RMI BRG PNTR switch) C .

Figure 3-10. Radio Bearing Heading Indicator



3-45. CONTROLS AND FUNCTIONS — RADIO BEARING HEADING INDICATOR. Refer to figure 3-10.

3-46. OPERATING PROCEDURES — RADIO BEARING HEADING INDICATOR.

a. Gyro-magnetic Heading Display and Synchronization.

(1) Gyro-magnetic heading dial rotates to indicate the helicopter's magnetic heading under the index.

(2) Heading synchronization is accomplished by rotating the synchronizing knob. The annunciator indicates, by means of a dot (•) or cross (+), the direction that the synchronizing knob should be turned to give immediate and accurate synchronization. If a cross (+) is showing in the annunciator, the synchronizing knob should be turned clockwise, and if a dot (•) is showing, the synchronizing knob should be turned counterclockwise. The system is synchronized when the annunciator indicates neither a dot (•) nor a cross (+). If, shortly after synchronizing the system, the heading dial drifts and a dot (•) or cross (+) appears in the annunciator, then the system was synchronized to a false null located 180 degrees from the correct heading and should be re-synchronized to the correct helicopter heading. The helicopter standby magnetic compass may be checked for reference.

b. ADF Pointer  (Bearing Pointer . Radio magnetic bearing information is indicated by the ADF pointer of the indicator. The arrow end of this pointer indicates the bearing of the radio station from the helicopter. The ADF set furnishes the bearing information to the pointer (VOR or ADF as selected by the RMI BRG PTR switch located on the instrument panel .

c. FM Homing.

(1) The steering indicator receives its input from the number 1 FM radio homing system. By moving to the right or left of its center indication, the indicator shows helicopter deviation from a direct approach path to the FM radio transmitter. The indicator moves to the right when the homing transmitter site is to the right of the helicopter, and to the left when the transmitter is to the left of the helicopter.

(2) An FM signal strength indicator shows red whenever the FM radio receiver signal is absent or is too weak for a reliable indication. When the signal strength is acceptable, the FM signal strength indicator shows black.

(3) The station approach indicator indicates helicopter approach to the FM radio transmitter. The pointer moves down as the transmitter is approached.

d. The power warning indicator comes into view whenever electrical AC power to the gyromagnetic compass is off, or inoperative.

3-47.  CONUS NAVIGATION RECEIVER.

NOTE

Keying of the AN/ARC-115, VHF-AM transmitter may cause the AN/ARN-123 VOR receiver to lose station lock-on. The RMI BRG PTR on the heading radio bearing indicator and the course pointer on the course deviation indicator will return to center position and the VOR NAV warning flag will appear. The VOR receiver will return to normal operation when the AN/ARC-115 transmitter is unkeyed.

3-48. DESCRIPTION — CONUS NAVIGATION RECEIVER. The CONUS navigation receiver AN/ARN-123(V) receives the combined VOR (VHF omni-range) and LOC (localizer) signals over a frequency range of 108.000 to 117.95 MHz, GS (glideslope) signals over a frequency range of 329.15 to 335.00 MHz, and MB (marker beacon) signals on 75.00 MHz from ground transmitters. The receiver is controlled by the C-10048/AR-123 control panel (figure 3-11) mounted on the lower right side of the instrument panel. The signals are visually displayed on the CDI (figure 3-12), and the marker beacon light as required. The VOR and localizer audio signals are received from ground transmitters through the helicopter intercommunications system by placing the interphone control (figure 3-2) AUX switch to ON. The set enables the operator to determine his present position, direction to a given point, and fly a predetermined flight path to localizer circuitry provides a visual display of the helicopter position relative to a localizer course. The marker beacon circuitry provides a visual display and aural tone to indicate helicopter position relative to a marker ground transmitter.

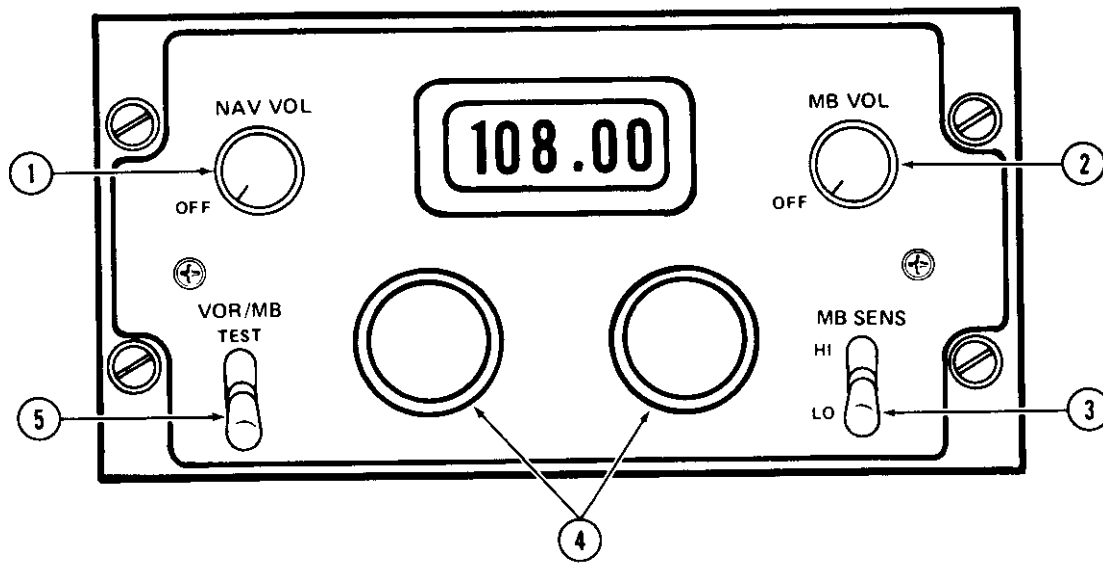

MS026091

CONTROL/INDICATOR	FUNCTION
1. NAV VOL Power Switch and Volume Control	
NAV VOL	Turns set on and controls VOR/LOC receiver volume.
OFF	Turns set OFF.
2. MB VOL Power Switch and Volume Control	
MB VOL	Turns set on and controls marker beacon volume.
OFF	Turns set OFF.
3. MB SENS Switch	
HI	Selects high receiver sensitivity.
LO	Selects low receiver sensitivity.
4. Frequency Selectors	
Right	Selects the fractional megahertz portion of the desired frequency.
Left	Selects the whole megahertz portion of the desired frequency.
5. VOR/MB-TEST Switch	Provides on and off capability for the VOR/MB self-test circuit within the receiver.

Figure 3-11. CONUS Navigation Receiver Control Panel

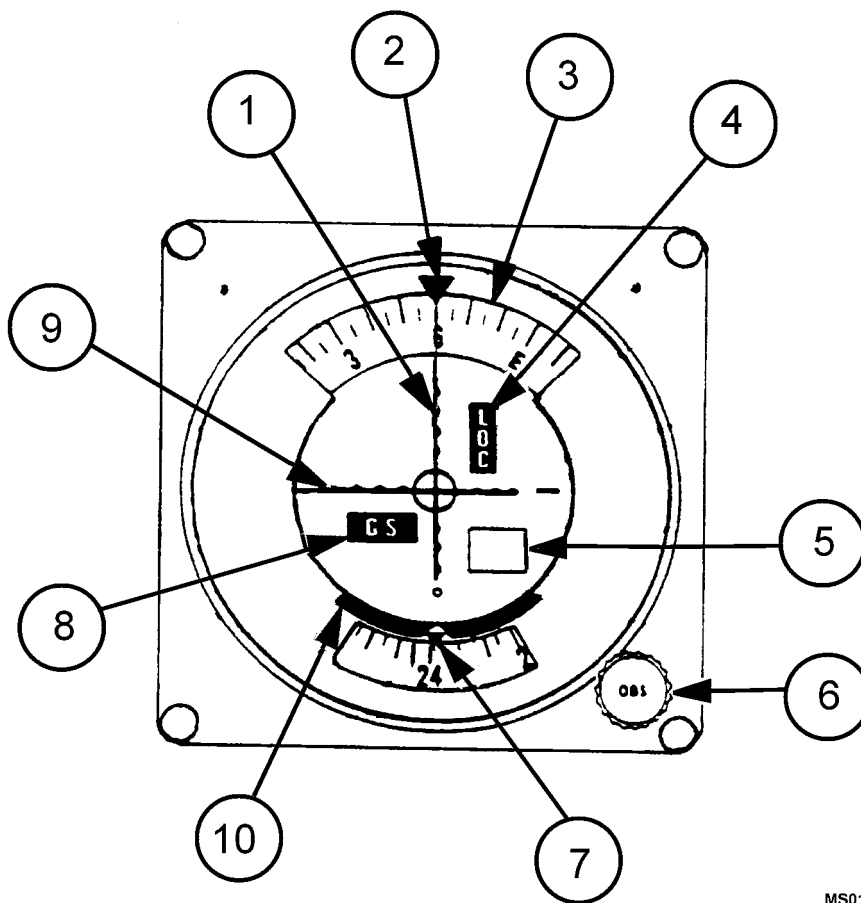

MS019066

CONTROL/INDICATOR	FUNCTION
1. Course Pointer	Indicates deviation from selected VOR radial or LOC path.
2. Course Index	Provides reference point for course deviation card.
3. Course Deviation Card	Manually rotated card, driven by OBS control to indicate desired VOR radial directly beneath course index.
4. NAV Warning Flag	Red NAV flag indicates VOR or LOC signal is unreliably weak or malfunction in receiver.
5. To/From Flag	Indicates whether flying selected radial would direct helicopter toward (TO) or from (FR) VOR station.
6. Omnibearing Selector (OBS) ...	Drives course deviation card for course selection.
7. Reciprocal Course Index	Indicates radial 180 degrees from selected radial.
8. Glide Slope Warning Flag	Red GS flag indicates GS signal is unreliably weak or malfunction in receiver.
9. Glide Slope Pointer	Indicates deviation from glidepath.
10. Blue/Yellow Off Course Indicator	Indicates deviation from selected course.

Figure 3-12. Course Deviation Indicator (CDI) □

3-49. CONTROLS AND FUNCTIONS — CONUS NAVIGATION RECEIVER.

Refer to figure 3-11.

3-50. OPERATING PROCEDURES — CONUS NAVIGATION RECEIVER.

a. System Operation.

- (1) NAV VOL switch control – On and adjust.
- (2) MB VOL switch control – On and adjust.
- (3) VOR/MB/TEST switch – Press to test as follows:

NOTE

This test requires an external VOR rf signal generated by a ground station, or ramp test set.

- (a) Set the course indicator OBS control for a 315 degree indication under the course index.
 - (b) Move the control unit VOR/MB switch to the TEST position (down).
 - (c) The CDI deviation needle should indicate center ± 2 dots.
 - (d) The VOR/LOG flag should be buried.
 - (e) The RMI should point to the 315 degree radial (± 5 degrees).
 - (f) The marker beacon lamp should illuminate.
- (4) Frequency selectors – As required.
 - (5) MB SENS switch – As desired.

(6) RMI BRG PTA switch (located on instrument panel) – VOR.

(7) Interphone control panel AUX switch – ON.

(8) Interphone control panel VOL switch – Adjust.

b. Stopping Procedure. NAV VOL AND MB VOL switch controls – OFF.

3-51. COURSE DEVIATION INDICATOR (CDI).

3-52. DESCRIPTION – COURSE DEVIATION INDICATOR.

The CDI ID-1347C/ARN (figure 3-12) is mounted on the right side of the instrument panel and displays VOR, LOC, and GS bearing information received from the CONUS navigation receiver. Additionally, it provides visual indications of unreliably weak VOR, LOC, and GS signals or equipment malfunction (NAV and GS flags), to/from station indication, and course selection.

3-53. CONTROLS AND FUNCTIONS – COURSE DEVIATION INDICATOR.

Refer to figure 3-12.

3-54. OPERATING PROCEDURES – COURSE DEVIATION INDICATOR.

Refer to figure 3-12.

3-54.1. GLOBAL POSITIONING SYSTEM (MWO 1-1520-228-50-53).

Operation of the Trimble Trimpack Global Positioning System (GPS) will be accomplished with the Interim Statement of Airworthiness Qualifications (ISAQ) and appropriate commercial manuals.

SECTION III TRANSPONDER AND RADAR

3-55. **A** TRANSPONDER SET – AN/APX-72.

3-56. **A** DESCRIPTION – TRANSPONDER SET.

The APX-72 (figure 3-13) provides a radar identification capability. Five independent coding modes are available to the pilot. The first three modes may be used independently or in combination. Mode 1 provides 32 possible code combinations, any one of which may be selected in flight. Mode 2 provides 4,096 possible code combinations but only one is available since the selection dial is not available in flight and must be preset before flight. Mode 3/A provides 4,096 possible codes, any of which may be selected in flight. Mode C is used with the MU032/A Encoding altimeter. Mode 4, which is connected to an external computer, can be programmed prior to flight to display any one of many classified operational codes for security identification. The effective range depends on the capability of interrogating radar and line-of-sight. The code setting can be mechanically retained. On the instrument Panel and Console – place the IFF CODE HOLD-OFF switch to the HOLD position. On the Transponder Set Control Panel – turn

CODE switch to HOLD (only momentary action is required). The transponder set is mounted on the upper left side of the instrument panel. The associated antenna is shown in figure 3-1.

3-57. **A** CONTROLS AND FUNCTIONS – TRANSPONDER SET.

The control panel is located on the instrument panel. It provides remote control of the APX-72 transponder set. Mode 2 code select switch is on the front panel of the receiver-transmitter radio. Controls and functions are shown in figure 3-13.

3-58. **A** OPERATING PROCEDURES – TRANSPONDER SET.

a. Transponder Operation.

(1) MASTER control – STBY. Allow approximately 2 minutes for warmup.

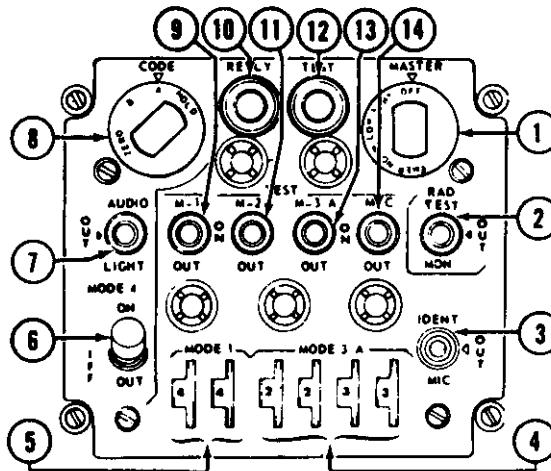

MS026092

CONTROL/INDICATOR	FUNCTION
1. MASTER Control	
OFF	Turns set OFF.
STBY	Places in warmup (standby) condition.
LOW	Set operates at reduced receiver sensitivity.
NORM	Set operates at normal receiver sensitivity.
EMER	Transmits emergency reply signals to MODE 1, 2, or 3/A interrogations regardless of mode control settings.
2. RAD TEST – MON Switch	
RAD TEST	Enable set to reply to TEST mode interrogations. Other functions of this switch position are classified.
MON	Enables the monitor test circuits.
OUT	Disables the RAD TEST and MON features.
3. IDENT-MIC Switch	
IDENT	Initiates identification reply for approximately 25 seconds.
OUT	Prevents triggering of identification reply. Spring loaded to OUT.
MIC	Not used.
4. MODE 3/A Code select Switches	Selects and indicates the MODE 3/A four-digit reply code number.
5. MODE 1 Code Select Switches ..	Selects and indicates the MODE 1 two-digit reply code number.

CONTROL/INDICATOR	FUNCTION
6. MODE 4 Switch	
ON	Enables the set to reply to MODE 4 interrogations.
OUT	Disables the reply to MODE 4 interrogations.
7. AUDIO-LIGHT Switch	
AUDIO	Enables aural and REPLY light monitoring of valid MODE 4 interrogations and replies.
LIGHT	Enables REPLY light only monitoring of valid MODE 4 interrogations and replies.
OUT	Disables aural and REPLY light only monitoring of valid MODE 4 interrogations and replies.
8. CODE Control	Holds, zeroizes or changes MODE 4 code.
9. M-1 Switch	
ON	Enables the set to reply to MODE 1 interrogations.
OUT	Disables the reply to MODE 1 interrogations
TEST	Provides test of MODE 1 interrogations by indication on TEST light.
10. REPLY Indicator	Lights when valid MODE 4 replies are present, or when pressed.
NOTE	
Computer must be installed before set will reply to a MODE 4 interrogation.	
11. M-2 Switch	
ON	Enables the set to reply to MODE 2 interrogations.
OUT	Disables the reply to MODE 2 interrogations.
TEST	Provides test of MODE 2 interrogation by indication on TEST light.
12. Test indicator	Lights when the set responds properly to a M-1, M-2, M-3/A or M-C test, or when pressed.
13. M-3/A Switch	
ON	Enables the set to reply to MODE 3/A interrogations.
OUT	Disables the reply to MODE 3/A interrogations.
TEST	Provides test of MODE 3/A interrogations by indication on TEST light.
14. M-C Switch	
ON	Enables set to reply to MODE C interrogations.
OUT	Disables reply to MODE C interrogations.
TEST	Enables TS-1843/APX to locally interrogate set.

Figure 3-13. Transponder APX-72 Control Panel **A**

- (2) Mode and code – Select as required.
- (3) Test as required.
- (4) MASTER control – LOW, NORM, EMER as required.
- (5) IDENT – As required.

b. Stopping Procedure. MASTER control – OFF.

3-59.  TRANSPONDER SET – AN/APX-100.

a. Description. The transponder set AN/APX-100, enables the helicopter to identify itself automatically when properly challenged by friendly surface and airborne radar equipment. The control panel (figure 3-14), located on the instrument panel, enables the set to operate in modes 1, 2, 3A, 4, C, and test. When computer KIT-1A(-1C)/TSEC (classified) is installed, mode 4 is operational. The range of the receiver-transmitter is limited to line-of-sight transmission since its frequency of operation is in the UHF band making range dependent on altitude. The Mode 4 codes can be mechanically retained. On the instrument Panel and Console – place the HOLD-OFF switch to the HOLD position. On the Transponder Set Control Panel – turn the CODE switch to HOLD (only momentary action is required). Turn the master switch or helicopter power off.

b. Controls and Functions. Refer to figure 3-14.

c. Operating Procedures.

(1) Transponder Operation.

- (a) MASTER control – STBY. Allow approximately 2 minutes for warmup.
- (b) MODE and CODE – Select as required.
- (c) TEST – As required.
- (d) MASTER control – NORM or EMER as required.
- (e) ANT – As desired.
- (f) IDENT – As required.

(2) Emergency Operation. MASTER control – EMER.

(3) Stopping Procedure. MASTER control – OFF.

3-60. DELETED.

3-61. DELETED.

3-62. DELETED.

3-63. DELETED.

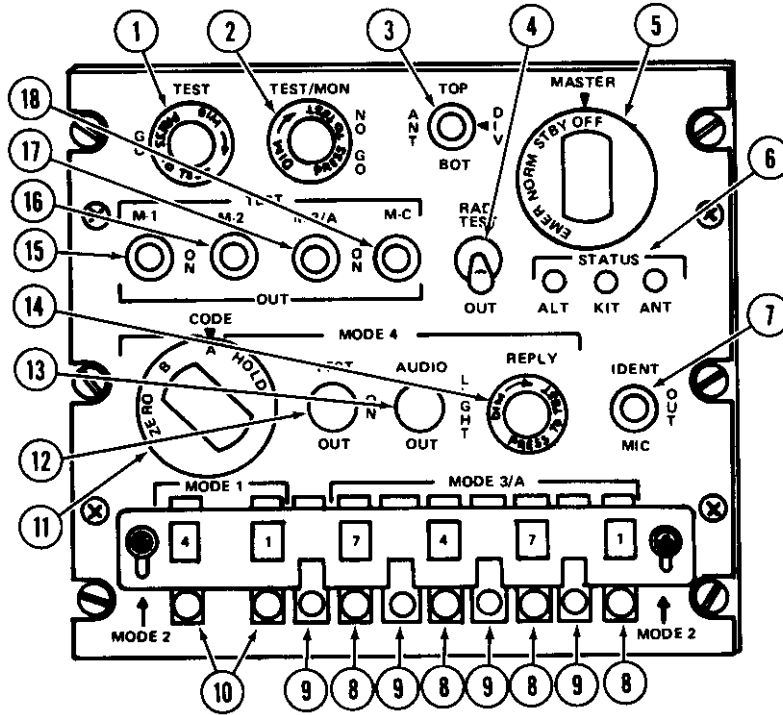

MS026093

CONTROL/INDICATOR	FUNCTION
1. TEST GO	Indicates successful built in test (BIT).
2. TEST/MON NO GO	Indicates unit malfunction.
3. ANT	
TOP	Selects antenna located on top of helicopter.
BOT	Selects antenna located on bottom of helicopter.
DIV	Selects both top and bottom antenna.
4. RAD TEST Switch	
RAD TEST	Enables set to reply to TEST mode interrogations.
OUT	Disables to RAD TEST features.
5. MASTER Control	
OFF	Turns set OFF.
STBY	Places in warmup (standby) condition.
NORM	Set operates at normal receiver sensitivity.
EMER	Transmits emergency reply signal to MODE 1, 2, or 3/A interrogations regardless of mode control settings.

CONTROL/INDICATOR	FUNCTION
6. STATUS Indicators.	
ANT	Indicates that built in test (BIT) or monitor (MON) failure is due to high voltage standing wave ratio (VSWR) in antenna.
KIT	Indicates that built in test (BIT) or monitor (MON) failure is due to external computer.
ALT	Indicates that built in test (BIT) or monitor (MON) failure is due to altitude digitizer.
7. IDENT-MIC Switch	
IDENT	Initiates identification reply for approximately 25 seconds.
OUT	Prevents triggering of identification reply. Spring loaded to OUT.
MIC	Not used.
8. MODE 3/A Code Select Switches	Selects and indicates the MODE 3/A four-digit reply code number.
9. MODE 2 Code Select Switches ..	Selects and indicates the MODE 2 four-digit reply code number.
10. MODE 1 Code Select Switches ..	Selects and indicates the MODE 1 two-digit reply code number.
11. CODE CONTROL	Holds, zeroizes, or changes MODE 4 code.
12. MODE 4/TEST Switch	
TEST	Selects MODE 4 BIT operation.
ON	Selects MODE 4 ON operation.
OYT	Disables MODE 4 operation.
13. MODE 4 AUDIO/LIGHT Control	
AUDIO	MODE 4 is monitored audio.
LIGHT	MODE 4 is monitored by a light.
OUT	MODE 4 not monitored.
14. MODE 4/REPLY	Indicates that a MODE 4 REPLY is generated.
15. TEST/TEST/M-1	
TEST/ON/OUT	Selects ON, OFF, or BIT of MODE 1 operation.
16. TEST/M-2	
TEST/ON/OUT	Selects ON, OFF, or BIT of MODE 2 operation.
17. TEST/M-3/A	
TEST/ON/OUT	Selects ON, OFF, or BIT of MODE 3/A operation.
18. TEST/M-C	
TEST/ON/OUT	Selects ON, OFF, or BIT of MODE C operation.

Figure 3-14. Transponder Set Control Panel 

FIGURE 3-15. HAS BEEN DELETED.

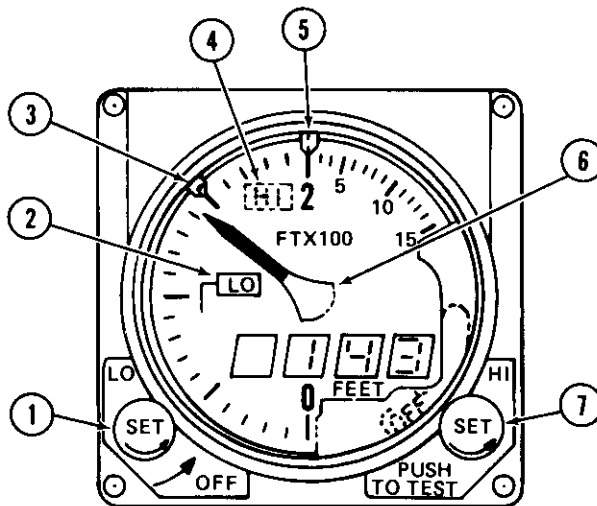

ALTIMETER

MS026094

CONTROL/INDICATOR	FUNCTION
1. LO SET Control Knob	Turns facility on and off, and sets low attitude limit index.
2. LO Level Warning Flag	Indicates LO when altitude reaches respective limit index.
3. Low Limit Index	Manually sets low altitude limit index. Actuates LO level warning flag when limit reached.
4. HI Level Warning Flag	Indicates HI when altitude reaches respective limit index.
5. High Limit Index	Manually sets high altitude limit index. Actuates HI level warning flag when limit reached.
6. Altitude Pointer	Indicates actual clearance in feet from helicopter to terrain (zero to 1500 feet).
7. HI SET Control Knob	Set high altitude limit index and operates self-test mode.

Figure 3-16. Radar Altimeter.

3-64. RADAR ALTIMETER (WITHOUT MWO 1-1520-228-50-52).

NOTE

Simultaneous operation of the AN/APR-39, radar warning receiver and the AN/APN-209 radar altimeter will cause a strobe to appear on the AN/APR-39 CRT and an audio tone can be heard in the headset for IGE hover.

3-65. DESCRIPTION – RADAR ALTIMETER.

The radar altimeter AN/APN-209 (figure 3-16) is a short pulse, terrain tracking and altitude sensing radar system that measures and visually indicates by pointer and digital display actual clearance in feet between the helicopter and terrain over a range from zero to 1500 feet. The indicator contains all the electronic components necessary for the generation, reception, and tracking of the radar pulses. The indicator provides precise altitude indications with a manually set low-level and high-level warning flag to warn when a predetermined low and high altitude limit has been reached.

3-66. CONTROLS AND FUNCTIONS – RADAR ALTIMETER.

Refer to figure 3-16.

3-67. OPERATING PROCEDURES – RADAR ALTIMETER.

NOTE

Refer to TM 11-5841-284-23&P for additional operating instructions. Particular attention shall be given to "Obstacle Avoidance" as follows: The altimeter system tracks the terrain below the aircraft and, therefore, will not provide useful information to aid in obstacle avoidance. By the time a sufficient area of an obstacle is within the antenna beams so the altimeter set can display the near object, the aircraft probably could not be maneuvered to avoid the object.

a. Altimeter Operation.

(1) LO SET control knob – Rotate clockwise from OFF. Set low limit index as desired.

(2) HI SET control knob – Set high limit index as desired.

b. Self-Test Operation.

(1) High limit index – Set to 800 feet.

(2) Low limit index – Set to 80 feet.

(3) HI SET control knob – Push and hold. Verify pointer indicates 1000 (± 100 feet), digital display reads 1000 (± 100 feet), and HI level warning flag is exposed.

(4) HI SET control knob – Release. Verify pointer indicates 0 (± 5) feet, digital display reads -0 to 3 feet, and low warning flag is exposed.

c. Stopping Procedure. LO SET control knob – Rotate counterclockwise from LO.

3-67.1. RADAR ALTIMETER (WITH MWO 1-1520-228-50-52).

NOTE

Simultaneous operation of the AN/APR-39, radar warning receiver and the AN/APN-209 radar altimeter will cause a strobe to appear on the AN/APR-39 CRT and an audio tone can be heard in the headset for IGE hover.

3-67.2. DESCRIPTION – RADAR ALTIMETER.

The radar altimeter AN/APN-209 (V) (figure 3-16) is a short pulse, terrain tracking and altitude sensing radar system that measures and visually indicates by pointer and digital display actual clearance in feet between the helicopter and terrain over a range from zero to 1500 feet. The indicator contains all the electronic components necessary for the generation, reception, and tracking of the radar pulses. The indicator provides precise altitude indications with a manually set low-level and high-level warning voice and flag to warn when a predetermined low and high altitude limit has been reached.

3-67.3. CONTROLS AND FUNCTIONS – RADAR ALTIMETER.

Refer to figure 3-16.

3-67.4. OPERATING PROCEDURES – RADAR ALTIMETER.

NOTE

Refer to TM 11-5841-284-23&P for additional operating instructions. Particular attention shall be given to “Obstacle Avoidance” as follows: The altimeter system tracks the terrain below the aircraft and, therefore, will not provide useful information to aid in obstacle avoidance. By the time a sufficient area of an obstacle is within the antenna beams so the altimeter set can display the near object, the aircraft probably could not be maneuvered to avoid the object.

a. Altimeter Operation.

(1) LO SET control knob – Rotate clockwise from OFF. Set low limit index as desired.

(2) HI SET control knob – Set high limit index as desired.

b. Self Test Operation.

(1) Lower right knob – Press. The pointer and digital display should read 1000 (\pm 100 feet). Also, the HI indicator on the radar altimeter should be illuminated. Release the knob. The reading should extinguish.

(2) Lower left knob – Adjust clockwise until the LO bug is positioned “above” (greater in altitude than) the pointer. A periodic audio warning “ALTITUDE LOW-TOO-LOW” should be heard in all headsets. Also, the LO indicator on the radar altimeter should be illuminated.

(3) Master ICS volume control – Rotate on each respective ICE unit. The audio warning volume should fluctuate. The audio warning volume level can also be altered by momentarily pressing the Push-To-Talk (PTT) knob (lower-right) on the radar altimeter itself after the voice warning has been initiated. Depress the PTT knob once. The audio warning volume should be 1/2 the initial level. Depress the PTT knob a second time, the audio warning message should be disabled. Once the volume is reduced 1/2 initial level, the audio warning volume level cannot be changed (except by adjusting the master ICS volume control) or once disabled it cannot be brought back.

(4) Lower left knob – Adjust counterclockwise until the LO bug is “below” the pointer, then adjust the knob clockwise until the LO bug is positioned “above” the pointer again. The “ALTITUDE LOW – TOO LOW” audio warning should again be heard at its initial “FULL” volume level.

(5) Lower knob – Adjust counterclockwise until the LO bug is “below” the pointer, (but not quite to the OFF position). The warning audio should cease. The LO indicator should be extinguished.

(6) Lower right knob – Depress and hold to put the Radar Altimeter into the test mode. A periodic “ALTIMETER HIGH-CHECK ALTITUDE” should be heard in all headsets. Also, the HI indicator on the radar altimeter should be illuminated.

(7) Push-To-Test knob – Release. The warning audio message should cease. The HI indicator should be extinguished.

c. Stopping Procedure. LO SET control knob – Rotate counterclockwise from LO.

3-68. RADAR SIGNAL DETECTING SET (AN/APR-39A(V)1).

Refer to TM 11-5841-294-12.

3-68.1. DESCRIPTION – RADAR SIGNAL DETECTING SET (AN/APR-39A(V)1).

a. Description. The radar signal detecting set AN/APR-39A(V)1 provides the pilot with visual and audible warning when a hostile fire control threat is encountered. The equipment responds to hostile fire-control radars but non-threat radars are generally excluded. The equipment also receives missile guidance radar signals and, when the signals are time-coincident with a radar tracking signal, the equipment identifies the combination as an activated hostile surface-to-air missile (SAM) radar system. The visual and aural displays warn the pilot of potential threat so that evasive maneuvers can be initiated.

b. Function.

(1) The AN/APR-39A(V)1 receives, processes and displays pulse type signals operating in the C-D and H-M radio frequency bands. The emitters that it processes and displays are derived from the emitter identification data (EID) contained in the user data module (UDM) that is inserted in the top of the digital processor. In normal circumstances the processor is classified confidential if a classified UDM is installed.

(2) The UDM contains the electronic warfare threat data that makes up the specific library for a specific mission(s) or a geographical location (it is theaterized). When a match of the electronic warfare data

occurs the processor generates the appropriate threat symbology and synthetic audio. It is important therefore that the correct theaterized EID and UDM are installed for mission or geographic location.

(3) Symbol generation and position relative to the center of the CRT shows the threat lethality, it does not show or represent and liability of range, but of condition/mode of the emitter. Highest priority threats (most lethal) are shown nearest the center. Each symbol defines a generic threat type, symbols are modified to show change in the status of the emitter. The symbols are unclassified, the definitions of what the symbols mean are classified. The complete set of symbols and definitions are contained in TM 11-5841-294-30-2. Each theaterized library EID has a specific classified pilot keyboard produced with it. The unit electronic warfare officer (EWO) should contact PM-ASE if sufficient cards are not available within his unit for the installed EID.

3-69. CONTROLS AND FUNCTIONS – RADAR SIGNAL DETECTING SET (AN/APR-39A(V)1).

Refer to figure 3-17.

3-70. OPERATING PROCEDURES – RADAR SIGNAL DETECTING SET (AN/APR-39A(V)1).

a. Self-Test Mode.

(1) After power up, the AN/APR-39A(V)1 synthetic voice will announce "APR-39 POWER UP" and the (+) symbol will stabilize in the center of the CRT. Self test should be initiated after approximately one minute. Self test can be performed in MODE ONE or MODE TWO.

In MODE ONE the synthetic voice will announce "SELF TEST SET VOLUME, 1, 2, 3, 4, 5, 6, 7, 8, 9, 10, 11, 12". In MODE TWO the synthetic voice will announce "SELF TEST VOLUME, 5, 4, 3, 2, 1".

(2) The CRT will display specific software version numbers (i.e., operational flight program (OFP) at the 12 o'clock position and the emitter identification data (EID) at the 6 o'clock position.

(3) After the software version numbers have been displayed the test sequence checks the receivers. A good visual self test will show two triangles, one at the 6 o'clock and one at the 12 o'clock position on the CRT. Snowflake symbols (*) will appear at the 2, 4, 8, and 10 o'clock positions and will flash if the AN/AVR-2 laser detecting set is not installed. This is a normal indication and does not effect system performance.

(4) A good self test (no faults detected) ends with a message "APR-39 OPERATIONAL". A bad self test (faults detected) ends with the "APR-39 FAILURE".

b. **MODE 1 Operation.** Selecting MODE ONE the operator will hear all the normal synthetic voice audio when an emitter has been processed (e. g., the AN/APR-39A(V)1 will announce; "SA, SA-18 12 O'CLOCK TRACKING"). Selection of this mode does not have any effect on emitters received, processed or displayed. It only affects synthetic voice audio.

c. **MODE 2 Operation.** Selecting MODE TWO the operator will hear abbreviated synthetic voice audio (e.g., the AN/APR-39A(V)1 will announce, "MISSILE 12 O'CLOCK TRACKING").

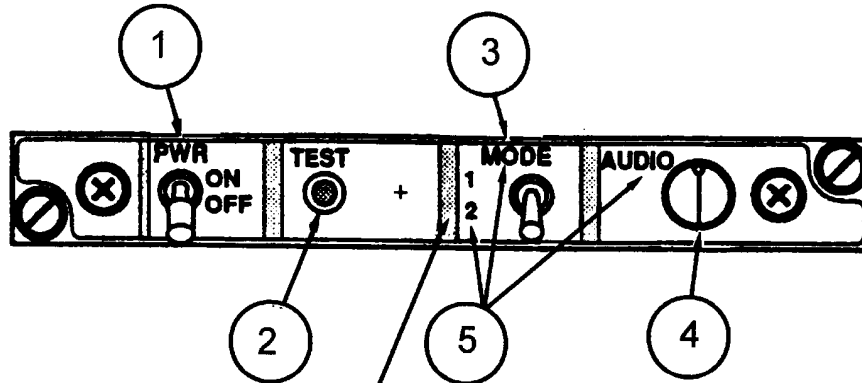

NOTE
Shading indicates
finger guards

MS019067

CONTROL/INDICATOR	FUNCTION
1. PWR Switch ON (up) OFF (down)	Two-position locking toggle switch. Provides 28vdc power for manual operation.PWR switch locks into ON position. Secures system off.Pull switch handle to release lock before attempting to set PWR switch to OFF.
2. TEST Switch	Press TEST pushbutton to start system self-test. Self-test described in paragraph 3-70.a.
3. MODE Switch: MODE 1 (up) MODE 2 (down)	Selects normal message format. Selects test (abbreviated) message format.Mode 2 reduces audio distractions when operating in dense signal environments.
4. AUDIO Control	Sets synthetic voice audio level (volume) to the aircraft ICS.Turn AUDIO control clockwise to increase volume.Turn AUDIO control counterclockwise to decrease volume.
5. Edge-Lit Panel Legends	Brightness is controlled by aircraft dimmer control.

Figure 3-17. Radar Signal Detecting Set AN/APR-39A(V)1 (Sheet 1 of 2)

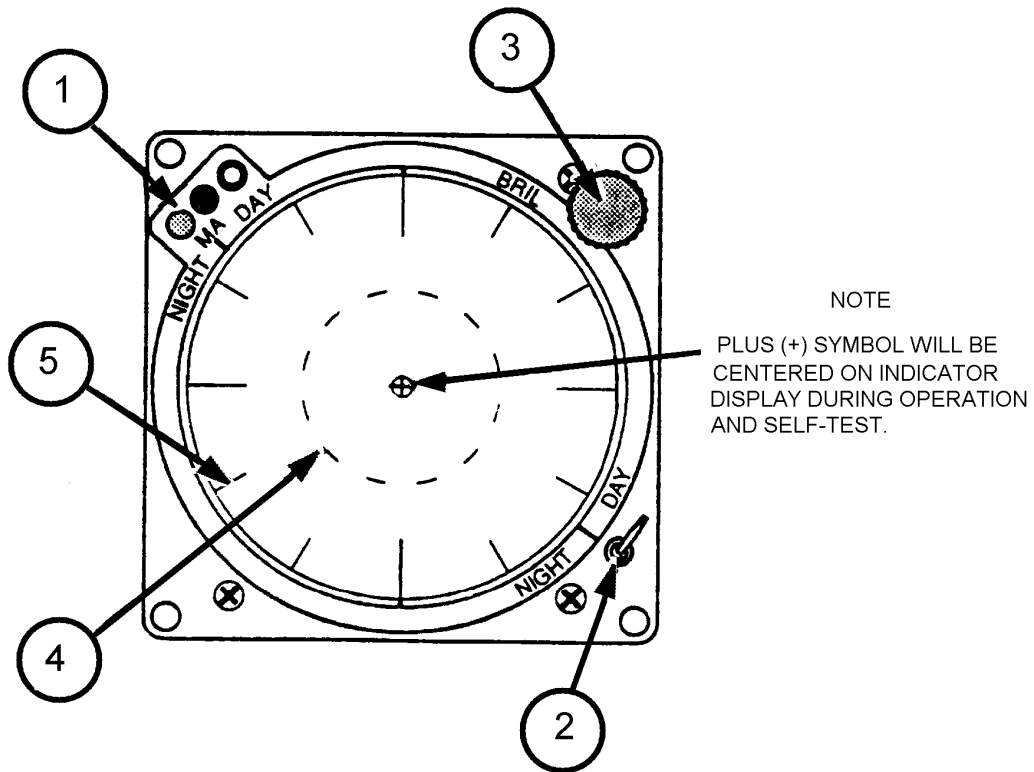

MISSILE ALERT INDICATOR / DISPLAY (AN / APR-39A (V) 1)

MS019068

CONTROL/INDICATOR	FUNCTION
1. MA Lamps	Missile Alert (MA) lamps are not used in AN/APR-39A(V)1.
2. MA Lamp Switch	MA lamps are not used in AN/APR-39A(V)1.
3. BRIL Control	Varies Indicator display brightness. Turn clockwise to increase brightness. Turn counterclockwise to decrease brightness. Adjust BRIL control for best readable display.
4. Lethality Ring	The most lethal threats are within this ring.
5. Tick Marks	At 30 degree increments, provide relative bearing reference in clock positions.

Figure 3-17. Radar Signal Detecting Set AN/APR-39A(V)1 (Sheet 2 of 2)

SECTION IV AN/ARC-201 SINGARS RADIO SET

3-71. VHF/FM RADIO SET AN/ARC-201.

3-72. DESCRIPTION – VHF/FM RADIO SET.

The An/ARC-201 VHF FM facility, consisting of a 2300 channel (approximately) radio set, an improved FM filter amplifier (IFM), FM communication antenna, and FM homing antenna, is used for point-to-point FM voice communication and station homing. The facility operates in the very high frequency range of 30,000 to 87.975 MHz in 0.025 MHz steps. The VHF FM radio set contains a multichannel, electronically tunable main receiver and transmitter, and Electronic Counter Countermeasures (ECCM). Retransmission of voice CW or X-mode communications is possible when a second radio set (AN/ARC-201) is installed. The radio sets are marked VHF FM COMM and are installed in the instrument panel center. Antenna locations are shown in figure 3-1.

3-73. CONTROLS AND FUNCTION – FM RADIO SET AN/ARC-201 & ZEROIZE SWITCH.

Refer to figure 3-7.

3-74. OPERATING PROCEDURES – FM RADIO SET AN/ARC-201 & ZEROIZE SWITCH.

a. Transmit/Receive.

- (1) FUNCTION selector switch – SQ ON.
- (2) MODE selector switch –SC.
- (3) PRESET selector switch – MAN.
- (4) IFM RF PWR selector switch – Set as required.
- (5) Frequency – Select frequency using key pad as follows:
 - (a) FREQ key – Press.
 - (b) CLR key – Press.
 - (c) Key in desired frequency.
 - (d) STO/ENT key – Press.
- (6) VOL – Adjust.

(7) Transmit. Transmit-Interphone selector position No. 1 (No. 5 for FM#2).

b. Frequency Hopping.

NOTE

To operate radio set frequency hopping mode, perform the following steps before PRESET selection:

- (1) FUNCTION selector switch – LD-V.
- (2) MODE selector switch – FH.
- (3) PRESET channel select switch – MAN. Display reads FILL T.
- (4) Connect an ECCM fill device to radio set FILL connector.
 - (a) ECCM device power switch – ON.
 - (b) Selector switch – T1.
- (5) On radio set, H-LD/O key – Press. Display reads STO T, then COLD.
- (6) On ECCM device, switch T1 to 1.
- (7) FUNCTION selector switch – LD.
- (8) H-LD/O – Press. Display reads hopset number.
- (9) STO/ENT – Press.
- (10) Key pad 1 – Press. Stores HOPSET data in PRESET 1.
- (11) Repeat steps 4 through 10 for remaining PRESET numbers 2 through 6.

NOTE

To operate Time of Day (TOD), both radios must be within 1 minute of each other in order to establish communications in steps 11 through 17.

- (12) TIME key – Press once.

- (13) CLR key – Press.
 - (a) Enter day.
 - (b) ENT key – Press.
 - (c) TIME key – Press.
 - (d) CLR key – Press.
 - (e) Enter hour
 - (f) Enter minute
 - (g) ENT key – Press.
- (14) FUNCTION selector switch – SQ OFF.
- (15) MODE selector switch FH.
- (16) PRESET selector switch 1.
- (17) Establish communications.

c. Homing.

- (1) MODE selector switch – HOM.
- (2) Frequency – Select FM Homing station frequency using key pad as follows:
 - (a) FREQ key – Press.
 - (b) CLR key – Press.
 - (c) Key in desired frequency.
 - (d) STO/ENT key – Press.
- (3) Observe homing information on the heading-radio bearing indicator.

d. Retransmission.

NOTE

Frequencies must have a minimum of 5 MHz difference, such as 30.00 MHz and 35.00 MHz.

- (1) Frequencies – Select (Both FM Sets)
- (2) Communications – Establish with each facility by selecting number 1 position and then number 5 position on Transmit-Interphone selector.
- (3) FUNCTION – selector switch – RXMT (Both FM Sets).
- (4) FUNCTION – selector switch – OFF.

e. Scanning. The RT can scan up to eight preset SC frequencies. The frequencies it can scan are the ones loaded into the presets 1–6, MAN, and CUE. When a signal is found, that channel is locked in. The RT dis-

play will show the channel number, and you can listen and talk on that channel. When the channel has been inactive for 2.5 seconds, scanning will begin again.

One of the presets can be selected to be the priority preset. The priority preset is scanned more often. The RT will transmit on the priority preset at any time just by pressing the push-to-talk on the headset.

(1) Starting Scanning.

(a) Set RT switches: FUNCTION – SQ ON; MODE – FH; PRESET – CUE. Set other switches as needed.

(b) Press STO (Sto/ENT) button on RT. The display reads: “SCAN.”

(c) Press a number, 0-8. This tells the RT which preset has priority (0 is MAN; 7 is CUE; 8 is no priority).

(2) Transmitting on a Locked-in Preset. Press push-to-talk and speak into headset. Do this within 2.5 seconds after traffic has stopped.

(3) Selecting a Preset for Transmission. Press number for channel on radio set keyboard. Press push-to-talk within 2.5 seconds after display shows preset number.

(4) Cancelling a Preset from Scan Sequence. Press number for preset on radio set keyboard, then press CLR. The priority preset cannot be cancelled. The display changes to “CLR” and preset number. Scanning begins. The cancelled preset will not lock in again.

(5) Restoring a Cancelled Preset. Press number for the cancelled preset. The display will show “CH” and preset number. The preset is now back in the scanning sequence.

(6) Starting Scanning While Locked on a Preset. Press STO (Sto/ENT) button on radio set.

(7) Checking Frequency of Locked-in Preset. Press FREQ push button on radio set while channel number is in display. The display changes to show frequency.

(8) Stopping Scanning. Set radio set PRESET switch to a different position.

3-75. ZEROIZE SWITCH.

a. Description. The zeroize switch provides the ability to zeroize all special codes contained in the AN/ARC-201, TSEC/KY-58, and TSEC/KIT-1A Computer when activated. Power must be applied to aircraft in order for the switch to function.

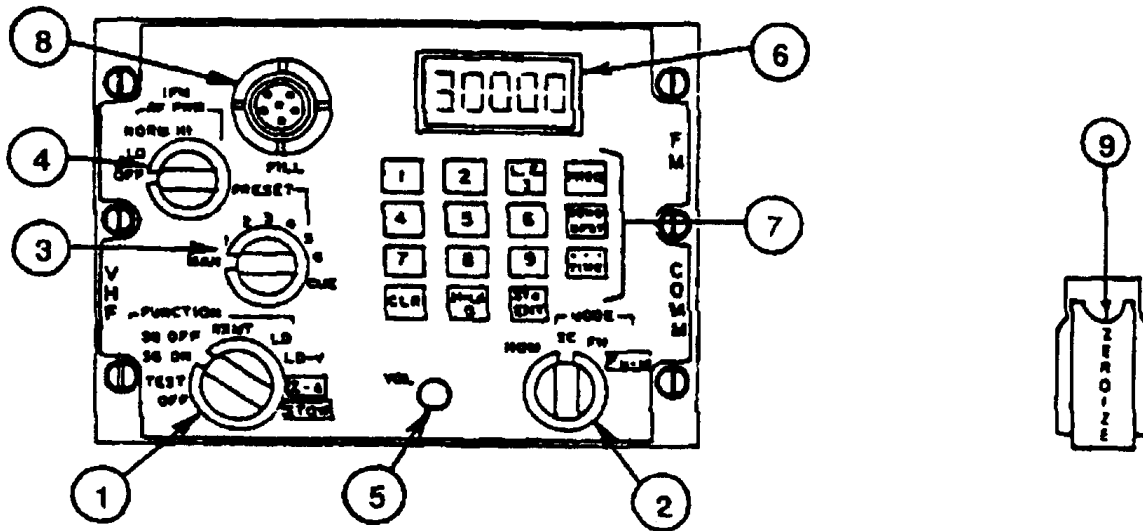

CONTROL/INDICATOR	FUNCTION
1. FUNCTION Selector	
OFF	Power off.
TEST	In this position, the major components of the Radio Set are examined to verify their operation. Results of test are presented on front panel display.
SQ ON	Receiver – On; Transmitter – Standby; Squelch – Enabled.
SQ OFF	Receiver – On; Transmitter – Standby; Squelch – Disabled.
RXMT	Activates retransmission mode when second FM set is installed.
LD	In this position, preset frequencies, time, ECCM net parameters, and lockout channels may be entered.
LD-V	In this position, TRANSEC variable is loaded into the RT.
Z-A	When activated, all ECCM TRANSEC variables are zeroized.
STOW	Completely disables all radio circuits during an extended period of inactivity such as storage.

CONTROL/INDICATOR	FUNCTION
2. MODE Selector	
HOM	Activates homing mode and display on radio bearing heading indicator. Voice communications can be conducted in this mode.
SC	Activates Single Channel mode of operation.
FH	Activates Frequency Hopping mode of operation.
FH-M	Activates Frequency Hopping-Master mode of operation.
3. PRESET Selector	
MAN	This manual position is used in SC mode to select any operating frequency.
1 through 6	In SC mode, preset frequencies are selected or loaded. In FH or FH-M mode, frequency hopping nets are selected.
CUE	Allows a non-ECCM radio to signal an ECCM radio that is in FH mode.
4. IFM RF PWR Selector	
OFF	Off (Bypass)
LO	Low Power
NORM	Normal Power
HI	High Power
5. VOL	Adjusts receiver volume.
6. Display	Indicates active frequency, Hopset numbers, Failure codes, and Key board inputs.
7. Keyboard	The keyboard is a 15–button array of pressure switches used to insert or display data.
8. Fill	This connector is used to fill ECCM parameters from an external fill device.
9. Zeroize Switch	This switch, when activated, zeroizes all codes contained in AN/ARC-201, TSEC/KY-58, and TSEC/KIT-1A Computer.

Figure 3-7. AN/ARC-201 Control Panel & Zeroize Switch.

**CHAPTER 4
MISSION EQUIPMENT**

SECTION I MISSION AVIONICS

(NOT APPLICABLE)

SECTION II ARMAMENT

(NOT APPLICABLE)

PAGES 4-2 THROUGH 4-20 (INCLUDING PARAGRAPHS 4-1 THROUGH 4-29 AND FIGURES 4-1 THROUGH 4-10) HAVE BEEN DELETED.

CHAPTER 5 OPERATING LIMITS AND RESTRICTIONS

SECTION I GENERAL

5-1. PURPOSE.

This chapter includes all important operating limits and restrictions that must be observed during ground and flight operations.

5-2. GENERAL.

The operating limitations set forth in this chapter are the direct results of design analysis, tests, and operating experiences. Compliance with these limits will allow the pilot to safely perform the assigned missions and to derive maximum utility from the helicopter.

5-3. EXCEEDING OPERATIONAL LIMITS.



Anytime an operational limit is exceeded, an appropriate entry shall be made on DA Form 2408-13-1. Entry shall state what limit or limits were exceeded, range, time beyond limits, and any additional data to aid maintenance personnel in the required inspection.

5-4. MINIMUM CREW REQUIREMENTS.

The minimum crew requirement consists of only the pilot, whose station is at the right side of the aircraft. Additional crewmembers as required will be added at the discretion of the commander, in accordance with pertinent Department of the Army regulations.

SECTION II SYSTEMS LIMITS

5-5. INSTRUMENT MARKINGS.

The operating ranges for both the helicopter and engine are listed below and shown in figure 5-1  and figure 5-2 .



NOTE

For OH-58A aircraft, reference figure 5-2 for power turbine tachometer, gas producer tachometer, torquemeter, and turbine outlet temperature.

a. Operating Limitations and Ranges. Operating limitations and ranges are illustrated by the colored markings which appear on the dial faces of engine, flight, and utility system instruments. Red markings on the dial faces of these instruments indicate the limit above or below which continued operation is likely to cause damage or shorten life. The green markings on instrument indicate the safe or normal range of operation. The yellow markings on instruments indicate the range when special attention should be given to the operation covered by the instrument. Operation is permissible in the yellow range, but is time limited. The

blue markings on instruments indicate recommended maximum IAS for autorotation. (Green areas will have a single line and yellow areas two yellow lines. This is for identification under night lighting conditions or when using night vision goggles .

b.  Limitation Markings. Limitation markings consist of strips of semi-transparent color tape which adhere to the glass outside of an indicator dial. All round instruments that have range markings on glass face must also have a white slippage mark between glass and frame. All other limitation markings are painted on dial faces under glasses.

c.  Limitation Markings. The instrument markings containing the saw tooth red line () are placed on the dial face with respect to the operating limit as shown in figure 5-2. The saw tooth edge of the red lines serves to caution the pilot that he is approaching a limit as shown in figure 5-2, Detail A. A white dot on the face of the instrument indicates the safe or normal range of operation. A chevron () indicates above or below operating limits and to go in direction of point.

NOTE

For OH-58A aircraft, reference Figure 5-2 for power turbine tachometer, gas producer tachometer, torquemeter, and turbine outlet temperature.

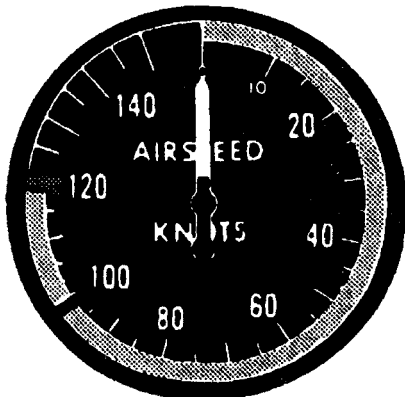

AIRSPEED

- G 0 to 120 Knots
- R 120 Knots IAS Maximum
- B 100 Knots Recommended Maximum IAS for Autorotation

Refer to Figure 5-3 for Additional Information (Airspeed Limits Chart)

Legend

RED	
YELLOW	
GREEN	
BLUE	

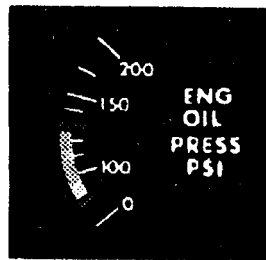

ENGINE OIL PRESSURE

- R 50 PSI Minimum

NOTE



Disregard yellow and green instrument Markings for engine oil pressure

- G Idle to 78% N1 50 to 130 PSI
- Above 78% to 89% N1 90 to 130 PSI
- Above 89% N1 115 to 130 PSI
- R 130 PSI Maximum

CAUTION



During Cold Weather Start, Maximum May Go To 150 PSI, But You Must Remain at Engine Idle Position Until Normal Limits are Attained.

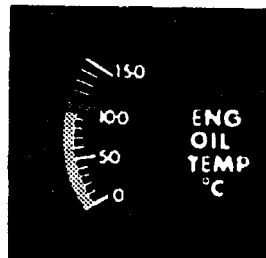

ENGINE OIL TEMPERATURE

- G 0°C to 107°C Normal Operation
- R 107°C Maximum

Legend

RED	
YELLOW	
GREEN	

NOTE

During cold weather operation the engine may be operated at engine oil temperatures down to -50° C.

MS028698

Figure 5-1. Instrument Markings **A**

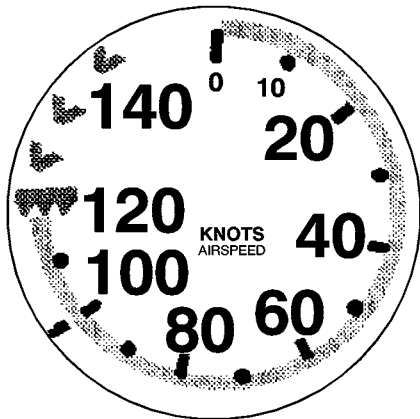

AIRSPEED **C**

- G 0 to 120 Knots Normal Operations
- R 120 Knots Maximum Refer to figure 5-3 for additional Information (AIRSPEED LIMITS).
- B 100 Knots Recommended Maximum for Autorotation

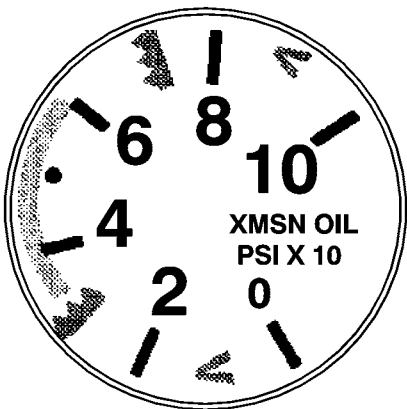

TRANSMISSION OIL PRESSURE **C**

- G 30 TO 60 PSI Normal Operation
- R 30 PSI Minimum
- R 70 PSI Maximum

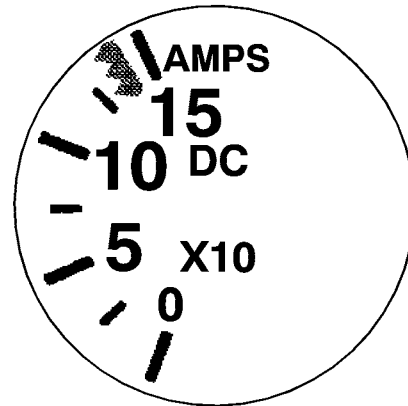

AMMETER **C**

R This Limit Mark not Applicable

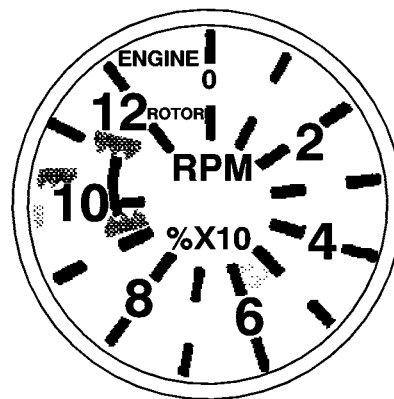

ROTOR TACHOMETER

- G 93 TO 110 Percent, Normal Operation
- Y 49% to 58% Continuous Operation Prohibited
- R 93 Percent Minimum
- R 110 Percent Maximum

ENGINE TACHOMETER

- G 98 TO 100 Percent, Normal Operation
- R 100 Percent Maximum
- 15 Second Maximum transient N2 Is 110% (Autorotation)
- Avoid Steady-State Conditions Between 78-88% N2

Legend

- Blue
- Green
- Yellow
- Red

MS026095A

Figure 5-2. Instrument Markings (Sheet 1 of 3)

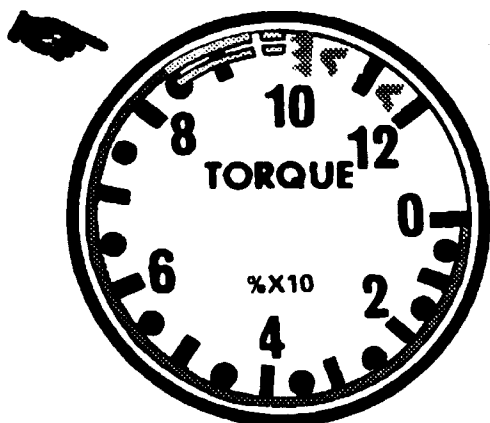

TORQUEMETER

- G 0 to 85 Percent Normal Operation
- Y 85 to 100 Percent 5 Minute Operation
- R 100 Percent Maximum

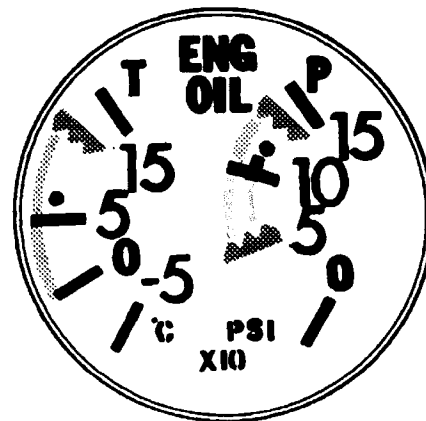

ENGINE OIL PRESSURE **C**

- R 50 PSI MINIMUM

Y NOTE

DISREGARD yellow and green instrument markings for engine oil pressure.

- G Idle to 78%N1 50-130 PSI
Above 78% to 89%N1 90-130 PSI
Above 89%N1 115-130 PSI

- R 130 PSI MAXIMUM

CAUTION

During cold weather start, maximum may go to 150 PSI, but you must remain at engine idle position until normal limits are attained.

ENGINE OIL TEMPERATURE

- G 0 °C to 107°C Continuous Operation
- R 107 °C Maximum

NOTE

During cold weather operation the engine may be operated at engine oil temperatures down to -50 °C.

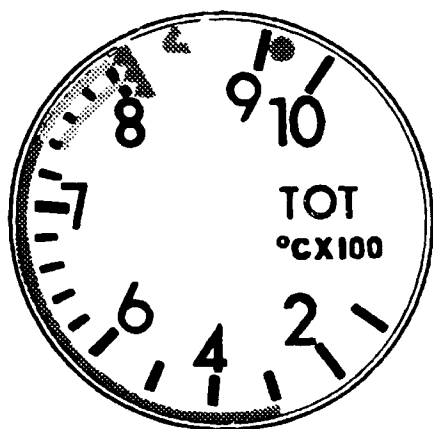

TURBINE OUTLET TEMPERATURE INDICATOR STARTING

- 0°C to 810°C Normal
- Above 810° to 927°C Maximum 10 Seconds

- R 927°C Maximum 1 Second

CONTINUOUS OPERATION

- 300°C Minimum
- G 300°C to 738°C Normal Operation
- Y Above 738°C to 810°C 30 Minutes Limit
- R 810° C Maximum. Above 810°C to 843°C during power transient, 6 seconds maximum.

Legend

- RED
- YELLOW
- GREEN

MS019069

Figure 5-2. Instrument Markings (Sheet 2 of 3)

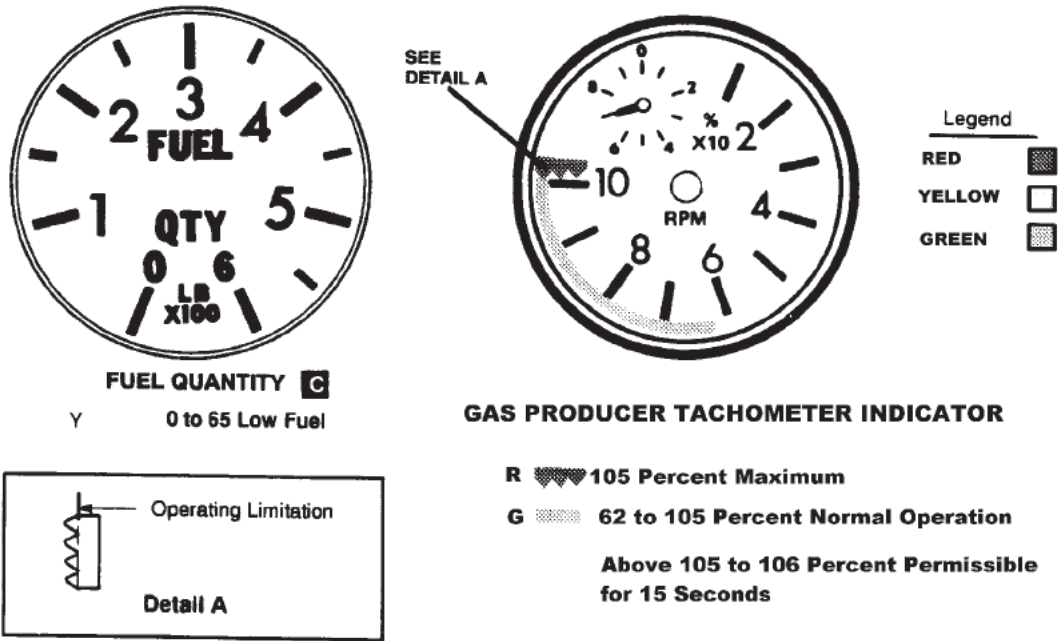

MS019151

Figure 5-2. Instrument Markings (Sheet 3 of 3)

5-6. TRANSMISSION OIL TEMPERATURE LIMITS.

110°C - Warning Light On.

5-7. TRANSMISSION OIL PRESSURE LIMITS.

30 ± 2 PSI MINIMUM — Warning Light On.

NOTE

Light will remain on until 36 psi is exceeded.

☐ Refer to figure 5-2 for transmission oil pressure limits.

5-8. WIND LIMITATIONS.

a. The helicopter can be started in a maximum wind velocity to 45 knots and a maximum gust spread of 15 knots.

NOTE

Gust spreads are not normally reported. To obtain spread, compare minimum and maximum wind velocities.

b. Maximum wind for hovering is 35 knots cross-wind and 30 knots tailwind.

c. Maximum wind for mooring is 65 knots parallel to the ground in any direction.

5-9. DELETED.

5-10. TOWING LIMITATIONS.

The maximum gross weight for towing the helicopter is 3000 pounds on prepared or unprepared surfaces.

SECTION III POWER LIMITS

5-11. ENGINE LIMITATIONS.

Refer to figure 5-1, figure 5-2. If N2 limit is exceeded, entry on DA Form 2408-13-1 must include duration and torque indicated.

25 seconds ON	40 seconds ON
30 seconds OFF	60 seconds OFF
25 seconds ON	40 seconds ON
30 minutes OFF	30 minutes OFF

5-12. FUEL OPERATION LIMITS.

a. JP-4. No restrictions are imposed when JP-4 fuel is used.

b. JP-5, JP-8, Jet A and Jet A-1. Operations with these fuels are restricted to ambient temperatures of -32°C (-25°F) and above. If fuel other than JP-4 is used, a deceleration check must be performed prior to first flight of the day. If autorotations are to be performed, a deceleration check will be done prior to each flight. Refer to paragraph 8-18.

NOTE

Engine starting difficulties may be encountered if any fuel other than JP-4 is used at ambient temperatures below +5°C (+39°F).

c. Emergency Fuel Aviation Gasoline (MIL-G-5572) without Tricresyl Phosphate (TCP).

(1) The helicopter shall not be flown when emergency fuel has been used for a total accumulated time of 6 hours. Entry in remarks section of DA Form 2408-13-1 is required for each time emergency fuel is used.

(2) Practice autorotation is prohibited using emergency fuel.

5-13. STARTER LIMITS.

a. Starter Engine Time — If rise in TOT does not occur during the first 20 seconds, starter engage is limited to the following times:

EXTERNAL POWER	BAT POWER
25 seconds ON	40 seconds ON
30 seconds OFF	60 seconds OFF

b. Starter Engine Time — If rise in TOT occurs during the first 20 seconds, starter engage time is limited to the following times:

EXTERNAL/BAT POWER

1 minute ON
1 minute OFF
1 minute ON
1 minute OFF
1 minute ON
30 minute OFF

5-14. ENGINE STARTING LIMITATIONS.

During starting if N1 does not reach 58 percent in a total time of 45 seconds (or 60 seconds below 10°C FAT), simultaneously, continue to press and hold starter switch until TOT is less than 200°C and close throttle.

5-15. HEALTH INDICATOR TEST (HIT).

HIT is the method by which the aviator in day-to-day flying monitors aircraft engine condition. This is accomplished by the aviator selecting N1 speed (%) predicted upon the existing FAT. The TOT must then be compared to predicted value (Baseline TOT) within a certain tolerance. TOT variation from baseline values are logged by the aviator. This log is part of aircraft records and is an aid maintenance personnel in monitoring performance trends and troubleshooting the engine. When the difference between recorded and baseline TOT is ± 20°C or greater, an entry on DA Form 2408-13-1 will be made to notify maintenance. Limits for grounding are ± 40°C.

5-16. HOVERING LIMITATIONS.

Refer to paragraph 5-24.

SECTION IV LOAD LIMITS

5-17. CENTER OF GRAVITY LIMITATIONS.

Maintain the aircraft within the limits in the center of gravity limitation charts in Chapter 6.

5-18. WEIGHT LIMITATIONS.

Maximum gross weight is 3200 pounds.

SECTION V AIRSPEED LIMITS

5-19. AIRSPEED LIMITS.

- a. Refer to speed operating limits chart (figure 5-3) for forward airspeed limits.
- b. Sideward flight limits are 35 knots.
- c. Rearward flight limits are 30 knots.
- d. Recommend maximum indicated airspeed for autorotation is 100 knots.
- e. Maximum indicated air speed with any door removed is 100 knots.

5-19.1. DELETED.

5-20. COCKPIT AND CABIN DOOR RESTRICTIONS.

a. Helicopter will not be flown without cabin doors unless heavy duty rear electronics compartment soundproof blanket (P/N 206-070-893-7), or its approved equivalent, has been installed. Helicopter will not be flown with only one cockpit door or one cabin door removed.

b. Whenever any OH-58A/C helicopter is operated without its cabin doors:

(1) All soundproof blankets must be in serviceable condition and firmly attached. Pilot must verify.

(2) If the rear cushions (bottom and back) are modified per MWO 55-1520-228-30-30, they may remain installed provided seat belts and shoulder harnesses are installed, properly fastened and tightened.

(3) Loose equipment or components must be removed or secured.

c. Doors shall not be opened in flight.

5-21. **A** FLIGHT RESTRICTION WITH FLOAT LANDING GEAR INSTALLED.

a. **Airspeed Limit.** Float landing gear installed - Rearward and sideward airspeed limit is 30 knots. Figure 5-3.

b. **Altitude Limitation.**

(1) Maximum operating - 15,000 feet altitude.

(2) Flight to lower altitude - increase pressure 0.5 PSI per 1000 feet below base altitude, to minimum operating altitude.

(3) Flight to higher altitude - Limit climbing flight to 8000 feet differential pressure altitude. Above 8000 feet differential pressure altitude, reduce float pressure 0.5 PSI per 1000 feet.

AIRSPEED OPERATING LIMITS

**AIRSPEED
OPERATING
LIMITS**
 OH-58A/C
 T63-A-720

EXAMPLE

WANTED

MAXIMUM INDICATED AIRSPEED

KNOWN

PRESSURE ALTITUDE = 7500 FEET
FAT = +20°C

METHOD

ENTER PRESSURE ALTITUDE HERE
MOVE RIGHT TO FAT
MOVE DOWN TO CONFIGURATION.
SEE NOTE
MOVE LEFT, READ MAXIMUM
INDICATED AIRSPEED = 99 KNOTS

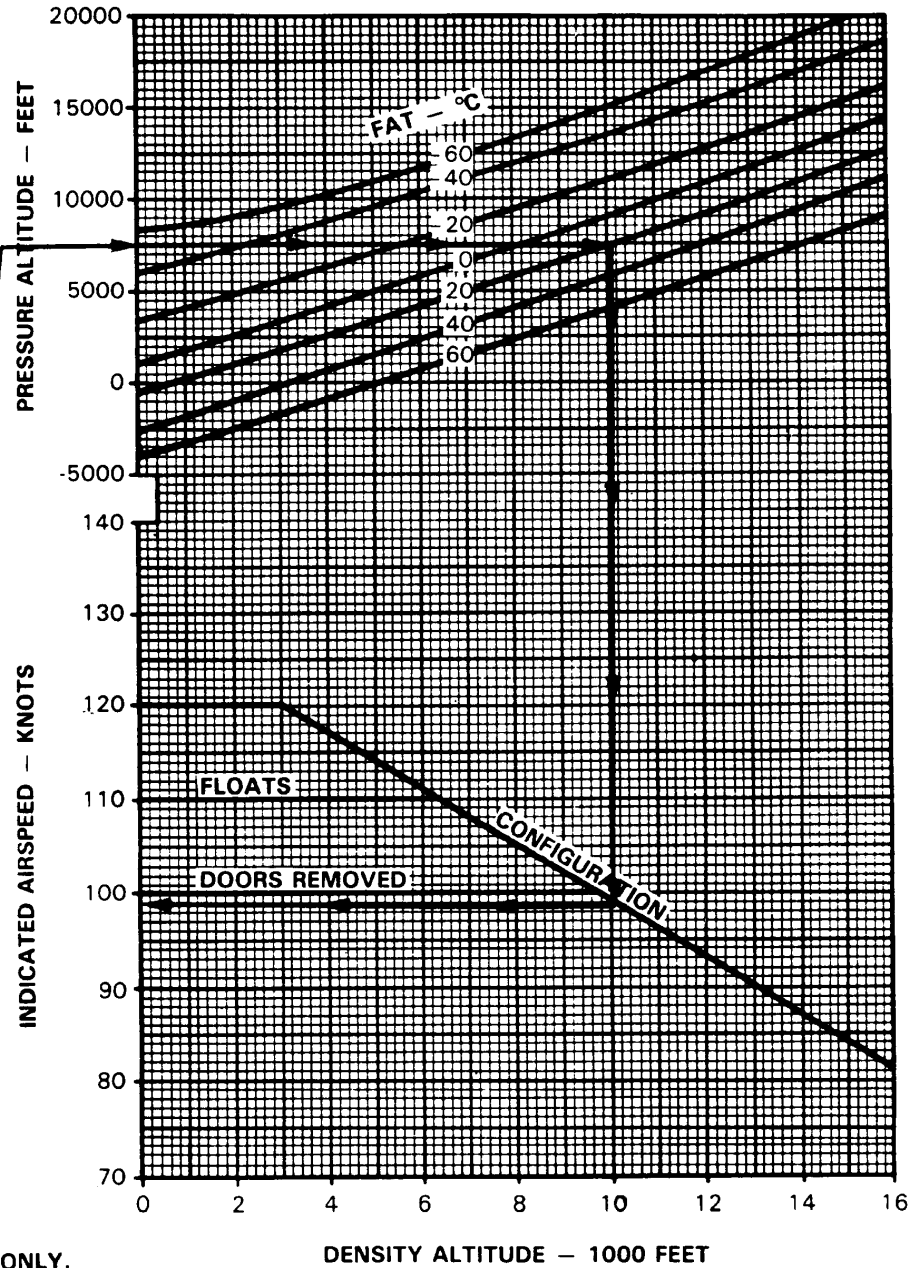

NOTE
 FLOATS CONFIGURATION IS **A** ONLY.
 DATA BASIS: DERIVED FROM BELL HELICOPTER TEXTRON FLIGHT TEST

MS019070

Figure 5-3. Airspeed Operating Limits Chart

SECTION VI MANEUVERING

5-22. AEROBATIC MANEUVERS.

Aerobatic maneuvers are prohibited. Aerobatic flight is defined to be any intentional maneuver involving an abrupt change in aircraft attitude, an abnormal attitude, pitch angle greater than $\pm 30^\circ$ or roll angles greater than 60° , or abnormal acceleration not necessary for normal flight.

5-23. CONTROL MOVEMENTS.



For gross weights greater than 3000 lbs. and density altitudes greater than sea level, the directional control margin may be significantly reduced while hovering in winds from the right greater than 20 knots or for right sideward flight at speed greater than 20 knots.

5-24. HOVERING LIMITATIONS.

Ten percent of total pedal travel, full right to full left, is considered adequate for safe control. The rearward airspeed limit is 30 knots and sideward limit is 35 knots except that control is marginal for certain combinations of relative wind velocity and azimuth angles (measured clockwise from the nose of the helicopter). See Chapter 8 for a description of the marginal wind velocity and azimuth angles.

5-25. FLIGHT RESTRICTIONS AT LOW "G'S".

Flight at less than +0.5g is prohibited.

5-26. FLIGHT RESTRICTIONS FOR PRACTICE AUTOROTATION LANDINGS. (FIGURE 5-4.)

- a. A qualified OH-58A/C IP must be in position to take control of the aircraft.
- b. Reported surface winds must not exceed 20 knots.

- c. Surface crosswind component must not exceed 10 knots. Wind gust spread must not exceed 10 knots.

- d. Touchdown rotor RPM must not be less than 64%.

- e. Ground speed at touchdown should be approximately 5 knots.

- f. Airspeed during glide shall not be less than that established for minimum rate of descent.



In any event, relatively long ground runs with the collective up, or any tendency to float for long distance prior to skid contact should be avoided. If vibrations are encountered after touchdown immediate lowering of the collective is recommended.

- g. Upon ground contact, collective pitch must be reduced smoothly to bottom stop without delay while maintaining cyclic pitch near center position. Application of aft cyclic should be avoided.

- h. Touchdown autorotations downwind are prohibited.

5-27. DELETED.

5-28. FLIGHT RESTRICTION FOR HIGH POWER.

NOTE

In aircraft equipped with IR exhaust stacks, rate of climb in excess of 1000 ft/min may result in divergent aircraft pitch oscillation which can reach 20 to 30 degree attitudes. This divergence can be alleviated by either increasing airspeed during steady climbs or decreasing rate of climb. Climb rates in excess of 1000 ft/min should be avoided.

EXAMPLE

WANTED

CROSSWIND COMPONENT

KNOWN

WIND VELOCITY = 17 KNOTS
 CROSSWIND DIRECTION (RELATIVE TO TOUCHDOWN HEADING) = 20°

METHOD

ENTER WIND VELOCITY HERE
 FOLLOW 17 KNOTS CURVE TO CROSSWIND DIRECTION. FROM THAT POINT MOVE DOWN, READ CROSSWIND COMPONENT = 6 KNOTS

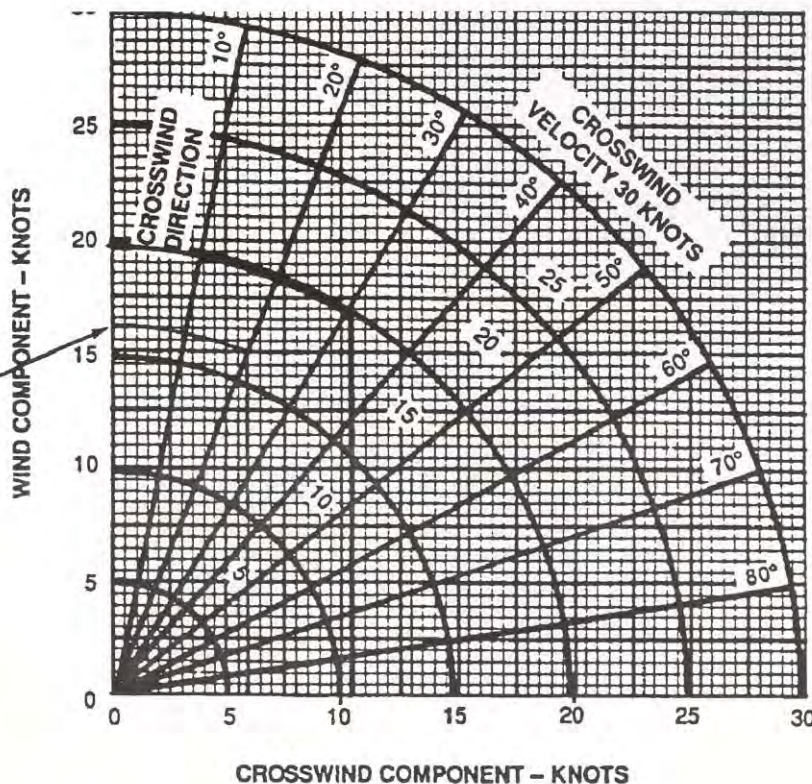

Figure 5-4. Practice Autorotation Landing Limits Crosswind Components

5-28.1. SLOPE LANDING/TAKE-OFF LIMITATIONS.

Slope Operations shall be limited to slopes of 8 degrees or less.

Caution is to be exercised for slopes greater than 5 degrees since rigging, loading, terrain and wind conditions may alter the slope landing capability. See Rollover characteristics in FM 1-203.



SECTION VII ENVIRONMENTAL RESTRICTIONS

5-29. FLIGHT UNDER INSTRUMENT METEOROLOGICAL CONDITIONS (IMC).

This aircraft is restricted to visual flight conditions. Flight into instrument meteorological conditions will be conducted on an emergency basis only.

5-30. FLIGHT RESTRICTIONS IN FALLING OR BLOWING SNOW.

Flight in falling or blowing snow is prohibited except for those helicopters with reverse flow inlet fairing installed. Helicopters having the above features may be flown in falling or blowing snow provided reverse flow inlet fairings are installed and the following criteria is met.

- a. Visibility reduced by snow must be at least 1/2 mile.
- b. Prior to initial takeoff and each subsequent takeoff, inspect the engine as specified in Chapter 8, Section V, paragraph 8-34.

- (1) Deleted.
- (2) Deleted.
- (3) Deleted.

5-31. FLIGHT OVER SALT WATER.



Prolonged hovering over salt water which results in spray ingestion, indicated by spray on the windshield, should be avoided.

Salt spray ingestion in turbine engines may result in a deterioration in performance as well as a loss in compressor stall margin. When operating within 10 miles of salt water or within 200 miles of volcanic activity appropriate entries should be made on DA Form 2408-13-1 to alert maintenance.

5-32. FLIGHT IN SAND AND DUST CONDITIONS.

During operations in heavy sand or dusty conditions without the new improved nozzles will result in lower inlet particle separator (IPS) efficiency which in turn severely shortens the engine life.

5-32-1. FLIGHT IN RAIN, SNOW AND ICING CONDITIONS.

If flown in rain, snow or icing conditions, appropriate entries should be made on DA Form 2408-13-1 to alert maintenance.

5-33. TURBULENCE LIMITATIONS.

- a. Intentional flight into severe or extreme turbulence is prohibited.
- b. Intentional flight into moderate turbulence is not recommended when report or forecast is based on aircraft above 12,500 pounds gross weight.
- c. Intentional flight into thunderstorms is prohibited.

CHAPTER 6 WEIGHT/BALANCE AND LOADING

SECTION I GENERAL

6-1. GENERAL.

Chapter 6 contains sufficient instructions and data so that an aviator knowing basic weight and moment of the helicopter can compute any combination of weight and balance.

6-2. CLASSIFICATION OF HELICOPTER.

Army Model OH-58A/C is in Class 2. Additional directives governing weight and balance of Class 2

aircraft forms and records are contained in AR 95-1, TM 55-1500-342-23 and DA PAM 738-751.

6-3. HELICOPTER STATION DIAGRAM.

Figure 6-1 shows the helicopter reference datum lines, fuselage stations, buttlines and waterlines. The primary purpose of the figure is to aid personnel in the computation of helicopter weight/balance and loading.

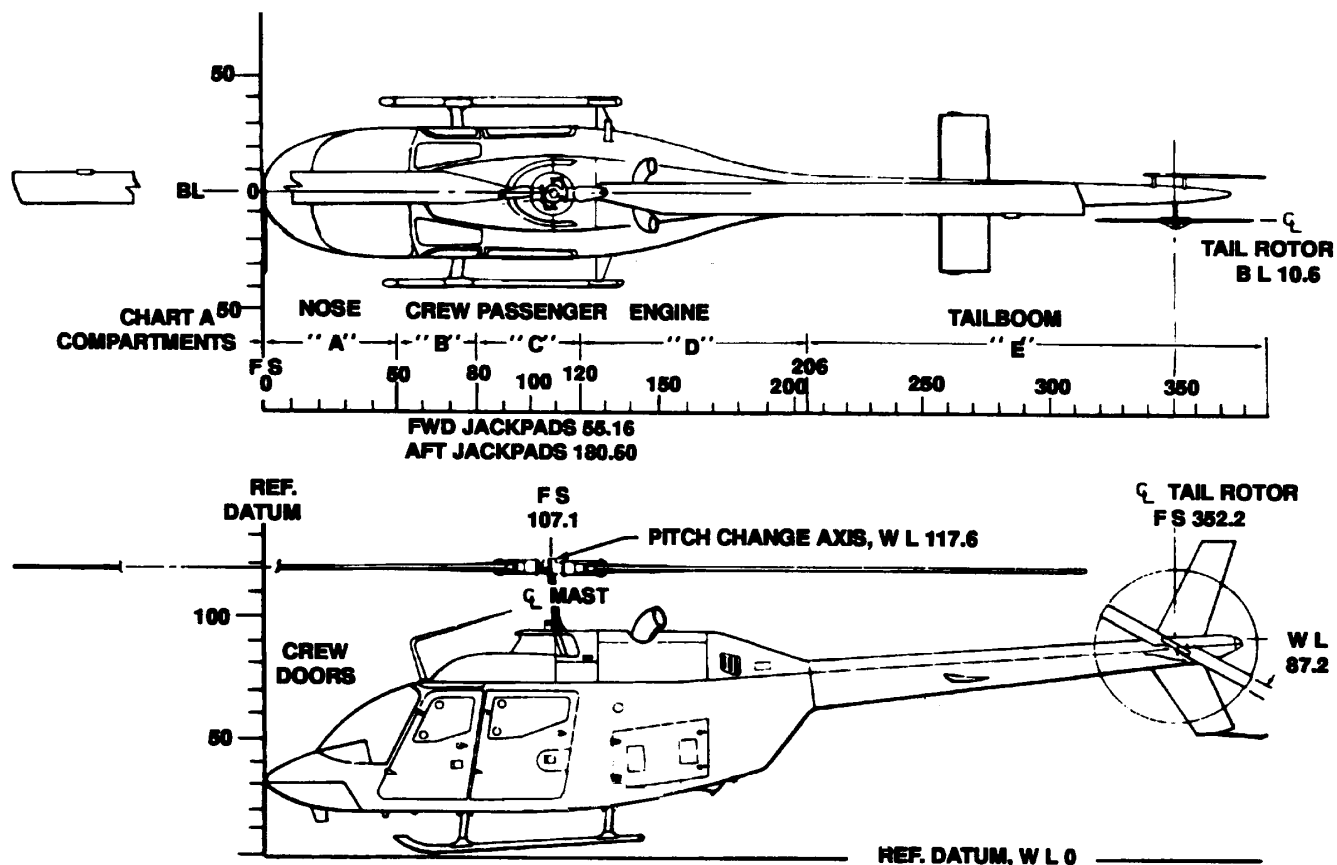

MS019071

Figure 6-1. Helicopter Station Diagram

6-4. LOADING CHARTS.

a. Information. The loading data contained in this chapter is intended to provide information necessary to work a loading problem for the helicopters to which this manual is applicable.

b. Use. From the figures contained in this chapter, weight and moment are obtained for all variable load items and are added to the current basic weight and moment (DD Form 365-3) to obtain the gross weight and moment.

6-5. CENTER OF GRAVITY LIMIT CHART (FIGURE 6-2).

a. The gross weight and moment are checked on figure 6-2 to determine the approximate center of gravity (cg).

b. The effect on cg by expenditures in flight of such items as fuel, etc., may be checked by subtracting the weights and moments of such items from the takeoff weight and moment and checking the new weight and moment on the center of gravity limit chart.

c. If the weight and moment lines intersect between the forward and aft limit lines, the helicopter is within flight limits.

NOTE

This check should be made to determine whether or not the cg will remain within limits during the entire flight.

6-6. CARGO SPACE (FIGURE 6-3).

The cargo space chart provides information necessary to ensure that maximum cargo weight does not exceed the amount specified for different helicopter configurations.

NOTE

Cargo space chart is used in conjunction with figure 6-1 and figure 6-2 to compute parameters of the loading charts contained in this chapter.

6-7. CARGO PLATFORM.



TO prevent damage to floor of cabin, no cargo will be placed on floor of helicopter. The cargo platform will be installed whenever cargo is to be carried.

The cargo platform will be installed in the cabin for cargo handling. The platform is a two-piece construction of plywood sheeting. Provisions are made for mounting to

existing fuselage hardware. The strength of the cargo tiedowns on the cargo platform is 2100 pounds.

6-7.1. CARGO RESTRAINT CRITERIA.

The amount of restraint that must be used to keep the cargo from moving in any direction is called the "restraint criteria" and is usually expressed in units of force of gravity, of G's. Following are the units of the force of gravity of G's needed to restrain cargo in four directions:

Direction	Cargo
Forward	8 G's
Rear	8 G's
Lateral	4 G's
Vertical	8 G's (up) 8 G's (down)

6-8. FUEL LOADING CHART (FIGURE 6-4).

The purpose of the fuel loading chart is to provide moment/100 for varying quantity (gallons and/or weight in pounds) for either JP-4, JP-5, or JP-8 fuel.

NOTE

Auxiliary tank in the passenger area.

a. For a given weight of fuel there is only a very small variation in fuel moment with change in fuel specific weight. Fuel moments should be determined from figure 6-4. Use the scale for the specific weight closest to that of the fuel being used.

b. The full tank usable weight will vary depending upon fuel specific weight. The aircraft fuel gage system was designed for use with JP-4, but does tend to compensate for other fuels and provide acceptable readings. When possible the weight of fuel onboard should be determined by direct reference to the aircraft fuel gages.

c. The following information is provided to show the general range of fuel specific weights to be expected. Specific weight of fuel will vary depending on fuel temperature. Specific weight will decrease as fuel temperature rises and increase as fuel decreases at the rate of approximately 0.1 lb/gal for each 15 degrees centigrade change. Specific weight may also vary between lots of the same type fuel at the same temperature by as much as 0.5 lb/gal. The following approximate fuel specific weights at 15 degrees centigrade may be used for most mission planning:

FUEL TYPE	SPECIFIC WEIGHT
JP-4	6.5 LB/GAL

— Continued

FUEL TYPE	SPECIFIC WEIGHT
JP-5	6.7 LB/GAL
JP-8	6.7 LB/GAL

CENTER OF GRAVITY LIMITS

EXAMPLE

WANTED

DETERMINE APPROXIMATE CENTER OF GRAVITY FOR KNOWN WEIGHT AND MOMENT

KNOWN

GROSS WEIGHT = 2850
MOMENT/100 = 3150 POUNDS

METHOD

MOVE RIGHT FROM 2850 POUNDS TO 3150 IN-LB DIAGONAL LINE. FROM THIS POINT MOVE DOWN TO READ 110.5 ON CENTER OF GRAVITY SCALE

NOTE

SHADED AREA IS OUT OF C. G. LIMITS

NOTE

FORWARD C.G. LIMITS :

1. UP TO 2500 lb G.W. FWD LIMIT IS STA. 105.2.
2. FROM 2500 lb G.W. TO 3000 lb G.W. THE LIMIT MOVES AFT LINEARLY FROM STA. 105.2 TO STA. 106.0
3. FROM 3000 lb G.W. TO 3200 lb G.W. THE FWD LIMIT MOVES AFT LINEARLY FROM STA. 106.0 TO STA. 107.0

AFT C.G. LIMITS:

1. UP TO 2500 lb G.W., AFT LIMIT IS STA. 114.2
2. FROM 2500 lb G.W. TO 3000 lb G.W., THE AFT LIMIT MOVES FWD LINEARLY FROM STA. 114.2 TO STA. 112.2
3. FROM 3000 lb G.W. TO 3200 lb G.W., THE AFT LIMIT MOVES FWD LINEARLY FROM STA. 112.2 TO STA. 111.4

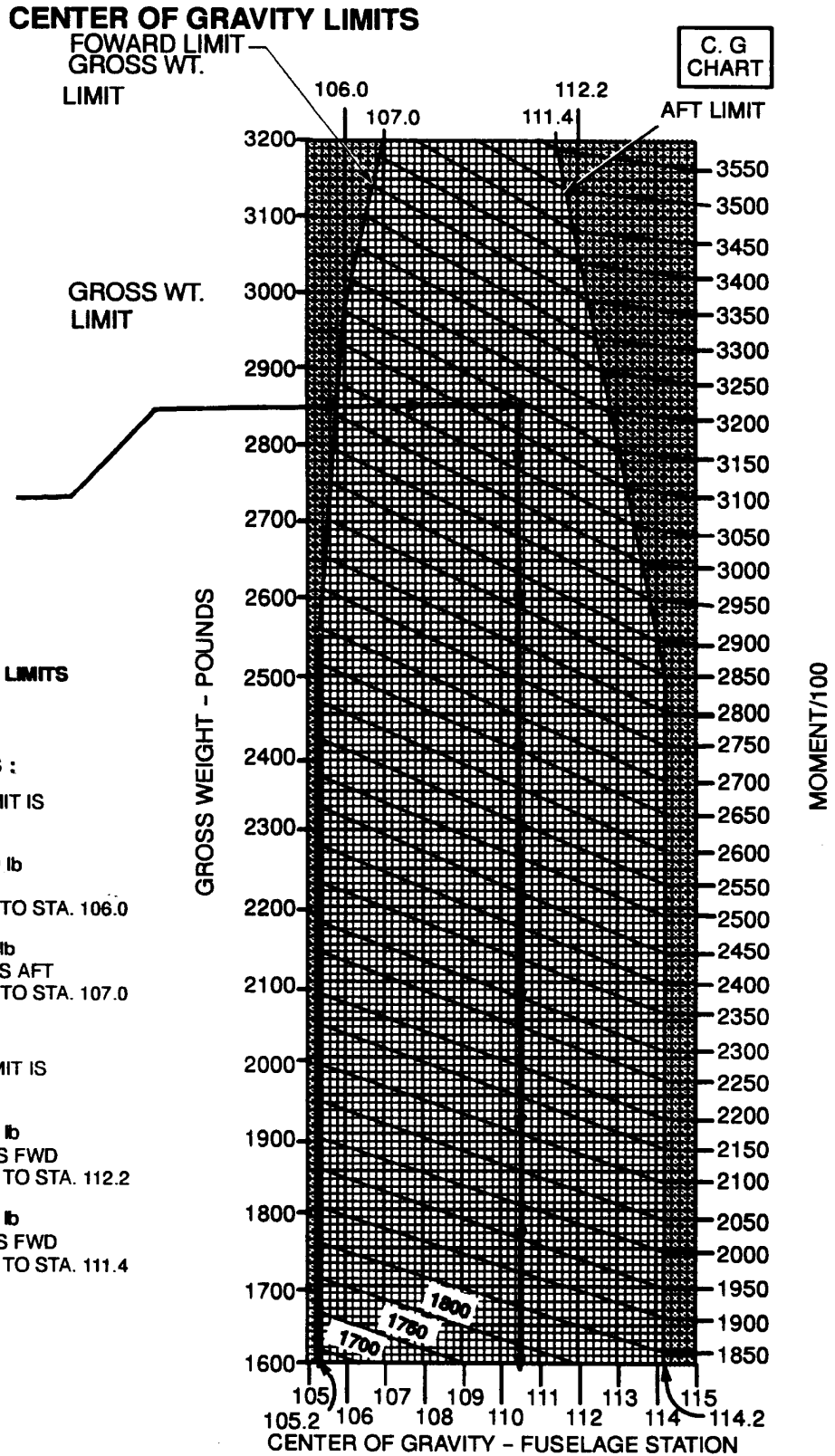

MS019072

Figure 6-2. Center of Gravity Limit Chart

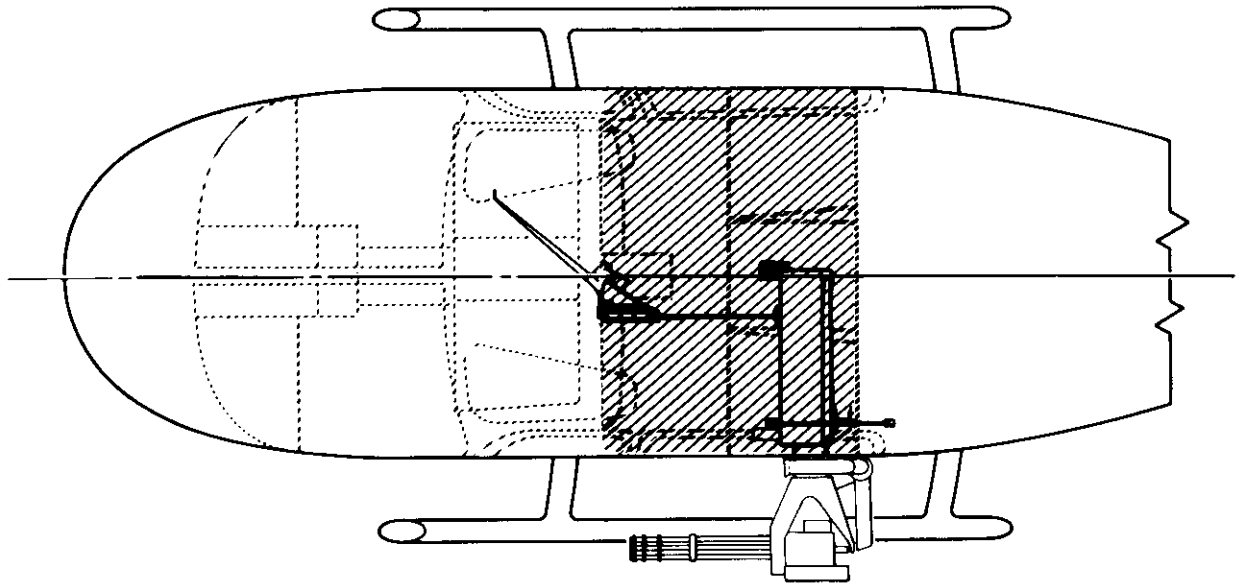

VIEW LOOKING DOWN

 Total maximum cargo weight is 950 pounds not exceeding 100 pounds per sq. ft.

CAUTION

No cargo shall be carried in the avionics compartment.

Maximum single box cargo size, unarmed configuration, is 33.0 x 23.4 x 44.0 inches. Maximum cargo size either side of canted center post is 33.0 x 27.5 x 18.5 inches.

The M27 armament system weight shall be included in the maximum allowable cargo weight when installed **A**

MS026098

Figure 6-3. Cargo Space

EXAMPLE

WANTED

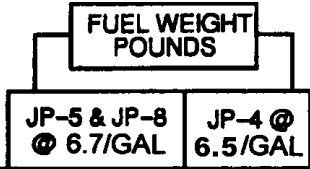

11

MOMENT FOR KNOWN FUEL QUANTITY



KNOWN

QUANTITY - 50 GALLONS (325LBS JP-4)

METHOD

MOVE RIGHT FROM 325 LBS ON JP-4 SCALE TO INTERSECT JP-4 DIAGONAL CURVE

MOVE DOWN FROM THE POINT TO READ 370 ON THE MOMENT/100 SCALE

FULL USEABLE FUEL VOLUME = 70.3 GALLONS

FULL USEABLE FUEL ARM = 117 INCHES

FULL FUEL MOMENT WILL VARY, AS IT IS A FUNCTION OF FUEL DENSITY

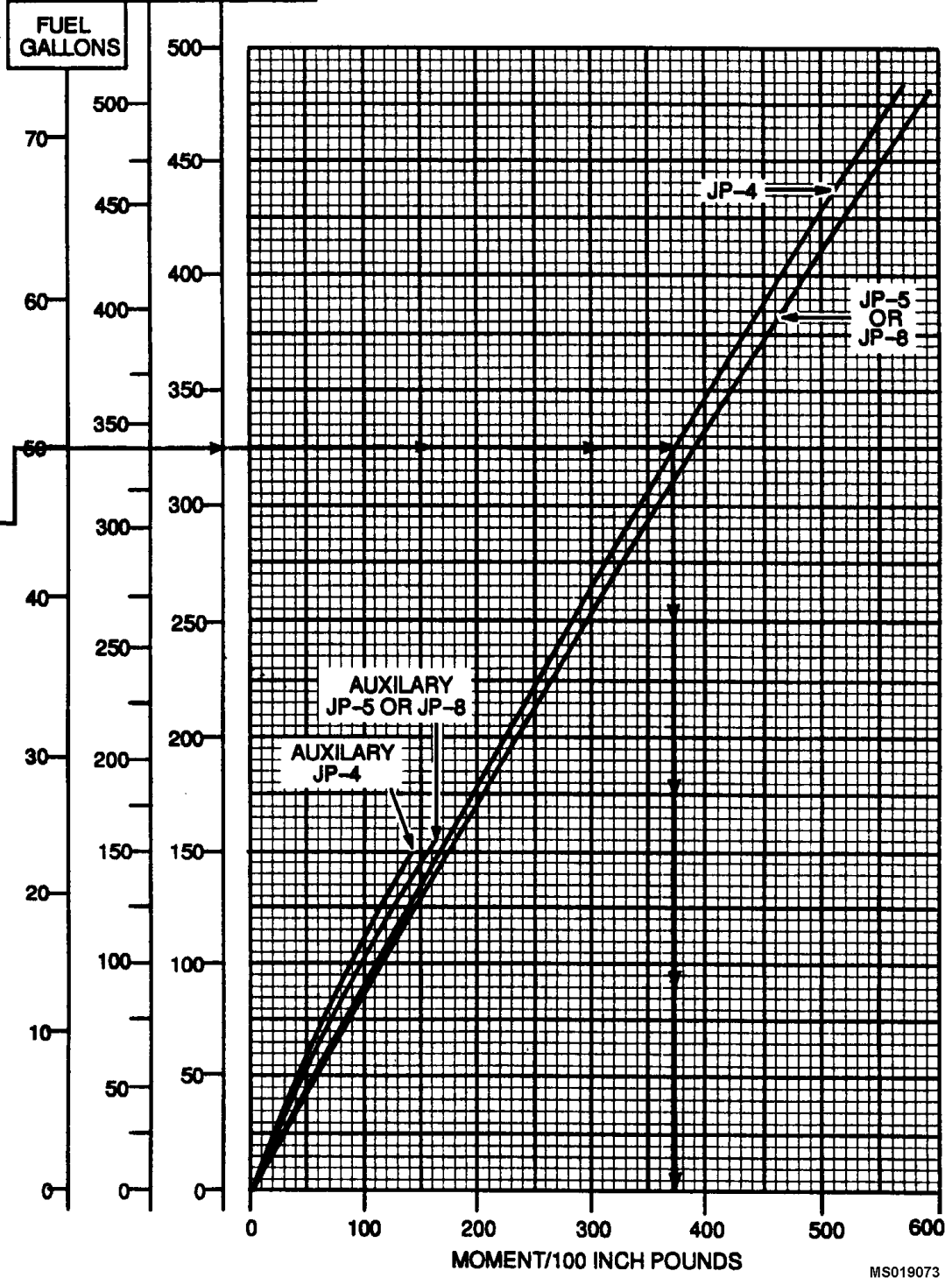

MS019073

Figure 6-4. Fuel Loading Chart

SEATING ARRANGEMENT

- 1 2 1 PILOT OR COPILOT
- 1 2 2 PASSENGERS

EXAMPLE :

WANTED
PERSONNEL MOMENT FOR
ONE PASSENGER

KNOWN
PERSONNEL WEIGHT OF
200 POUNDS IN BACK SEAT

METHOD
MOVE RIGHT FROM 200 POUNDS
TO BACK SEAT LINE.
MOVE DOWN TO READ 208 ON
MOMENT/100 SCALE

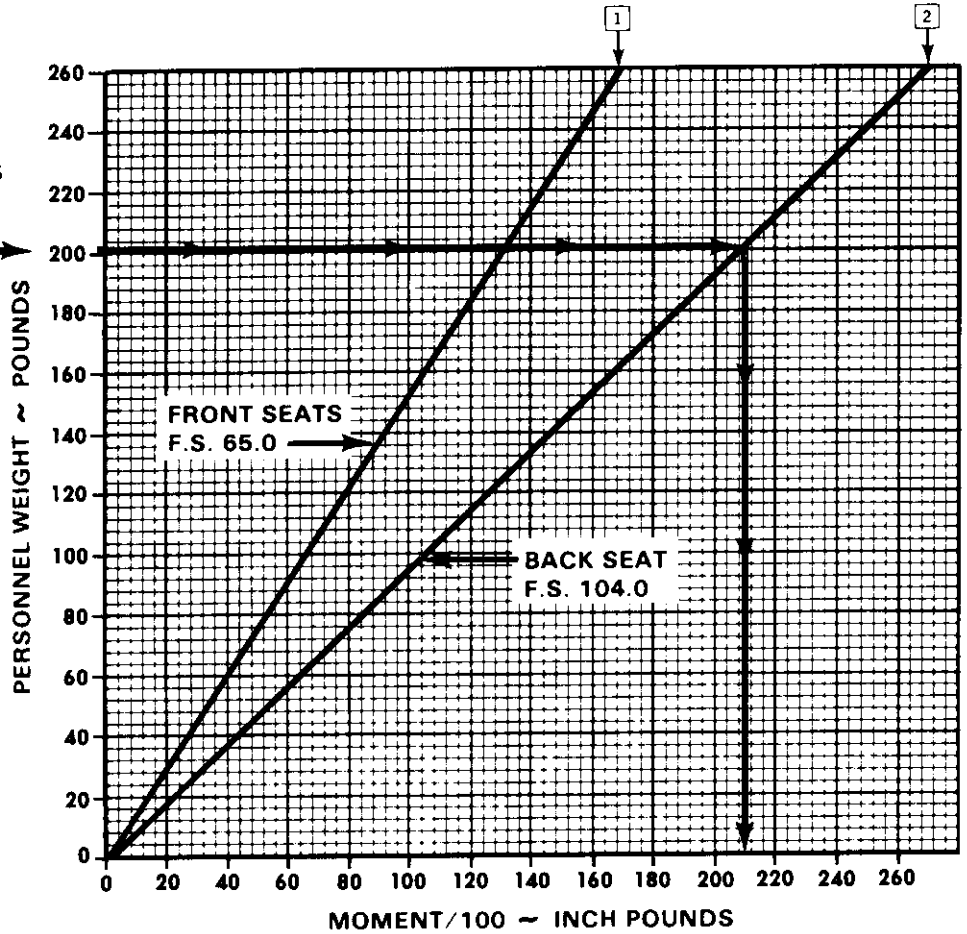

MS026058

Figure 6-5. Personnel Loading

6-9. OIL DATA.

For weight and balance purposes, engine oil is part of aircraft basic weight.

6-10. PERSONNEL LOADING (FIGURE 6-5).

Refer to figure 6-5, to compute pilot, copilot/observer and passenger moments.

NOTE

When helicopter is operated at critical gross weights, the exact weight of each individual occupant plus equipment should be used. If weighting facilities are not available, or if the tactical situation dictates otherwise, loads shall be computed as follows:

a. Combat equipped soldiers; 240 lbs. per individual.

b. Combat equipped paratroopers; 260 lbs. per individual.

c. Crew and passengers with no equipment: compute weight according to each individual's estimate.

6-11. DELETED.

6-12. DELETED.

6-12.1. DELETED.

6-13. CARGO MOMENT.

Refer to Cargo Moment Chart, figure 6-8, for computing cargo weight and balance information.

CARGO LOADING

CARGO PLATFORM
WEIGHS 32 POUNDS
WITH A MOMENT/100
OF 30

EXAMPLE

WANTED

CARGO MOMENT

KNOWN

CARGO WEIGHT = 350 POUNDS

METHOD

MOVE RIGHT FROM 350 TO DIAGONAL LINE.
THEN MOVE DOWN AND READ 325 ON THE
MOMENT SCALE.

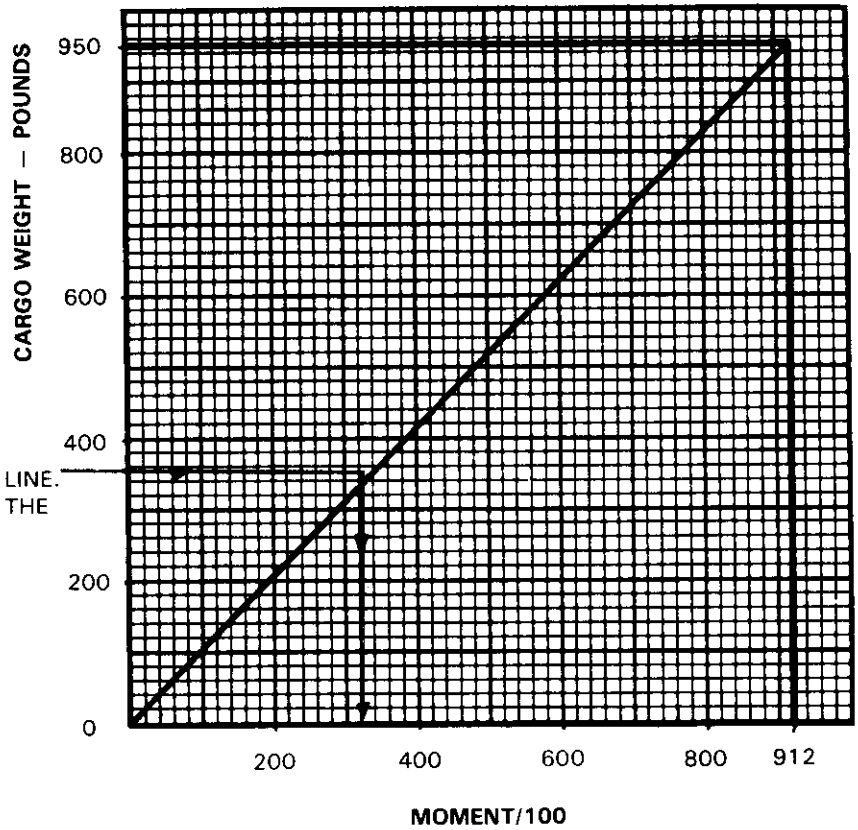

MS026099

Figure 6-8. Cargo Moment Chart

SECTION II DD FORM 365

6-14. DD FORM 365-1 – BASIC WEIGHT CHECK LIST.

The form is a tabulation of equipment that is, or may be, installed and for which provision for fixed stowage has been made in a definite location. The form gives the weight, arm, and moment/100 of individual items for use in correcting the basic weight and moment on DD Form 365-3 as changes are made in this equipment.

6-15. DD FORM 365-3 – BASIC WEIGHT AND BALANCE RECORD.

The form is a continuous history of the basic weight and moment resulting from structural and equipment

changes. At all times the last entry is considered current weight and balance status of the basic helicopter.

6-16. DD FORM 365-4 – WEIGHT AND BALANCE CLEARANCE FORM F.

The form is a summary of actual disposition of the load in the helicopter. It records the balance status of the helicopter, step-by-step. It serves as a worksheet on which to record weight and balance calculations, and any corrections that must be made to ensure that the helicopter will be within weight and cg limits.

CHAPTER 7 PERFORMANCE DATA

SECTION I INTRODUCTION

NOTE

All OH-58A and OH-58C model aircraft are now equipped with the T63-A-720 Engine. For performance planning purposes, all OH-58A model aircraft will use the OH-58C model aircraft  performance charts.

c. Familiarity with the data will allow performance to be computed more easily and quickly.

d. Experience will be gained in accurately estimating the effects of variables for which data are not presented.

NOTE

The information provided in this chapter is primarily intended for mission planning and is most useful when planning operations in unfamiliar areas or at extreme conditions. The data may also be used in flight, to establish unit or area standing operating procedures, and to inform ground commanders of performance/risk trade-offs.

7-1. PURPOSE.

The purpose of this chapter is to provide the best available performance data for the OH-58A/C helicopter. Regular use of this information will enable you to receive maximum safe utilization from aircraft. Although maximum performance is not always required, regular use of this chapter is recommended for the following reasons.





a. Knowledge of your performance margin will allow you to make better decisions when unexpected conditions or alternate missions are encountered.

b. Situations requiring maximum performance will be readily recognized.







7-2. CHAPTER 7 INDEX.

The following index contains a list of the sections and their respective titles, along with figure numbers, subjects and page numbers for each performance chart contained in this chapter.

INDEX

Section	Subject	Page
I	Introduction	7-1
II	Temperature Conversion	7-6
	Figure 7-1. Temperature Conversion Chart	7-7
III-IX	T63-A-700 Engine  Performance Charts	DELETED
X	Torque Available 	7-47
	Figure 7-11. Maximum Torque available (30 Minute Operation) Chart 	
	Sheet 1 of 4, Engine Deice and Heater OFF	7-48
	Sheet 2 of 4, Engine Deice and Heater ON	7-49
	Sheet 3 of 4, Engine Deice and Heater OFF and Reverse Flow Inlet Installed	7-50
	Sheet 4 of 4, Engine Deice and Heater ON and Reverse Flow Inlet Installed	7-51
	Figure 7-12. Torque Available (Continuous Operation) Chart 	
	Sheet 1 of 4, Engine Deice and Heater OFF	7-52
	Sheet 2 of 4, Engine Deice and Heater ON	7-53
	Sheet 3 of 4, Engine Deice and Heater OFF and Reverse Flow Inlet Installed	7-54
	Sheet 4 of 4, Engine Deice and Heater ON and Reverse Flow Inlet Installed	7-55

INDEX — Continued

Section	Subject	Page
XI	Hover	7-56
	Figure 7-13. Hover Chart 	
	Sheet 1 of 3, Hover Chart	7-57
	Sheet 2 of 3, Hover Chart	7-58
	Sheet 3 of 3, Hover Chart	7-59
XII	Takeoff (not applicable)	7-60
	Figure 7-14 Takeoff Chart	DELETED
XIII	Cruise	7-62
	Figure 7-15. Cruise Chart 	
	Sheet 1 of 13, Pressure Altitude Sea Level to 2000 Ft, FAT = -30°C	7-63
	Sheet 2 of 13, Pressure Altitude 4000 Ft to 6000 Ft, FAT = -30°C	7-64
	Sheet 3 of 13, Pressure Altitude 8000 Ft to 14,000 Ft, FAT = -30°C	7-65
	Sheet 4 of 13, Pressure Altitude Sea Level to 6000 Ft, FAT = -15°C	7-66
	Sheet 5 of 13, Pressure Altitude 8000 Ft to 14,000 Ft, FAT = -15°C	7-67
	Sheet 6 of 13, Pressure Altitude Sea Level to 6000 Ft, FAT = 0°C	7-68
	Sheet 7 of 13, Pressure Altitude 8000 Ft to 14,000 Ft, FAT = 0°C	7-69
	Sheet 8 of 13, Pressure Altitude Sea Level to 6000 Ft, FAT = +15°C	7-70
	Sheet 9 of 13, Pressure Altitude 8000 Ft to 14,000 Ft, FAT = +15°C	7-71
	Sheet 10 of 13, Pressure Altitude Sea Level to 6000 Ft, FAT = +30°C	7-72
	Sheet 11 of 13, Pressure Altitude 8000 Ft to 14,000 Ft, FAT = +30°C	7-73
	Sheet 12 of 13, Pressure Altitude Sea Level to 6000 Ft, FAT = +45°C	7-74
	Sheet 13 of 13, Pressure Altitude 8000 Ft to 14,000 Ft, FAT = +45°C	7-75
XIV	Drag 	7-76
	Figure 7-16. Drag Chart	7-77
XV	Climb — Descent	7-78
	Figure 7-17. Climb — Descent Chart 	7-79
	Figure 7-18. Climb Performance 	DELETED
XVI	Idle Fuel Flow	7-84
	Figure 7-19. Idle Fuel Flow Chart 	7-85

7-3. GENERAL.

The data presented covers the maximum range of conditions and performance that can reasonably be expected. In each area of performance, the effects altitude, temperature, gross weight, and other parameters relating to that phase of flight are presented. In addition to the presented data, your judgement and experience will be necessary to accurately obtain performance under a given set of circumstances. The conditions for the data are listed under the title of each chart. The effects of different conditions are discussed in the text accompanying each phase of performance. Where practical, data are presented at conservative conditions. However, **NO GENERAL CONSERVATISM HAS BEEN APPLIED**. All performance data presented are within the applicable limits of the aircraft.

7-4. LIMITS.

Applicable limits are shown on the charts as red lines. Performance generally deteriorates rapidly beyond limits. If limits are exceeded, minimize the amount and time. Enter the maximum value and time above limits on DA Form 2408-13 so proper maintenance action can be taken.

7-5. USE OF CHARTS.

a. Chart Explanation. The first page of each section describes the chart(s) and explains its uses.

b. Color Coding. Chart color codes are used as follows:

- (1) Green is used for example guidelines.
- (2) Red is used for limit lines.
- (3) Yellow is used for precautionary or time-limited operations.

c. Reading the Charts. The primary use of each chart is given in an example and green guidelines is provided to help you follow the route through the chart. The use of a straight (ruler or page edge) and a hard fine point pencil is recommended to avoid cumulative errors. The majority of the charts provide a standard pattern for use as follows: enter first variable on top left scale, move right to the second variable, reflect down at right angles to the third variable, reflect left at right

angles to the fourth variable, reflect down, etc. until the final variable is read out at the final scale. In addition to the primary use, other uses of each chart are explained in the text accompanying each set of performance charts. Colored registration blocks located at the bottom and top of each chart are used to determine if slippage has occurred during printing. If slippage has occurred, refer to chapter 5 for correct operating limits

NOTE

An example of an auxiliary use of the charts referenced above is as follows: Although the hover chart is primarily arranged to find torque required to hover, by entering torque available as torque required, maximum skid height for hover can also be found. In general, any single variable can be found if all others are known. Also, the tradeoffs between two variables can be found. For example, at a given density altitude and pressure altitude, you can find the maximum gross weight capability as free air temperatures change.

The primary advantage of the helicopter over other aircraft is the capability to hover and take-off and land vertically (zero air speed flight). To more rapidly calculate the performance tradeoffs in hover mode, a Hover Ceiling Chart has been included.

7-6. DATA BASIS.

The type of data used is indicated at the bottom of each performance chart under DATA BASIS. The applicable report and date of the data are also given. The data provided generally is based on one of four categories.

a. Flight Test Data. Data obtained by flight test of the aircraft by experienced flight test personnel at precise conditions using sensitive calibrated instruments.

b. Derived From Flight Test. Flight test data obtained on a similar rather than the same aircraft and series. Generally small corrections will have been made.

c. Calculated Data. Data based on tests, but not on flight test of the complete aircraft.

d. Estimated Data. Data based on estimates using aerodynamic theory or other means but not verified by test flight.

7-7. SPECIFIC CONDITIONS.

The data presented are accurate only for specific conditions listed under the title of each chart. Variables for which data are not presented, but which may affect that phase of performance, are discussed in the text. Where data are available or reasonable estimates can be made, the amount that each variable affects performance will be given.

7-8. GENERAL CONDITIONS.

In addition to the specific conditions, the following general conditions are applicable to the performance data.

a. Rigging. All airframe and engine controls are assumed to be rigged within allowable tolerances.

b. Pilot Technique. Normal pilot technique is assumed. Control movements should be smooth and continuous.

c. Aircraft Variation. Variations in performance between individual aircraft are known to exist; however, they are considered to be small and cannot be individually accounted for.

d. Instrument Variation. The data shown in the performance charts do not account for instrument inaccuracies or malfunctions.

e. Types of Fuel. All flight performance data is based on JP-4 fuel. The change in fuel flow and torque available, when using JP-5, JP-8, Aviation gasoline, or any other approved fuels, is insignificant.

7-9. PERFORMANCE DISCREPANCIES.

Regular use of this chapter will allow you to monitor instruments and other aircraft systems for malfunction, by comparing actual performance with planned performance. Knowledge will also be gained concerning the effects of variables for which data are not provided, thereby increasing the accuracy of performance predictions.

7-10. DEFINITIONS OF ABBREVIATIONS.

a. Unless otherwise indicated in the following list of abbreviations, abbreviations and symbols used in this manual conform to those established in Military Standard MIL-STD-12, which is periodically revised to reflect current changes in abbreviations usage. Accordingly, it may not be noted that certain previously established definitions have been replaced by more current abbreviations and symbols.

b. Capitalization and punctuation of abbreviations varies, depending upon the context in which they are used. In general, lower case abbreviations are used in text material, whereas abbreviations used in charts and illustrations appear in full capital letters. Periods do not usually follow abbreviation; however, periods are used with abbreviations that could be mistaken for whole words if they were omitted.

c. The following list provides definitions for abbreviations used in this manual. The same abbreviation applies for either singular or plural applications.

LIST OF ABBREVIATIONS

Abbreviation	Definition	Abbreviation	Definition
AGL	Above ground level	FAT	Free air temperature
ALT	Altitude	FLT	Flight
AVAIL	Available	FT	Foot
C	Celsius	FT/MIN	Foot per minute
CAS	Calibrated	FWD	Forward
CL	Centerline	ΔF	Increment of equivalent flat plate drag area
CONFIG	Configuration		
CONT	Continuous	GAL	Gallon
ECU	Environmental Control Unit	GAL/HR	Gallons per hour
END	Endurance	GW	Gross Weight
F	Fahrenheit	HP	Horsepower
HR	Hour	NM	Nautical Mile

LIST OF ABBREVIATIONS — Continued

Abbreviation	De nition	Abbreviation	De nition
IAS	Indicated airspeed	%Q	Percent torque
IGE	In ground effect	PRESS	Pressure
IN	Inch	PSI	Per square inch
IN HG	Inches of mercury	R/C	Rate of climb
IR	Infrared	R/D	Rate of descent
KIAS	Knots indicated airspeed	RPM	Revolutions per minute
KN	Knot	SPEC	Specif cations
°	Degree	STA	Station
OGE	Out of ground effect	SQ FT	Square feet
LB	Pound	TAS	True airspeed
LB/HR	Pounds per hour	TOT	Turbine outlet temperature
LIM	Limit	TRQ	Torque
MAX	Maximum	USAASTA	United States Army Aviation Systems Test Activity
MIN	Minute	VDC	Volts, direct current
MIN	Minimum	Vne	Velocity, never exceed (airspeed limitation)
MM	Millimeter	XMSN	Transmission
N1	Gas producer speed		
N2	Power turbine speed		
NO.	Number		

SECTION II TEMPERATURE CONVERSION

7-11. FREE AIR TEMPERATURES.

A temperature conversion chart (figure 7-1) is indicated for the purpose of converting Fahrenheit temperature to Celsius.

TEMPERATURE CONVERSION

TEMPERATURE
CONVERSION
OH-58A/C

EXAMPLE

WANTED

FREE AIR TEMPERATURE IN DEGREES CELSIUS

KNOWN

FREE AIR TEMPERATURE = +32°F

METHOD

ENTER FREE AIR TEMPERATURE
HERE
MOVE RIGHT TO DIAGONAL LINE
MOVE DOWN TO DEGREES CELSIUS SCALE
READ FREE AIR TEMPERATURE = 0°C

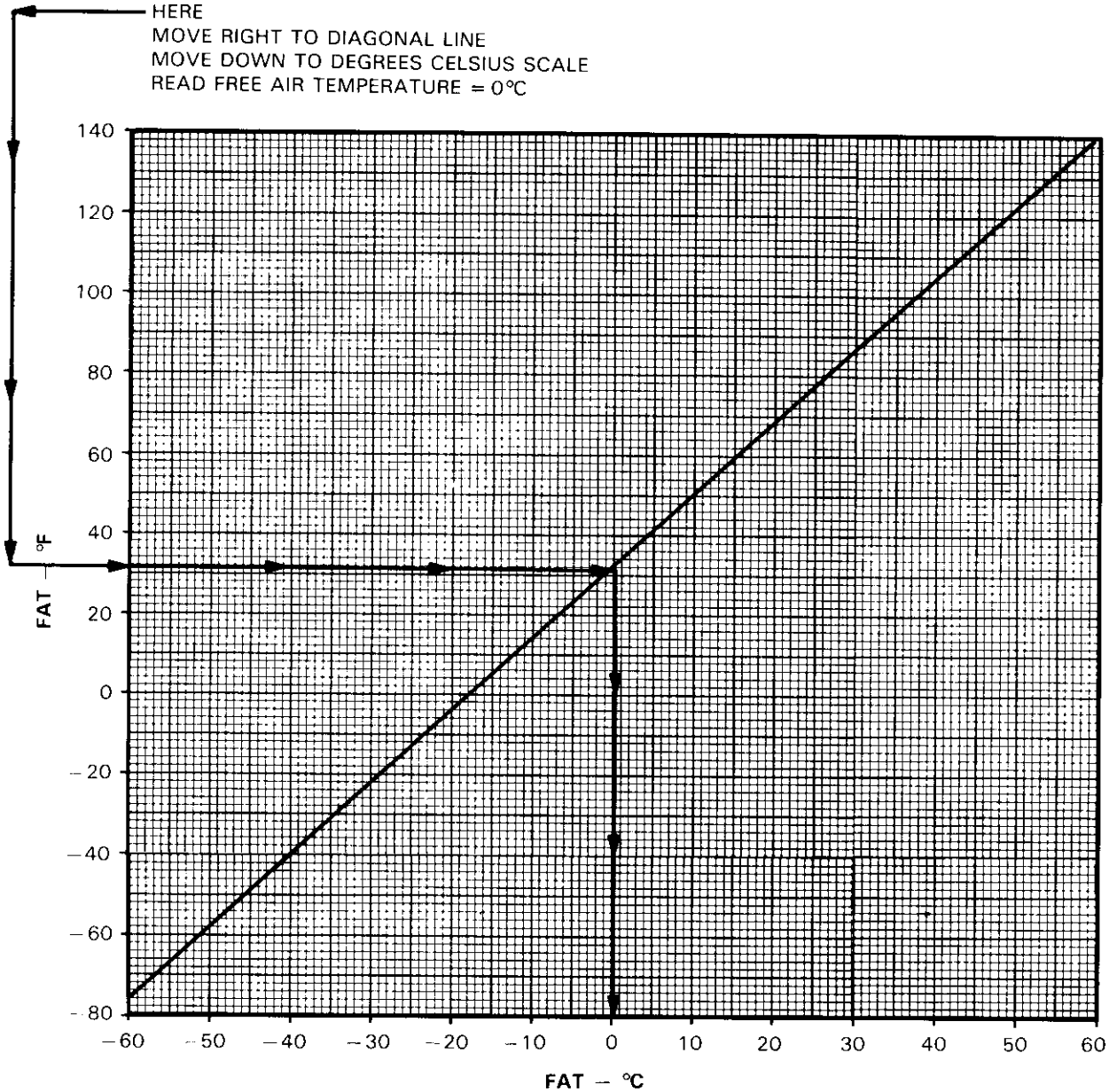

206900-515

MS026101

Figure 7-1. Temperature Conversion Chart

PAGES 7-8 THROUGH 7-46, INCLUDING PARAGRAPHS 7-12 THROUGH 7-36 AND FIGURES 7-2 THROUGH 7-10, HAVE BEEN DELETED.

SECTION X TORQUE AVAILABLE

7-37. DESCRIPTION.

The torque available charts show the effects of altitude and temperature on engine torque.

7-38. CHART DIFFERENCES.

Both pressure altitude and FAT affect engine power production. Figure 7-11 and 7-12 show power available data at 30 minute power and maximum continuous power ratings in terms of the allowable torque as recorded by the torquemeter (%Q).

Note that the power output capability of the T63-A-720 engine can exceed the transmission structural limit (100 %Q) under certain conditions.

- a. Figure 7-11 (sheet 1) is applicable for maximum power, engine deice and heater off, 30 minute operation at 100% N2 rpm.
- b. Figure 7-11 (sheet 2) is applicable for maximum power, engine deice and heater on, 30 minute operation at 100% N2 rpm.
- c. Figure 7-11 (sheet 3) is applicable for maximum power, engine deice and heater off and reverse flow inlet installed, 30 minute operation at 100% N2 rpm.
- d. Figure 7-11 (sheet 4) is applicable for maximum power, engine deice and heater on and reverse flow inlet installed, 30 minute operation at 100% N2 rpm.
- e. Figure 7-12 (sheet 1 through 4) is applicable for maximum continuous power for the above mentioned conditions.

f. Prolonged IGE hover may increase engine inlet temperature as much as 10°C, therefore, a higher FAT must be used to correct for the increase under this condition.

7-39. USE OF CHARTS.

The primary use of the charts is illustrated by the examples. In general, to determine the maximum power available, it is necessary to know the pressure altitude and temperature. By entering the upper left side of the chart at the known pressure altitude, moving right to the known temperature, then straight down to the bottom of the lower grid, available torque is obtained. If the CONT XMSN LIM line is intersected prior to reaching the temperature line, TORQUE AVAILABLE is 85%. Operations in the yellow area of the chart (between 85 and 100%) are limited to 5 minutes duration.

7-40. CONDITIONS.

Chart (figure 7-11) is based upon speeds @ 100% rotor/engine rpm with JP-4 fuel. The use of aviation gasoline will not influence engine power. Fuel grade of JP-5 will yield the same nautical miles per pound of fuel and being 6.8 pounds per gallon will only result in increased fuel weight per gallon. Because JP-4 and JP-5 have the same energy value per pound, then JP-5 fuel will increase range by almost 5 percent per gallon of fuel. The 30 minutes operation limit is based on TOT indication.



MAXIMUM TORQUE AVAILABLE (30 MINUTE OPERATION)
ENGINE DEICE AND HEATER OFF
100% RPM, JP-4 FUEL

MAXIMUM TORQUE
OH-58C
T63-A-720

EXAMPLE
WANTED
 CALIBRATED TORQUE
KNOWN
 PRESSURE ALTITUDE = 7000 FEET
 FAT = 20°C
METHOD
 ENTER PRESSURE ALTITUDE HERE
 MOVE RIGHT TO FAT
 MOVE DOWN TO READ
 CALIBRATED = 92.5%Q (5 MIN)
 CALIBRATED = 85%Q (30 MIN)

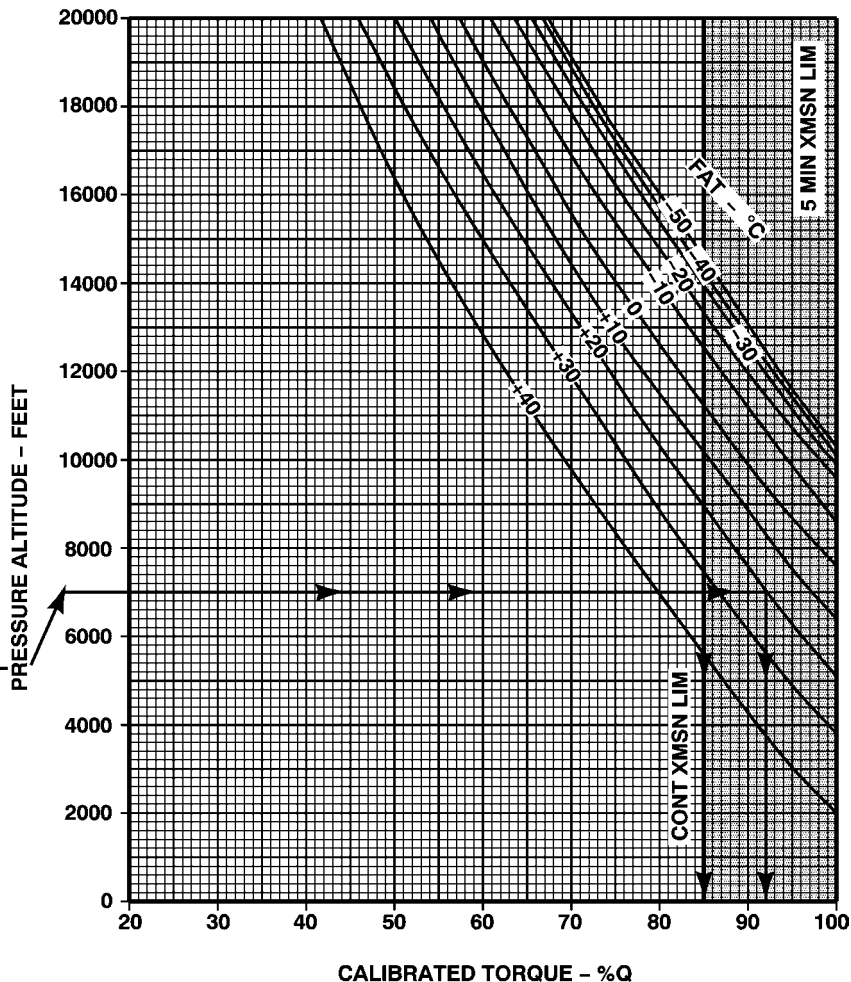

DATA BASIS: CALCULATED FROM MODEL SPEC 876, 25 JULY 1975, CORRECTED FOR INSTALLATION LOSSES BASED ON FLIGHT TEST OF SIMILAR TYPE AIRCRAFT



MS026102A

Figure 7-11. Maximum Torque Available (30 Minute Operation) Chart (Sheet 1 of 4)



MAXIMUM TORQUE AVAILABLE (30 MINUTE OPERATION)
ENGINE DEICE AND HEATER ON
100% RPM, JP-4 FUEL

MAXIMUM TORQUE
OH-58C
T63-A-720

EXAMPLE
WANTED

CALIBRATED TORQUE

KNOWN

PRESSURE ALTITUDE = 7000 FEET
 FAT = 10°C

METHOD

ENTER PRESSURE ALTITUDE HERE →
 MOVE RIGHT TO FAT
 MOVE DOWN, READ
 CALIBRATED TORQUE = 87.7%Q
 (5 MIN)
 CALIBRATED TORQUE = 85.5%Q
 (30 MIN)

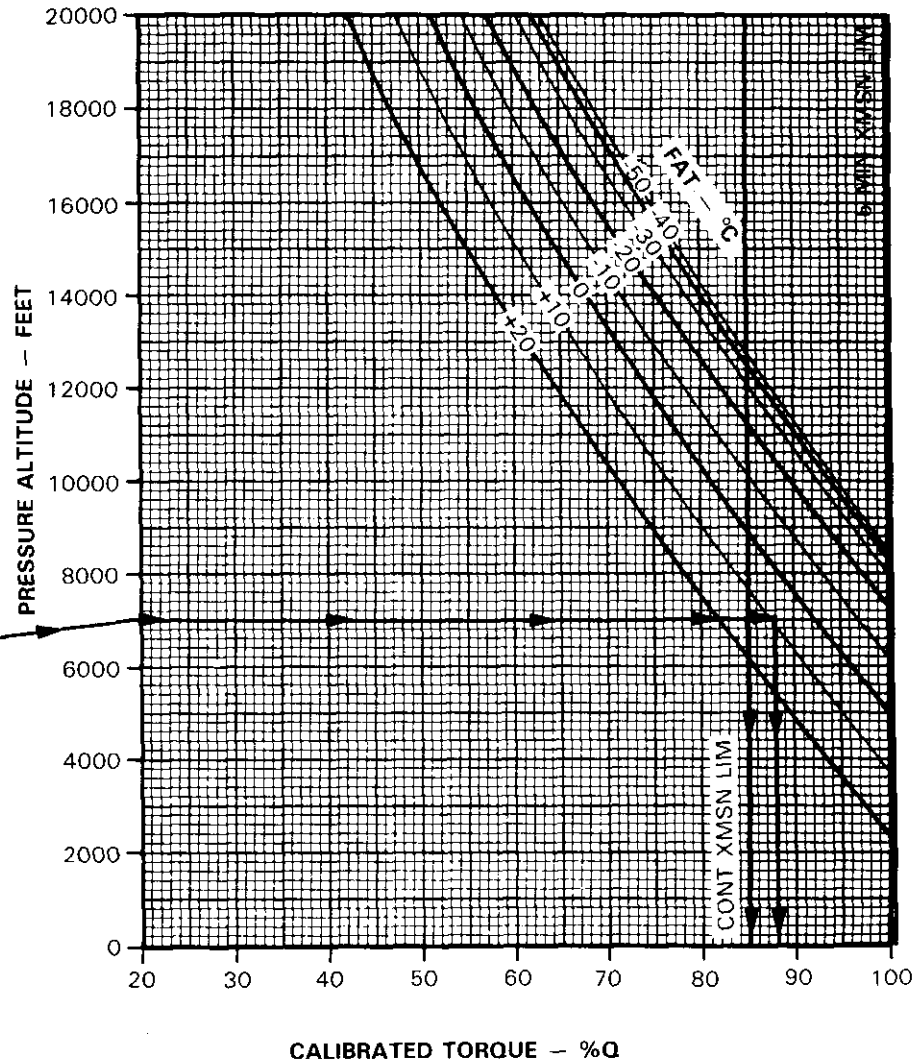

DATA BASIS: CALCULATED FROM MODEL SPEC 876, 25 JULY 1975, CORRECTED FOR INSTALLATION LOSSES BASED ON FLIGHT TEST OF SIMILAR TYPE AIRCRAFT



MS026103

Figure 7-11. Maximum Torque Available (30 Minute Operation) Chart (Sheet 2 of 4)



**MAXIMUM TORQUE AVAILABLE (30 MINUTE OPERATION)
ENGINE DEICE AND HEATER OFF AND REVERSE FLOW INLET INSTALLED
100% RPM, JP-4 FUEL**

**MAXIMUM
TORQUE
OH-58C
T63-A-720**

**EXAMPLE
WANTED**

CALIBRATED TORQUE

KNOWN

PRESSURE ALTITUDE = 7000 FEET
FAT = 20°C

METHOD

ENTER PRESSURE ALTITUDE HERE →
MOVE RIGHT TO FAT
MOVE DOWN, READ
CALIBRATED TORQUE = 76.8%Q

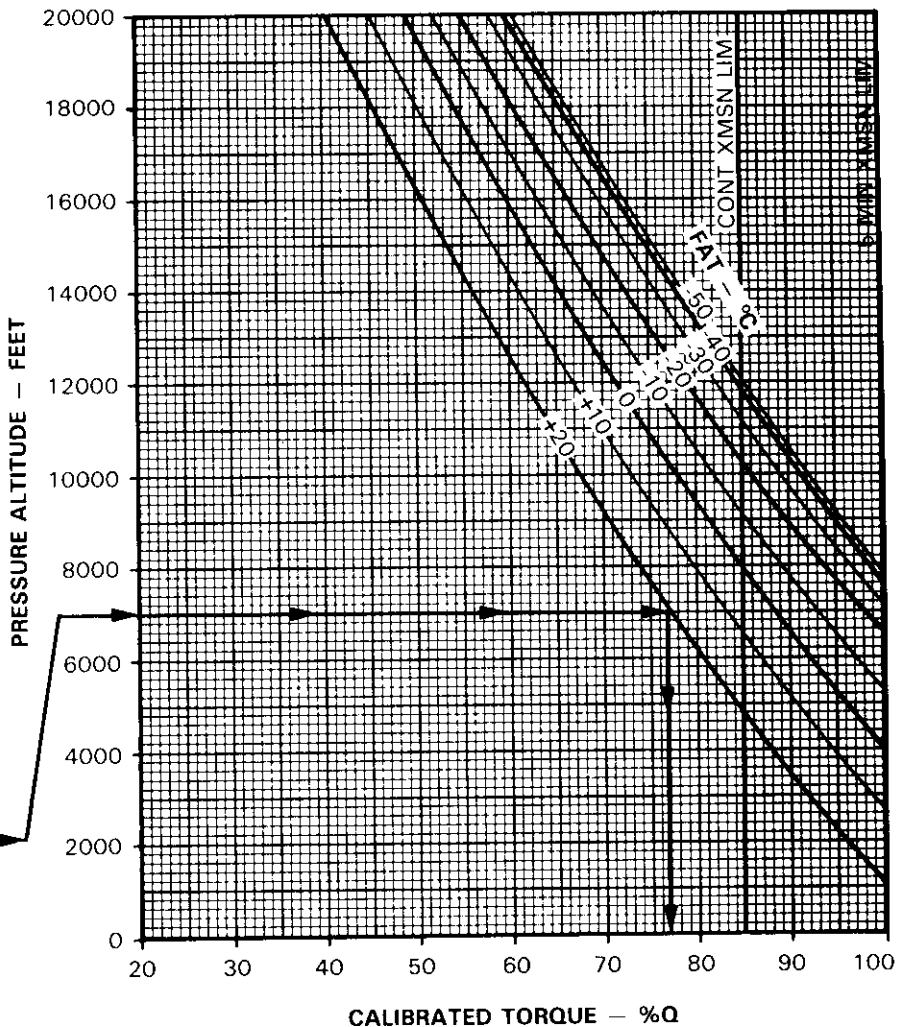

DATA BASIS: CALCULATED FROM MODEL SPEC 876, 25 JULY 1975,
CORRECTED FOR INSTALLATION LOSSES BASED ON FLIGHT TEST OF SIMILAR TYPE AIRCRAFT



MS026104

Figure 7-11. Maximum Torque Available (30 Minute Operation) Chart (Sheet 3 of 4)



MAXIMUM TORQUE AVAILABLE (30 MINUTE OPERATION)
ENGINE DEICE AND HEATER ON AND REVERSE FLOW INLET INSTALLED
100% RPM, JP-4 FUEL

MAXIMUM TORQUE
OH-58C
T63-A-720

EXAMPLE
WANTED

CALIBRATED TORQUE

KNOWN

PRESSURE ALTITUDE = 7000 FEET
 FAT = 10°C

METHOD

ENTER PRESSURE ALTITUDE HERE
 MOVE RIGHT TO FAT
 MOVE DOWN, READ
 CALIBRATED = 83.5%Q

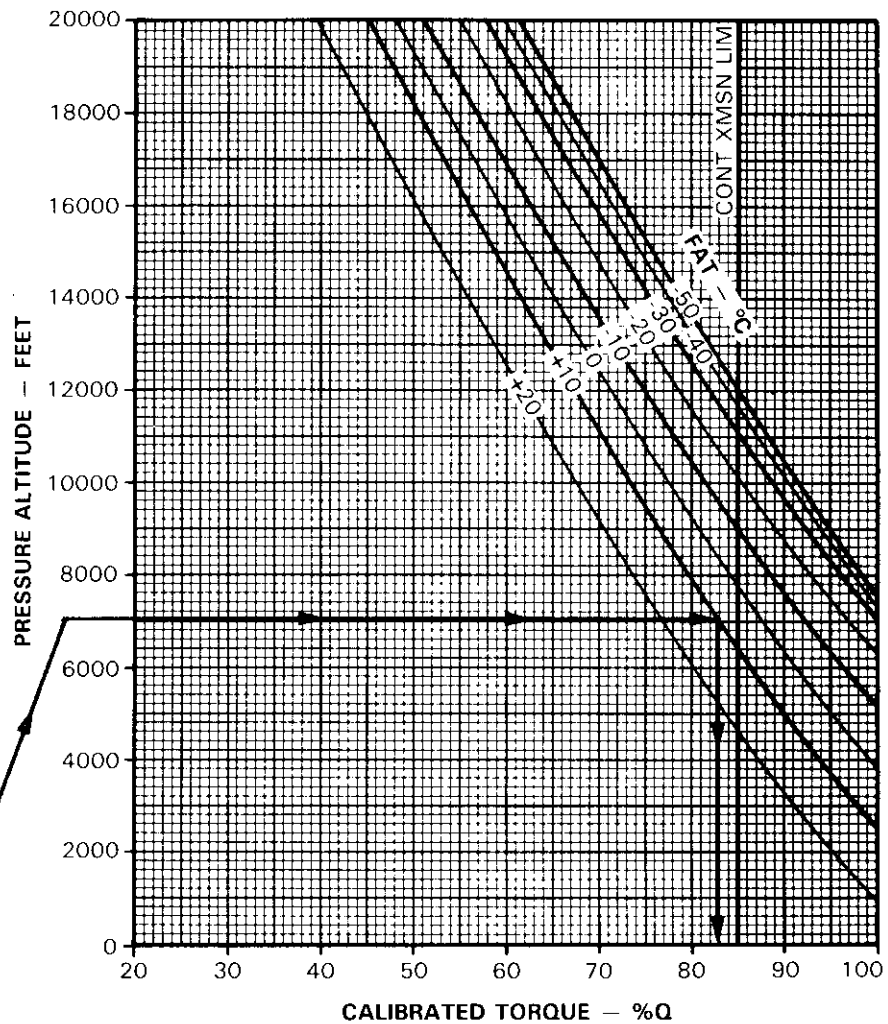

DATA BASIS: CALCULATED FROM MODEL SPEC 876, 25 JULY 1975,
 CORRECTED FOR INSTALLATION LOSSES BASED ON FLIGHT TEST OF SIMILAR TYPE AIRCRAFT



MS026105

Figure 7-11. Maximum Torque Available (30 Minute Operation) Chart (Sheet 4 of 4)



TORQUE AVAILABLE — CONTINUOUS OPERATION
ENGINE DEICE AND HEATER OFF
100% RPM, JP-4 FUEL

TORQUE AVAILABLE
OH-58C
T63-A-720

EXAMPLE WANTED

CALIBRATED TORQUE

KNOWN

PRESSURE ALTITUDE = 7000 FEET
 FAT = 20°C

METHOD

ENTER PRESSURE ALTITUDE HERE
 MOVE RIGHT TO FAT
 MOVE DOWN, READ
 CALIBRATED TORQUE = 76.5%Q

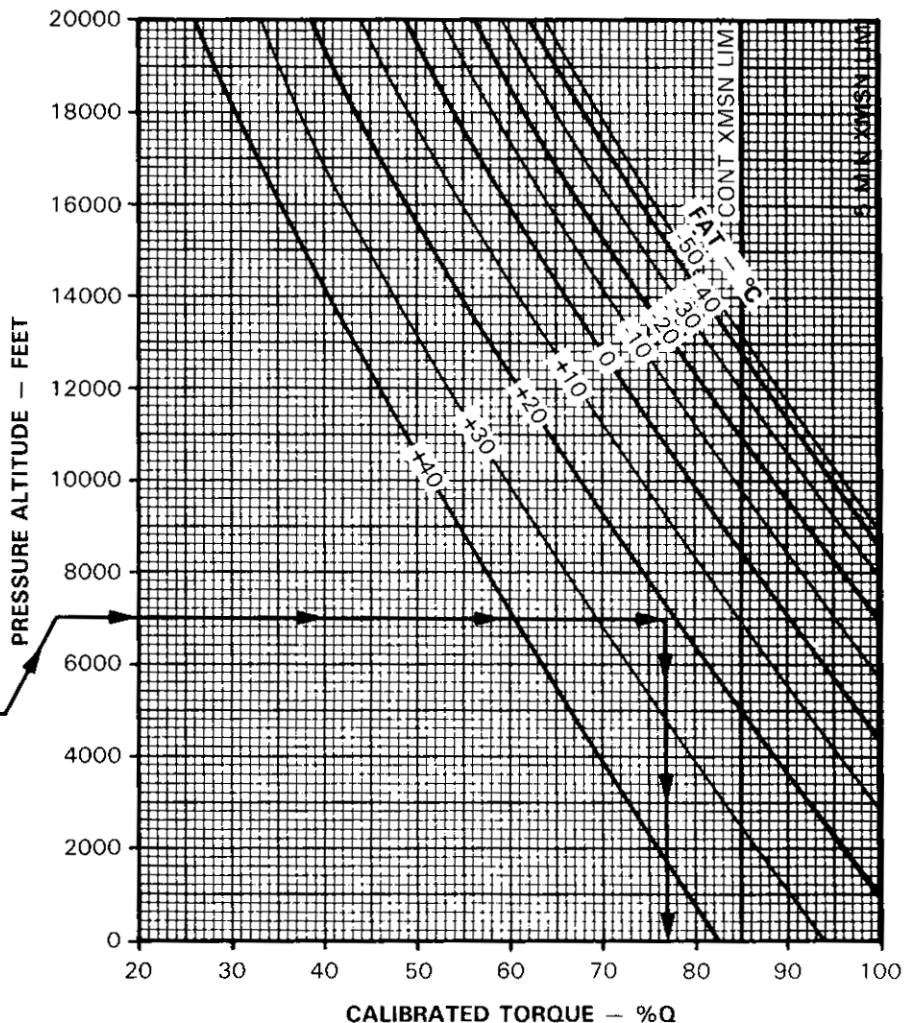

DATA BASIS: CALCULATED FROM MODEL SPEC 876, 25 JULY 1975,
 CORRECTED FOR INSTALLATION LOSSES BASED ON FLIGHT TEST OF SIMILAR TYPE AIRCRAFT



MS026106

Figure 7-12. Torque Available (Continuous Operation) Chart (Sheet 1 of 4)



TORQUE AVAILABLE—CONTINUOUS OPERATION
ENGINE DEICE AND HEATER ON
100% RPM, JP-4 FUEL

TORQUE AVAILABLE
OH-58C
T63-A-720

EXAMPLE WANTED

CALIBRATED TORQUE

KNOWN

PRESSURE ALTITUDE = 7000 FEET
 FAT = 10°C

METHOD

ENTER PRESSURE ALTITUDE HERE
 MOVE RIGHT TO FAT
 MOVE DOWN, READ
 CALIBRATED TORQUE = 72.5%Q

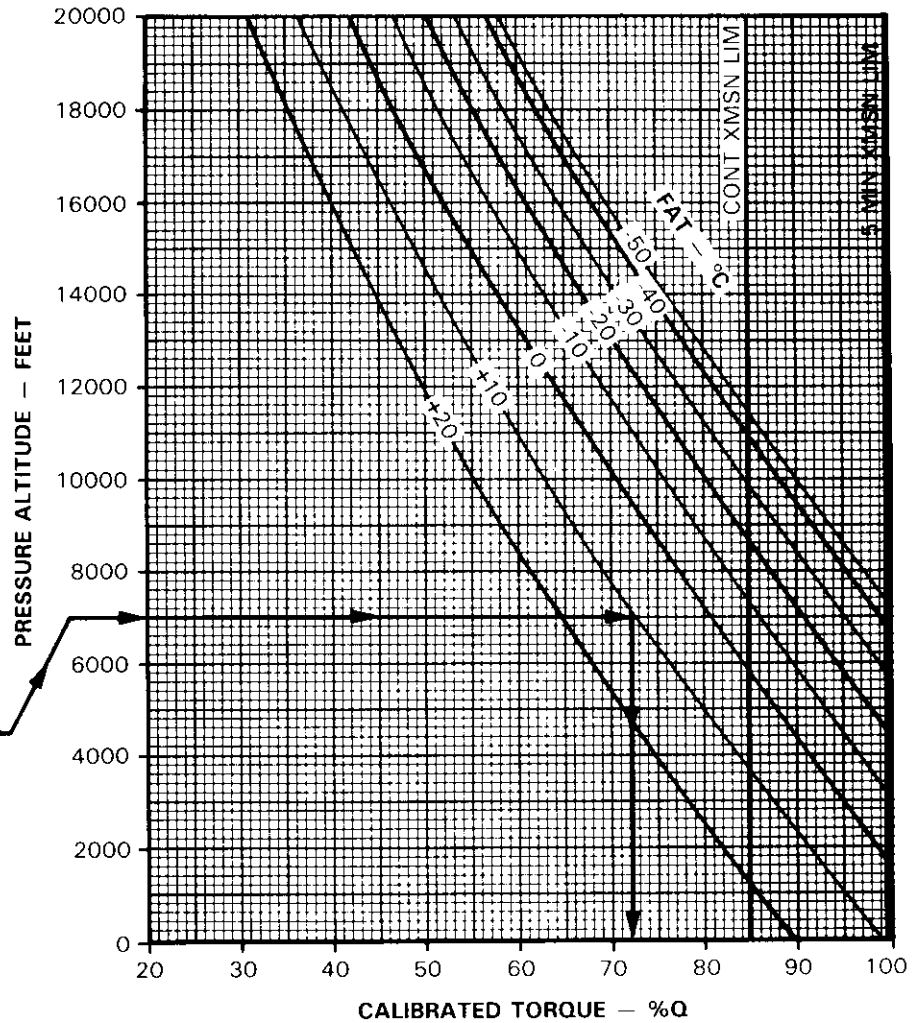

DATA BASIS: CALCULATED FROM MODEL SPEC 876, 25 JULY 1975,
 CORRECTED FOR INSTALLATION LOSSES BASED ON FLIGHT TEST OF SIMILAR AIRCRAFT



MS026107

Figure 7-12. Torque Available (Continuous Operation) Chart (Sheet 2 of 4)



TORQUE AVAILABLE—CONTINUOUS OPERATION
ENGINE DEICE AND HEATER OFF AND REVERSE FLOW INLET INSTALLED
100% RPM, JP-4 FUEL

TORQUE AVAILABLE
 OH-58C
 T63-A-720

EXAMPLE WANTED

CALIBRATED TORQUE

KNOWN

PRESSURE ALTITUDE = 7000 FEET
 FAT = 20°C

METHOD

ENTER PRESSURE ALTITUDE HERE →
 MOVE RIGHT TO FAT
 MOVE DOWN. READ
 CALIBRATED TORQUE = 59.5%Q

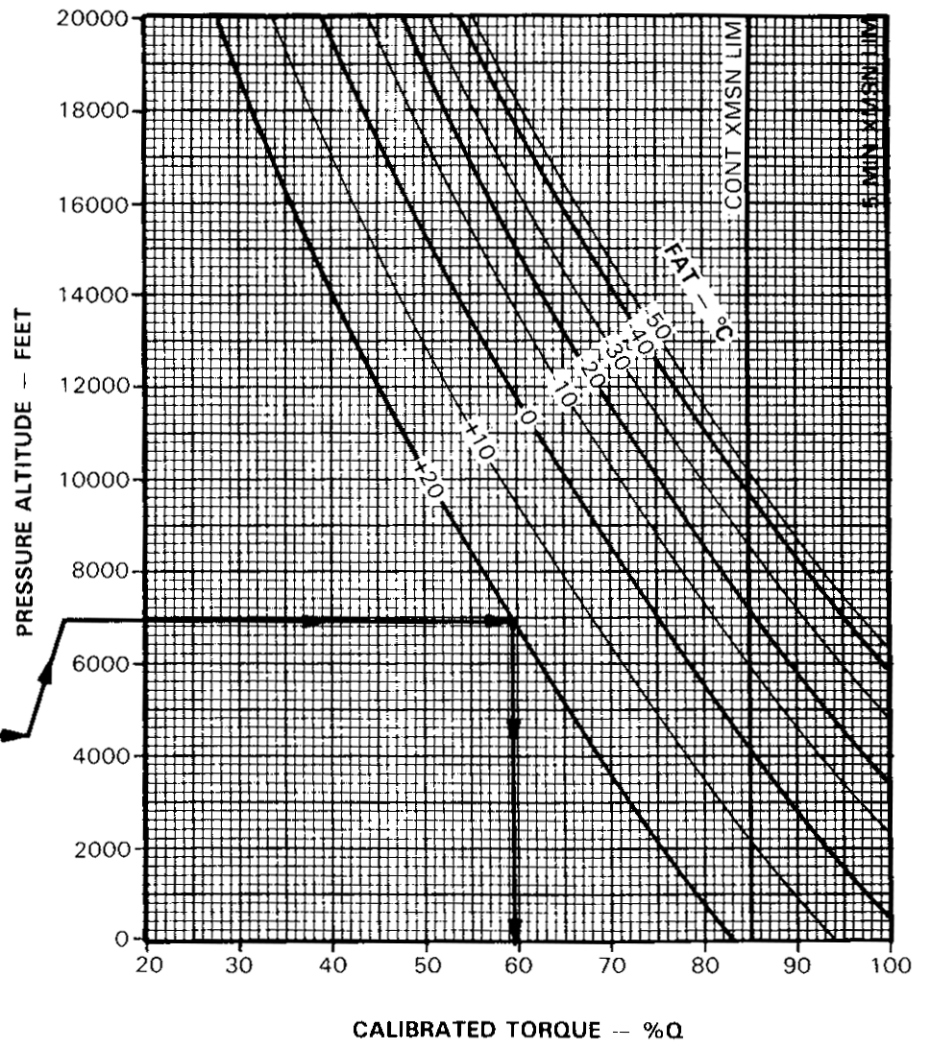

DATA BASIS: CALCULATED FROM MODEL SPEC 876, 25 JULY 1975,
 CORRECTED FOR INSTALLATION LOSSES BASED ON FLIGHT TEST OF SIMILAR TYPE AIRCRAFT



MS026108

Figure 7-12. Torque Available (Continuous Operation) Chart (Sheet 3 of 4)



TORQUE AVAILABLE — CONTINUOUS OPERATION
BLEED AIR ON PARTICLE SEPARATOR AND
REVERSE FLOW INLET INSTALLED
100% RPM JP-4

TORQUE AVAILABLE
OH-58C
T63-A-720

EXAMPLE WANTED

CALIBRATED TORQUE

KNOWN

PRESSURE ALTITUDE = 7000 FEET
 FAT = 10°C

METHOD

ENTER PRESSURE ALTITUDE HERE →
 MOVE RIGHT TO FAT
 MOVE DOWN, READ
 CALIBRATED TORQUE = 67.5%Q

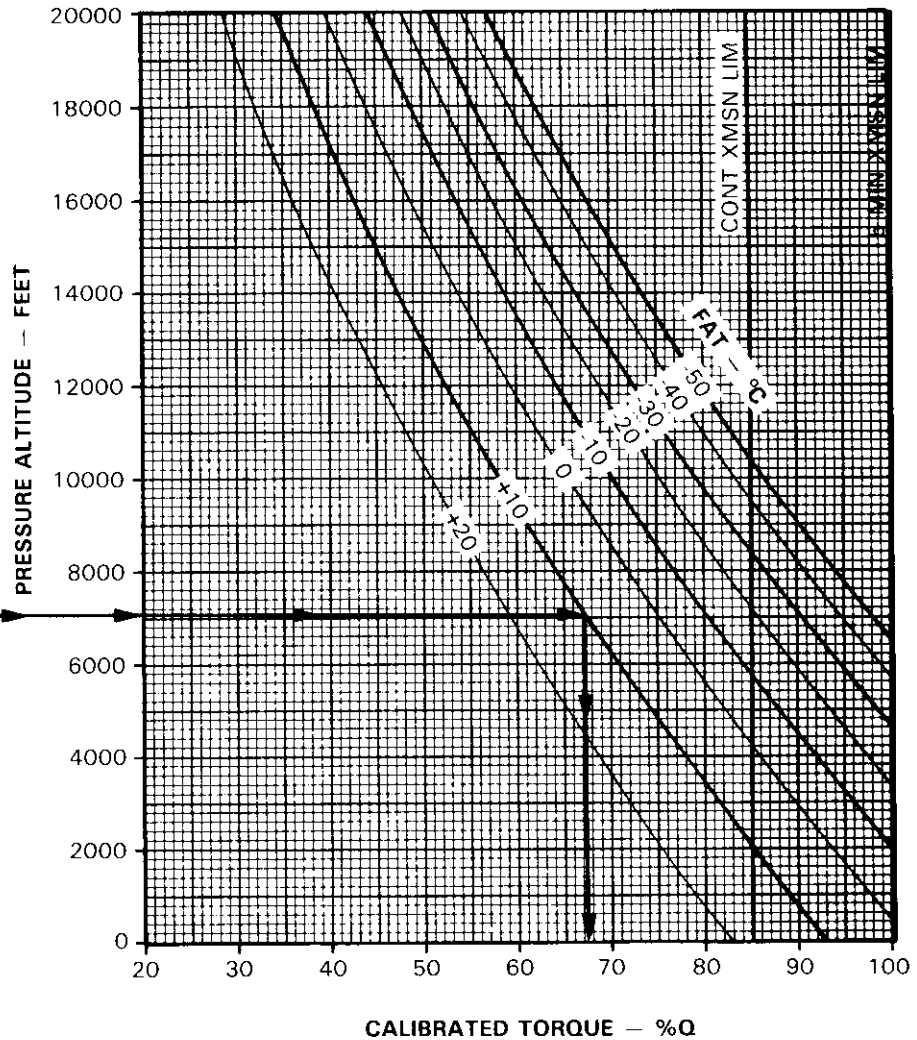

DATA BASIS: CALCULATED FROM MODEL SPEC 876, 25 JULY 1975,
 CORRECTED FOR INSTALLATION LOSSES BASED ON FLIGHT TEST OF SIMILAR TYPE AIRCRAFT



MS026109

Figure 7-12. Torque Available (Continuous Operation) Chart (Sheet 4 of 4)

SECTION XI HOVER

7-41. DESCRIPTION.

The hover charts (figure 7-13, sheets 1 and 2) show the hover ceiling and the torque required to hover respectively at various pressure altitudes, ambient temperatures, gross weights, and skid heights. Maximum skid height for hover can also be obtained by using the torque available from figure 7-11.

7-42. USE OF CHART.

a. The primary use of the charts is illustrated by the charts examples. In general, to determine to hover ceiling or the torque required to hover, it is necessary to know the pressure altitude, temperature, gross weight and the desired skid height.

CAUTION

Low altitude maneuvering flights at airspeeds below 35 knots are not recommended under conditions where power required to hover out of ground effect exceeds maximum continuous power.

b. In addition to its primary use, the hover chart (sheet 2) can also be used to determine the predicted maximum hover height, which is needed for use of the takeoff chart (figure 7-14); and the maximum right crosswind corresponding to a 10% directional control margin. To determine maximum right crosswind and hover height proceed as follows:

(1) Enter chart at appropriate pressure altitude.

(2) Move right to FAT.

(3) Move down to gross weight, read the maximum right crosswind corresponding to a 10% directional control margin.

(4) Move left to intersection with maximum power available (obtained from figure 7-11).

(5) Read the predicted maximum skid height. This height is the maximum hover height.

7-43. CONDITIONS.

The hover charts are based upon calm wind conditions, a level ground surface, and the use of 100% N2 rpm. Controllability during downwind hover, crosswinds, side-ward flight and rearward flight may be inadequate; however, for stabilized hover in steady winds from the right (i.e., right crosswind) the wind velocities on the chart correspond to the maximum one can have and yet maintain a 10% directional control margin. See Chapter 5 for hovering and low altitude/low airspeed flight limitations.

WARNING

Figure 7-13 (sheet 3 of 3) shows 10% directional control margins only for the stabilized conditions set forth. It does not and is not meant to infer that for corresponding dynamic flight maneuvering conditions such margins exist.



HOVER CEILING

**MAXIMUM TORQUE AVAILABLE (30 MINUTE OPERATION)
100% RPM**

HOVER
OH-58C
T63-A-720

EXAMPLE

WANTED

GROSS WEIGHT TO HOVER OGE (50 FT)

KNOWN

PRESSURE ALTITUDE = 10000 FEET

FAT = 0°C

SKID HEIGHT = OGE (50 FT)

METHOD

ENTER PRESSURE ALTITUDE HERE →
 MOVE RIGHT TO FAT
 MOVE DOWN TO SKID HEIGHT
 MOVE LEFT, READ GROSS WEIGHT
 TO HOVER = 2965 POUNDS

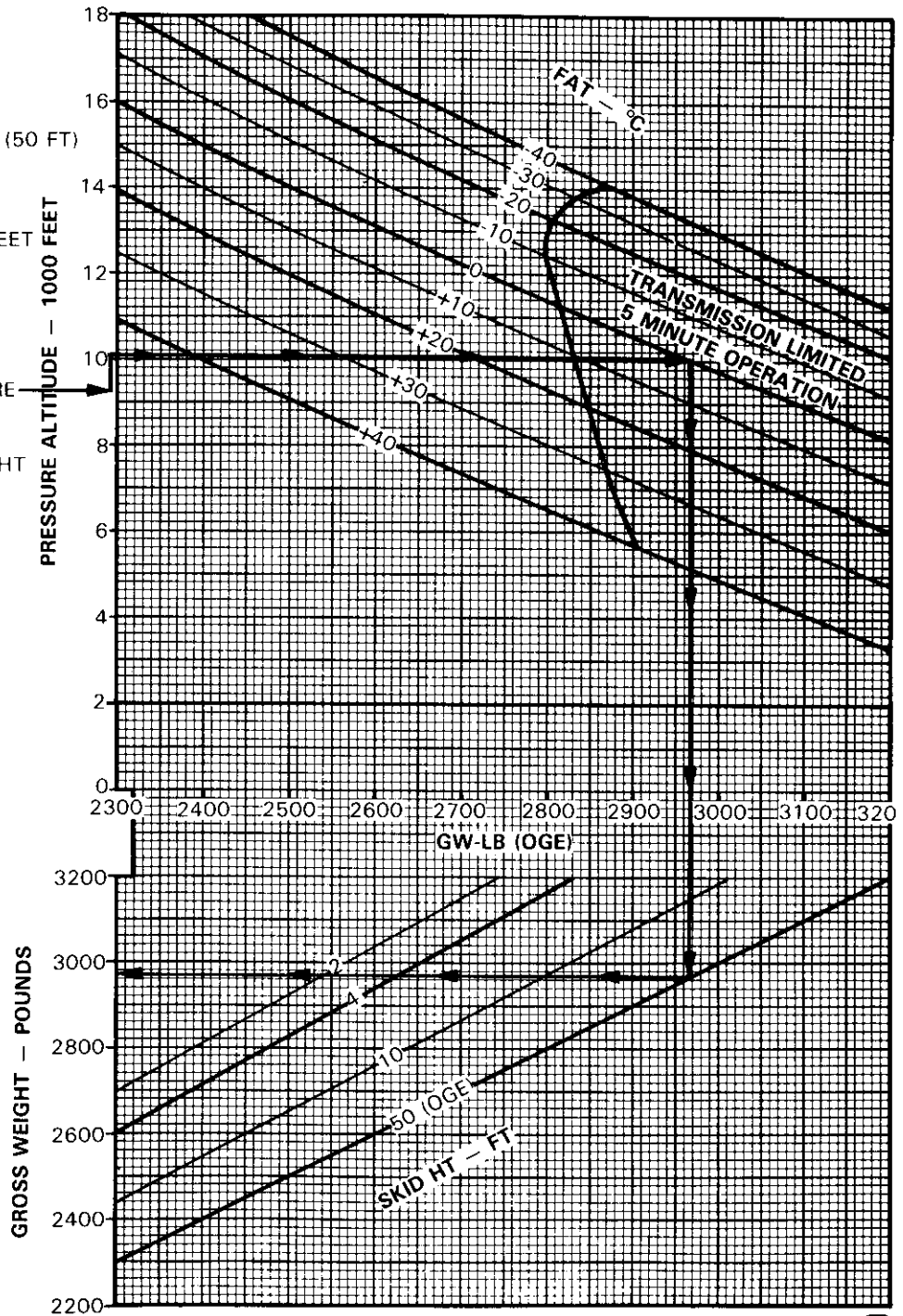

DATA BASIS: DERIVED FROM FLIGHT TEST, USA AEFA 74-48, APRIL 1975

MS026110

Figure 7-13. Hover Chart (Sheet 1 of 3)



HOVER

AT 100% N2 RPM
ALL CONFIGURATIONS LEVEL SURFACE CALM WIND

HOVER OH-58C T63-A-720

EXAMPLE

WANTED

TORQUE REQUIRED TO HOVER & RT CROSS-
WIND CORRES TO 10% DCM

KNOWN

PRESSURE ALTITUDE = 11000 FEET
FAT = 0°C
GROSS WEIGHT = 2600 LB
DESIRED SKID HEIGHT = 2 FEET

METHOD

ENTER PRESSURE ALTITUDE HERE →
MOVE RIGHT TO FAT
MOVE DOWN TO GROSS WEIGHT, READ RT CROSSWIND
MOVE LEFT TO SKID HEIGHT
MOVE DOWN, READ TORQUE REQUIRED
TO HOVER = 60.3%Q

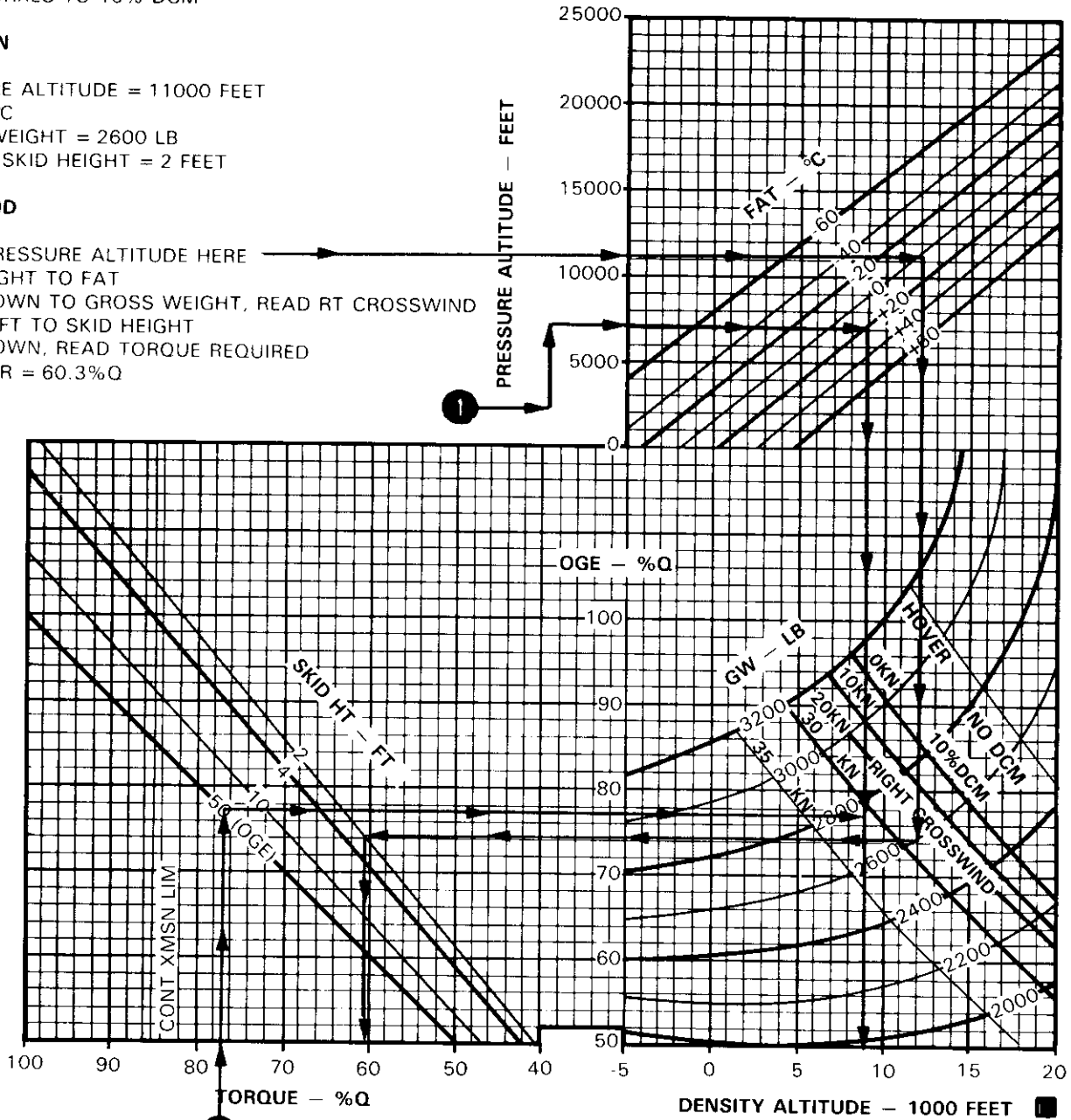

DATA BASIS: DERIVED FROM FLIGHT TEST, USA AEFA 74-48, APRIL 1975

MS026111

Figure 7-13. Hover Chart (Sheet 3 of 3)

SECTION XII TAKEOFF

7-44. DELETED.

7-46. DELETED.

7-45. DELETED.

FIGURE 7-14. ON PAGE 7-61 HAS BEEN DELETED.

SECTION XIII CRUISE

7-47. DESCRIPTION.

The cruise charts (figure 7-15, sheets 1 through 13) show the torque pressure and engine rpm required for level flight at various pressure altitudes, airspeeds, gross weights, and fuel flows.

NOTE

The cruise charts are basically arranged by FAT groupings, Figure 7-15, sheets 1 through 13, are based upon operation with clean configuration.

7-48. USE OF CHARTS.

The primary use of the charts is illustrated by the examples provided in figure 7-15. The first step for chart use is to select the proper chart, based upon the planned drag configuration, pressure altitude, and anticipated free air temperature; refer to chapter 7 index (paragraph 7-2). Normally, sufficient accuracy can be obtained by selecting the chart nearest to the planned cruising altitude and FAT, or the next higher altitude and FAT (chart Example A, Method 2). If greater accuracy is required, interpolation between altitudes and/or temperatures will be required (chart Example A, Method 1). You may enter the charts on any side: TAS, IAS, torque pressure, or fuel flow, and then move vertically or horizontally to the gross weight, then to the other three parameters. Maximum performance conditions are determined by entering the chart where the maximum range or maximum endurance and rate of climb lines intersect the appropriate gross weight; then read airspeed, fuel flow, and percent torque. For conversion, use the gross weight at the beginning of cruise flight. For greater accuracy on long flights it is preferable to determine cruise information for several flight segments in order to allow for decreasing fuel weights (reduced gross weight). The following parameters contained in each chart are further explained as follows:

a. Airspeed. True and indicated airspeeds are presented at opposite sides of each chart. On any chart,

indicated airspeed can be directly converted to true airspeed (or vice versa) by reading directly across the chart without regard for other chart information. Maximum permissible airspeed (Vne) limits appear as red lines on some charts. If no red line appears, Vne is above the limits of the chart.

b. Torque (%Q). Since pressure altitude and temperature are fixed for each chart, torque varies according to gross weight and airspeed.

c. Fuel Flow. Fuel flow scales are provided opposite the torque scales. On any chart, torque may be converted directly to fuel flow without regard for other chart information. All fuel flow information is presented with engine deice and heater off. Fuel flow increases 5% with reverse flow inlets installed, 4% with anti-ice on, and 4% with bleed air heater on.

d. Maximum Range. The maximum range lines indicate the combinations of weight and airspeed that will produce the greatest flight range per gallon of fuel under zero wind conditions. When a maximum range condition does not appear on a chart it is because the maximum range speed is beyond the maximum permissible speed (Vne) in such cases, Vne cruising speed to obtain maximum range.

e. Maximum Endurance and Maximum Rate of Climb. The maximum endurance and maximum rate of climb lines indicate the airspeed for minimum torque required to maintain level flight for each gross weight, FAT, and pressure altitude. Since minimum torque will provide minimum fuel flow, maximum flight endurance will be obtained at the airspeeds indicated.

7-49. CONDITIONS.

The cruise charts are based upon operation at 100% rpm, engine deice and heater off.



CRUISE
PRESSURE ALTITUDE — SEA LEVEL TO 2000 FEET
CLEAN CONFIGURATION JP-4/JP-5 FUEL OGE

CRUISE
 OH-58C
 T63-A-720

EXAMPLE A
WANTED

TORQUE REQUIRED FOR LEVEL FLIGHT,
 FUEL FLOW, INDICATED AIRSPEED

KNOWN

CLEAN CONFIGURATION
 GROSS WEIGHT = 2800 LB
 PRESSURE ALTITUDE = 1000 FEET
 FAT = -30°C
 DESIRED TRUE AIRSPEED = 90 KNOTS

METHOD 1 (INTERPOLATE — MOST ACCURATE)

ENTER TRUE AIRSPEED HERE
 READ TORQUE, FUEL FLOW, AND IAS ON EACH
 ADJACENT ALTITUDE AND/OR FAT, THEN
 INTERPOLATE BETWEEN ALTITUDE AND FAT

ALTITUDE, FEET	SEA LEVEL	2000 FEET	1000 FEET
FAT, C	-30	-30	-30
TORQUE, %Q	73	70	71.5
FUEL FLOW LB/HR	168	161	164.5
IAS, KNOTS	99	96	97.5

METHOD 2 (SIMPLEST)

USE NEXT HIGHEST ALTITUDE AND/OR TEMPERATURE
 (2000 FEET, -30°C)
 ENTER TRUE AIRSPEED HERE
 MOVE RIGHT TO GROSS WEIGHT
 MOVE DOWN AND READ CALIBRATED TORQUE = 70%Q
 MOVE UP AND READ FUEL FLOW = 161 LB/HR
 MOVE RIGHT, READ IAS = 96 KNOTS

100% RPM
 FAT = -30°C

PRESSURE ALTITUDE — SEA LEVEL
FUEL FLOW — LB/HOUR

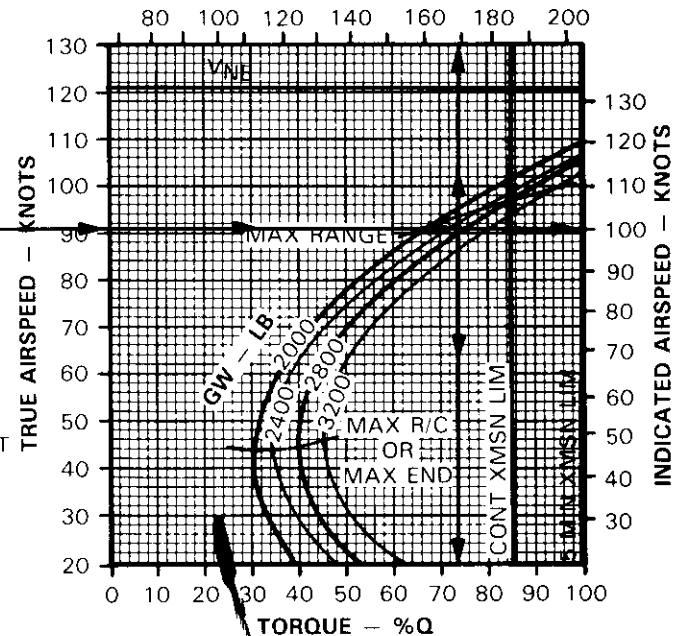

PRESSURE ALTITUDE — 2000 FEET
FUEL FLOW — LB/HOUR

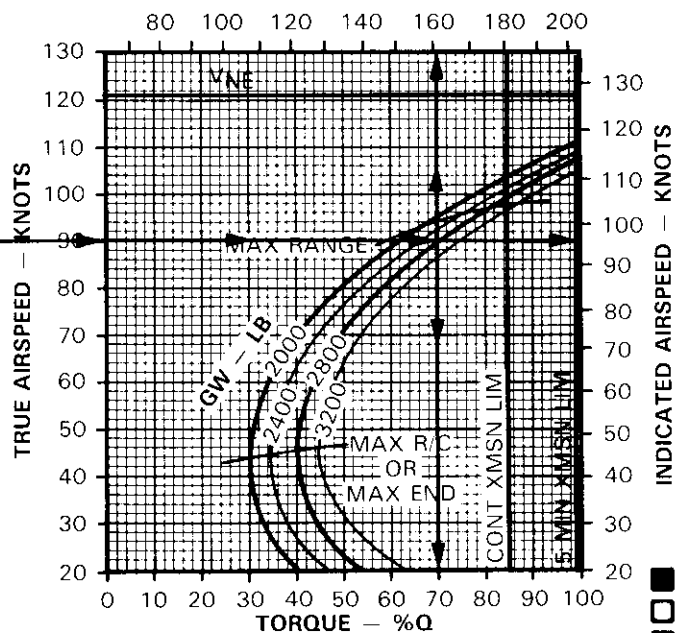

DATA BASIS: DERIVED FROM BELL HELICOPTER TEXTRON FLIGHT TEST

MS026112

Figure 7-15. Cruise Chart (Sheet 1 of 13)



CRUISE
PRESSURE ALTITUDE — 4000 FEET TO 6000 FEET
CLEAN CONFIGURATION JP-4/JP-5 FUEL OGE
100% RPM
FAT = -30°C

CRUISE
 OH-58C
 T63-A-720

EXAMPLE B

WANTED

SPEED FOR MAXIMUM RANGE
 TORQUE REQUIRED AND FUEL FLOW AT MAXIMUM RANGE
 SPEED FOR MAXIMUM ENDURANCE

KNOWN

CLEAN CONFIGURATION, FAT = -30°C,
 PRESSURE ALTITUDE = 4000 FEET,
 AND GROSS WEIGHT = 2800 POUNDS

METHOD

LOCATE (-30°C FAT, 4000 FEET) CHART
 FIND INTERSECTION OF 2800 LB GROSS WEIGHT LINE
 WITH THE MAXIMUM RANGE LINE
 TO READ SPEED FOR MAXIMUM RANGE:
 MOVE LEFT, READ TAS = 98.5 KNOTS AND
 MOVE RIGHT, READ IAS = 101 KNOTS
 TO READ FUEL FLOW REQUIRED:
 MOVE UP, READ FUEL FLOW = 170 LB/HR
 TO READ TORQUE REQUIRED:
 MOVE DOWN, READ TORQUE = 79.5%Q
 FIND INTERSECTION OF 2800 LB GROSS WEIGHT LINE
 WITH THE MAXIMUM ENDURANCE LINE
 TO READ SPEED FOR MAXIMUM ENDURANCE
 MOVE LEFT, READ TAS = 47 KNOTS AND
 MOVE RIGHT, READ IAS = 46 KNOTS

PRESSURE ALTITUDE — 4000 FEET

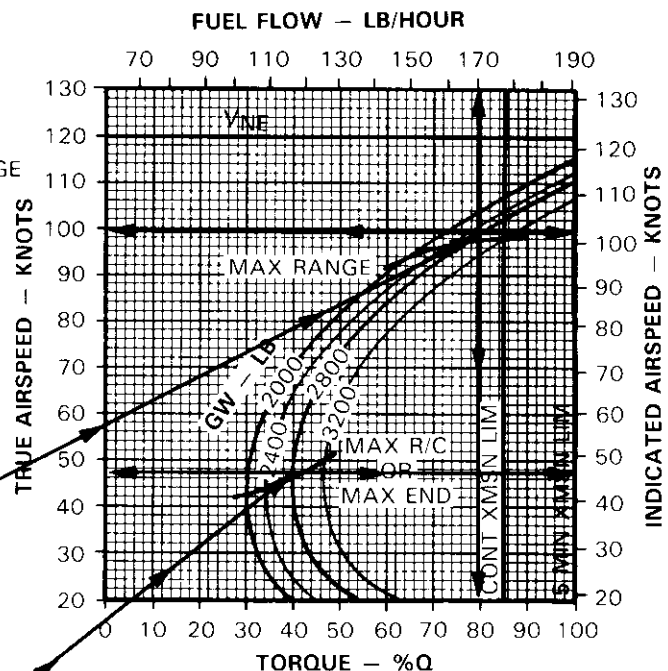

PRESSURE ALTITUDE — 6000 FEET

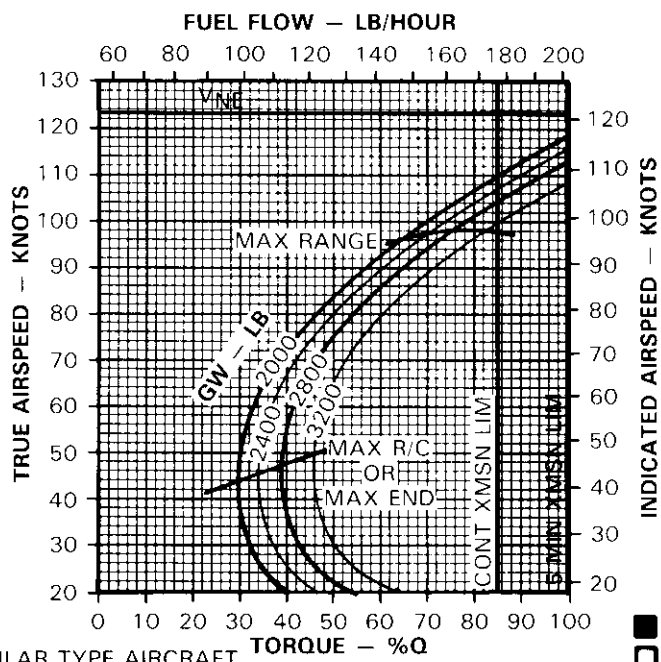

DATA BASIS: DERIVED FROM FLIGHT TEST OF SIMILAR TYPE AIRCRAFT



MS026113

Figure 7-15. Cruise Chart (Sheet 2 of 13)

CRUISE

**PRESSURE ALTITUDE — 8000 FEET TO 14000 FEET
CLEAN CONFIGURATION JP-4/JP-5 FUEL OGE**

**100% RPM
FAT = - 30°C**

**CRUISE
OH-58C
T63-A-720**

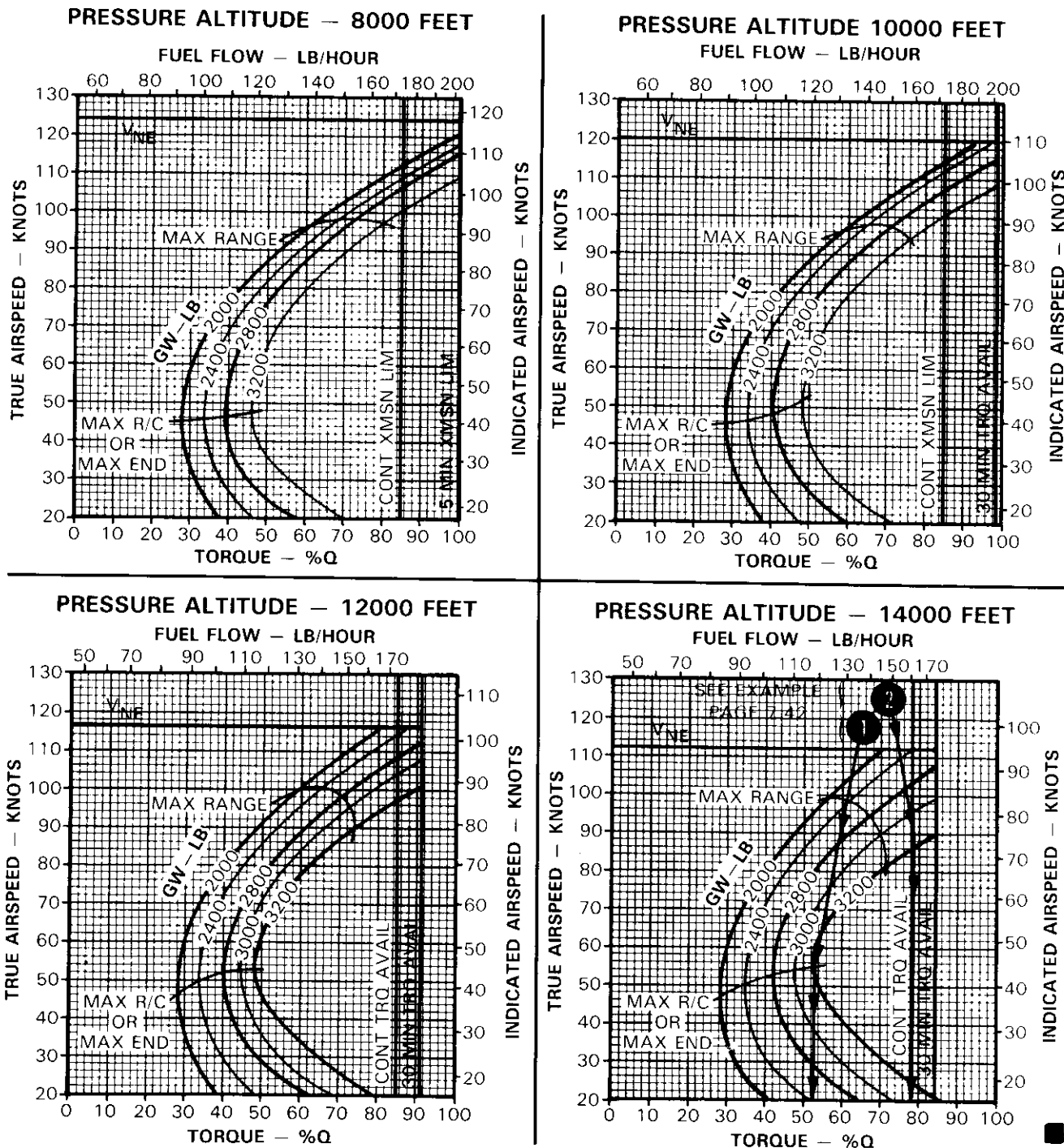

DATA BASIS: DERIVED FROM FLIGHT TEST, ASTA PROJECT NO. 68-30, SEPTEMBER 1970

Figure 7-15. Cruise Chart (Sheet 3 of 13)

CRUISE

**PRESSURE ALTITUDE — SEA LEVEL TO 6000 FEET
CLEAN CONFIGURATION JP-4/JP-5 FUEL OGE**

**100% RPM
FAT = -15°C**

**CRUISE
OH-58C
T63-A-720**

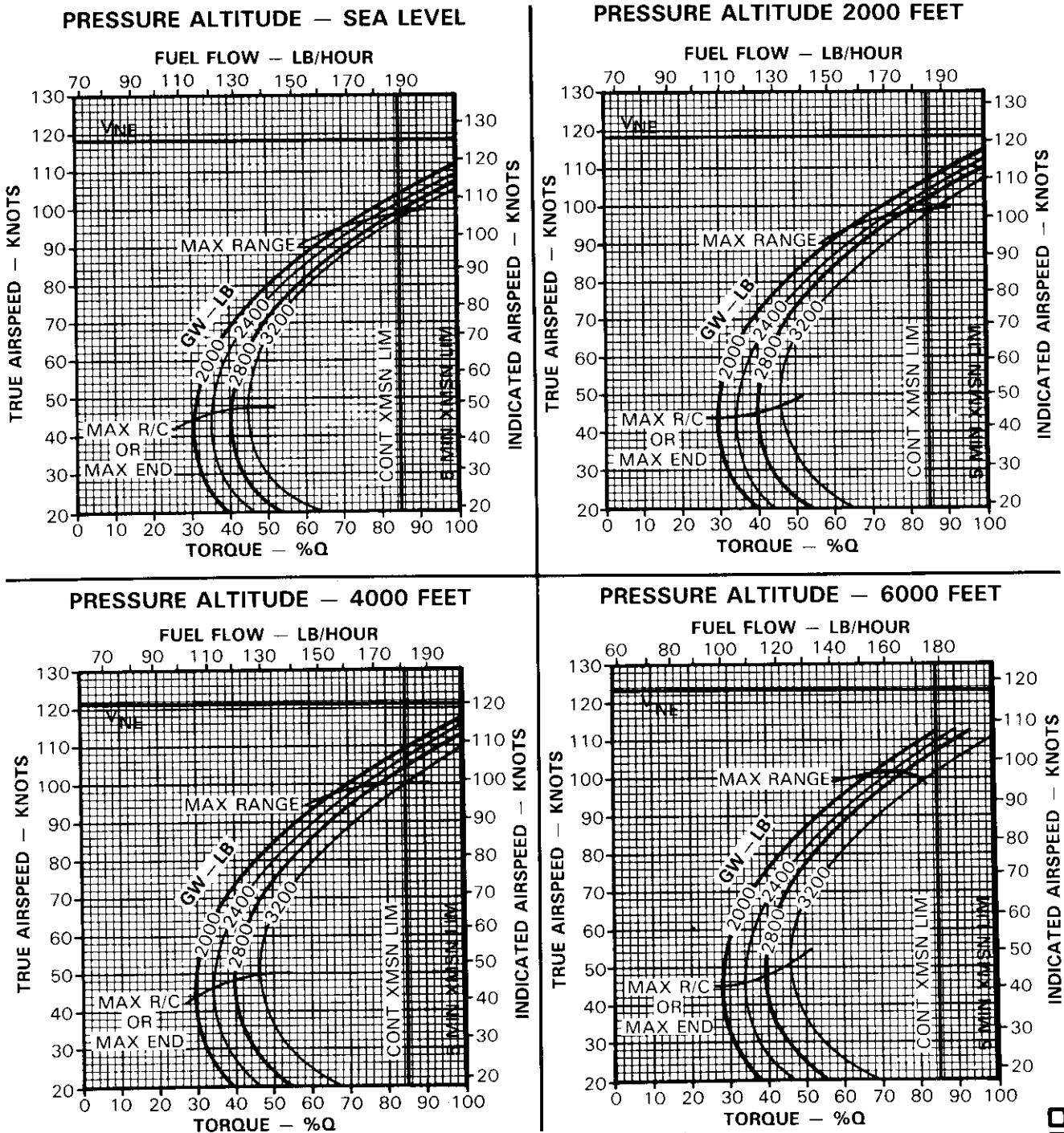

DATA BASIS: DERIVED FROM FLIGHT TEST, ASTA PROJECT NO. 68-30, SEPTEMBER 1970

MS026115

Figure 7-15. Cruise Chart (Sheet 4 of 13)

CRUISE

**PRESSURE ALTITUDE — 8000 FEET TO 14000 FEET
CLEAN CONFIGURATION JP-4/JP-5 FUEL OGE**

**CRUISE
OH-58C
T63-A-720**

100% RPM

FAT = -15°C

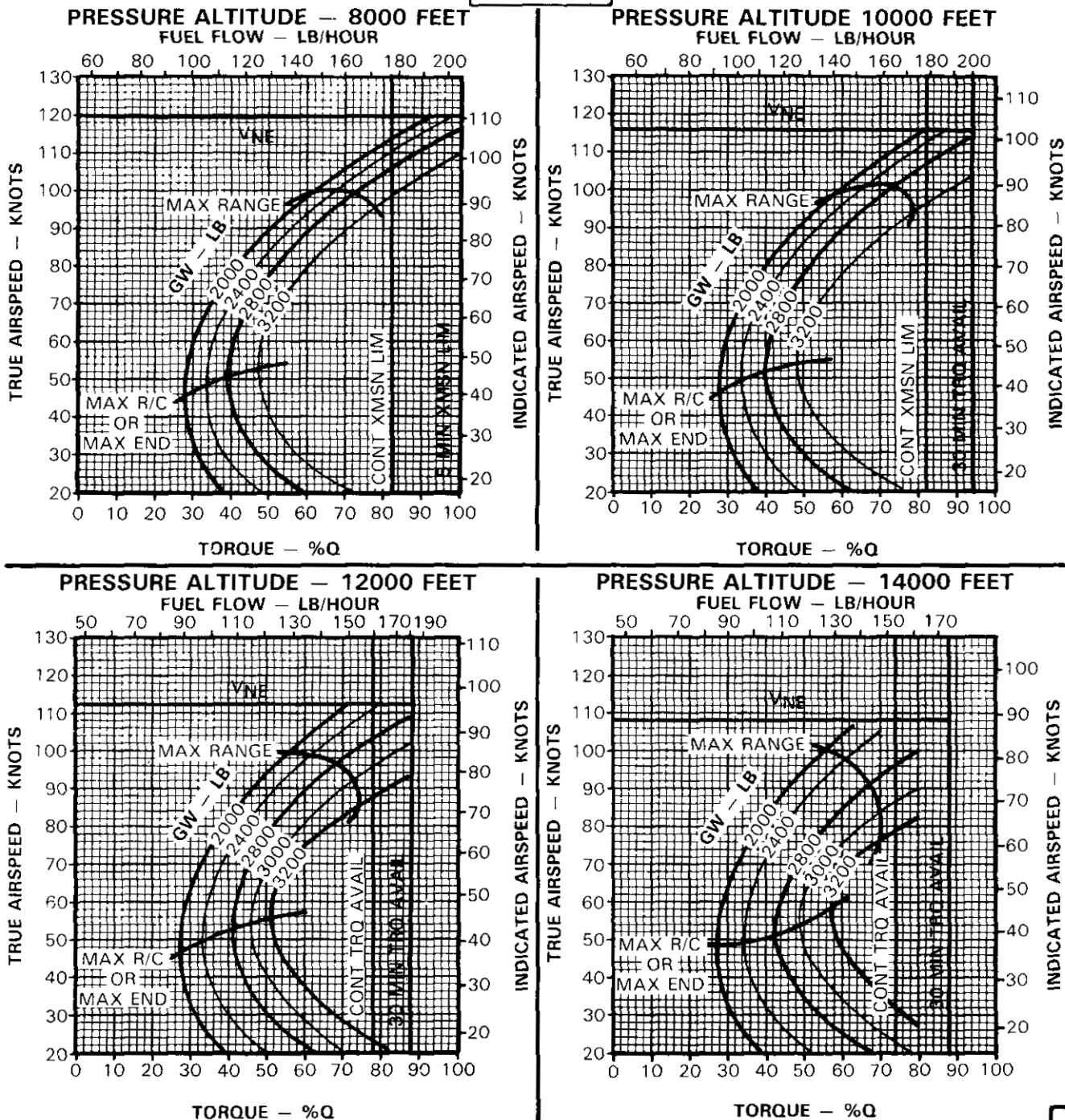

DATA BASIS: DERIVED FROM FLIGHT TEST, ASTA PROJECT NO. 68-30, SEPTEMBER 1970

Figure 7-15. Cruise Chart (Sheet 5 of 13)



CRUISE

PRESSURE ALTITUDE — SEA LEVEL TO 6000 FEET
 CLEAN CONFIGURATION JP-4/JP-5 FUEL OGE
 100% RPM

FAT = +15°C

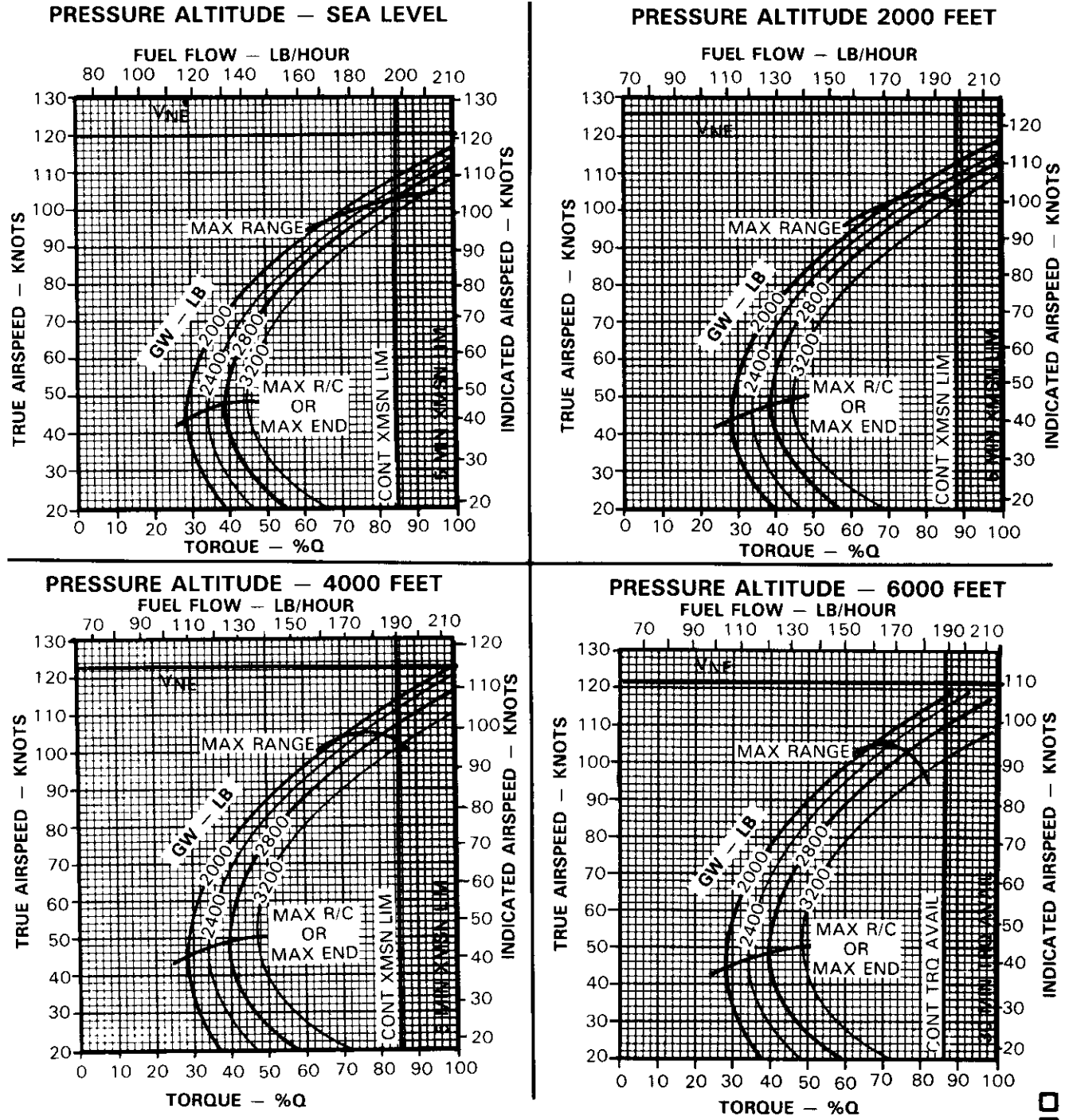

DATA BASIS: DERIVED FROM FLIGHT TEST, ASTA PROJECT NO. 68-30, SEPTEMBER 1970



MS026118

Figure 7-15. Cruise Chart (Sheet 6 of 13)



CRUISE

**PRESSURE ALTITUDE — 8000 FEET TO 14000 FEET
CLEAN CONFIGURATION JP-4/JP-5 FUEL OGE**

**CRUISE
OH-58C
T63-A-720**

**100% RPM
FAT = 0°C**

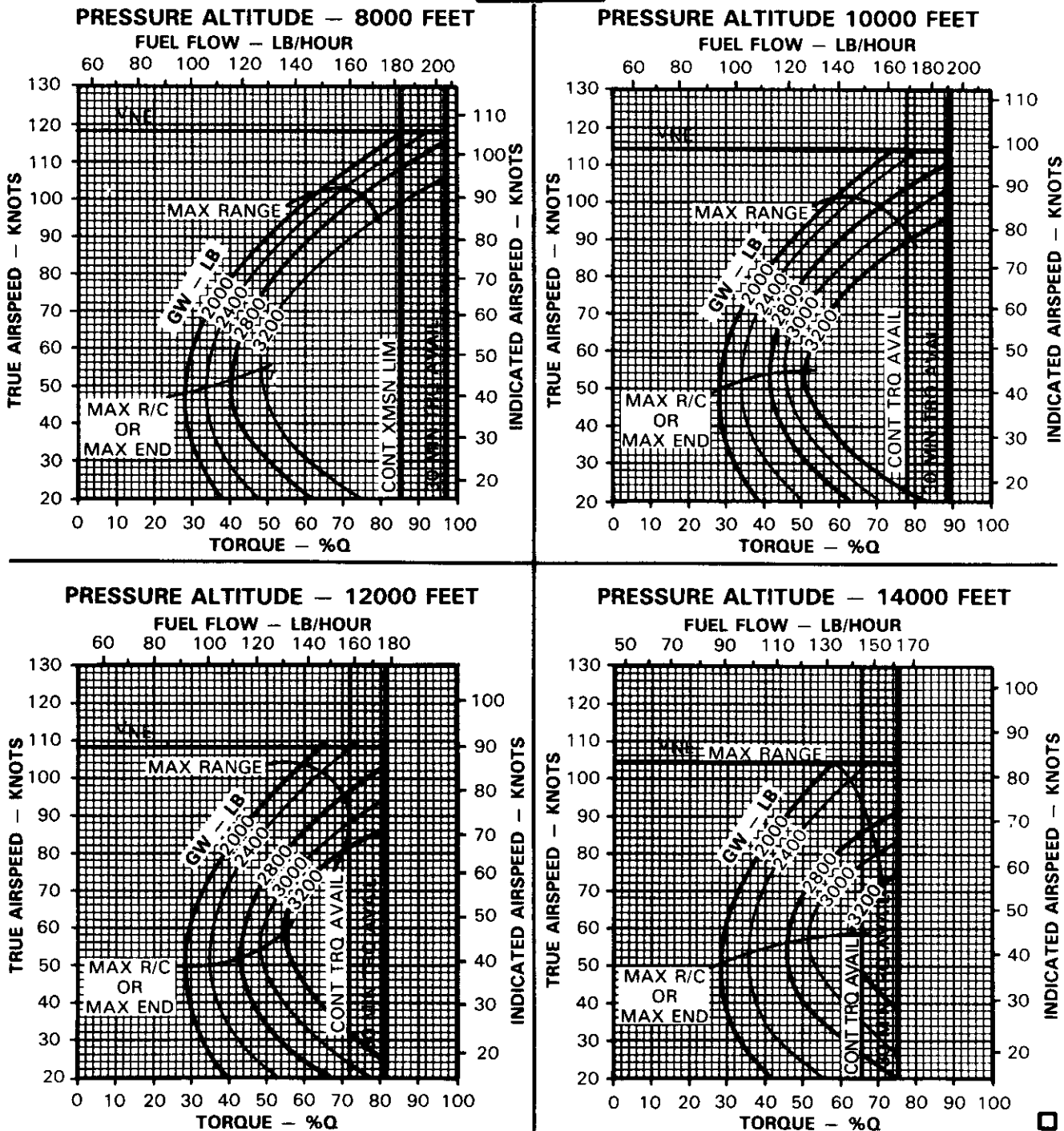

DATA BASIS: DERIVED FROM FLIGHT TEST, ASTA PROJECT NO. 68-30, SEPTEMBER 1970



MS026117

Figure 7-15. Cruise Chart (Sheet 7 of 13)



CRUISE
PRESSURE ALTITUDE – SEA LEVEL TO 6000 FEET
CLEAN CONFIGURATION JP-4/JP-5 FUEL OGE

CRUISE
OH-58C
T63-A-720

100% RPM
FAT = +30°C

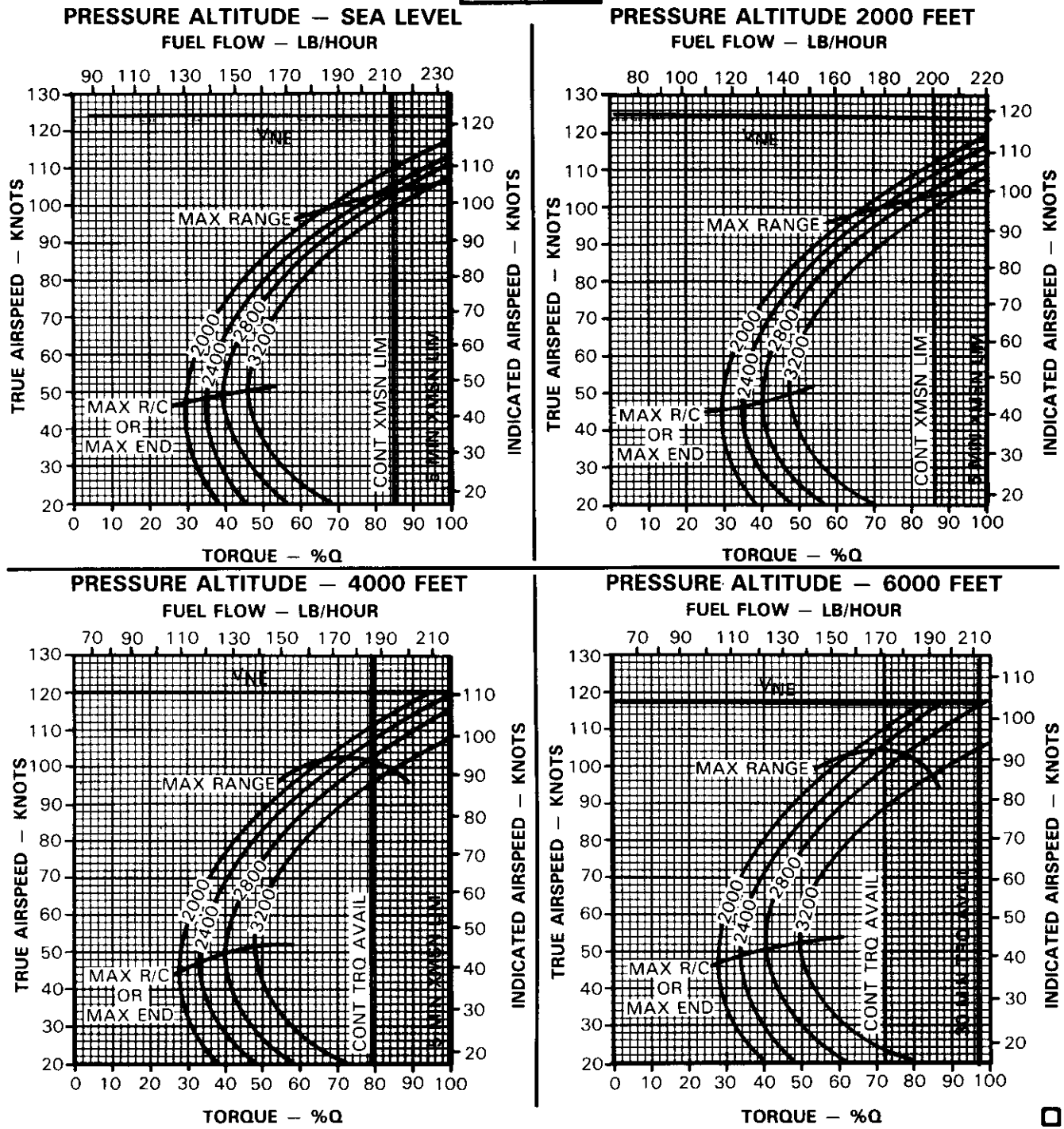

DATA BASIS: DERIVED FROM FLIGHT TEST, ASTA PROJECT NO. 68-30, SEPTEMBER 1970



MS026120

Figure 7-15. Cruise Chart (Sheet 8 of 13)



CRUISE

**PRESSURE ALTITUDE — SEA LEVEL TO 6000 FEET
CLEAN CONFIGURATION JP-4/JP-5 FUEL OGE**

**CRUISE
OH-58C
T63-A-720**

**100% RPM
FAT = +30°C**

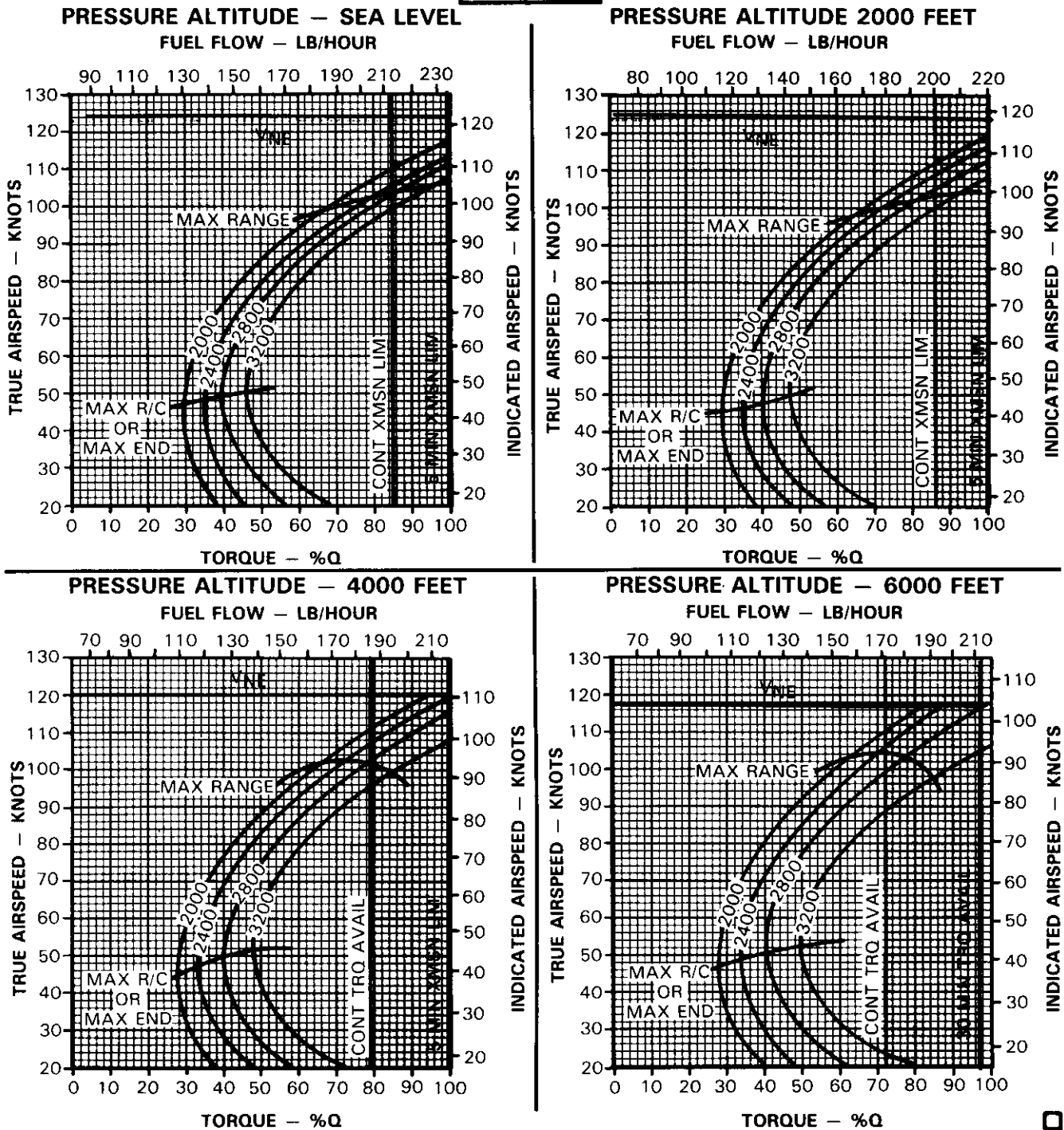

DATA BASIS: DERIVED FROM FLIGHT TEST, ASTA PROJECT NO. 68-30, SEPTEMBER 1970



MS026120

Figure 7-15. Cruise Chart (Sheet 9 of 13)

CRUISE

**PRESSURE ALTITUDE — SEA LEVEL TO 6000 FEET
CLEAN CONFIGURATION JP-4/JP-5 FUEL OGE
100% RPM**

**CRUISE
OH-58C
T63-A-720**

FAT = +45°C

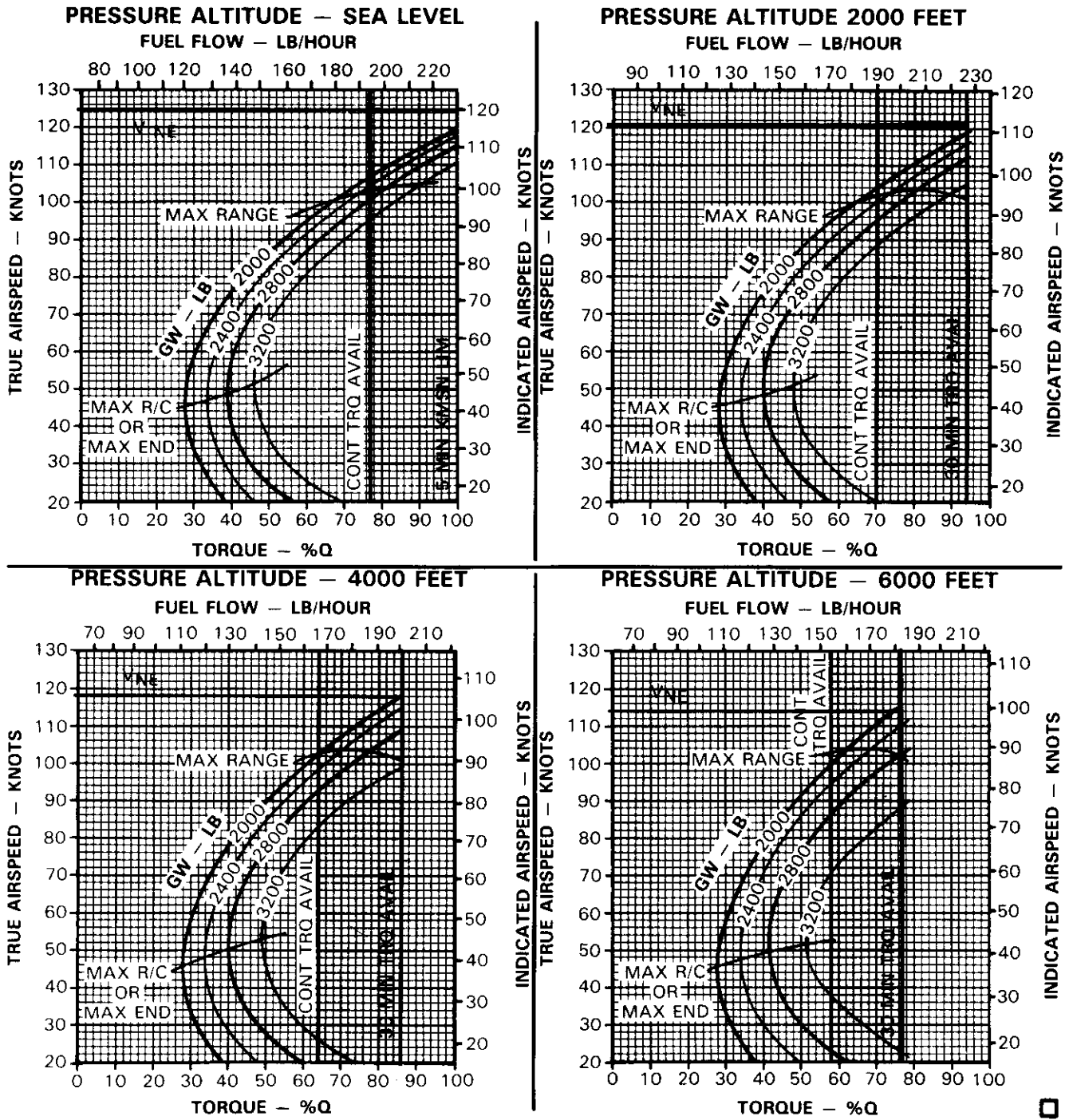

DATA BASIS: DERIVED FROM FLIGHT TEST, ASTA PROJECT NO. 68-30, SEPTEMBER 1970

MS026122

Figure 7-15. Cruise Chart (Sheet 10 of 13)



CRUISE
PRESSURE ALTITUDE — 8000 FEET TO 14000 FEET
CLEAN CONFIGURATION JP-4/JP-5 FUEL OGE
100% RPM

CRUISE
OH-58C
T63-A-720

FAT = +30°C

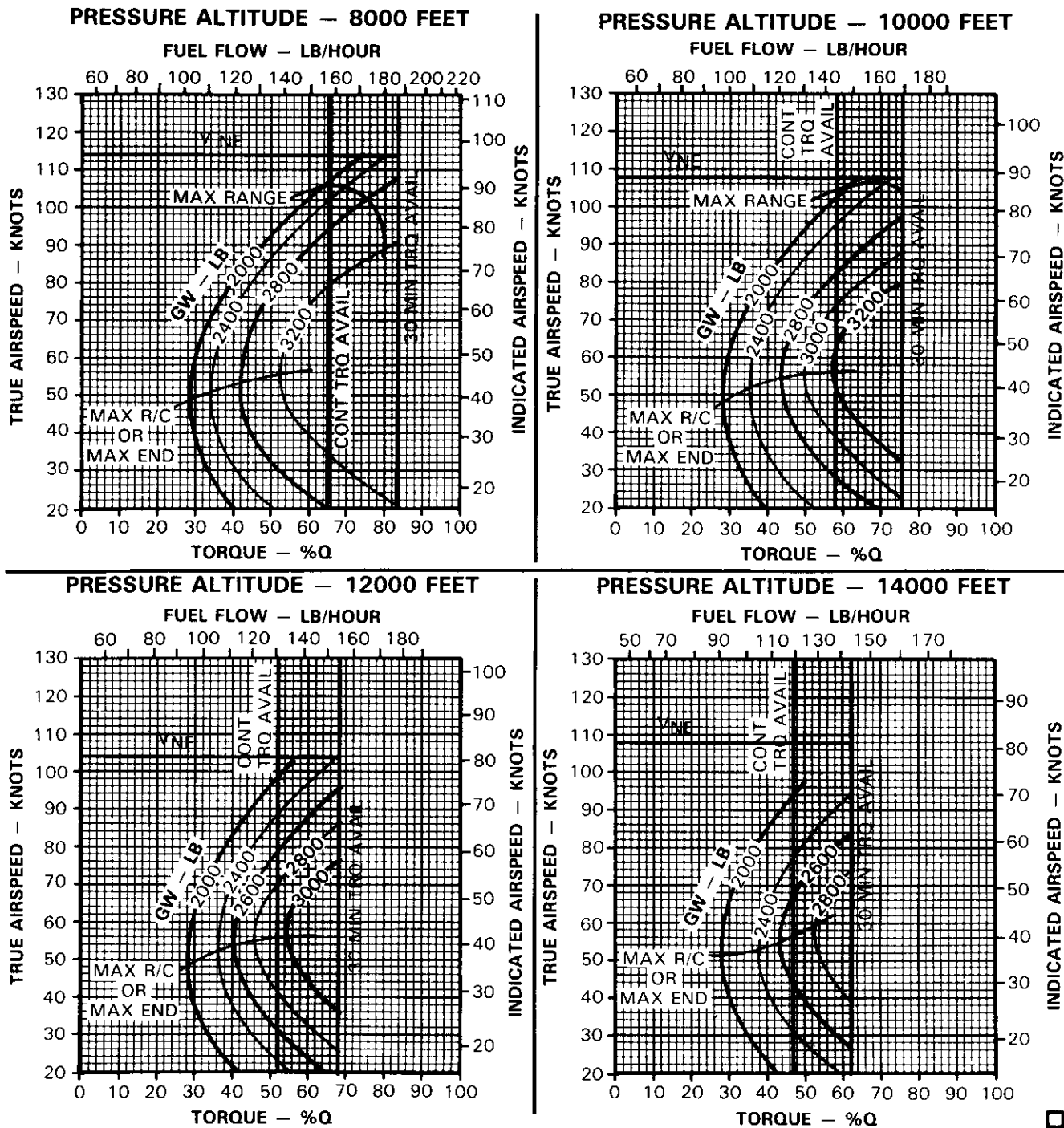

DATA BASIS: DERIVED FROM FLIGHT TEST, ASTA PROJECT NO. 68-30, SEPTEMBER 1970



MS026121

Figure 7-15. Cruise Chart (Sheet 11 of 13)

CRUISE

**PRESSURE ALTITUDE — SEA LEVEL TO 6000 FEET
CLEAN CONFIGURATION JP-4/JP-5 FUEL OGE
100% RPM**

**CRUISE
OH-58C
T63-A-720**

FAT = +45°C

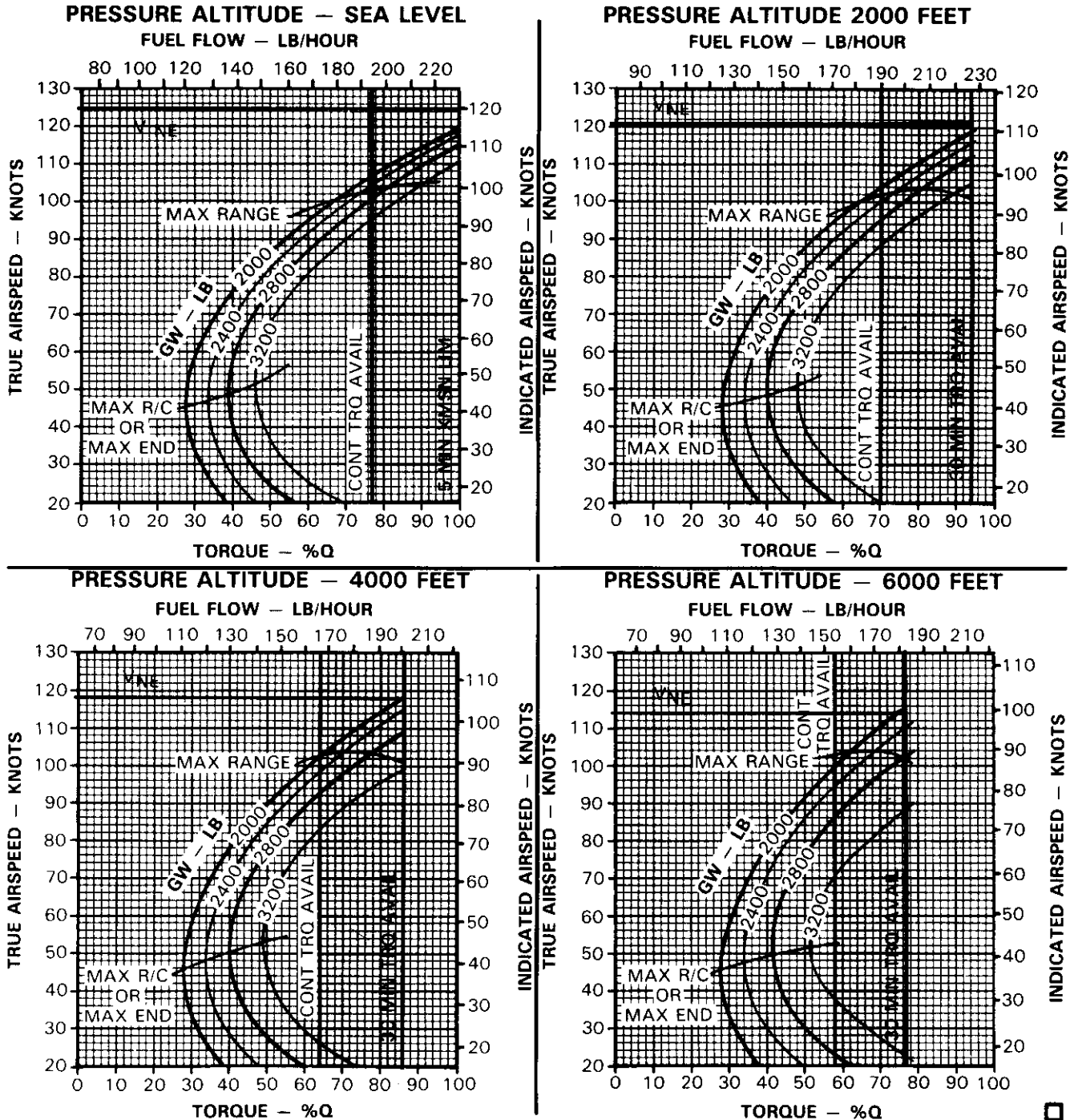

DATA BASIS: DERIVED FROM FLIGHT TEST, ASTA PROJECT NO. 68-30, SEPTEMBER 1970

MS026122

Figure 7-15. Cruise Chart (Sheet 12 of 13)



CRUISE

**PRESSURE ALTITUDE — 8000 FEET TO 14000 FEET
 CLEAN CONFIGURATION JP-4/JP-5 FUEL OGE
 100% RPM**

**CRUISE
 OH-58C
 T63-A-720**

FAT = +45°C

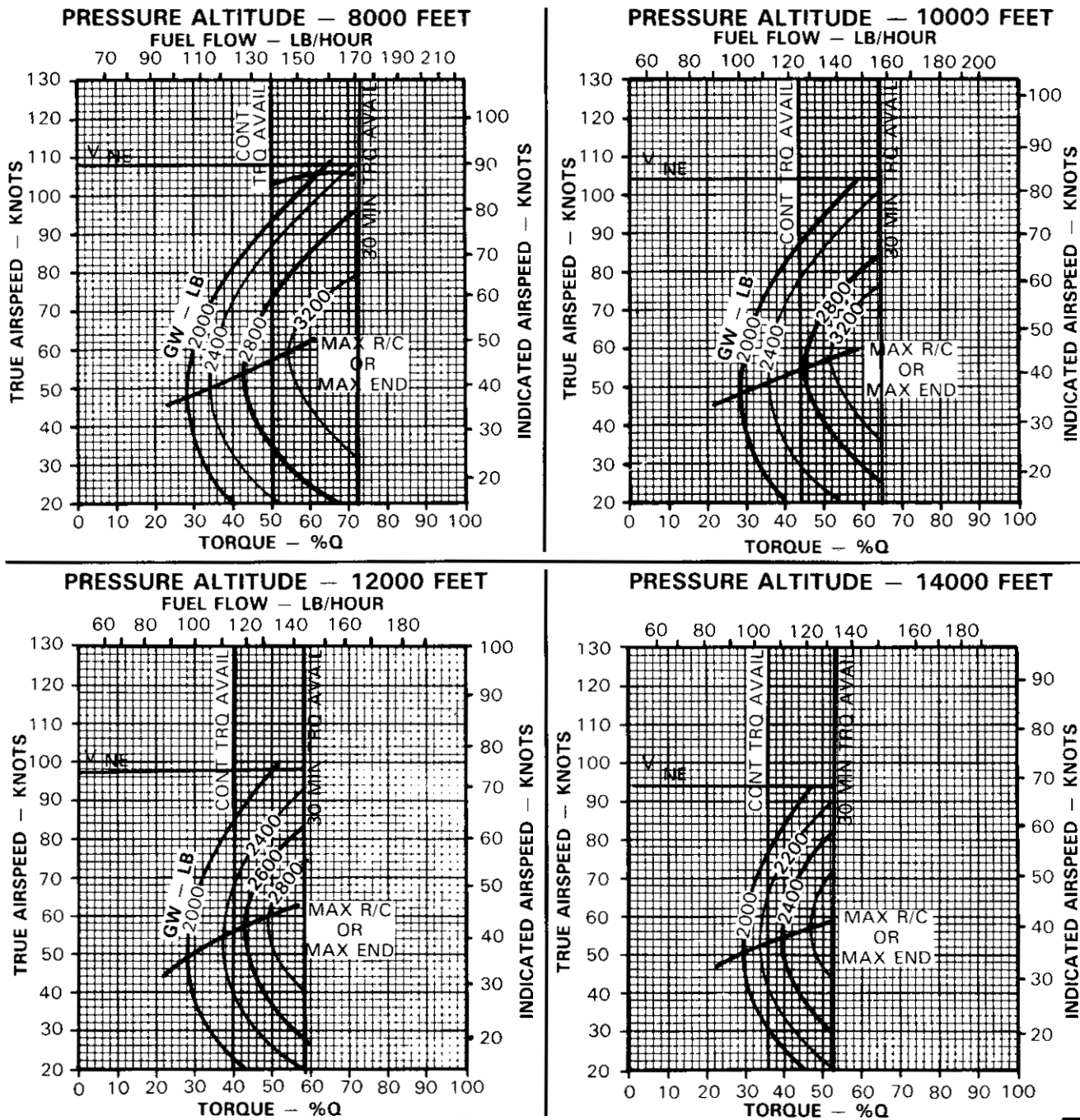

DATA BASIS: DERIVED FROM FLIGHT TEST, ASTA PROJECT NO. 68-30, SEPTEMBER 1970



MS026123

Figure 7-15. Cruise Chart (Sheet 13 of 13)

SECTION XIV DRAG

7-50. DESCRIPTION.

The drag chart (figure 7-16) shows the torque change required for flight due to drag area change as a result of external configuration changes. Note that the figure shows drag area change due to specific configurations.

7-51. USE OF CHART.

The primary use of the chart is illustrated by the example. To determine the change in torque it is necessary to know the drag area change, the true airspeed, the pressure altitude, and the free air temperature. Enter at

the known drag area change, move right to TAS, move down to pressure altitude, move left to FAT, then move down and read change in torque. In addition, by entering the chart in the opposite direction, drag area change may be found from a known torque change.

This chart is used to adjust cruise charts (figure 7-15, sheets 1 through 13) for appropriate torque and fuel flow due to equivalent flat plate drag area change (ΔF).

7-52. CONDITIONS.

The drag chart is based upon 100% rpm.

DRAG

DRAG
OH-58C
T63-A-720

EXAMPLE

WANTED

CHANGE IN TORQUE REQUIRED
DUE TO EQUIVALENT PLATE DRAG AREA
CHANGE, (ΔF) FROM ALL DOORS OFF
CONFIGURATION

KNOWN

DRAG AREA CHANGE = 1.6 SQ FT
TRUE AIRSPEED = 120 KNOTS
PRESSURE ALTITUDE = SEA LEVEL
FAT = -20°C

METHOD

ENTER DRAG AREA CHANGE HERE
MOVE RIGHT TO TRUE AIRSPEED
MOVE DOWN TO PRESSURE ALTITUDE
MOVE LEFT TO FAT
MOVE DOWN, READ CHANGE IN TORQUE = 11%Q

DATA BASIS: CALCULATED ADTA

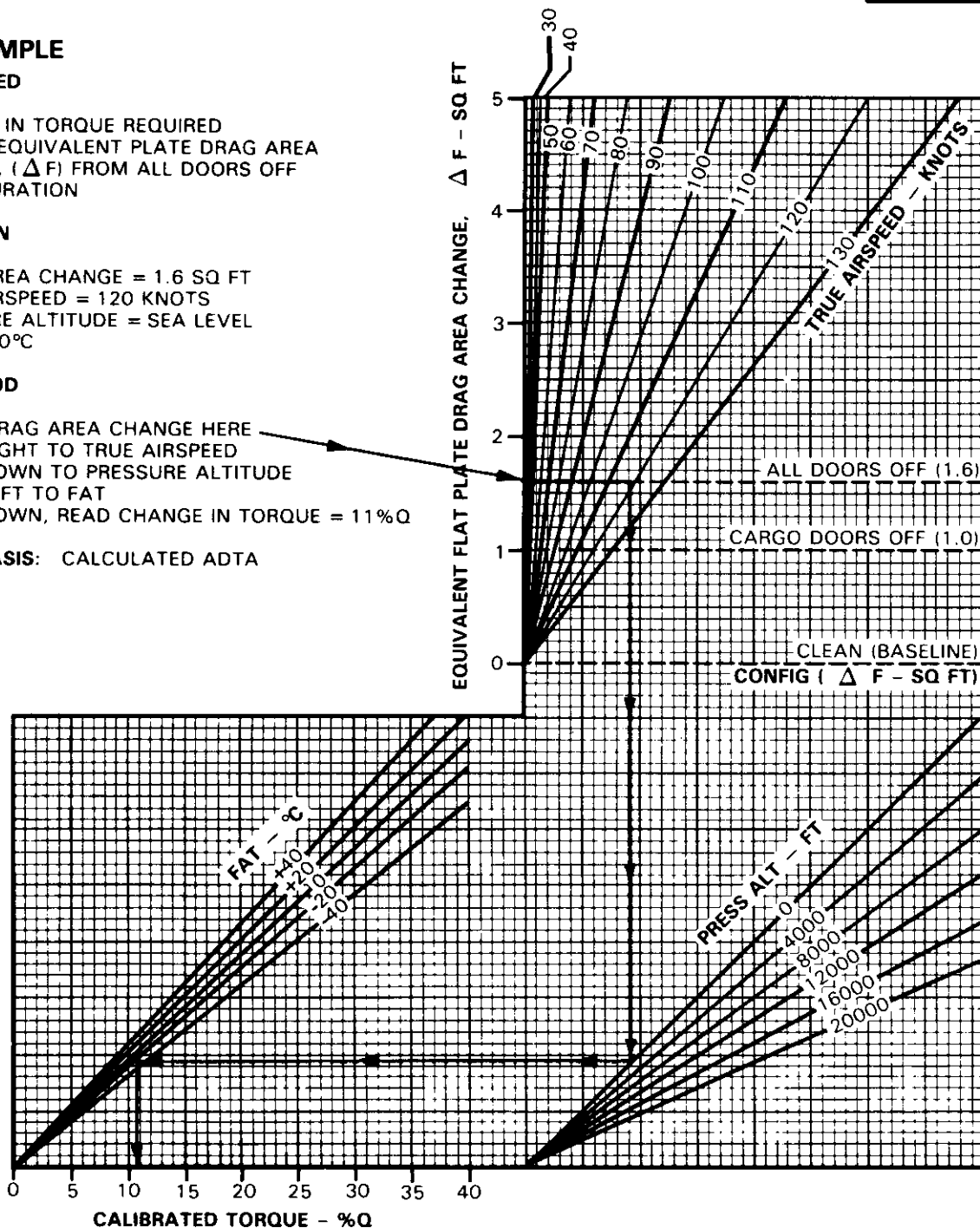

Figure 7-16. Drag Chart

MS026124

SECTION XV CLIMB — DESCENT

7-53. DESCRIPTION — CLIMB-DESCENT CHART.

The grid of the climb descent chart (figure 7-17) shows the change in torque (above or below torque required for level flight under the same gross weight, and atmospheric conditions) to obtain a given rate of climb or descent.

7-54. USE OF CLIMB-DESCENT CHART.

The primary uses of the chart are illustrated by the chart examples.

a. The torque change obtained from the grid scale must be added to the torque required for level flight (for climb) — or subtracted from the torque required for level flight (for descent) — obtained from the appropriate cruise chart in order to obtain a total climb or descent torque.

b. By entering the bottom of the grid with a known torque change, moving upward to the gross weight, and left to the corresponding rate of climb or descent may also be obtained.

7-55. CONDITIONS.

The climb-descent chart is based on the use of 100% rpm.

EXAMPLE

WANTED (SEE FIGURE 7-15)

EXCESS TORQUE AVAILABLE FOR CLIMB AT MAXIMUM CONTINUOUS POWER

KNOWN

CLEAN CONFIGURATION

GROSS WEIGHT = 3200 LB

PRESSURE ALTITUDE = 14000 FEET

FAT = -30°C

METHOD

LOCATE CHART (FIGURE 7-15, SHEET 3)

FIND INTERSECTION OF 3200 LB GROSS WEIGHT LINE WITH THE MAXIMUM RATE OF CLIMB LINE **1**

MOVE DOWN, READ TORQUE REQUIRED = 53%Q

FIND INTERSECTION OF 3200 LB GROSS WEIGHT LINE WITH CONTINUOUS TORQUE AVAILABLE LINE **2**

MOVE DOWN, READ TORQUE AVAILABLE = 78%Q

EXCESS TORQUE AVAILABLE = (78-53) = 25%Q

WANTED (SEE FIGURE 7-17)

RATE OF CLIMB AT 70 KIAS

MAXIMUM CONTINUOUS POWER

KNOWN

EXCESS TORQUE AVAILABLE
(FROM FIGURE 7-15, SHEET 3) = 25% Q

GROSS WEIGHT = 3200 LB

METHOD

ENTER CALIBRATED TORQUE SCALE HERE **3**

MOVE UP TO GROSS WEIGHT LINE

MOVE LEFT TO RATE OF CLIMB OR
DESCENT SCALE, READ RATE OF
CLIMB = 1290 FT/MIN

CLIMB — DESCENT 100% RPM

CLIMB — DESCENT
OH-58C
T63-A-720

**EXAMPLE A
WANTED**

CALIBRATED TORQUE CHANGE
FOR DESIRED R/C OR R/D

KNOWN OR ESTIMATED

GROSS WEIGHT = 2600 LB
DESIRED R/C = 700 FT/MIN

METHOD

ENTER R/C HERE →

MOVE RIGHT TO GROSS WEIGHT

MOVE DOWN, READ CALIBRATED
TORQUE CHANGE = 11%Q

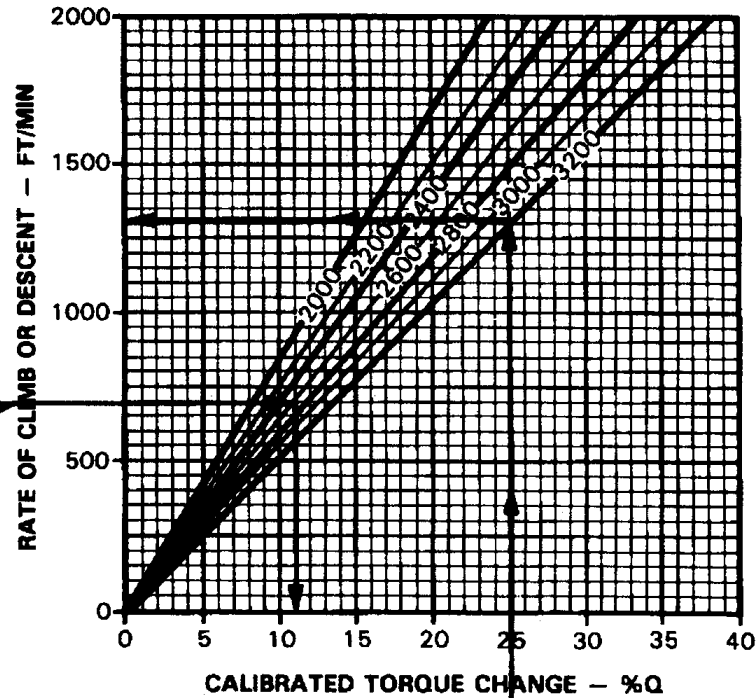

REMARK: TORQUE CHANGE IS THE DIFFERENCE BETWEEN THE TORQUE USED DURING THE CLIMB OR DESCENT AND THE TORQUE REQUIRED FOR LEVEL FLIGHT AT THE SAME CONDITIONS (ALTITUDE, GROSS WEIGHT, AIRSPEED, CONFIGURATION, ETC)

Figure 7-17. Climb-Descent Chart ©

TM 55-1520-228-10

7-56. DELETED.

FIGURE 7-82, FIGURE 7-18 (SHEET 2 OF 2) and 7-83
HAVE BEEN DELETED.

7-57. DELETED.

7-58. DELETED.

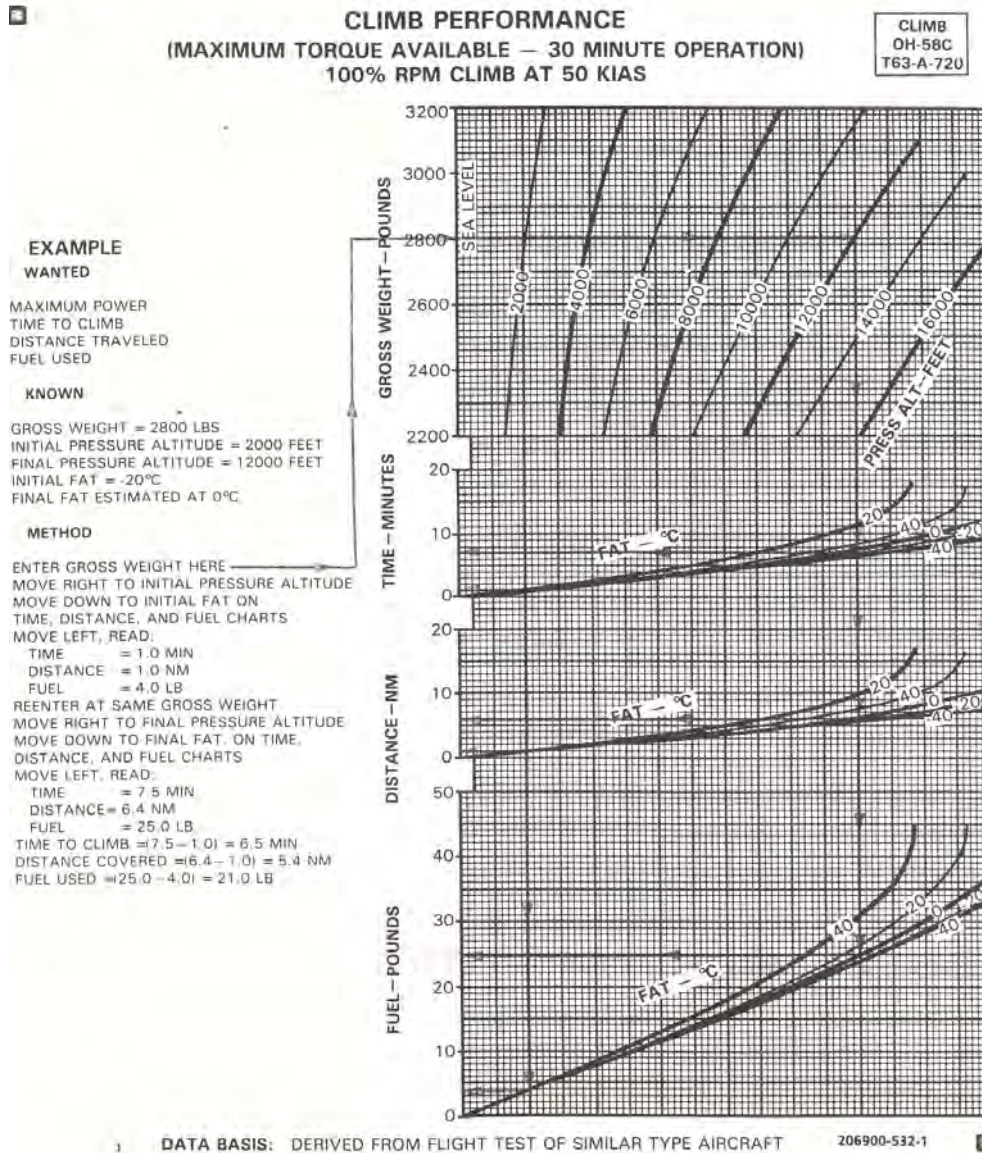

Figure 7-18. Climb Performance

SECTION XVI IDLE FUEL FLOW

7-59. DESCRIPTION.

The idle fuel flow chart (figure 7-19) shows the fuel flow at flight idle and at flat pitch with 100% rpm.

7-60. USE OF CHART.

The primary use of the chart is illustrated by the example. To determine idle flow, it is necessary to know the idle condition, pressure altitude, and free air tempera-

ture. Enter at the pressure altitude, move right to FAT in appropriate grid, then move down and read fuel flow on the scale corresponding to the condition. Refer to the cruise charts to obtain fuel flow for cruise power condition.

7-61. CONDITIONS.

This chart is based upon the use of JP-4 or JP-5 fuel and 100% rpm.

6

EXAMPLE
WANTED
 FUEL FLOW AT FLAT PITCH
 AND ENGINE IDLE

KNOWN
 PRESSURE ALTITUDE = 11200 FEET
 FAT = 0°C

METHOD
 ENTER PRESSURE ALTITUDE HERE
 MOVE RIGHT TO (FLAT PITCH)
 FAT = 0°C
 MOVE DOWN, READ FLAT PITCH
 FUEL FLOW = 84 LB/HR
 REENTER PRESSURE ALTITUDE HERE
 MOVE RIGHT TO (ENGINE IDLE)
 FAT = 0°C
 MOVE DOWN READ ENGINE IDLE
 FUEL FLOW = 48 LB/HR

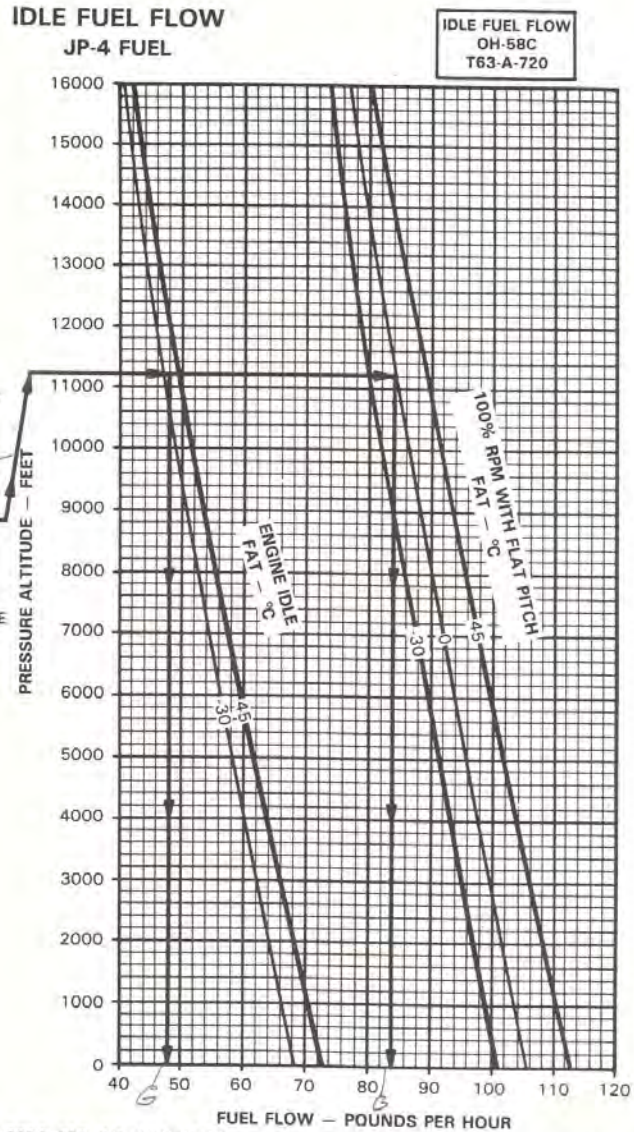

DATA BASIS: CALCULATED FROM MODEL SPEC 876, 25 JULY 1975,
 CORRECTED FOR INSTALLATION LOSSES BASED ON FLIGHT TEST OF SIMILAR TYPE AIRCRAFT

206900-533

6

Figure 7-19. Idle Fuel Flow Chart

CHAPTER 8 NORMAL PROCEDURES

SECTION I MISSION PLANNING

8-1. MISSION PLANNING.

Mission planning begins when the mission is assigned and extends to the preflight check of the helicopter. It includes, but is not limited to, checks of operating limits and restrictions; weight, balance and loading; performance, publications; flight plan; and crew and passenger briefings. The pilot shall ensure compliance with the contents of this manual which are applicable to the mission.

8-2. AVIATION LIFE SUPPORT EQUIPMENT (ALSE).

All aviation life support equipment required for mission; e. g., helmets, gloves, survival vests, survival kits, etc., shall be checked.

8-3. CREW DUTIES/RESPONSIBILITIES.

The minimum crew required to fly the helicopter is a pilot. During single pilot operations, the pilot shall occupy the right-hand pilot seat. Additional crew members, as required, may be added at the discretion of the commander. The manner in which each crew member performs his duties is the responsibility of the pilot in command.

a. Crew Briefing. A crew briefing shall be conducted to ensure a thorough understanding of individual and team responsibilities. The briefing should include, but not be limited to, copilot, crew chief, mission equipment operator, ground crew responsibilities, and the coordination necessary to complete the mission in the most efficient manner. A review of visual signals is desirable when ground guides do not have voice communication with the crew.

b. Passenger Briefing. The following guide may be used in accomplishing required passenger briefings; items that do not pertain to a specific mission may be omitted.

- (1) Crew introduction.
- (2) Equipment.
 - (a) Personal to include ID tags.
 - (b) Professional.
 - (c) Survival.
- (3) Flight data.
 - (a) Route.
 - (b) Altitude.
 - (c) Time enroute.
 - (d) Weather.
- (4) Normal procedures.
 - (a) Entry and exit of helicopter.
 - (b) Seating.

WARNING

Demonstrate to passenger how and where loose carry-on equipment will be secured. Demonstrate to passenger how seat belts and shoulder harnesses are to be used and how they are to be secured when exiting.

- (c) Seat belts.
- (d) Movement in the helicopter

- (e) Internal communication.
- (f) Security of equipment.
- (g) Smoking.
- (h) Oxygen.
- (i) Refueling.
- (j) Weapons.
- (k) Protective masks.
- (l) Parachutes.
- (m) Hearing protection.
- (n) Aviation life support equipment (ALSE).
- (5) Emergency procedures.
- (a) Emergency exits.
- (b) Emergency equipment.
- (c) Emergency landing/ditching procedures.
- (d) Bail out.
- (e) Survival.
- (f) Recovery.

SECTION II OPERATING PROCEDURES AND MANEUVERS

8-4. OPERATING PROCEDURES AND MANEUVERS.

This section deals with normal procedures and includes all steps necessary to ensure safe, efficient operation of the helicopter from the time a preflight begins until the flight is completed and the helicopter is parked and secured. Unique feel, characteristics, and reaction of the helicopter during various phases of operation and the techniques and procedures used for taxiing, takeoff, climb, etc., are described, including precautions to be observed. Your flying experience is recognized; therefore, basic flight principles are avoided. Only the duties of the minimum crew necessary for the actual operation of the helicopter are included. Additional crew duties are covered as necessary in Section I. Mission equipment checks are contained in Chapter 4. MISSION EQUIPMENT. Procedures specifically related to instrument flight that are different from normal procedures are covered in this section, following normal procedures. Descriptions of functions, operations, and effects of controls are covered in Section IV, FLIGHT CHARACTERISTICS, and are repeated in this section only when required for emphasis. Checks must be performed under adverse environmental conditions, such as desert and cold-weather operations, supplement normal procedures checks in this section and are covered in Section V, ADVERSE ENVIRONMENTAL CONDITIONS.

8-5. SYMBOLS DEFINITION.

The symbol "O" shall be used to indicate "if installed" the asterisk symbol "*" indicates that performance of step is mandatory for all thru-flights. The asterisk applies only to checks performed prior to takeoff. Placarded items such as switch and control labels appear in capital letters.

8-6. CHECKLIST.

Normal procedures are given primarily in checklist form, and amplified as necessary in accompanying paragraph form, when a detailed description of a procedure or maneuver is required. A condensed version of the amplified checklist, omitting all explanatory text, is contained in the operator's checklist. To provide for easier cross-referencing, the procedural steps in the condensed checklist are numbered to coincide with the corresponding numbered steps in this manual.

8-7. PREFLIGHT CHECK.

The pilot walk-around and interior checks are outlined in the following procedures. The preflight check is not intended to be a detailed mechanical inspection. The steps that are essential for safe helicopter operation are included. The preflight may be made as comprehensive as conditions warrant at the discretion of the pilot.

8-8. BEFORE EXTERIOR CHECKS.

1. Deleted.

2. Publications — Check DA Forms 2408-12, -3, -14, and -18; DD Form 1896 if required; DD Form 365-4; Compass Cards; locally required forms, records and publications; and availability of operator's manual (-10) and checklist (-CL).

*3. Covers, locking devices, tiedowns (except main rotor), and grounding cables – Removed and secured.

*4. Ignition switch – On.

5. Cockpit – Check as follows:

a. FUEL BOOST switch – OFF.

b. BAT switch – BAT (check fuel quantity).

c. NON-ESS BUS switch – MAN.

d. Lights – Check and set if use is anticipated (LDG, ANTI-COLLISION, POS, CONSOLE, INST, and NVG lights).

e. WARNING and CAUTION lights – Check for illumination of the ROTOR RPM, MASTER CAUTION, ENGINE OUT, and XMSN OIL PRESS lights. Press the WARNING LTS TEST lights. Press the WARNING LTS TEST switch to check XMSN OIL HOT light. Test caution lights and reset. DC GENERATOR, HYD PRESS, and INST INVERTER caution lights should remain illuminated. Do not fly if any of these lights fail to illuminate.

f. BAT switch – OFF.

g. Pilot seat, seat belt, shoulder harness, and armor side panels – Check condition.

h. Crew Door – Check condition.

8-9. EXTERIOR CHECK.**8-10. AREA 1 (FIGURE 8-1) – FUSELAGE – CABIN RIGHT SIDE.**

1. Cabin Interior – Check as follows:

*a. Cargo/loose equipment – Check for proper loading and tiedown.

*b. Auxiliary fuel cell – Check condition, fuel level, and cap secure.

*c. Passenger seats and belts – Check as follows:

(1) Check seat and back cushions for condition and security. Ensure seat belts are through loops on seat and back cushions and secured with nylon safety cord.

(2) Check tabs on top of seat back for condition and security.

(3) Check seat belts and shoulder harnesses for condition and security. Ensure shoulder harnesses and belts are properly fastened together and tightened when not in use.

(4) If seat belts are not installed, seat and back cushions must be removed prior to flight with doors left off.

d. First aid kit – Check.

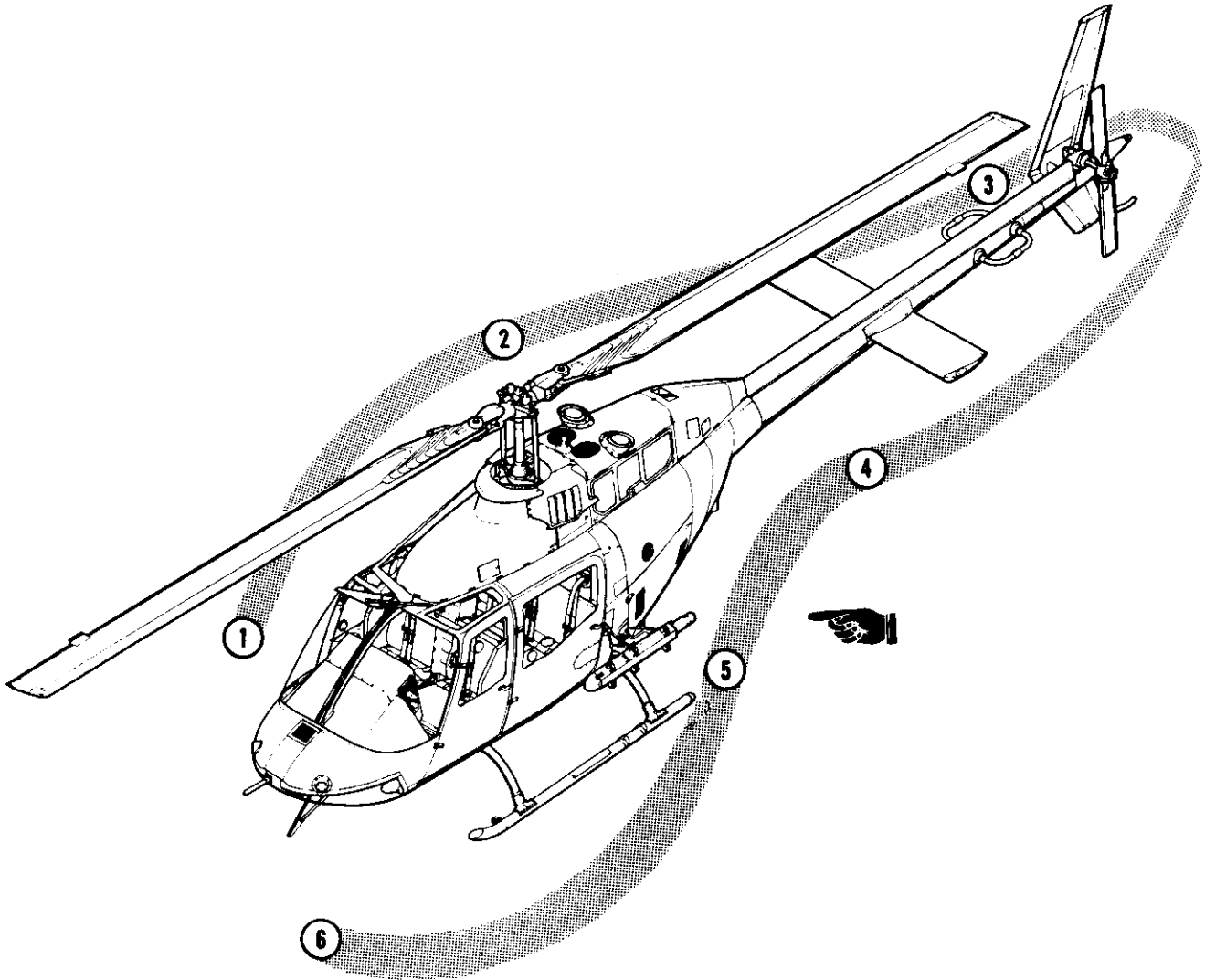

MS026128

Figure 8-1. Exterior Check Diagram

- e. Fire extinguisher – Check.
 - f. Cabin door – Check condition.
2. Fuselage – Check as following items are checked.
- a. Static port – Check unobstructed.
 - b. Landing gear – Check condition of cross-tubes, skid, skid shoe(s), wheels removed.
 - c. Fuel sample – Check for contamination before first flight of day. If fuel sump has not been drained, drain a sample and check.
 - *d. Hydraulic reservoir/servos and flight controls – Check condition and oil levels. Hydraulic filter button in. Secure door.
 - *e. Transmission compartment – Check condition and oil level. Secure door.
 - f. Engine inlet and plenum – Check clear.
 - g. Engine compartment – Check condition; lines, cables, and connections for condition and leaks. Secure door.
 - *h. Fuel – Check quantity first flight of day and when refueled. cap secure.
 - i. FM homing antenna – Check condition.
 - j. Drain lines and vents – Check unobstructed.
 - k. Transmission and engine cowling – Check secure.
 - l. Engine oil tank – Check condition, cap secure. Close door.

8-11. AREA 2 (FIGURE 8-1) TAILBOOM – RIGHT SIDE.

1. Tailboom – Check as following items are checked:
- a. Driveshaft cover – Check secure.
 - b. Tail rotor drive – Check shaft, collars, bearings, and hangers for condition, slippage marks (if cover not installed).
 - c. Horizontal stabilizer – Check condition.

d. Vertical fin – Check condition; antenna connections secure.

e. Tail skid – Check condition.

*2. Main rotor blade – Check condition, rotate 90 degrees to fuselage, tiedown removed.

8-12. AREA 3 (FIGURE 8-1) TAILBOOM – LEFT SIDE.

*1. Tail rotor gearbox – Check condition, oil level, filler cap, and chip detector wire secure.

*2. Tail rotor – Check condition.

3. Tailboom – Check as following items are checked:

a. Driveshaft cover – Check secure.

b. Horizontal stabilizer – Check condition.

8-13. AREA 4 (FIGURE 8-1) AFT FUSELAGE – LEFT SIDE.

1. Fuselage – Check as following items are checked:

a. Oil tank compartment – Check condition of oil cooler, driveshaft, oil lines, and external oil filter bypass. Secure door.

*b. Engine oil level – Check.

c. Avionics compartment – Check condition of compartment and tailboom slippage marks. Secure door.

d. Engine compartment – Check condition of lines, and connections for security and leaks. Secure door.

e. FM homing antenna – Check condition

f. Transmission compartment – Check condition. Secure door.

g. Hydraulic servos and flight controls – Check.

h. External oil filter bypass – Check.

2. Main rotor blade – Check condition.

8-14. AREA 5 (FIGURE 8-1) FUSELAGE – CABIN LEFT SIDE.

1. Fuselage top – Check as following items are checked:

- a. Engine inlet and plenum – Check clear.
- b. Engine oil cooler exhaust – Check.
- c. Engine exhaust – Check.
- d. Hydraulic reservoir, lines, slippage marks and flight controls – Check and ensure filter buttons are in.
- e. Transmission oil filter – Check cap secure.
- f. Transmission oil cooler exhaust – Check condition.
- g. Cowling – Check secure.

NOTE

Ensure swashplate is level for inspection of outer-ring self-aligning bearings for main rotor push-pull tubes.

*2. Main rotor system – Check condition, slippage marks, swashplate, and flight controls.

3. Fuselage top – Check as following items are checked:

- a. Mission equipment – Check.
- b. Cabin door – Check condition.
- c. Landing gear – Check condition, cross tubes, skid, skid shoe(s). Wheels removed.

4. Cockpit – Check as follows:

- a. Copilot seat, seat belts, shoulder harness and armor side panels (if installed) – Check condition.

Secure seat belts and shoulder harness if seat is not used.

b. Cyclic – Check secure or stow as required, cannon plug connected.

c. Collective – Check secure or stow as required.

d. Cabin door – Check condition.

8-15. AREA 6 (FIGURE 8-1) FUSELAGE – FRONT.

1. Fuselage – Check as following items are checked:

a. Static port – Check.

b. Upper WSPS – Check.

c. Windshield – Check.

d. Ram air grill – Check.

e. Pitot tube – Check.

f. Lower WSPS – Check.

g. Fuselage underside – Check.

*2. Crew and passenger briefing – Complete as required.

8-16. BEFORE STARTING ENGINE.

1. Deleted.

2. Shoulder harness lock(s) – Check operation.

3. Overhead switches and circuit breakers – Set as follows:

a. Cockpit utility lights – As required.

b. Circuit breakers – in.

c. INST LTS, CONSOLE LTS, and NVG POS LTS — As required.

*d. ANTI-COLLISION LTS switch — As required.

*e. POS LTS switch — As required

f. ENG OIL BYPASS switch — OFF. In a combat situation with the possibility of oil cooler damage, the switch should be in AUTO.

g. HTR switch — OFF.

h. DEFOG & VENT switch — OFF.

i. PITOT HTR switch — OFF.

j. ENG DEICE switch — OFF.

k. INV switch — OFF.

l. NON-ESS BUS switch — MAN.

m. GEN switch — OFF.

*n. BAT switch — As required

o. AUX RECP switch — OFF.

p. Fuel Shutoff Valve Handle — Check ON (forward and locked).

q. FAT gage — Check.

*4. GPU — Connect for GPU start.

5. Avionics — Off and set.

6. Instrument panel instruments and switches — Check and set as follows:

a. System requirements — Check engine instruments for static indications, slippage marks and operating range limit markings.

b. Flight instruments- Check for static indications, set altimeter to field elevation, and note setting in Kollsman window.

c. DIR GYRO/MAG switch — As required.

d. FORCE TRIM switch — FORCE TRIM.

e. HYD BOOST switch — HYD BOOST.

*7. Flight controls — Check and set as follows:

a. Control frictions — OFF.

b. Flight controls — Check for full travel; check engine out/low — rotor audio.

*8. Throttle — Check. Move to open, then to idle stop; press idle release and close.

8-17. STARTING ENGINE.

*1. Fireguard — Post if available.

*2. Rotor blades — Check clear and untied.

*3. Engine — Start as follows:

a. FUEL BOOST switch — FUEL BOOST.

b. STARTER switch — Press and hold.

c. TOT — Check below 200°C.

NOTE

Do not wait for N1 to peak out. Delay in moving the throttle to engine idle may diminish battery capacity early in the start cycle.

d. Throttle — Open to engine idle as N1 **Accelerates Through** the minimum N1 RPM, as provided below.

	<u>FAT</u>	<u>MINIMUM N1</u>
(a)	Above 7°C	15%
(b)	-18°C to 7°C	13%
(c)	Below -18°C	12%

e. Engine Oil Pressure N1 — Check for increase by 20% N1.

f. Main rotor — Check moving by 30% N1.

g. (TOT) Monitor for OVERTEMP conditions.

h. STARTER switch — Release at 58–62% N1.

i. Engine oil pressure — Check.

j. ENGINE OUT and XMSN OIL PRESS warning lights — check out.

- k. N1 — 62–64 percent.

WARNING

Do not have battery switch on and APU system charging simultaneously for more than 2 minutes. This will prevent an unmonitored battery from overheating and possibly exploding.

- *4. GPU — Disconnect; then BAT switch — BAT, if required.
- *5. N2 — Stabilized.
- *6. THROTTLE ADJUST — 70 percent N1.
- *7. GEN switch — GEN.
- *8. DC amps — Check 60 or less before inverter is turned on.
- *9. INV switch — INV.
- *10. Avionics — On.

8-18. ENGINE RUNUP.

- *1. Engine and transmission instruments — Check.
- *2. Throttle — Slowly increase to open. Set N2 to 100 percent.
- 3. HEAT and DEICE systems — Check if use is anticipated as follows, then set as required:
 - a. ENG DEICE — Check by moving the switch to ENG DEICE; check for rise in TOT; then OFF. TOT should decrease.
 - b. PITOT HTR — Check by moving the switch to PITOT HTR; check for an increase in DC AMPS; then OFF. DC AMPS should decrease.
 - c. DEFOG & VENT — Check by moving the switch to DEFOG & VENT; check for an increase in DC AMPS; then OFF. DC amps should decrease.
 - d. HTR — Check by moving the switch to HTR; Check for increase in TOT; then OFF. TOT should decrease.

- 4. Avionics — Check as required.
- 5. Deleted.
- *6. Flight Instruments — Check and set as follows:
 - a. Attitude indicator — Horizon **A** ; Set 5 degrees above horizon to indicate level attitude at cruise flight **C**.
 - b. Altimeter — Set and check.
 - (1) Barometric Altimeter — Set to current altimeter setting and check altitude error.
 - (2) Radar Altimeter — Test.
 - c. Heading indicators — Check and set.
- *7. Doors, armor side panels and seat belts — Secure.
- 8. Health indicator test (HIT) — Check. Refer to HIT TOT log in the helicopter log book. Perform before first flight of the day.

- *9. Deceleration check. — Perform if required. See Chapter 5, FUEL OPERATION LIMITS.
 - a. GEN switch — OFF.
 - b. N2 RPM — 100 percent. Stabilize 15 seconds.
 - c. Throttle — Idle. Simultaneously start a time count.
 - d. Stop as N1 passes through 65 percent.

NOTE

Multiple attempts may be required before proficiency is obtained in timing the deceleration.

- e. Check deceleration time. Minimum allowable time is 2 seconds. If deceleration time is less than 2 seconds, make two checks to confirm the time.

f. If deceleration time is less than 2 seconds, aircraft will not be f own. Enter conditions in the "Remarks" section of DA Form 2408-13-1.

g. GEN switch – GEN.

h. Throttle – Slowly increase to open.

8-19. BEFORE TAKEOFF.

Prior to takeoff, the following checks shall be accomplished:

- *1. N2 – 100 percent.
- *2. Systems – Check engine, transmission, electrical, and fuel systems indications.
- *3. Crew, passengers, mission equipment, and seat belts – Check.
- *4. Avionics – As required.

8-20. HOVER CHECK.

Perform the following checks at a hover:

- *1. Flight controls – Check.
- *2. Engine and transmission instruments – Check.
- *3. Flight instruments – Check as required.
- *4. Power – Check. The power check is performed by comparing the torque required to hover with the predicted values from performance charts.

8-21. TAKEOFF.



During takeoff with the helicopter skids close to the ground, nose-low attitudes of 10 degrees or more can result in ground contact of the WSPS lower cutter tip. Forward CG, high gross weight, high density altitude, translational lift settling, and tail wind increases the possibility of ground contact.

8-22. DELETED.

8-23. BEFORE LANDING.

Prior to landing, the following checks shall be accomplished:

1. Crew, passenger and mission equipment – Check.
2. Landing light – As required.

8-24. ENGINE SHUTDOWN.



If throttle is inadvertently rolled to close position, do not attempt to roll it back on.

1. Throttle – Engine idle; stabilize TOT for two minutes.
2. FORCE TRIM switch – FORCE TRIM.
3. FUEL BOOST switch – OFF.
4. NVG/LDG LTS switch – OFF.
5. Control frictions – On.
6. Avionics – Off.
- 6.1. Deleted.
7. Overhead switches and circuit breakers – Set as follows:
 - a. ENG OIL BYPASS switch – OFF.
 - b. HTR switch – OFF.
 - c. DEFOG & VENT switch – OFF.
 - d. PITOT HEAT switch – OFF.
 - e. ENG DEICE switch – OFF.
 - f. INV switch – Off.
8. Battery change – Check as follows:

- a. BAT switch – OFF.
 - b. Ammeter – Check change indication. If the change in indication is less than 5.0 amperes, the battery is fully charged.
 - c. BAT switch – BAT.
9. Throttle – Close. TOT, stabilize below 400° C.
 10. Overhead switches – OFF as required.
 - a. GEN.
 - b. ANTI-COLLISION LTS.
 - c. POS LTS.
 - d. CONSOLE LTS, INST LTS, and NVG POS LTS.
 - e. BAT.
 11. Ignition switch – OFF (keys as required).



Do not drop seat belt against side of aircraft. Buckles and bracket will damage honeycomb panel under crew member door frame.

12. Doors – Close immediately after exiting aircraft.

8-25. BEFORE LEAVING THE HELICOPTER.

1. Main rotor blades – Tie down as required.
2. Walk-around – Complete, checking for damage, fluid leaks, and levels.
3. Deleted.
4. DA Forms 2408-12 and 2408-13-1 – Complete.
5. Secure helicopter – As required.

SECTION III INSTRUMENT FLIGHT

8-26. INSTRUMENT FLIGHT – GENERAL.

This aircraft is restricted to visual flight conditions. Flight into instrument meteorological conditions will be conducted on an emergency basis only. Flight handling,

stability characteristics, and range are the same during instrument flight as for visual flight. Navigation and communication equipment are adequate for instrument flight.

SECTION IV FLIGHT CHARACTERISTICS

8-27. OPERATING CHARACTERISTICS.

a. The flight characteristics of this helicopter, in general are similar to other single-rotor helicopters.

b. N2 droop may occur during a normal flight maneuver requiring a rapid increase in power (i.e., rapid collective and/or tail rotor inputs, high-G maneuvers). If N2 droop occurs, but low RPM warning is not activated and N2 recovers to 100 percent within 5 seconds, and further droop is not experienced, this is considered a normal flight characteristic.

8-28. MAST BUMPING.

Mast bumping (flapping-stop contact) is the main yoke contacting the mast and may result in a fractured mast and rotor separation. It may occur during slope landings, rotor startup/coastdown, or when the flight envelope is exceeded. If bumping occurs during a slope landing, reposition the cyclic to stop the bumping, reestablish a hover, and land on less sloping ground. If bumping occurs during startup or shutdown, move cyclic to minimize or eliminate bumping. If the flight envelope is inadvertently exceeded, causing low "G" condition and right roll, move cyclic aft to return rotor to a positive thrust condition, then roll level, continuing flight if mast bumping has not occurred. As collective pitch is reduced after engine failure or loss of tail rotor thrust, cyclic must be

positioned to maintain positive "G" forces during autorotation. Touchdown should be accomplished prior to excessive rotor RPM decay. After landing, an entry in DA Form 2408-13-1 is required for appropriate maintenance inspection.

8-29. SPIKE KNOCK.

a. Spike knock occurs when the round pin in the drag-pin fitting contacts the side of the square hole of the pylon stop, which is mounted to the roof. It creates a loud noise and will occur during a rocking of the pylon. The following factors can cause a spike knock: low rotor RPM, extreme asymmetric loading, poor execution of an autorotational landing and low G maneuvers below +0.5 Gs.

b. Spike knock will be more prevalent during zero ground run autorotational landings than for sliding autorotational landings and running landings.

c. Spike knock in itself is not hazardous but is an indicator of a condition that could be hazardous. If spike knock is encountered, an entry must be made on DA Form 2408-13-1, to include the flight conditions under which the spike knock has occurred. An inspection will be performed by maintenance personnel before continuing.

d. During landing, starting, and rotor coastdown, spike knock could also occur, especially if there are high winds and/or the elastomeric damper is deteriorated. This type of spike knock is not considered damaging to the aircraft.

8-30. PYLON WHIRL.

Pylon whirl is a condition which occurs after blade flapping and mast bumping. The resultant motion of the pylon is elliptical, and spike knock is apt to occur. If the frequency of motion coincides with a particular natural frequency of the helicopter, and the amplitude and direction of the force is large enough, damaging vibrations can occur in the aft section tailboom of the helicopter. Motion of this type could occur during touchdown autorotations, if operational limits are exceeded.

8-31. CRITICAL TAILBOOM DYNAMIC MODES.

Two critical tailboom dynamic modes exist. One of these may occur during an improperly executed touchdown autorotational landing, and corresponds to a frequency of less than 64 percent rotor RPM. The second may occur during a high speed autorotational entry, or any maneuver in which application of collective allows a significant decay in rotor RPM down to a critical frequency corresponding to approximately 68-73 percent RPM. At high blade angles of attack (increased collective), there may be a point where the blade does not produce more lift. When there is this condition of low rotor speeds and high collective blade angles, there will be excessive flapping of the main rotor. The cycle will be as follows: rotor blade flap, mast bumping, and spike knock, which will ultimately results in main rotor inertia/energy transfer to the airframe. These conditions generate a resonance and the tailboom will rapidly respond to these frequencies. The tailboom will then have up and down movements as it responds to the resonant condition and at some point, a structural failure will occur. typically, there will be wrinkles in the tailboom just aft of the boom attaching points. After the tailboom has buckled and/or been damaged, the vibrations may (and usually will) cease; predominantly, because the failure unloads the condition or the landing has stopped or main rotor flapping has ceased. these could be aggravated by high winds and abrupt cyclic inputs while in the condition. High forward speed relative to the maneuver may provide the driving force for excessive blade flapping, mast bumping, and as a result, damaging vibration. Likelihood of encountering the second mode is remote and is avoidable. if operating limitations of the helicopter are observed.

8-32. LOSS OF TAIL ROTOR EFFECTIVENESS.

a. Loss of tail rotor effectiveness (LTE) is the occurrence of an uncommanded and rapid right yaw rate which does not subside of its own accord and which, if not quickly reacted to , can result in loss of aircraft control. However, the term "loss of tail rotor effectiveness" is misleading. The tail rotor on this aircraft has exhibited the capability to produce thrust during all flight regimes. Under varying combinations of wind azimuth and velocity, tail rotor thrust variations can occur. When this occurs, the helicopter will attempt to yaw to the right. this yaw is usually correctable if immediate additional left pedal is applied. Correct and timely pilot response to an uncommanded right yaw is critical. If the response is incorrect or slow, the yaw rate may rapidly increase to a point where recovery may not be possible in the terrain flight regime.

NOTE

The pilot must anticipate these variations, concentrate on flying the aircraft, and not allow a yaw rate to build.

b. Extensive flight testing and wind-tunnel tests have identified three relative wind azimuth and velocity regions as capable of adversely affecting aircraft controllability and dramatically increasing pilot workload. For illustration, specific wind azimuths and velocities are identified for each region (see figure 8-2). However, the pilot must realize the boundaries of these regions may shift in azimuth or velocity depending on the ambient conditions.

(1) Weathercock stability (120-140 degrees). Winds within this region will attempt to weathervane the aircraft into the relative wind. The helicopter exhibits a tendency to make a slow uncommanded yaw to either the left or right, depending upon the exact wind direction. Due to the inherent yaw characteristics of this helicopter, the right yaw rate will increase unless arrested by the pilot. A right yaw can develop into an LTE condition and requires immediate correction.

(2) Vortex ring state (210-330 degrees). Winds within this region will cause a vortex ring state to develop around the tail rotor, which, in turn, causes tail rotor thrust variations. The helicopter exhibits a tendency to make uncommanded pitch, roll, and yaw excursions. The subsequent aircraft reactions require multiple pedal, cyclic, and collective inputs by the pilot. maintaining a precise heading in this region will be impossible. Pilot workload in this region will be high; therefore, the pilot must concentrate fully on flying the aircraft and not allow a right yaw rate to build.

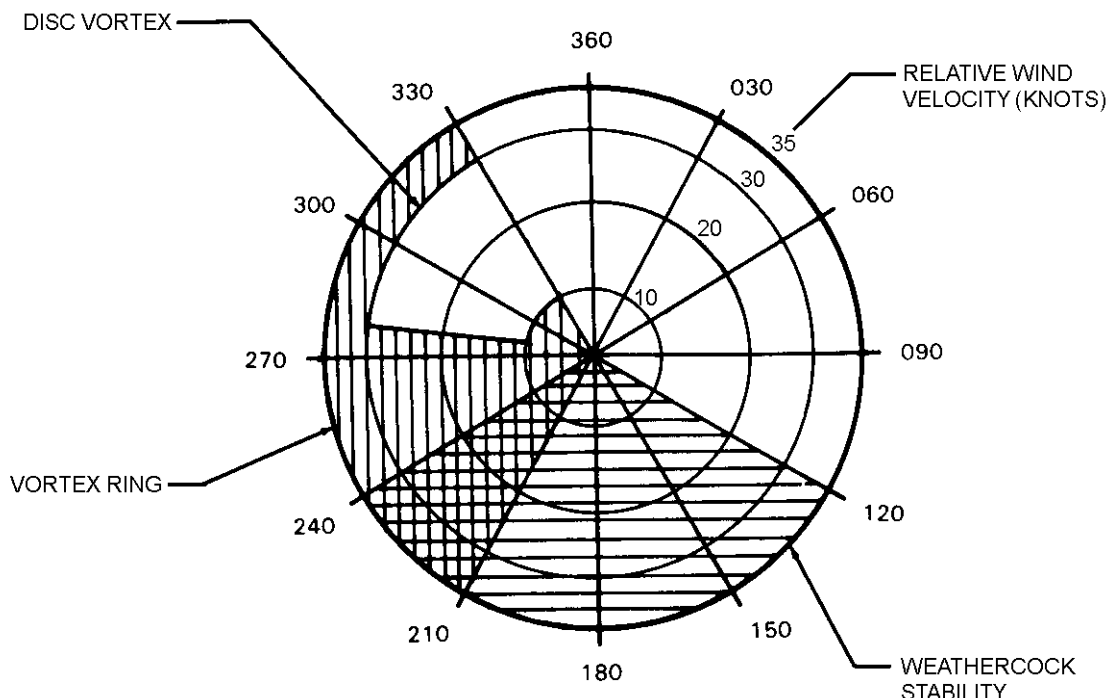

MS026054

Figure 8-2. Effects of Wind Azimuth On Aircraft.

(3) Disc vortex (280-330 degrees). Winds within this region will cause the main rotor tip vortices to be directed onto the tail rotor. The effect of this main rotor vortex is to cause the tail rotor to operate in an extremely turbulent environment. The helicopter will exhibit a tendency to make a sudden uncommanded right yaw which, if uncorrected, will develop into a spin. When operating in this region, the pilot must anticipate the sudden demand for left pedal inputs.

c. Other factors which may be present can significantly influence the severity of the onset of Loss of Tail Rotor Effectiveness (LTE). These factors are:

(1) Gross weight and density altitude. An increase in either of these factors will decrease the power margin between the maximum available and power re-

quired to hover. The pilot should conduct a low level, low airspeed mission with only minimum essential personnel and equipment on board.

(2) Low indicated airspeed. At airspeeds below LTE the tail rotor is required to produce nearly 100 percent of the directional control. If the required amount of tail rotor thrust is not available, for whatever reason, the aircraft will yaw to the right.

(3) Power droop. A rapid power application may cause a transient power droop to occur. Any decrease in main rotor RPM will cause a corresponding decrease in tail rotor thrust. The pilot must anticipate this and apply additional left pedal to counter the main rotor torque. All power demands should be made as smoothly as possible to minimize the effect of the power droop.

d. The OH-58A/C, in its typical mission configuration, is closer to its maximum gross weight than most other aircraft in the Army inventory; thus, the pilot is consistently operating closer to power and directional control limits. For this reason, the aircraft heading should be kept into the wind as much as possible; it is very important that precise heading control be main-

tained to minimize the yaw excursions that could lead to LTE. Additionally, it has been determined that there is a greater susceptibility to LTE for right turns (especially right downwind turns at low altitude and low airspeeds) than for left turns. Therefore, pilot should exercise caution when executing right turns under conditions conducive to LTE.

SECTION V ADVERSE ENVIRONMENTAL CONDITIONS

8-33. GENERAL.

This section provides information relative to operation under adverse environmental conditions. Section II checklist provides for operational requirements of this section. Refer to FM 1-202, Environmental Flight.

8-34. COLD WEATHER OPERATIONS.

Operation of the helicopter in cold weather or an arctic environment presents no unusual problems if the operators are aware of those changes that do take place and conditions that may exist because of the lower temperatures and freezing moisture.

a. Inspection. The pilot must be more thorough in the preflight check, when temperatures have been at or below 0 degrees C (32 degrees F). Water and snow may have entered many parts during operations or in periods when the helicopter was parked unsheltered. This moisture often remains to form ice which will immobilize moving parts or damage structure by expansion and will occasionally foul electric circuitry. Protective covers afford protection against rain, freezing rain, sleet, and snow, when installed on a dry helicopter prior to the precipitation. Since it is not practicable to completely cover an unsheltered helicopter, those parts not protected by covers and those adjacent to cover overlap and joints require closer attention, especially after blowing snow or freezing rain. Remove accumulation of snow and ice prior to flight. Failure to do so can result in hazardous flight, due to aerodynamic and center-of-gravity disturbances, as well as the introduction of snow, water, and ice into internal moving parts and electrical systems. Pilot should be particularly attentive to the main and tail rotor systems and their exposed control linkages.

b. Checks.

(1) Exterior checks 0 degrees C (32 degrees F) to -54°C (-65°F) Perform exterior check as outlined in Section II plus the following checks.



Check that all surfaces and controls are free of ice and snow.

NOTE

Contraction of the fluids in the helicopter system at extreme low temperature causes indication of low levels. A check made just after the previous shutdown and carried forward to the walk-around check is satisfactory, if no leaks are in evidence. Filling, when the system is cold-soaked, reveals an over full condition immediately after flight, with the possibility of forced leaks at seals.

(a) **Main rotor.** Check free of ice, frost, and snow.

(b) Engine.

1 Inspect inlet for possible accumulations of snow, slush, or ice. Accumulations must be removed from the interior of the reverse flow inlet (hand removal is acceptable).

2 Inspect the engine plenum chamber through the plexiglass windows (a flashlight may be required) on each side of the inlet cowling for snow, slush, or ice, paying particular attention to the firewalls, rear face of the particle separator, bottom corners, and protruding surfaces, such as guide vanes, etc.

3 Visually inspect the plastic particle separator ejector tubes on each side of the engine fairing for obstructions and snow. A thin film of ice about the interior of each tube is acceptable. External ice, adjacent to the ejector tube, is acceptable.

4 If exhaust covers are missing or improperly installed, rain or snow may enter the engine through the exhaust stacks and subsequently freeze, causing the N₁ and N₂ turbine blades to be imbedded in ice. If the starter is activated under these circumstances, serious engine damage may result. Visually inspect inside of the exhaust collar (with a flashlight, if necessary) to ensure that no ice is present. Apply external heat to engine until all visible ice in the exhaust collector is melted, before attempting start.

(c) Oil tank compartment – Check free of ice, frost, and snow.

(2) Interior check – All flights 0 degrees C (32 degrees F) to -54 degrees C (-65 degrees F). Perform check as specified in Section II.

(3) Interior check – Night flights 0 degrees C (32 degrees F) to -54 degrees C (-65 degrees F). External power connected. Perform check as specified in Section II.

(4) Engine starting check 0 degrees C (32 degrees F) to -54 degrees C (-65 degrees F). Perform as outlined in Section II.

CAUTION

In the fuel system, condensation and freezing of moisture in pneumatic circuits can occur when weather conditions of low temperature and high relative humidity are encountered. this condition can cause auto acceleration of engine.

NOTE

Auto acceleration resulting from frozen moisture in fuel system air circuits does not repeat unless aircraft is again subjected to cold soak. to prevent icing/auto acceleration, make a 10 minute ground warm-up run at idle before flight. This warm-up is recommended when aircraft has been allowed to cold soak in low ambient temperatures of -12°C (10°F) or below and high relative humidity of 45% or greater.

If auto acceleration occurs, close the throttle and shut down engine. Subsequently, restart the engine and resume warm-up.

NOTE

Due to the variation in types of jet fuel, in cold

weather the engine may experience a short delay before lightoff after the throttle is advanced to idle position. This delay should be less than three seconds, regardless of the type of fuel used.

NOTE

During cold weather, starting the engine oil pressure gage may exceed 130 PSI. The engine should be warmed up at engine idle until the engine oil pressure indication is below 130 PSI.

(5) Engine runup check. Perform the check as outlined in Section II. To prevent the possibility of auto-acceleration after takeoff, the engine shall be operated at idle for the times specified below before completing runup procedures.

FAT (°C)	TIME MINUTES
-30 to -21	10
-20 to -11	7
-10 to -1	5
0 to +9	3

WARNING

Control system checks should be performed with extreme caution when helicopter is parked on snow and ice. there is reduction in ground friction holding the helicopter stationary; controls are sensitive and response is immediate.

c. Engine Starting Without External Power Supply. If a battery start must be attempted when the helicopter and battery have been cold-soaked at temperatures between -26 degrees C to -37 degrees C (-15 degrees F to -35 degrees F), preheat the engine and battery, if equipment is available and time permits. Preheating will result in a faster starter cranking speed which tends to reduce the hot-start hazard, by assisting the engine to reach a self-sustaining speed.

d. Engine Anti-Icing. The END DEICE switch should be in ENG DEICE position in visible moisture below 5°C FAT.

8-35. SNOW OPERATIONS.

There are no unusual flight operational characteristics in snow operations. Refer to FM 1-202, Environmental Flight, for snow takeoff and landing technique.

8-36. DESERT AND HOT WEATHER OPERATIONS.

There are no unusual flight operational characteristics in desert and hot weather operations. Refer to FM 1-202, Environmental Flight, for operational technique.

8-37. TURBULENCE.

a. To minimize the adverse effects of turbulence encountered in flight, the helicopter should be flown at a torque value corresponding to maximum endurance airspeed. There will be a corresponding increase in control movements at reduced airspeed.

b. Helicopter controllability is the primary consideration; therefore, if control becomes marginal, exit the turbulence as soon as possible.

c. In turbulence, check that all occupants are seated with seat belts and harnesses tightened.

d. Deleted.

e. Deleted.

8-38. THUNDERSTORMS.

a. To minimize the effects of thunderstorms encountered in flight, perform the following:

(1) Adjust torque to a value corresponding to maximum endurance airspeed.

(2) Check that all occupants are seated with seat belts and harnesses tightened.

(3) PITOT HTR switch – ON.

(4) Avionics – Reduce volume on any equipment affected by static.

(5) Interior lights – Adjust to full bright at night to minimize blinding effect of lightning

b. In the storm:

(1) Maintain level altitude and constant power setting. Airspeed fluctuations should be expected and disregarded.

(2) Maintain original heading, turning only when necessary.

(3) The altimeter is unreliable, due to differential barometric pressures within the storm. An indicated gain or loss of several hundred feet is not uncommon and should be allowed for in determining minimum safe altitude.

8-39. LIGHTNING STRIKE.

a. Although the possibility of a lightning strike is remote, the helicopter could inadvertently be exposed to lightning damage. Therefore, static tests have been conducted to determine lightning strike effect on rotors.

b. Simulated lightning tests indicate that lightning strikes may damage helicopter rotors. The degree of damage will depend on magnitude of charge and point of contact. Catastrophic structural failure is not anticipated. However, lightning damage to hub bearings, blade aft section, trim tabs and blade tips was demonstrated. Also, adhesive bond separation occurred between blade spar and aft section between spar and leading edge abrasion strip. Some portions of blade aft sections deformed to the extent that partial or complete separation of the damaged section could be expected. Such damage can aerodynamically produce severe vibrations and serious control problems which, if prolonged, could endanger helicopter and crew.

WARNING

Avoid flight in or near thunderstorms, especially in area of observed or anticipated lightning discharges.

NOTE

Abnormal operating noises almost always accompany rotor damage, but loudness or pitch are not valid indications of degree of damage sustained.

c. If lightning strike occurs, or is expected, the following precautions are recommended to minimize further risk:

(1) Reduce airspeed as much as practical to maintain safe flight.

(2) Avoid abrupt control inputs.

8-40. ICING CONDITIONS.

a. Intentional flight in any icing condition is prohibited. If icing conditions are encountered during flight, effort should be made to vacate the icing conditions.

b. If icing conditions become unavoidable, the pilot should turn on pitot heat, windshield defroster and the engine anti-ice system.

c. During flights in icing, the following conditions may be experienced:

(1) Obscured forward field of view due to accumulation on windscreen and chin bubbles. If windshield defrosters fail to keep windshield clear of ice, side windows may be used for visual reference during landing.

(2) One-per-rotor-revolution vibrations, from mild to severe, caused by asymmetrical ice shedding on main rotor system. Severity of vibration will depend on temperature and amount of accumulation on blades when ice shed occurs. Possibility of asymmetrical ice shed occurring increases as outside air temperature decreases.

(3) An increase in torque required to maintain a constant airspeed and altitude due to ice accumulation on the rotor system and possible degradation of the ability to maintain autorotational rotor speed within operating limits.

d. Control activity cannot be depended upon to remove ice from the main rotor system. Vigorous control movements should not be made in an attempt to reduce low frequency vibrations caused by asymmetrical shed-

ding of ice from main rotor blades. These movements may induce more asymmetrical shedding of ice, further aggravating helicopter vibration levels.

WARNING

Ice shed from rotor blades and/or other rotating components presents a hazard to personnel during landing and shutdown. Ground personnel should remain clear of helicopter during landing and shutdown; passengers/crew members should not exit aircraft until rotor has stopped turning.

8-41. SAND AND DUST OPERATION.

Efficiency of the particle separator is directly related to the amount of engine bleed air available. Bleed air is used to operate the particle separator, and remove sand/dust particles before they enter the engine plenum chamber.

a. **Ground Operations.** At ground idle, with heater on, particle separator with improved nozzles has a cleaning efficiency of approximately 53%; with heater off, cleaning efficiency is approximately 75%.

b. **Extended Ground Operations.** If extended ground operations are expected, it is recommended heater be turned off. Should environmental conditions require use of heater, it is recommended OH-58 be operated close to 100% N2 with blades in flat pitch. This condition should permit particle separator to function at a cleaning efficiency of over 70%.

CHAPTER 9 EMERGENCY PROCEDURES

SECTION I AIRCRAFT SYSTEMS

9-1. HELICOPTER SYSTEMS.

This section describes the helicopter systems emergencies that may reasonably be expected to occur and presents the procedures to be followed. Emergency operation of mission equipment is contained in this chapter insofar as its use affects safety of flight. Emergency procedures are given in checklist form when applicable. A condensed version of these procedures is obtained in the condensed checklist.

9-2. IMMEDIATE ACTION EMERGENCY STEPS.

NOTE

The urgency of certain emergencies requires immediate and instinctive action by the pilot. The most important single consideration is helicopter control. All procedures are subordinate to this requirement. The MASTER CAUTION should be reset after each malfunction to allow systems to respond to subsequent malfunctions. If time permits during a critical emergency, transmit MAYDAY call, set transponder to emergency, jettison external stores if appropriate, and lock shoulder harnesses.

Those steps that must be performed immediately in an emergency situation are underlined. These steps must be performed without reference to the checklist. When the situation permits, nonunderlined steps will be accomplished with the use of the checklist.

9-3. DEFINITION OF EMERGENCY TERMS. For the purpose of standardization, the following definitions shall apply:

a. The term LAND AS SOON AS POSSIBLE is defined as landing at the nearest suitable landing area (e.g., open field) without delay. (The primary consideration is to ensure the survival of occupants).

b. The term LAND AS SOON AS PRACTICABLE is defined as landing at a suitable landing area. (The primary consideration is the urgency of the emergency).

c. The term AUTOROTATE is defined as adjusting the flight controls as necessary to establish an autorotational descent and landing.

d. The term EMER SHUTDOWN is defined as engine shutdown without delay.

(1) Throttle – Close.

(2) FUEL Shutoff Valve Handle – OFF.

(3) BAT switch – OFF. Before turning the battery switch off during in-flight emergencies requiring EMER SHUTDOWN, the pilot should consider a "MAYDAY" call, setting the transponder to EMER, and the possible adverse effects of total electrical failure.

NOTE

Total electrical failure in the OH-58C will result in loss of rotor RPM indications.

9-4. AFTER EMERGENCY ACTION. After a malfunction of equipment has occurred, appropriate emergency actions have been taken, and the helicopter is on the ground, an entry shall be made in the Remarks section of DA Form 2408-13-1 describing the malfunction. Ground and flight operations shall be discontinued until corrective action has been taken.

9-5. EMERGENCY EQUIPMENT. A fire extinguisher and first aid kit (figure 9-1) are mounted on the right of the center post behind the pilot seat.

9-6. EMERGENCY EXITS/EMERGENCY ENTRANCE. Emergency exits are shown in figure 9-1. Emergency jettison handles are yellow. To exit the aircraft in an emergency, first attempt to open doors. If doors will not open, use emergency jettison handles. The crew doors can be jettisoned by pulling the yellow handles to the aft position and the cabin doors by moving the yellow handles to the forward position. If doors will not jettison, break plexiglass to exit the aircraft.

9-7. ENGINE MALFUNCTION – PARTIAL OR COMPLETE POWER LOSS.

NOTE

Under any partial power condition, the throttle should be checked to ensure it is full open and, time and altitude permitting, the GOV RPM switch may be increased to ensure maximum RPM is applied.

a. The indications of an engine malfunction, either a partial or a complete power loss, are: left yaw, drop in engine RPM, drop in rotor RPM, low RPM audio alarm, illumination of ROTOR RPM warning light, ENGINE OUT warning light, and change in engine noise.

WARNING

Do not respond to the RPM audio and/or warning light illumination without first confirming engine malfunction by one or more of the other indications. Normal indications signify that the engine is functioning properly and that there is a tachometer generator failure or an open circuit to the warning system, rather than an actual engine malfunction.

b. Flight Characteristics.

(1) Control response with an engine inoperative is similar to a descent with power.

(2) Airspeed above the minimum rate of descent from autorotational glide characteristics chart (figure 9-2) will result in greater rates of descent but may be used as necessary to extend glide distance.

(3) Airspeeds below minimum rate of descent airspeeds will increase rate of descent and decrease glide distance.

(4) Should the engine malfunction during a left bank maneuver, right cyclic input to level the aircraft must be made simultaneously with collective pitch adjustment. If the collective pitch is decreased without a corresponding right cyclic input, the helicopter will pitch down and roll rate will increase rapidly, resulting in a significant loss of altitude.

c. Partial Power Condition. Under partial power conditions, the engine may operate smoothly at reduced power or it may operate erratically with intermittent surges of power. In instances where a power loss

is experienced without accompanying power surging, the helicopter may be flown at reduced power to a suitable landing area. Under this condition, the pilot should always be prepared for a complete power loss. In the event a partial power condition is accompanied by erratic engine operation or power surging, and flight is to be continued, the throttle may be adjusted in an attempt to correct the surging condition. If flight is not possible, close the throttle completely and complete an autorotational landing.

d. Complete Power Loss. Under a complete power loss condition, delay in recognition of the malfunction, improper technique or excessive maneuvering to reach a suitable landing area reduces the probability of a safe autorotational landing. Flight conducted within the avoid area of the chart (figure) exposes the helicopter to a high probability of damage despite the best efforts of the pilot.

e. Low Airspeed and Low Altitude. Under low altitude low airspeed conditions, the deceleration capability is limited, and caution should be used to avoid striking the ground with the tail rotor. Initial collective reduction will vary after an engine malfunction, dependent upon the altitude and airspeed at the time of the occurrence. For example, collective should not be decreased when an engine failure occurs at a hover below 15 feet; whereas, during cruise flight conditions, altitude and airspeed are sufficient for a significant reduction in collective, thereby, allowing rotor RPM to be maintained in the safe operating range during autorotational descent. The rotor may overspeed and require collective pitch application to maintain the RPM below the upper limit. Collective should never be applied to reduce RPM below normal limits for extending glide distance because of the reduction in RPM available for use during autorotational landing.

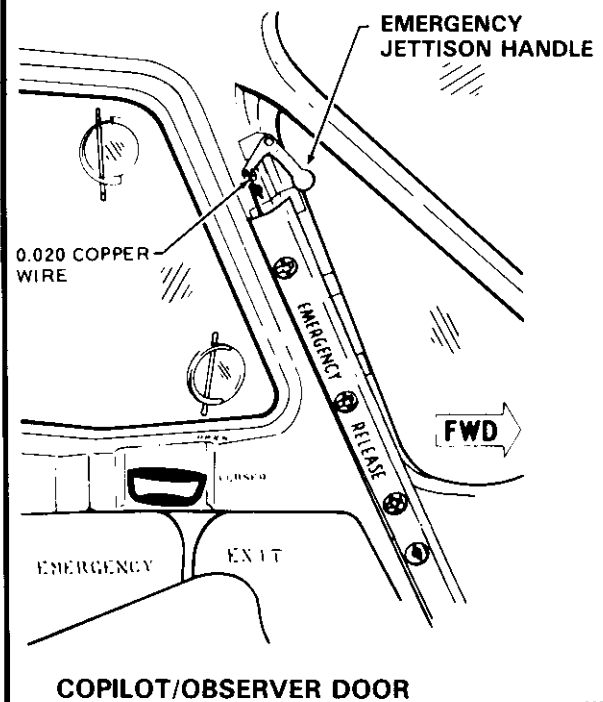
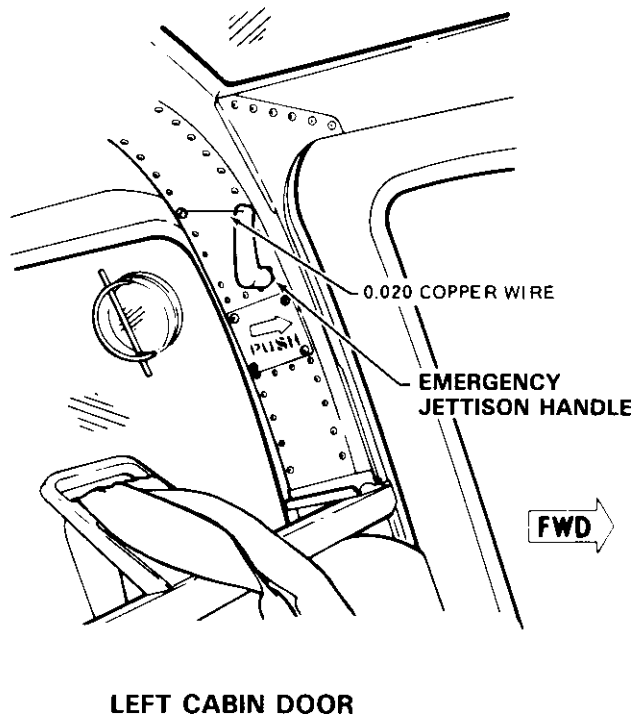
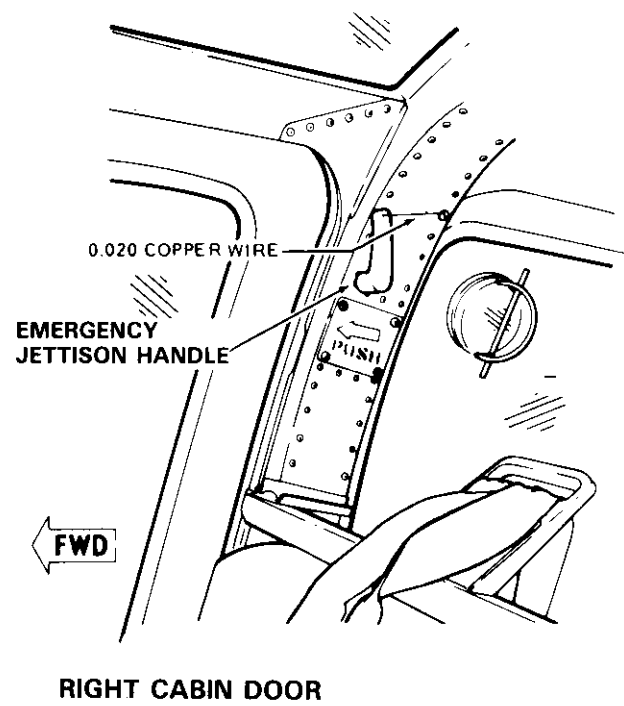
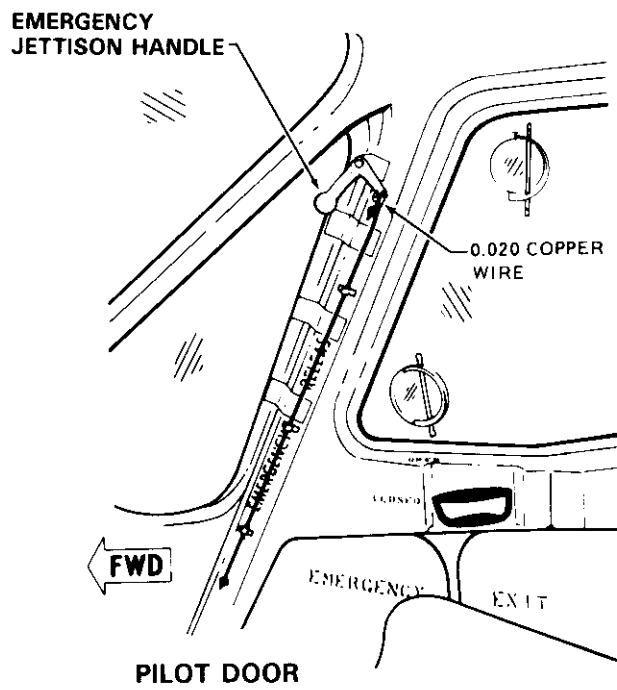

MS026129

Figure 9-1. Emergency Exits and Equipment (Sheet 1 of 2)



MS026130

Figure 9-1. Emergency Exits and Equipment (Sheet 2 of 2)

AUTOROTATIONAL GLIDE CHARACTERISTICS POWER OFF

AUTOROTATIONAL
GLIDE
A OH-58A
C OH-58C

NOTE
AUTOROTATIONAL
GLIDE PERFORMANCE IS
A FUNCTION OF
AIRSPEED AND IS
ESSENTIALLY
UNAFFECTED BY
DENSITY ALTITUDE AND
GROSS WEIGHT

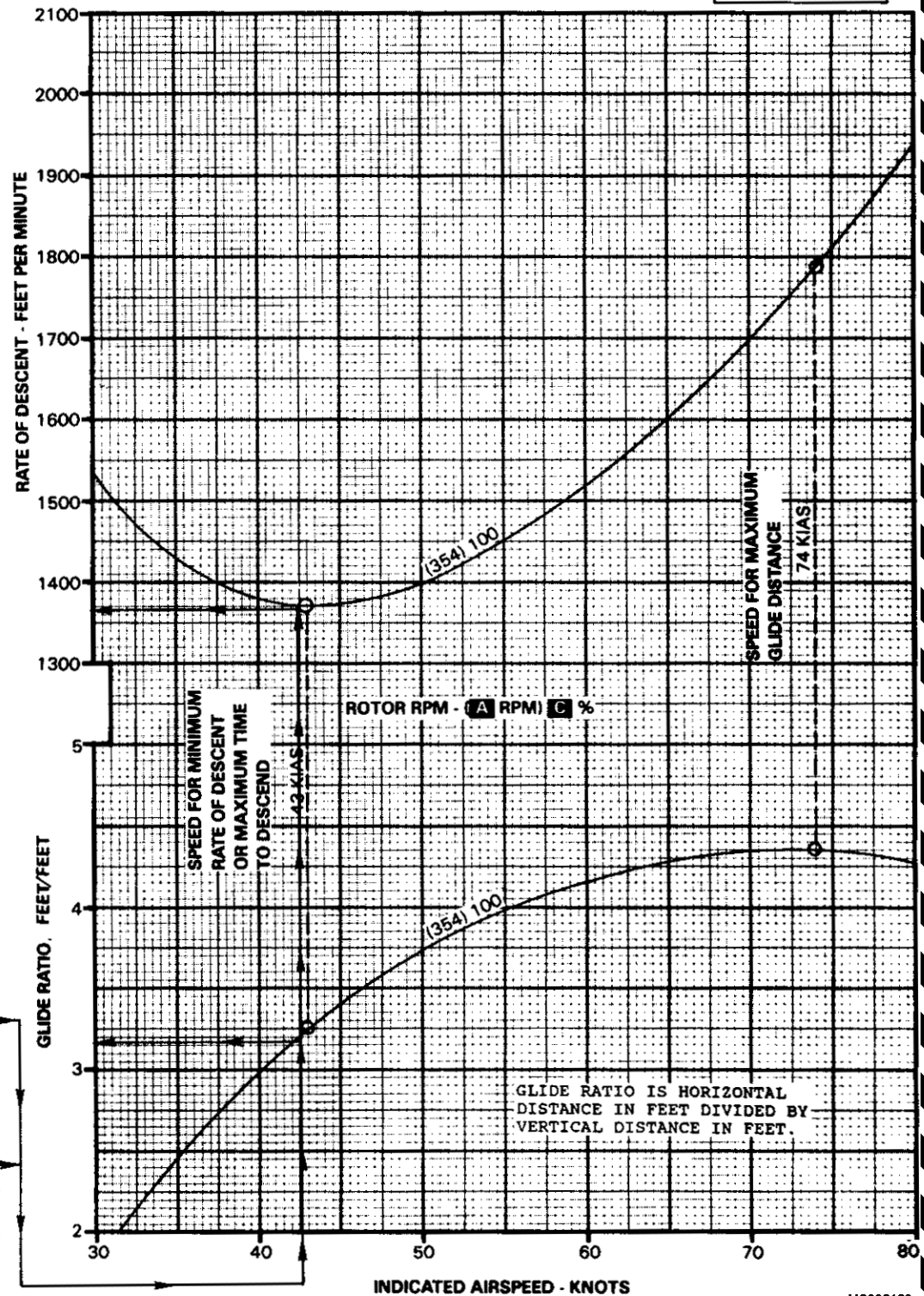

EXAMPLE

WANTED

GLIDE RATIO AND RATE OF DESCENT

KNOWN

AIRSPEED = 42.5 KIAS
ROTOR RPM = 354 OR 100%

METHOD

ENTER INDICATED AIRSPEED HERE
 MOVE UP TO 354 ROTOR RPM GUIDE LINE IN THE LOWER PART OF THE CHART
 MOVE LEFT, READ GLIDE RATIO = 3.2
 RE-ENTER INDICATED AIRSPEED HERE
 MOVE UP TO 354 ROTOR RPM GUIDE LINE IN THE UPPER PART OF THE CHART
 MOVE LEFT, READ RATE OF DESCENT = 1370 FPM

DATA BASIS: DERIVED FROM FLIGHT TEST (USAASTA 68-30)

MS026138

Figure 9-2. Autorotational Glide Characteristics Chart

MINIMUM HEIGHT FOR SAFE LANDING AFTER ENGINE FAILURE

MINIMUM HEIGHT
OH-58A/C



EXAMPLE A

WANTED

MAXIMUM GROSS WEIGHT RESTRICTION FOR SAFE LANDING AFTER ENGINE FAILURE

KNOWN

DENSITY ALTITUDE = 5700 FEET

METHOD

ENTER DENSITY ALTITUDE HERE
MOVE RIGHT TO DIAGONAL LINE
MOVE DOWN, READ GROSS WEIGHT = 2800 LBS

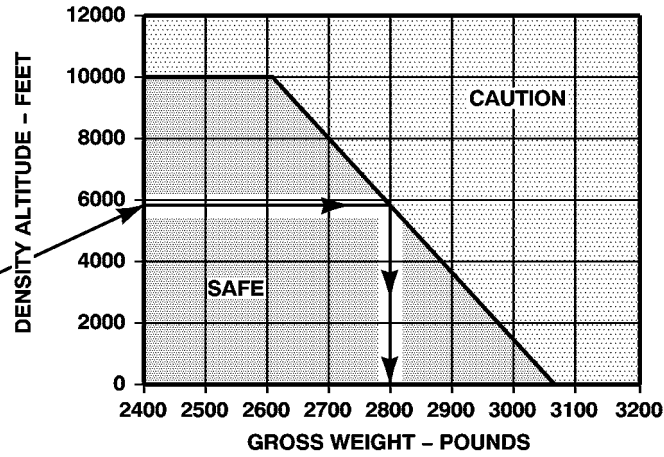

EXAMPLE B

WANTED

MINIMUM INDICATED AIRSPEED FOR SAFE LANDING (WITHOUT AIRCRAFT DAMAGE) AFTER ENGINE FAILURE

KNOWN

SKID HEIGHT ABOVE GROUND = 400 FEET

METHOD

ENTER SKID HEIGHT HERE
MOVE RIGHT TO CRITICAL POINT ON HEIGHT VELOCITY CURVE
MOVE DOWN, READ INDICATED AIRSPEED = 35 KNOTS (MINIMUM)

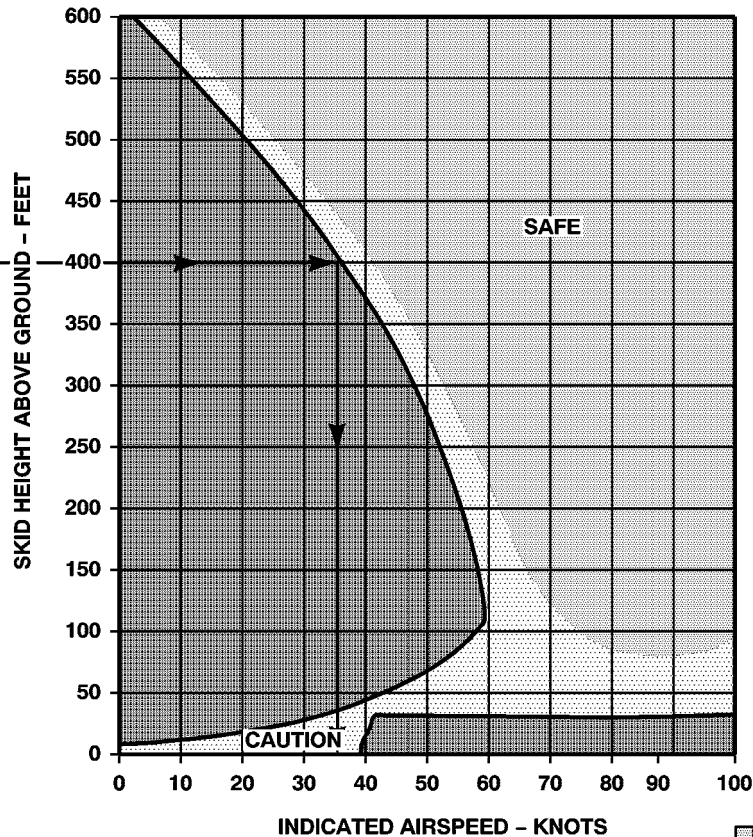

DATA BASIS: DERIVED FROM FLIGHT TEST OF SIMILAR TYPE AIRCRAFT



MS026027A

Figure 9-3.

9-8. MINIMUM RATE OF DESCENT – POWER OFF. The power-off minimum rate of descent is attained at an indicated airspeed of 43 knots and 100% rotor RPM. Refer to figure 9-2, autorotational glide characteristics chart.

9-9. MAXIMUM GLIDE DISTANCE – POWER OFF. The maximum glide distance is attained at an indicated airspeed of 71 knots to 74 knots and 100% rotor RPM. Refer to figure 9-2 for maximum glide distance.

9-10. ENGINE FAILURE – HOVER.

AUTOROTATE.

9-11. ENGINE FAILURE – LOWER ALTITUDE/LOW AIRSPEED OR CRUISE.

1. AUTOROTATE.
2. EMER SHUTDOWN. Accomplish during descent if time permits.

9-12. ENGINE RESTART – DURING FLIGHT. After an engine failure in flight, an engine start may be attempted. Because the exact cause of the engine failure cannot be determined in flight, the decision to attempt the start will depend on the altitude and time available, rate of descent, potential landing areas, and crew assistance available. Under ideal conditions, approximately one minute is required to regain powered flight from the time the attempted start is begun. If the decision is made to attempt an in-flight start.

1. Throttle – Close.
2. Attempt start.
3. LAND AS SOON AS POSSIBLE.

9-13. ENGINE COMPRESSOR STALL. Engine compressor stall may be characterized by a sharp rumble or a series of loud reports, severe engine vibration and a rapid rise in TOT depending on the severity of the surge. After engine compressor stall, maneuvers requiring rapid or maximum power applications should be avoided. Should engine compressor stall occur:

1. Collective – Reduce.
2. ENG DEICE and HTR switches – OFF.
3. LAND AS SOON AS POSSIBLE.

9-14. ENGINE OVERSPEED. Engine overspeed will be indicated by a right yaw, rapid increase in both rotor and engine RPM, and an increase in engine and rotor noise. If an engine overspeed is experienced:

1. Collective – Increase to load the rotor and sustain engine/rotor RPM below the maximum operating limit.
2. Throttle – Adjust until normal N2 operating RPM is attained.

3. LAND AS SOON AS POSSIBLE. Perform a power-on approach and landing by controlling the RPM manually with throttle.

a. If RPM cannot be controlled manually:

1. AUTOROTATE when over a safe landing area while simultaneously closing the throttle
2. EMER SHUTDOWN. Accomplish during descent if time permits.

9-15. ENGINE UNDERSPEED.

a. If an engine underspeed occurs, the collective must be adjusted downward to maintain rotor RPM within limits. If powered flight with rotor in the green can be accomplished, LAND AS SOON AS POSSIBLE in an area that will permit a run-on landing.

b. An engine underspeed below 94% N2 results in rotor RPM decay below minimum safe limits. Should this occur:

1. AUTOROTATE.
2. EMER SHUTDOWN. Accomplish during descent, if time permits.

9-16. ENGINE SURGES. If surges in engine RPM are experienced:

1. GOV RPM switch – INCR for maximum RPM.
2. Throttle – Adjust to 98% N2.
3. LAND AS SOON AS POSSIBLE.

If engine surges are not controlled in steps 1 and 2 above, proceed as follows:

4. AUTOROTATE – When over safe landing area.
5. EMER SHUTDOWN. Accomplish during descent if time permits.

9-16.1. LOW ENGINE OIL PRESSURE AND LOSS OF TORQUE INDICATION. If the engine oil pressure is decreasing or indicates zero with accompanying loss of torque a complete loss of engine power is possible.

1. LAND AS SOON AS POSSIBLE.

Should engine oil pressure drop to zero psi the oil temperature indications might not be valid.

9-17. ROTORS, TRANSMISSION AND DRIVE SYSTEMS MALFUNCTIONS.

9-18. TAIL ROTOR FAILURE AND DIRECTIONAL CONTROL MALFUNCTIONS. Because of the many different malfunctions that can occur, it is not possible to provide a solution for every emergency. The success in coping with the emergency depends on quick analysis of the condition and selection of the proper emergency procedure. The following is a discussion of some types of malfunctions, probable effects, and corrective actions.

9-19. COMPLETE LOSS OF TAIL ROTOR THRUST. This situation involves a break in the drive system, such as a severed driveshaft, causing the tail rotor to lose power.

a. Powered Flight.

(1) Indications:

- (a) Abnormal vibrations.
- (b) Pedal input has no effect on helicopter trim.
- (c) Nose of the helicopter turns to the right (left slideslip).
- (d) Left roll of the fuselage along the longitudinal axis.

WARNING

Degree of roll and slideslip may be varied by varying throttle and/or collective (At airspeeds below 40 knots in powered flight, the slideslip may become uncontrollable, and the helicopter will begin to spin on the vertical axis. Autorotation may be the only option).

(2) Procedures:

- (a) Continue powered flight, if possible, to a suitable landing area at or above minimum rate of descent airspeed.
- (b) AUTOROTATE when landing area is reached.
 - 1 If a run-on landing is possible, complete autorotation with a touchdown airspeed as required for directional control.
 - 2 If a run-on landing is not possible, start to decelerate from about 75 feet altitude, so that forward ground speed is at a minimum when the helicopter reaches 10 to 20 feet. Execute touchdown with a rapid collective pull just prior to touchdown in a level attitude with minimum ground speed.

b. Deleted.

9-20. FIXED PITCH SETTINGS. This is a malfunction involving a loss of control resulting in a fixed pitch setting. Whether the nose of the helicopter yaws left or right is dependent upon the amount of pedal applied at the time of the malfunction. Regardless of pedal set-

ting at the time of malfunction, a varying amount of tail rotor thrust will be delivered at all times during flight.

a. Reduced power (low torque).

(1) Indications: The nose of the helicopter will turn right when power is applied.

(2) Procedure:

- (a) If helicopter control can be maintained in powered flight, the best solution is to maintain control with power and accomplish a run-on landing as soon as practicable.
- (b) If helicopter control cannot be maintained, close the throttle immediately and accomplish an autorotational landing.

b. Increased power (high torque).

(1) Indications: The nose of the helicopter will turn left when the power is reduced

(2) Procedure:

- (a) Maintain control with power and airspeed. (Between 40 and 70 knots.)
- (b) If needed, reduce engine RPM manually to 98%.
- (c) Continue powered flight to a suitable landing area where run-on landing can be accomplished.
- (d) Execute a run-on landing with power and a touchdown speed which will minimize sideslip. Use throttle and collective, as necessary, to control sideslip and heading.

c. Hover.

(1) Indication: Helicopter heading cannot be controlled with pedals.

(2) Procedure.

- (a) Fixed pedal – Land.
- (b) Loss of tail rotor thrust – Perform hovering autorotation.

9-21. LOSS OF TAIL ROTOR COMPONENTS. The severity of this situation is dependent upon the amount of weight lost. Any loss of this nature will result in a forward center of gravity shift, requiring aft cyclic.

a. Indications:

(1) Varying degrees of right yaw depending on power applied and airspeed at time of failure.

(2) Forward CG shift.

b. Procedure:

(1) Enter autorotative descent (power off).

(2) Maintain airspeed above minimum rate of descent airspeed.

(3) If run-on landing is possible, complete autorotation with a touchdown airspeed above effective translational lift.

(4) If run-on landing is not possible, start to decelerate from about 75 feet altitude, so that forward groundspeed is at a minimum when the helicopter reaches 10 to 20 feet; execute the touchdown with a rapid collective pull just prior to touchdown in a level attitude with minimum ground run.

9-22. LOSS OF TAIL ROTOR EFFECTIVENESS (LTE). This is a situation involving a loss of effective tail rotor thrust without a break in the drive system which cannot be stopped with full left pedal application. If LTE is experienced, simultaneously:

1. Pedal – Full Left.
2. Cyclic – Forward.
3. As recovery is effected, adjust controls for normal flight.

WARNING

Collective reduction will aid in arresting the yaw rate; however, if a rate of descent has been established, collective reduction may increase the rate of descent to an excessive value. The resultant large and rapid increase in collective to prevent ground or obstacle contact may further increase the yaw rate, decrease the rotor RPM and cause an over-torque and/or over-temperature condition. Therefore, the decision to reduce collective must be based on the pilot assessment of the altitude available for recovery.

If spin cannot be stopped and crash is imminent, an autorotation may be the best course of action. Main-

tain full left pedal until the spin stops, then adjust to maintain heading.

9-23. MAIN DRIVESHAFT FAILURE. A failure of the main driveshaft will be indicated by a sudden increase in engine RPM, decrease in rotor RPM, left yaw and activation of the low RPM audio, and illumination of the ROTOR RPM warning light. A transient overspeed of N1 and N2 may occur but will stabilize. In the event of main driveshaft failure:

1. AUTOROTATE – Establish a power-on autorotational glide. The engine must continue to operate at normal operating RPM in order to provide tail rotor control.
2. EMER SHUTDOWN after landing.

9-24. CLUTCH FAILS TO DISENGAGE. A clutch failing to disengage in flight will be indicated by the rotor RPM decaying with engine RPM as the throttle is reduced to the engine idle position when entering autorotational descent. This condition results in total loss of autorotational capability. If a failure occurs:

1. Throttle – Open.
2. LAND AS SOON AS POSSIBLE.

9-25. MAST BUMPING.

LAND AS SOON AS POSSIBLE.

a.

9-26. FIRE. The safety of helicopter occupants is the primary consideration when fire occurs; therefore, it is imperative that every effort be made by the flight crew to put the fire out. On the ground, it is essential that the engine be shut down, crew and passengers evacuated and firefighting begun immediately. If time permits, a "MAYDAY" radio call should be made before the electrical power is off to expedite assistance from firefighting equipment and personnel. If the helicopter is airborne when a fire occurs, the most important single action that can be taken by the pilot is to land the helicopter.

WARNING

Toxic fumes of the extinguishing agent may cause injury, and liquid agent may cause frostbite or low temperature burns.

CAUTION

If aircraft fire occurs on ground while using Ground Power Unit (GPU); the GPU should be shutdown immediately.

9-27. HOT START.

CAUTION

During engine starts using a Ground Power Unit (GPU), failure of the GPU could possibly result in an engine hot start. After GPU failure during start, the pilot must turn the battery switch on before accomplishing the procedure described below.

During engine starting or shutdown, if TOT limits are exceeded, or it becomes apparent that TOT limits may be exceeded.

1. Starter switch – Continue to press and hold until TOT is less than 200°C.
2. Throttle – Close.

9-28. ENGINE/FUSELAGE/ELECTRICAL FIRE – GROUND.

EMER SHUTDOWN.

a.

9-29. ENGINE/FUSELAGE FIRE – IN FLIGHT. If a fire is observed during flight, prevailing circumstances such as VMC, IMC, night, altitude, and landing areas available must be considered in order to determine whether to execute a power-on, or power-off landing.

a. If Power-On landing:

1. LAND AS SOON AS POSSIBLE.
2. EMER SHUTDOWN after landing.

b. If Power-Off landing:

1. AUTOROTATE.
2. EMER SHUTDOWN. Accomplish during descent if time permits.

9-30. ELECTRICAL FIRE – FLIGHT. Prior to shutting off all electrical power, the pilot must consider the equipment that is essential to a particular flight environment that will be encountered. In the event of electrical fire or suspected electrical fire in flight:

1. BAT and GEN switches – OFF.
2. LAND AS SOON AS POSSIBLE.
3. EMER SHUTDOWN after landing.

30.1. DELETED.

9-31. SMOKE AND FUME ELIMINATION. Smoke and/or toxic fumes entering the cockpit and cabin can be exhausted as follows:

CAUTION

Do not jettison doors in flight above effective translational lift.

1. Vents – Open.
2. DEFOG and VENT switch – ON.

9-32. ELECTRICAL SYSTEM MALFUNCTIONS.

9-33. GENERATOR FAILURE – NO OUTPUT. A no-output malfunction of the generator will be indicated by a zero indication on the DC AMMETER and a DC GENERATOR caution light illumination. An attempt may be made to put the generator back on line by accomplishing the following:

1. GEN FIELD and GEN & BUS RESET circuit breakers – Check in.
2. GEN switch – RESET then GEN – Do not hold the switch in the RESET position.

If the generator is not restored, or if it goes off line again:

3. GEN switch – OFF.
4. Turn OFF all unnecessary electrical equipment.
5. LAND AS SOON AS PRACTICABLE.

9-34. OVERHEATED BATTERY. An abnormally high DC AMMETER indication is evidence of a high battery charging rate or a battery thermal runaway. High battery charging amperage is normal immediately after engine start and should dissipate within minutes. DC AMMETER indications of 30 AMPS or below is normal after 15 minutes of aircraft operation with all systems operating.

WARNING

Do not open battery compartment or attempt to disconnect or remove overheated battery. Battery fluid will cause burns and overheated battery will cause thermal burns and may explode.

If high DC amperage does not dissipate:

1. BAT switch – OFF.

If high DC amperage indication disappears with BAT switch OFF, a high battery charging rate and possible battery thermal runaway is confirmed, in this event:

2. LAND AS SOON AS POSSIBLE.
3. EMER SHUTDOWN after landing.

If high DC amperage indication does not dissipate, pilot should anticipate electrical fire in flight.

9-35. HYDRAULIC SYSTEM MALFUNCTION.

9-36. HYDRAULIC POWER FAILURE. Hydraulic power failure will be evident when the force required for control movement increases; a moderate feedback in the cyclic and collective controls is felt and the HYD PRESS caution light illuminates. Control movements will result in normal aircraft response in every respect. In the event of hydraulic power failure:

1. Airspeed – Adjust as necessary to attain the most comfortable level of control movements.
2. HYD BOOST SOL circuit breaker – Out; check for restoration of hydraulic power.

If hydraulic power is not restored:

3. HYD BOOST SOL circuit breaker – In.
4. HYD BOOST switch – OFF.

WARNING

Do not return the HYD BOOST switch to the ON position for the remainder of the flight. This prevents any possibility of a surge in hydraulic pressure and the resulting loss of control.

5. LAND AS SOON AS PRACTICABLE at an area that will permit a run-on landing.

9-37. LANDING AND DITCHING.

9-38. LANDING IN TREES. A landing in trees should be made when no other landing area is available. In addition to accomplishing engine malfunction emergency procedures, select a landing area containing the least number of trees of minimum height. Decelerate to minimum forward speed at treetop level and descend into the trees vertically. Apply all the remaining collective, prior to the main rotor blades entering the trees.

9-39. DITCHING – POWER ON. If ditching becomes necessary, with power available accomplish an approach to a hover above the water and:

1. Doors – Jettison at a hover.
2. Crew (except pilot) and passengers – Exit.
3. Hover a safe distance away from personnel.
4. AUTOROTATE. Apply all remaining collective as the helicopter enters the water. Maintain a level attitude as the helicopter sinks and until it begins to roll, then apply cyclic in direction of the roll.
5. Pilot – Exit when the main rotor stops.

9-40. DITCHING – POWER OFF. If an engine failure occurs over water and ditching is imminent, accomplish engine failure emergency procedures and proceed as follows:

1. AUTOROTATE. Decelerate to minimum forward speed as the helicopter nears the water. Apply all remaining collective as the helicopter enters the water. Maintain a level attitude as the helicopter sinks and until it begins to roll, then apply cyclic in the direction of the roll.
2. Doors – Jettison.
3. Crew and passengers – Exit when the main rotor stops.

9-41. FLIGHT CONTROL MALFUNCTIONS. Failure of components within the flight control system may be indicated through varying degrees of feedback, binding, resistance, or sloppiness. These conditions should not be mistaken for hydraulic power failure. In the event of a flight control malfunction:

1. LAND AS SOON AS POSSIBLE.
2. EMER SHUTDOWN after landing.

9-42. LIGHTNING STRIKE.

1. LAND AS SOON AS POSSIBLE.

a.

9-43. IN-FLIGHT WIRE STRIKE.

1. LAND AS SOON AS POSSIBLE.

a.

TM 55-1520-228-10

SECTION II MISSION EQUIPMENT.

NOT APPLICABLE

Table 9-1. Warning/Caution Panel Lights

WARNING LIGHT	CORRECTIVE ACTION
ROTOR RPM (Red)	<u>Verify condition. Adjust collective.</u>
MASTER CAUTION	Check for Caution Panel segment light illumination. <u>If none, LAND AS SOON AS POSSIBLE.</u>
ENGINE OUT (Red)	<u>Verify condition. AUTOROTATE.</u>
XMSN OIL PRESS (Red)	<u>LAND AS SOON AS POSSIBLE.</u>
XMSN OIL HOT (Red)	<u>LAND AS SOON AS POSSIBLE.</u>
CAUTION LIGHT	CORRECTIVE ACTION
FUEL BOOST	LAND AS SOON AS PRACTICABLE
20 MIN FUEL	LAND AS SOON AS PRACTICABLE
FUEL FILTER	<u>LAND AS SOON AS POSSIBLE.</u>
ENG OIL BYPASS	<u>LAND AS SOON AS POSSIBLE.</u>
ENG CHIP DET	<u>LAND AS SOON AS POSSIBLE.</u>
XMSN CHIP DET	<u>LAND AS SOON AS POSSIBLE.</u>
T/R CHIP DET	<u>LAND AS SOON AS POSSIBLE.</u>
INST INVERTER	Information/system status
DC GENERATOR	Refer to emergency procedures
HYD PRESS	Refer to emergency procedures
IFF	Information/system status
SPARE	<u>LAND AS SOON AS POSSIBLE.</u>

APPENDIX A REFERENCES

The following documents of the issue in effect on date of invitation for bids are required for use by overhaul maintenance personnel in performance of their duties and form a part of this Technical Manual (TM). Other specifications may be required as specified in these documents. Those specifications are not listed in this appendix.

AR 70-50	Designating and Naming Defense Military Aerospace Vehicles
AR 95-1	Army Aviation General Provisions and Flight Regulations
AR 385-40	Accident Reporting and Records
DA Form 2408-13	Aircraft Status Information Record
DA Form 2408-13-1	Aircraft Inspection and Maintenance Record
DA PAM 738-751	Functional Users Manual for the Army Maintenance Management System — Aviation (TAMMS-A)
FM 1-202	Environmental Flight
FM 1-203	Fundamentals Of Flight
FM 10-67-1	Concepts And Equipment Of Petroleum Operations
FM 10-68	Aircraft Refueling
MIL-STD-12	Abbreviations For Use On Drawing and in Specifications, Standards and Technical Documents
MWO 1-1520-228-50-48	Installation of Airframe Mounted Fuel Filter Assembly
MWO 1-1520-228-50-52	Installation of Altitude Voice Warning System
MWO 1-1520-228-50-53	Global Positioning System (GPS)
MWO 55-1520-228-30-30	Modification of OH-58 A/C Passenger Seat Cushions Installation
MWO 55-1520-228-50-24	Installation of Altimeter, AAU-31/AAU-32A in OH-58A Helicopter
MWO 55-1520-228-50-44	Installation of External Scavenger Oil Filter Kit
TM 1-1500-250-23-1	General Tie-Down and Mooring on All Series Army Models AH-64, UH-60, CH-47, UH-1, AH-1, and OH-58 Helicopters
TM 11-5810-262-OP	Operating Procedures for Cryptographic Speech Equipment TSEC/KY-58
TM 11-5841-284-23&P	Operator Organizational and Direct Support Maintenance Manual (including Repair Parts and Special Tools List Altimeter Set, Electronic, AN/APN-209(V) 1 and AN/APN209(V) 2.
TM 11-5841-294-12	Operator and Aviation Unit Maintenance Manual for Radar Signal Detecting Set An/APR-39A(V)1
TM 38-250	Preparation of Hazardous Materials for Military Air Shipment
TM 55-1500-342-23	Army Aviation Maintenance Engineering Manual — Weight and Balance
TM 750-244-1-5	Procedure for the Destruction of Aircraft and Associated Equipment to Prevent Enemy Use

APPENDIX B

DEPOT MOBILIZATION REQUIREMENT

B-1. DEPOT MOBILIZATION REQUIREMENTS. Under a state of mobilization, the procuring activity may elect to:

a. Eliminate the minor repair stipulation in the preshop analysis section of the DMWR. This will require all items to be overhauled, maximizing the longevity of such items but requiring full turnaround time during depot maintenance.

b. Extend the operating hour ceiling, which is currently stipulated in the preshop analysis section, for accomplishing minor repair. This will assure a quicker turnaround during depot maintenance but will not maximize longevity.

GLOSSARY

ASSEMBLY	A group of two or more physically connected and related parts, which is capable of disassembly, and when combined with other assemblies and parts, creates a component.
BRINELLING	Surface depressions produced by a severe blow, extremely heavy pressure, or rollers skidding or sliding instead of rolling.
COMPONENT	A group of physically connected assemblies and parts, which is capable of independent operation but may be externally controlled, or derives its power from another source and, when combined with other components, assemblies, or parts, forms a functional group or end item.
CONSUMABLE ITEMS	Parts of materials which are consumed by usage or have a one-time usage, normally losing identity upon application with, or assembled into the equipment.
CONTRACTING OFFICER	(CO) is used herein to indicate the Department of the Army individual responsible for overall administration of the contract.
DISASSEMBLY	As used herein, describes the operations necessary to reduce an assembly or sub-assembly to its separate components and parts.
FEDERAL STOCK NUMBER (FSN)	The Federal Stock Number for an item of supply consists of the applicable 4-digit Federal Supply Classification (FSC) code number, plus the applicable 7-digit Federal Item Identification Number (FIIN). The FSC code number relates the item to other like items of supply; the FIIN merely identifies the item as a unit. The FSN is incomplete unless both of these numbers are included.
GALLING	Aggravated condition of wear, generally caused by rubbing action with little or no lubrication.
MODIFICATION	An alteration or integral change affecting the configuration of the equipment or its respective parts, components, subassemblies, and assemblies.
OVERHAUL	To restore an item to a completely serviceable condition as prescribed by serviceability standards developed and published by USAAVSCOM.
PITTING	Small holes or indentations, generally caused by rust, corrosion, high compressive stresses or metal-to-metal pounding.
QUALITY AUDIT	A teardown inspection and evaluation of an overhauled or modified item for the purpose of Government verification that all work directed in the DMWR has been properly accomplished, and to establish the continued effectiveness of the contractor's quality control system including workmanship, materials used, and repair procedures. The quality audit shall include correction of any deficiencies, reassembly, test, and calibration to assure serviceable end items in accordance with the requirements of this DMWR.
REASSEMBLY	The assembling and aligning of all subassemblies and parts into a complete assembly to effect a serviceable item of equipment.
RECONDITION	As used herein, means the disassembly, cleaning, treating, lubrication, repair, or replacement of defective parts or components, and reassembly in accordance with the instructions contained in this DMWR.
REPAIR	To restore a defective part, component, subassembly, or assembly to a serviceable condition in accordance with the instructions contained in this DMWR.
SCORING	Very deep scratches caused by foreign particles between surfaces that are moving, or between one moving and one stationary surface. Scores follow the travel direction of the part.
SCRATCHING	Narrow shallow lines resulting from movement of foreign particles across a surface.

TM 55-1520-228-10

SERVICING

The lubrication, treating, cleaning, or preservation necessary to maintain the equipment and other respective parts in serviceable condition.

SPALLING

Chipped or flaked surface caused by the breaking away of the hardened surface layer of the metal. A surface fatigue condition which occurs from the undermining of the case hardened metal and separation of the case from the core.

TEST

As used herein, is the testing of equipment using shop test equipment to determine that the unit functions properly within the limits set forth in this DMWR.

■ USAAVSCOM — US

Army Aviation Systems Command.

INDEX

Subject	Paragraph Figure, Table Number
A	
AAU-31 / A PNEUMATIC ALTIMETER.	2-62
Description.	2-62.1
Operation.	2-62.2
Abnormal Operation.	2-62.2.b
Normal Operation.	2-62.2.a
ABBREVIATIONS.	1-6
AEROBATIC MANEUVERS.	5-22
AFTER EMERGENCY ACTION.	9-4
AIRFRAME MOUNTED FUEL FILTER ASSEMBLY.	2-22.1
AIRSPD INDICATOR.	2-61
AIRSPD LIMITS.	5-19.e
ALTERNATING CURRENT POWER SUPPLY.	2-50
Circuit Breakers.	2-50.b
Controls.	2-50.a
ALTITUDE ENCODER/PNEUMATIC ALTIMETER AAU-32/A.	2-62.1
AAU-32/A Altitude Encode/Pneumatic Altimeter.	F 2-18.1
Description.	2-62.1.a
Operation.	2-62.1.b
Abnormal Operation.	2-62.1.b.(2)
Normal Operation.	2-62.1.b.(1)
ANTI-COLLISION LIGHTS.	2-53
ANTI-TORQUE (DIRECTION) CONTROL.	2-28
Deleted.	2-28.a
APPENDIX A, REFERENCES.	1-4
APPROVED FUELS, OILS, AND FLUIDS.	2-74
Fluids.	2-74.c
Fuels.	2-74.a
Oils.	2-74.b
AREA 1 (f gure 8-1) – FUSELAGE – CABIN RIGHT SIDE.	8-10.1.*a., 8-10.2.a.
Exterior Check Diagram.	F 8-1, 8-10.1.e.
AREA 2 (f gure 8-1) TAILBOOM – RIGHT SIDE.	8-11.1.a.
AREA 3 (f gure 8-1) TAILBOOM – LEFT SIDE.	8-12.3.b.
AREA 4 (f gure 8-1) AFT FUSELAGE – LEFT SIDE.	8-13.1
AREA 5 (f gure 8-1) FUSELAGE – CABIN LEFT SIDE.	8-14.*2
AREA 6 (f gure 8-1) FUSELAGE – FRONT.	8-15.1.e.
ARMY AVIATION SAFETY PROGRAM.	1-7
ATTITUDE INDICATOR.	2-64
AUTOMATIC REMOTE KEYING PROCEDURE.	3-32.c
AUXILIARY FUEL SYSTEM.	2-23.a
Auxiliary Fuel System.	F 2-15
AVIATION LIFE SUPPORT EQUIPMENT (ALSE).	8-2

B

BEFORE EXTERIOR CHECKS.	8-8.5.h.
BEFORE LANDING.	8-23.1
BEFORE LEAVING THE HELICOPTER.	8-25
BEFORE STARTING ENGINE.	8-16.1, 8-16.3.*n.
BEFORE TAKEOFF.	8-19.*2

BLADE GRIPS AND PILLOW BLOCKS SERVICING.	2-82
BLEED AIR HEATING SYSTEM.	2-47
Description.	2-47.a
■ Heater Control and Vent Pull Knobs C	F 2-17
Heating and Ventilation A	F 2-16
Operation	2-47.b

C

CARGO MOMENT.	6-13
Cargo Moment Chart	F 6-8
CARGO PLATFORM.	6-7
CARGO RESTRAINT CRITERIA.	6-7.1
CARGO SPACE (Figure 6-3).	6-6
CAUTION INDICATOR.	2-34
CENTER OF GRAVITY LIMIT CHART (Figure 6-2).	6-5.a
CENTER OF GRAVITY LIMITATIONS.	5-17
CHAPTER 7 INDEX.	7-2
CHART DIFFERENCES.	7-38.a
CHECKLIST.	8-6
CLASSIFICATION OF HELICOPTER.	6-2
CLEAR VOICE PROCEDURES.	3-30
CLUTCH FAILS TO DISENGAGE.	9-24
COCKPIT AND CABIN DOOR RESTRICTIONS.	5-20.b.(2)
COCKPIT AND CABIN DOORS.	2-4
Float Gear Equipped Helicopter A	F 2-7
Locking Devices for Doors	F 2-8
COCKPIT UTILITY LIGHT.	2-59
Cockpit Utility Lights.	2-59.a
COLD WEATHER OPERATIONS.	8-34
Checks.	8-34.b.(1), 8-34.b.(2)
Engine Anti-Icing.	8-34.d
Engine Starting Without External Power Supply.	8-34.c
Inspection.	8-34.a
COLLECTIVE PITCH CONTROL.	2-27
Copilot Collective Pitch Control Installation.	2-27.b.(2)
Copilot Collective Pitch Control Stowage.	2-27.a.(2)
A COMBUSTION HEATER.	2-48
Combustion Heater Pre-Start Check.	2-48.b
Description.	2-48.a
Emergency Shutdown.	2-48.d.(1)
Normal Operation.	2-48.c.(3)
COMMUNICATIONS SYSTEM CONTROL, C-6533/ARC.	3-6
COMPLETE LOSS OF TAIL ROTOR THRUST.	9-19.b
Powered Flight.	9-19.a
Indications:	9-19.a.(1)
Procedures.	9-19.a.(2)
COMPRESSOR BLEED AIR SYSTEM.	2-16
CONDITIONS.	7-40, 7-43, 7-49, 7-52, 7-55, 7-61
Climb-Descent Chart C	F 7-17
Cruise Chart C	F 7-15
■ Drag Chart	F 7-16
Hover Chart C	F 7-13
Idle Fuel Flow Chart C	F 7-19
Maximum Torque Available (30 Minute Operation) Chart C	F 7-11
Torque Available (Continuous Operation) Chart C	F 7-12
CONSOLE LIGHTS.	2-57.b
Night Vision Features (for Flights Using Night Vision Goggles (NVG)).	2-57.a
CONTROL MOVEMENTS.	5-23

CONTROL..... 2-33

CONTROLS AND FUNCTION – FM RADIO SET AN/ARC-201 & ZEROIZE SWITCH. 3-73

CONTROLS AND FUNCTIONS — COMMUNICATION SYSTEM CONTROL. 3-8

CONTROLS AND FUNCTIONS — CONUS NAVIGATION RECEIVER. 3-49

CONTROLS AND FUNCTIONS – COURSE DEVIATION INDICATOR. 3-53

CONTROLS AND FUNCTIONS — DIRECTION FINDER SET (AN/ARN-89). 3-37

CONTROLS AND FUNCTIONS — FM RADIO SET. 3-12

CONTROLS AND FUNCTIONS — GYRO MAGNETIC COMPASS SET. 3-41

CONTROLS AND FUNCTIONS – RADAR ALTIMETER. 3-66

CONTROLS AND FUNCTIONS – RADAR SIGNAL DETECTING SET (AN/APR-39A(V)1). 3-69

CONTROLS AND FUNCTIONS — RADIO BEARING HEADING INDICATOR. 3-45

A CONTROLS AND FUNCTIONS – TRANSPONDER SET. 3-57

CONTROLS AND FUNCTIONS — UHF/AM RADIO SET (AN/ARC-116 or AN/ARC-164). 3-20

CONTROLS AND FUNCTIONS – UHF/AM RADIO SET (RT-1167/ARC-164(V) or RT-1167C/ARC-164(V)). ... 3-25

 RT-1167/ARC-164(V). 3-25.a

 RT-1167C/ARC-164(V). 3-25.b

CONTROLS AND FUNCTIONS — VHF/AM RADIO SET (AN/ARC-115). 3-16

CONTROLS AND INDICATORS. 2-24

 Fuel Boost Caution Light. 2-24.b

 Fuel Boost Pump Switch. 2-24.c

 Fuel Filter Caution Light. 2-24.e

 Fuel Quantity Indicator. 2-24.a

 Low Fuel Quantity Caution Light. 2-24.d

C CONUS NAVIGATION RECEIVER. 3-47

C CONUS NAVIGATION SYSTEM (AN/ARN-123). 2-69

COURSE DEVIATION INDICATOR (CDI). 3-51

COVERS. 2-85

 Engine Exhaust. 2-85.b

 Engine Inlet and Pitot Tube. 2-85.a

 Main Rotor Tie-Down. 2-85.c

CREW DUTIES/RESPONSIBILITIES. 8-3

 Crew Brief ng. 8-3.a

 Passenger Brief ng. 8-3.b.(2)

CRITICAL TAILBOOM DYNAMIC MODES. 8-31

CYCLIC CONTROL. 2-26

 Copilot Cyclic Stick Installation. 2-26.b.(4)

 Copilot Cyclic Stick Storage. 2-26.a.(1)

D

DATA BASIS. 7-6

 Calculated Data. 7-6.c

 Derived From Flight Test. 7-6.b

 Estimated Data. 7-6.d

 Flight Test Data. 7-6.a

DD FORM 365-1 – BASIC WEIGHT CHECK LIST. 6-14

DD FORM 365-3 – BASIC WEIGHT AND BALANCE RECORD. 6-15

DD FORM 365-4 – WEIGHT AND BALANCE CLEARANCE FORM F. 6-16

DEFINITION OF EMERGENCY TERMS. 9-3.b

DEFINITIONS OF ABBREVIATIONS. 7-10.c

DELETED. 2-55, 3-4, 3-62, 5-9, 5-19.1, 5-27, 6-11, 7-45, 7-58, 8-22, 30.1

 Climb Performance **C**. F 7-18

 Radar Altimeter. F 3-16

 Transponder Set Control Panel **C**. F 3-14

Depot Mobilization Requirements. B-1.a

DESCRIPTION – CLIMB-DESCENT CHART. 7-53

DESCRIPTION — COMMUNICATIONS SYSTEM CONTROL. 3-7

DESCRIPTION — CONUS NAVIGATION RECEIVER. 3-48

 CONUS Navigation Receiver Control Panel **C**. F 3-11

TM 55-1520-228-10

Course Deviation Indicator (CDI) C	F 3-12
DESCRIPTION – COURSE DEVIATION INDICATOR.	3-52
DESCRIPTION — DIRECTION FINDER SET(AN/ARN-89).	3-36
DESCRIPTION — GYRO MAGNETIC COMPASS SET.	3-40
DESCRIPTION — MANUAL	1-3
DESCRIPTION – RADAR ALTIMETER.	3-65
DESCRIPTION – RADAR SIGNAL DETECTING SET (AN/APR-39A(V)1).	3-68.1
Description.	3-68.1.a
Function.	3-68.1.b.(1)
DESCRIPTION — RADIO BEARING HEADING INDICATOR.	3-44
Radio Bearing Heading Indicator	F 3-10
A DESCRIPTION – TRANSPONDER SET.	3-56
DESCRIPTION – UHF/AM RADIO SET (RT-1167/ARC-164(V) or RT-1167C/ARC-164(V)).	3-24
RT-1167/ARC-164(V).	3-24.b
B DESCRIPTION — VHF/AM RADIO SET (AN/ARC-115).	3-15
DESCRIPTION — VHF/FM RADIO SET.	3-11, 3-72
B DESCRIPTION —(AN/ARC-116 or AN/ARC-164).	3-19
DESCRIPTION.	2-25, 2-32, 7-37, 7-41, 7-47, 7-50, 7-59
DESERT AND HOT WEATHER OPERATIONS.	8-36
DESIGNATOR SYMBOLS.	1-11
DESTRUCTION OF ARMY MATERIAL TO PREVENT ENEMY USE.	1-8
DIRECT CURRENT PRIMARY POWER.	2-49
Auxiliary Power Receptacle.	2-49.d
Circuit Breakers.	2-49.b
Electrical System Schematic	F 2-18
External Power Receptacle.	2-49.c
Indicators and Controls.	2-49.a
Battery Switch.	2-49.a.(3)
DC Power Control.	2-49.a.(2)
DC System Indicator.	2-49.a.(1)
Generator Switch.	2-49.a.(4)
Non-Essential Bus Switch.	2-49.a.(5)
DIRECTION FINDER SET — (AN/ARN-89).	3-35
DITCHING – POWER OFF.	9-40
DITCHING – POWER ON.	9-39
DRIVESHAFTS.	2-40
Main Driveshaft.	2-40.a
Tail Rotor Driveshaft.	2-40.b

E

ELECTRICAL FIRE – FLIGHT.	9-30
ELECTRICAL SYSTEM MALFUNCTIONS.	9-32
EMERGENCY EQUIPMENT.	9-5
EMERGENCY EXITS/EMERGENCY ENTRANCE.	9-6
ENGINE AUTOMATIC RELIGHT SYSTEM (NOT USED).	2-20
ENGINE COMPARTMENT COOLING.	2-10
ENGINE COMPRESSOR STALL.	9-13
ENGINE FAILURE – HOVER.	9-10
ENGINE FAILURE – LOWER ALTITUDE/LOW AIRSPEED OR CRUISE.	9-11
ENGINE FUEL CONTROL SYSTEM.	2-13
B Deleted.	2-13.a, 2-13.h
Droop Compensator.	2-13.c
Engine Idle Release Control.	2-13.d
Fuel Nozzle.	2-13.k
Fuel Pump and Filter Assembly.	2-13.i
Gas Producer Fuel Control.	2-13.f
Governor RPM Switch.	2-13.e
Overhead Console	F 2-12

Overhead Console with AN/ARC-201 (Typical) F 2-12.1

Power Turbine Governor. 2-13.g

Throttle. 2-13.b

ENGINE INLET ANTI-ICING SYSTEM 2-12

ENGINE INSTRUMENTS AND INDICATORS. 2-21

Dual Tachometer. 2-21.g

Engine Chip Detector. 2-21.l

Engine Oil Bypass Caution Light. 2-21.k

Engine Out Audio Warning. 2-21.b

Engine Out Warning. 2-21.a

Gas Producer Tachometer. 2-21.f

 A Oil Pressure Gage. 2-21.h

 C Oil Pressure/Temperature Indicator. 2-21.j

 A Oil Temperature Gage. 2-21.i

Torquemeter. 2-21.c

 A Turbine Outlet Temperature Gage. 2-21.d

 C Turbine Outlet Temperature Indicator. 2-21.e

ENGINE LIMITATIONS. 5-11

ENGINE MALFUNCTION – PARTIAL OR COMPLETE POWER LOSS. F 9-3

 Autorotational Glide Characteristics Chart F 9-2

 Complete Power Loss. 9-7.d

 Emergency Exits and Equipment F 9-1

 Flight Characteristics. 9-7.b

 Low Airspeed and Low Altitude. 9-7.e

 Partial Power Condition. 9-7.c

ENGINE OIL SUPPLY SYSTEM – EXTERNAL SCAVENGE OIL FILTER (After Compliance with MWO
55-1520-228-50-44). 2-17.1

ENGINE OIL SUPPLY SYSTEM. 2-17

ENGINE OIL SYSTEM SERVICING. 2-79

ENGINE OVERSPEED. 9-14

ENGINE RESTART – DURING FLIGHT. 9-12

ENGINE RUNUP. 8-18.*9.e., 8-18.*9.f.

ENGINE SHUTDOWN. 8-24.10

ENGINE STARTING LIMITATIONS. 5-14

ENGINE SURGES. 9-16

ENGINE UNDERSPEED. 9-15.a

ENGINE. 2-9

 Combustion Section. 2-9.b

 Compressor. 2-9.a

 Engine F 2-11

 Power and Accessories Gearbox. 2-9.d

 Turbine. 2-9.c

ENGINE/FUSELAGE FIRE – IN FLIGHT. 9-29

 If Power-Off landing: 9-29.b

 If Power-On landing: 9-29.a

ENGINE/FUSELAGE/ELECTRICAL FIRE – GROUND. 9-28

EXCEEDING OPERATIONAL LIMITS. 5-3

EXTERIOR CHECK. 8-9

F

FIRE EXTINGUISHER. 2-8

FIRE. 9-26

FIRST AID KIT. 2-7

FIXED PITCH SETTINGS. 9-20

 Hover. 9-20.c

 Indication: 9-20.c.(1)

 Procedure. 9-20.c.(2)

 Increased power (high torque). 9-20.b

TM 55-1520-228-10

Indications:	9-20.b.(1)
Procedure:	9-20.b.(2)
Reduced power (low torque).	9-20.a
Procedure:	9-20.a.(2)
FLIGHT CONTROL MALFUNCTIONS.	9-41
FLIGHT IN RAIN, SNOW AND ICING CONDITIONS.	5-32-1
FLIGHT IN SAND AND DUST CONDITIONS.	5-32
FLIGHT OVER SALT WATER.	5-31
FLIGHT RESTRICTION FOR HIGH POWER.	5-28
Practice Autorotation Landing Limits Crosswind Components	F 5-4
A FLIGHT RESTRICTION WITH FLOAT LANDING GEAR INSTALLED.	5-21
Airspeed Limit.	5-21.a
B Airspeed Operating Limits Chart	F 5-3
Altitude Limitation.	5-21.b
FLIGHT RESTRICTIONS AT LOW "G'S".	5-25
FLIGHT RESTRICTIONS FOR PRACTICE AUTOROTATION LANDINGS. (Figure 5-4.)	5-26.g
FLIGHT RESTRICTIONS IN FALLING OR BLOWING SNOW.	5-30.b
FLIGHT UNDER INSTRUMENT METEOROLOGICAL CONDITIONS (IMC).	5-29
FORCE TRIMS (FORCE GRADIENT).	2-29
FORMS AND RECORDS.	1-9
FREE AIR TEMPERATURE INDICATOR.	2-66
FREE AIR TEMPERATURES.	7-11
Temperature Conversion Chart	F 7-1
FREEWHEELING ASSEMBLY.	2-38
FUEL LOADING CHART (Figure 6-4).	6-8, F 6-2, F 6-3, F 6-5
C Cargo Space	F 6-3
Center of Gravity Limit Chart	F 6-2
Fuel Loading Chart	F 6-4
Personnel Loading	F 6-5
FUEL OPERATION LIMITS.	5-12
Emergency Fuel Aviation Gasoline (MIL-G-5572) without Tricresyl Phosphate (TCP).	5-12.c
JP-4.	5-12.a
JP-5, JP-8, Jet A and Jet A-1.	5-12.b
FUEL SUPPLY SYSTEM.	2-22
FUEL SYSTEM SERVICING. (POWER OFF)	2-77
Closed Circuit Refueling.	2-77.c
Gravity Refueling With Closed Circuit Receiver	2-77.c.(6)
Gravity Refueling.	2-77.d.(3)
Precaution.	2-77.a.(3)
Servicing.	2-77.b.(2)
FUEL SYSTEM SERVICING. (RAPID (HOT) REFUELING).	2-78
After Rapid Refueling.	2-78.e.(2)
Before Rapid (Hot) Refueling:	2-78.c.(2)
Defueling and Draining.	2-78.f.(1)
During Rapid (Hot) Refueling.	2-78.d
Closed Circuit Refueling.	2-78.d.(1)
Gravity Refueling.	2-78.d.(2)
Precautions.	2-78.a.(1)
Refueling Receptacle	2-78.a.(3)
Servicing.	2-78.b.(2)
FUEL TYPES.	2-75
Emergency Fuel.	2-75.c
JP-4.	2-75.a
JP-5 and JP-8.	2-75.b

G

GENERAL CONDITIONS.	7-8
Aircraft Variation.	7-8.c

Instrument Variation. 7-8.d
 Pilot Technique. 7-8.b
 Rigging. 7-8.a
 Types of Fuel. 7-8.e
 GENERAL. 1-1, 3-1, 5-2, 6-1, 7-3, 8-33
 Crew Configuration. 2-1.d
 Dimensions. 2-1.a
 Turning Radius and Ground Clearance. 2-1.b
 Weights. 2-1.c
 GENERATOR FAILURE – NO OUTPUT. 9-33
 GLOBAL POSITIONING SYSTEM (MWO 1-1520-228-50-53). 3-54.1
 GROUND HANDLING. 2-83
 GYRO MAGNETIC COMPASS SET — AN/ASN-43. 3-39

H

HEALTH INDICATOR TEST (HIT). 5-15
 HELICOPTER DESIGNATION SYSTEM. 1-10
 HELICOPTER STATION DIAGRAM. F 6-1
 Helicopter Station Diagram F 6-1
 HELICOPTER SYSTEMS. 9-1
 HORIZONTAL STABILIZER. 2-30
 HOT START. 9-27
 HOVER CHECK. 8-20.*3
 HOVERING LIMITATIONS. 5-16, 5-24
 HYDRAULIC POWER FAILURE. 9-36
 HYDRAULIC SYSTEM MALFUNCTION. 9-35
 HYDRAULIC SYSTEM SERVICING. 2-81

I

ICING CONDITIONS. 8-40
 IGNITION SYSTEM. 2-18.b
 IMMEDIATE ACTION EMERGENCY STEPS. 9-2
 IN-FLIGHT WIRE STRIKE. 9-43
 Warning/Caution Panel Lights T 9-1
 INDEX. 1-5
 INDICATORS. 2-41
 Tail Rotor Gearbox Chip Detector. 2-41.b
 Transmission Chip Detectors. 2-41.a
 Transmission Oil Pressure Warning Light. 2-41.c
 Transmission Oil Temperature Warning Light. 2-41.d
 INDUCTION SYSTEM. 2-11
 Intake Ducting. 2-11.a
 Particle Separator. 2-11.b
 INFRARED SUPPRESSION SYSTEM. 2-14
 INSTRUMENT FLIGHT – GENERAL. 8-26
 INSTRUMENT LIGHTS. 2-56
 INSTRUMENT MARKINGS. 5-5
 Instrument Markings F 5-2
 ☑ Limitation Markings. 5-5.c
 Operating Limitations and Ranges. 5-5.a

K

KY-58 AUDIO TONES. 3-34.c.(3), 3-34.f

L

LANDING AND DITCHING. 9-37

 LANDING GEAR SYSTEM. F 2-1, F 2-2, F 2-3, F 2-4

 Compartment Diagram **A** F 2-3

A Float Gear. 2-3.c

 General Arrangement **A** F 2-1

 General Arrangement **C** Typical F 2-2

 High Skid Gear. 2-3.b

 Pilot and Copilot/Observer Station Diagram F 2-4

 Principal Dimensions F 2-5

 Standard System. 2-3.a

 Tail Skid. 2-3.d

 Turning Radius and Ground Clearance F 2-6

LANDING IN TREES. 9-38

LANDING LIGHTS. 2-54

LIGHTNING STRIKE. 8-39, 9-42

LIMITS. 7-4

LOADING CHARTS. 6-4

 Information. 6-4.a

 Use. 6-4.b

LOSS OF TAIL ROTOR COMPONENTS. 9-21

 Indications: 9-21.a.(1)

 Procedure: 9-21.b

LOSS OF TAIL ROTOR EFFECTIVENESS (LTE). 9-22

LOSS OF TAIL ROTOR EFFECTIVENESS. 8-32.a, 8-32.c.(2)

 Effects of Wind Azimuth On Aircraft. F 8-2

M

MAGNETIC COMPASS. 2-67

MAIN DRIVESHAFT FAILURE. 9-23

MAIN ROTOR RPM INDICATOR. 2-43

MAIN ROTOR. 2-42

MANUAL REMOTE KEYING PROCEDURES. 3-33.d.(1)

MAST BUMPING. 8-28, 9-25

MAXIMUM GLIDE DISTANCE – POWER OFF. 9-9

MINIMUM CREW REQUIREMENTS. 5-4

MINIMUM RATE OF DESCENT – POWER OFF. 9-8

MISCELLANEOUS INDICATORS. 2-72

 Caution System. 2-72.b

 Clock. 2-72.a

 Warning and Caution Panels F 2-19

 Warning System. 2-72.c

MISSION PLANNING. 8-1

MOORING — FLOAT EQUIPPED HELICOPTER. 2-87

 Ground Handling Equipment, Covers, Rotor Tiedowns, and Mooring Diagram F 2-24

 Paved Surface Mooring Configuration (OH-58A/C) F 2-25

MOORING. 2-86.c

N

NOMENCLATURE AND COMMON NAMES. 3-3

NVG POSITION LIGHTS. 2-52

NVG-COMPATIBLE FILTERS. 2-60

O

OIL DATA. 6-9

OPERATING CHARACTERISTICS. 8-27.b

OPERATING PROCEDURE — UHF/AM RADIO SET (AN/ARC-116). 3-21

 Stopping Procedures. 3-21.b

 Transmit/Receive. 3-21.a.(3)

OPERATING PROCEDURE— UHF/AM RADIO SET (RT-1167/ARC-164(V) or RT-1167C/ARC-164(V)). 3-26,
F 3-5, F 3-6

 AN/ARC-115 Control Panel F 3-4

 AN/ARC-116 Control Panel F 3-5

HAVE QUICK System Operation. 3-26.b.(4)

Modes of Operation. 3-26.a.(1), 3-26.a.(4)

 Radio Set ARC-164(V) Operation. b

 UHF/AM Radio Sets AN/ARC-164, RT-1167/ARC-1164(V), and RT-1167C/ARC-1164(V) F 3-6

OPERATING PROCEDURES — COMMUNICATIONS SYSTEM CONTROL. 3-9

 Modes of Operation. 3-9.a

 Operation. 3-9.b.(2)

OPERATING PROCEDURES — CONUS NAVIGATION RECEIVER. 3-50

 Stopping Procedure. 3-50.b

 System Operation. 3-50.a.(3)

OPERATING PROCEDURES — COURSE DEVIATION INDICATOR. 3-54

OPERATING PROCEDURES — DIRECTION FINDER SET (AN/ARN-89). 3-38

 AN/ARN-89 (ADF) Control Panel F 3-9

COMPASS Mode. 3-38.a.(2)

 LOOP Mode. 3-38.b

Manual Operation. 3-38.d.(5)

 Preliminary. 3-38.c

 Stopping Procedure. 3-38.e

OPERATING PROCEDURES — FM RADIO SET AN/ARC-201 & ZEROIZE SWITCH. 3-74

 Frequency Hopping. 3-74.b.(1), 3-74.b.(13)

 Homing. 3-74.c.(1)

 Retransmission. 3-74.d

 Scanning. 3-74.e.(4)

 Transmit/Receive. 3-74.a.(5)

 OPERATING PROCEDURES — FM RADIO SET. F 3-2, F 3-3

 AN/ARC-114 and AN/ARC-114A Control Panel 3-13.c.(3)

 Communication System Control Panel C-6533/ARC F 3-2

 Homing. 3-13.b.(3)

 Retransmission. 3-13.c

 Stopping Procedures. 3-13.d

 Transmit/Receive 3-13.a.(4)

 OPERATING PROCEDURES — GYRO MAGNETIC COMPASS SET. 3-42.a

 OPERATING PROCEDURES — RADAR ALTIMETER. 3-67, 3-67.4

 Altimeter Operation. 3-67.a, 3-67.4.a

 Self Test Operation. 3-67.4.b.(5)

 Self-Test Operation. 3-67.b.(4)

 Stopping Procedure. 3-67.c, 3-67.4.c

 OPERATING PROCEDURES — RADAR SIGNAL DETECTING SET (AN/APR-39A(V)1). 3-70

 MODE 1 Operation. 3-70.b

 MODE 2 Operation. 3-70.c

 Radar Signal Detecting Set AN/APR-39A(V)1 F 3-17

 Self-Test Mode. 3-70.a.(4)

 OPERATING PROCEDURES — RADIO BEARING HEADING INDICATOR. 3-46.d

 ADF Pointer **A** (Bearing Pointer **B**). 3-46.b

 FM Homing. 3-46.c.(1)

 Gyro-magnetic Heading Display and Synchronization. 3-46.a.(1)

A OPERATING PROCEDURES — TRANSPONDER SET. 3-58

 Stopping Procedure. 3-58.b

 Transponder APX-72 Control Panel **A** F 3-13, 3-58.a.(4)

 Transponder Operation. 3-58.a.(1)

 OPERATING PROCEDURES — UHF/AM RADIO SET (AN/ARC-164). 3-22

TM 55-1520-228-10

Stopping Procedure. 3-22.b
Transmit/receive. 3-22.a.(3)
OPERATING PROCEDURES — VHF/AM RADIO SET (AN/ARC-115). 3-17
Stopping Procedure. 3-17.b
Transmit/Receive. 3-17.a
OPERATING PROCEDURES AND MANEUVERS. 8-4
OPERATING PROCEDURES. 3-28
OVERHEATED BATTERY. 9-34

P

PARKING. 2-84.b
PASSIVE DEFENSE. 2-2
PERFORMANCE DISCREPANCIES. 7-9
PERSONNEL LOADING (Figure 6-5). 6-10.a
PITOT HEATING SYSTEM. 2-46
Description. 2-46.a
Operation. 2-46.b
POSITION LIGHTS. 2-51
POWER SUPPLY. F 3-1
Antenna Locations F 3-1
Communications and Associated Electronics Equipment T 3-1
PREFLIGHT CHECK. 8-7
PRESSURE ALTIMETER. 2-63
PURPOSE. 5-1, 7-1.b
PYLON SUPPORT STRUCTURE. 2-36.a.(2)
PYLON SUSPENSION SYSTEM. 2-37.a
PYLON WHIRL. 8-30

R

RADAR ALTIMETER (AN/APN-209). 2-70
RADAR ALTIMETER (with MWO 1-1520-228-50-52). 3-67.1
RADAR ALTIMETER (without MWO 1-1520-228-50-52). 3-64
RADAR SIGNAL DETECTING SET (AN/APR-39A(V)1). 3-68
RADAR WARNING SYSTEM. 2-71
RADIO BEARING HEADING INDICATOR — ID-1351A. 3-43
ROTOR BLADE TIE-DOWN. 2-86.1.a
ROTORS, TRANSMISSION AND DRIVE SYSTEMS MALFUNCTIONS. 9-17
RPM WARNING SYSTEM. 2-44

S

SAND AND DUST OPERATION. 8-41
Extended Ground Operations. 8-41.b
Ground Operations. 8-41.a
SEATS. 2-5
Passenger Seats. 2-5.b
Pilot and Copilot/Observer Seats. 2-5.a
SECURE VOICE PROCEDURES. 3-29.d
SERVICING. 2-73
Fuels, Oils, Fluids, Specifications, and Capacities. 2-73.b
Servicing Diagram. 2-73.a
SIGNAL LIGHT RECEPTACLE. 2-58
SLOPE LANDING/TAKE-OFF LIMITATIONS. 5-28.1
SMOKE AND FUME ELIMINATION. 9-31
SNOW OPERATIONS. 8-35
SPECIFIC CONDITIONS. 7-7
SPIKE KNOCK. 8-29

STARTER LIMITS. 5-13
 Starter Engine Time 5-13.a
 STARTER SWITCH. 2-19
 Instrument Panel and Console **C** F 2-14
 Instrument Panel and Console (Typical) **A** F 2-13
 Instrument Panel and Console with AN/ARC-201 **C** (Typical) F 2-14.2
 STARTING ENGINE. 8-17.*3.d.
 SYMBOLS DEFINITION. 8-5

T

TAIL ROTOR FAILURE AND DIRECTIONAL CONTROL MALFUNCTIONS. 9-18
 TAIL ROTOR GEARBOX. 2-39
 TAIL ROTOR. 2-45
 TAKEOFF. 8-21
 TEMPERATURE MEASUREMENT SYSTEM. 2-15
 THUNDERSTORMS. 8-38.a.(1)
 In the storm: 8-38.b.(1)
 TOWING LIMITATIONS. 5-10
 TRANSMISSION AND GEARBOX OIL SYSTEM SERVICING. 2-80
 Gearbox. 2-80.b
 Transmission. 2-80.a
 TRANSMISSION OIL PRESSURE LIMITS. 5-7
 TRANSMISSION OIL TEMPERATURE LIMITS. 5-6
 TRANSMISSION. 2-35
C TRANSPONDER SET – AN/APX-100. 3-59
 Controls and Functions. 3-59.b
 Description. 3-59.a
 Operating Procedures. 3-59.c
 Emergency Operation. 3-59.c.(2)
 Stopping Procedure. 3-59.c.(3)
 Transponder Operation. 3-59.c.(1)
A TRANSPONDER SET – AN/APX-72. 3-55
 TURBULENCE LIMITATIONS. 5-33.b
 TURBULENCE. 8-37
 TURN AND SLIP INDICATOR. 2-65

U

UHF/AM RADIO SET (AN/ARC-116 or AN/ARC-164). 3-18
 UHF/AM RADIO SET (RT-1167/ARC-164(V) or RT-1167C/ARC-164(V)). 3-23
 USE OF CHART. 7-42.b.(5), 7-51, 7-60
 USE OF CHARTS. 7-5, 7-39, 7-48
 Airspeed. 7-48.a
 Chart Explanation. 7-5.a
 Color Coding. 7-5.b.(2)
 Fuel Flow. 7-48.c
 Maximum Endurance and Maximum Rate of Climb. 7-48.e
 Maximum Range. 7-48.d
 Reading the Charts. 7-5.c
 Torque (%Q). 7-48.b
 USE OF CLIMB-DESCENT CHART. 7-54.a
 USE OF FUELS. 2-76
 Approved Fluids T 2-4
 Approved Fuels T 2-2
 Approved Oils T 2-3
 Emergency Fuels. 2-76.c
 Fuels, Oils, Fluids, Specifications, and Capacities T 2-1
 JP-4. 2-76.a

TM 55-1520-228-10

JP-5, JP-8, Jet A, and Jet A1. 2-76.b
 Servicing Diagram **A** F 2-20, F 2-21
USE OF WORD SHALL, SHOULD, AND MAY. 1-12

V

VERTICAL FIN. 2-31
VERTICAL SPEED INDICATOR. 2-68
VHF/AM RADIO SET — AN/ARC-115. 3-14
VHF/FM RADIO SET AN/ARC-201. 3-71
VHF/FM RADIO SET. 3-10
VOICE SECURITY EQUIPMENT (TSEC/KY-58). 3-27
 Controls and Functions. 3-27.b
 Description. 3-27.a

W

WARNINGS, CAUTIONS, AND NOTES DEFINED. 1-2
WEIGHT LIMITATIONS. 5-18
WIND LIMITATIONS. 5-8.a
WIRE STRIKE PROTECTION SYSTEM (WSPS). 2-6
 Avoidance. 2-6.b
 Wire Strikes. 2-6.a
 WSPS Configuration. F 2-9

Z

ZEROIZE SWITCH. F 3-7
 AN/ARC-201 Control Panel & Zeroize Switch. F 3-7
 Description. 3-75.a
ZEROIZING PROCEDURES. 3-31
 Voice Security Equipment T/SEC KY-58. F 3-8

By Order of the Secretary of the Army:

CARL E. VUONO
General, United States Army
Chief of Staff

Official:

WILLIAM J. MEEHAN II
Brigadier General, United States Army
The Adjutant General

DISTRIBUTION:

To be distributed in accordance with DA Form 12-31, -10 and CL requirements for OH-58A and OH-58C Helicopter, Observation.

*U.S. GOVERNMENT PRINTING OFFICE: 1994 - 300-421 (82053)

*U.S. GOVERNMENT PRINTING OFFICE: 1994 300-421/82053

These are the instructions for sending an electronic 2028

The following format must be used if submitting an electronic 2028. The subject line must be exactly the same and all fields must be included; however only the following fields are mandatory: 1, 3, 4, 5, 6, 7, 8, 9, 10, 13, 15, 16, 17, and 27.

From: "Whomever" whomever@wherever.army.mil

To: 2028@redstone.army.mil

Subject: DA Form 2028

1 **From: Joe Smith**
2 *Unit: home*
3 **Address: 4300 Park**
4 **City:** Hometown
5 **St: MO**
6 **Zip: 77777**
7 **Date Sent:** 19--OCT--93
8 **Pub no:** 55--2840--229--23
9 **Pub Title: TM**
10 **Publication Date:** 04--JUL--85
11 *Change Number: 7*
12 *Submitter Rank:* MSG
13 **Submitter FName:** Joe
14 *Submitter MName:* T
15 **Submitter LName:** Smith
16 **Submitter Phone:** 123--123--1234
17 **Problem: 1**
18 *Page: 2*
19 *Paragraph: 3*
20 *Line: 4*
21 *NSN: 5*
22 *Reference: 6*
23 *Figure: 7*
24 *Table: 8*
25 *Item: 9*
26 *Total: 123*

27 **Text:**

This is the text for the problem below line 27.

RECOMMENDED CHANGES TO PUBLICATIONS AND BLANK FORMS For use of this form, see AR 25-30; the proponent agency is ODISC4.						Use Part II (reverse) for Repair Parts and Special Tool Lists (RPSTL) and Supply Catalogs/ Supply Manuals (SC/SM)	DATE 8/30/02
TO: (Forward to proponent of publication or form)(Include ZIP Code) Commander, U.S. Army Aviation and Missile Command ATTN: AMSAM--MMC--MA--NP Redstone Arsenal, AL 35898						FROM: (Activity and location)(Include ZIP Code) MSG, Jane Q. Doe 1234 Any Street Nowhere Town, AL 34565	
PART 1 - ALL PUBLICATIONS (EXCEPT RPSTL AND SC/SM) AND BLANK FORMS							
PUBLICATION/FORM NUMBER TM 9-1005-433-24						DATE 16 Sep 2002	TITLE Organizational, Direct Support, And General Support Maintenance Manual for Machine Gun, .50 Caliber M3P and M3P Machine Gun Electrical Test Set Used On Avenger Air Defense Weapon System
ITEM NO.	PAGE NO.	PARA-GRAPH	LINE NO. *	FIGURE NO.	TABLE NO.	RECOMMENDED CHANGES AND REASON	
1	WP0005 PG 3		2			Test or Corrective Action column should identify a different WP number.	
EXAMPLE							
* Reference to line numbers within the paragraph or subparagraph.							
TYPED NAME, GRADE OR TITLE MSG, Jane Q. Doe, SFC					TELEPHONE EXCHANGE/ AUTOVON, PLUS EXTENSION 788-1234		SIGNATURE

TO: (Forward direct to addressee listed in publication) Commander, U.S. Army Aviation and Missile Command ATTN: AMSAM-MMC-MA-NP Redstone Arsenal, AL 35898	FROM: (Activity and location) (Include ZIP Code) MSG, Jane Q. Doe 1234 Any Street Nowhere Town, AL 34565	DATE 8/30/02
---	---	------------------------

PART II - REPAIR PARTS AND SPECIAL TOOL LISTS AND SUPPLY CATALOGS/SUPPLY MANUALS

PUBLICATION NUMBER			DATE	TITLE				
PAGE NO.	COLM NO.	LINE NO.	NATIONAL STOCK NUMBER	REFERENCE NO.	FIGURE NO.	ITEM NO.	TOTAL NO. OF MAJOR ITEMS SUPPORTED	RECOMMENDED ACTION
EXAMPLE								

PART III - REMARKS (Any general remarks or recommendations or suggestions for improvement of publications and blank forms. Additional blank sheets may be used if more space is needed.)

EXAMPLE

TYPED NAME, GRADE OR TITLE MSG, Jane Q. Doe, SFC	TELEPHONE EXCHANGE/AUTOVON, PLUS EXTENSION 788-1234	SIGNATURE
--	--	-----------

RECOMMENDED CHANGES TO PUBLICATIONS AND BLANK FORMS For use of this form, see AR 25--30; the proponent agency is ODISC4.						Use PartII(reverse) for Repair Parts and Special Tool Lists (RPSTL) and Supply Catalogs/ Supply Manuals (SC/SM)	DATE
TO: (Forward to proponent of publication or form)(Include ZIP Code) Commander, U.S. Army Aviation and Missile Command ATTN: AMSAM-MMC-MA-NP Redstone Arsenal, AL 35898						FROM: (Activity and location)(Include ZIP Code)	
PART 1 --ALL PUBLICATIONS (EXCEPT RPSTL AND SC/SM) AND BLANK FORMS							
PUBLICATION/FORM NUMBER						DATE	TITLE
ITEM NO.	PAGE NO.	PARA-GRAPH	LINE NO. *	FIGURE NO.	TABLE NO.	RECOMMENDED CHANGES AND REASON	
* Reference to line numbers within the paragraph or subparagraph.							
TYPED NAME, GRADE OR TITLE						TELEPHONE EXCHANGE/ AUTOVON, PLUS EXTENSION	SIGNATURE

TO: <i>(Forward direct to addressee listed in publication)</i> Commander, U.S. Army Aviation and Missile Command ATTN: AMSAM-MMC-MA-NP Redstone Arsenal, AL 35898	FROM: <i>(Activity and location) (Include ZIP Code)</i>	DATE
---	--	-------------

PART II --REPAIR PARTS AND SPECIAL TOOL LISTS AND SUPPLY CATALOGS/SUPPLY MANUALS

PUBLICATION NUMBER			DATE		TITLE			
PAGE NO.	COLM NO.	LINE NO.	NATIONAL STOCK NUMBER	REFERENCE NO.	FIGURE NO.	ITEM NO.	TOTAL NO. OF MAJOR ITEMS SUPPORTED	RECOMMENDED ACTION

PART III --REMARKS *(Any general remarks or recommendations, or suggestions for improvement of publications and blank forms. Additional blank sheets may be used if more space is needed.)*

TYPED NAME, GRADE OR TITLE	TELEPHONE EXCHANGE/AUTOVON, PLUS EXTENSION	SIGNATURE
----------------------------	--	-----------

This fine document...

Was brought to you by me:



[Liberated Manuals -- free army and government manuals](#)

Why do I do it? I am tired of sleazy CD-ROM sellers, who take publicly available information, slap “watermarks” and other junk on it, and sell it. Those masters of search engine manipulation make sure that their sites that sell free information, come up first in search engines. They did not create it... They did not even scan it... Why should they get your money? Why are not letting you give those free manuals to your friends?

I am setting this document FREE. This document was made by the US Government and is NOT protected by Copyright. Feel free to share, republish, sell and so on.

I am not asking you for donations, fees or handouts. If you can, please provide a link to liberatedmanuals.com, so that free manuals come up first in search engines:

<A HREF=<http://www.liberatedmanuals.com/>>Free Military and Government Manuals

- Sincerely
Igor Chudov
<http://igor.chudov.com/>
- [Chicago Machinery Movers](#)