

Administrative Changes to AFPAM 10-219, Volume 4, *Airfield Damage Repair Operations*

OPR: AFCESA/CEXX

OPR should be changed to: AFCEC/CX

References to Air Force Civil Engineer Support Agency (AFCESA) should be changed to Air Force Civil Engineer Center (AFCEC) throughout publication.

References to AFH 10-222V16, *Guide for Use of the Minimum Airfield Operating Surface Marking System*, should be deleted; publication will be rescinded simultaneously with this AC.

17 December 2012



**AIRFIELD DAMAGE REPAIR OPERATIONS**

---

**ACCESSIBILITY:** Publications and forms are available on the e-Publishing website at [www.e-publishing.af.mil](http://www.e-publishing.af.mil) for downloading or ordering.

**RELEASABILITY:** There are no releasability restrictions on this publication.

---

OPR: HQ AFCESA/CEXX

Certified by: HQ USAF/A7CX  
(Col Donald L. Gleason)

Supersedes AFPAM10-219V4, 1 April 1997

Pages: 177

---

This pamphlet series supports Air Force Instruction (AFI) 10-210, Prime Base Engineer Emergency Force Program and AFI 10-211, Civil Engineer Contingency Response Planning. This volume of this pamphlet series provides guidance and procedures for repairing war-damaged airfield operating surfaces. It applies to Air Force Civil Engineer Prime Base Engineer Emergency Force (BEEF) members and Rapid Engineer Deployable Heavy Operational Repair Squadron Engineer (RED HORSE) who perform airfield damage repair (ADR) operations, including Air National Guard (ANG) units and Air Force Reserve Command (AFRC). In addition to information on ADR techniques, it also addresses damage assessment, minimum operating strip (MOS) selection, repair quality criteria (RQC) and airfield marking. Ensure that all records created as a result of processes prescribed in this publication are maintained in accordance with Air Force Manual (AFMAN) 33-363, Management of Records, and disposed of in accordance with the Air Force Records Information Management System (AFRIMS) Records Disposition Schedule (RDS) located at [https://afrims.amc.af.mil/rds\\_series.cfm](https://afrims.amc.af.mil/rds_series.cfm). The use of the name or mark of any specific manufacturer, commercial product, commodity, or service in this publication does not imply endorsement by the Air Force.

**SUMMARY OF CHANGES**

This publication has been substantially revised and must be completely reviewed. This revision changes the publication title from Rapid Runway Repair Operations to Airfield Damage Repair Operations to be consistent with Unified Facilities Criteria (UFC) 3-270-07, Airfield Damage Repair. Command and control functional designators were updated throughout the publication to reflect the new Air Force Incident Management System construct. Detailed procedures were eliminated if included in official directive publications elsewhere, such as T.O.s, UFCs, AFIs, etc. The concept of operations was updated to reflect the force module construct.

**Chapter 1— INTRODUCTION**

**9**

1.1. Overview.....

**9**

1.2. Background ..... 9

Figure 1.1. Airmen Laying Out Folding Fiberglass Matting. .... 10

1.3. Future Planned Improvements. .... 10

1.4. Today’s Concept of Operations. .... 10

Figure 1.2. AF Force Module Deployment Construct. .... 13

1.5. Scope of Publication. .... 18

1.6. SUMMARY. .... 18

**Chapter 2— TRAINING 20**

2.1. General..... 20

2.2. Limitations..... 20

2.3. ADR Training Concept..... 20

2.4. Summary..... 23

**Chapter 3— COMMAND AND CONTROL 25**

3.1. General..... 25

3.2. Overall Organization..... 25

Figure 3.1. ADR Organizational Concept. .... 25

3.3. Command and Control (C2). .... 25

Figure 3.2. ESFs Located in the EOC. .... 27

3.4. Engineer Organization..... 28

3.5. Organizational Responsibilities..... 29

Table 3.1. Suggested Progress Report Format (AM2 Mat Repair). .... 31

Table 3.2. Suggested Progress Report Format (Folded Fiberglass Mat Repair). .... 31

3.6. Communications..... 32

Table 3.3. Suggested ADR Team Radio Requirements. .... 32

3.7. Summary..... 33

**Chapter 4— SEQUENCE OF EVENTS 34**

4.1. Peacetime Planning and Actions. .... 34

4.2. Preattack Actions..... 37

4.3. Transattack Actions. .... 39

4.4. Postattack Actions..... 39

Table 4.1.	MOS Marking Team Layout Tasks. ....	42
4.5.	Maintenance of ADR Repairs.....	45
4.6.	Sustainment Crater Repair.....	46
4.7.	Summary.....	46
 <b>Chapter 5— DAMAGE ASSESSMENT PROCEDURES</b>		<b>47</b>
5.1.	Introduction.....	47
5.2.	Overview.....	47
5.3.	General Information.....	47
5.4.	Team Composition.....	47
5.5.	Equipment.....	48
5.6.	Pavement Reference Marking System.....	48
5.7.	Damage Assessment Data.....	49
Figure 5.1.	Typical Pavement Reference Marking System. ....	50
5.8.	Assessment Technique.....	50
Figure 5.2.	Types of Pavement Damage. ....	51
5.9.	Initial Reconnaissance (Phase I).....	51
5.10.	Detailed Reconnaissance (Phase II).....	52
Figure 5.3.	VDAS in Up-Armored HMMWV. ....	53
Figure 5.4.	Single Large UXO Assessment. ....	54
Figure 5.5.	UXO Field Assessment. ....	55
Figure 5.6.	Multiple UXO/Damage Assessment. ....	56
5.11.	Priorities.....	57
5.12.	Locating Damage.....	57
5.13.	Recording and Reporting Damage.....	58
Figure 5.7.	Recording/Reporting Procedure. ....	58
Figure 5.8.	Data Report and Plot of Damage. ....	59
5.14.	Double Point Damage Plotting Steps.....	60
Figure 5.9.	Double Point Damage Plotting. ....	60
5.15.	Chapter Summary. ....	61
 <b>Chapter 6— MINIMUM OPERATING STRIP (MOS) SELECTION PROCEDURES</b>		<b>62</b>
6.1.	Introduction.....	62

6.2.	Overview.....	62
6.3.	Concept of Operations.....	63
6.4.	Team Composition.....	64
6.5.	MOS Characteristics.....	64
Table 6.1.	EOC Team Organization.....	65
Table 6.2.	MOS LOR Capability.....	66
Figure 6.1.	Requirements for Use of Existing AAS.....	68
6.6.	MOS Selection Kit.....	69
6.7.	MOS Selection Phases.....	70
Table 6.3.	Minimally Accepted Repaired Taxiway Width Criteria.....	72
Figure 6.2.	Example of Damage Plots.....	73
Table 6.4.	MOS Selection Checklist.....	75
Table 6.5.	Estimated Crater Repair Times For a Dual Crater Repair.....	78
Figure 6.3.	MOS Identification Coordinates.....	80
6.8.	Review of MOS Selection Steps.....	80
6.9.	Situation Example.....	81
Figure 6.4.	Airbase Layout.....	82
Figure 6.5.	Runway Damage Listing and Damage Plot.....	83
Figure 6.6.	Candidate MOSs.....	84
6.10.	Chapter Summary.....	85
<b>Chapter 7—REPAIR QUALITY CRITERIA (RQC)</b>		<b>87</b>
7.1.	Introduction.....	87
7.2.	Overview.....	87
7.3.	Purpose.....	87
7.4.	Concept of Operations.....	88
7.5.	Activities Sequencing.....	88
Figure 7.1.	MOS Selection—ADR/RQC Interface.....	89
7.6.	RQC Procedures.....	90
7.7.	Terminology.....	90
Figure 7.2.	Apparent Crater Diameter.....	91
Figure 7.3.	Repair Terminology.....	2 9

Figure 7.4. MOS Terminology. ....	92
7.8. RQC Chart Description.....	93
Figure 7.5. Example RQC Chart. ....	93
Figure 7.6. Density Ratio Chart. ....	95
7.9. Worksheets.....	96
7.10. Example .....	96
Figure 7.7. MOS Candidate. ....	96
Figure 7.8. Expanded Picture of MOS. ....	97
Figure 7.9. ICC Data Entered in Worksheet 1. ....	98
Figure 7.10. Density Ratio Determination. ....	99
Table 7.1. RQC Chart Summary. ....	100
Figure 7.11. Worksheet 1, Chart Number Entered. ....	101
Figure 7.12. Operational Lengths Identified on F-16B Takeoff Chart. ....	102
Figure 7.13. Operational Lengths Identified on F-16B Landing Chart. ....	103
Figure 7.14. Operational Lengths Identified on F-16B Landing-Arrestment Chart. ....	104
Figure 7.15. Worksheet 1 Complete. ....	104
Figure 7.16. South to North Flying Operations (360 degree heading). ....	105
Figure 7.17. Worksheet 2—South to North Landing/Takeoff Data (360 degree heading). ....	106
Figure 7.18. Arresting System Location Identified. ....	107
Figure 7.19. North to South Flying Operation (180 Degree Heading). ....	108
Figure 7.20. Worksheet 2—North to South Landing/Takeoff Data (180 degree heading). ....	108
Figure 7.21. Patch Repair Locations, Spacings, Lengths and DR Markings. ....	109
Figure 7.22. Operation 1 RQC Values (Worksheet 2). ....	110
Figure 7.23. Patch Lengths, Locations, and Spacings Marked on D2 Chart. ....	110
Figure 7.24. Operation 2 RQC Values Added to Worksheet 2. ....	111
Figure 7.25. RQC Takeoff Determinations. ....	112
Figure 7.26. RQC Landing Determinations. ....	112
Figure 7.27. RQC Entries on Worksheet 2. ....	113
Figure 7.28. RQC Summary (Worksheet 3). ....	114
Figure 7.29. Summary RQC Data. ....	114

7.11.	Final Considerations. ....	115
7.12.	Chapter Summary. ....	115
<b>Chapter 8—</b>	<b>RESOURCE REQUIREMENTS</b>	<b>117</b>
8.1.	Overview.....	117
8.2.	Heavy Equipment Requirements for Recovery After Attack. ....	117
Table 8.1.	R-1 Vehicle and Equipment Set. ....	118
Table 8.2.	R-2 Vehicle and Equipment Set Additives. ....	119
Table 8.3.	R-3 Vehicle and Equipment Set Additives. ....	119
8.3.	Personnel Requirements. ....	119
Table 8.4.	R-3 Personnel Requirements. ....	120
Figure 8.1.	Typical R-1/2 Set Organization Using FFM for both MOS & Taxiway. ....	121
Table 8.5.	Personnel Requirements (Not Cumulative). ....	122
Table 8.6.	Vehicle Assignments (Not Cumulative). ....	123
<b>Chapter 9—</b>	<b>SPALL REPAIR</b>	<b>125</b>
9.1.	Overview.....	125
Figure 9.1.	Spall Damage. ....	125
9.2.	Purpose and Objective of Spall Repairs. ....	126
9.3.	Areas of Concern. ....	126
9.4.	Personnel Requirements. ....	126
9.5.	Equipment Requirements.....	126
9.6.	Spall Repair Procedures.....	126
<b>Chapter 10—</b>	<b>CRATER REPAIR</b>	<b>127</b>
10.1.	Overview.....	127
Figure 10.1.	Large and Small Craters ....	127
10.2.	Expedient Repair.....	127
10.3.	Mobilization After Attack.....	127
Figure 10.2.	Raised Pavement Marker System Post. ....	129
10.4.	Determining Repair Method and Clearing Crater Site. ....	130
10.5.	Initial Upheaval Determination. ....	130
Figure 10.3.	Upheaval Around Crater. ....	131

10.6.	Removing Upheaval, Excavating and Filling Crater. ....	131
10.7.	Intermediate Crater Profile Check. ....	131
10.8.	Crater Edge Cleaning, Leveling Fill Material, and Overfilling Crater. ....	131
10.9.	Rough Leveling and Initially Compacting the Filled Crater. ....	132
10.10.	Final Grade and Compaction. ....	132
10.11.	Dual-Crater Repair. ....	132
10.12.	FOD Covers. ....	132
Figure 10.4.	AM-2 Mat Repair Method. ....	133
Figure 10.5.	FFM Repair Method. ....	133
10.13.	Sweeping the Crater Area. ....	134
10.14.	Repair Activity Sequencing. ....	134
Table 10.1.	Dual Crater Folded Fiberglass Mat Repair Timeline. ....	135
10.15.	Debris Clearance. ....	136
10.16.	Clearing and Sweeping Recommendations. ....	136
10.17.	Equipment Repair and Recovery Planning. ....	137
10.18.	Equipment Substitution. ....	137
Table 10.2.	Equipment Hierarchy. ....	138
<b>Chapter 11—</b>	<b>AUXILIARY SYSTEMS</b>	<b>139</b>
11.1.	Introduction. ....	139
11.2.	Overview. ....	139
11.3.	Airfield Marking Procedures. ....	139
11.4.	Mobile Aircraft Arresting System (MAAS). ....	140
11.5.	Installing Airfield Lighting. ....	142
11.6.	Summary. ....	143
<b>Chapter 12—</b>	<b>INFORMATION COLLECTION, RECORDS, AND FORMS</b>	<b>144</b>
12.1.	Information Collections. ....	144
12.2.	Records. ....	144
12.3.	Forms (Adopted and Prescribed). ....	144
<b>Attachment 1—</b>	<b>GLOSSARY OF REFERENCES AND SUPPORTING INFORMATION</b>	<b>145</b>
<b>Attachment 2—</b>	<b>SEQUENTIAL ADR FUNCTIONS</b>	<b>160</b>



<b>Attachment 3— CRATER-CREW CHECKLIST</b>	<b>164</b>
<b>Attachment 4— SPALL REPAIR TEAM CHECKLIST</b>	<b>167</b>
<b>Attachment 5— AM-2 ASSEMBLY CHECKLIST</b>	<b>169</b>
<b>Attachment 6— FFM ASSEMBLY CHECKLIST</b>	<b>172</b>
<b>Attachment 7— FFM INSPECTION AND MAINTENANCE CHECKLIST</b>	<b>174</b>

## Chapter 1

### INTRODUCTION

**1.1. Overview.** Air Forces fly and fight from airbases; however, it is at the airbase that air power is most vulnerable. Airbases can be the most immediate and lucrative targets for an adversary, because it is far more effective to destroy aircraft while they are on the ground than to hunt them in the air. Destroy the infrastructure that supports the aircraft, and you essentially destroy air operations. Not only must the United States maintain the capability to recover our own airbase after an enemy attack, but must also be capable of restoring an enemy airfield after US seizure. In either scenario proper preparation must be accomplished prior to the moment of need—time will not be available during the conflict to accomplish meaningful training.

**1.2. Background.** American military leaders of World War II recognized the vital need for airfields to support operations in all theaters of operation. Many times this meant repairing enemy airfields or constructing new ones as quickly and close to the front as possible. To provide this level of support, aviation engineers experimented with several different types of runway materials. Some never proved feasible. For example, the attempt to construct a runway with wooden 2" x 4" landing mats was too costly and labor intensive. However, the engineers did develop several types of materials enabling them to provide expedient runways in just days or even hours. The three primary repair materials included Pierced Steel Planking, Hessian Matting, and Square Mesh Track. These evolved into the AM-2 matting used extensively in the Vietnam conflict and still in limited use today (see Volume 1, Attachment 4, of this series for more information on the history of airfield damage repair [ADR] materials).

1.2.1. As the USAF developed higher performance aircraft, near-flush repairs on the primary take-off/landing surface became imperative to eliminate the rough “bump” AM-2 mat presented. To address this late 1970s issue, HQ Air Force Engineer and Services Center (AFESC), now HQ Air Force Civil Engineer Support Agency (AFCESA), developed a synthetic matting system that would provide portability without the transitional roughness problems associated with AM-2 matting. Initial versions of their efforts were fielded in August 1984 and called Polyurethane Fiberglass Mats (PFM). Unfortunately, these early PFM products were not well received, mainly because of storage and transport problems presented by their sheer bulk. They were 50 x 60 feet in size, not foldable, and weighed approximately 1,500 pounds.

1.2.2. However, work continued on the project and by February 1992, AFCESA developed the folded fiberglass mat (FFM) system that is the primary ADR method now employed Air Force-wide (**Figure 1.1**). The FFM system was basically the PFM with hinges that allows the mat to fold into a manageable size for transport and storage. The system does have its weak points: the elastomer hinges are susceptible to damage with heavy fighter and cargo aircraft usage and the corners of the mat's trailing edge failed earlier than anticipated during C-17 high speed taxiing or braking situations.

**Figure 1.1. Airmen Laying Out Folding Fiberglass Matting.**



**1.3. Future Planned Improvements.** We must continue to improve tactics, techniques, and procedures (TTP) if we expect to remain the preeminent Air Force in the world, this holds true for ADR tools and methods. At publishing time for this pamphlet, several ADR modernization projects were underway.

1.3.1. In the long-term, the Air Force desires to replace foreign object damage (FOD) covers, such as AM-2 and FFM, with more permanent cap repairs, such as quick setting concrete and grout mixtures, that support all our airframes. This would provide true flush repairs, minimize rutting issues, and eliminate anchoring problems. Materials are currently being investigated and tested to achieve this goal, and short-term projects to improve current FOD covers are currently underway. The overall goal is to provide quick repair TTPs that require less maintenance and are applicable for any scenario or location.

1.3.2. A project is underway to develop a rapid ramp expansion product that is lighter, stronger, and requires less maintenance than AM-2.

1.3.3. Use of alternative crater fill material, such as expanding foam, is being tested to determine durability, time required for application, and ease of use.

1.3.4. Studies are in process to improve spall repair materials, techniques, and guidance.

1.3.5. Air Force civil engineers intend to exploit the full spectrum of technologies to improve all facets of ADR; from efforts to decrease damage assessment by using unmanned aerial vehicles and prepositioned, remotely controlled, digital cameras to exploring software to perform automated minimum operating strip (MOS) selection accurately and efficiently. These are but two ideas that can revolutionize the way ADR operations are conducted in the future.

#### **1.4. Today's Concept of Operations.**

##### **1.4.1. Introduction.**

1.4.1.1. ADR Definition. ADR encompasses all actions required to rapidly prepare airfield operating surfaces and infrastructure to establish or sustain operations at a new forward operating loca-

tion (FOL) or to recover operations at a main operating base (MOB) or FOL that has sustained damage from an attack.

1.4.1.2. Concept of Operations (CONOPS) Overview. Airfield damage repair is an essential element in the rapid projection and application of Joint US Military power to ensure the United States can establish airbase operations anywhere on the globe in minimum time. This CONOPS addresses Prime Base Engineer Emergency Force (BEEF) and Rapid Engineer Deployable Heavy Operational Repair Squadron Engineer (RED HORSE) ADR capabilities to support the installation's flying mission. ADR capability includes tasks such as damage assessment, explosive ordnance reconnaissance, MOS selection, repair quality criteria (RQC) determination, airfield surface repair, minimum airfield operating surface (MAOS) marking and striping, aircraft arresting system installation, and airfield lighting system repair and installation.

#### 1.4.2. Changing Requirement.

1.4.2.1. Transformed Strategies. The Global Mobility (GM) Operational CONOPS, within the construct of the AF Agile Combat Support (ACS) CONOPS, has transformed. In addition to maintaining capabilities to repair damaged airfields resulting from enemy attack at established MOBs as in the past, expeditionary engineers now face the daunting tasks of opening and restoring airfield operations within friendly host nation airbases in a permissive environment or after seizing an enemy airbase in a non-permissive environment. In the latter scenario, the airfield will have most likely suffered heavy damage from US and ally airfield denial operations or denial efforts by departing enemy forces. In this scenario, lines of communication are longer and material acquisition more difficult. Expeditionary engineers must also be able to restore deteriorating airfields while operating the airbase at a high ops tempo on substandard and/or aged pavements. Similar to the need to act quickly to restore operations following an attack, this requirement drives carefully scheduled rapid repairs in order to minimize or eliminate impact to the flying schedule.

1.4.2.2. Need for Consistency in ADR Operations. The global war on terrorism has compelled the United States to project airpower into places where we must seize and open airbases in non-permissive territories, often in a joint service environment. Standard tactics, techniques, and procedures must be established to deal with this transformed strategy. Recent operations identified the lack of familiarity and consistency in ADR procedures, equipment, material, and unified pavement specifications when opening an airbase. Developing unified ADR guidance is the first step in overcoming these inconsistencies.

1.4.3. Objective. Provide the installation commanders and the combatant commander with improved capability to restore operations at an existing air base or establish flying operations after opening an expeditionary airbase to ensure the rapid, timely, and effective deployment, employment, sustainment, and redeployment of US airpower in support of America's global interests. It also refines the existing ADR TTPs to provide the installation commander with capabilities to sustain and restore flying operations rapidly after enemy attack on an existing MOB or COB. It should also be used to guide AF civil engineer (CE) units in equipping, training, and employing forces to ensure they are prepared to provide ACS towards GM in the form of ADR planning, design, evaluation, repair, construction, maintenance, and training to support aircraft sortie generation.

1.4.4. Desired Effects. Airfield damage repair CONOPS will define capabilities required to achieve the desired primary effect of rapid projection and application of Joint US Military airpower anywhere on the globe in minimum time.

1.4.4.1. Airpower Projection through Expeditionary Air Base s. Provide assured ability to mesh seamlessly with other forces (Army, Navy, USMC, and SOF) to establish air operations from a full spectrum of airfields. Achieve seamless transition between airfield seizure, airbase opening, sustainment, and recovery in concert with theater-assigned mobility forces, to include rapid, efficient redeployment of forces.

1.4.4.2. Airpower Projection through MOB/COBs. Assured ability to recover damaged airfield surfaces and associated systems rapidly to continue air operations after an enemy attack.

1.4.5. Capabilities. Airfield damage repair capabilities cover a wide range of functional actions to establish, sustain, and recover airbase operations.

1.4.5.1. In a scenario where an enemy airbase has been seized, ADR assets and capability may be limited until minimum airfield repairs are completed to enable cargo aircraft to bring in additional resources. Special capability units, such as airborne RED HORSE and contingency response groups (CRG), will likely accomplish airfield repairs when opening the airbase. Afterwards, operations will be handed off to follow-on Prime BEEF (PB) units to continue airfield repairs. After establishing an airbase and beginning sustainment of operations, the potential enemy threat must be assessed and resources acquired in anticipation to counter those potential threats.

1.4.5.2. In a recovery scenario (MOB, COB, or FOL), availability of assets and capability may be impacted by the attrition of materials, equipment, and personnel due to bomb/missile damage, or the necessity to operate in a chemical environment.

1.4.5.3. The following specific capabilities are provided by PB forces:

1.4.5.3.1. Assessing airfield damage to determine required repairs.

1.4.5.3.2. Locating, identifying, marking, clearing, and safing unexploded explosive ordnance (UXO).

1.4.5.3.3. Selecting an appropriate MOS to minimize repair time required to continue launch and recovery of aircraft.

1.4.5.3.4. Determining the RQC of the required airfield repairs.

1.4.5.3.5. Performing expedient and sustainment repairs to craters and spalls on runways, taxiways, and aprons/ramps. Installing FOD covers (FFM, spall patches, etc.) as appropriate to the area of the airfield (runway, taxiway, ramp) and airframe (fighter, cargo, etc.) using the airfield.

1.4.5.3.6. Expanding parking aprons and ramps using AM-2 or other means.

1.4.5.3.7. Marking and striping MAOS.

1.4.5.3.8. Repairing existing aircraft arresting systems and installing mobile aircraft arresting systems (MAAS).

1.4.5.3.9. Repairing existing airfield lighting systems and installing emergency airfield lighting systems (EALS).

1.4.5.3.10. Repairing hydrant fueling systems.

1.4.6. Enabling Capabilities.

1.4.6.1. ACS CONOPS Capabilities.

1.4.6.2. GM CONOPS Capabilities.

1.4.6.3. Training capabilities are necessary to develop the degree of proficiency and expertise demanded in damage assessment, UXO reconnaissance, MOS selection, RQC determination, damage repair, airfield marking and striping, and installation of aircraft arresting systems and airfield lighting systems.

1.4.7. Force Module ADR Capabilities. Airfield damage repair activities take place throughout the expeditionary airbase life cycle. The following paragraphs will describe activities performed along the timeline of each force module ( **Figure 1.2.**). However, before deploying force modules, pre-action assessment and planning will be accomplished.

1.4.7.1. Pre-action Assessment and Planning. Conduct as much of the assessment actions as possible prior to deployment. Throughout the pre-action assessment, civil engineers must consider and gather data necessary to ensure their ability to initiate, sustain, and restore flying operations. This phase begins with deliberate planning, through crisis action planning until the first element of the airbase opening force sets foot on the base. Important to the pre-action assessment is the Expeditionary Site Survey Process (ESSP). Intended to provide ground truth, this process includes airfield and runway surveys, and overall assessment of facilities; explosive storage siting; petroleum, oil, and lubricants (POL); terminal control; environmental issues (including, but not limited to) potable water and potential public health hazards. Ultimately, this process develops a site map. For more information on ESSP, see the ESSP CONOPS on the Air Force CONOPS community of practice website at

<https://wwwd.my.af.mil/afknprod/ASPs/CoP/EntryCoP.asp?Filter=OO-OP-AF-25>.

**Figure 1.2. AF Force Module Deployment Construct.**

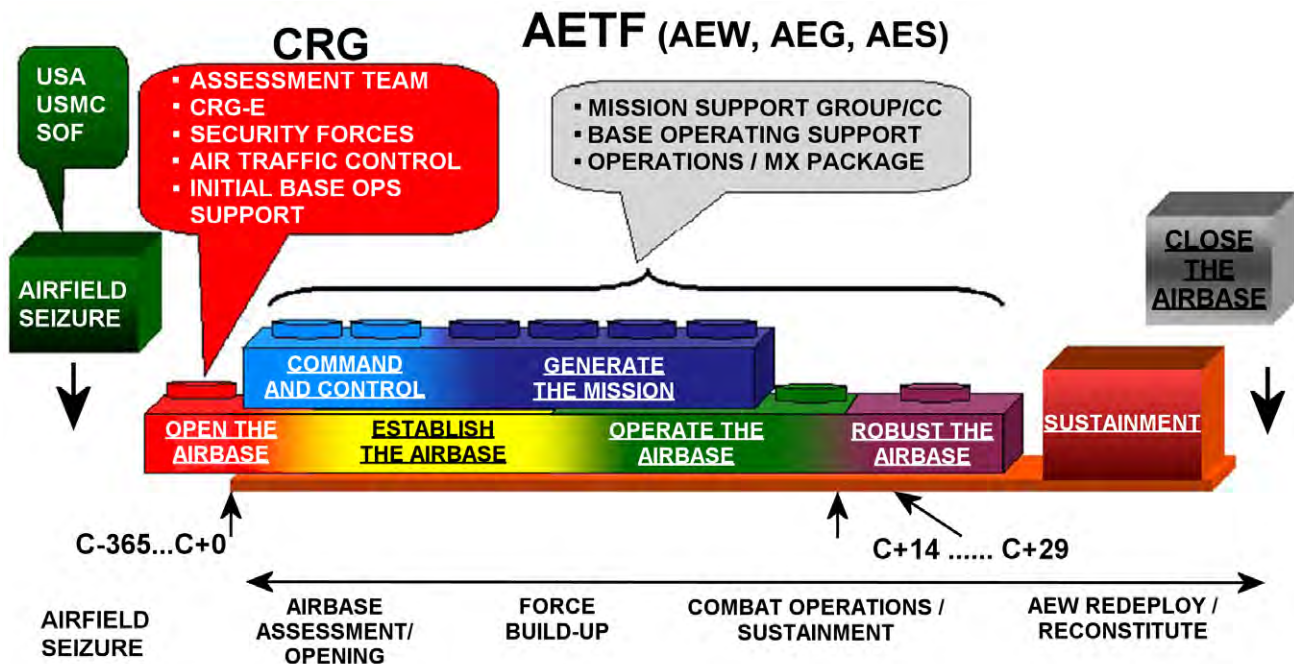

1.4.7.1.1. The Joint Staff Intelligence Directorate (J-2) provides geospatial information compiled by the National Geospatial-Intelligence Agency (NGA). In addition, the topographic



engineers within the Army component provide special topographic engineer-derived products assessing terrain support for mobility and countermobility operations.

1.4.7.1.1.1. Geology. Civil engineers require knowledge of the surface and subsurface strata for foundation designs (where required) and selection of anchoring systems.

1.4.7.1.1.2. Infrastructure. Essential CE information on infrastructure (e.g., facilities, airfield data, utilities systems, and transportation structures) includes host nation design, construction, and maintenance practices as well as overall condition assessment (particularly of roads, bridges, ports, and airfields).

1.4.7.1.1.3. Resources. Acquire information on the availability of construction resources (locally available contractors, skilled labor, construction equipment, and construction materials) in the host nation and Region. Class IV construction materials may be acquired anywhere in the world; however, not all construction material is of adequate quality and quantity to meet mission needs. Use of local materials often provide repairs that meet mission needs while reducing costs and demands on logistic support systems.

1.4.7.1.2. Many of these priority intelligence requirements can be satisfied by information available in national-level Department of Defense (DOD) intelligence databases.

1.4.7.1.3. Other sources of information are:

1.4.7.1.3.1. Historical database – Geographical database to serve as a historical repository of broad range of data collected on bases and other key locations.

1.4.7.1.3.2. Remote sensor using intelligence, surveillance, and reconnaissance (ISR) – A great deal of data can be collected via sensor. Greater advance knowledge of the location will reduce workload of the assessment team (command, control, communications, and computer systems C4ISR Capability).

1.4.7.1.3.3. Tri-Service Transportation Website. Army CoE Engineering Research and Development Center website that provides information on pavements research, criteria, software, and other useful information and links at <https://transportation.wes.army.mil/triservice/>.

1.4.7.1.3.4. AFCESA Pavements Program. The AFCESA Pavements Program focuses on airfield support to the Major Commands (MAJCOM) and bases by providing services for both peacetime and contingency operations. AFCESA pavement evaluation reports can be accessed at the following website:

[https://www.mil.afcesa.af.mil/Directorate/CES/Civil/Pavements/pav\\_app/Pav\\_main.asp](https://www.mil.afcesa.af.mil/Directorate/CES/Civil/Pavements/pav_app/Pav_main.asp).

1.4.7.1.3.5. AMC Site Suitability Reports. Airport searches can be conducted at this Website (<https://www.afd.scott.af.mil/>) to determine the suitability for AMC aircraft use.

1.4.7.2. “Open the Airbase” Force Module. An airborne RED HORSE (ARH) flight may be inserted with the tail end of the airfield seizure force to conduct rapid airfield assessment and basic preparations for follow-on forces if the airbase is inaccessible by ground movement. Otherwise, CE forces belonging to an advanced assessment team of the CRG typically perform initial assessments at the beginning of the “open the airbase” force module. However, not all USAF initial-airbase opening capabilities are embedded within the CRGs and if rapid response is not critical,

UTCs from various units within the Air Force will be tasked to collectively constitute the open the airbase force module – initial airbase opening capability. The “open the airbase” force module is defined in three phases.

1.4.7.2.1. Phase I – Open the Runway. Following airfield seizure operations, (usually accomplished by USA, USMC or SOF), and the subsequent transition to airbase opening operations, Phase I is achieved when the first mobility aircraft is authorized to land. By the end of this stage, adequate runway, ramp and taxiways for the intended mission are cleared and monitored. Additionally, the airfield is secure, and the runway, taxiway, and ramp space are capable of supporting airlift operations. Engineer capabilities related to ADR in this phase include:

1.4.7.2.1.1. Expedient force protection construction to protect ADR forces.

1.4.7.2.1.2. Initial site survey assessment to verify airfield operations information and evaluate/obtain any details that were not pre-assessed. This capability includes visual inspection and evaluation of existing airfield pavements and infrastructure to determine aircraft utilization capability and initial repair requirements to allow limited cargo/transport aircraft operations. Specialized airfield pavement evaluation teams can perform in depth testing with more robust equipment packages when sustained operations at a location are planned.

1.4.7.2.1.3. Limited UXO and explosive hazard clearance to allow insertion of personnel and equipment for limited ADR.

1.4.7.2.1.4. Limited chemical, biological, radiological, nuclear and high yield explosives (CBRNE) and toxic industrial material hazard assessment to inform planners of potential airfield hazards.

1.4.7.2.1.5. Clearance of obstructions preventing safe airfield operations. This capability also includes explosive demolition.

1.4.7.2.1.6. Expedient repair of airfield surfaces to allow limited cargo/transport aircraft passes. These temporary repairs require constant inspection and maintenance until sustainment repairs are completed.

1.4.7.2.2. Phase II – Aircraft Reception. Phase II is achieved once initial-airbase opening forces and their equipment are prepared to receive aircraft; sufficient ramps, taxiways, and facilities are available to support the intended mission. ARH, follow-on CRG forces, and/or PB forces work towards accomplishing this phase of opening an airbase. Capabilities related to ADR in this phase include:

1.4.7.2.2.1. Laying out minimum airfield operating surface marking system (MAOSMS), obliterating obsolete runway/taxiway stripes, and striping MOS and temporary taxiways.

1.4.7.2.2.2. Assessing operability and, when possible, repairing existing airfield lighting and aircraft arresting systems.

1.4.7.2.2.3. Installing temporary expedient airfield lights, such as those used by Air Force Special Operations Command's Special Tactics Teams (STT), or installing EALS and/or MAAS when available. NOTE: The EALS and MAAS arrive via airlift after initial airfield operations begin.



1.4.7.2.3. Phase III – Initial Beddown. Phase III is achieved when sufficient real estate has been obtained to allow for the initial beddown and sustainment of combat and combat support forces. Phase III is complete once like forces are in place to extend, then replace the initial-airbase opening force capability. ARH, follow-on CRG forces, and or PB forces continue to work towards accomplishing this final phase of opening the airbase concurrently with continuing ADR tasks such as debris removal, backfilling craters, and spall repair. Additional capabilities are mainly related to beddown tasks including:

1.4.7.2.3.1. Expanding on initial site survey assessments to provide beddown planners critical airbase information. This capability includes visual inspection and evaluation of potential beddown sites.

1.4.7.2.3.2. Limited clearing of UXO and explosive hazards to allow erection of beddown structures.

1.4.7.2.3.3. Limited assessment CBRNE to inform planners of potential on-site threats.

1.4.7.2.3.4. Clearing obstructions to make real estate available for beddown structures. This capability also includes explosive demolition.

1.4.7.2.3.5. Expedient construction of fighting positions and other force protection structures to secure living and working conditions.

1.4.7.3. “Command and Control” (C2) Force Module. The C2 force module provides the permanent C2 capability of assigned forces, including ACS forces, through the establishment of the Air and Space Expeditionary Wing or Group Structure. Engineer representatives are assigned to the Emergency Operations Center (EOC) to provide engineering expertise and to reduce redundancy and confusion. The EOC implements decisions, made by the Installation Control Center (ICC), and directs all base recovery forces. The CE Damage Control Center (DCC), or sometimes referred to as the Unit Control Center, is manned by civil engineers and normally controls all CE ADR activities as directed by the EOC.

1.4.7.4. “Establish the Base” Force Module. This force module is complete when ADR and forces are sufficient to support the arrival of the first mission aircraft. PB forces through the normal Air and Space Expeditionary Force (AEF) tasking construct normally replace ARH and CRG forces. Engineer ADR actions include tasks such as:

1.4.7.4.1. Minimizing risk from UXO.

1.4.7.4.2. Adding explosive ordnance disposal (EOD), CBRNE, and conventional threat response capabilities.

1.4.7.4.3. Adding 24/7 fire protection.

1.4.7.4.4. Installing EALS and providing lighting for the airfield to establish 24-hour flight-line operations.

1.4.7.4.5. Enhancing airfield operations by conducting additional airfield operating surface repairs to increase size of the MAOS to support mission aircraft.

1.4.7.4.6. Expanding ramps to support all expected aircraft operations at the airbase.

1.4.7.4.7. Repairing and/or installing aircraft arresting systems to enhance flying safety.

1.4.7.4.8. Assisting communications personnel in repairing/installing navigational aids.

1.4.7.5. “Generate the Mission” Force Module. The airfield is considered operational when airfield repairs and forces are sufficient to fly operational missions. CE provides PB forces to:

1.4.7.5.1. Support and maintain infrastructure; including vertical structures, real property, power, water, and a robust C2 capability.

1.4.7.5.2. Respond to CBRNE threats to include the capability to support all flightline operations including ADR and crash and recovery capability if needed.

1.4.7.5.3. Upgrade expedient airfield repairs with sustainment repairs. Initiate sustainment repairs as soon as the operational tempo permits, considering that expedient repairs are only designed to support 100 aircraft sorties.

1.4.7.6. Operate the Airbase and Robust the Airbase Force Modules. These force modules continue to enhance the airbase by expanding the infrastructure. They contain mission support forces needed to achieve full operating capability and to make the initial operating capabilities of the airbase mature and robust. CE PB forces typically perform the following ADR tasks during these force modules:

1.4.7.6.1. Continue to upgrade expedient repairs with sustainment repairs.

1.4.7.6.2. Conduct further airfield repairs to increase capabilities and enhance flying safety.

1.4.7.7. Airbase Sustainment. While not considered a force module, airbase sustainment is still an important part of the expeditionary airbase life cycle. Airbase sustainment is maintaining effective capacities of mission support for the duration of operations worldwide through the maximum use of reachback to strategic and operational levels of support; and distributing in those instances where executive agent’s role falls to the Air Force. This phase of operation is much like day-to-day sustained operations at a MOB. Specific sustainment tasks in relation to ADR are based on the expected duration and general nature of the operation and other factors, but may include:

1.4.7.7.1. Performing or maintaining sustainment airfield repairs.

1.4.7.7.2. Returning the runway to full operability to the fullest extent possible.

1.4.7.7.3. Increasing ramp space.

1.4.7.7.4. Installing semi-permanent or permanent arresting systems.

1.4.7.7.5. Installing permanent airfield lighting systems.

1.4.7.7.6. Acquiring the skills, equipment, and material necessary to provide a lean and responsive depot structure that provides an organic repair capability for all airfield maintenance responsibilities.

1.4.7.7.7. Performing day-to-day operations and maintenance the same as if at a MOB.

1.4.7.7.8. Assessing the enemy’s potential to attack and damage the airfield and the airbase’s vulnerabilities.

1.4.7.7.9. Perform necessary preattack actions as determined by assessing the enemy’s potential attack threat. Preattack actions include tasks such as active and passive defensive measures and stockpiling assets to repair damage from potential attacks if necessary.

1.4.7.8. Airbase Recovery. Forces must be prepared to recover the airbase after a conventional attack with the resumption of flying operations as first priority. Other recovery activities may be conducted concurrently; however, these activities must not impede the resumption of flying operations. Base recovery actions should be identical whether at a MOB or bare base. The basic airbase recovery tasks include:

- 1.4.7.8.1. Damage assessment.
- 1.4.7.8.2. Safing and disposing of UXO.
- 1.4.7.8.3. MOS selection.
- 1.4.7.8.4. RQC determination.
- 1.4.7.8.5. Repairing airfield damage and installation of FOD cover as necessary.
- 1.4.7.8.6. Airfield marking and striping.
- 1.4.7.8.7. MAAS installation.
- 1.4.7.8.8. EALS installation.

**1.5. Scope of Publication.** This publication mainly focuses on the airbase recovery aspect of ADR, although many of the TTPs apply in any ADR scenario. It is a complex and difficult tasking that requires the total commitment of all involved to succeed.

1.5.1. The procedures presented in this volume follow what may be expected as the most common order of accomplishment. In addition, a number of attachments have also been included that serve to amplify some of the more intricate functions presented in a number of chapters. Detailed airfield pavement damage repair procedures are now covered in Unified Facilities Criteria (UFC) 3-270-07, O&M: Airfield Damage Repair, and will be referenced throughout this volume. The ADR discussed in this document is not to be confused with the permanent repairs accomplished with host nation, US Army, or contract support.

1.5.2. In addition, ADR processes are performed by AF units other than PRIME BEEF forces, such as STTs, CRGs, and RED HORSE units. Engineer personnel in these units typically perform “open the airbase” actions prior to the arrival of Prime BEEF forces who establish the airbase, operate the airbase, robust the airbase, and then sustain operations thereafter. While “open the airbase” ADR TTPs are similar to those in other force modules, this publication will mainly focus on operations after the airbase is opened.

## **1.6. SUMMARY.**

1.6.1. The capability to launch and recover aircraft rapidly, subsequent to any attack, is a critical requirement. If damage prevents or significantly degrades this response in either time or quantity, it is a severe handicap to friendly forces. The ability to rapidly determine damage and conduct repairs is essential.

1.6.2. The ADR CONOPS described in this chapter supports the ACS and GM CONOPS’ goals of force projection and sustainment. The ADR CONOPS objective is to provide the regional Combatant Commander with the necessary capabilities to enable rapid, timely, and effective projection, employment, and sustainment of US airpower in support of US global interests. The CONOPS describes the capabilities required to rapidly restore flying operations at a damaged airbase and defines the capabil-

ities necessary to open a runway , establish an airfield, sustain, and recover an airbase to conduct air combat operations.

1.6.3. In the event of future hostilities, the United States Air Force will, as in the past, play a decisive role in defeating the aggressor. The flexibility, massive firepower, and speed of employment of our air forces are capabilities needed to win a future conflict. The overwhelming success enjoyed by the Air Force from World War II through Operation IRAQI FREEDOM amply demonstrated these features. To preserve these characteristics we must maintain the relatively uninterrupted operation of our forward-based airfields through all stages of a conflict. During Operation IRAQI FREEDOM, allied forces combined numerous aircraft sorties with cruise missiles and other weapon systems to attack Iraqi forces and infrastructure; many of these targeted Iraqi airfields, including airfield pavements. There is little reason not to expect a capable enemy will attempt to do likewise to our airfields with every weapon system they have at their disposal during future conflicts.

1.6.4. Fortunately, we have not experienced a crippling air attack on one of our airbases in more than half a century ago. Because of this, we have no real world ADR data in terms of problems encountered, shortfalls experienced, or effort expended to draw from. This complicates the training situation in that training must be based on various assumptions, estimates, and subjective judgments. Computer-modeling techniques have indicated in the past that given adequate equipment and personnel, current ADR procedures can meet the stringent parameters stipulated in various requirement documents and plans. However, recent technological developments, experience in repairing seized airfields during Operations ENDURING FREEDOM and IRAQI FREEDOM, and FFM deficits require enhancements of our ADR TTPs.

1.6.5. The scope of airfield operating surface repair requirements will vary proportionally to the intensity of the attack. It could range from minor pavement disruption with minimal interference to aircraft operations to major airfield damage. It is this latter possibility that AF engineers must be prepared to handle swiftly and correctly. Engineers must be prepared for major airfield damage to include multiple bomb craters and numerous spall fields. In its most basic interpretation, the ADR mission is simply to overcome these multiple problems and provide an accessible and functional MAOS within a scant few hours. Though simplistic in outward appearance, it is a highly complex undertaking that may well require accomplishment at night, in rain or snow, or even in a chemically contaminated environment. This volume is all about repairing the airfield operating surface so that sortie generation can start as expeditiously as possible.

1.6.6. Air Force civil engineers have repaired airfield damage since World War II and many changes and improvements have come and gone. However, we cannot rest on our laurels; we must continue to strive for better and quicker ADR methods to meet the Joint Force Commander's aircraft launch and recovery needs.

## Chapter 2

### TRAINING

**2.1. General.** Mission success in all theaters of operation depends upon the level of individual and unit training. Ideally, engineer personnel should train the way they expect to fight whenever possible, and their training should be comprehensive and realistic. Conduct and document ADR training in accordance with AFI 10-210, the source document for Prime BEEF training.

2.1.1. Airfield damage repair personnel must train for wartime construction and maintenance and must learn to be innovative to deal with potential shortages of supplies, equipment, and manpower. Their training should stress flexibility and multi-skill capabilities to offset the effects of casualties and unforeseen situations (i.e., training in contingency engineering skills, as well as in their primary duty Air Force specialty). Integrated exercises should tax their physical and mental limits to build stamina, to minimize wartime trauma, and to acquaint them with the friction of war. Engineer personnel should prepare for a variety of missions in all kinds of weather and climates throughout the spectrum of warfare, from low-intensity conflict to theater conventional war, and in a chemical environment if necessary.

2.1.2. As stated in [Chapter 1](#), we have no real-world air attack ADR lessons-learned. The little data we do have comes from repairing damage to enemy airfields after we seized their airbases. We repaired damage inflicted from our own attacks, and from our coalition partners, and damage resulting from base denial operations inflicted by the retreating enemy.

2.1.3. Leadership techniques, equipment operation capabilities, and basic knowledge of ADR procedures are areas to concentrate training. Such training cannot be accomplished solely in a classroom environment—extensive hands-on activities must be performed. Teamwork, skill proficiency, individual task accuracy, and overall operational responsiveness must be the key elements of this hands-on effort. The complexity and criticality of the ADR task demand that every unit establish and maintain a viable and aggressive ADR training program. This program must include the ADR aspects of all existing training avenues; namely, home station training, officer field education, regional equipment operator training site (REOTS), and specialty training site (STS) instruction.

**2.2. Limitations.** While Prime BEEF category (CAT)-I knowledge-level ADR classroom training is conducted at home station, hands-on ADR training is not always attainable at most Continental United States (CONUS) units, and many overseas units, because they typically do not possess ADR assets or have an area where craters and spalls can be repaired. For that reason, ADR is not required in CAT-II training.

2.2.1. To overcome this training shortfall, CAT-III training, conducted at Silver Flag Exercise Sites, provides hands-on ADR training. Units are scheduled for CAT-III training to align with their AEF cycles. In addition, personnel may receive “just-in-time” hands-on ADR training at a special training site/location identified in AFI 10-210, paragraph 4.6.

2.2.2. The lack of assets and a training area is no excuse to disregard all facets of ADR training. Skills such as command and control, damage assessment, minimum operating strip (MOS) selection, and RQC determination can be trained and practiced during the home station field training exercises without ADR equipment or a dedicated ADR training area.

**2.3. ADR Training Concept.**

2.3.1. To accomplish ADR in the envisioned intense postattack environment, the base civil engineer (BCE) in a high threat location should train forces as they expect them to perform during wartime. This approach requires the unit's ADR team be able to:

2.3.1.1. Operate each item of ADR equipment at a consistent, high level of individual operator proficiency.

2.3.1.2. Execute coordinated crater repair team efforts to ensure that individual units of equipment are optimally employed in and around each crater, and that fill hauling, debris removal, and other support tasks are accomplished when needed without conflicting with other equipment operations.

2.3.1.3. Conduct simultaneous repair of multiple craters at dispersed runway and taxiway locations.

2.3.1.4. Protect the forces and equipment so they will survive the attack and be able to work in the high-threat postattack environment.

2.3.1.5. Endure the demanding physical requirements of performing ADR tasks while wearing individual protective equipment (IPE), and compensate for the degraded performance in the gear.

2.3.1.6. Integrate any arriving Prime BEEF forces into the host organization to achieve the optimum ADR organization.

2.3.2. Auxiliary Training Requirements. These skills permit each ADR team member to survive and operate in the postattack environment. These skills include physical conditioning, chemical agent awareness and contamination avoidance, IPE wear and care, small-arms proficiency, UXO identification, and self-aid and buddy care. Each team member must also learn to recognize the marking signals used in explosive and chemical hazardous areas. Provide these skills through the unit's home station training program.

2.3.3. Individual ADR Skills. These are officer and enlisted skills tailored to each individual's responsibility in the ADR organization. The objective is to train to the level of proficiency needed to meet performance requirements. For example, train excavator operators in upheaval removal, blade leveling, and aggregate compaction. Train managers of multiple tasks at all levels in both task accomplishment and task sequence requirements. Also, train all managers to perform the next higher-level task and train individual operators in job sequencing (what to do next or who to ask once the task is completed). Communications procedures; radio discipline (including "comm-out"), attrition; and performance in IPE, coupled with both day and nighttime exercises should be important instructional blocks of each training package.

2.3.4. Unit ADR Skills. These are building block, task-integration skills geared to establish proficiency of the overall ADR effort. First-level training skills include individual team efforts, such as single-crater repair, spall-group repair, MOS marking, debris clearance, and other crater support operations. Second-level training consists of combining these units into simultaneous crater and spall repair operations. Third-level training consists of on-scene crater evaluation and rapid team reorganization or tasking to cope with a large number of small craters and spalls. Reach this final level of unit skills by employing multiple teams to train in an integrated base recovery environment that includes all facets of recovery, from damage assessment through final sweeping, MAAS installation, and airfield lighting installation. Due to environmental and equipment constraints, much of this training is accomplished at MAJCOM operated STSs and Silver Flag Sites. Un its conduct first-level training where they have the capability.

2.3.5. First-level training is provided at each unit's home station. To meet these demanding requirements, make every effort to incorporate base-wide engineer training scenarios into wing-level training plans, and integrated base recovery exercises, to demonstrate the coordination and integration relationship between the engineer wartime response capabilities and the operational mission. Prime BEEF units in CONUS tasked with lead and follow team mobility docket should train at least annually using both the AM-2 minikit and FFM training kit. At high-threat overseas MOB, conduct extensive hands-on integrated exercises quarterly that involves as many aspects of the ADR concept as plausible. MAJCOM operated STSs provide second- and third-level ADR training.

2.3.6. Whenever feasible, focus training towards a combination of both hands-on and formal instruction. Attempt to include the topics below in the course of instruction at a MAJCOM operated STS.

2.3.6.1. Short-notice responses.

2.3.6.2. Site selection, and equipment/personnel dispersal.

2.3.6.3. Damage assessment, day and night (including ADAT training with the runway reference marker system).

2.3.6.4. MOS selection.

2.3.6.5. MOS layout.

2.3.6.6. Unexploded explosive ordnance safing in repair areas and UXO removal actions.

2.3.6.7. Crushed stone large crater repair.

2.3.6.8. Folded fiberglass mat positioning and anchoring.

2.3.6.9. Personnel and equipment attrition (before and during repairs).

2.3.6.10. "Comm out" procedures (before and during repair).

2.3.6.11. Radio discipline.

2.3.6.12. Repeat attack during repair and reconstitution of repair resources.

2.3.6.13. Clearance and sweeping.

2.3.6.14. RQC evaluations/calculations and crater profile measurements.

2.3.6.15. Crater maintenance procedures.

2.3.6.16. MAAS site selection and installation.

2.3.6.17. EALS installation.

2.3.6.18. Final clearance and sweeping.

2.3.6.19. MOS marking system installation.

2.3.6.20. MOS painting and blackout procedures.

2.3.6.21. Personnel protection trench selection procedures and construction techniques.

2.3.7. Realistic Training. When placed in the postattack scenario, Prime BEEF personnel can expect that nothing will happen according to plan. Chaos most likely will prevail. This environment of real damage, debris, injured people, chemical warfare-impaired personnel, UXO, little or no communications, and confusion will be far different from the pristine, single dug-crater situation in which they

train at home station. To be effective in the real postattack environment, personnel must train in full chemical warfare equipment and remain in the equipment through crew-change periods; practice in a blown, multi crater environment, integrated with all other base recovery activities; and train in attrition, communication outages, integrated nighttime exercises, and repeat attack during repair. Personnel should train in and become accustomed to their wartime organization. Such realistic training can only be provided at dedicated training sites, such as those operated by the MAJCOMs. To train, as they fight, is as necessary to the engineer repair teams and related base recovery teams as it is to the front-line tactical fighter aircrew member. A less challenging training format will result in less than adequately prepared personnel and teams.

2.3.8. Repeat Attack. A repeat attack with only a few minutes warning may occur during the recovery effort. Consequently, both training and planning actions should consider this threat.

2.3.9. During peacetime training, the BCE must be alert to all interfaces impacting ADR and must ensure that those functions and related training are standardized and thorough. An example of such an interface follows.

2.3.9.1. Peacetime EOC training should include specific and consistent ADAT procedures for damage assessment training. Develop concepts concerning how to conduct damage assessment. This concept should include, but not be limited to, the following:

2.3.9.1.1. Description of the team's function, collectively and individually.

2.3.9.1.2. Performance requirements.

2.3.9.1.3. Personnel sources and training responsibilities.

2.3.9.1.4. Team chief identification.

2.3.9.1.5. Team equipment identification.

2.3.9.1.6. Training requirements.

2.3.9.1.7. Reporting format.

2.3.9.1.8. Procedures for communication blackouts (comm-out), vehicle malfunction, attrition, and other contingencies.

2.3.9.2. Actual hands-on EOC exercises should involve use of the following functions/activities:

2.3.9.2.1. Runway reference marker system.

2.3.9.2.2. RQC system.

2.3.9.2.3. MOS selection.

2.3.9.3. Similar procedures should be developed for individuals from base organizations that will be acting as initial reconnaissance personnel immediately following an attack. Give specific attention to the scope and type of reported damages.

**2.4. Summary.** Mission success may depend upon the level of individual and unit ADR training. Ideally, engineer personnel should train the way they expect to fight whenever possible, and the training should be comprehensive and realistic. Training should stress flexibility and multi-skills to offset casualties and unforeseen situations. Training should focus on leadership techniques, equipment operation capabilities, and basic knowledge of ADR procedures. Classroom training alone cannot prepare engineers for the ADR



mission—extensive hands-on activities must be performed. Integrated exercises should tax their physical and mental limits and prepare them for a variety of missions in all kinds of weather and climates, throughout the spectrum of warfare. The complexity and criticality of the ADR task demand that every unit establish and maintain a viable and a ggressive ADR training program that includes all existing ADR training avenues; namely, home station training, officer field education, REOTS, and STS instruction.

## Chapter 3

### COMMAND AND CONTROL

**3.1. General.** Nothing has a more negative impact on a unit's capability to accomplish its mission than weak command and control. It can "rip the heart out" of an organization's motivation and esprit de corps. Simply put, without effective command and control, nothing will work. The best-trained and equipped ADR team will never reach its true potential if saddled with ineffective leadership. Command and control of an engineer team is a tough job, and it will be especially tough immediately following an attack. Good leadership can contribute greatly towards overcoming training and resource shortfalls; unfortunately, the opposite is not true. For a unit to have strong command and control, individuals within the command structure must be completely knowledgeable and competent in their position—to accept anything else is unconscionable.

**3.2. Overall Organization.** The EOC is the hub of ADR activities. From the EOC, the Mission Support Group (MSG) Commander, BCE (or designated representative), and other key support commanders or functional chiefs provide overall direction and guidance to the field forces accomplishing base recovery. In particular, the BCE passes EOC information and decisions to the CE DCC. The MOS selection team is located in the EOC and the ADR damage assessment and EOD teams report to the EOC. The overall organizational concept for ADR operations is shown in [Figure 3.1](#).

**Figure 3.1. ADR Organizational Concept.**

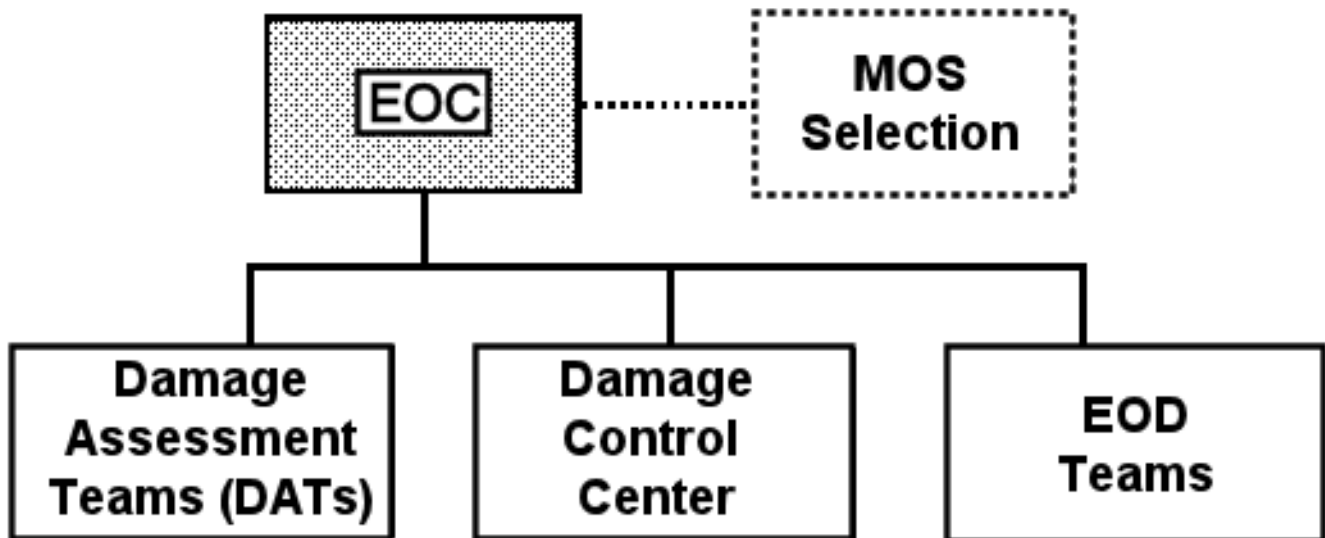

**3.3. Command and Control (C2).** All MOB assigned forces (in-place and deployed) are under the operational control of the local wing commander or equivalent. The wing commander controls assigned forces and all air base operability (ABO) operations through the ICC using the battle staff and existing radio and telephone communications. The ICC monitors status and location of personnel, resources, communications, damage, and other factors impacting mission-capability.

**3.3.1. EOC Organization.** The EOC is established, in accordance with AFI 10-2501, Air Force Emergency Management (EM) Program Planning and Operations, and AFMAN 10-2602, Nuclear, Biological, Chemical, and Conventional (NBC) Defense Operations and Standards, specifically to direct

ABO survivability and recovery operations. As addressed earlier, the EOC is the focal point for all base recovery operations. It also provides command and control of most ABO forces to ensure continuity of operations during preattack, transattack, and postattack operations.

3.3.1.1. The MSG commander, or equivalent, directs activities in the EOC and coordinates the efforts of the supporting staff to collect, analyze, prioritize, display, and report information on the status of the base. The EOC, which is subordinate to the ICC, is the focal point for determining and tracking the extent of base damage. As damage inputs are received, the EOC staff then develops a recovery strategy for ICC approval, implements and directs the recovery activity, and monitors recovery progress. As an integral part of the ICC, the EOC actively coordinates with other ICC cells (logistics, operations, reports, etc.), and reports directly to the Commander's Senior Staff. The EOC usually is collocated with, or adjacent to, the ICC battle staff work area (Battle Cab) to allow the battle staff easy viewing of EOC displays. Without a close proximity arrangement with the ICC battle staff, the EOC will find it difficult to perform its base recovery mission effectively. The EOC is responsible for determining the scope of damage; determining its impact on the base mission; and maintaining the status of personnel, casualties, and material resources. It develops a recovery strategy, directs recovery actions, and tracks progress.

3.3.1.2. An alternate EOC is established at another facility (preferably, the alternate ICC) which affords at least the same degree of protection as the primary EOC. The alternate EOC personnel track and record information plotted at the primary EOC, so it will be capable of assuming the primary EOC functions with little or no notice.

3.3.1.3. The EOC staff composition may be established to fit local base requirements, but, generally, it is organized into standardized emergency support functions (ESF) from the agencies identified in **Figure 3.2**. ESFs are groupings of capabilities that provide the support, resources, program implementation, and services that are most likely to be needed during emergency response. ESFs serve as the primary operational-level mechanism that provides support during an incident. **Table 3.1** lists the ESFs and their scope of responsibilities. See AFI 10-2501 to learn more about ESFs.

Figure 3.2. ESFs Located in the EOC.

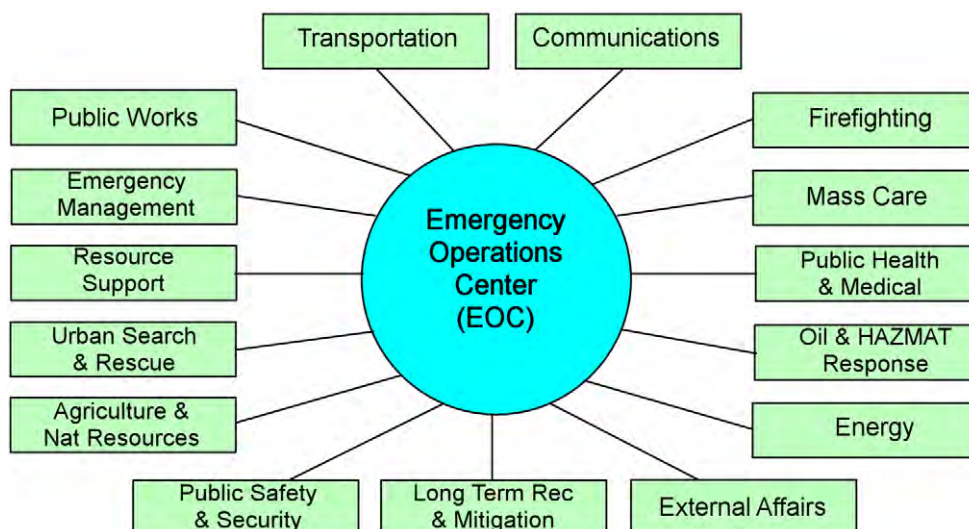

### 3.3.2. Civil Engineer EOC Duties and Responsibilities.

3.3.2.1. BCE. The BCE or designated representative is the senior advisor to the EOC commander on engineering matters. At theater bases, the base recovery concept of operations requires the BCE (or a senior designated representative) and members of the MOS selection team to be located in the EOC. From the EOC, the BCE provides direction to the ADR crews and ADATs, directs facility and utility repair, and provides fire protection and crash rescue capability. As mentioned earlier, much of the BCE's direction is executed through the DCC staff. As a member of the EOC, the BCE is the command and control link between the EOC and the DCC. From the EOC, the BCE receives, reviews, and evaluates damage assessment reports, and assists the commander in developing and implementing the base recovery strategy.

3.3.2.2. Readiness and Emergency Management Flight Officer or Superintendent. This individual is responsible for oversight and administration of the EOC, coordinates activities of the remaining staff, and recommends priorities for emergency response forces. He/she advises the commander and battle staff on CBRNE defense matters and exercises operational control of CBRNE survey teams. This person is also responsible for monitoring activities of the shelter management and contamination control teams through their respective functional control centers.

3.3.2.3. Explosive Ordnance Disposal Representative. The EOD representative controls the UXO safing teams' activities and advises the commander and battle staff on all matters concerning UXO.

3.3.2.4. Controllers and Plotters. To support EOC operations, controller and plotter positions are filled as needed according to AFMAN 32-4004, Emergency Response Operations, and base Comprehensive Emergency Management Plan (CEMP) 10-2. These individuals will record, plot, and track attack damage inputs received from individuals and organizational control centers. They will also conduct MOS selection based upon inputs from airfield damage assessment teams (ADAT), weather and aircraft loading factors, and other mission data from the ICC.

3.3.3. The CE DCC, which is subordinate to the EOC, is established in accordance with AFMAN 32-4004. The recovery priorities and strategy are established in the EOC, then implemented, executed

and controlled by the DCC. The DCC normally controls all CE recovery activities and is usually headed by the squadron's Chief of Operations.

3.3.4. Resources. If available, tracking and plotting tools can be electronic, but should have a hard copy/paper back-up system at the EOC and DCC (primary and alternate). Resources that should be available include:

3.3.4.1. BCE contingency response plan, including checklists.

3.3.4.2. Personnel accountability tracker.

3.3.4.3. Tracker depicting vehicle status, by category, such as snow removal, ADR, base recovery, damage assessment, EOD, etc., and special-purpose equipment, generators, water supplies, and materials.

3.3.4.4. Base layout map (1" = 400') to mark and track UXO, damage and contamination, location of remote stockpiles, dispersed personnel and equipment, and the location of recovery teams; paper copy should be in acetate.

3.3.4.5. Runway damage plotting map (1" = 100') with a subdivided 10' x 10' grid on runway surface. Mount paper copy behind plexiglass.

3.3.4.6. MOS selection and RQC kits.

3.3.4.7. Base master plan tabs (C & G) showing location of utilities, drainage, etc. If not already, this feature will be a function of Expeditionary GeoBase.

3.3.4.8. CEMP 10-2.

3.3.5. Precedence of Command and Control. Normally, the wing commander directs operations from the ICC. After the EOC is activated, the preattack and recovery operations are managed from this command cell. In the event of isolation, attrition, or loss of equipment, CE and ADR command and control would pass as follows:

3.3.5.1. EOC (BCE).

3.3.5.2. Alternate EOC.

3.3.5.3. DCC.

3.3.5.4. Alternate DCC.

3.3.5.5. Senior BCE Officer.

3.3.5.6. ADR officer in charge (OIC).

3.3.6. Communication loss with the EOC/DCC. If the ADR OIC loses contact with the DCC and alternate DCC, it must be assumed that they either have been damaged beyond operational capability or have inoperative communications equipment. In either case, the OIC will attempt to verify the situation by dispatching a runner to check their status. Once verified, or until directed otherwise by competent authority, the ADR OIC will continue working toward providing a repaired MOS in the required time. Similarly, ADATs and EOD teams must be trained in the command sequence to automatically report to the DCC if they lose contact with both the EOC and its alternate.

**3.4. Engineer Organization.** The DCC is the focal point for engineer activities during base recovery. The ADR team receives its direction from the DCC. The team functions under an area repair group concept

wherein an essentially equal effort is applied to both MOS and access taxiway repair requirements. Typically, three crater repair crews are designated for MOS support and another three crews are assigned to taxiway requirements. For parallel runway bases, the installation may have more crews, or assign two crews to each runway and two for taxiways. In either case, the installation should exercise according to their installation's specific plan. In addition, the installation's In-Garrison Expeditionary Support Plan (IGESP or ESP) should reflect their approach to allow incoming forces to train accordingly. Crews should be flexible in order to focus on specific areas driven by the actual damage and the air tasking order (ATO) requirements. Each crew will repair craters according to the priority established by the EOC. The hauling crew supports the six repair crews with fill and FOD cover deliveries. The support team accomplishes all the ancillary, but equally important, tasks of FOD removal, spall repair, airfield marking, airfield lighting, and aircraft arresting system installation. The ADR OIC and noncommissioned officer in charge (NCOIC) lead this entire operation.

**3.5. Organizational Responsibilities.** Many difficult decisions must be made quickly and accurately during an actual airfield recovery situation. Recognizing the need for decisive response to a wide variety of situations, base recovery calls for a standard organizational structure and assigns responsibility accordingly. Briefly summarized, these responsibilities are:

3.5.1. EOC. The EOC, as described previously, is responsible for managing overall installation recovery operations, including ADR. The BCE and engineer members of the MOS selection team are located in the EOC. During ADR operations, the EOC staff directs the airfield damage assessment effort, receives and plots damage and UXO data, and selects three MOS candidates to present to the ICC Commander. After MOS selection by the ICC Commander, the EOC orders EOD forces to begin UXO safing operations and instructs the DCC to initiate ADR operations.

3.5.2. Airfield Damage Assessment Teams. **Chapter 6** of this volume provides detailed information on the responsibilities of the ADATs. The ADATs receive direction from the EOC and report airfield damage and UXO data.

3.5.3. MOS Selection Team. **Chapter 6** of this volume outlines procedures for selecting the MOS. The MOS selection team plots damage and UXO data received from the ADATs, and after MOS selection is complete, continues to monitor and record damage repair and EOD progress. The MOS selection team also performs all RQC calculations as outlined in **Chapter 7** of this volume.

3.5.4. DCC and ADR OIC. The DCC is manned by key BCE supervisory personnel, and serves as the focal point for management of CE recovery efforts. During the initial stages of damage assessment (from the advantage point of the DCC), the ADR OIC monitors the logging and plotting of all incoming damage and UXO data reported by the ADATs. After all reports have been received and the ICC Commander has selected the MOS, the EOC annotates the MOS coordinates, MOS operations (bi- or unidirectional), identifies the location of craters to be repaired, records MAAS and distance-to-go marker locations, and designates which taxiways and access routes are to be cleared and repaired. Once this data has been received, the ADR OIC normally will join the ADR team at either their dispersed sites or staging area and outline specific duties and areas of responsibility. From this point on, the ADR OIC will usually remain on-scene and assume immediate control of the operation. If damages to be repaired are considerably different from those upon which ADR operations are preplanned, the ADR OIC alters team assignments as necessary. For example, the ADR OIC may have to shift a crater repair crew from the MOS to the access taxiways or perhaps release crews to other taskings if damages are lighter than expected. Much of the extent of this adjustment can be determined in the

DCC prior to the ADR OIC leaving the control center. Once the overall scope of the ADR operation has been identified, the OIC directs crews to craters, designates haul routes to be cleared, and determines which stockpiles are to be used. In the DCC, plotters continue to update wall displays as repair progress reports are received. In addition, these plotters maintain the status of material usage, personnel casualties, and equipment losses. Display boards in the DCC (whether manual, projected computer-based, or semi-automated LCD displays) should include, but not be limited to, the following:

3.5.4.1. Airfield map showing damage, crater identification numbers, MAAS location, distance to go marker locations, planned or actual MOS and taxiing patterns, haul routes, and areas where work is in progress or completed.

3.5.4.2. Tasking board listing each team's task, and start and estimated completion time.

3.5.4.3. Equipment status indicating each team's equipment allocation and performance limitations due to breakdowns, malfunction, or war damage.

3.5.4.4. Material usage to show quantities of ballast rock, crushed stone, AM-2 mats, and FFMs remaining at each stockpile location.

3.5.5. Support Team OIC and ADR NCOIC. The support team OIC's primary responsibility is to ensure that the several crews assigned under him/her accomplish their taskings on time and correctly. While the crews themselves are not large, they are diverse in nature and somewhat specialized. Any individual has the potential to delay launch and recovery operations if the performance of their portion of the ADR effort is lacking. This is particularly true of the FOD removal and spall repair teams. The support team OIC will act in a roving controller capacity during the entire ADR operation to ensure all teams are providing the required support. Also having to serve as a roving controller is the ADR NCOIC. This individual must maintain close oversight of both the MOS and taxiway ADR operations and the associated hauling team support. The ADR NCOIC's primary function is to act as an on-site problem solver and to provide technical and control assistance to the ADR OIC. The ADR NCOIC must facilitate the coordination of requirements between all ADR crews to ensure delays in repair progress are avoided.

3.5.6. ADR Crater Crew Chiefs. Crew chiefs carry out their task of managing the crater crew's operations and reporting progress to the ADR OIC. Samples of the type of progress information to be reported are shown in [Table 3.1.](#) and [Table 3.2.](#)

**Table 3.1. Suggested Progress Report Format (AM2 Mat Repair).**

FROM REPAIR TEAM NUMBER:		_____
REFERENCE CRATER NUMBER:		_____
SERIAL EXAMPLE	ACTIVITY (do not send over radio)	TIME OR % COMPLETE
A T	ime now	1230
B	Started work (time)	1205
C	Clear around crater (%)	100%
D	Upheaval Removal (%)	10%
E	Stone in crater (%)	
F Compa	ction (%)	
G	Final leveling (%)	
H	AM-2 patch assembly (%)	10%
I Sweeping	(%)	
J	Mat in place (time)	
K	Patch Anchoring (%)	
L	Estimated time of completion	1500

**Table 3.2. Suggested Progress Report Format (Folded Fiberglass Mat Repair).**

FROM REPAIR TEAM NUMBER:		_____
REFERENCE CRATER NUMBER:		_____
SERIAL EXAMPLE	ACTIVITY (do not send over radio)	TIME OR % COMPLETE
A T	ime now	1230
B	Started work (time)	1205
C	Clear around crater (%)	100%
D	Upheaval Removal (%)	10%
E	Stone in crater (%)	
F Compa	ction (%)	
G	Final leveling (%)	
H	Mat assembly (%)	10%
I Sweeping	(%)	
J	Mat in place (time)	
K	Mat Anchoring (%)	
L	Estimated time of completion	1500



### 3.6. Communications.

3.6.1. Communication Equipment. The host BCE's communications equipment will provide sufficient assets to accomplish the ADR mission. However, mobility forces should deploy with two-way radios to enhance the ADR capability further. When possible, the deployment team's radios should be adjusted to correspond to the frequency of the host. However, without such modifications the usefulness of the deployed team's radios will be constrained and communication interaction between host and deployed personnel could be greatly impaired.

3.6.2. ADR Essential Communications. The ADR OIC and NCOIC must maintain communications not only with the various ADR team chiefs, but also with the CE DCC. **Table 3.3.** serves as a quick visual reference of suggested ADR team radio requirements. This list is not cardinal, but presented as a general guide. Each unit should formulate their ADR communications requirements predicated upon the anticipated situation. Factors to consider when doing so include team experience, threat assessments, leadership expertise, and available equipment resources. Radio authorization levels are outlined in allowance standard (AS) 660, Non-Weapons Systems Communications Requirements.

**Table 3.3. Suggested ADR Team Radio Requirements.**

Function	Requirement*
ADR OIC and NCOIC	Portable & vehicle mounted, jam-resistant units
MOS Repair Team Chief	Portable two-channel, jam-resistant unit
Taxiway Repair Team Chief	Portable two-channel, jam-resistant unit
Hauling Team Chief	Portable two-channel, jam-resistant unit
Support Team OIC	Portable two-channel, jam-resistant unit
MAAS Crew Leader	Single-channel, jam-resistant unit
MOS Marking Team	Single-channel, jam-resistant unit
Airfield Lighting Team	Single-channel, jam-resistant unit
FOD Removal Team	Single-channel, jam-resistant unit
Fill Site(s) Personnel	Single-channel, jam-resistant unit
Equipment Operators (as required)**	Single-channel, jam-resistant unit
*Each ADR situation should be assessed individually. The above suggested radio requirements will most likely not prove ideal for every scenario. Make necessary adjustments accordingly.	
**Care must be taken to avoid having too many radios in use. Excess chatter on the frequency can only serve to create confusion and discord.	

3.6.3. Alternate Communication Forms. Radio communication is the ideal method; however, due to any number of variables, radios may be partially or totally unusable. Therefore, establish some alternate form of communication, such as field phones, base phones, runners, et c., to pass information, such as simple status reports, requests for essential services or supplies, and passing directions and guidance.

3.6.4. DCC. Communications with the following essential primary and alternate agencies should be available to relay damage reconnaissance and to manage ADR activities from the engineering DCC:

- 3.6.4.1. EOC.
- 3.6.4.2. Fire operations center.
- 3.6.4.3. Base defense operations center (BDOC).
- 3.6.4.4. Logistic readiness center (LRC).
- 3.6.4.5. Medical services.
- 3.6.4.6. Sheltered engineer teams.
- 3.6.4.7. ADR operations.

3.6.5. Both ADR OIC/NCOIC should have a portable (hand held) and vehicle-mounted, multi-channel, jam-resistant (if available) frequency modulation (FM) radio for communications with engineering DCC and ADR teams.

3.6.6. The MOS crater team, taxiway crater team, haul team, should each have a portable (hand held), two-channel, jam-resistant (if available) FM radio for intercommunications.

3.6.7. The airfield management and ramp net should have a single-channel that is jam-resistant for contact with the ADR OIC/NCOIC.

3.6.8. The MAAS team, airfield lighting team, FOD clearance team, MOS marking team, EOD ADR support team, shelter managers, and equipment operators of sweepers, excavators, graders, paint machine, ordnance clearance equipment, dump trucks, stockpile loader, etc., should be provided a single-channel, jam-resistant (if available) radio for contact with their respective team chief.

**3.7. Summary.** Without effective command and control, ADR operations are not likely to meet mission requirements. The wing commander controls assigned forces and all ABO operations through the ICC using the battle staff and existing radio and telephone communications. The ICC monitors status and location of personnel, resources, communications, damage, and other factors impacting mission-capability. The next level of ADR command and control is the EOC, which is controlled by the MSG Commander and is the hub of ADR activities. From the EOC, functional chiefs provide overall direction and guidance to the field forces accomplishing base recovery. In particular, the BCE passes EOC information and decisions to the CE DCC. The DCC is the focal point for engineer activities during base recovery. The ADR team receives its direction from the DCC. It is important that each control center have an alternate location to assume responsibility if the primary becomes disabled. Next, the ADR OIC and NCOIC direct numerous ADR teams. Effective and secure communication is critical between the various teams and control centers. Alternate communication procedures must be established in case the primary methods become disabled to ensure effective control and reporting continues.

## Chapter 4

### SEQUENCE OF EVENTS

#### 4.1. Peacetime Planning and Actions.

4.1.1. Preattack Planning Phase. This phase of recovery operations is very critical. Meticulous planning, realistic training, extensive checklists, pre-selected dispersal sites, hardened facilities/equipment, and other such planning measures will prepare CE forces to perform quickly and efficiently during the subsequent phases.

4.1.1.1. All preattack preparations, including ADR, must be listed, disseminated, and exercised properly. These tasks are generally listed in MAJCOM/base recovery directives/checklists, base/joint support plans, reception plans, medical wartime plans, and communications support plans. Disseminate such plans to the lowest level necessary to ensure rapid execution. Consolidate the BCE's preattack planning efforts into the CEMP 10-2.

4.1.1.2. As a norm, hostility buildup can be expected to provide several days warning during which the base should improve its defensive posture. However, to prevent surprises, write a minimum alert preparation plan (short notice) and implement, practice, and incorporate it into the CEMP. Specific reaction standards (times) should be established to measure satisfactory performance. Time will be of the essence.

4.1.2. Peacetime Actions. During peacetime, at bases with defined threat probabilities, the BCE should accomplish the following actions:

4.1.2.1. In conjunction with the EMP and Emergency Action File checklists, develop specific checklists itemizing essential ADR actions for the preattack phase. Implement these checklists, along with those provided by higher headquarters, when directed by the ICC or EOC.

4.1.2.2. Conduct integrated training in full chemical warfare defense (CWD) gear, so crews are proficient in the environment and are accustomed to working in full CWD equipment. To add realism, conduct at least one integrated nighttime exercise annually.

4.1.2.3. Determine and preposition an adequate supply of needed repair materials, identify strategic locations for stockpiles, and establish several suitable alternative haul routes from these stockpiles to potential MOS. The repair fill material quantities are based upon the perceived threat and dictated by theater and MAJCOM directives. Locate repair materials for rapid access to the expected repair areas. Stockpile aggregate in the immediate vicinity of runways and taxiways to minimize haul times, yet separate far enough from each other to increase survivability. Ensure pile heights and locations comply with aircraft obstruction and clearance requirements. Maintain access to buried utilities. Stockpile locations must provide reasonable all-weather access and, when possible, should not require haul routes that use the MOS. Otherwise, trucks may track mud and possibly spill rocks and debris onto the MOS surface, complicating the runway and taxiway sweeping and clearing efforts.

4.1.2.4. Determine requirements and preplan stockpiles of emergency water supplies since normal base utilities may be disrupted during the attack. Water for drinking and personal hygiene should be pre-identified and available at the dispersal site or in protected areas, such as basements. After an attack that may include chemical weapons, consider unprotected base water unsafe for consumption until proven otherwise.

4.1.2.5. Install an accurate and survivable runway reference marker system to be used by ADATs in reporting airfield damage and UXO, and by the MOS marking team for MOS layout.

4.1.2.6. Plan for beddown and integration of augmentation forces.

4.1.2.7. Identify support requirements, such as transportation, from the shelters to the dispersed equipment locations, vehicle mechanics to assist in postattack vehicle repairs, and EOD personnel to stand by at the repair site for potential UXO safing. These requirements should be coordinated with appropriate tasking agencies, and incorporated into the EMP.

4.1.2.8. Determine suitable dispersal locations for ADR equipment, materials, and people. This may include programming collaterally protected personnel shelters; building berms; or modifying existing natural protection, such as ditches, hillsides, etc., into some means of splinter protection, and improving the surface and/or drainage to preclude a mud problem in a rainy season. In selecting these dispersal sites, consider the proximity of possible targets, natural cover and concealment, security, access in inclement weather, etc.

4.1.2.9. Make plans to improve and expedite airfield damage assessment and repair procedures during peacetime. Accomplish by utilizing all available base assets, not just CE's, in assessing airfield damage. The focus should be on getting the presumptive MAOS to leadership as quickly as possible.

4.1.2.9.1. Where possible, utilize existing visualization tools, such as remotely operated cameras, to efficiently manage ADATs and damage assessment process. Using these tools can allow the MOS selection team to guide the ADATs and prevent wasting time by running the entire airfield when some areas are too damaged to repair.

4.1.2.9.1.1. Expediting damage assessment can be accomplished by such things as planning and exercising use of existing airfield security camera systems, which may be configured to feed video into the EOC. If there is not a feed to the EOC, local procedures might be to send a person to the SF control center to view the camera system while guiding the ADATs.

4.1.2.9.1.2. An individual can be dispatched to the control tower, if it is not damaged, to retrieve digital photos of airfield damage. Digital cameras can also be pre-positioned around the airfield on existing tower type structures to provide complete coverage. Photos taken by these cameras can be used by the MOS selection team.

4.1.2.9.1.3. If available, partner with SF to develop an agreement for use of their mini-unmanned aerial vehicles (UAV) to conduct preliminary damage assessments of the airfield through use of real-time camera feeds or photographs. NOTE: At publishing time of this pamphlet, actions were underway to integrate processes between SF Common Relevant Operating Picture (CROP) and CE Common Operating Picture (COP).

4.1.2.9.2. Develop grids for ramps and taxiways as well as the primary runway so larger damage areas can be properly plotted. If GPS assets are available, use the Military Grid Reference System (MGRS) as the primary method to locate damage.

4.1.3. Probable Targets. Probable targets, other than the runway, include communication facilities; utility plants; petroleum, oil, and lubricant areas; liquid oxygen (LOX) storage; munitions storage; aircraft shelters and hangars; exposed aircraft; and headquarters buildings. Heaviest bomb or missile

groupings occur on the runway/alternate launch and recovery surfaces, aircraft shelters, and industrial areas.

4.1.4. Dispersal Area Considerations. Disperse personnel, equipment, and materials at least 1,000 feet from probable primary fixed targets. The areas off the ends of the runway and the housing area may provide candidate dispersal areas. Coordinate with the local intelligence section (wing director of operations) for the most likely targets.

4.1.4.1. When possible, plan for cover and concealment that blends with the background and sites that provide natural cover, such as trees, foliage, ditches, or hillsides. Improve protection by hardening with drive-through trenches, berms, sandbags, etc.

4.1.4.2. Sites that are accessible in inclement weather should be selected, and the effects of drainage, mud, icy inclines, or snowdrifts should be considered.

4.1.4.3. If the housing area is clear of occupants, dispersal into the housing area should also be considered. Park equipment as close as possible to the sides of buildings (preferably in the shadows) located away from the flight line and industrial areas. Use basements for personnel protection. If feasible, use a top-story window for an observer with a radio to report to the DCC after an attack. Be sure to provide as much splinter protection to that position as possible.

4.1.5. Personnel Dispersal Area Considerations. The following are general guidelines for selecting personnel dispersal areas.

4.1.5.1. In general, location considerations used in sheltering the equipment from attack also should be applied when sheltering personnel. However, when sheltering personnel, the first option should be for a hardened, filtered-air, over pressurized shelter. If such a shelter is unavailable, the next option should be to wear the ground crew ensemble (GCE) inside a collective protected facility. If collective protection is not available, personnel should don IPE and take shelter in places away from primary bomb impact areas, as depicted in Figure 4.1. Expedient shelters would include trenches, berms, basements, behind buildings, or other such splinter protection. During peacetime, assigned personnel shelters, install communications capability between shelters and the EOC/DCC, and establish and practice postattack reporting procedures.

4.1.5.2. Once the crews are in GCE and the gear becomes contaminated, there is presently no way for people to partially remove individual pieces, such as the hood and mask for food intake, or the trousers for bodily functions. Water intake is possible through the water-intake port in the mask, but do not break the mask seal. Rest or relief outside the contaminated clothing can take place only at a hardened, filtered-air, over pressurized shelter or at a processing facility with positive filtered airflow. There is not a chemical threat-level requiring only a partial ensemble. The BCE's pre-attack planning should include the following:

4.1.5.2.1. Total number of individual protective garments and masks assigned.

4.1.5.2.2. Decontamination cycle and time requirements.

4.1.5.2.3. Processing and decontamination responsibilities.

4.1.5.2.4. Work/rest cycle—instead of 12-on/12-off, a 4-on/4-off or similar schedule may be required if the wet-bulb globe temperature index dictates in order to provide sustained capability.

4.1.5.3. Survey the area to determine several suitable alternative routes from the selected dispersal sites to potential staging areas. Present candidate routes to the EOC for approval.

4.1.6. Training. Peacetime training should be comprehensive and thorough, and should be in accordance with existing training guidance outlined in AFI 10-210, Prime Base Engineer Emergency Force (BEEF) Program.

**4.2. Preattack Actions.** During this phase, the base should make final preparations to survive an attack. When directed by higher headquarters, the wing commander, through the ICC, should initiate emergency action file measures, such as activating the EOC; implementing the base recall; coordinating the evacuation and travel of noncombatants; directing issue of field equipment, weapons, CWD equipment, rations, and individual equipment; and placing the base on wartime duty hours.

4.2.1. EOC Responsibilities. The EOC is responsible for establishing alert postures and directing all combat support organizations to take appropriate action in coordination with the established alert posture. When activated, the EOC staff assembles, runs the appropriate checklists, deploys the necessary teams and equipment, and generally, ensures that all recovery personnel and activities are ready to perform their base recovery functions.

4.2.2. Airfield Damage Assessment Teams. ADATs should establish contact with the EOC and report to their sheltered dispersal locations. Each team chief should ensure team equipment operability, account for team composition, and secure assigned vehicle and equipment near each team's shelter.

4.2.3. EOD Personnel. The EOD team chief should brief team personnel, make EOD assignments to ADATs, keep the EOC informed of EOD activities, and secure assigned vehicles and equipment near the team's sheltered dispersed areas.

4.2.4. BCE Preattack Actions. At this point, the BCE's efforts should be directed toward protecting people, equipment, and vehicles, and to ensure that CE resources are ready to start base recovery as soon as the attack is over. The BCE should establish a base of wartime operation; assemble, account for, brief, and disperse CE troops and equipment; prepare expedient hardening; ensure that communications equipment is in commission; and see that all personnel understand their jobs. The following actions are included:

4.2.4.1. Execute the preattack checklists.

4.2.4.2. Place personnel on appropriate shift schedules; establish duty hours and crew changeover procedures; move the off duty personnel into assigned shelters to start their crew duty cycle; and plan for messing, rest and relief, and for chemical contamination processing. As planned, ADR teams should be dispersed between shelters and transported so one shelter or vehicle loss will not eliminate an entire functional capability (e.g., all excavator operators or team chiefs should not be located in one shelter or vehicle).

4.2.4.3. Issue all required individual protective equipment.

4.2.4.4. Prepare ADR equipment and vehicles for recovery operations. Mount blades on designated vehicles, install armor, and check fluid levels. Identify emergency sources of water for refill and confirm travel routes from dispersal sites to the pre-designated staging area. Establish predetermined travel route checkpoints for teams to call in their status. This enables the EOC to know where to continue the route should a replacement team be required.

4.2.4.5. Beddown and integrate the augmenting ADR forces, if appropriate.

4.2.4.6. Plan for building berms or similar structures at the preplanned UXO holding areas. Identify locations for shallow ditches at predetermined intervals along the aircraft operating surfaces. Use these ditches as sub-munitions holding areas for EOD clearance operations. The purpose of these ditches is to get the munitions below grade; therefore, the ditches should be between 1 to 2 feet deep and 2 to 3 feet wide. Rather than digging trenches at this time, identify areas where trenches can be dug without cutting utility lines. Also, identify locations for possible construction of expedient trenches near the runway. Airfield damage repair team members working on the MOS use these trenches when sufficient time is not available to reach a hardened shelter facility during no-notice follow-on attacks.

4.2.4.7. Inspect stockpiles and haul routes. Ensure that adequate spall repair material and associated dry aggregate are available.

4.2.4.8. Review plans for refueling and servicing equipment, on-site maintenance, and spare parts availability. Leave keys in vehicles and ensure that spare keys are available. However, do not leave keys in vehicles if enemy special operation forces (SOF) engagement is expected.

4.2.4.9. Review vehicle status board and discuss the consequences of any known equipment limiting factors (LIMFACs).

4.2.4.10. Perform regular status-checks to account for personnel and ensure teams are fully manned.

4.2.4.11. Ensure that communications equipment (two-way radios) are issued, checked for proper operation, and that an ample supply of spare batteries is available. If plans call for more than one frequency, make sure all involved parties understand the reasons for such. Also, make sure that the battery chargers function properly.

4.2.4.12. If required, when the ADR crews have completed their preattack actions, have them assist other engineer recovery crews in such activities as utility isolation; hardening; sandbagging; camouflage, concealment, and deception; and beddown of arriving forces.

4.2.4.13. If possible, ADR vehicles, stockpiles, and haul routes should be high priorities on DAT routes. Designate specific ADR personnel to assess ADR resources and routes if DATs are delayed. Personnel must be in the appropriate mission oriented protective posture (MOPP).

4.2.4.14. Load dump trucks with appropriate fill material and water trucks as required.

4.2.4.15. Load appropriate ADR matting kits and dozer (if required).

4.2.4.16. Inventory and inspect the EALS and MAAS.

4.2.4.17. Coordinate with other support agencies providing services and assets to the ADR effort. This includes vehicle maintenance teams ensuring their stock levels are full, assigning mechanics, and collocating vehicles with ADR equipment.

4.2.4.18. Arrange for fuel services to top-off all dispersed vehicles and equipment. Never leave ADR assets idle with their fuel tank less than one-half full.

4.2.4.19. Plan for weapons issue and work party security based on the state of alert and the perceived threat.

4.2.4.20. Move ADR sets and associated equipment to dispersal locations and shelter all personnel.

4.2.4.21. Normally, the ADR OIC and NCOIC report to the DCC in order to observe damage plotting activities as they are received from the EOC. This will allow both the OIC and NCOIC to obtain first-hand knowledge of the true extent of damage to the MAOS and better prepare them to make on-scene decisions once the team is on the MOS.

### 4.3. Transattack Actions.

4.3.1. General. The effort at this point is to ensure that all needed actions have been taken to rapidly place the base at a maximum level of protection to survive a full-scale attack employing conventional and chemical weapons. Standardized USAF attack alarm signals (based upon international agreements) are used at all high-threat area bases. The decision to declare a given attack alarm is made by the wing commander, based on an actual threat to the base, rather than on forecasted threats for large geographic areas. Information about the type and level of threat is obtained from intelligence reports, air defense radar, early warning systems, base CBRNE detection systems, individual reports, unit air traffic control organizations, security patrols, and civil/host nation agencies. Dissemination of the attack alarm is accomplished by the installation warning system which incorporates voice, siren, and other audible signals, as well as visual signals to ensure that all personnel are warned promptly of attacks. The base is expected to receive at least a 5-minute warning before the attack. All personnel should don the IPE, according to MAJCOM and base instructions, go to the nearest or assigned shelters, or take cover under or behind the nearest expedient shelter and wait for the "attack is over" signal with specific instructions.

4.3.2. BCE Transattack Actions. Civil engineer personnel are well qualified to identify facility utility, and pavement damage. Each ADR team, if not inside a "blind" shelter, should appoint an observer to watch the attack (if a suitable and safe vantage point is available) and immediately report to the DCC observed munitions, general-purpose, or sub munitions damage. The DCC quickly consolidates and passes this information on to the EOC for consideration. Such reports will assist the EOC in obtaining a quick picture of the postattack situation and will enable them to focus EOD response and damage assessment efforts. Although not equipped to test and respond to chemical contamination, observers should watch for vapor-dispersing munitions and be especially watchful for animal reactions. If there are signs of birds dying or small animals having convulsions and becoming incapacitated, with no apparent wounds, it is likely that chemical agents are present.

4.4. Postattack Actions. To ensure an airfield can quickly return to its operational role following an attack, a well-organized ADR effort is essential. The value of the planning and training becomes evident as the procedures are implemented during an actual attack. To address a sequence of events for ADR operations, a general scenario must be portrayed. In our case, we will begin at the point where all preattack actions have been completed, all command posts and control centers are functioning, dispersal requirements have been met, and personnel have been sheltered. The base has just been attacked and considerable damage has been sustained. Particularly hard hit were the runway, taxiways, and major aircraft parking areas. After the attack, personnel occupying observation posts and organizational units begin reporting damage, fires, and UXO sightings to the EOC and/or DCC. Reports confirm major damage to the airfield with numerous craters on the main runway, taxiways, aprons, and access routes from the aircraft shelters. Spalls are prevalent throughout the pavement system and UXO are in abundance.

4.4.1. Damage Assessment. Damage assessment is normally the first function performed after an attack. It is extremely important to rapidly obtain a damage picture of the entire area of interest (runway, taxiways, shelter access, etc.) by using all tools available. Integration of flightline cameras, ele-



vated observation posts, and mini-UAVs as planned during peacetime actions should help the EOC MOS selection team expedite and focus airfield damage assessment. The ADATs initially survey assigned sections of the airfield in order to locate craters, spalls and utility breaks, and make an initial UXO reconnaissance. However, they must be under positive control of the EOC's MOS selection team to focus them on likely MOS areas and expedite MOS selection. In the absence of a suitable armored/hardened vehicle, the assessment team must proceed on foot. The number of ADATs required is dependent upon the size of the airfield; however, most bases will posture three teams.

4.4.1.1. Quick initial reconnaissance to provide assessment of installation damage after an attack is a key part of recovery. All base personnel and organizations have a responsibility to report to the EOC, through their respective control centers, any facility damage, casualties, suspected contamination, and unexploded ordnance within and around their specific areas. Each organization should identify and train specific damage reconnaissance personnel for this purpose. While base organizations report damage in and around their immediate areas, DATs assigned to the EOC perform damage assessment in specific areas, such as airfield surfaces.

4.4.1.2. Damage assessment team manning normally involves one engineering technician (3E5X1), one EOD technician (3E8X1), and one augmentee (any AF specialty [AFS]). These teams, under the EOC direction, should survey the runways and taxiways using pre-assigned routes until given direction to specific areas based on the MOS selection teams quick assessment using remote cameras/observation means to narrow the likely MOS locations. The engineering technician will determine the location and size of craters and spalls while the EOD technician identifies UXO by type, location, and, when possible, by fuse. Generally, the augmentee will be trained as a driver/observer and will serve as a data recorder. The team uses a grid-reference system and available visual references, such as prepositioned pavement reference markers, runway distance markers, centerline, runway edge, taxiway locations, runway lights, etc., to estimate the location of damage and UXO. The team also monitors vehicle-mounted detectors and M-8 paper for the presence of chemical agents. During this damage assessment period, speed is of the essence. All findings uncovered by the team are immediately passed to the EOC. Damage assessment procedural details are presented in [Chapter 6](#) of this volume.

4.4.2. Locating a MOS. Immediately following the attack, the EOC dispatches the airfield damage assessment teams to determine the extent and severity of damages to airfield operating surfaces. Based on initial damage reports from remote observation tools (flightline cameras, mini-UAVs, etc.), observers, and base agencies, the EOC directs the ADATs (using preplanned routes) to the least damaged areas of the airfield pavement complex to provide feedback on the size, type, and location of damage and UXO. At the same time, DATs make a quick inspection of ADR equipment and stockpiles reporting the results of their findings to the DCC where the ADR OIC is initially located. If the DATs designated to assess ADR resources and routes are delayed, designated ADR personnel outfitted in the appropriate MOPP are dispatched to assess ADR resources and routes. As reports from the ADATs are received, the MOS selection team in the EOC records and plots the damages sustained. In due course, the full extent of the attack becomes apparent. The critically important decision at this juncture is to determine which areas of the airfield pavement surfaces require immediate repair to conduct aircraft generation. The MOS location will normally be the section of airfield requiring the least amount of repair and disposal of unexploded ordnance and meets the requirements for aircraft launch and recovery. The MOS must satisfy mission requirements for sustained operation and must be suitable for the type aircraft specified by the ICC. The ICC provides aircraft mission requirements and the MOS

selection team, using RQC technical order (TO) procedures, makes a crosscheck of the MOS length requirement.

4.4.2.1. Repair Time Estimates. Develop repair time estimates and strategies now. Prior to attack, the EOC plotter shall contact the DCC and verify what R-Set (R1, R2, or R3) is available for ADR. Obtain UXO safing time estimates from the EOD representative on the EOC staff.

4.4.2.2. MOS Candidate Selection. Shortly after receiving the last bit of relevant airfield damage information, the MOS selection team identifies the three best MOS candidates and presents them to the Wing Commander for final approval. After the ICC Commander selects a MOS, EOD teams start UXO safing and removal actions and ADR personnel begin recovery efforts as soon as appropriate UXO clearance is afforded.

4.4.3. Mobilizing Repair Forces and Materials. The EOC informs the DCC of the selected MOS details and directs the commencement of ADR operations. The DCC, in turn, directs the ADR team. Since the ADR OIC is normally in the DCC during the MOS selection phase of the ADR operation and has the opportunity to observe the plotting of damage inputs, he/she should be fully aware of the overall ADR recovery requirement. With this knowledge in hand, the ADR OIC then takes on-scene control of the ADR operation, assigning tasks to the various ADR crater crews; designating travel routes of vehicles, equipment, and personnel from dispersal sites; and coordinating the efforts of the ADR crews, hauling crews, and support teams. Vehicles are moved from dispersal sites to a staging area in preparation for convoying to the repair sites, a last check of equipment is made, and the word is passed back to the DCC that the ADR teams are ready to proceed. If the team can follow the same preplanned route(s) used by the ADATs to the MOS, most apparent UXO hazards on such route(s) will have already been identified and the potential for incurring subsequent UXO damage should be noticeably reduced.

4.4.4. Accomplishing ADR Operations. When EOD teams have sufficiently cleared or safed any impinging munitions, the EOC clears the ADR forces for entry to the repair sites. As ADR teams convoy to their respective work areas the team's OIC and NCOIC conduct a quick final check of the MOS to ensure ADR operations can actually commence as planned. If circumstances that might invalidate MOS selection are identified, the OIC should immediately advise the DCC and inform the teams to hold position until the situation is reevaluated. Some conditions that might invalidate MOS selection include: 1) excessive damage; 2) too large a repair area; 3) unchecked broken fuel lines; 4) missed area-denial weapons; and 5) damaged utility lines.

4.4.4.1. If no problems are found, the ADR crews continue the convoy to each of the repair locations. Airfield damage repair crews travel to their sites in small, mixed increments so explosions, accidents, or contamination will not cripple the ADR effort through the loss of an entire crew. The vehicles contain "mixed loads" of people so all excavator operators or other highly specialized personnel will not be attrited by a single explosion. Convoy the vehicles individually at no less than 60-second intervals. Crews from the support team, such as airfield lighting installation, aircraft arresting system installation, FOD removal, and spall repair are also traveling to the repair locations.

4.4.4.2. Convoys are arranged so that the first groups to arrive on scene are those tasked with MOS layout. Minimum operating strip layout usually involves location identification, or layout, of the locations identified in [Table 4.1](#).

4.4.4.3. As crater repair crews arrive at their work sites, they perform the repair operations following detailed procedures outlined in UFC 3-270-07. It is up to the crater crew chiefs to ensure their repairs progress smoothly and rapidly and that no equipment stands idle. The ADR OIC and NCOIC closely monitor the overall progress of the entire operation and make necessary adjustments as required. Flexibility, resourcefulness, and leadership ability will be required here.

**Table 4.1. MOS Marking Team Layout Tasks.**

MOS LAYOUT TASKS
1. MOS threshold layout
2. MOS departure layout
3. MOS centerline
4. "T" clear zones
5. MAAS
6. Distance-To-Go (DTG) Markers
7. Precision Approach Path Indicators (PAPI)
8. Edge Markers
9. MOS threshold lighting
10. Approach lighting

4.4.5. Any damaged utility lines found in the crater repair area should be reported to the DCC. If the broken utility line creates a hazard, the ADR crew may work in other areas until the hazard is eliminated. Otherwise, do not delay MOS crater repairs because of damaged utility lines. If the utility is mission-critical, undamaged sections on either side of the runway/taxiway crater may be located, and a bypass repair accomplished at a convenient time.

4.4.6. Installing the Aircraft Arresting System. Most airfield recovery situations will require the installation of a MAAS; since it is likely the permanently installed systems are either damaged or located in an area unsuitable for the selected MOS. Details concerning arresting systems are addressed in Volume 5 of this Air Force Pamphlet (AFPAM) series and Air Force Handbook (AFH) 10-222, Volume 8, Guide to Mobile Aircraft Arresting System Installation. If an arresting system is necessary, its location will have been marked by MOS layout personnel prior to the arrival of the aircraft arresting system installation team. Prior to initial movement of the ADR forces, the support team chief ascertains from the team's OIC whether the arresting system will be unidirectional or bidirectional as directed by the EOC. This information is passed to the arresting system installation team chief. As soon as possible after the arresting system location has been marked, the aircraft arresting system installation team starts its efforts. If debris clearance is required at the installation site, the arresting system team chief requests such assistance through the support team OIC. Once the arresting system is installed, the arresting system team chief checks the tape sweep area for cleanliness. If debris has to be moved out of the tape sweep area, this is also coordinated through the support team OIC. The arresting system team chief retains the responsibility for ensuring the tape sweep area is usable even after requesting debris removal support. He/she must not declare the arresting system serviceable until the tape sweep area is completely clear of any object that could interfere with the arresting system.

operation and can certify that the installation is in accordance with T.O. 35E8-2-10-1, Arresting Systems, Aircraft, Mobile (MAAS). NOTE: For new installations or for cases where major civil works have been accomplished that may affect system alignment, a task-certified Power Production 7-level technician or the civilian WG 5378 equivalent must certify the system ready for use (AFI 32-1043).

4.4.7. Installing Emergency Airfield Lighting. Airfield lighting may not be important for daytime aircraft operations, but it is essential for flight in an environment with limited visibility. Restoration of the existing permanent lighting system may not be feasible due to the extent of damage or location of existing lighting relative to the MOS; if this is the situation, install an EALS. Procedures for installing portable lighting systems, as well as guidance on salvaging the existing system, are provided in Volume 5 of this pamphlet series and AFH 10-222, Volume 7, Emergency Airfield Lighting System (EALS) describes the EALS installation process.

4.4.7.1. In most cases, the question will be when to install the lighting system, not whether one is necessary. If considerable daylight will be available after all other ADR operations are anticipated to be complete, airfield lighting should not prove to be immediately critical to aircraft launch and recovery efforts. On the other hand, if the onset of darkness or limited visibility due to bad weather is a factor, start airfield lighting installation as soon as possible. The ADR OIC will have to decide the timing for this operation based on inputs from the EOC and ICC and the situation at hand.

4.4.7.2. If it is necessary to install the lighting system concurrently with other ADR operations, the lighting installation team starts the task as soon as possible. Because the edges of the MOS may not be marked and considerable debris may be remaining in the area, final placement of the fixtures probably will not be possible when the team first starts its efforts. The cabling and fixtures can be assembled 25 feet or so off of the probable MOS edges and moved into place once all major debris has been removed from the final installation area. Placement of the airfield lighting regulator and generator can also be accomplished early. The support team OIC must also make a concerted effort to dovetail the heavier debris clearance activities with the lighting installation. Since access to the areas around crater repair activities will usually be limited, the airfield lighting team should initially concentrate its activities on other areas where access is not hampered by either debris or equipment operations. Obviously, such decisions are on-scene judgments with the potential of involving unlimited variations. The basic point here is not to expect the airfield lighting team to be able to start at one end of the MOS and work to the other end without interruption—there usually will be too many other major activities on and around the MOS to allow this. While the support team OIC will have much coordination to do with respect to airfield lighting installation, the lighting installation team chief retains the primary responsibility for proper installation and performance of the system. This individual should not permit the installation team to leave the MOS area until the system is fully functional and correctly installed.

4.4.8. Debris Removal. Debris will be abundant and removal may take considerable effort. Expect debris removal activities to continue throughout the entire ADR operation time frame. The debris removal equipment is responsible for clearing all areas of the MOS and access taxiways that are not in the immediate vicinity of crater operations. The crater repair teams will clear areas immediately around craters; however, final sweeping by the FOD removal team will be required when repairs have been finalized.

4.4.8.1. The debris removal equipment may be divided into separate teams, each working an assigned area, or may remain together working the same area at once. The support team OIC will decide the assignments based on the size of the areas to be cleaned and the situation at the time.

4.4.8.2. First, the FOD removal team clears debris for a clean access route for vehicles to use while traveling between craters and while traveling to and from stockpiles or equipment storage areas. The team then starts clearing undamaged areas not containing spall fields. Since the spall repair operation creates debris, the debris clearance equipment waits until spall repair is complete before cleaning spall field areas. Debris should always be pushed at least 25 feet off the MOS. To avoid possible aircraft wing contact, never pile material more than 3-feet high. The support team OIC will have to oversee this operation closely since its timing impacts MOS marking, airfield lighting installation, and aircraft arresting system installation progress.

4.4.9. Spall Repairs. The support team OIC receives information relative to the scope and location of spall repair requirements from the ADR OIC at the onset of ADR operations. Based on this information, the support team OIC determines the assignments of the spall repair crews. Unless a spall field is located near a crater where there is heavy debris, spalls should be easy to find. Spall crews initially start their repairs in these areas and move on to the debris-covered area later. This approach allows time for the support team OIC to arrange for the necessary debris removal actions to take place. Debris covered spall fields are cleared by a single pass of a grader, excavator, or front-end loader—the intent is to clear enough debris to enable easy identification of spall locations. Once all spall repairs are complete, final clearing and sweeping actions are accomplished.

4.4.10. Airfield Marking. Marking of the MOS is normally accomplished before aircraft launch and recovery operations commence. The MOS marking effort includes striping the MOS centerline and ends; placing edge, distance-to-go, and arresting system location markers; and obliterating existing paint markings that are no longer applicable. Undamaged sections of the selected MOS can be marked and old markings obliterated while repairs are ongoing in other areas. The support team OIC coordinates the MOS marking team's activities with those of the FOD removal team to prevent marking team delays due to a lack of cleared pavement. The goal of the MOS marking team is to have all MOS marking complete by the time ADR operations are nearing completion, except for areas where crater repairs are in progress on the MOS centerline. As ADR efforts near completion, it is preferred that the MOS marking crew is waiting for the crater repair crews to finish, not vice versa. Detailed procedures on proper marking of the MOS are presented in AFH 10-222, Volume 16, Guide for Use of the Minimum Airfield Operating Surface Marking System.

4.4.11. Moving Off the MOS. The DCC, in coordination with the EOC, determines the next steps in the base recovery strategy while initial ADR efforts are underway. Upon completion of these initial ADR recovery tasks, the ADR OIC notifies the DCC of the situation and requests further instructions with respect to pavement repair requirements. In all likelihood, the recovery strategy will include numerous additional taskings for ADR team support. These could range from returning to dispersed locations in anticipation of follow-on attacks to continuation of pavement repair activities to expand airfield capabilities. Upon receipt of the applicable instructions, the ADR OIC dispatches the majority of the ADR team to its next series of taskings. A portion of the FOD removal team (primarily sweepers) remains until the final inspection of the airfield pavements is accomplished. If no further sweeping is required, release the remainder of the FOD removal team.

4.4.11.1. Before declaring the MOS open, the ADROIC and NCOIC, along with the support team OIC, inspect the MOS, taxiways, and access routes to ensure:

4.4.11.1.1. All craters have been repaired and meet RQC.

4.4.11.1.2. AM-2 mats and/or FFM are anchored in place.

- 4.4.11.1.3. All necessary spalls have been repaired.
- 4.4.11.1.4. Operating surfaces have been satisfactorily swept.
- 4.4.11.1.5. Airfield lighting and arresting system, if required, are operational.
- 4.4.11.1.6. Markings on the MOS and taxiways are completed and conflicting (old) markings have been obliterated.
- 4.4.11.1.7. All tools, equipment, and unused components of AM-2 mats and FFMs have been removed from the operating surfaces.

**4.5. Maintenance of ADR Repairs.** Expedient crater and spall repairs are temporary and require periodic inspection and maintenance. Whenever possible, post observers near the MOS to observe deflection of crater repairs and to note the response of aircraft while passing over the repaired surfaces. Increased aircraft bounce will be an indication of deteriorating serviceability of the repair. Check for rutting and sagging and inspect anchor bolts after 10 to 20 aircraft passes. When the repaired crater has settled, rutted, or sagged by 2 inches (at its worst point) below the original flat surface of the repair where the mission aircraft are fighters (3-inches where the mission aircraft are heavies), it must be re-leveled. An obvious exception would occur if a flush repair is required; in this situation the sag cannot exceed .75 of an inch. The inherent rigidity of folded fiberglass mats to bridge irregularities in the surface of the crushed stone layer beneath can result in inaccurate readings during RQC checks. To ensure that the mat conforms to the shape of the stone surface beneath it, park a vehicle on the mat while taking crater profile measurements. Surface roughness checks to determine the need for maintenance are identical to the RQC checks accomplished at the completion of the initial repairs. The same stanchions and sight rod are used. Take at least three profiles of each crater along obvious ruts or along equally spaced lines parallel to the existing runway centerline.

4.5.1. Maintenance of AM-2 Mat Repairs. Conduct the following steps when performing maintenance actions on a failed crater repair involving an AM-2 FOD cover:

- 4.5.1.1. Remove all of the nuts from the anchor bolts and inspect bolts.
- 4.5.1.2. Remove ramp units from both ends of the mat.
- 4.5.1.3. Tow the AM-2 mat away from the crater.
- 4.5.1.4. Grade off any high spots where the stone has been pushed up, fill ruts with additional crushed stone, and compact the surface.
- 4.5.1.5. Check surface roughness to ensure that the repair surface is within tolerance.
- 4.5.1.6. Cut off the tops of the old anchor bolts so that they are flush with the MOS surface.
- 4.5.1.7. Tow the AM-2 mat over the crater. Replace the ramp units and drill new holes in the pavement for new anchor bolts. Offset the patch so that new holes are at least 6 inches from the original anchoring holes.
- 4.5.1.8. Re-anchor the AM-2 mat to the pavement.

4.5.2. Maintenance of FFM Repairs. Conduct the following steps when performing maintenance actions on failed crater repair involving a FFM foreign object damage protective cover:

- 4.5.2.1. Remove and inspect all anchor bolts and bushings.

4.5.2.2. Tow the FFM away from the crater.

4.5.2.3. Grade off any high spots where the stone has been pushed up, fill ruts with additional crushed stone, and compact surface.

4.5.2.4. Check surface roughness to ensure the repair surface is within tolerance.

4.5.2.5. Tow FFM mat over the crater. Realign the mat so the holes in the mat are at least 6 inches from the original pavement anchor holes.

4.5.2.6. Drill new holes in the pavement and re-anchor the mat into position.

4.5.3. Maintenance of Spall Repairs. Conduct the following steps when performing spall maintenance actions:

4.5.3.1. Remove loose spall repair material and other debris.

4.5.3.2. Make a new spall repair using cold mix asphalt or quick setting cement.

**4.6.** Sustainment Crater Repair. Repair efforts designed to upgrade expedient repairs for increased aircraft traffic are known as sustainment repairs. Sustainment repairs should be initiated as soon as the operational tempo permits, considering that expedient repairs are only designed to support 100 aircraft sorties. Sustainment repairs to an MOS/MAOS are expected to support the operation of 5,000 C-17 passes with a gross weight of 227,707 kg (502 kips), or 5,000 C-130 passes with a gross weight of 79,380 kg (175 kips), or the number of passes required to support mission aircraft at the projected mission weights throughout the anticipated operation, if other than the C-17 or C-130. "Expected to support..." means that these numbers of passes can be conducted before additional maintenance is required. While construction time is important for conducting sustainment repairs, quality control is even more important so that further maintenance will be minimized. It is recommended that sustainment repairs commence not later than 12 to 20 hr after expedient repairs are completed; however, mission requirements and the operational tempo will generally dictate level and direction of the repair effort.

**4.7.** Summary. The airfield runway has always been a vulnerable target for enemy air attack. The widespread use of hardened aircraft shelters to protect aircraft on the ground has made the runway an even more desirable target of an enemy intent on dominating the sky. To counter this threat, CE forces must be capable of completing rapid runway repair in the shortest time possible.

4.7.1. This chapter provided information and guidance on organization, equipment, materials, and methods for rapid runway repair. The chapter was designed to be used as a ready reference, as well as a guide when conducting training.

4.7.2. By using the material presented in this chapter and the references listed in [Attachment 1](#), CE units should be able to build a viable ADR home station training program.

## Chapter 5

### DAMAGE ASSESSMENT PROCEDURES

**5.1. Introduction.** From an engineering perspective, damage assessment activities are categorized into two distinct areas: airfield damage assessment and facility/utility damage assessment. Resources permitting, both assessment operations should be conducted simultaneously and, depending on the situation at hand, may be of equal importance. Airfield assessments include evaluation of damage involving runway surfaces, taxiway surfaces, and other facilities which directly support aircraft operations. Facility damage assessment includes evaluation of damage to all other air base facilities and utility systems. This volume will be limited to airfield damage assessment procedures. Facility damage assessment, which is conducted by teams referred to as damage assessment and response teams (DART), is presented in-depth in Volume 3 of this series. Airfield damage assessment is the vital first step toward restoring a war-damaged runway. Since major recovery tasks cannot be started until damage assessment and MOS selection are completed, speed and accuracy during damage assessment are essential. Dedicated ADATs determine and report the location, types, and numbers of UXO, and the location, types, and quantity of airfield pavement damage to the EOC. A qualified team in the EOC, known as the MOS selection team, uses this information to select candidate MOSs. After the ICC Commander selects the MOS, it must be cleared and repaired in order to launch and recover aircraft. In addition, this team must also take into consideration the damage to the entire airfield operating surface, which could possibly impact aircraft generation. This entire airfield area is commonly referred to as the MAOS. Simply put, the MAOS consists of a MOS and supporting taxiways or access routes.

**5.2. Overview.** This chapter provides guidance for accomplishing airfield damage assessment operations. Organization, team composition, and equipment are described as well as assessment techniques and damage recording and reporting procedures.

**5.3. General Information.** During base recovery, the EOC is responsible to the ICC for all base recovery and base support activities. The mission support group commander and a recovery staff of essential base support organizations typically man the EOC—including CE representatives, such as EOD, CBRNE, and MOS selection personnel.

5.3.1. Civil engineer functions performed in the EOC include directing damage assessment operations, recording and evaluating damage reports, plotting airfield damage locations, accomplishing MOS selection, developing repair plans, and directing recovery operations.

5.3.2. To shorten airfield restoration time, engineer damage assessment operations and explosive ordnance disposal/assessment operations will usually be accomplished jointly. Thus, the damage assessment team is organized to conduct ground assessments of UXO locations; pavement and navigational (NAVAID) damage; and aircraft arresting system condition. The assessments are conducted either on foot or from hardened vehicles.

**5.4. Team Composition.** An ADAT normally consists of one EOD technician, one engineering specialist (usually an engineering craftsman), and one or more augmentees to assist in vehicle operation, recording information and communicating data to the EOC. Due to the length and width of the assessment areas, more than one ADAT will usually be required; three teams are typical. The exact number of teams necessary is a decision made by the BCE. Each ADAT works to locate and identify UXO and pavement dam-



age. Explosive ordnance disposal expertise is necessary to accurately identify and classify UXO, perform limited “render safe” procedures on selected ordnance, and oversee activity in the hazardous UXO environment (as a general rule, “render safe” procedures are not performed unless two EOD members are present). The engineering craftsman will identify UXO coordinates and determine the location and size of craters, camouflages, spall fields, and other airfield pavement damage. Normally, the ranking member will be the team chief. However, regardless of rank the EOD technician is responsible for the team’s movement where UXO exists. Field test results have proven that, with practice, the damage assessment teams can estimate short distances (less than 100 feet), crater diameters, and spall counts with acceptable accuracy without tape measurements.

**5.5. Equipment.** ADAT equipment requirements will depend on the means by which they conduct damage assessment operations. For example, a team conducting damage assessment activities on foot will have different requirements than a team conducting damage assessment activities from a vehicle. In addition to chemical warfare defense ensembles, each team member may require specific equipment to perform a particular function. Explosive ordnance disposal personnel should reference appropriate operating instructions and technical orders to determine equipment requirements. The following equipment is recommended for engineering craftsmen and should be preassembled as part of the ADAT deployment kit:

5.5.1. Safety ropes for approaching a camouflaged.

5.5.2. Data recording and reporting equipment to include base grid maps (both a 1” = 400’ crash grid map and a 1” = 100’ airfield pavement map with runway and station posts indicated), damage assessment forms, clipboards, writing instruments, radios, and spare radio batteries. When possible, include current site development tools, such as GPS systems and laser equipment, to allow both faster and more accurate recording and reporting of pavement damage.

**NOTE:** Before using equipment that emits signals for damage assessment (such as GPS systems and lasers), get approval from the EOD technician.

5.5.3. Binoculars and night vision devices to improve detection capabilities in low visibility conditions.

5.5.4. Other damage assessment enhancing equipment to include explosion-proof plastic-cased flashlights; nonmetallic measuring tapes; marking tape; flags and UXO markers.

5.5.5. The damage assessment team should also develop a non-electronic reporting system (runner) and should include any additional items needed for this purpose in the equipment list.

**5.6. Pavement Reference Marking System.** Use current tracking tools such as GPS and geobase maps to the greatest extent possible to quickly identify damage and UXO locations using the MGRS. When such tools are not available, or if EOD technicians recommend against using them, use the pavement reference marking system for successful postattack communications when locating damage. This reference system should be in place prior to the attack and be able to withstand the effects of an attack. Furthermore, to achieve maximum effectiveness, the pavement reference system should be employed on all takeoff and landing (TOL) surfaces and their associated access routes and used as a manual back-up system when GPS is the primary source.

5.6.1. A zero point is established for each pavement surface. Damage and UXO can be located with this reference system by identifying how far down the pavement they are from the zero point and how far they are right or left of the centerline. To eliminate the need for time-consuming measurements,

markers provide a visual cue that ADATs use to locate the damage and UXO. These markers are painted on the pavement surface at 50- or 100-foot intervals along the centerline and along each pavement edge starting at the zero point. Additionally, raised markers are placed at 50- or 100-foot intervals at a distance between 25 to 50 feet from the edge of the pavement. This duplication and spacing away from the pavement edge helps ensure the reference system remains usable following an attack and actual recovery operations. Normally, placement of these raised markers is accomplished as part of preattack preparation and is included on the engineer DCC checklists. Three basic rules need to be followed when using the pavement reference marking system:

5.6.1.1. Zero Point Rule. For an airfield pavement section, the zero point is fixed. It does not switch from one end of the pavement to the other. The zero point is usually established at the runway threshold where normal aircraft operations occur.

5.6.1.2. Centerline Rule. All distances along the length of the pavement section are measured along the centerline from the zero point for that pavement.

5.6.1.3. Right/Left Rule. Right and left of the centerline are determined as the ADAT faces down the centerline of the pavement and moving away from the zero point. **Figure 5.1.** illustrates a typical pavement reference marking system and how the three basic rules are employed.

**5.7. Damage Assessment Data.** During damage assessment, ADATs must gather two types of information—location of pavement damage caused by bombs, rockets, etc., and UXO data. Unexploded ordnance must be accurately located, reported, and recorded in sufficient detail for the EOC explosive ordnance disposal representative to determine the risk to aircraft operations. Include the following information in the UXO report: location, quantity, size, shape, color, distinctive markings, and fuse type and condition. All UXO within 300 feet of repair operations or aircraft operating surfaces must be identified and reported (and any obvious visible hazard at a greater distance that may threaten ADR operations). Holes of entry for subsurface UXO and camouflet craters must also be reported. Thus, scaled drawings must show sufficient adjacent area to include a 300-foot UXO radius-of-effect zone for paved surfaces and crater mat assembly areas.

5.7.1. Pavement damage within potential MOS candidates will also be recorded on the same drawings as the UXO reports (**Figure 5.2.**). NOTE: **Figure 5.2.** shows limitations associated with each possible class of pavement damage. However, for airfield ADAT reporting purposes, a crater has a sole identification of “C.” This added information has been provided for those who are interested in seeing a pictorial of the limitations associated with each class of pavement damage.

Figure 5.1. Typical Pavement Reference Marking System.

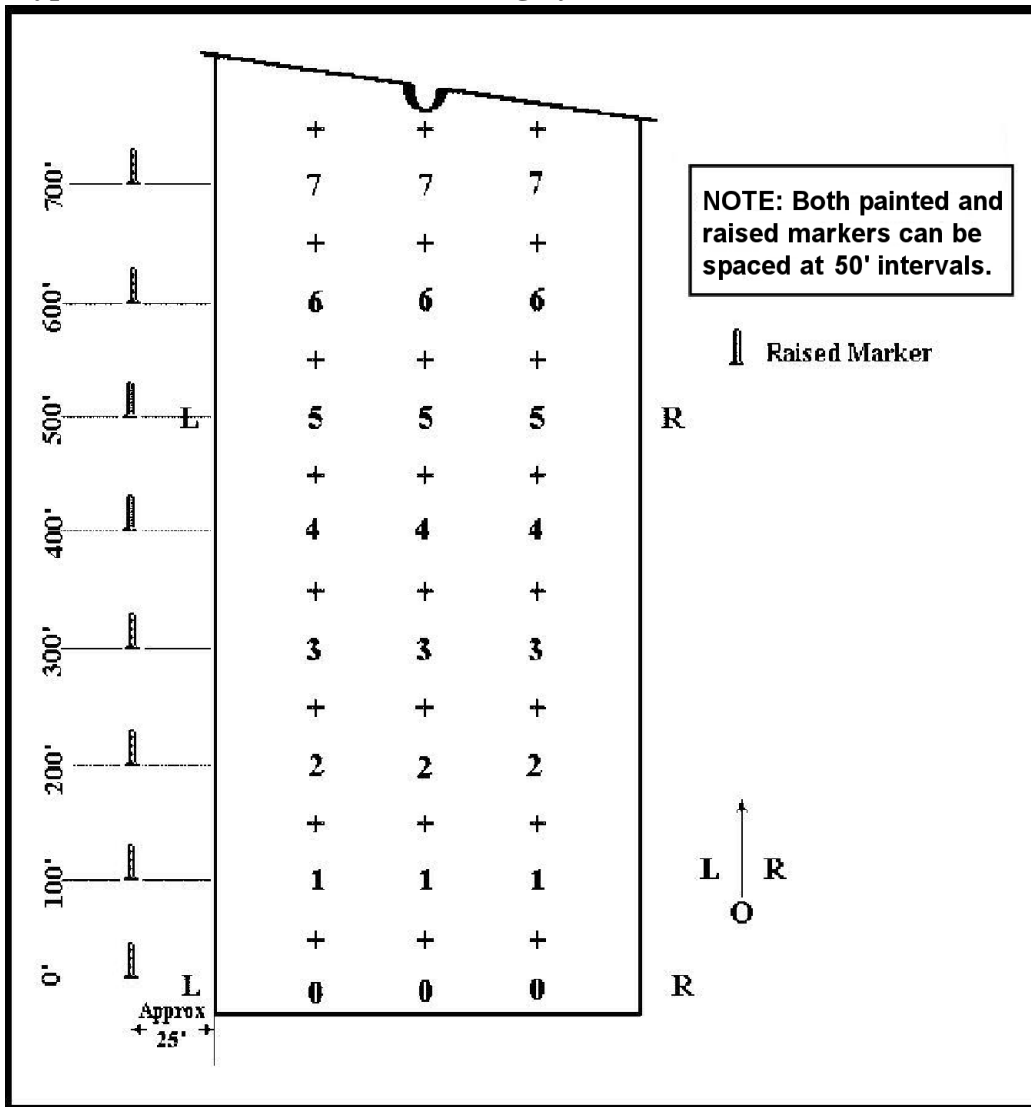

5.7.2. The following information should be included in each ADAT report: damage type (crater, spall, crater, spall or bomblet field, et c.); location (by grid coordinates or in relation to known reference markers); size (crater diameter; crater, spall, or bomblet field dimensions, etc.); and number (of craters, spalls or bomblets in a field).

**5.8. Assessment Technique.** Current base recovery planning is based on a two-phased damage assessment activity: Phase I: initial reconnaissance; and Phase II: detailed damage assessment. In Phase I, an initial gross assessment is made from prepositioned locations around the airfield. These locations can be manned locations which are usually splinter protected and elevated to afford clear visibility or unmanned tools such as camera systems, mini-UAVs, or other remote tools to get a runway "quick look." From these vantage points, trained personnel can quickly locate areas with UXO and pavement damage on the airfield. The results of the preliminary survey help the EOC quickly direct the ADATs to those areas requiring detailed damage assessment or avoid areas which are apparently too heavily damaged to warrant consideration in MOS selection during the initial efforts. In Phase II, where detailed damage assessment is con-

ducted, the damage assessment teams follow a predetermined EOC-directed travel route from their staging location to their area of responsibility. When the MOS selection team has analyzed the data from Phase I, they will exercise positive control of the ADATs. The ADATs, then under the direction of the EOC, report the extent and location of damage from the areas directed to or along their predetermined route. Detailed damage assessment requires locating damage more accurately than the initial reconnaissance, because these reports are the basis for MOS selection.

**Figure 5.2. Types of Pavement Damage.**

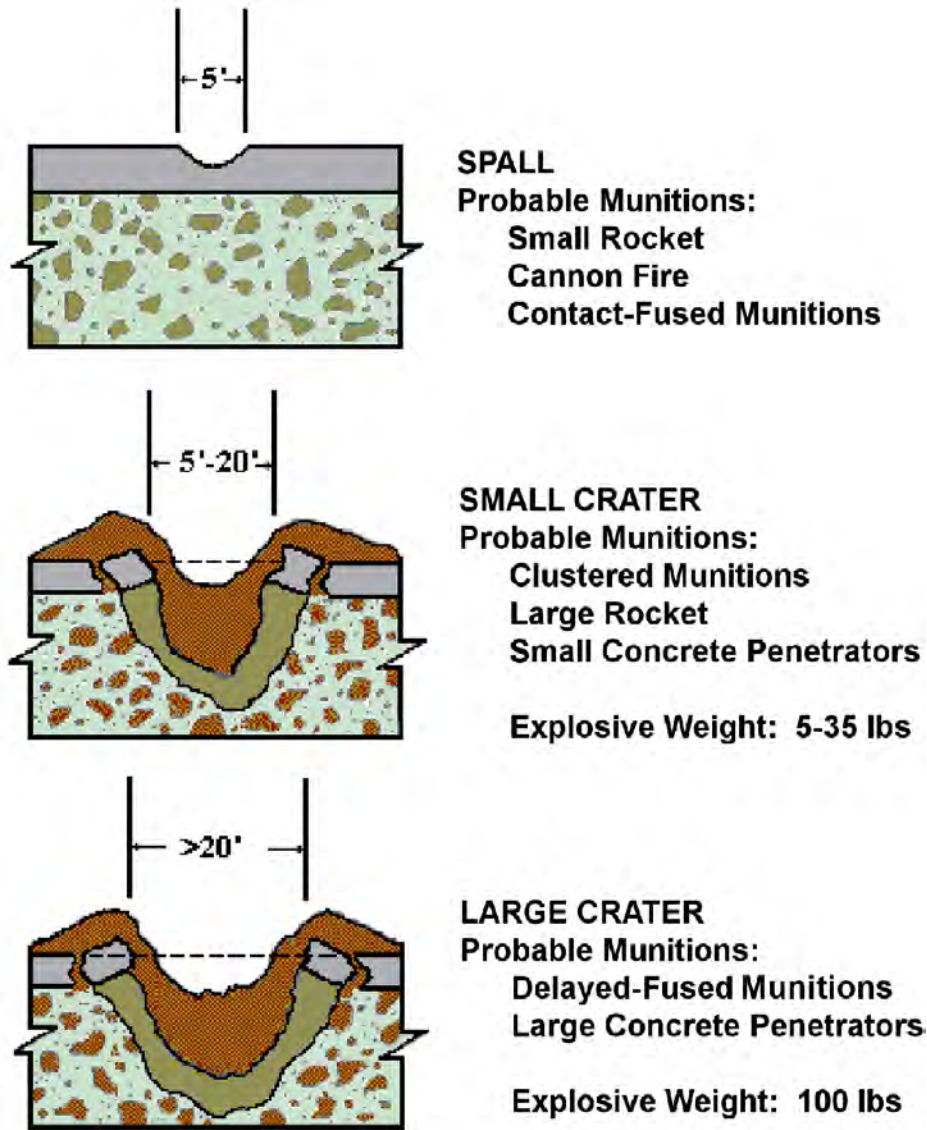

**5.9. Initial Reconnaissance (Phase I).** The purpose of Phase I, initial reconnaissance, is to assess the post-attack environment quickly in order to identify the areas of pavement damage

5.9.1. Precise damage locations or measurements are not expected because most of the Phase I observations are made at some distance from the damaged area. Personnel trained in MOS selection should make the initial reconnaissance from pre-selected manned observation posts and/or from camera feeds, pictures, or other remote devices. Examples of observation tools and locations are the control

tower, flightline camera systems, air base point defense positions, aircraft shelters, overflights, mini-UAVs, or other specific airfield vantage points. When hostilities are imminent, personnel will be assigned to those observation posts. After the attack, these individuals make visual observations and report the size and location of all damage as quickly and accurately as possible. Reporting procedures will depend on preattack instructions and available communications. Some observers may report directly to the EOC, while others report to their organizational control center. For example, security forces observers may report directly to the security forces base defense operations center, which would then relay the damage report to the EOC.

5.9.2. For any UXO threatening the launch and recovery surfaces, individuals should attempt to provide information regarding the size, location, color, condition, etc., of the munition. Also, the extent of pavement damage should be reported. From these observations and the resulting initial reports, pavement areas showing promise as possible MOSs may become readily apparent.

**5.10. Detailed Reconnaissance (Phase II).** Phase II damage assessment will be extremely hazardous and may be time consuming, depending on the level of damage. Since the extent of potential damage is most likely an unknown, several damage assessment teams (usually at least three teams) are designated prior to an attack and dispersed to protected locations on the base. Dispersal is important to ensure ADATs are available following an attack to conduct the vital first step in establishing an operational runway. Immediately after an attack, the EOC relays damage assessment instructions to each ADAT. This message is normally transmitted by radio and will include initial reconnaissance information, any changes to assigned damage assessment routes (to include new checkpoints), and any special instructions necessary to define the task at hand. ADAT travel routes are normally identified during preattack planning. Preplanned routes prevent wasted time by ensuring different teams do not assess the same areas. If appropriate, the EOC can modify the routes based upon the incoming initial assessment information. Since the primary purpose of airfield damage assessment is to ascertain the status and repair requirements associated with airfield pavement surfaces, the preplanned routes (and any successive modifications by the EOC) should take the ADATs from their personnel shelters to the ADR staging area and then to the airfield areas. This approach ensures ADR teams have a relatively safe and clear path from their dispersed locations to the staging area and subsequent entry to damaged airfield locations. To achieve this outcome logically, the ADATs should be sheltered close to the ADR team dispersal sites and the ADR equipment should be dispersed with easy access to ADAT routes. These are not difficult feats to achieve, but they do entail some degree of preplanning.

5.10.1. The success of the damage assessment operation depends on dedicated communication links and strict communication procedures to ensure accurate transmission of damage information. The current concept calls for separate EOD and CE radio nets for transmission of this information. The EOD and CE representative on each ADAT will transmit UXO and damage information to the EOC. With several ADATs passing information to the control center over these radio nets, as well as other CE and EOD personnel around the base, the potential for confusion is great. It is essential to use clear and concise radio transmissions while maintaining strict radio discipline. Unnecessarily keying the mike, transmitting unorganized thoughts, and interrupting other transmissions will necessitate the repeat of transmissions, which results in the delay of MOS selection and repair operations. Radio communications are usually quick and generally effective, but can be jammed or intercepted if not secured. If secure communications are unavailable, procedures, such as a runner system, should be preplanned to address these problems. The use of runners will increase the time to pass information to the EOC, but will still get the job accomplished.

5.10.2. Detailed reconnaissance may be conducted using two possible damage assessment techniques—vehicular or manual. Both require substantial CE support.

5.10.2.1. Vehicle Damage Assessment System (VDAS). The VDAS provides the most speed and protection for the ADAT and is the primary method of detailed reconnaissance. Ideally, the VDAS uses armored vehicles to transport ADATs between UXO and crater locations while providing protection from UXO blast and fragmentation effects. These benefits are not provided without some cost to system effectiveness. Visibility from inside the vehicle is restricted by the armor protection. This may require ADATs to use binoculars in order to locate and identify UXO and damage from greater distances. This limitation contributes to errors in reporting the size, position, and identification of UXO and damage. The accuracy of this method will vary from person to person. Observation distance, weather conditions, time of observation (night or day), and other human factors such as fatigue and fear will affect the accuracy.

5.10.2.1.1. Hardened Vehicles. Hardened vehicles, such as the M113A2 armored personnel carrier and the up-armored high mobility multipurpose wheeled vehicle (HMMWV) shown in [Figure 5.3.](#), provide protection from the UXO environment. If a hardened vehicle is not available, substitute with dump trucks or a hardened rapid runway repair vehicle. Pickup trucks and similar vehicles do not provide the same measure of protection as do hardened vehicles; however, these vehicles may be reinforced with sand bags, plexiglass, plywood, etc. The ADAT composition for the VDAS will vary with vehicle capacity, but should generally be the same as the MDAS team composition discussed earlier. As is the case with a MDAS team, the EOD experts are responsible for identifying UXO and safest travel routes. The engineering craftsman is responsible for identifying the damage to airfield pavements, airfield lighting, aircraft arresting system, utility systems, etc. Augmentation personnel will assist the other team members as needed and usually are trained to serve as the vehicle operator for the team.

**Figure 5.3. VDAS in Up-Armored HMMWV.**



5.10.2.1.2. VDAT General Guidelines. Some general guidelines for vehicle-based damaged assessment are as follows. The best travel route will normally be along the pavement center-



line. This route gives equal visibility to both sides of the runway and allows ADAT personnel to sweep the area visually forward and to the sides of the vehicle. Obviously, a meandering path may be required to avoid UXO or pavement damage. When this is necessary, the team must be careful not to miss damage or UXO on the side of the runway. Because the vehicle is used for protection, the damage assessors should remain inside except for extreme cases where remaining in the vehicle would gravely hamper the assessment effort. An example of such would be a scenario where extreme damage has destroyed the pavement reference system. In this case, the assessors would have to estimate the distance from the nearest remaining reference marker to assure the required accuracy. Specific procedures for vehicle-based damage assessment of various types of UXO and damage are detailed in the following paragraphs.

5.10.2.1.2.1. Large UXO. When the ADAT sights a large UXO on the runway surface, the damage assessment vehicle will move off the runway centerline and approach on the far runway shoulder edge (Figure 5.4.). The ADAT will then stop and record as much of the following information as possible: location, number, shape, color, weight, markings, coordinates, and estimated render safe time.

**Figure 5.4. Single Large UXO Assessment.**

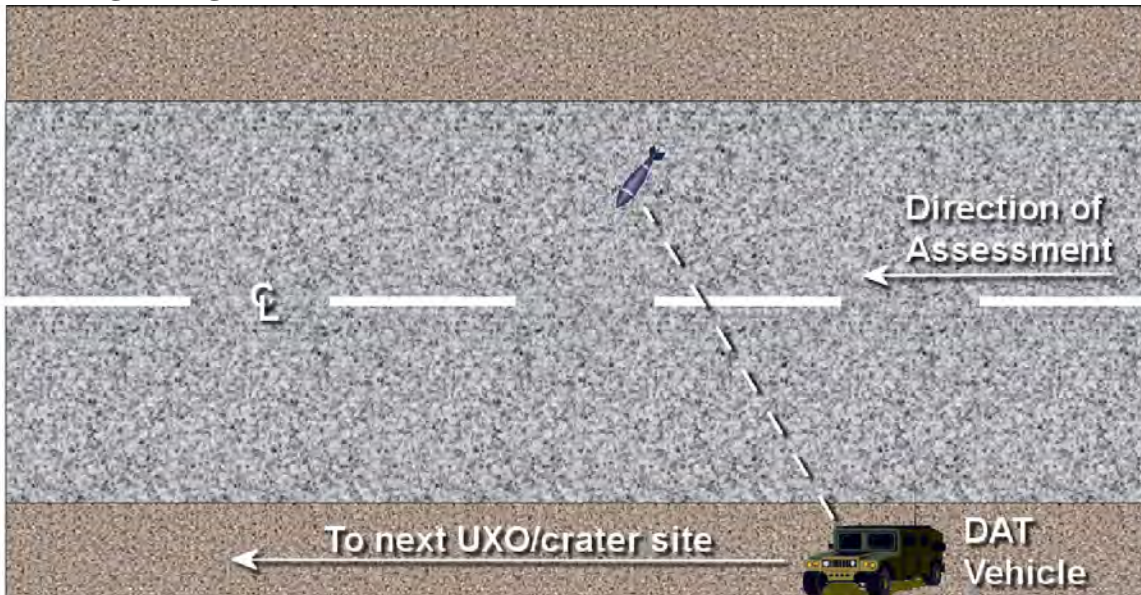

5.10.2.1.2.2. UXO Field. When the ADAT sights a bomblet, or group of bomblets, they should approach the closest ordnance (Figure 5.5.) at a safe distance and record the following information: number, shape, location, field width, field length, color, markings, and render-safe time. When this information is recorded and reported to the EOC, the ADAT should drive past the field in such a manner to provide the maximum standoff distance between the UXO field boundaries and the team.

5.10.2.1.2.3. Bomb Crater/Camouflet. Craters are generally divided into two broad categories, large (greater than 20 feet [6 meters] in diameter) and small (20 feet in diameter or less). In either case, when bomb craters or camouflets are detected during vehicular damage assessment, the ADAT should approach the area with caution. If the area appears to be free of UXOs, move close enough to the crater(s) to perform damage assessment and verify there is not UXO in the bottom of the crater.

Figure 5.5. UXO Field Assessment.

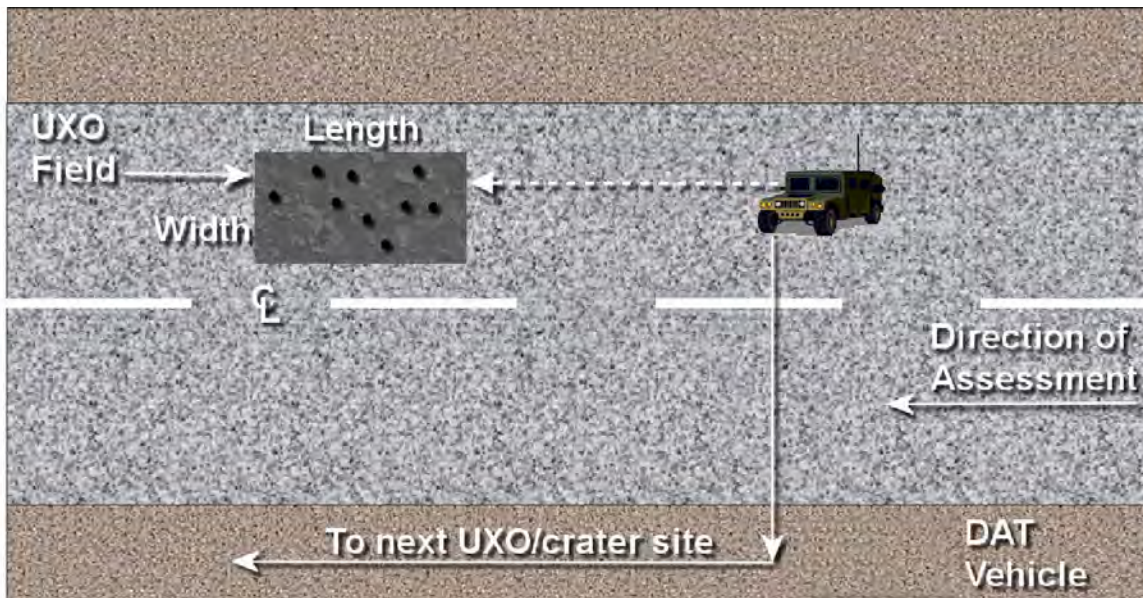

5.10.2.1.2.3.1. Large Craters. Coordinates for the center of each crater and the apparent crater diameter will be recorded. If a camouflet is discovered, its coordinates and the size of the entry hole will be recorded. Data on craters, UXO, and camouflets will be immediately relayed to the EOC. This immediate reporting procedure not only aids in hastening the MOS selection process but also serves to keep the EOC staff aware of the team's position on a frequent basis.

5.10.2.1.2.3.2. Small Craters. Small craters may be numerous or few, depending on the weapons system employed. If there are only a few, follow the same guidance as for reporting large craters. However, if there is a large number of small craters, such as would be caused by sub-munitions, the team should consider calling them in as a field, like a spall field, or mix of a field and individual craters. The decision of which method to use must reflect the balance between speed (calling in many grouped small craters individually will use a lot of time and tie-up radio frequencies) and accuracy of the picture in the EOC (if the field is too broad or spread out, it will not give the ICC enough information to make a good MOS selection). A rule of thumb is that if the crater is further than 2 ft from the adjoining craters, it should be called in individually, and if they are clumped together closer than 2 ft apart, consider the grouping as a small crater field and report it as you would a spall field by counting the number and type(s) of craters and approximate apparent depth and report the data. Be careful to observe likely UXOs in the field as well as spalls and record/report this data as well. Provide the MOS plotters with as much of a picture as possible; for instance, if the field is 100 feet wide, but 80% of the craters are in the left-of-center 50 foot section, say so in your report.

5.10.2.1.2.4. Crater Fields. Small craters located close together where there upheaval joins the neighboring crater should be reported as a crater field. Crater fields are similar to bomb craters and should be carefully examined from a distance for the presence of UXO. If no UXO is sighted, the ADAT should move the vehicle into the area and record the following information: center coordinates for the leading and trailing edges, leading and trailing field widths, and number of craters within the field.



5.10.2.1.2.5. Spalls. Spall fields are similar to bomb craters and should be carefully examined from a distance for the presence of UXO. If no UXO is sighted, the ADAT should move the vehicle into the area and record the following information: center coordinates for the leading and trailing edges, leading and trailing field widths, and number of spalls within the field. Because spalls are not highly visible even at close range, spall counts and field dimensions may be difficult to determine, especially since spalls are likely to be covered with debris.

5.10.2.1.2.6. Bomblets. Bomblet fields are similar to spall fields and should be carefully examined. The ADAT should record the following information: center coordinates for the leading and trailing edges, leading and trailing field widths, and number of bomblets within the field.

5.10.2.1.2.7. Multiple Ordnance/Damage Sites. It is also possible that a ADAT will encounter a situation where damage and UXO presence are so severe that continuation of the planned assessment run is impossible. Before attempting a circuitous route to reach the other side of the blocked area, the ADAT should inform the EOC of the situation. The EOC may see a pattern developing, based on the damage reported, which allows adjustment of travel routes to have a different ADAT finish assessing the affected pavement area ([Figure 5.6](#)). In this type of situation, both ADATs would assess damage from their respective sides of the blockage and report their findings back to the EOC. The EOC, in turn, would plot a composite of the area and, in all likelihood, develop a reasonably accurate picture of the damage sustained.

**Figure 5.6. Multiple UXO/Damage Assessment.**

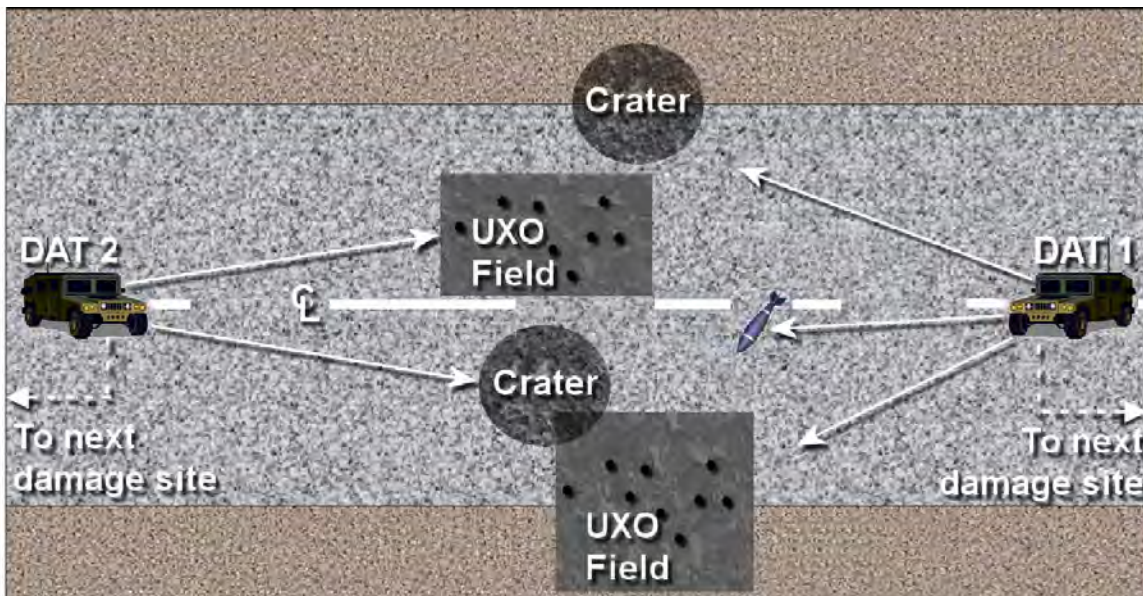

5.10.2.2. The manual damage assessment system (MDAS) is a slow and hazardous damage assessment method that requires the runway-taxiway surface to be surveyed on foot. Damage assessment team members walk specified areas of the runway to identify and locate UXO, pavement damage, and damage to support systems. Normally, this is accomplished with help from the pavement reference marking system. Make distance measurements by visual estimation or pacing,

whichever is most appropriate for the situation, from known runway or taxiway locations, by estimating crater dimensions, and by visually determining UXO identifying features. In addition, the team should specify if there is adequate pavement for taxing aircraft to bypass taxiway damage so repairs can be delayed until a more opportune time. Although the MDAS is the most accurate damage assessment method, it is extremely time consuming and exposes ADAT members to UXO fragmentation and blast hazards. Actions of the individual team members are outlined in the following paragraphs.

5.10.2.2.1. As addressed earlier, the EOD expert is responsible for the overall definition of safe travel routes through hazardous areas. The EOD member assigns areas or lanes of responsibility to each of the augmentees. As the team progresses through its area of responsibility, the EOD representative assists the augmentees in the proper identification of UXO and relays pertinent information to the EOC.

5.10.2.2.2. The engineering team member has the overall responsibility for damage assessment. The engineering craftsman may be assisted in damage location and recording by one or more augmentees. However, as stated earlier, in areas of extreme bomb damage, the EOD representative typically takes charge of the damage assessment team to ensure all pertinent information is gathered, recorded, and relayed back to the EOC.

5.10.2.2.3. Augmentees are responsible for following the safe routes identified by the EOD member and identifying all pavement damage and UXO locations in the assigned area. Any identification problems are reported to the EOD or CE representative for resolution. Augmentees may also assist the EOD and CE members in transmitting information to the EOC. If a runner system must be implemented because of communication difficulties, the augmentees are usually called upon to serve as runners.

**5.11. Priorities.** As mentioned earlier, ADAT travel routes are normally predetermined to start at the ADAT personnel shelters, move to the ADR staging area, and then head toward the more critical aircraft pavements. These routes are updated or altered as required based on initial damage assessment reports. Generally, the EOC will have selected ADAT travel routes so that the airfield is surveyed in the following priority:

- 5.11.1. Takeoff and Landing Surfaces. This includes runways, alternate launch and recovery surfaces, and taxiway segments that are long enough to permit aircraft launch and recovery.
- 5.11.2. Access pavements to launch and recovery surfaces.
- 5.11.3. Aircraft shelters and parking areas.
- 5.11.4. NAVAIDS.
- 5.11.5. Aircraft arresting systems.
- 5.11.6. Aircraft maintenance, rearming, and refueling areas.
- 5.11.7. Other EOC specified locations.

**5.12. Locating Damage.** Specific crater locations on the takeoff and landing surfaces and the primary taxiway access are critical to restoring the flying mission. When available, use GPS and the MGRS to accurately locate and report damage. Installations already have very specific grids for the takeoff and landing surfaces and use the crash grid for large craters and installation damage much as they use in



Figure 5.8. Data Report and Plot of Damage.

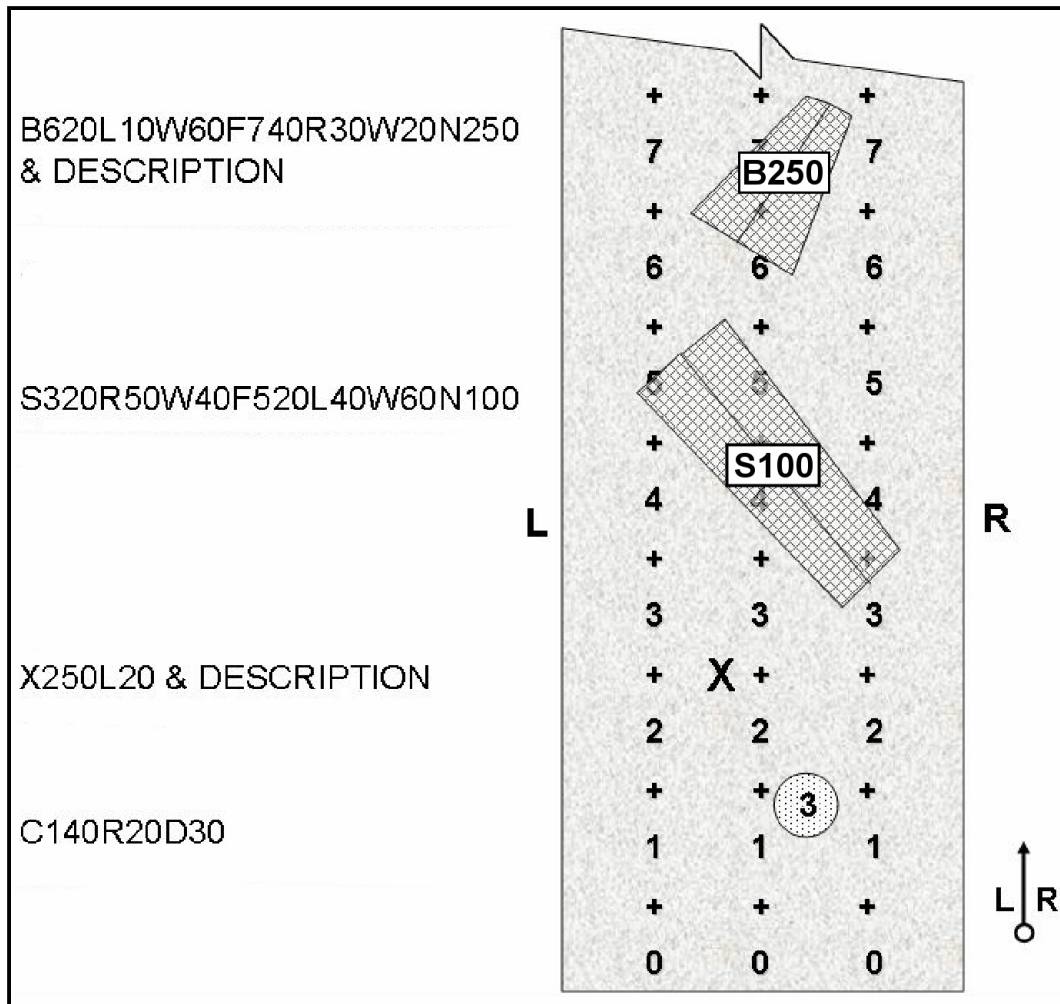

- 5.13.1. Type of Damage or Ordnance. Enter damage or ordnance type here, using a letter coding such as “C” for crater, “X” for UXO, “S” for spall, and “B” for bomblet.
- 5.13.2. Distance Down Pavement. Distance from the zero pavement reference point to the center of the crater, UXO, or to the closest leading edge of the spall or bomblet field.
- 5.13.3. Direction L or R of Centerline. “L” stands for left, “R” stands for right. They denote the direction from the pavement centerline to the damage/UXO center point.
- 5.13.4. Distance Left or Right. This is the numerical distance expressed in feet.
- 5.13.5. Diameter or Width. For craters or circular spall and bomblet fields, enter the letter “D.” For rectangular spall or bomblet fields, enter the letter “W.”
- 5.13.6. Size of Diameter or Width. This is the numerical estimation of the apparent diameter or field width for that point along the pavement.
- 5.13.7. Field Identifier. If required, enter the letter “F” to alert the EOC that the following information completes the leading edge description of a spall, small crater, or bomblet field. The next alphanumeric group after “F” stands for the same as above and describes the trailing edge of the field.



5.13.8. Number Identifier (N). The letter “N” alerts the EOC that the field identifier is completed and that the next number is the number of spalls, small craters, bomblets, or a mix.

5.13.9. Number of Bomblets, Small Craters, or Spalls. The numerical estimate of the number of bomblets, small craters, or spalls in the field previously identified. If it is a mix, show the total number first followed by the breakdown by type. For instance, if the spall field in [Figure 5.8](#). was a mix of 50 small craters, 25 spalls, and 25 UXOs; it would be reported as: C320R50W40F520L40W60N100(C50X25S25). Note the field designator to the more challenging problem of craters.

5.13.10. Description. Record any additional information that would be helpful in accurately identifying the pavement damage (diameter, depth, and type of small crater) or ordnance (i.e. color, shape, bands, size, features, etc.).

**5.14. Double Point Damage Plotting Steps.** Once the information identified by the damage assessment teams is forwarded to the EOC, it must be correctly plotted in order to determine its impact on the MOS selection process. Normally, a process called double-point plotting is used for spall and bomblet fields. The steps involved in conducting double-point plotting are shown below and in [Figure 5.9](#). Additional information regarding damage plotting and specific considerations applied during the MOS selection procedure are presented in [Chapter 6](#) of this volume.

**Figure 5.9. Double Point Damage Plotting.**

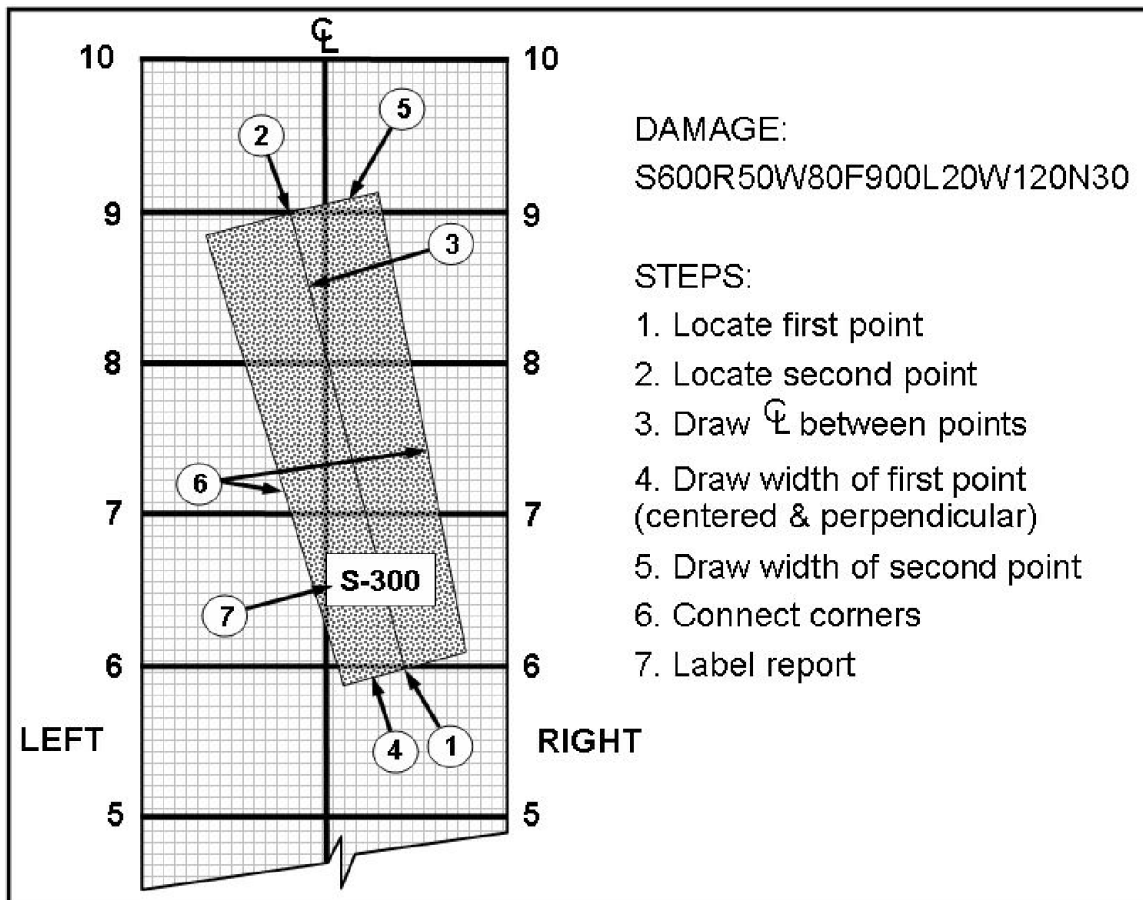

- 5.14.1. Step 1—Identify specific type of damage (usually spalls or bomblets) and determine distance down the runway for the first point, distance left or right of centerline, and locate the point.
- 5.14.2. Step 2—Determine distance down the runway for second point, distance left or right of centerline, and locate point.
- 5.14.3. Step 3—Construct centerline of field by connecting first and second points.
- 5.14.4. Step 4—Plot beginning width, centered and perpendicular to centerline of the field.
- 5.14.5. Step 5—Plot ending width, centered and perpendicular to centerline of the field.
- 5.14.6. Step 6—Connect corners of end lines.
- 5.14.7. Step 7—Label the report.

**5.15. Chapter Summary.** Damage assessment forms the foundation for prompt and effective base recovery actions. Two primary types of teams that involve civil engineers are used in this activity. ADATs, controlled by the EOC, concentrate on airfield pavement damage assessment so that ADR teams can provide a MOS and access taxiways for combat aircraft as quickly as possible. On the other hand, teams called DARTs are controlled by the engineer DCC and respond to damage assessment requirements associated with base facilities and utilities. If effective damage assessments are to be realized, both ADATs and DARTs must be comprised of qualified, experienced personnel; be provided adequate communications, transport, and protective equipment; and be completely knowledgeable of damage assessment procedures. In addition, a pavement reference marking system, used to identify the locations of damage and UXO on airfield pavements, must be employed if the airfield damage assessment process is to be within the required accuracy. The success of subsequent ADR activities, to a large degree, hinge upon the accuracy of the damage assessment teams efforts.

## Chapter 6

### MINIMUM OPERATING STRIP (MOS) SELECTION PROCEDURES

**6.1. Introduction.** If an enemy attacks an air base, the commander's immediate problem is to launch and recover mission aircraft as soon as possible after the attack. The BCE must recommend the “best” airfield surfaces to repair—those that require the least repair time but still provide adequate launch and recovery surfaces for mission aircraft. The launch and recovery surface selected for repair is called the MOS. The MOS is the area where aircraft actually takeoff and land and its dimensions are determined by the ICC Commander. The actual dimensions of the MOS vary with aircraft type, operation, and weights as well as environmental conditions. When a MOS is combined with access taxiways from aircraft staging areas such as shelters and parking ramps, the entire area becomes the MAOS. Most of the information presented in this chapter will focus upon MOS considerations. However, be aware that a MOS cannot be selected without a full appreciation of the extent of damage throughout the entire MAOS. For example, if an ideal MOS is identified that involves a minimum repair effort, finding acceptable access routes to that location should also be taken into account. If necessary, transitional taxiway routes may have to be constructed, assuming that the tradeoff in resource expenditure justifies the efforts. In addition, RQC should be considered as part of the selection process. This is not to imply that the MOS selection team will include RQC calculations as part of their MOS selection process. Rather, it means that the team should be familiar enough with the RQC process to be able to apply fundamental RQC requisites indirectly when seeking the best MOS candidates. Confusion can often be avoided between the closely related acronyms MOS and MAOS, if you do not become a “definition purist.” When used to describe situations, both terms frequently overlap one another. Keep these points in mind as you progress in this chapter.

**6.2. Overview.** This chapter serves as a guide for Airmen who must choose candidate MOSs. Divided into two major parts, the chapter provides a broad picture of the MOS candidate selection process, to include concept of operations, team organization, sequence of the selection steps, and characteristics of a good MOS. The second major part of this chapter contains detailed procedures for MOS selection. An illustrated example of MOS selection is also presented. Common MOS selection terms are contained in **Attachment 1** (Terms Explained).

6.2.1. Engineer Activities. When an airfield is attacked, engineer personnel will respond with four kinds of activities:

- 6.2.1.1. Damage assessment.
- 6.2.1.2. Identification of candidate MOSs.
- 6.2.1.3. Safing and disposal of explosive ordnance.
- 6.2.1.4. Repair of attack damage.

6.2.2. Event Order. Damage assessment, covered in the preceding chapter, provides information about the location and extent of damage to the surfaces of the airfield. The ICC provides other information on operational requirements and expected operating conditions following the attack. Using all this information, the MOS selection team locates potential operating strips to be repaired and recommends MOS candidates to the ICC commander. After the ICC commander approves a specific MOS, the EOC commander directs the explosive ordnance disposal teams work on the areas designated to be cleared. Finally, the ADR teams begin to repair craters and spalls, clear debris, repair airfield collat-

eral damage, and mark the MOS location. These activities are discussed in depth in subsequent chapters of this document. Since much of the success of the MOS selection procedure depends on advance training, personnel should be thoroughly prepared. All engineer, EOC, and DCC team members must be familiar with MOS selection procedure and understand each of its phases. Suggested MOS selection kit contents are outlined in paragraph 7.7. of this volume.

**6.3. Concept of Operations.** The current base recovery concept calls for a primary and an alternate EOC. Both EOCs will have a MOS selection team assigned and will simultaneously perform MOS selection. This provides a double check on proposed MOS candidates and allows smooth transfer of control in the event that the primary EOC is incapacitated.

6.3.1. The MOS selection team will receive the damage and UXO information provided by the ADATs and then identifies acceptable MOSs. In the primary EOC, a CE representative will record data items, such as crater and spill damage. Using a different radio frequency, the EOD representative in the primary EOC will record UXO type, location, and fuse data. Airfield damage and UXO locations will be plotted on the MOS selection map. In the alternate EOC, the same information is recorded by the CE representatives and plotted on their equivalent MOS selection map. The ICC provides other information on operational requirements, such as expected weather conditions, aircraft loads, desired MOS length and width, and arresting system requirements. In today's basing strategies, installations often support a variety of aircraft which may have different MOS requirements and priorities which must be considered in MOS selection recommendations. Therefore, the EOC should request an OG representative to help with MOS selection who understands the current and near-future ATO requirements and the aircraft characteristics for the currently assigned aircraft to help determine the right MOS requirements. As data is reported, MOS selection procedures are conducted so that when the last ADAT reports are received, the MOS candidate selection process is nearing completion. Upon completion, three candidate MOSs are recommended to the ICC commander, of which the best candidate of the three is typically chosen. It is a good idea to have a couple of alternate MOS possibilities available in case previously unknown operational requirements surface which impact the suitability of the originally recommended MOS. At bases where there are two (or more) runways/primary takeoff and landing surfaces, MOS selection should consider both surfaces. The team should work with the operators to provide the ICC with the greatest post attack capability in the shortest time. This could mean two MOSs, one on each runway, for different aircraft types (e.g. fighter and cargo), or one launch and another for recovery in order to get planes in the air quickly and then focus on recovery on a timeline to support their return.

6.3.2. After the MOS has been selected by the ICC commander, the BCE will direct the DCC to prepare relocation of the ADR equipment from the dispersed locations to the appropriate staging area and prepare for the commencement of airfield repair activities. At the same time, the EOC commander will direct EOD personnel to begin the safing, removal, and/or the "leave alone" UXO activities. This will invoke the employment of EOD teams for render-safe procedures and clearing submunitions from the MOS and other areas of repair. Once ADR activities are underway, primary and alternate MOS selection teams will commence RQC calculations for the chosen MOS. It should be noted that the sequencing of the aforementioned activities is not essential. Many situations may develop that will necessitate adjustments. For example, it is plausible that a delay in the actual decision of which MOS to repair may allow the MOS selection team sufficient time to conduct RQC calculations on all MOS candidates beforehand. On the other hand, a route used from one of the ADR dispersal areas may be laden with UXO problems resulting in a noticeable delay before that equipment will be available to



contribute toward the recovery effort. Flexibility is essential to success of any complex undertaking and ADR is by no means an exception.

6.3.3. In addition to repairing the pavement damage, CE personnel will mark the MOS, install the EALS, and if necessary, install a MAAS. Minimum operating strip marking is normally required prior to launching sorties. Installing the lighting and arresting systems may be accomplished after air operations have begun, providing initial operations are in daylight hours and takeoff and landings can be accomplished without an arresting system. Both of these stipulations require approval by the ICC.

**6.4. Team Composition.** As a minimum, the MOS selection team is comprised of two personnel—one of which should be an engineering technician (AFS 3E5X1). The second team member serves as a radio operator and data recorder, while the engineering technician acts as a data plotter. CE leadership in the EOC should pay particular attention during this phase to ensure the MOS selection team does not become overwhelmed. Multiple ADAT teams, or large numbers of craters, may require augmenting the team to expedite plotting or receiving data by radio. If UXO is light, consider using the EOD frequency for one ADAT team's data reporting. Likewise, if other frequencies are underused at this phase of recovery, consider chopping them to the ADAT team/MOS Selection team to expedite MOS selection. The EOD representative in the EOC supports the two CE personnel by receiving and recording EOD related data from the ADATs and providing technical expertise on how UXO information should be displayed on the airfield maps. Both the primary and alternate EOCs will be staffed with similar teams. **Table 6.1.** provides further details on the EOC team's composition, skill requirements, and responsibilities. Be aware that the manning shown in **Table 6.1.** represents an ideal arrangement. Local situations may dictate a number of other manning configurations. **NOTE:** Additional information regarding the composition of the EOC team, of which the MOS selection team is a component, is outlined in AFPAM 10-219, Volume 1, Contingency and Disaster Planning.

**6.5. MOS Characteristics.** Simply stated, the goal of MOS candidate selection is to locate the best available MOS that can be repaired in the least amount of time. A good MOS has many characteristics, the ranking of which will depend upon the situation at a particular base that is attacked. Consequently, the MOS selection process must be flexible to identify the best option under a wide variety of circumstances. Generally, a good MOS will allow rapid restoration of launch and recovery capability. With either of the two currently approved ADR techniques, crater repair is a lengthy process. Thus, initially it is important to repair no more damage than necessary. This is the reason that it is worthwhile waiting for completion of airfield damage assessment before finalizing MOS selection. The MOS selection procedure is designed to choose a takeoff and landing area that is comparatively low in crater and spall damage. Repair time, therefore, is saved at the cost of initial delay caused by accurately identifying and plotting damage and selecting a MOS. While in the majority of cases the MOS with the least damage will be selected, this may not always be the situation—other consequential considerations could come into play.

**Table 6.1. EOC Team Organization.**

Position	Number of Personnel	Air Force Specialty	Required Skills	Responsibilities
BCE	1	32E3		Oversee engineer activities
Team Chief	1	32E3 or 3E5X1	Know MOS candidate selection criteria & RQC procedures.	
Plotter 1		3E5X1	Understand damage coordinates and plotting techniques	Plot data, select candidate MOSs, & calculate RQC
CE Radio Operator	2	3E5X1 or 3E6X1	Radio ops & data recorder	Receive/record data; assist with MOS selection
<b>Support Personnel</b>				
EOD Tech	1	3E8X1	Radio operations, data recorder, & technical EOD expertise	Receive/record data; provide technical advice
ADAT (per team)	1 3E5X1		Know airfield marking system, crater & spall damage assessment procedures. Also, be able to perform utility, facility, & NAVAID damage evaluations.	Assess pavement & supporting airfield systems damage & provide such data to the EOC.
	1 3E8X1		UXO identification	Provide EOD input to EOC.
	2 Augmentee		Vehicle operation/damage & UXO recording procedures	Operate ADAT vehicle & develop a "hard copy" re-report of information provided to EOC.

6.5.1. Resource Limitations. An ADR team's capability may be hampered by resource shortages and equipment deficiencies. The MOS selection team should consider any noticeable limitations when determining candidates. As reconnaissance reports are received in the EOC, the selection team must make a conscious decision to monitor the status of ADR equipment and materials and keep this information in mind during the MOS selection process. Engineer personnel in the alternate EOC and DCC should also monitor equipment and material status as a crosscheck for accuracy. As airfield damage assessment nears completion, a quick verification on equipment and material status between all control centers should be accomplished to ensure the most current information is being considered.

6.5.2. Sortie Capability. Aircraft should be able to get to a nd from the MOS quickly. If a MOS is selected without regard to sortie generation capability, aircraft operations could be restricted after MOS repair. The launch or recovery (LOR) status of an airfield measures sortie generation capability, independent of variables such as mission time, aircraft attrition, and origin of aircraft (aircraft may

launch at one air base and be recovered at another). A few examples of how various restrictions can reduce LOR capabilities are shown in **Table 6.2**. The example in **Table 6.2** shows that a MOS with two access taxiways that requires an aircraft to backtrack more than 2,000 feet will have an LOR capability of only 50%. Additional explanations of other common LOR restrictions are described below.

**Table 6.2. MOS LOR Capability.**

Two Access Taxiways	One Access Taxiway	Taxi Backtrack > 1,000 Ft.	Taxi Backtrack > 2,000 Ft.	Arresting System Engagement with Each Aircraft	Air Traffic Control Eqpt Not Functional	Relative LOR Capability
X						100%
X X						34%
X X					X	25%
X X						60%
X X						50%
	X					40%
	X X					27%
	X X				X	19%

6.5.2.1. LOR Status. The LOR status of a MOS is the total number of launches and recoveries the surface can handle per unit time compared to the number that could be handled by the same undamaged airfield. An LOR status of 100 per cent simply means that the MOS and its access route(s) are not restricting sortie capacity. Even if its LOR status is substantially less than 100 per cent, this does not necessarily mean that the MOS is limiting sortie capacity. Normal operations may not use the entire capability, and other factors in the base status after an attack may be even more limiting.

6.5.2.2. MOS Location. A MOS may be located on the main runway, on a parallel taxiway, or even on an alternate launch and recovery surface on or off base. The MOS location affects LOR status in various ways by limiting access and egress, by limiting air traffic control, or by restricting the flight approach of aircraft.

6.5.2.2.1. Air Traffic Control Limitations. The availability of NAVAIDS to control air traffic can significantly improve the LOR capability of a MOS. NAVAIDS provide pilots with the information necessary to locate the air base and the operating strip efficiently. NAVAIDS are also necessary to support operations when visibility is poor (including foul weather and nighttime).

6.5.2.2.1.1. Location Consequences. Location of the MOS has no effect on visual NAVAIDS such as emergency runway and airstrip lighting systems, since all these are portable and can be installed wherever the MOS is located. However, location of the MOS does affect the use of non-visual aids. If non-visual NAVAIDS are not present, aircraft can be recovered only when weather conditions are good.

6.5.2.2.1.2. Minimum NAVAID Requirements. The minimum NAVAID requirements for a MOS are tactical air navigation (TACAN)—a radio transmitter emitting 360 degrees, which the pilot uses to locate the airfield; and ground control approach (GCA)—a system which guides the aircraft onto a particular strip. The TACAN for the airfield will support any MOS, regardless of its location on the field. Ground control approach support can be provided to a MOS so long as neither the MOS threshold nor departure is located within 3,000 feet of the original runway threshold of any GCA-supported runway. If a MOS was selected on an airfield surface that did not meet this criterion, or if the TACAN or GCA facilities were damaged in the attack, LOR status could be degraded by as much as 25 percent. If both systems were inoperable, landing capacity would be reduced by as much as 50 percent. If a MOS falls outside the air traffic control range and portable equipment is unavailable or takes a long time to set up, the MOS selection team should be aware that LOR status may be further degraded.

6.5.2.2.2. Access/Egress Limitations. Inadequate access or egress forces aircraft to taxi on the MOS, resulting in excessive runway occupancy. At least two access routes are desired, preferably one at each end of the MOS. More limited access/egress may reduce LOR rates. Some of the more common access route limitations include:

6.5.2.2.2.1. Cul-de-Sac. The term cul-de-sac refers to the limiting factor whereby a taxiway access route requires an aircraft to taxi back on the MOS before takeoff or after landing.

6.5.2.2.2.2. Only One Access Route. A MOS with a single access route requires aircraft to taxi the length of the MOS before takeoff or after landing.

6.5.2.2.2.3. Taxi Distance. Selecting a MOS that is located off base or has a long taxiway route will reduce LOR capability and time to first launch. In addition, overheating of brakes could mean higher maintenance problems, and taxiing aircraft will spend more time in an exposed, vulnerable condition.

6.5.2.2.3. Arresting System Limitations. Operational requirements, landing with battle damage, shorter than desired landing surface, wet or icy conditions, or other emergencies may dictate arrested landings. Normally, the MAAS is used for wartime support of MOSs, since the probability of an in-place system being serviceable and in the correct place after an attack is low. The MAAS is capable of an aborted takeoff or arrested landing every 3 to 5 minutes. If an existing arresting system remains functional, is located longitudinally correct on the MOS, and is situated within the crater free restrictions, its pendant must span the MOS properly to pre-

vent an aircraft from being pulled to one side or the other after engagement. Off-center engagement capability for the MAAS and BAK-12 is half the distance to the runway edge from each side of the runway centerline. If the centerline of the selected MOS is within the off-center engagement capability of the existing system, the existing system can be used, but pilots must be cautioned to engage as near to MOS centerline as possible. If the MOS centerline is not within the off-center engagement capability of the existing system, the existing system cannot be used (see [Figure 6.1](#)). Regardless of whether a MAAS or an in-place system is operated, the compulsory use of an arresting system will reduce LOR status due to the time involved in arresting system recycling operations.

**Figure 6.1. Requirements for Use of Existing AAS.**

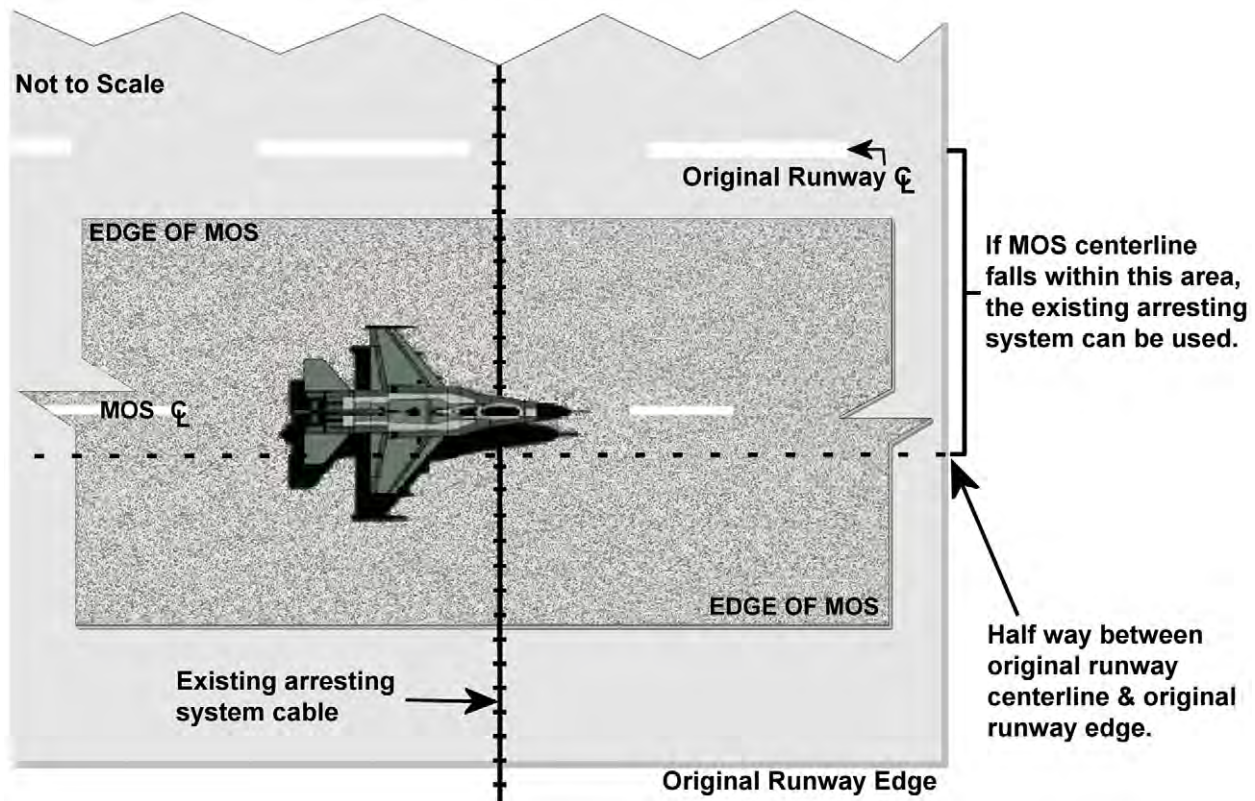

6.5.2.2.4. Other LOR Factors. Many other variables outside the control of the MOS selection team affect LOR status. A few examples include aircraft maintenance, fueling, arming, and pilot briefings.

6.5.2.3. Limitation Examples. [Table 6.2](#) gives the LOR capability of a MOS for various access limitations. Use it to help identify the impact your MOS candidate has on sortie capacity. As was addressed earlier, inadequate access forces the aircraft to taxi the length of the MOS, which results in excessive runway occupancy time. If taxiway repairs can be made while aircraft are using the MOS, you will probably recommend that the strip be declared operational after one access route is repaired. However, it may be that craters are located such that safety considerations preclude repairs to access taxiways during operations. In this case, your briefing to the wing commander should point out the tradeoff between increased LOR status and decreased recovery time. The commander can decide what percentage of full launch and recovery capacity is immediately required.

6.5.3. Low Probable Aircraft Damage. In spite of an earnest effort, the repaired MOS will most likely not be as smooth as the original runway. Restoring the surface to its original condition is too time-consuming. However, if the repairs are too rough, damage to aircraft structures and strut systems may result. The acceptable roughness of a MOS depends upon many factors: type of aircraft using it, aircraft weight and configuration, repair location length and spacing, and environmental conditions. Given these conditions, acceptable roughness for a particular repair depends upon location of the repair, the aircraft operation (takeoff or landing), and the velocity of the aircraft as it traverses that repair. Each of these factors is included as part of RQC addressed in detail in the next chapter of this pamphlet. However, a couple of key considerations are worthwhile discussing now since they substantially impact MOS operational characteristics.

6.5.3.1. Density Ratio (DR). Density ratio, a relationship between air temperature and pressure altitude, provides a baseline for potential aircraft performance. For high DRs (on cool days), aircraft performance will be good; during takeoffs, aircraft accelerate quickly, achieve high velocity and lift in a relatively short distance. Consequently, a MOS may be shorter when the DR is high. How quick an aircraft accelerates, decelerates, and generates lift are factors regarding how rough of a crater repair an aircraft can tolerate. These factors are taken into account during RQC calculations.

6.5.3.2. Repair Spacing. Another item to consider is the distance between repairs on the MOS. To avoid over-stressing the aircraft, vibrations caused by encountering a crater repair must be allowed to dampen before the craft encounters another crater repair. Selecting a MOS with craters spaced far apart will increase the amount of time available for damping the vibrations and usually decreases the need for high quality repairs and the need for frequent maintenance and subsequent repairs.

6.5.4. Expansion Capability. The MOS is an expedient operating surface selected to support a specific combination of aircraft under specific conditions. A larger operating surface, or one that can be rapidly expanded, is always highly desirable. In some situations, the commander may choose to delay initial recovery in order to provide a more flexible MOS. The MOS selection team should keep these factors in mind as it searches for a candidate MOS. Avoid boxing-in the MOS with large craters at both ends. If an expansion option with equivalent or slightly longer repair time is available, that option should be included in the briefing to the wing commander. Also, be aware that expansion of a MOS may affect the repair qualities required. If you are planning on later MOS expansion, you may want to make the initial RQC calculations adequate to support both the initial and expanded MOSs.

## 6.6. MOS Selection Kit.

6.6.1. Each CE squadron at an overseas MOB and units within the CONUS that have a deployment docket should develop a MOS selection kit. If the installation performs peacetime damage assessment and tracking using automated mapping tools such as GeoBase/GIS, the kit may include these same tools; but sufficient backup capability must be available, such as duplicating information on a different hard drive/server at the alternate EOC. However, the team should look at deployability of this capability and exercise it to ensure wartime-unique tools are not overlooked. In addition to the necessary GIS equipment, the kit should include, as a minimum, the items listed below.

6.6.1.1. Transparent material for making MOS templates (e.g., clear acetate or Plexiglas).

6.6.1.2. Plotting board.

6.6.1.3. Critical resource charts.

6.6.1.4. Straight edge, engineer scale, and transparent circle templates with decimal units matching the airfield map scale.

6.6.1.5. RQC T.O. 35E2-4-1, Repair Quality Criteria System for Rapid Runway Repair.

6.6.1.6. Markers, pens, and pencils.

6.6.1.7. Damage reporting/recording forms.

**NOTE:** Transparency material, markers, pens/pencils, and circle templates should be obtained through either local purchases or normal supply channels.

6.6.2. In addition to the items above, the following additional MOS selection kit augmentation items must be available at each MOB or deployment location for MOS selection team use:

6.6.2.1. Base map - 1:4800 (1" = 400') scale.

6.6.2.2. Airfield map - 1:1200 (1" = 100') scale with the runway identifier and station marker posts indicated. Ideally, the runway portion of the airfield map should be lightly partitioned in 10' increments to ease and expedite plotting.

6.6.2.3. Plotting board.

**6.7. MOS Selection Phases.** Minimum operating strip selection is accomplished in four phases: (1) Alert status preparation—gathering the team equipment and basic information for use during MOS selection; (2) plotting the damage and searching for candidate MOSs and access/egress routes; (3) evaluating candidate MOSs; and (4) briefing the MOS candidates to the ICC commander for final MOS approval.

6.7.1. Phase 1—Alert Status Preparation. After declaration of an alert condition, MOS selection personnel report to their assigned base recovery duty position to acquire information on MOS dimensions, aircraft types and missions, direction of takeoff and landing, weather conditions, and possible use of an aircraft arresting system. This information should be recorded on the airfield map where it can easily be seen by the entire EOC staff. The information should also be relayed to the alternate EOC and the DCC by the MOS selection team located in the primary EOC and posted on the RQC Worksheet #1. **NOTE:** Repair quality criteria Instructional Guideline Steps 1 and 2 can be accomplished during the preattack period. This is also the best time to contact the DCC and verify what R-set (R1, R2 or R3) is available for ADR.

6.7.1.1. MOS Dimensions. The ICC will determine the dimension of the MOS it needs following an attack. These dimensions will be based on the known requirements of aircraft expected to use the MOS, mission objectives, weather, aircraft performance, and environmental conditions. After obtaining the MOS dimensions, make the MOS template to create a "picture" of the MOS in the same scale as the airfield map. When the installation has multiple types of aircraft and missions, a MOS template should be developed for each with an ICC-provided mission priority. This will allow the ADR teams to focus on the most pressing MOS while having situational awareness of the overall requirement. An example would be a MOS needed as quickly as possible for fighters and a C-17 MOS needed within 12 hours. This would drive the team to focus on the MOS to get fighters operating and then plan to expand or develop the C-17 MOS in concert with the ICC's ATO to provide the C-17 MOS for on-time resupply without delaying offensive operations. **NOTE:** Generally, the dimensions of a basic MOS for fighter aircraft are considered 50 ft. x 5,000



ft. However, a number of factors, such as weather conditions, can necessitate that a larger MOS width or length is desirable. Consequentially, do not be surprised if a wing commander insists upon greater MOS dimensions.

6.7.1.2. Aircraft Requirements. Ask the ICC to provide the MOS operational requirements, i.e., what type(s) of aircraft will use the landing surface, and will each type be landing only, taking off only, or both. Under certain circumstances, an evacuation strip may be required. Evacuation is a minimum gross-weight takeoff, requiring a minimal amount of pavement. NOTE: Post this information on RQC Worksheet #1.

6.7.1.2.1. Aircraft Braking. A decision must be made for certain aircraft as to whether the aircraft will brake during landing. The trade-off here is that when braking is allowed, less pavement is required, but repairs must be smoother. If braking is not allowed, a rougher repair quality may be acceptable, but a longer MOS is required.

6.7.1.2.2. Aircraft Arresting System. For fighter aircraft equipped with arresting hooks, the possibility exists for using an AAS when landing. This is only an option if your base has a MAAS available, or if the installed arresting systems and sufficient surrounding pavement remain undamaged. In wet and especially in icy conditions, the arresting system substantially reduces the amount of pavement required to land. If a system is available and wet or icy conditions exist, plan on using it to recover fighter aircraft.

6.7.1.3. Weather Conditions. Consult the ICC or base weather regarding present and forecasted (48-hour) weather conditions. Always use the most critical weather forecasted in your computations. In wet and icy conditions, most aircraft will require more than 5,000 feet to land. An arresting system may be needed to recover aircraft when insufficient cleared pavement is available. Furthermore, weather information must be updated as actual conditions change. The three main weather indicators are runway condition reading (RCR), runway surface condition (RSC), and DR. Each will be discussed in detail in the next chapter.

6.7.1.4. Unidirectional or Bidirectional MOS. A MOS can be used for unidirectional (takeoff and landing in only one direction) or bidirectional (takeoff and landing in both directions) operations. Repairs in landing zones will usually require higher RQC. Ask the ICC for the directional requirements (compass heading) for the MOS. Wind conditions also affect the direction requirement, since it is desirable for aircraft to takeoff with a head wind. If high changeable winds are expected, a bidirectional MOS may be required.

6.7.1.5. Taxiway Widths. Minimum operating strip selection by its very nature concentrates on determining desirable MOS characteristics. Taxi access to the MOS must not be forgotten. Data on taxiway requirements should also be gathered early in the selection process. Of primary concern are the required taxiway widths to support the various types of aircraft expected to be using the MOS. **Table 6.3.** provides minimally acceptable taxiway widths for common aircraft. Choose the largest width from those which apply to aircraft that will be using the MOS. In addition, request data from the ICC regarding aircraft turning radius requirements. Consider the problems presented if an aircraft should breakdown on a taxiway that is too narrow for the aircraft to be turned around. Though not a “show stopper,” this information should be part of the evaluation process. Supply the ADATs with this information so that they can judge whether access routes are open or require repair. Also, do not forget to pass the same information to the alternate EOC and the DCC.



**Table 6.3. Minimally Accepted Repaired Taxiway Width Criteria.**

Aircraft	Repaired Width (Feet)
F-15/16/22, A-10/7	25
C-130 30	
C-17 50	
C-5, KC-10, B-747	60
KC-135 75	

6.7.2. Phase 2—Plotting the Damage and Searching for Candidate MOSs. Selection of candidate MOSs is based primarily on the data provided by ADATs. However, the data is gathered under adverse conditions and is not precisely measured; therefore, it may include some amount of error. Initial detailed airfield damage information comes into the EOC from the ADAT reports. The radio operators log it on an appropriate form and plotters subsequently annotate the base map accordingly. The goal should be to have MOS candidate selection completed within 30 minutes after the last damage assessment reports on the potential LOR pavement surfaces are received. However, much of the work can proceed while receiving damage assessment reports. The following guidance describes the general process for MOS plotting by hand; it does not prevent automation of the process so long as the same general steps are followed to arrive at MOS candidates for presentation to and evaluation by the ICC and EOC leadership.

6.7.2.1. Plotting. When the ADATs begin calling in pavement surface reports, plot damage on the 1:1200 (1" = 100') scale airfield map.

6.7.2.1.1. Craters. The most critical damage data are the location and size of craters. The circle template used for crater plotting should have a decimal scale (e.g., a 0.40-inch circle will represent a 40-foot circle on 1:1200 scale airfield maps). The apparent crater diameter called in by the ADATs should be doubled when plotted to represent the approximate required repair diameter. The apparent diameter should be noted inside the circle. The actual repair diameter will depend on how much upheaval lip has to be removed during the actual repair process. This obviously will be unknown until the ADR crews perform their upheaval measurements. However, the doubling of the apparent diameter gives a reasonable approximation and allows some room for both plotting and assessment error.

6.7.2.1.2. Spalls and Bomblets. A spall or bomblet field is shown on the airfield map by marking its perimeter and noting the approximate number of spalls to be repaired or bomblets to be removed. Bomblet and spall field counts are estimates and probably will not be exact; a factor to consider when determining overall recovery time. However, spall and bomblet fields normally are not as difficult as craters to repair in terms of searching for candidate MOSs.

6.7.2.1.3. Utility Damage. Utility damage affecting MOS selection must also be plotted. Examples include damaged petroleum, oil, and lubricant (POL) lines; airfield lighting; water lines; or electrical lines. Utility damage is especially critical when it occurs near runways and taxiways, since it could lead to pavement washout or deterioration or present a serious hazard to aircraft maintenance crews and firefighters.

6.7.2.1.4. UXO. Individual large unexploded ordnance should be marked with reasonable precision on the airfield map. They should also be cross-referenced with the EOD incident list.

Exact position of a UXO is not critical, due to the large radius of effect upon detonation. Once a UXO is plotted, the EOD representative should determine the radius of effect on the airfield map. De-pending upon what areas are covered by this radius, the prioritization of EOD recovery actions could be influenced.

6.7.2.1.5. Other. During plotting, you should also assess potential access/egress routes using the required taxiway width as determined in Phase 1. As mentioned earlier, access/egress to both ends of the MOS is an important factor when it comes to sortie capacity. A single access route could cut your launch and recovery capacity to 40 percent or lower. If damage is high, operations may begin with one access route; a nother route can be cleared as repair teams become available. This strategy is particularly good if repairs to the second access route can be made while the MOS is in use **Figure 6.2.** shows an example of various types of damage plotted on the runway.

**Figure 6.2. Example of Damage Plots.**

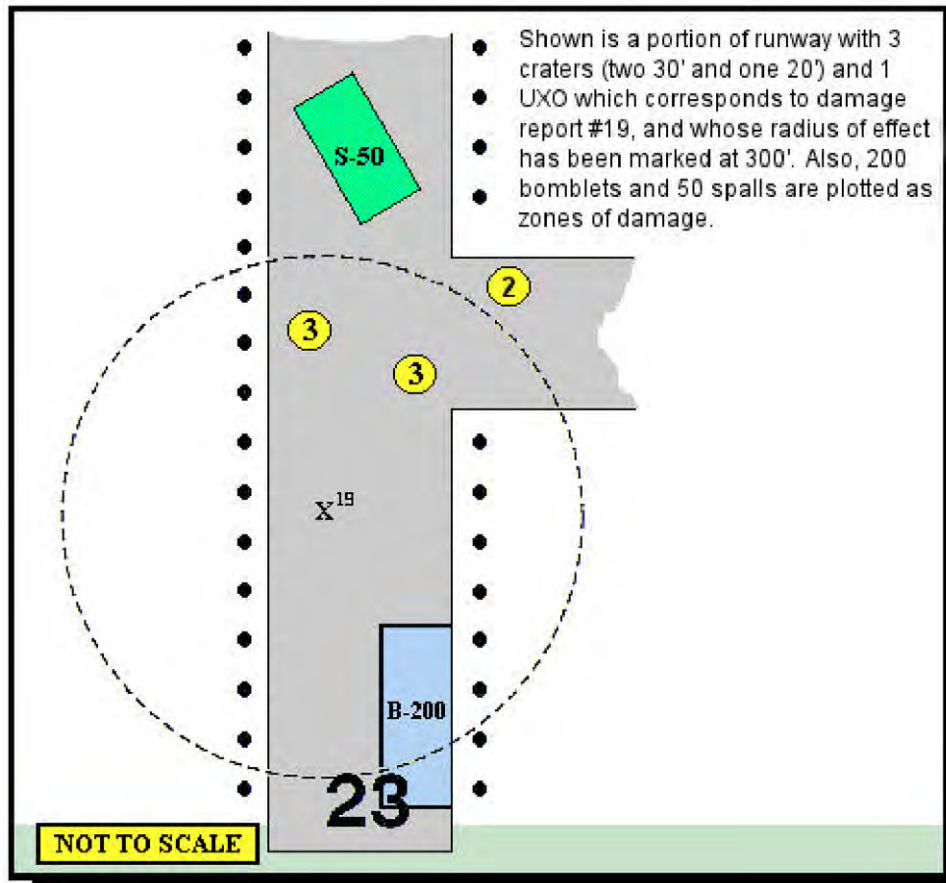

6.7.2.2. MOS Candidate Selection Considerations. The primary aim of MOS selection is to identify the best launch and recovery strip candidates for recommendation to the wing commander. However, always remember to check for MOSs that have the same centerline as the runway initially and begin or terminate at the threshold of the existing runway. If the same centerline cannot be used, the selected MOS must be parallel to the centerline of the runway. A skewed MOS is not desirable and should be used only as a last resort when no other option is available. Other prime considerations in the selection process include:

6.7.2.2.1. Craters and Spalls. How many and what size are the craters? Likewise, how many spall repairs are required? A MOS involving the least number and smallest size craters and spalls will probably be the most attractive option. Start by avoiding areas with dense clumps of damage. Remember that the ADATs may not be reporting the damage accurately. Damage assessment reports are only “best” estimates made under difficult circumstances; they could easily be off by several feet. However, there is some leeway, since the craters are plotted to represent repaired rather than apparent diameter. Nevertheless, if possible, avoid butting the MOS right up against the edge of plotted craters. These craters may not be exactly where you think they are. Also, attempt to find a MOS that does not have craters in the landing (touch-down) zones—roughly the first and last 1,000 feet of the strip. Besides requiring a higher quality of repair, craters in these areas will demand considerable maintenance since the landing zones receive the most abuse from aircraft traffic.

6.7.2.2.2. MOS Access. Always look for a MOS with good taxiway access/egress. Search for candidates with routes by which aircraft from shelters can readily taxi to and from both the takeoff and landing ends of the MOS. Access routes are best when positioned close to each end of the MOS.

6.7.2.2.3. Expansion Potential. The commander may opt for a MOS that requires a somewhat longer repair time if it can be readily expanded to support additional aircraft or poorer weather conditions. Always look for a MOS that is longer and wider than the minimum requirement provided by the ICC. Do not forget the possibility of using parallel taxiways as a primary MOS.

6.7.2.2.4. UXO. Are there any large buried bombs that will require careful excavation, or bomblet fields that exclude a candidate MOS from consideration? Are bomblets mixed with crater debris, making clearance too slow? Will an in-place deflagration of an UXO make the MOS candidate option worse? A deflagration is an accelerated burnout of explosive material within an item of ordnance. An EOD technician hitting the munition with a rifle round usually causes this situation. The resulting reaction (deflagration) is normally less destructive than that caused by allowing the ordnance to detonate—but some damage to the pavement surface will usually result.

6.7.2.2.5. Resource Limitations. Consider any limitations in resources that might impinge upon a repair effort. For example, if the stocks of spall repair material have been depleted, a MOS with few spalls will be at a premium. Likewise, if ADR equipment has been damaged, the impact on repair techniques and time must also be taken into consideration.

6.7.2.2.6. MOS Identification. Once candidate MOSs are selected, the threshold and departure ends and edges should be bracketed ( [ ] ) on the airfield map. The MOS threshold is designated at the lowest numbered pavement reference marker. Conversely, the highest numbered pavement reference marker indicates the MOS departure. Be sure to coordinate the designation of the MOS threshold with the ICC.

6.7.2.2.7. Other Factors. Minimum operating strip selection requires a compromise of all the aforementioned considerations. For this reason, the EOC staff must have an intimate knowledge of ADR procedures, capabilities of the repair teams and availability of all of the ADR assets and materials. The EOC staff must also have a basic understanding of operational requirements in terms of weather, NAVAID support, and aircraft operating characteristics. The

EOC staff must be able to discuss all the tradeoffs knowledgeably and effectively with the BCE and the wing commander to select the best repair plan. **Table 6.4.** provides a MOS selection checklist highlighting a few of both the desirable and undesirable MOS features. Good MOS selection is an acquired skill attained through training and operational readiness exercises. In the next procedure phase, candidate MOSs will be evaluated based on time for repair and assessment of various operational limitations. During MOS candidate selection the EOC staff will have time to evaluate only a few MOS candidates. The MOS selection team must have practiced enough to know the trade-offs without stopping to figure them out.

**Table 6.4. MOS Selection Checklist.**

MOS Selection Checklist	
___ 1.	Are MOSs available that are on the centerline and at either end of the original runway?
___ 2.	Crater and spall repairs—how many and what size? A MOS location that involves the least number and smallest size craters and spalls is usually the most attractive option.
___ 3.	Are there longer or wider MOSs than ICC requirements, but do not require additional repairs?
___ 4.	Are there MOSs that have expansion potential, yet require limited additional repairs?
___ 5.	UXO: ___ a. Are there any UXO or bomblet fields that exclude a candidate MOS from further consideration (large buried bombs that will require excavation)? ___ b. Will in-place detonation make the option worse? ___ c. Are bomblets so heavily mixed with crater debris that clearance will be too slow? ___ d. Has time delay for start of crater repair necessitated by UXO clearance been estimated?
___ 6.	Have shortest access routes been chosen consistent with the degree of repairs required?
___ 7.	Are access/egress routes positioned close to the end of the MOS? At least two routes are desired, with minimal MOS back-taxiing requirements.
___ 8.	Existing MOS: ___ a. Is there an existing MOS? ___ b. Is it still operable? ___ c. Can it be made operable with minimal repair and marking?
___ 9.	Can a MOS be made operable by altering operational requirements (types of aircraft expected to use the MOS, gross weights, use of arresting system, unidirectional vs. bidirectional operations, etc.)? Consult with director of operations (DO) or supervisor of flying (SOF) & notify wing commander of possibilities.

MOS Selection Checklist	
___ 10.	Arresting System: ___ a. Is an arresting system required for operations? ___ b. Is there a MOS candidate that includes an in-place arresting system? Is candidate MOS centered sufficiently with pendant to permit proper arresting system operation? ___ c. Is there sufficient crater free pavement on both sides of the arresting system? ___ d. Is a MAAS available?
___ 11.	How well trained are ADR teams? Can they complete damage repair in the 4 hours criterion?
___ 12.	What is the condition of the troops (fatigue, morale, attrition, etc.)?
___ 13.	What is the current condition of the ADR equipment?
___ 14.	What is the Chemical -Biological-Radiological-Nuclear (CBRN) state?
___ 15.	What are the environmental factors (weather, lighting, etc.)?
___ 16.	What is the possibility of reattack?
___ 17.	Navigational Aids: ___ a. Will the MOS location allow the use of existing NAVAIDS? ___ b. Are NAVAIDS needed? ___ c. Are existing NAVAIDS operational?
Table 6.4 continued on next page.	

Desirable MOS Selection Aspects	
___ 1.	Crater locations on MOS that facilitate repair in pairs rather than single repairs may be desirable to reduce crater repair times. (RQC will normally be more restrictive for closely spaced craters.)
___ 2.	MOS aligned on existing centerline to reduce marking time and take advantage of surviving NAVAIDS.
___ 3.	MOS with one end (either threshold or departure) situated on threshold of the original runway.
___ 4.	A MOS that can utilize an existing in-place arresting system system.
___ 5.	Craters which are located close to material stockpiles.
___ 6.	A MOS with access/egress routes at each end.
___ 7.	A MOS with a minimal number of crater repair locations.
___ 8.	A MOS with dimensions longer and wider than the nominal 5,000' by 50'.
Undesirable MOS Selection Aspects	
___ 1.	Craters located so close together that there is no clear working space around them.
___ 2.	More craters, spalls, & UXO than a full ADR team can handle in a 4-hour time frame.
___ 3.	Craters within the first & last 1,000 feet of the MOS (these are the takeoff/landing touchdown zones; repair RQC in these zones are more restrictive).
___ 4.	Boxed-in MOS, one that has large craters situated at the ends that limit expansion potential.
___ 5.	Craters in either an aircraft arresting system's cable approach or fixed tape sweep areas.
___ 6.	Only one access route with no potential of developing a second route.

6.7.3. Phase 3—Evaluating a Candidate MOS. Once the MOS candidates have been identified, several factors must be considered before making the final selection. Many of these are somewhat subjective; therefore demand a wide experience base on the part of the engineer members of the EOC staff.

6.7.3.1. Engineering Repair Times. Equipment availability must be a prime consideration when selecting MOS candidates. Both vehicular and equipment availability directly impact upon an ADR team's crater repair times, regardless of operator expertise. Three equipment packages (R-1, R-2, and R-3) have been developed to manage ADR requirements. Each package supports a defined crater repair requirement. For example, the R-1 set will only provide enough vehicles and equipment to repair three 50-foot (large) bomb craters within a 4-hour period; whereas, an R-3 set will provide enough assets to allow a properly manned team to repair a total of 12 large craters within the same 4-hour time limit. Details regarding ADR equipment sets are outlined in **Chapter 8** of this volume. If your ADR team has been training consistently, the data presented in **Table 6.5** should provide reasonable crater repair time estimates. If not, your estimate will have to be adjusted to be more subjective. Field tests have shown that an untrained team will normally require at least twice as much time to perform ADR as compared to what is illustrated in the table. Times obtained during training exercises may also prove helpful in estimating actual repair times required by your team. However, take into consideration that time estimates from training situations normally involve conditions that are much better than those faced in a wartime environment.

Furthermore, you will need to temper your estimates with the following considerations. Most of these factors will lengthen the ADR process to various degrees.

6.7.3.1.1. What is the physical and mental condition of ADR team members? Are the troops fresh or have they been subjected to previous attacks and subsequent ADR operations?

**Table 6.5. Estimated Crater Repair Times For a Dual Crater Repair.**

Apparent Diameter	Repair Time First Crater	Additional Time For 2nd Crater	Total Repair Time For Both Craters
5-20 feet	65 minutes	35 minutes	100 minutes
>20 feet	155 minutes	65 minutes	220 minutes

**NOTE:** Times reflected are for both AM-2 and folded fiberglass mat repairs conducted under ideal environmental conditions with a complete vehicle/equipment complement utilized by a highly trained and capable team. Estimates do not include travel times to repair locations.

6.7.3.1.2. What attrition has taken place? How many personnel have been lost or vehicles damaged?

6.7.3.1.3. What type of repairs are to be performed? Field experience has shown that AM-2 repairs typically go faster than FFM repairs due to less stringent quality requirements.

6.7.3.1.4. What is the current or expected CBRN status? Will the ADR crews have to wear portions or all of their ground crew ensembles during repair activities?

6.7.3.1.5. What are the environmental factors that will be present during repair? Will it be hot, cold, dark, wet, etc.?

6.7.3.1.6. What is the possibility of a reattack and what will be the time lapse? This type of information could be vital in deciding whether to repair an expanded MOS or stick with the minimum requirements.

6.7.3.1.7. How experienced are the ADAT members at estimating crater sizes and locations? An inexperienced team could be providing data that are prone to recurring errors.

6.7.3.2. EOD Time Estimates. The EOD representative in the EOC will estimate the EOD clearance time for candidate MOSs. In addition, this individual will decide which EOD activities must be completed before ADR can begin and estimates "safing" times for each UXO. The EOD technician will also estimate the time needed for in-place UXO deflagration and/or bomblet field removal from the MOS and UXO clearance on routes from ADR dispersal sites to the MOS. The input from the EOD representative is critical to MOS selection and evaluation. It is entirely possible that the MOS with the least crater repair work could be negated by extensive UXO safing and clearing requirements.

6.7.3.3. NAVAIDS. The availability of NAVAIDS must be considered. If NAVAIDS are inoperative, what will it take to put them back in service? Are mobile NAVAID units available and can on-base communications personnel install them quickly? If NAVAIDS will be out of service for an extended period, other factors may become more important. For example, two access taxiways to the MOS rather than only one may be required, thereby speeding ground flow of aircraft to compensate, to some extent, for the loss of air traffic control abilities.

6.7.3.4. LOR Capability. The MOS selection team must assess any LOR limitations pertaining to each MOS candidate. Using the LOR table and the base layout map, the team must evaluate the various trade-offs associated with numbers of access taxiways, availability of arresting systems, aircraft traffic flow, fueling and maintenance locations, etc.

6.7.3.5. Collateral Damage Repairs. Damage to in-place arresting systems, airfield lighting, vicinity utility lines, and NAVAIDS may have to be repaired before a MOS can become operational. Therefore, repair times for these systems involved with a particular candidate MOS must be considered. Some collateral damage may affect all possible MOS selections (i.e., when an airfield lighting vault has been destroyed). Other collateral damage may affect only a few of the possible MOS candidates, such as a ruptured POL line crossing under the pavement at 1,000 feet from the south end of the runway. Repairing collateral damage will normally not be an overriding, time-critical factor, since crews other than ADR teams will be assigned to repair collateral damage. However, the MOS selection team must analyze all collateral damage for its potential impact on MOS selection.

6.7.3.6. Other Factors. As part of the evaluation process, MOSs identified by the alternate EOC are also reviewed, particularly if they differ from the ones developed by the team in the primary center. This action provides a “check and balance” capability for MOS selection, thereby lessening the possibility that important factors have been overlooked. In addition, both the DCC and its alternate are also transcribing damage reports provided by the ADATs and plotting candidate MOSs. By using this “cross-feeding” approach, the DCC can become aware of the true extent of the airfield damage incurred and attain a realistic insight to the extent of the ADR effort they will have to mount.

6.7.4. Phase 4—Recommending MOS Candidates to the Commander. In the last phase of the MOS selection procedure, the MOS selection team chief checks the work of the team and briefs the commander and BCE on the candidates.

6.7.4.1. Presenting Options. The MOS selection team chief recommends one or more candidate MOSs, estimates the comparative recovery times, and describes the advantages and disadvantages of each selection. The commander may request more information, such as an estimate of the time needed to expand a given MOS. In any case, the commander will be required to select a MOS on the basis of the data provided, while at the same time considering many factors that are hard to quantify. All decisions have some risk. Even with precise information, a less-than-the-best MOS may be selected. The MOS selection team’s job is to provide an accurate and timely summary of necessary information to the commander, whose job it is to define what “best” means in a given situation.

6.7.4.2. Commencement of Activities. Once the commander has selected a particular MOS to repair, the BCE will advise the DCC so ADR teams can be dispatched. At the same time, the EOC will direct the EOD technician to dispatch the UXO safing and bomb removal teams to clear the ADR team’s route to the MOS, and the MOS itself, of munitions. The EOC staff also provides the details of the selected MOS to the DCC and alternate EOC. Besides the basics such as length, width, and location of the MOS, information on aircraft turning radii, access/egress route width, sweeping width, time frames for ancillary equipment installation (e.g., airfield lighting, etc.) must be provided. The method of identifying the basic information pertaining to a selected MOS is shown in [Figure 6.3](#). The EOC and DCC staffs must effectively communicate between each other to ensure recovery instructions and requirements are clearly and totally understood. As airfield



recovery progresses, the MOS selection team calculates RQC for the MOS repairs, monitors the repair process, and updates the appropriate maps and charts to indicate the airfield's current condition. NOTE: When forwarding MOS information to the DCC, it is important to include data that indicates the direction of travel for a unidirectional MOS. The best method for doing so is to include the compass heading. For example, on a 06-24 runway, the indication would be either "compass heading 060" if aircraft travel is from the 06 end to the 24 end, or "compass heading 240" degrees if aircraft travel is from the 24 end to the 06 end.

**Figure 6.3. MOS Identification Coordinates.**

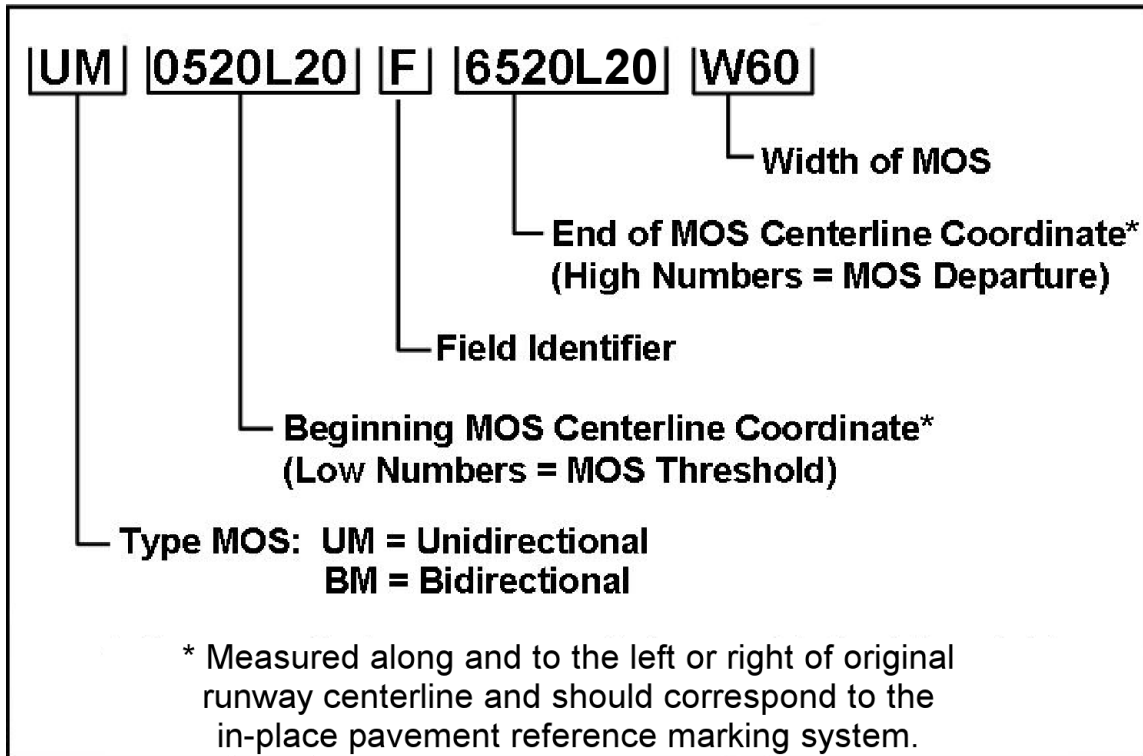

**6.8. Review of MOS Selection Steps.** The following is an abbreviated step-by-step review of the primary steps that members of the MOS selection team should take prior to and during the selection process.

- 6.8.1. Verify availability of all necessary MOS selection maps, documents, materials, and equipment.
- 6.8.2. Obtain information from ICC on aircraft requirements, MOS dimensions, taxiway dimensions, operational parameters, environment conditions, NAVAIDS, arresting system requirements, etc.
- 6.8.3. Construct a MOS template to the prescribed measurements provided by the ICC. Be sure that the template is made in the same scale as the airfield maps used to plot the damage.
- 6.8.4. Inform ADATs of required MOS and taxiway dimensions and pertinent operational needs so that they can apply this data during their assessment process.
- 6.8.5. Record and plot damage and UXO data on the airfield map.
- 6.8.6. Select candidate MOSs to include access and egress routes.
- 6.8.7. Evaluate candidate MOSs in terms of repair times, LOR capabilities, and collateral damage impacts.

- 6.8.8. Recommend MOS candidates to the wing commander (typically at least three, but do not delay excessively if a third is not realistic). Report the comparative recovery times, and describe advantages and disadvantages of various courses of action.
- 6.8.9. Relay commander's decision on MOS to the DCC and alternate EOC.
- 6.8.10. Have DCC dispatch ADR crews to relocate from their dispersed locations to the staging site.
- 6.8.11. Dispatch ADR crew to the MOS after sufficient EOD safing/clearing operations are complete.
- 6.8.12. Perform RQC calculations and monitor progress of recovery efforts.

**6.9.** Situation Example. The following example is presented to walk-through some of the thought processes involved in the MOS selection process. The example is overly simplified, but it outlines a few MOS selection considerations likely encountered in an actual postattack environment.

6.9.1. Circumstance. United States forces are deployed to a theater operating location. The base runway measures 9,000 by 200 feet with three access taxiways (**Figure 6.4**). In-place aircraft arresting systems are located 1,200 feet from each end of the runway and airfield lighting exists. One MAAS is in war readiness material (WRM) storage on base. The UTCs identified in **Table 8.4** are in place and an R-3 ADR set (see **Chapter 8**) is available. Considerable quantities of AM-2 matting are available, but due to heavy structural damage to a storage facility, folded fiberglass mat quantities are available to repair only three craters. Training records reflect that a typical ADR crew has had training in both methods of ADR; however, such a crew will require a minimum of 4 hours to repair two craters using the fiberglass mat technique. The base has just experienced an initial attack.

Figure 6.4. Airbase Layout.

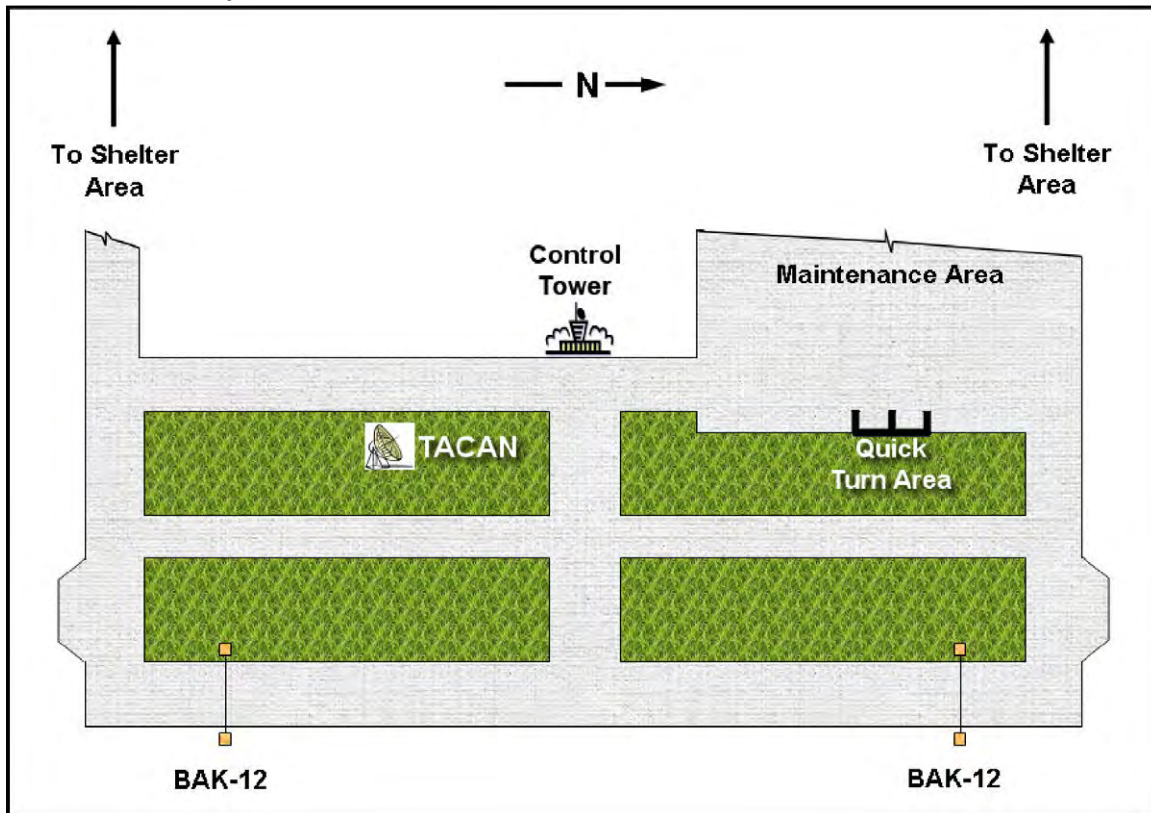

### 6.9.2. Phase I—Alert Status Preparation.

6.9.2.1. Preattack Actions. Prior to the attack, the wing operations center informed the EOC of the following:

- 6.9.2.1.1. MOS dimensions of at least 4,800' by 60' are required to support the fighter aircraft deployed to this location.
- 6.9.2.1.2. Support of cargo or other wide-body aircraft is not an initial consideration.
- 6.9.2.1.3. The use of an arresting system is highly desirable.
- 6.9.2.1.4. The weather is expected to be fair for an extended period, therefore, rain and ice should not be a limiting factor.
- 6.9.2.1.5. A bidirectional MOS is desirable.
- 6.9.2.1.6. Access/egress route width needs to be at least 25 feet.
- 6.9.2.1.7. Maximum use of combat quick turn areas will be made.
- 6.9.2.1.8. Eventual expansion of the MOS (width and length) should be a consideration since resupply will be by air.

6.9.2.2. Preparatory Steps. Prior to the attack, the EOC engineer staff also ensured they had all appropriate equipment, materials, maps, and documents necessary. Once the ICC identified the required size of the MOS, the MOS selection team made a template to correspond in scale to the desired criteria. All MOS selection related data was annotated on the airfield map and relayed to

the alternate EOC and DCC. Engineer information pertaining to ADR capabilities, material availability, and personnel and equipment status was updated and verified. Lastly, a radio check was accomplished to ensure communication with the ADATs.

6.9.3. Phase 2—Plotting Damage and Searching for a Candidate MOS.

6.9.3.1. Plotting Procedures. As the ADATs report airfield pavement damage, the information is plotted on the airfield map. **Figure 6.5.** lists the runway pavement damage locations the ADATs encountered on their survey. Additional damage information reported by the DART, ADATs, and other base personnel that could impact launch and recovery operations are listed below:

**Figure 6.5. Runway Damage Listing and Damage Plot.**

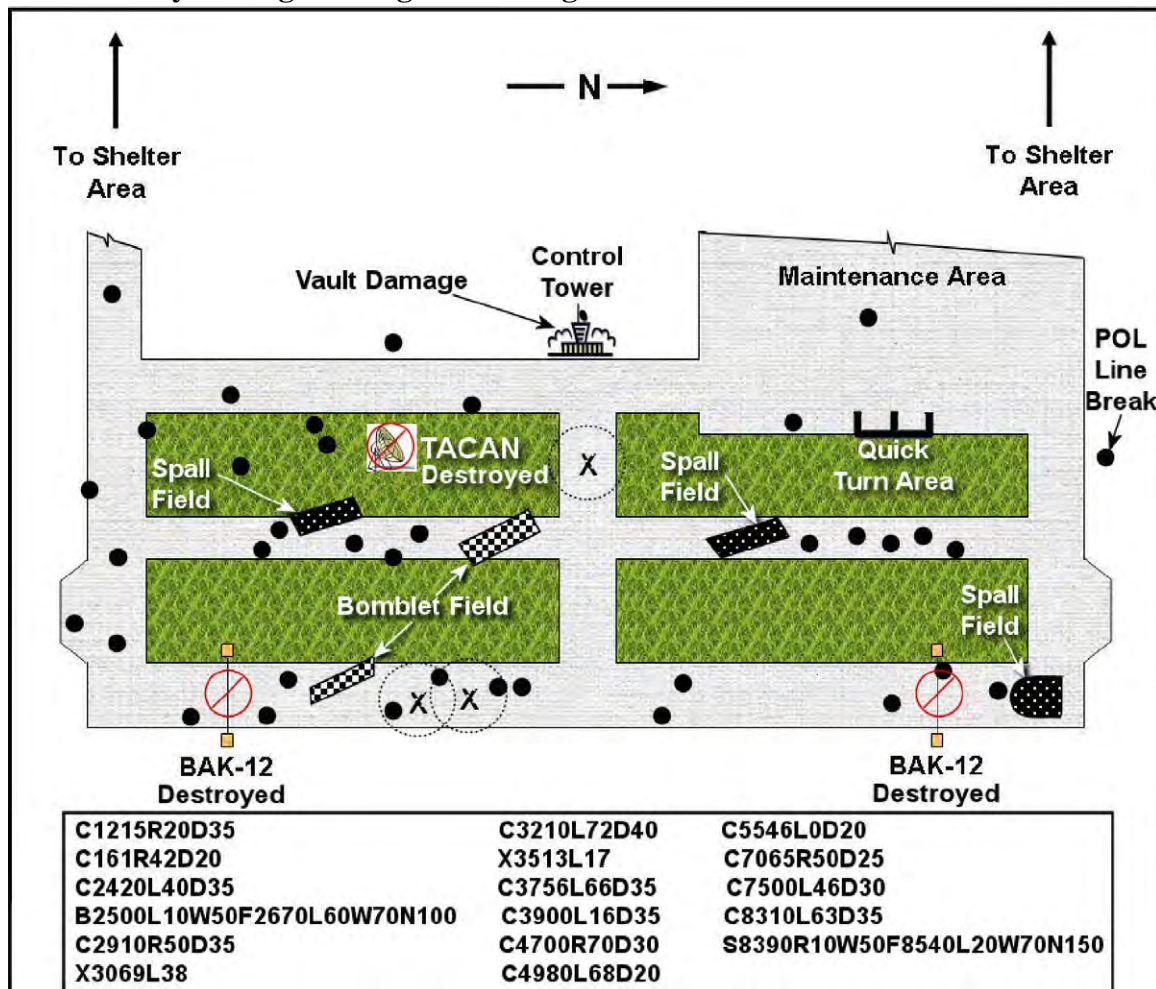

6.9.3.1.1. Substantial structural damage to the airfield lighting vault.

6.9.3.1.2. Aircraft quick turn area appears intact.

6.9.3.1.3. A POL line crossing under the north taxiway is ruptured.

6.9.3.1.4. Roads from the ammunition storage area appear passable.

6.9.3.1.5. South taxiway is cratered in six locations.

6.9.3.1.6. A sizable bomblet field is near the center of the parallel taxiway.



6.9.3.1.7. The TACAN facility is destroyed.

6.9.3.1.8. Both BAK-12 arresting systems are severely damaged.

6.9.3.1.9. The parallel taxiway is heavily cratered and spalled at the 2,000' and 6,000' points.

6.9.3.2. Information Crosschecking. With the locations of airfield damage plotted, the MOS selection team now attempts to find candidate MOSs that fulfill the operational requirement. The selection team uses the MOS template to identify potential candidates. Engineer representatives in the alternate EOC and, if the situation permits, the DCC also perform the MOS candidate search. Information is continually cross-fed between these command centers both for operational continuity purposes and as a crosscheck of MOS selection accuracy and options. Many MOS candidates are possible; three are shown in [Figure 6.6](#).

**Figure 6.6. Candidate MOSs.**

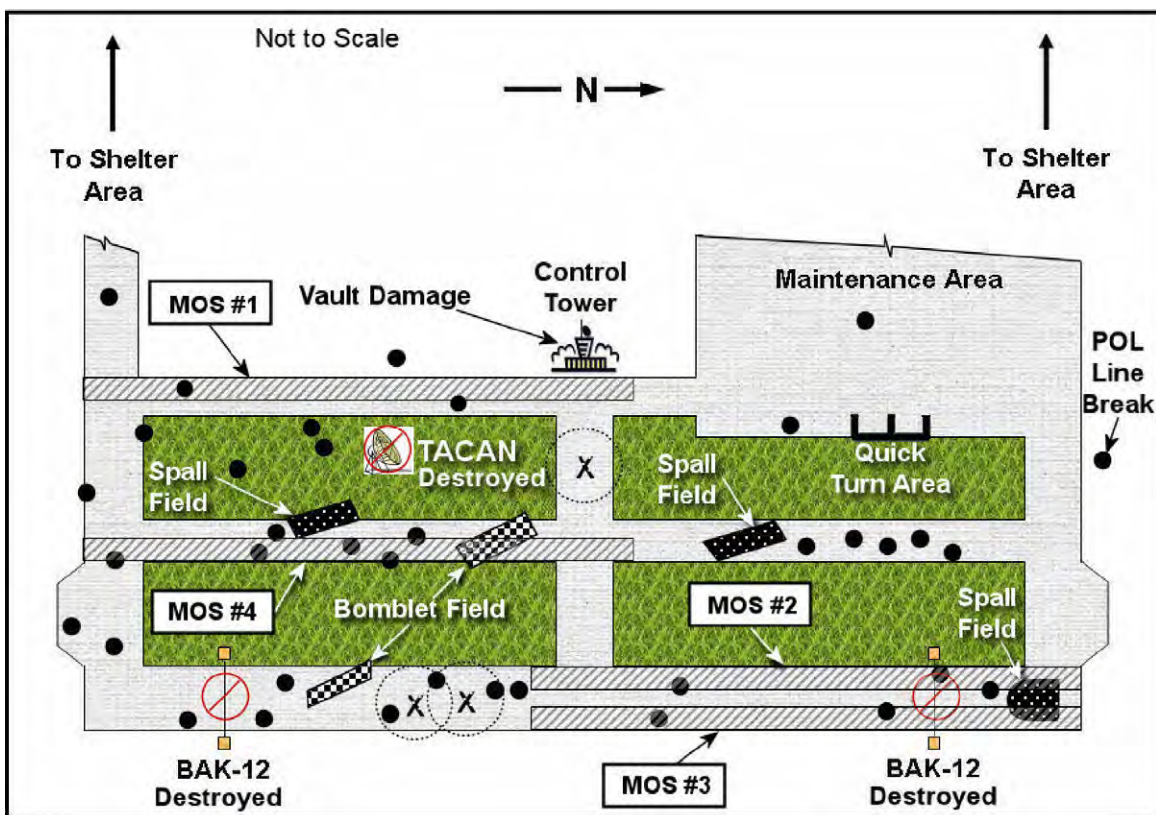

6.9.4. Phase 3—Evaluating a Candidate MOS. Once MOS candidates have been identified, each must be evaluated to determine the best choice for support of launch and recovery operations. Each of the chosen MOSs in our example meet the length and width criteria, yet each have differing characteristics.

6.9.4.1. MOS Candidate #1. This MOS is part of a connecting taxiway. It has access from both ends and requires repair of only two craters in addition to those on any access routes. One of the two craters on MOS #1 is within the first 1,000' of pavement; this usually will require a high quality repair. Bidirectional use of this MOS is possible. Sufficient undamaged pavement along this MOS exists to enable installation of the MAAS in a crater free area, if necessary. For night operations, installation of an airfield lighting set will be required. Access to the quick turn area is avail-

able without extensive maneuvering of aircraft. Primary drawbacks of this MOS are its proximity to structures (control tower) which pose a flying safety hazard and its nearness to the aircraft maintenance area, which limits expandability and could hinder aircraft taxi flow due to aircraft congestion. Explosive ordnance disposal UXO safing and bomb removal prior to establishment of this MOS appear to be minimal, since bomblet fields do not present immediate problems. The number of craters to be repaired does not appear to be excessive. Folded fiberglass mat repairs would be performed on the MOS and AM-2 repairs on access routes. Time frames for engineer repair efforts should be approximately 4-5 hours.

6.9.4.2. MOS Candidate #2. This MOS is located on the western edge of the original runway. Like MOS #1, it has access and egress routes, sufficient undamaged pavement for MAAS installation, bidirectional capability, and relatively easy access to and from the quick turn area. On the other hand, it requires the repair of three craters on the MOS surface itself plus those on the access routes and a portion of a spall field. Additionally, two of the three craters on the MOS are within 1,000 feet of each threshold, which usually results in higher RQC requirements. Near term expandability is limited due to additional craters and a bomblet field south of the MOS. For a south to north takeoff some back taxiing on the MOS is necessary, since the southern access route intersects the MOS at about the 500-foot mark. One UXO on the south end access route must be safed and the POL line adjacent to the north access route, as a minimum, must be isolated. Using folded fiberglass mats for the MOS crater repairs and AM-2 matting for taxiway craters, the time frame for repair should also be in the neighborhood of 4-5 hours. Ample resources exist in terms of manpower, materials, and equipment to meet this time estimate.

6.9.4.3. MOS Candidate #3. This MOS is located on the eastern edge of the original runway. Similar to MOSs #1 and #2, it has access and egress routes, adequate clear pavement for arresting system installation and a bidirectional capability. However, there is a little problem with access to the quick turn area. Like MOS #1, it only requires repair of two MOS craters, does not have to rely on back taxiing, and has a crater located in the first 1,000 feet from its south end. It, however, shares with MOS #2 the requirements for UXO safing and POL line isolation or repair on or along the access routes. Unlike the other two MOSs, it offers an expandability feature. By repairing one more crater and removing two UXOs and the bomblet field, an additional 2,300 feet of MOS length can be gained. The repair time estimate should be similar to both of the other MOSs.

6.9.4.4. Candidate Comparisons. Comparing the three MOS candidates, MOS #3 seems to provide the preferred solution. Repair time estimates are equal among all MOSs and MOS #3 offers expandability and less aircraft taxi traffic flow interference with the maintenance area.

6.9.5. Phase 4—Presenting MOS Candidates to the Commander. All candidate MOSs shall be briefed to the ICC Commander for final decision. Based on the evaluation of all three candidates, MOS #3 appears as the best choice. If asked, MOS #1 would be recommended to the wing commander as the alternative.

**6.10. Chapter Summary.** Minimum operating strip selection is a critical phase of the total effort required to establish a launch and recovery surface for aircraft. To those involved, it can be time consuming, confusing and somewhat complicated if not practiced often. As indicated earlier, the selection process is not an exact science, but top quality personnel that are properly organized and trained can do the job in an effective manner. The need for high competency in, and thorough understanding of, the MOS candidate selection process cannot be over emphasized. The speed with which MOS candidate search and selection

must be accomplished, coupled with the pressures and confusion of a postattack situation will not permit methodical, detailed, step-by-step evaluations of airfield pavement conditions. Minimum operating strip selection must be second nature to the selection team and the only way to gain this degree of efficiency is through constant, repetitive, realistic training. Remember, the mission of the entire air base after an attack is hostage to MOS selection. All personnel involved in MOS selection must be prepared to perform this process rapidly and accurately—nothing less is acceptable.

## Chapter 7

### REPAIR QUALITY CRITERIA (RQC)

**7.1. Introduction.** While modern aircraft are multi-capable, versatile, and extremely lethal in a combat environment, they are nevertheless highly dependent upon an airfield operating surface which must be in “near perfect” condition. This is primarily because the landing gear configurations of most aircraft are highly intolerant of pavement irregularities. Historically, aircraft designers have traded-off landing gear upgrades and undercarriage strengthening for decreased weight and improved avionics and weapons carrying capacities to increase the combat functions of aircraft. This sensitivity to the condition of airfield operating surfaces makes the ADR task more difficult in that we must not only be attuned to the time it takes to accomplish repairs, but also capable of accomplishing high quality repairs. These two features often oppose each other and can only mesh if sufficient training and preattack preparation are performed. Included in this training and preparation are the physical tasks of ADR, MOS selection, and the subject of this chapter—the determination of RQC.

**7.2. Overview.** In this chapter we will discuss the procedural aspects of determining RQC for MOS crater repairs in a wartime situation. Included will be the purpose of RQC, the use of various charts and tables associated with RQC development, the interface between RQC and MOS selection, and the general concept of operations and timing of RQC activities. Although this chapter will address the details of RQC calculations and provide an example based on the MOS chosen in the previous chapter on MOS selection, obtain a copy of TO 35E2-4-1 before fully training on RQC procedures. The TO contains additional aircraft related charts that are not provided in this pamphlet; the TO also contains additional examples which can be used for training purposes.

**7.3. Purpose.** The purpose of RQC is to provide guidance to the wing command and control staff, the DCC, and ADR crews regarding the suitability of wartime pavement repairs for aircraft launch and recovery operations. The criteria determines whether a crater repair is sufficient enough to allow aircraft use.

7.3.1. Current USAF concept of operations calls for repairing a MOS for aircraft operations after an airfield attack. Airfield damage repair teams will attempt to make all repairs flush (plus or minus 3/4 of an inch) with the adjacent undamaged pavement surface by primarily using the FFM repair technique. However, such repairs are difficult to achieve due to hindrances like poor weather conditions, equipment failures, personnel attrition, or the presence of chemicals and/or unexploded ordnance. When ADR teams do not obtain flush repairs, RQC becomes extremely critical. The criteria answer crucial questions, such as “must non-flush repairs be upgraded,” or “can they be used as is?” The criteria also provide information about when and if periodic maintenance to repaired craters is necessary.

7.3.2. Repair quality criteria calculations result in either an F, indicating a flush repair requirement, or a single number expressed in inches for each MOS crater repair. This number represents the maximum allowed height that a finished repair can have in relationship to adjacent undamaged pavement. Determining RQC for each repair is critical. Incorrect RQC can result in certification of an unacceptable runway surface as usable. Operations on improperly certified surfaces could damage aircraft and endanger personnel. Proper use of the RQC system provides a pass/fail assessment for expediently repaired pavement surfaces that alleviates the potential of certifying an unacceptable MOS.



**7.4. Concept of Operations.** Repair quality criteria determination parallels, to some extent, and then follows MOS selection activities. The MOS selection team in the primary EOC has the responsibility for RQC calculations. As a crosscheck, CE representatives in the alternate EOC should also perform the calculations. If it is locally determined that CE DCC personnel will concurrently perform MOS selection, they should act as another RQC safety check. Regardless of how many control centers perform RQC determinations, the ultimate responsibility rests with the primary EOC engineer staff. **Figure 7.1.** depicts how the RQC process typically interfaces with MOS selection and ADR activities. As a minimum, RQC calculations must be accomplished after the wing commander chooses the MOS to be repaired and again after MOS repairs are completed if crater locations, lengths, and spacing have changed during the repair process. Crater changes are entirely probable since damage assessment inputs are field estimates rather than precise measurements. Ideally, RQC determinations should start as early as possible.

**7.5. Activities Sequencing.** As mentioned in the previous chapter, one of the initial actions required with respect to MOS selection is to ensure the necessary maps, charts, materials, and equipment are available in all appropriate control centers prior to an attack situation. This is equally important with regard to RQC components. A copy of the RQC technical order and extra copies of all worksheets and aircraft charts must be available. As a necessity, a reasonable estimate on what aircraft charts to have on hand would be to consider charts associated with any in place aircraft and all potential aircraft that may arrive as identified in the operations plan (OPLAN) time phased force deployment data (TPFDD).

7.5.1. Also, as described in the previous chapter on MOS selection, certain initial steps must be taken once the alert level dictates command centers are to be fully activated. The MOS selection team in the EOC immediately begins to gather data from the ICC such as types of aircraft to be operated, need for an arresting system, anticipated weather conditions, desired MOS length, etc. Besides being used in MOS selection, these data also form the basis for RQC calculations. It is imperative that this information be obtained as soon as possible.

7.5.2. Once the initial information is obtained from the ICC, the EOC MOS selection team should gather the applicable aircraft charts and start filling in the worksheets.

7.5.2.1. Particular attention should be paid to the required MOS length and width. The ICC will provide required MOS dimensions based on knowledge of aircraft characteristics and operational requirements. While the MOS length is probably adequate since it came from the Operations community, it is worthwhile to make a crosscheck using the RQC aircraft charts. The MOS length determination is greatly affected by weather and pavement surface conditions and the consideration of takeoffs or landings of a particular type aircraft. For planning purposes, a nominal MOS length has commonly been considered 50 feet by 5,000 feet, but these dimensions may not hold true for all situations, particularly if environmental conditions tend to be variable. Once all relevant information is obtained from the ICC, the MOS selection team should calculate required MOS lengths for both takeoffs and landings for all applicable aircraft. If disparities with dimensions provided by the ICC are found, these should be resolved before further MOS selection activities take place.

Figure 7.1. MOS Selection—ADR/RQC Interface.

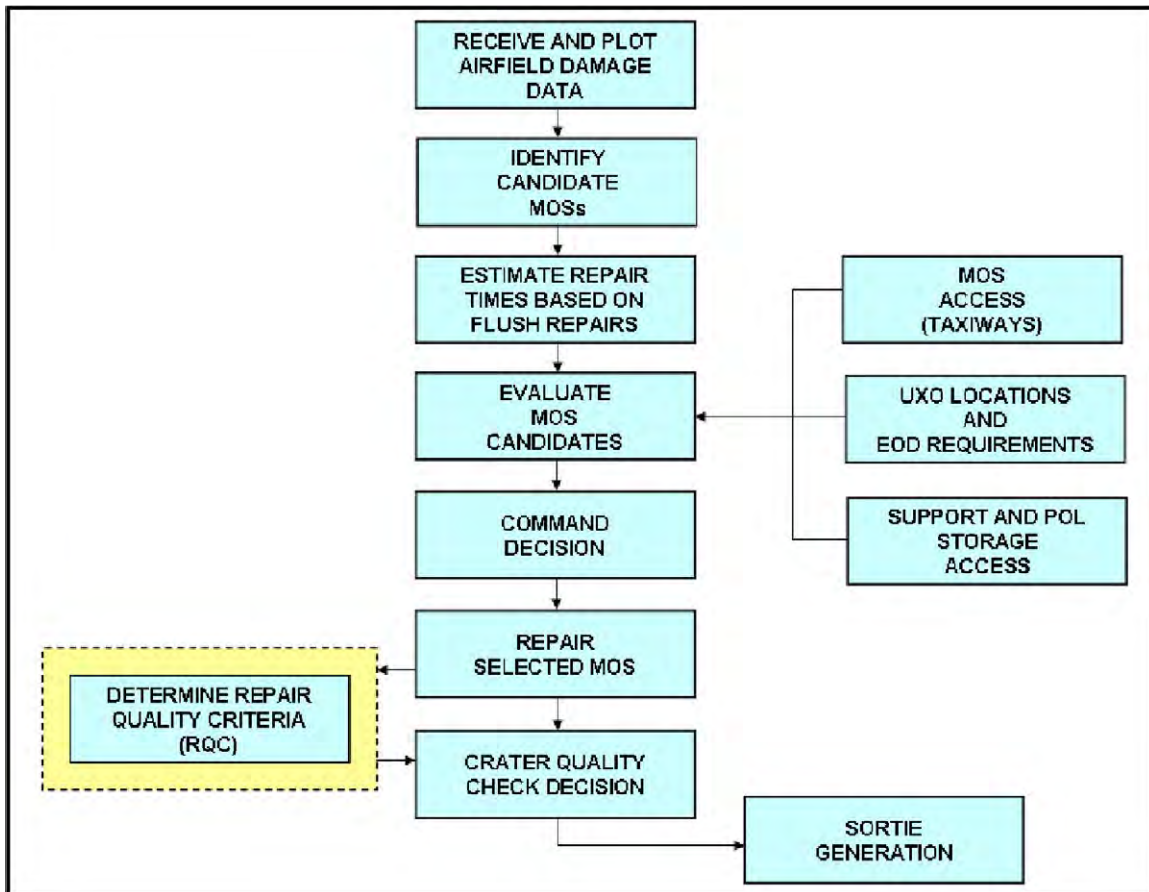

7.5.2.2. Once the ICC and EOC agree upon a MOS length, the appropriate MOS template can be made for the MOS selection process with the assurance that MOS length will be adequate. If this action is not accomplished, MOS selection and subsequent ADR efforts might be based on a MOS length that may be too short to meet all desired operational requirements. Airfield damage repair crews may then be faced with a situation of having to repair additional pavement damage beyond that originally planned. This obviously causes a delay in aircraft sortie generation.

7.5.2.3. Once the initial information is received from the ICC and the MOS selection team has verified MOS length and width, all such data must be relayed to the alternate EOC and the DCC, if appropriate.

7.5.3. After damage has been plotted, MOS candidates will be identified and the most appropriate MOS selected. If EOC staffing and time permit, RQC calculations should be accomplished for the most promising MOS candidates at this time as well. This information will give an indication of the degree of accuracy needed during ADR operations. Although all MOS crater repair techniques are meant to yield flush repairs, unless an ADR team is well trained and competent, it could have difficulty in meeting the flush criteria in a responsive timeframe. All else being equal, it is often better to recommend MOS candidates having greater latitude of repair tolerance, thereby to some degree countering the inexperience of an ADR team. This is a situation where the BCE and his or her staff must have an in-depth knowledge of the capabilities of the ADR team in order to make sound operational recommendations to the ICC staff.

7.5.4. Once the wing commander has selected the MOS for repair and the DCC has dispatched the ADR teams, the MOS selection team performs the mandatory portion of the RQC process. RQC calculations are performed using the initial data obtained from the ICC and the crater location, size, and spacing information pertaining to the chosen MOS. When completed they are compared with those obtained at the alternate EOC and the DCC (if applicable) as a crosscheck for accuracy. As repairs progress and actual repair patch locations, lengths, and spacing are identified, the ADR team chief relays this information back to the DCC and EOC. Repair quality criteria are then recalculated to see if criteria have been altered due to changes in actual crater locations, lengths, and spacing found during the repair process. The results of these calculations are provided to the ADR team chief. If crater repairs are within tolerance, the ADR team completes MOS cleanup and progresses to its next assigned tasking. If repairs are not within tolerances, the wing commander is informed of the situation. The commander must make the decision as to whether aircraft operations will be attempted under such conditions. If the decision is “no-go,” the ADR team must continue working until the repairs meet RQC tolerances.

7.5.5. After repairs are complete and the MOS is usable, RQC calculations continue to apply for maintenance purposes. The tolerance measurements for each repair patch also provide information for maintenance purposes. With sustained aircraft use, the repaired craters on the MOS will most likely begin to settle. This settlement, called sag, could be just as damaging to aircraft landing gear as original crater repairs that are out-of-tolerance. Therefore, periodic checks of the repair patch quality on sag must be made to ensure their suitability for continued aircraft use. If a patch is found to be nearing an out-of-tolerance condition, an arrangement must be made with the airfield operations function to allow MOS downtime for crater repairs. It is also important to note changes in weather conditions. Wide temperature changes and precipitation will require RQC to be recalculated. According to the technical manual, MOS repairs that fall within a numbered area on the appropriate chart (0” to 6”) are allowed to have a maximum 2-inch sag for fighter aircraft, or a 3-inch sag for heavy aircraft. However, craters that call for a flush (F) repair can have maximum sag of only 3/4-inch.

**7.6. RQC Procedures.** In its most basic form, the RQC system is a set of charts and tables that allow quick and accurate determination of allowable crater repair roughness. Different aircraft can withstand varying levels of runway roughness. In addition, weather and runway conditions may affect an aircraft’s performance and consequently, its tolerance to pavement irregularities. Furthermore, the type of aircraft operations also affects RQC, since different operations call for different procedures and aircraft configurations. All of these parameters are taken into account in the RQC system.

**7.7. Terminology.** An understanding of the terminology used in the RQC system is critical. The following are definitions for some of the more important terms common to the RQC process. It is imperative that all CE command center personnel and ADR team leaders thoroughly understand the meanings of these terms.

7.7.1. **Apparent Diameter.** The extent of visible damage associated with a crater (**Figure 7.2.**) measured from upheaved lip to upheaved lip. This is the information that is forwarded to the EOC by the ADAT.

**Figure 7.2. Apparent Crater Diameter.**

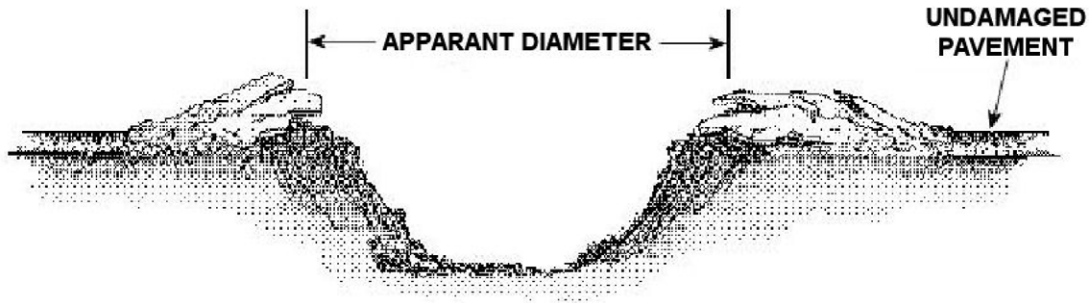

7.7.2. Repair Length. The length of a repaired crater, measured parallel to the MOS centerline, from undamaged pavement to undamaged pavement. Repair length is expressed in feet and is plotted as double the apparent diameter during the damage-plotting portion of MOS selection (**Figure 7.3**).

7.7.3. Repair Height. This is the maximum height of the repair surface above the original undamaged surface (**Figure 7.3**).

7.7.4. Sag. The maximum amount, in inches or fraction thereof, that a repair surface drops below the maximum repair height is sag. Allowing sag permits a repair to degrade with aircraft traffic without requiring excessive maintenance during sortie generation. Allowable sag depths on RQC charts are constant (2-inches for fighter aircraft or 3-inches for heavies) for numbered repairs. Allowable sag depth for flush repairs is only 3/4 inch, since by definition flush means plus or minus 3/4 inch. These restrictions apply for each profile line overall portions of a repair surface (**Figure 7.3**).

7.7.5. MOS Threshold. The MOS threshold is the starting point of the MOS (**Figure 7.4**). It corresponds to the end of the MOS with the lowest numbered station marker on the pavement reference marking system.

Figure 7.3. Repair Terminology.

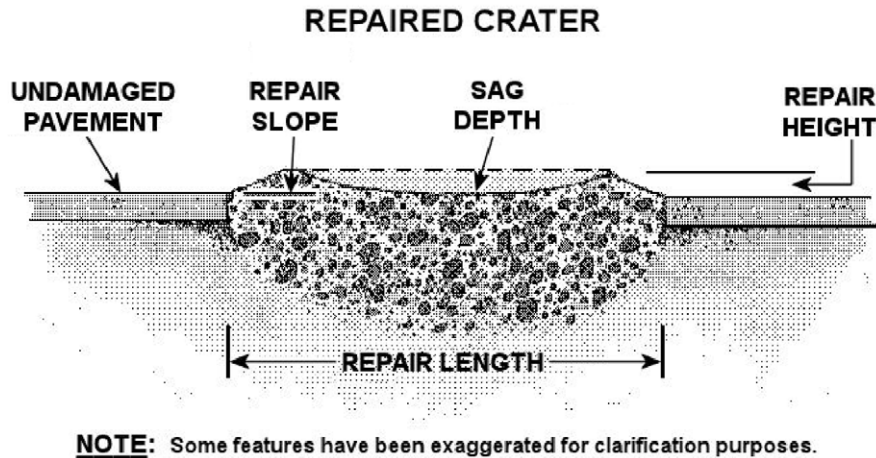
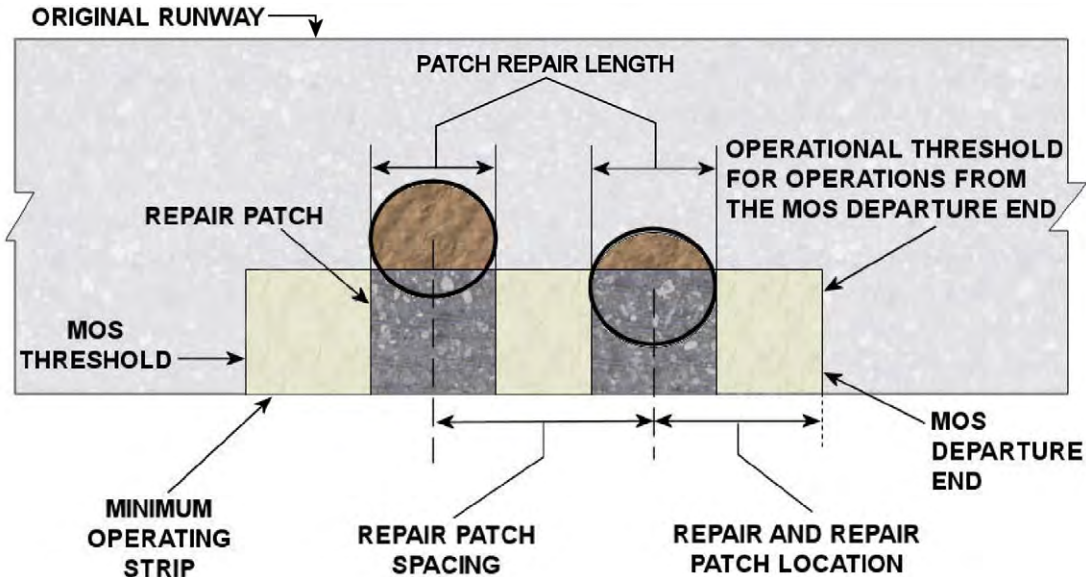

Figure 7.4. MOS Terminology.



7.7.6. Departure End. This is the end of the MOS opposite the MOS threshold ( [Figure 7.4](#)). This point corresponds to the highest numbered station marker location on the selected MOS. All aircraft operations must begin at either the threshold or the departure end of the MOS.

7.7.7. Operation Threshold. This is the point on the MOS where aircraft begin their takeoff roll or touchdown on landing. For bidirectional operations, aircraft can operate from either the MOS threshold or the MOS departure, depending upon which direction aircraft will be flying when operations commence ( [Figure 7.4](#)). As will be described later in this chapter, bidirectional operations will require two RQC calculations—one for operations starting from the MOS threshold and once for operations starting from the MOS departure (typically driven by prevailing wind and given as runway headings).



7.7.8. Repair Patch. A repair patch is an area on the MOS that may include a single repair, part of a repair, or any combination of repairs, or parts of repairs. A repair patch is an area fixed as a single repair (Figure 7.4).

7.7.9. Repair Patch Location. The location of a repair patch center relative to the operation threshold. The location is measured parallel to the MOS centerline and is expressed in feet (Figure 7.4).

7.7.10. Repair Patch Spacing. Repair patch spacing is the distance from one repair patch center location to the next repair patch center location. Spacing is measured in feet parallel to the MOS centerline (Figure 7.4).

7.7.11. Repair Patch Length. This is the length of a repair patch, measured parallel to the MOS centerline. Repair patch length is expressed in feet (Figure 7.4).

7.8. RQC Chart Description. Technical Order 35E2-4-1 contains a number of different RQC charts designed to support various aircraft and operating situations. For example, Chart D1 governs F-16B aircraft during takeoff, whereas Chart D2 applies to F-16B aircraft during landings. Charts also exist for other variations like evacuation (the expedient departure with the lightest load possible). All RQC charts are divided into four major areas: location baseline, environmental shift area, uncorrected RQC area, and correction factor area (Figure 7.5). RQC charts will be discussed in greater detail later in this chapter.

Figure 7.5. Example RQC Chart.

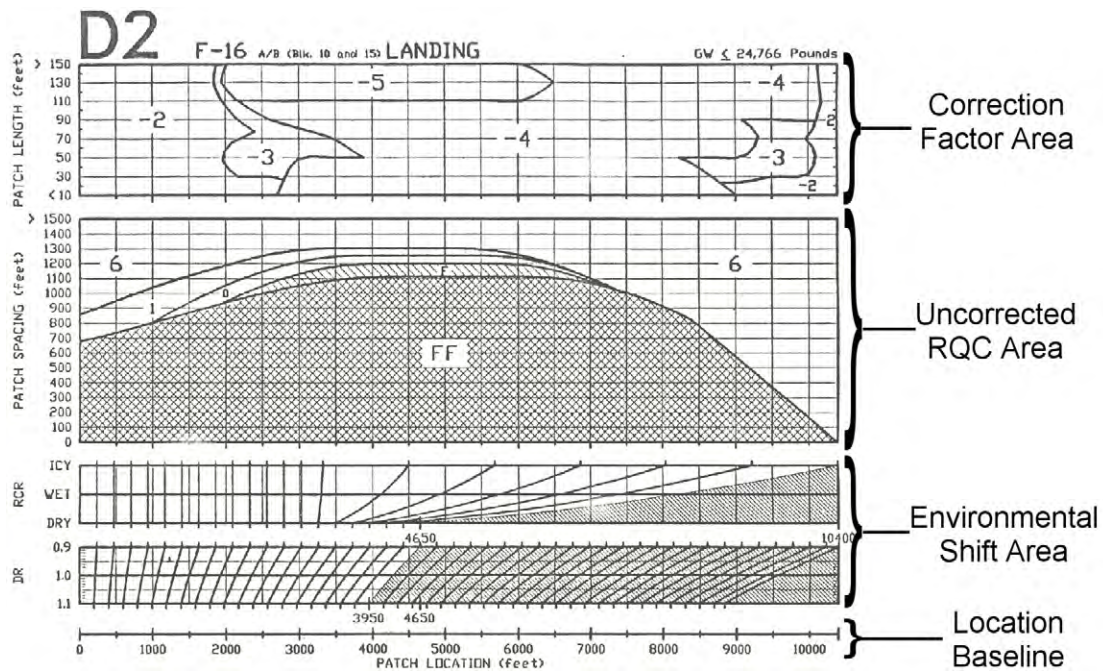

7.8.1. Location Baseline. The location baseline is the starting point for RQC calculations. The baseline is at the bottom of an RQC chart. Marking the location of each crater repair on this line begins the RQC determination process. All locations are measured from the operation threshold.

7.8.2. Environmental Shift Area. The environmental shift area includes the boxes above the baseline that compensates for aircraft performance changes under varying weather and runway surface conditions. These conditions are depicted using DR, RCR, and RSC numbers.

7.8.3. Density Ratio. DR is the relationship between air temperature and pressure altitude which gives a measure of probable aircraft performance. On cool days the density ratio will be high and performance will be good. This means takeoff distances will be shorter. Ask the base weather office for the expected high temperature and the pressure altitude. With these figures the DR can be found by using the chart shown in **Figure 7.6**. Enter the temperature along the X-axis. From this temperature value, go vertically until the appropriate pressure altitude line is reached. Then go horizontally to the Y-axis and read the DR value. For example, at 59 degrees Fahrenheit, at the sea level pressure altitude, the DR value is 1.0. Note that as temperature and altitude increase, the DR value decreases. Density ratio affects all aircraft on takeoff and landing.

7.8.4. Runway Condition Reading. RCR affects the landing distance of aircraft by influencing wheel braking effectiveness. It can be measured as a specific number, but for purposes of RQC calculations it is subjectively expressed in terms of three choices: wet, dry, or icy.

Figure 7.6. Density Ratio Chart.

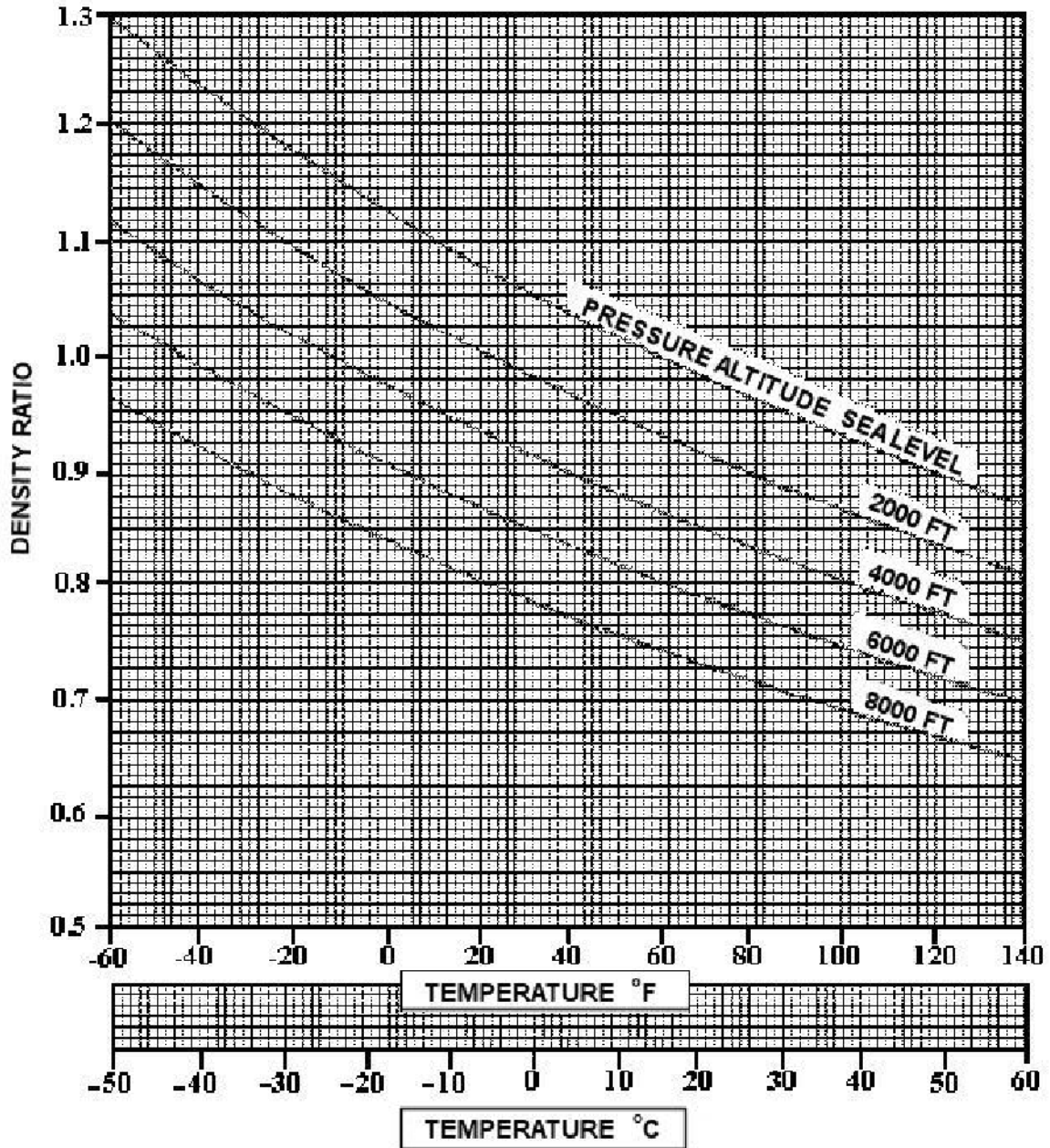

7.8.5. Runway Surface Condition. RSC is a measure of the precipitation standing on the runway. It affects only multi-wheeled wide body aircraft during takeoff. Because of the large tire footprint area of cargo aircraft, precipitation can cause significant additional friction, resulting in a lengthening of the takeoff roll.

7.8.6. Uncorrected RQC Area. This area is located on the RQC chart just above the environmental shift area. It is used to assign an initial value for maximum repair height, based on patch spacing. For example, "F" means the repair must be flush; "FF" means the next repair down the MOS must also be flush. Areas identified by the numbers 1 through 6 reflect maximum repair height in inches. As mentioned earlier, all numbered repair heights can allow maximum sag of 2 inches for fighter aircraft and 3 inches for heavy aircraft. No sag is allowed with flush repairs beyond the + or - 3/4 of an inch nor-



mally accepted as part of flush repair criteria. These restrictions apply over all portions of a repair surface. The vertical axis on the RQC chart represents crater repair patch spacing. When a number is missing, as the number 3 is in **Figure 7.5.**, the variance between numbers was too small to indicate.

7.8.7. Correction Factor Area. The correction factor area is at the top section of the RQC chart. It assigns a correction factor to the repair height, based on repair length. Here, the vertical axis represents crater repair length. The correction factor is algebraically added to the uncorrected RQC to obtain the final required RQC. A quick look at **Figure 7.5.** should tell you that the RQC for the F-16A/B will never exceed 6 inches. The correction factor either reduces the repair quality height or has no affect. NOTE: No correction factor is allowed for “F” or “FF” repairs in the uncorrected RQC area. If, however, the correction factor is larger than the uncorrected RQC and the resultant RQC is negative, the RQC becomes “F.”

**7.9. Worksheets.** There are three worksheets used in the RQC process. They are used sequentially for data collection as the RQC process progresses. The example that will be worked shortly will show you the details of how the forms are used; we will only briefly address the data that goes on the forms at this point.

7.9.1. Worksheet 1, (AFTO Form 71). This sheet is used to record much of the “given” data received from the ICC and base weather at the onset of the MOS selection and RQC determination processes. Information such as aircraft weights, weather, DR, operational parameters, required pavement lengths, and RQC chart numbers are entered.

7.9.2. Worksheet 2, (AFTO Form 72). This sheet is used to record the repair patch locations, lengths and spacing, and calculate the RQC values obtained from the aircraft RQC charts.

7.9.3. Worksheet 3, (AFTO Form 73). This sheet serves as a summary chart for the various crater repair RQC values and enables the determination of the final RQC requirements. It is most important when calculating RQC for bidirectional MOSs.

**7.10. Example.** The following example illustrates procedures for determining RQC.

7.10.1. **Figure 7.7.** shows the airfield map, plotted damage, and the selected MOS. **Figure 7.8.** provides an expanded picture of the MOS candidate itself and illustrates how RQC determination factors are measured. The information following the figures is assumed to have been obtained from the ICC:

**Figure 7.7. MOS Candidate.**

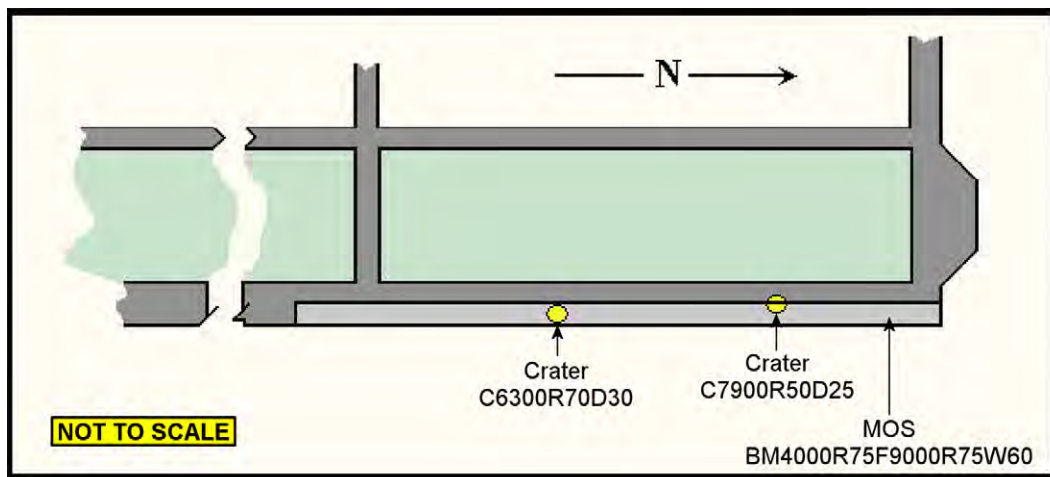
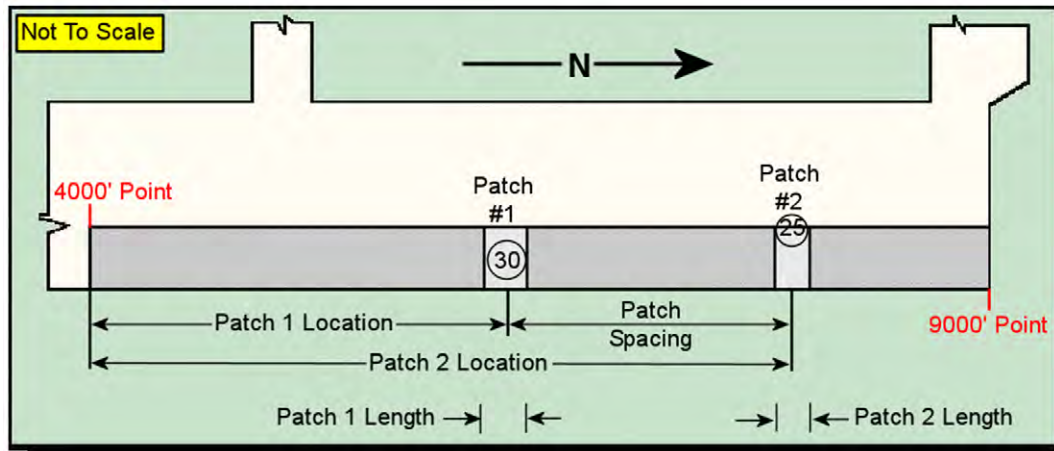

Figure 7.8. Expanded Picture of MOS.



7.10.1.1. Aircraft type—one squadron of F-16Bs. Cargo aircraft is not a primary consideration.

7.10.1.2. Aircraft takeoff weight—33,000 lbs.

7.10.1.3. Aircraft landing weight—22,800 lbs.

7.10.1.4. Bidirectional operations is desirable.

7.10.1.5. Required MOS size—60 feet by 5,000 feet.

7.10.1.6. Sea level pressure altitude operations.

7.10.1.7. Weather—clear, long-range forecast is for clear weather, temperature high of 72F.

7.10.1.8. Evacuation requirements not probable.

7.10.1.9. Aircraft arresting system capability desirable.

7.10.2. The above information is transposed onto Worksheet 1 ([Figure 7.9](#)). Because a bidirectional feature is desired, landings and takeoffs from both the MOS threshold end (operations 1, 2, and 3) and the departure end (operations 4, 5, and 6) are identified. Both variations must be addressed, since crater patches will be at different locations relative to aircraft roll, depending upon the direction of travel. In our example, an aircraft traveling south to north (360 degree heading) on the MOS will reach crater patch number 1 before an aircraft traveling north to south (180 degree heading) will reach the same patch. This difference could influence RQC values resulting in the possibility that the same patch could have different values depending on the aircraft's direction of travel. Investigate both situations to ensure the more stringent requirement is applied.

Figure 7.9. ICC Data Entered in Worksheet 1.

REPAIR QUALITY CRITERIA (RQC) ENVIRONMENTAL DATA							
TEMPERATURE (°F)		72	MDS THRESHOLD (Feet)	4,000	RSC		0.0
ALTITUDE (FT)		Sea Level	DEPARTURE END (Feet)	9,000	RCR (Choose One)		<input checked="" type="checkbox"/> DRY <input type="checkbox"/> WET <input type="checkbox"/> ICY
DENSITY RATIO		.97	MDS LENGTH (Feet)	5,000 x 60	DIRECTION (Choose One)		CHART
OPERATION NUMBER	AIRCRAFT MODEL	GROSS WEIGHT (Lbs)	OPERATION	SPECIAL LANDING PROCEDURES	DIRECTION (Choose One)		OPERATION LENGTH (Feet)
1	F-16B	33,000	Take Off		<input checked="" type="checkbox"/> FROM MDS THRESHOLD <input type="checkbox"/> FROM DEPARTURE END		
2	F-16B	22,800	Landing		<input checked="" type="checkbox"/> FROM MDS THRESHOLD <input type="checkbox"/> FROM DEPARTURE END		
3	F-16B	22,800	Landing	Barrier	<input checked="" type="checkbox"/> FROM MDS THRESHOLD <input type="checkbox"/> FROM DEPARTURE END		
4	F-16B	33,000	Takeoff		<input type="checkbox"/> FROM MDS THRESHOLD <input checked="" type="checkbox"/> FROM DEPARTURE END		
5	F-16B	22,800	Landing		<input type="checkbox"/> FROM MDS THRESHOLD <input checked="" type="checkbox"/> FROM DEPARTURE END		
6	F-16B	22,800	Landing	Barrier	<input type="checkbox"/> FROM MDS THRESHOLD <input checked="" type="checkbox"/> FROM DEPARTURE END		
					<input type="checkbox"/> FROM MDS THRESHOLD <input type="checkbox"/> FROM DEPARTURE END		
					<input type="checkbox"/> FROM MDS THRESHOLD <input type="checkbox"/> FROM DEPARTURE END		

AFTO FORM 71.19960901 (IMT-V1)

7.10.3. DR is determined using the DR chart (Figure 7.10.). A temperature of 72 degrees Fahrenheit and a sea level pressure altitude equates to a DR of approximately .97. Request from the ICC the ranges of RSC and RCR expected for the day. Since the weather is expected to remain fair for an extended period, the RCR will be considered “dry,” resulting in an RSC of 0.0.

Figure 7.10. Density Ratio Determination.

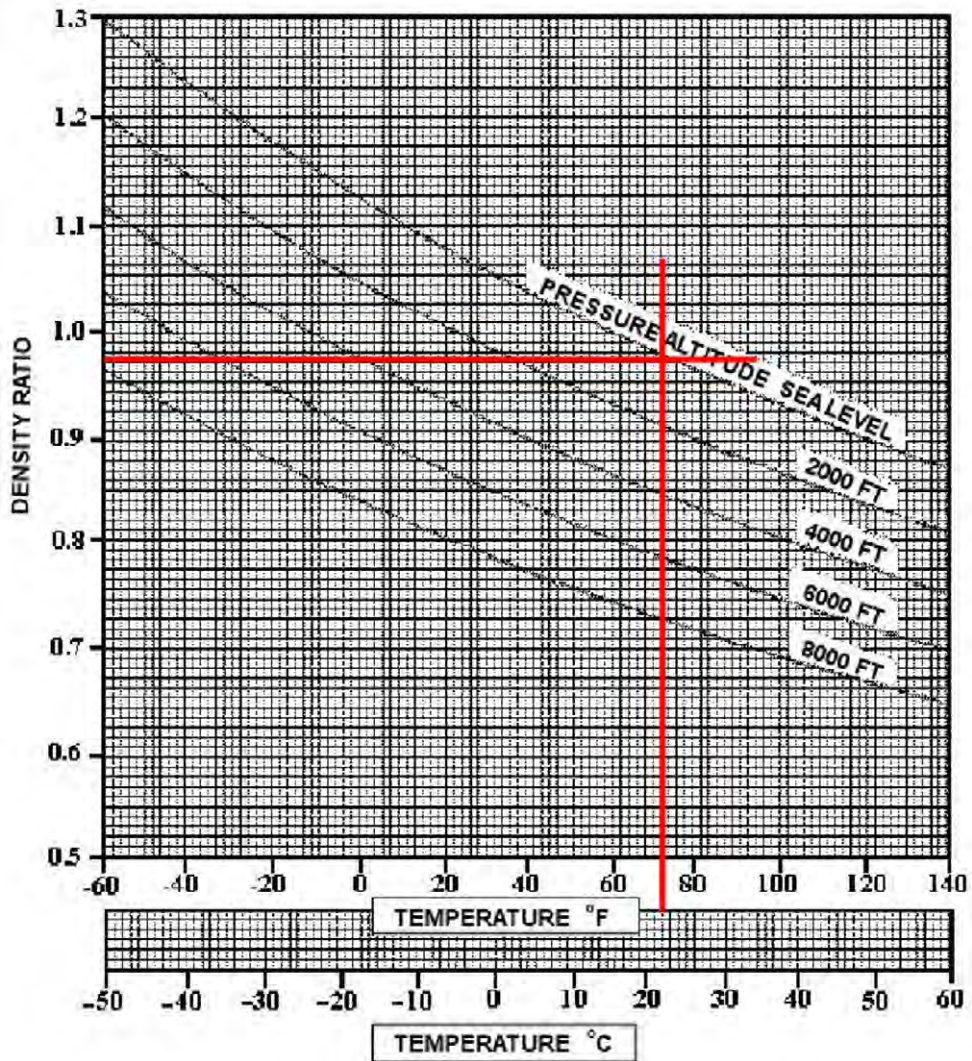

7.10.4. The MOS threshold has been designated at the 4,000-foot point and the departure end at the 9,000-foot point corresponding to the desired 5,000-foot MOS required by the ICC. A crosscheck on the adequacy of this length will be made shortly using the RQC aircraft charts.

7.10.5. The next step is to determine what aircraft charts are needed. All such charts are contained in T.O. 35E2-4-1; therefore, we must have a copy of this T.O. readily available. [Table 7.1.](#) provides a summary of some of the available RQC aircraft charts. The summary indicates that for F-16B takeoffs, Chart D1 is required and for F-16B landings, Chart D2 is necessary. Because the ICC indicated a desire for an aircraft arresting system, Chart D3 is also gathered. These chart numbers are noted in the Chart # column of Worksheet 1 ([Figure 7.11.](#)).



**Table 7.1. RQC Chart Summary.**

Type Aircraft	RQC Chart #	Operation	Type Aircraft	RQC Chart #	Operation
F-15A/B	C1	Takeoff Landing-Aero-braking	F-111A/3	E1	Takeoff Landing Landing-Short Field
	C2 Lan	ding-Wheel Braking		E2	Landing-Arrestment Evacuation
F-15C/D	C3	Landing Arrestment Evacuation	C-5B	E3	Takeoff Landing
	C4	Takeoff Landing-Aero-braking	C-130E/H	E4	Landing Takeoff
F-15E	C5 Lan	ding-Wheel Braking		E5	Landing Heavy Weight Takeoff
	C6 Lan	ding Arrestment	C-141A/B HEAVY	F1	Heavy Weight Landing Medium Weight Takeoff
	C7 Ev	acuation	C-141A/B	F2	Medium Weight Landing
F-16A/B BLOCK	C8	Takeoff Landing Landing Arrestment	A-7D	G1	Takeoff Landing
	C9	Evacuation Takeoff		G2	Landing-Arrestment Evacuation
	C10	Landing Landing-Arrestment	A-10A H1		Takeoff Landing
	C11 Evacuation			H2	
	C12			I1	
	C13			L2	
	C14		J1		
	D1	J2			
	D2			J3	
	D3 J4				
	D4			K1	
				K2	

Figure 7.11. Worksheet 1, Chart Number Entered.

REPAIR QUALITY CRITERIA (RQC) ENVIRONMENTAL DATA							
TEMPERATURE (°F)		72	MDS THRESHOLD (Feet)	4,000	RQC		0.0
ALTITUDE (FT)		Sea Level	DEPARTURE END (Feet)	9,000	RQP (Choose One)		<input checked="" type="checkbox"/> DRY <input type="checkbox"/> WET <input type="checkbox"/> ICY
DENSITY RATIO		.97	MDS LENGTH (Feet)	5,000 x 60	DIRECTION (Choose One)		CHART
OPERATION NUMBER	AIRCRAFT MODEL	GROSS WEIGHT (Lbs)	OPERATION	SPECIAL LANDING PROCEDURES	DIRECTION (Choose One)		CHART
1	F-16B	33,000	Take Off		<input checked="" type="checkbox"/> FROM MDS THRESHOLD <input type="checkbox"/> FROM DEPARTURE END		D1
2	F-16B	22,800	Landing		<input checked="" type="checkbox"/> FROM MDS THRESHOLD <input type="checkbox"/> FROM DEPARTURE END		D2
3	F-16B	22,800	Landing	Barrier	<input checked="" type="checkbox"/> FROM MDS THRESHOLD <input type="checkbox"/> FROM DEPARTURE END		D3
4	F-16B	33,000	Takeoff		<input type="checkbox"/> FROM MDS THRESHOLD <input checked="" type="checkbox"/> FROM DEPARTURE END		D1
5	F-16B	22,800	Landing		<input type="checkbox"/> FROM MDS THRESHOLD <input checked="" type="checkbox"/> FROM DEPARTURE END		D2
6	F-16B	22,800	Landing	Barrier	<input type="checkbox"/> FROM MDS THRESHOLD <input checked="" type="checkbox"/> FROM DEPARTURE END		D3
					<input type="checkbox"/> FROM MDS THRESHOLD <input type="checkbox"/> FROM DEPARTURE END		
					<input type="checkbox"/> FROM MDS THRESHOLD <input type="checkbox"/> FROM DEPARTURE END		

AFTO FORM 71.19960901 (IMT-V1)

7.10.6. The data and charts gathered so far enable us to make determinations of operation lengths necessary for F-16B sortie generation from the selected MOS. The determination of operation length for the takeoff of the F-16B is determined by using aircraft Chart D1 (Figure 7.12.). A horizontal line is drawn across the DR section corresponding to the .97 DR value until it intersects the section's shaded area. A vertical line is then dropped to the location baseline and a reading taken. For our example, the takeoff operation length is 3,525 feet. Enter this number in the operations length column of Worksheet 1 for operations 1 and 4.

Figure 7.12. Operational Lengths Identified on F-16B Takeoff Chart.

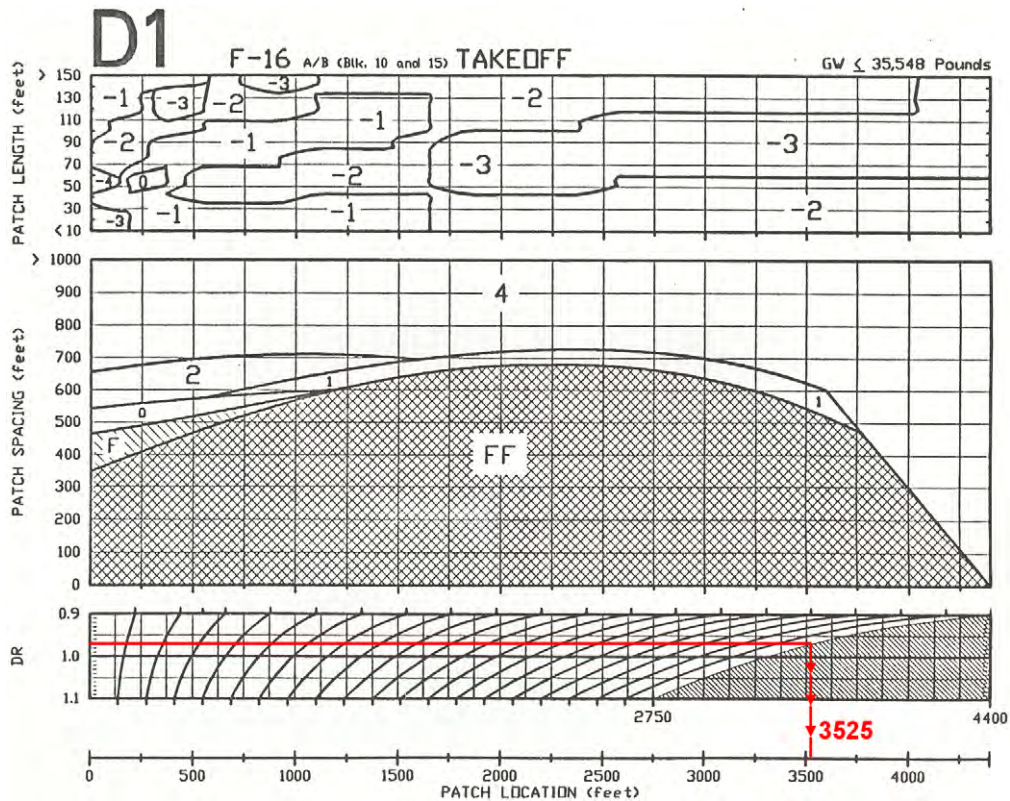

7.10.7. Using Chart D2 for landings, a horizontal line is drawn across the entire DR section corresponding to the .97 DR value (Figure 7.13.). Now, find the point where the line intersects the shaded part of the DR section.

7.10.7.1. From this point of intersection, a vertical line is drawn up to the RCR section until it intersects the horizontal line representing “dry” conditions. Because no shift is caused by the RCR section under “dry” conditions, another vertical line is drawn from the RCR intersection point down to the location baseline. The reading at the intersection of this second vertical line and the location baseline is the operation length required for MOS landings in dry conditions. This value is approximately 4,400 feet in our example.

Figure 7.13. Operational Lengths Identified on F-16B Landing Chart.

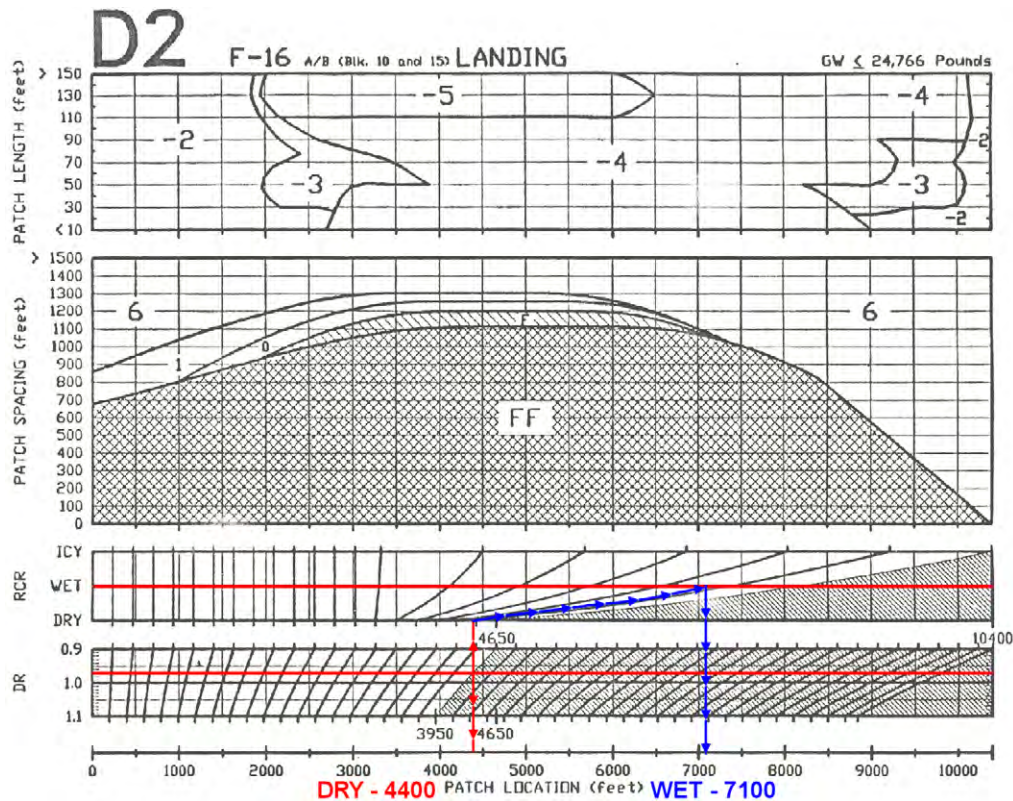

7.10.7.2. If “wet” conditions were expected to be prevalent, the horizontal line on the RCR section representing “wet” conditions would be used. In this case, the vertical line from the DR shaded area intersection that was drawn up to the bottom of the RCR section would be shifted to account for “wet” conditions (Figure 7.13.). This shift would follow the guidelines proportionally from the bottom of the RCR section until the horizontal line representing “wet” conditions was reached. In drawing the shift line from the bottom of the RCR chart up to the “wet” conditions horizontal line, it is important to stay between the guidelines in proportion to the starting location at the bottom of the RCR section. From this new intersection, a vertical line would then be drawn down to the location baseline and the appropriate operation length read (approximately 7,100 feet). As would be expected, the new operation length under “wet” conditions would be considerably longer than that obtained when under “dry” conditions. The dry and wet distances are entered in the operational length column of Worksheet 1 for operations 2 and 5. Note that the landing operation lengths for wet conditions are more than the 5,000-foot length requested by the ICC, therefore the 5,000-foot length is obviously inadequate. This would require that all landings in wet conditions use the aircraft arresting system until the MO S length can be extended beyond 7,100 feet. This information must be passed to the ICC since flight safety and mission effectiveness would be involved.

7.10.8. Now the operation distance must be found for arrested landings. Chart D3 indicates that at least 2,034 feet of pavement length is required for an arrested F-16B landing (Figure 7.14.).



Figure 7.14. Operational Lengths Identified on F-16B Landing-Arrestment Chart.

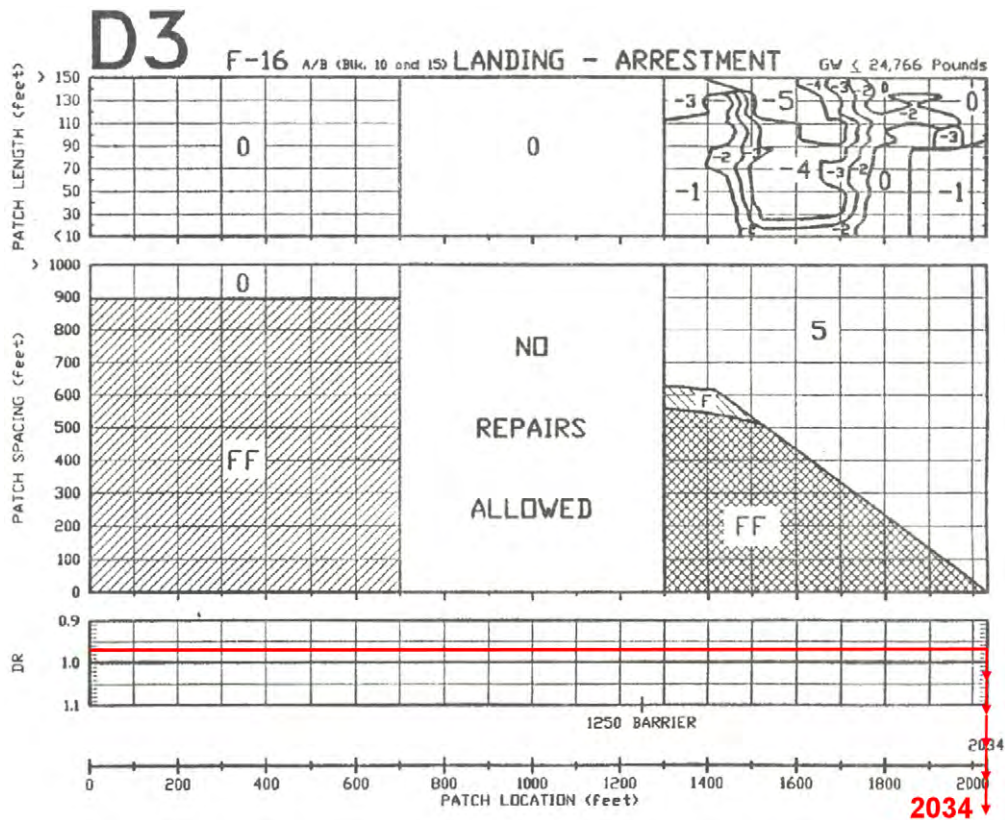

7.10.9. Entries in Worksheet 1 shown in Figure 7.15. illustrate the operation distances determined above for aircraft traveling south to north (360 degree heading) on the selected MOS.

Figure 7.15. Worksheet 1 Complete.

REPAIR QUALITY CRITERIA (RQC) ENVIRONMENTAL DATA							
TEMPERATURE (°F)	72		MDS THRESHOLD (Feet)	4,000		RSC	0.0
ALTITUDE (FT)	Sea Level		DEPARTURE END (Feet)	9,000		RCR (Choose One)	<input checked="" type="checkbox"/> DRY <input type="checkbox"/> WET <input type="checkbox"/> ICY
DENSITY RATIO	.97		MDS LENGTH (Feet)	5,000 x 60			
OPERATION NUMBER	AIRCRAFT MODEL	GROSS WEIGHT (Lbs)	OPERATION	SPECIAL LANDING PROCEDURES	DIRECTION (Choose One)	CHART	OPERATION LENGTH (Feet)
1	F-16B	33,000	Take Off		<input checked="" type="checkbox"/> FROM MDS THRESHOLD <input type="checkbox"/> FROM DEPARTURE END	D1	3,525
2	F-16B	22,800	Landing		<input checked="" type="checkbox"/> FROM MDS THRESHOLD <input type="checkbox"/> FROM DEPARTURE END	D2	4,400 dry 7,100 wet
3	F-16B	22,800	Landing	Barrier	<input checked="" type="checkbox"/> FROM MDS THRESHOLD <input type="checkbox"/> FROM DEPARTURE END	D3	2,034

7.10.9.1. After determining operation lengths in the South to North direction (360 degree heading), the next steps in the RQC process involve defining repair patches and identifying the repair patch locations, lengths, and spacing. Accomplish the graphics work to support these activities on

the same air base maps where airfield damages were plotted in the EOC and DCC. **Figure 7.8.** depicts the repair patch definition for the two craters on the MOS in our example. To define the repair patches, the following actions are taken.

7.10.9.1.1. To define the repair patches, draw lines the entire width of the MOS on both sides of each crater on, or partially on, the MOS.

7.10.9.1.2. Shade the areas on the MOS between the lines for each repair.

7.10.9.1.3. Number each crater consecutively starting from the MOS threshold. Two points pertaining to repair patch definition need to be mentioned before we move on. First, if two or more shaded areas are within 25 feet of each other, treat them as one large repair patch. Secondly, for bidirectional MOSs, RQC will be determined from both directions and the operation threshold will shift from one end of the MOS to the other. The crater numbers, however, do not change when the RQC from the other direction is calculated. Once a patch is numbered, it will retain that number throughout the RQC process.

7.10.9.2. Once the repair patches are numbered, patch locations, lengths, and spacing are determined; Worksheet 2 is used to record this data and the MOS plotting map should be updated accordingly. **Figure 7.16.** depicts the data for south to north (360 degree heading) flying operations.

**Figure 7.16. South to North Flying Operations (360 degree heading).**

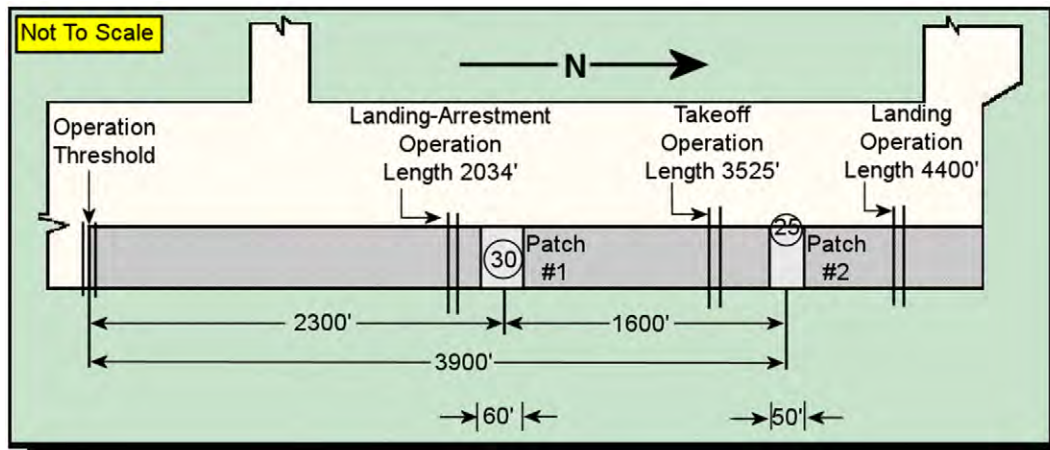

7.10.9.2.1. The first step is to draw double lines, perpendicular to the sides of the MOS, indicating the operation threshold and the operation lengths determined earlier using the aircraft charts. Then, record the operation number and patch number on Worksheet 2 for each patch between the operation threshold and double lines of each operation. For a south to north (360 degree heading) direction, the takeoff operation only includes Patch 1 and the landing operation would include both patch 1 and 2 in this example. However, there are no patches between the threshold and the double lines for the arrested landing operation.

7.10.9.2.2. The center of each repair patch is determined next—this corresponds to the station location of the crater reported during damage assessment operations. The center of Patch 1 is at the 6,300-foot point and patch 2 center is at the 7,900-foot point. Subtracting the operation threshold location point (4,000 feet) from the patch center locations provides the patch locations on the MOS. Repair patch spacing is determined by calculating the distances between the

centers of adjacent patches going in the direction of aircraft travel (i.e., patch 1 to patch 2, patch 2 to patch 3, etc).

7.10.10. When the last patch within the operation length is reached, the maximum value on the patch spacing axis on the uncorrected RQC area of the applicable aircraft chart is used as the spacing distance. In our example, the repair patch spacing between patch 1 and patch 2 is 1,600 feet. The maximum value on the patch spacing axis is 1,000 feet on Charts D1 and D3, and 1,500 on Chart D2. NOTE: The Air Force Institute of Technology determines patch spacing distance differently, because finding the “maximum value on the patch spacing axis on the uncorrected RQC area of the applicable aircraft chart” becomes quite cumbersome when dealing with several aircraft and a bi-directional MOS. They teach to insert the infinity symbol ( $\infty$ ) and go to the top of the Uncorrected RQC portion of the chart.

7.10.11. Patch length is twice the apparent diameter as reported by the damage assessment teams. Remember from the MOS selection chapter, this was the dimension used when plotting craters on the airfield map. When two patches overlap, or are within 25 feet of each other, a composite length must be calculated. In our example, the repair patches are individual, measuring 60-foot (patch 1) and 50-foot (patch 2). **Figure 7.17.** depicts the above data for landings and takeoffs under a south to north (360 degree heading) flying operation.

**Figure 7.17. Worksheet 2—South to North Landing/Takeoff Data (360 degree heading).**

REPAIR QUALITY CRITERIA (RQC) VALUES WORKSHEET										
MDS THRESHOLD (Feet)		4,000		OPERATION #		1	2	3	4	5
DEPARTURE END (Feet)		9,000		DIRECTION		FROM MDS THR	X	X	X	
				FROM DEP END					X	X
MDS LENGTH (Feet)		5,000		OPERATION LENGTH		3525	4400	2034	3525	4400
CHART #	D.P. #/ PATCH #	PATCH LOCATION (Feet)	PATCH LENGTH (Feet)	PATCH SPACING (Feet)	UNCORRECTED RQC	CORRECTION FACTOR		RQC		
D1	1/1	2,300	60	1,000						
D2	2/1	2,300	60	1,600						
D2	2/2	3,900	50	1,500						
D3	3	-----	-----	-----						

7.10.12. Now that the patches have been defined and patch locations, lengths, and spacing determined, we can decide if the selected MOS meets the arresting system requirements. Of equal importance to the minimum arrested landing operational length is the need for having a substantial amount of undamaged pavement available prior to the arresting system location. Chart D3 ( **Figure 7.14.**) shows that approximately 550 feet of undamaged pavement is required. This distance allows a fighter aircraft to “stabilize” its movement prior to engaging the arresting system cable. This harmonics dampening is critical if the aircraft tail hook is to function properly.

7.10.12.1. In addition, Chart D3 indicates that at least 50 feet of undamaged pavement must exist beyond the arresting system. Thus, to meet the T.O. requirements, the arresting system must be placed in an area with a minimum of 600 feet of undamaged pavement for unidirectional arresting operations, or 1,100 feet of undamaged pavement for bidirectional arresting operations. To meet ACC’s requirement, no less than 1,050 feet of undamaged pavement is required for unidirectional arrested landing operations, and 2,000 feet of undamaged pavement for bidirectional arrested landing operations.

7.10.12.2. Looking at the example, if the arresting system was installed at the 1,250-foot position from the operation threshold in the 360 degree heading, there would be 1,250 feet of undamaged pavement prior to the arresting system and 1,020 feet beyond the arresting system. These distances meet the more stringent ACC requirements for bidirectional operation of the arresting system (Figure 7.18.); subsequently, its operation would be recommended. A change in the landing threshold location for operations in the 180-degree heading may be necessary to prevent the aircraft's tail-hook from snagging on the edge of Patch 1 before engaging the arresting system. The threshold location change will have to be a decision made by the wing command element.

Figure 7.18. Arresting System Location Identified.

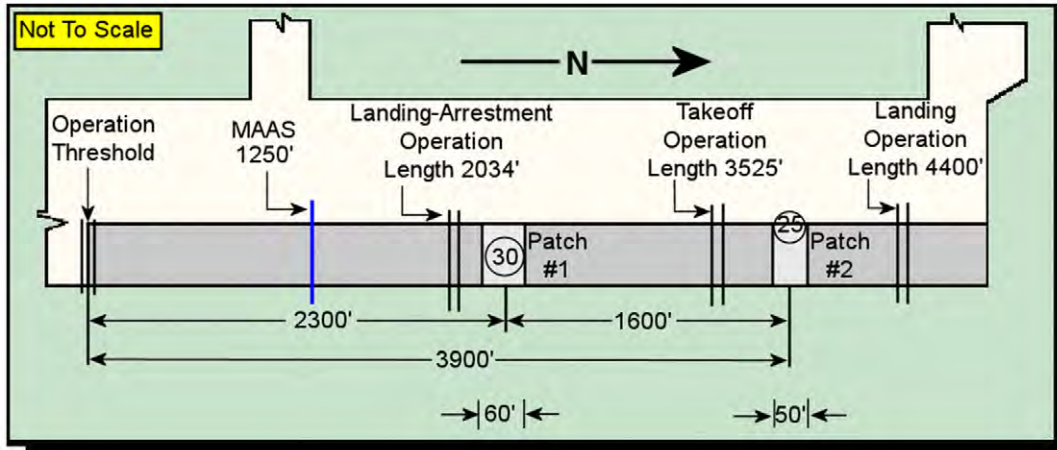

7.10.12.3. Due to the complexities introduced by offsetting the operation threshold for operation 6, the ICC Commander made the decision to eliminate that operation. During the MOS selection process, the MOS briefer identified that shifting the operation 6 threshold to the 6500' point would severely decrease the effectiveness of the visual/instrument landing aids, as well as a failed MAAS engagement would not give the pilot enough time to get the aircraft back in the air.

7.10.13. Because a bidirectional operation is desired, the same data that was determined above must also be determined for a north to south (180 degree heading) flying operation. Figure 7.19. shows the dimensions for this situation and Figure 7.20. illustrates the resulting entries on Worksheet 2.



Figure 7.19. North to South Flying Operation (180 Degree Heading).

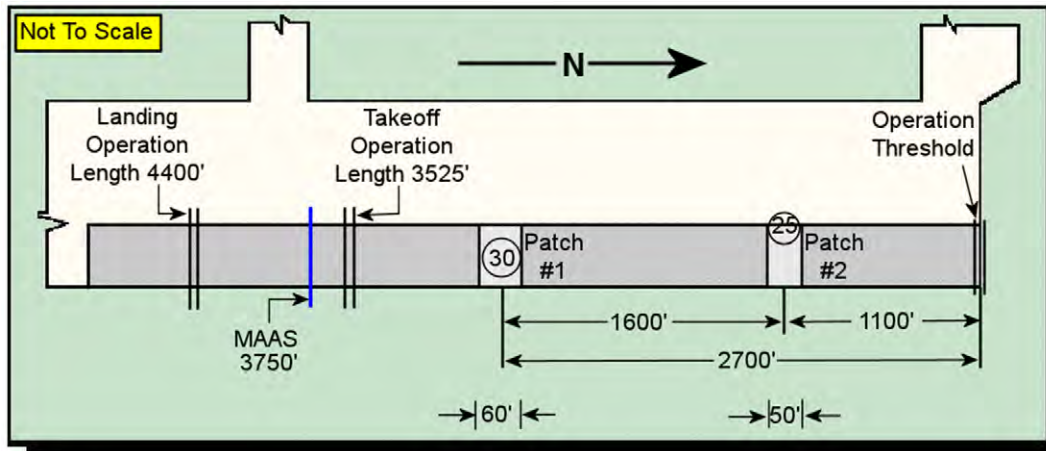

Figure 7.20. Worksheet 2—North to South Landing/Takeoff Data (180 degree heading).

REPAIR QUALITY CRITERIA (RQC) VALUES WORKSHEET										
MDS THRESHOLD (Feet)	4,000		OPERATION #		1	2	3	4	5	
DEPARTURE END (Feet)	9,000		DIRECTION		FROM MDS THR	X	X	X		
					FROM DEP END			X	X	
MDS LENGTH (Feet)	5,000		OPERATION LENGTH		3525	4400	2034	3525	4400	
CHART #	D.P. #/ PATCH #	PATCH LOCATION (Feet)	PATCH LENGTH (Feet)	PATCH SPACING (Feet)	UNCORRECTED RQC	CORRECTION FACTOR		RQC		
D1	1/1	2,300	60	1,000						
D2	2/1	2,300	60	1,600						
D2	2/2	3,900	50	1,500						
D3	3	-----	-----	-----						
D1	4/2	1,100	50	1,600						
D1	4/1	2,700	60	1,000						
D2	5/2	1,100	50	1,600						
D2	5/1	2,700	60	1,500						

7.10.14. The dimensional data obtained so far allows determination of the RQC for all repair patches for each individual aircraft operation over the selected MOS. Beginning first with the takeoff operation from the south to north (360 degree heading) direction, the patch lengths, locations, and spacing are marked on the D1 aircraft chart. If the value for any length or spacing is greater than the maximum or less than the minimum shown on the RQC aircraft chart, the maximum or minimum dimension on the chart will be marked. The DR and RCR values should also be marked on the chart and horizontal lines drawn as was done during the operation length determinations.

7.10.15. RQC must be determined for one repair patch within the takeoff operation length. Since aircraft chart D1 has no RCR section, the RCR value is ignored.

7.10.15.1. Starting at the 2,300-foot point, a vertical line is drawn until it intersects with the DR value (Figure 7.21). The guidelines are then followed proportionally to the top of the DR section. From this point a vertical line is again drawn to the top of the RQC aircraft chart and the resulting line marked as 1/1 (represents Operation 1/Patch 1).

Figure 7.21. Patch Repair Locations, Spacings, Lengths and DR Markings.

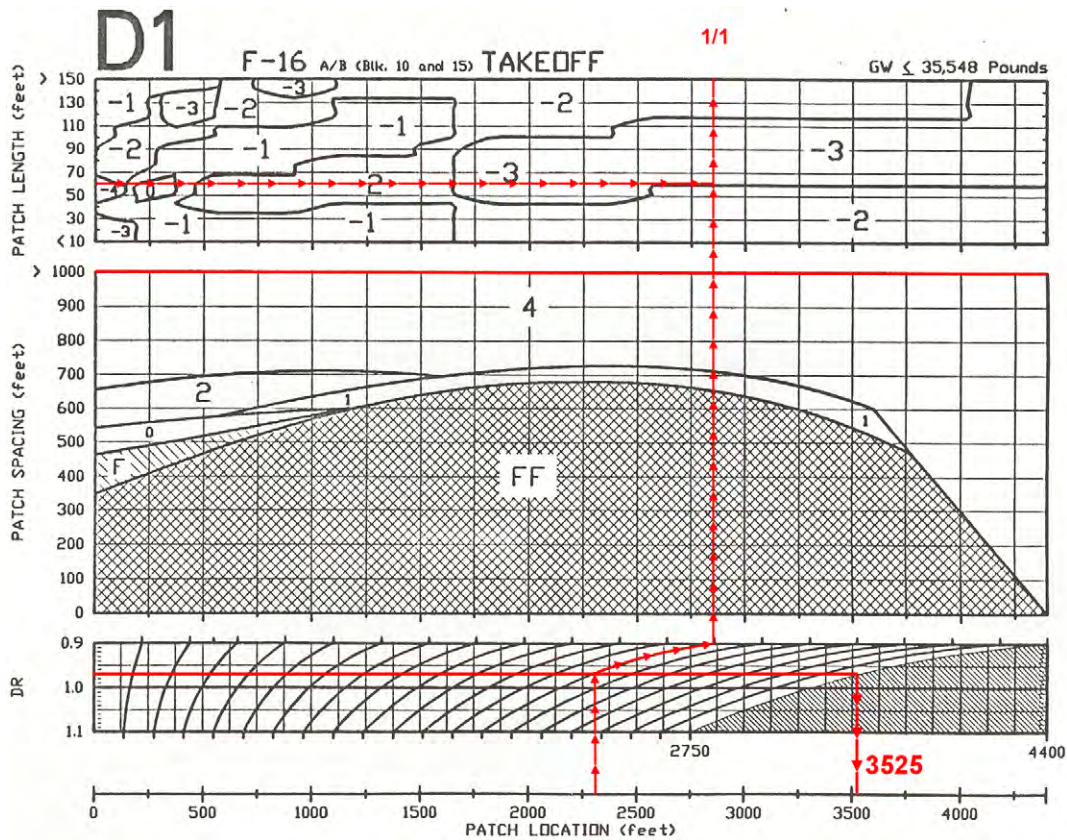

7.10.15.2. When the vertical line is completed, the uncorrected RQC value for Patch 1 is determined. Starting at the 1,000-foot point of the patch spacing axis, a horizontal line is drawn intersecting the vertical line of Patches 1. The 1,000-foot point is used since Patch 1 is the last patch in the operation length. The reading obtained at the intersection is 4, and Worksheet 2 is annotated accordingly.

7.10.15.3. Moving up to the correction factor area, a horizontal line is drawn from the repair patch length (60-foot) until it intersects with the vertical line; the reading is -3. The reading is algebraically added to the uncorrected RQC value and the resulting value (1) is entered in Worksheet 2 (Figure 7.22). Repair quality criteria calculation for Operation 1 is now complete; however, similar calculations must also be determined for Operations 2 thru 6.



Figure 7.22. Operation 1 RQC Values (Worksheet 2).

REPAIR QUALITY CRITERIA (RQC) VALUES WORKSHEET									
MDS THRESHOLD (Feet)	4,000	OPERATION #			1	2	3	4	5
DEPARTURE END (Feet)	9,000	DIRECTION			FROM MDS THR	X	X	X	
					FROM DEP END			X	X
MDS LENGTH (Feet)	5,000	OPERATION LENGTH			3525	4400	2034	3525	4400
CHART #	D.P. #/ PATCH #	PATCH LOCATION (Feet)	PATCH LENGTH (Feet)	PATCH SPACING (Feet)	UNCORRECTED RQC	CORRECTION FACTOR	RQC		
D1	1/1	2,300	60	1,000	4	-3	1		
D2	2/1	2,300	60	1,600					
D2	2/2	3,900	50	1,500					

7.10.16. Unlike the takeoff operations, both repair patches are encountered within the south to north landing operation length and RQC must be determined for both.

7.10.16.1. Starting first with Patch 1, from the 2,300-foot mark on the patch location line at the bottom of the RQC aircraft chart D2, a vertical line is drawn until it intersects with the DR value line on the DR portion of the chart. The guidelines on the DR chart are then followed proportionally until the top of the DR portion of the chart is reached (Figure 7.23.).

Figure 7.23. Patch Lengths, Locations, and Spacings Marked on D2 Chart.

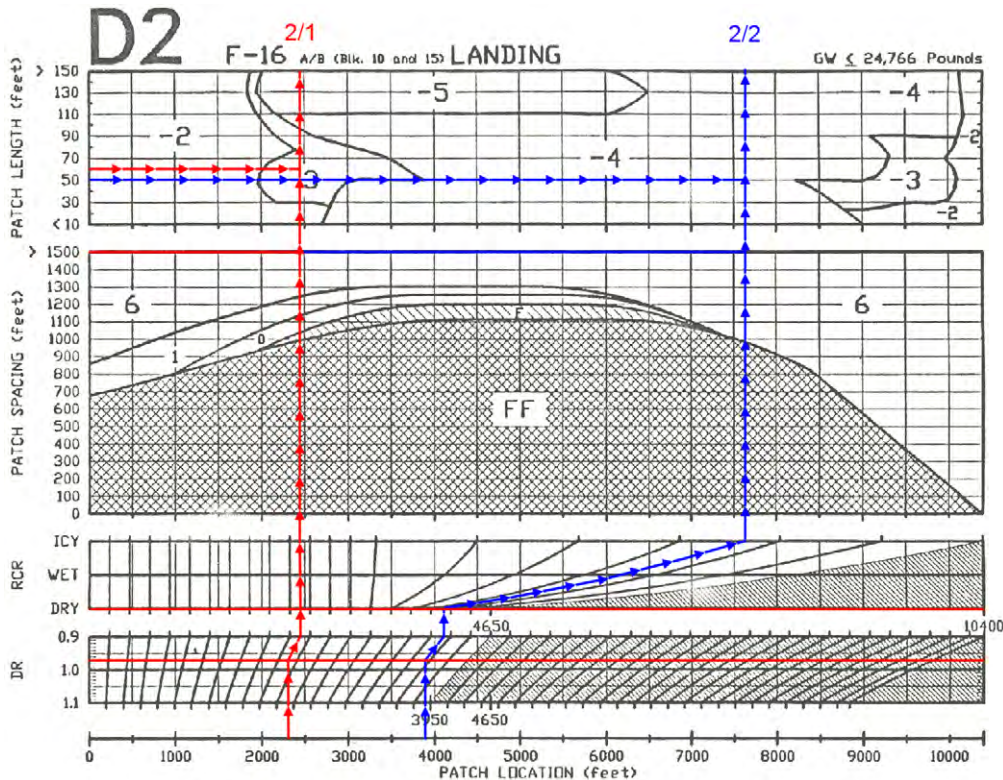

7.10.16.2. From that point, a vertical line is again drawn until it intersects the current RCR value (dry) on the RCR portion of the chart. The guidelines are once again followed proportionally to the top of the RCR section.

7.10.16.3. From this point a vertical line is drawn through the two remaining sections to the top of the RQC chart itself. The line that has been drawn is then labeled 2/1.

7.10.16.4. Now, a horizontal line is drawn from the patch spacing value (1,500 feet) on the un-corrected RQC area of the chart until it intersects the vertical line previously drawn and a reading is taken. In this case the value is 6, and this figure is entered into the uncorrected RQC column of Worksheet 2 for operation 2/1.

7.10.16.5. The last step for operation 2/1 involves determining the correction factor for the uncorrected RQC value just obtained. Using the correction area portion of the chart, a horizontal line is drawn from the patch length value (60-foot) until it intersects with the vertical line drawn earlier. The value obtained at this intersection represents a number which must be algebraically added to the uncorrected RQC value determined in the previous step. In the case of this example, the correction value is negative 3 (-3) resulting in a RQC of 3. Enter this value in the RQC column for operation 2/1.

7.10.16.6. Perform the same steps above to determine the RQC value for operation 2/2. The uncorrected values, correction factors, and the resulting corrected RQC values are entered in the appropriate columns of Worksheet 2 (Figure 7.24.). Since there are no repair patches in the operation length for Operation 3, no RQC determinations are required. Note that all correction values are either zero or negative numbers. This means that the maximum value ever obtained for a final repair patch RQC will never be greater than the uncorrected RQC value.

**Figure 7.24. Operation 2 RQC Values Added to Worksheet 2.**

REPAIR QUALITY CRITERIA (RQC) VALUES WORKSHEET										
MDS THRESHOLD (Feet)		4,000		OPERATION #		1	2	3	4	5
DEPARTURE END (Feet)		9,000		DIRECTION		FROM MDS THR	X	X	X	
				FROM DEP END					X	X
MDS LENGTH (Feet)		5,000		OPERATION LENGTH		3525	4400	2034	3525	4400
CHART #	D.P. #/ PATCH #	PATCH LOCATION (Feet)	PATCH LENGTH (Feet)	PATCH SPACING (Feet)	UNCORRECTED RQC	CORRECTION FACTOR		RQC		
D1	1/1	2,300	60	1,000	4	-3		1		
D2	2/1	2,300	60	1,600	6	-3		3		
D2	2/2	3,900	50	1,500	6	-4		2		
D3	3	-----	-----	-----						

7.10.17. Operations 4 through 5 pertain to the north to south (180 degree heading) component of the bidirectional flying operation. The RQC determinations for operations 4 and 5 are shown in Figure 7.25. and Figure 7.26. The resulting Worksheet 2 entries are depicted in Figure 7.27.



Figure 7.25. RQC Takeoff Determinations.

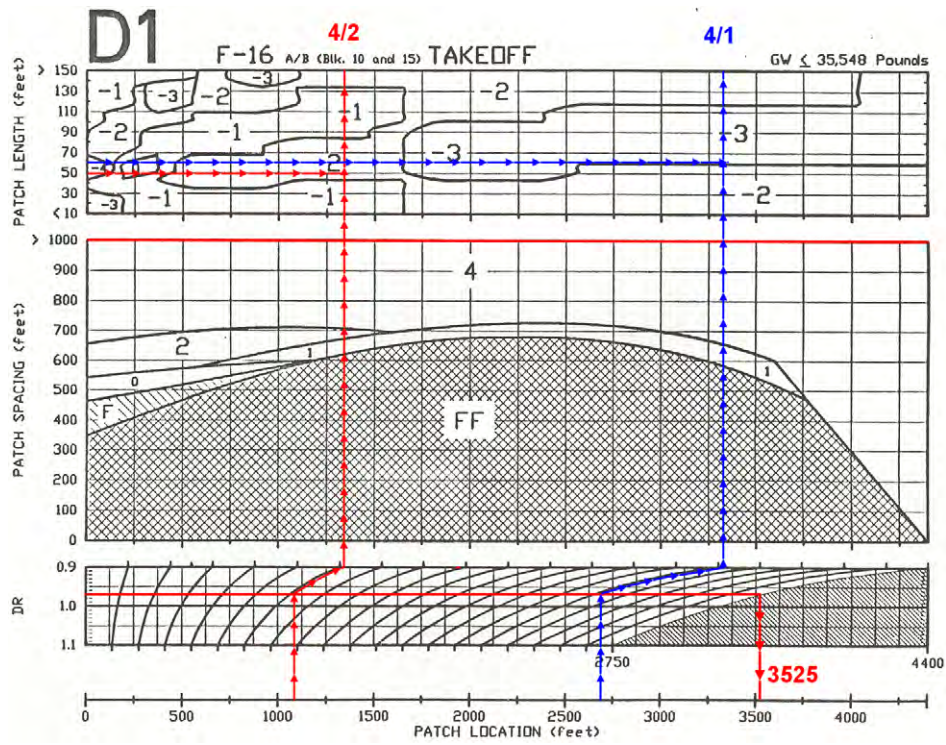

Figure 7.26. RQC Landing Determinations.

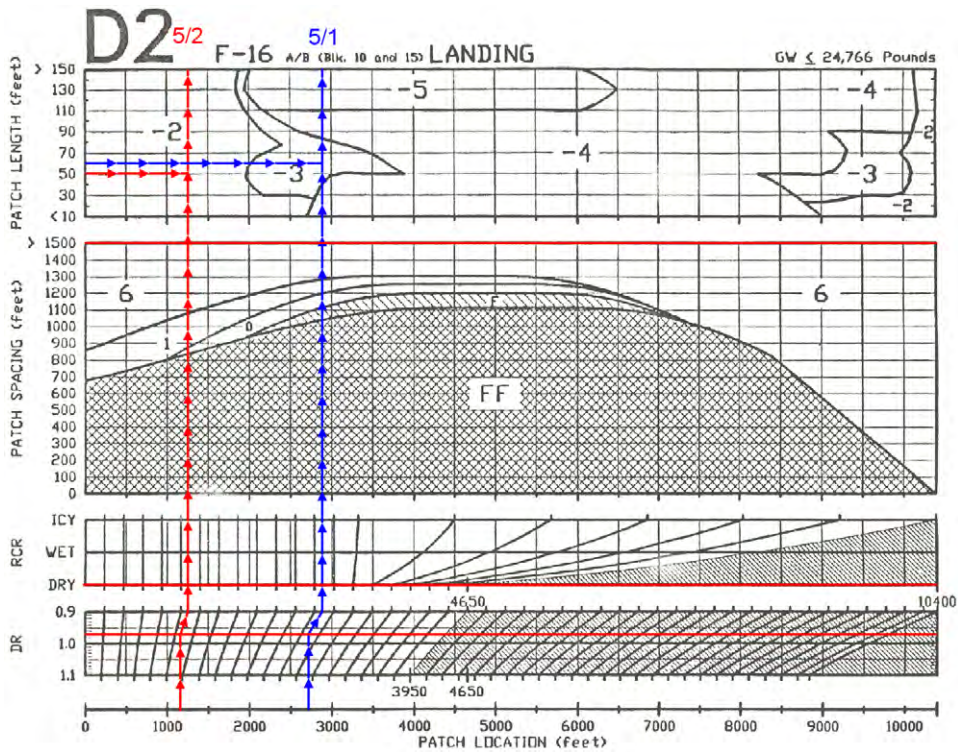

Figure 7.27. RQC Entries on Worksheet 2.

REPAIR QUALITY CRITERIA (RQC) VALUES WORKSHEET										
MDS THRESHOLD (Feet)		4,000		OPERATION #		1	2	3	4	5
DEPARTURE END (Feet)		9,000		DIRECTION		FROM MDS THR	X	X	X	
						FROM DEP END			X	X
MDS LENGTH (Feet)		5,000		OPERATION LENGTH		3525	4400	2034	3525	4400
CHART #	D.P. #/ PATCH #	PATCH LOCATION (Feet)	PATCH LENGTH (Feet)	PATCH SPACING (Feet)	UNCORRECTED RQC	CORRECTION FACTOR		RQC		
D1	1/1	2,300	60	1,000	4	-3		1		
D2	2/1	2,300	60	1,600	6	-3		3		
D2	2/2	3,900	50	1,500	6	-4		2		
D3	3	-----	-----	-----						
D1	4/2	1,100	50	1,600	4	-2		2		
D1	4/1	2,700	60	1,000	4	-3		1		
D2	5/2	1,100	50	1,600	6	-2		4		
D2	5/1	2,700	60	1,500	6	-3		3		

7.10.18. As is readily apparent, both patches 1 and 2 have differing RQC values depending on mode and direction of operation. Our final step is to summarize these values and determine which one governs the overall situation for each patch. Worksheet 3 is used for this purpose and is populated by entering data from worksheet 2.

7.10.18.1. MOS threshold end operations (south to north 360 degree heading in our example) go on the top part of the form; those from the departure end go on the bottom part of the form (Figure 7.28.). Once these figures are entered, fill in the summary lines by comparing the RQC values for each individual patch and select the most stringent (the lowest) as the summary value. While our example did not have one, an “F” (flush) value is lower than any numeric value.

7.10.18.2. Once this step is complete, compare the summary values for each repair patch and enter the most stringent of these in the “combined” line on Worksheet 3. The RQC values on the “combined” line of Worksheet 3 represent the level of quality that the ADR crews have to meet for each repair patch during ADR operations. In our example, 1-inch RQC is the lowest figure obtained. This means that a repair patch with this value can have a +1-inch bump and still be acceptable. Remember, the sag for any numbered repair (RQC#) can never exceed 2 inches for fighter aircraft and 3 inches for heavy aircraft.

7.10.19. Once all RQC data have been determined, they must be presented to the BCE in a straightforward manner. Figure 7.29. illustrates one method of presenting this data using a MOS map. The RQC values for both MOS threshold and departure end operations are shown along with the combined values for each repair patch. In most cases, the MOS will have already been chosen by the wing command element. This summary permits a quick way of informing the CE command section of RQC requirements so they can rapidly forward them to ADR crews.

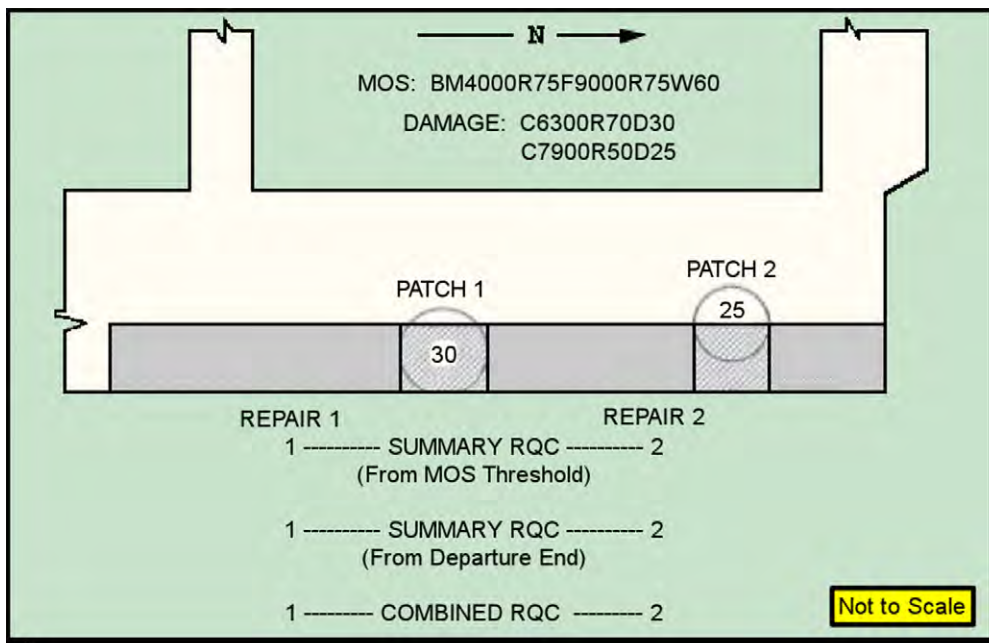

Figure 7.28. RQC Summary (Worksheet 3).

REPAIR QUALITY						
OPERATION DIRECTION		FROM MDS THRESHOLD				
OPERATION #	PATCH 1	PATCH 2	PATCH	PATCH	PATCH	PATCH
1 - Takeoff	1	---				
2 - Landing	3	2				
Summary	1	2				
OPERATION DIRECTION		FROM MDS THRESHOLD				
OPERATION #	PATCH 1	PATCH 2	PATCH	PATCH	PATCH	PATCH
4 - Takeoff	1	2				
5 - Landing	3	4				
Summary	1	2				
Combined	1	2				

AFTO FORM 73,19960901 (IMT-V1)

Figure 7.29. Summary RQC Data.



7.10.20. The following factors could influence the wing commander's decision with respect to final MOS selection:

7.10.20.1. Bidirectional versus Unidirectional Operation. In most cases, operating in a unidirectional mode will result in less stringent RQC values, which, in turn, could permit greater latitude in repair exactness. This is especially important if an ADR team is not thoroughly trained in a par-

ticular repair method. Assuming identical aircraft types and operations, a unidirectional MOS will usually have less restrictive RQC than a bidirectional MOS.

7.10.20.2. Use of Aircraft Arresting Systems. In many situations, the landing of an aircraft will require more pavement length than takeoff—especially in wet or icy conditions. If an arresting system is available, the landing length can be shortened with an accompanying decrease in the ADR effort needed. Be sure, however, that sufficient undamaged pavement exists before planning on the use of an arresting system. ACC desires about 2,000 feet of undamaged pavement to use the arresting system in a bidirectional mode.

7.10.20.3. Displacing Operation Thresholds. There may be occasions, particularly with bidirectional operations, when moving an operation threshold could decrease the RQC value for a repair patch. Look for the takeoff or landing operation that drives the lowest RQC value for a particular patch and see if moving the applicable threshold for that operation results in a less restrictive RQC value. Chances are the need for the repair patch will not be eliminated, but the degree of exactness will be lessened; thereby decreasing the potential for the repair to be out of tolerance once completed.

7.10.21. The previous paragraphs have addressed the “first round” determination of RQC values. As mentioned earlier, once repairs are completed and more accurate dimensions (repair lengths, locations, and spacing) are obtained, it is extremely critical to repeat the RQC process to ensure aircraft operations can safely continue.

**7.11. Final Considerations.** As brought out early in this chapter, repair quality criteria determination is an integral part of the ADR base recovery effort and its importance cannot be overshadowed by the pace of recovery activities and pressures of the postattack environment. A single mistake in the RQC process can be catastrophic with respect to the aircraft sortie generation capability. Some key points and responsibilities deserve final mention.

7.11.1. A current copy of T.O. 35E2-4-1 with all up to date changes must be readily available. RQC determination cannot be accomplished without this publication.

7.11.2. Specific personnel must be fully trained in RQC determination procedures. As a minimum, all officers and Engineering (AFS 3E5X1) personnel should be capable of performing this task.

7.11.3. Training on RQC procedures must be extensive. Personnel must be able to perform RQC determinations without hesitation. There will be no time for practice or OJT during base recovery.

7.11.4. Airfield damage repair team chiefs must know and understand the importance of RQC determination. They must obtain and report accurate dimensions on repair patch sizes and locations as soon as they are available in the field. Furthermore, they must organize and use their resources in such a manner that the most critical repairs receive the most attention.

7.11.5. Senior civil engineers must be able to explain and defend the importance of RQC determinations to the base and wing command elements. This must be practiced in peacetime during training exercises; otherwise, it will be difficult to tell the commander that his/her aircraft cannot be flown during wartime due to the results obtained from a series of charts and dimensions.

**7.12. Chapter Summary.** This chapter has presented the concept and procedures for repair quality criteria determination. The RQC process forms the link between completed ADR efforts and the commencement

of flying operations after an attack. As such, it must receive close attention from the command element of a civil engineer unit.

7.12.1. Once the MOS repair locations have been identified, airfield damage repair teams attempt to make flush repairs on MOS surfaces, but this level of precision is difficult to obtain under wartime conditions. The RQC process provides a method of determining the degree of tolerance allowed for each repair that will permit launch and recovery operations without aircraft damage. Repair quality criteria procedures account for differing aircraft characteristics; weather and pavement surface conditions; dimensions and spacing of repair areas; and the types of operations aircraft are expected to perform. The end result of RQC determinations is a value for each repair area, normally expressed in inches, which provides the ADR teams with pass/fail criteria to apply against their crater repair activities. These values can range from perfectly flush up to 6 inches above adjacent undamaged pavement surfaces. If completed crater repairs do not meet RQC values, the repairs must normally be reaccomplished before aircraft operations can commence.

7.12.2. Repair quality criteria determination provides a go/no go decision situation to the wing command structure. Accuracy in performing the RQC process is therefore critical, since faulty data could mistakenly delay aircraft launch or create extremely dangerous flying conditions. The appropriate engineer personnel responsible for RQC determination must be highly trained and capable of performing RQC calculations quickly and flawlessly.

## Chapter 8

### RESOURCE REQUIREMENTS

**8.1.** Overview. Engineer forces require proper equipment and adequate personnel to accomplish rapid repairs to war damaged airfield pavements after seizing an enemy's airbase, when assuming or sharing a friendly host nation's airfield, or at a US Air Force MOB overseas.

8.1.1. After seizing an enemy's airbase, it is anticipated that an airborne RED HORSE and CRGs will accomplish initial airfield pavement repairs with their own equipment and personnel. Afterwards, Prime BEEF units will deploy towards the tail end of the "open the airbase" force module to establish, operate, and sustain the flying mission with additional airfield repairs. Prime BEEF personnel and equipment UTCs will be tailored to accomplish the required repairs. Use of local materials, equipment, and labor to augment US forces often provide repairs that meet mission needs while reducing costs and demands on logistic support systems.

8.1.2. When assuming or sharing a coalition partner's airfield, pavement repairs are often required to meet US flight safety requirements. Prime BEEF units will be brought in to establish, operate, and sustain the flying mission with required airfield repairs. As in the "seize the base" scenario above, Prime BEEF personnel and equipment UTCs will be tailored to accomplish necessary repairs. Again, use of local materials, equipment, and labor to augment US forces often provide repairs that meet mission needs while reducing costs and demands on logistic support systems.

8.1.3. To fulfill the MOB recovery requirement, the Air Force has developed equipment sets for accomplishing airfield pavement repairs at MOBs. Furthermore, Air Force Prime BEEF teams are configured to provide sufficient numbers of personnel to adequately man these equipment sets. The following paragraphs describe the equipment sets and provide recommendations on use of Prime BEEF forces for optimum manning for ADR operations.

**8.2.** Heavy Equipment Requirements for Recovery After Attack. The Air Force has developed standardized equipment and vehicle sets for accomplishing expeditious airfield pavement repairs. At present, there are three fielded ADR sets (R-sets) in a building-block manner to provide a designated crater repair capability.

8.2.1. R-Sets. The minimum ADR package designed to deal with a possible air attack threat to an air base is the R-1 set. This set provides the vehicles, equipment, and material needed by a base to form three crater crews, each capable of repairing one crater in 4 hours. If the threat analysis for a given base indicates that an R-1 set capability is insufficient, additional vehicles and equipment should be obtained to bring the unit's ADR recovery package level up to an R-2 set. The R-2 set gives the base the capability to form six crater repair teams each able of repairing one crater in 4 hours. Consequently, an R-2 set provides a base the ability to repair six craters in 4 hours. However, if the enhanced R-2 set capability is still inadequate to meet the perceived threat, the base should posture an R-3 set. An R-3 set provides yet more vehicles and equipment, enabling six crater repair teams to repair two craters each, or 12 craters in 4 hours.

8.2.1.1. Basic (R-1) ADR Set. The basic set was developed by the Air Force to provide an expedient bomb damage repair capability to theater air bases. This set supports the repair of three 50-foot bomb craters with an AM-2 or FFM FOD cover within 4-hours. The basic ADR set is cur-

rently in place at most high-threat theater MOBs. The vehicle and equipment items of the R-1 set are shown in [Table 8.1](#).

**Table 8.1. R-1 Vehicle and Equipment Set.**

VEHICLES	QTY
Excavator 3	
Grader	3
Dozer (T-7)	3
Front-End Loader (4-cy)	6
Front-End Loader (2.5-cy)	3
Vibratory Roller	3
Dump Truck (8-cy)	8
Dump Truck (5-ton)	4
Tractor (7.5-ton)	3
Tractor (10-ton)	3
Trailer (22-ton)	3
Trailer (60-ton)	3
Vacuum Sweeper	2
Tractor Mounted Sweeper (ADR)	2
Paint Machine (Part of MAOSMS)	2
HMMWV	2
ADR Trailer	3
1,500-Gallon Water Truck	3
Dolly Converter (8-ton)	3
Basic ADR Equipment Support Kit	1
Basic ADR Airfield Lighting Kit	1
AM-2 ADR FOD Cover Kit	*3/6/9
AM-2 Support Kit	*1/2
Folded Fiberglass Mat FOD Cover Kit (Kit-A)	1
Folded Fiberglass Mat FOD Cover Kit (Kit-B)—Anchoring Systems	2
Spall Repair Kit	4
Minimum Airfield Operating Strip Marking System (MAOSMS)	1
*The specific quantities needed at a given MOB will depend upon the perceived threat.	

8.2.1.2. Supplemental (R-2) Set. The R-2 set contains additional vehicles and equipment which are additive to the R-1 set. The combined R-1 and R-2 sets provide the capability to form six crater



repair teams (three on the MOS and three on taxiways), each able to repair one crater in 4 hours. Thus, the R-1/R-2 combination permits the repair of six craters in 4 hours. **Table 8.2.** shows the R-2 vehicle and equipment additives.

**Table 8.2. R-2 Vehicle and Equipment Set Additives.**

VEHICLES	QTY
Excavator 3	
Front-End Loader (4-cy)	3
Front-End Loader (2.5-cy)	3
Vibratory Roller	3
Dump Truck (8-cy)	7
HMMWV	4
ADR Trailer	3
Floodlight/Generator Set	6
Generator Set (Diesel)	1

8.2.1.3. Supplemental (R-3) Set. The R-3 set provides yet more vehicles, enabling six crater repair teams (three on the MOS and three on taxiways) to repair two craters each, or a total of 12 craters within 4 hours. Only a few theater main operating bases have the R-3 package, since current threat scenarios indicate a limited requirement for this configuration. **Table 8.3.** identifies the R-3 additives.

**Table 8.3. R-3 Vehicle and Equipment Set Additives.**

VEHICLES	QTY
Front-End Loader (4-cy)	4
Dump Truck (8-cy)	7
Vacuum Sweeper	2
Dirt Sweeper (ADR)	5
Floodlight/Generator Set	6

**8.3. Personnel Requirements.** Air Force Prime BEEF teams are configured to provide sufficient numbers of personnel to adequately man the equipment sets described above. In a situation that dictates the use of the full R-1 through R-3 equipment and vehicle packages, present Prime BEEF planning and force employment concepts envision that personnel identified in **Table 8.4.** be used. While the full 189-person engineer complement of these UTCs will not be employed solely in the ADR role, the vast majority of personnel will be dedicated to this tasking. Normal exclusions include individuals involved in command center (EOC/DCC), damage assessment, facility/utility recovery activities, CBRN defense assessment, EOD safing operations, and firefighting functions.

**Table 8.4. R-3 Personnel Requirements.**

UTC	Function	UTC QTY	Persons per UTC	Total # of Persons
4FPET Core	Team	6	26	156
4FPES C2		1	6	6
4FPAL LFM		2	2	4
4FPAP Power	Pro	3	2	6
4FPAR HV	AC/R	1	3	3
4FPAT	Structures 1 3			3
4FPAX Pest	Mngt	2	2	4
4FPAN Superintendent		5	1	5
4FPSA Of	ficer	1	1	1
4FPSB Of	ficer	1	1	1
Total				189

8.3.1. **Figure 8.1.** depicts an example of how this multi-Prime BEEF team configuration could be organized to satisfy a six-crater ADR requirement employing only an R-1 and R-2 set. In particular, it illustrates the ADR team configuration using folded fiberglass mats for both MOS and taxiway repairs. However, employing this same configuration, AM-2 matting could be used on the taxiways in place of FFM, and still achieve satisfactory results within the same 4-hour time constraint.

8.3.1.1. With the multi-skilling features of our training programs, many AFS combinations are possible. In this example, 36 individuals remain untasked (primarily in the utilities areas) whom could be used to support utility/facility damage recovery identified by the DARTs.

8.3.1.2. However, when it comes to ADR, one discipline where latitude is notoriously limited is construction equipment operators (3E2X1). This is one field where the ADR command and control functions must be fully aware of the capabilities and limitations of their personnel in order to realize optimization of the resource.

8.3.2. When theater intelligence indicates that the anticipated threat will entail repairing twelve or more craters, an R-3 set will be required and team manning must be increased by about 20 personnel—mainly for equipment operation purposes. With an R-3 set and proper manning, each crater crew is expected to repair two craters within the same maximum 4-hour time frame. However, if the conflict situation results in a less than six crater repair requirement, various subsets of these configurations should be employed. For the most part, this simply involves decreasing the number of crater repair crews and proportionally downsizing the personnel strength of the hauling team.

Figure 8.1. Typical R-1/2 Set Organization Using FFM for both MOS & Taxiway.

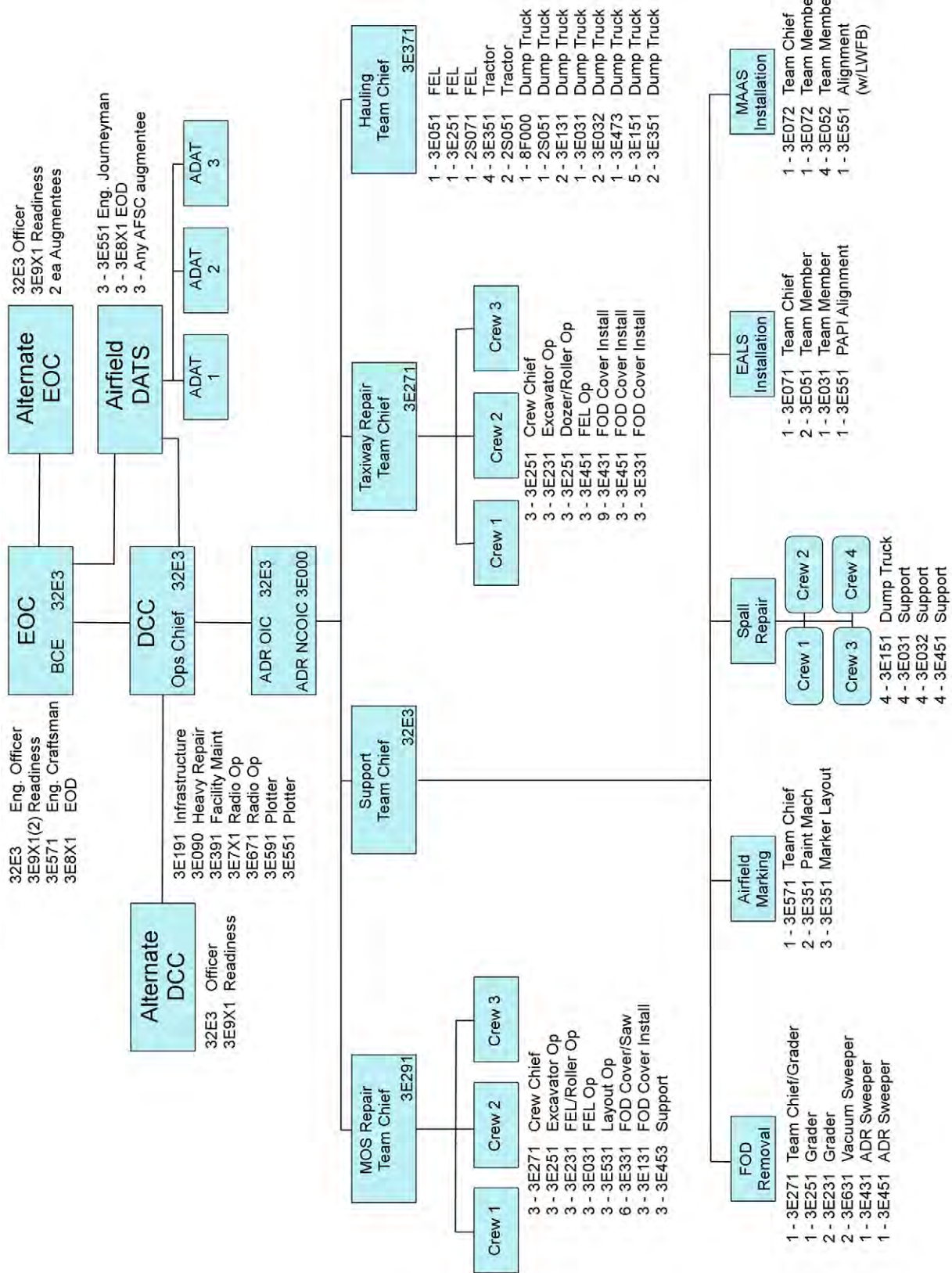

8.3.3. As a general rule of thumb, use the following numbers for planning purposes: adequate manning of an R-1 set requires approximately 100 personnel, while an R-1/R-2 combination requires approximately 125 personnel, and an R-1/R-2/R-3 combination requires approximately 140 personnel. When it comes to rapid ADR, the consequences of inadequate training cannot be overemphasized. An ill-prepared ADR team properly manned and equipped will have great difficulty accomplishing their mission within the mandated 4-hour time requirement. Furthermore, keep in mind that these figures are only for the ADR team; additional personnel will be required for staffing command and control centers as well as manning the various airfield and base-proper damage assessment teams. Details regarding additional team manning requirements are presented in volume 1, chapter 4 of this pamphlet series.

8.3.4. R-Set Manning. Teams assigned with R-sets should be manned as depicted in [Table 8.4.](#) and [Table 8.5.](#) respectively. The tables reflect only dedicated manning. For instance, FFM personnel are used on both taxiways and the MOS, whereas, AM-2 mat personnel are usually employed only on taxiway and ramp repairs.

**Table 8.5. Personnel Requirements (Not Cumulative).**

Team	Position	R-1 Set	R-2 Set	R-3 Set
Command and Control (C2)	ADR OIC	1	1	1
	ADR NCOIC	1	1	1
	Support Team OIC	0	1	1
MOS Crater Repair Crews (3 each)	Team Chief	1	1	1
	Crew Chief	3	3	3
	Excavator 3		3	3
	Front End Loader (FEL)	6	6	6
	Eng Tech. (3E5X1)	3	3	3
	MOS Layout Support	6	6	6
	Vibratory Roller	3	3	3
	FOD Cover (FFM)	6*	6*	6*
	Saw System (Optional)	6	6	6
	Water Truck (Optional)	3	3	3
	Dozer 3		0	0
Taxiway Crater Repair Crews (3 each)	Team Chief	0	1	1
	Crew Chief	0	3	3
	Excavator 0		3	3
	FEL 0		3	6
	FOD Cover (FFM/AM-2)	6/27	6/27	6/27
	Dozer/Vibratory Roller	0	3	3

Team	Position	R-1 Set	R-2 Set	R-3 Set
Hauling Crew	Team Chief	1	1	1
	FEL 3		6	7
	Tractor	6	6	6
	Dump Truck	8	15	22
FOD Removal Crew	Grader	3	3	3
	Vacuum Sweeper	2	2	4
	ADR Kick-broom	2	2	7
MOS Layout and Marking Crew	Paint Machine	2	2	2
	Support 4		4	4
Spall Repair Crews (4 each)	Dump Truck	4	4	4
	Support 12		12	12
*Only dedicated resources are reflected. Optimum crew size for installing FFM FOD covers is six (two dedicated to this task and four assigned to other tasks). As other tasks near completion, some personnel will be available to assist in FFM cover installation.				

**Table 8.6. Vehicle Assignments (Not Cumulative).**

Team	Vehicles	R-1 Set	R-2 Set	R-3 Set
ADR OIC	HMMWV	1	1	1
ADR NCOIC	HMMWV	1	1	1
Support Team OIC	HMMWV	0	1	1
MOS Crater Repair Crews (3 each)	HMMWV 0		1	1
	Excavator 3		3	3
	2.5-cy FEL	3	3	3
	4-cy FEL	3	3	3
	Dozer 3		0	0
	Vibratory Roller	3	3	3
	ADR Trailer	3	3	3
	Water Truck (Optional)	3	3	3
Taxiway Crater Repair Crews (3 each)	HMMWV 0		1	1
	Excavator 0		3	3
	4-cy FEL	0	3	6
	Dozer 0		3	3
	Vibratory Roller	0	3	3
	ADR Trailer	0	3	3

Team	Vehicles	R-1 Set	R-2 Set	R-3 Set
Hauling Crew	HMMWV	1	1	1
	8-cy Dump Truck	8	15	22
	2.5-cy FEL	0	3	3
	4-cy FEL	3	3	4
	7.5-ton Tractor	3	3	3
	22-ton Tractor	3	3	3
	10-ton Tractor	3	3	3
	60-ton Tractor	3	3	3
FOD Removal Crew	Grader	3	3	3
	Vacuum Sweeper	2	2	4
	ADR Kick-broom	2	2	7
MOS Layout and Marking Crew	Paint Machine	1	1	1
	1.5-ton Stake-bed Truck	1	1	1
Spall Repair Crews (4 each)	1.5-ton Stake-bed Truck	4	4	4



## Chapter 9

### SPALL REPAIR

**9.1. Overview.** Spall damage should be expected after any conventional airfield attack. Spalls are generally defined as pavement surface damage that does not penetrate through the pavement surface to the underlying layers and may be up to 5 feet in diameter (see [Figure 9.1.](#)).

**Figure 9.1. Spall Damage.**



9.1.1. During an attack, they are most commonly caused by ordnance impact (e.g., strafing and bomb-let detonation; bomb fragmentation impacts; and pavement ejecta).

9.1.2. During extended operations in overseas locations, spalling is often the result of a combination of heavy operational use and substandard pavements (such as former Soviet Union or other areas without stringent pavement specifications and construction controls) resulting in a rapid rate of deterioration and increased maintenance requirements. In addition, the incidence of repairs to previous patches may also be high because of material failures or poor repair practices.

9.1.3. During peacetime, spalling is generally caused by incompressible materials present in the joints and cracks that prevent the necessary movement of the slab due to thermal fluctuations, thereby causing breaks in the concrete adjacent to the joint or crack. Spalls may also be caused by snowplows, overworking, or pop-outs. Incompressible materials must be removed from the joint or crack, the spalled area patched, and the joint sealant replaced.

9.1.4. As a norm, spalls are easier to correct than crater damage, providing the numbers are not overwhelming. Repairing of a spall requires a few procedures: 1) squaring of the edges; 2) cleaning out and removing debris; 3) applying bonding agent if required; 4) placing the fill material; and 5) finish the surface to provide a smooth load bearing surface for aircraft traffic.

**9.2. Purpose and Objective of Spall Repairs.** The primary purpose of repairing spalls on airfield pavements is to reduce aircraft damage due to FOD, continue to provide a flush surface for aircraft operations, and to prolong the service life of the pavement. The objective of spall repair is to reduce FOD and prevent moisture or incompressible material (rocks, sand, other pieces of concrete, etc.) from entering into the joint around the spall repair. Unsealed joints will allow moisture to penetrate under the slab causing an increase in the moisture content in the base and sub-base. As thermal cycling occurs and the joint expands and contracts, incompressible material such as rocks, chunks of concrete, sand, or ice in the crack may cause stress to build in the slab. Such stress can result in more spalling or cracking and further damage to the slab, thereby increasing the potential for FOD.

### **9.3. Areas of Concern.**

9.3.1. **Manufacturer's Instructions.** Ensure that the manufacturer's instructions, or rules of common practice, are strictly followed.

9.3.2. **Bonding.** The spall area must be prepared thoroughly. Sides should be vertical, loose material removed, and the repair surface clean or coated with a bonding agent if applicable. Bad bonding will result in the patch coming loose.

9.3.3. **Safety.** Follow all safety precautions. Some of the rapid setting materials are toxic and flammable. Wear protective clothing and dispose of excess material properly.

9.3.4. **Debris.** Sweep all areas to be trafficked by aircraft even if debris appears minimal.

**9.4. Personnel Requirements.** For planning purposes, three spall repair teams consisting of four personnel each are usually established as part of the overall ADR team complement. This number of personnel is sized to respond to a potential requirement of repairing up to 400 spalls within a 4-hour period. Obviously, if fewer spalls are encountered, the team sizing can be adjusted accordingly by the engineer command and control element.

**9.5. Equipment Requirements.** The equipment generally needed for each spall repair team consists of the following: 1) one 5-ton dump truck or similar vehicle; 2) portable radio; 3) protective masks; 4) mixers, tools, and materials appropriate to the type of repair product being used; 5) concrete saw; and 6) joint use of the ADR team jackhammer and compressor.

**9.6. Spall Repair Procedures.** For specific spall repair procedures, see UFCs 3-270-03, Concrete and Partial Depth Spall Repair.

## Chapter 10

### CRATER REPAIR

**10.1. Overview.** Craters represent damage that penetrates through the pavement surface into the underlying base and sub grade soil, which uplifts the surrounding pavement and ejects base, sub base soils, rock, and pavement debris around the impact area. Craters represent much more severe damage than spalls. Large craters have an apparent diameter equal to or greater than 6 m (20 ft). Small craters have an apparent diameter less than 6 m (20 ft). Typical crater configurations are shown in [Figure 10.1](#).

**Figure 10.1. Large and Small Craters**

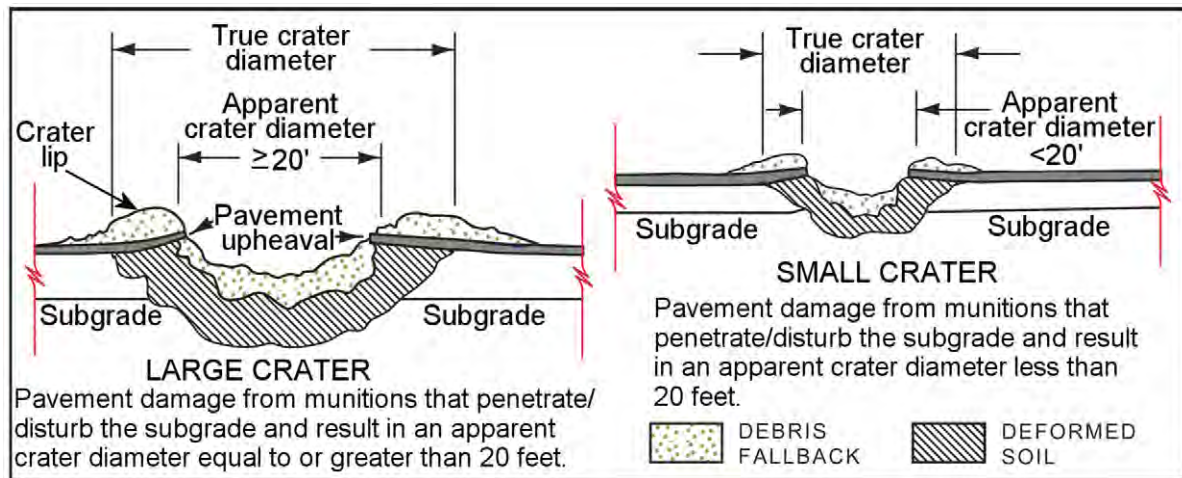

**10.2. Expedient Repair.** Repairs to the MOS/MAOS must be completed within four hours after an enemy attack to allow aircraft launch and recovery operations. These repairs must provide an accessible and functional MOS/MAOS that will sustain 100 passes of the particular aircraft identified by the ICC at its projected mission weight, or the number of passes required to support the initial surge mission aircraft.

**10.3. Mobilization After Attack.** After an enemy attack, repair materials and equipment will have to be delivered to the damaged runway and taxiways before ADR operations can begin. The chaos common to any postattack environment requires close coordination between the hauling team NCOIC and the crew chiefs of the crater repair crews. This prevents delivery of excess materials to one repair area while another area is left without adequate repair supplies. It is up to the ADR OIC and NCOIC to oversee this entire delivery operation, making adjustments as necessary to ensure a steady progression of ADR activities. The ADR delivery operation is a major tasking in logistics flow, more dependent on organization and timing than ability to operate specific pieces of equipment in a prescribed manner. Repair teams, equipment, and materials were dispersed to several locations prior to the attack. These assets must now be brought from dispersal sites and properly combined and configured to perform the ADR operation. Transport vehicles, repair materials, and equipment are not always collocated during dispersal.

**10.3.1. Assembly.** After an airfield attack, airfield damage assessment teams are dispatched by the EOC to gather information for MOS selection purposes. Between the times these teams are dispatched and the final selection of the MOS is made, ADR crews must assemble; assess their equipment and material status; and prepare for movement to the repair sites. At this time the repair crews are nor-

mally formed and the c onvoy order of progression is established. If for some reason vehicles are attrited, adjustments must be made predicated on how long the vehicle will be out of service, its importance to the flow of ADR activities, and what other “work-arounds” may be available.

10.3.2. Loading. The complexity of the loading operation will depend on the type of materials and equipment to be loaded and their stockpile or dispersal locations. For example, crushed stone and ballast rock loading operations will require the support of front-end loaders or similar equipment to place these materials into dump trucks. Bulldozers and other tracked vehicles may have to be loaded onto flatbed trailers for transport if they are located a significant distance from the runway. AM-2 matting, folded fiberglass matting, and the various component kits will all require forklift support for loading onto tractor-trailer units. To the maximum extent possible, repair materials and equipment should be loaded prior to the attack and dispersed in this fashion. For example, the initial loads of crushed stone should be in dispersed dump trucks and the matting materials should be loaded onto tractor-trailers.

10.3.3. Establishment of a Haul Route. Establishment of a good haul route at the very beginning of the ADR operation is essential to avoid traffic congestion and to ensure rapid movement of trucks and equipment between locations. The haul route should be selected as soon as possible after initial damage assessment. The haul route is normally designated by the DCC or the ADR OIC based on the location of pavement damage and UXO. All drivers must know the route and they must be warned not to deviate from it unless forced to by subsequent attacks or similar emergencies. A good haul route will have the following characteristics:

10.3.3.1. Be wide enough for two trucks or heavy equipment to pass one another.

10.3.3.2. If possible, a one-way travel circuit.

10.3.3.3. Be connected to all crater repair sites. This is required in case one of the stockpile sites is depleted and the supply of materials must be shifted to another stockpile location. This also allows C2 and vehicle maintenance personnel access to all repair and stockpile locations.

10.3.4. Debris Clearance. Haul route clearance is the first priority of the crater repair operation. All front-end loader and grader operators should assist by traveling to their crater site with buckets and blades down in areas where debris is present. Where the debris is heavy, front-end loaders should move debris to the side of the haul route trying not to leave a thick, compacted layer which could be too deep for graders to remove.

10.3.5. Traffic Congestion. For ease of control, each repair team should deploy with all its equipment. This ensures required equipment does not become separated from the team. However, serious congestion occurs around the crater if equipment waiting to start work is parked in places that hinder other phases of the repair operation. Normally, it is recommended that teams move with all their personnel and equipment, but that equipment not required at a particular time be moved off of the MOS and parked about 100 feet away from the crater. However, be aware of potential hidden UXO—never move equipment outside the EOD cleared zone without proper clearance. Unnecessary vehicles on the MOS seriously hinder foreign object damage clearance and sweeping, and muddy tires or a spilled load of crushed stone can easily contaminate cleared areas. Dump trucks can be a main cause of congestion along the haul route and around craters. If they must park to await an opportunity to dump their load, they should not get in the way of other trucks or equipment. It is preferred to have the trucks discharge their loads near the crater repair area to prevent delaying the total delivery activity. This stockpiling approach can pay dividends in time saved when craters are significant distances apart. Once the stockpiled crushed stone starts to be pushed into the crater, it is best to have the trucks dump



their payloads directly into the crater. Regardless of the approach taken, it is the crater crew chief's responsibility to take steps to regulate vehicular traffic around his/her immediate operations area.

10.3.6. Precise Identification of Runway Locations. Without a system for identifying locations on the runway, misunderstandings between the DCC and crews are bound to occur. The hauling team drivers will have difficulty finding the right crater to deliver their load. As a result, frustrated crater crew chiefs may "hijack" passing trucks, and the team at the far end of the MOS will be seriously delayed while waiting for crater fill materials to be delivered. The pavement reference system marker posts set out on the grass adjacent to the runway just before the start of hostilities serve as more than just location stations for the damage assessment teams (Figure 10.3). They also can be used as identifiers for delivery locations for the hauling team.

**Figure 10.2. Raised Pavement Marker System Post.**



10.3.7. Off-Load Materials and Equipment. Areas in the immediate vicinity of craters must be cleared of debris so FFM or AM-2 matting, support kits and equipment, and stockpiles of crushed stone can be off loaded.

10.3.7.1. Special areas must be identified and cleared for both AM-2 and FFM assembly. Unlike most other areas, these must be totally cleared and swept since even relatively small pieces of debris can interfere with mat assembly. One of the first tasks for the crater crew chiefs upon arrival at the repair site is to identify these stockpiling and assembly areas.

10.3.7.2. Delivery of material must continue until the crater crew chief determines that sufficient quantities are at the crater sites. Not all fill requires stockpiling near or at the crater's edge; some can be dumped directly into the crater void. If there is too much fill delivered to the crater, it can be pushed quickly to the runway edge; but if there is not enough material, the repair process will be delayed.

10.3.7.3. Dump truck tailgates should be unlatched by a “spotter” from the crater repair team as the truck backs up to offload.

10.3.7.4. Dozers and other tracked vehicles should be unloaded from transporters as quickly and safely as possible to reduce traffic congestion. Where to unload the dozer will be determined by each crater crew chief based upon the situation at hand. The dozer operator should minimize pavement damage by driving the dozer along the grass beside the airfield pavement when moving between craters. Minimizing sharp turns and the use of street pads can also be helpful when a porous friction surface (asphalt) overlay of the runway surface is involved.

10.3.8. Lighting the Work Site. Be sure to bring and set up portable light sets when ADR operations are conducted during hours of darkness.

**10.4. Determining Repair Method and Clearing Crater Site.** The crater repair method must be determined and the crater area must be cleared of debris to permit upheaval identification. One of four crater repair methods can be utilized: debris backfill, choke ballast over debris, choke ballast, or sand grid. The sand-grid repair method must have a foreign object damage (FOD) cover and is only suitable for fighter aircraft and C-130 operations. Foreign object damage covers are not currently approved for C-17 Globemaster, C-5 Galaxy, KC-10 Extender, and KC-135 Stratotanker operations. For airfields with a mix of aircraft that includes those not approved for FOD covers and ones that require FOD covers (i.e. fighters), multiple MOS' should be selected, if possible, to allow for a MOS with FOD covers and one without. This will prevent the time consuming and maintenance intensive removal and replacement of FOD covers between operations of different aircraft. It is critical in either case to ensure the ADR teams understand which type mission has higher priority to the ICC and repair that one first; likewise, it is critical that the ICC understands the limitation imposed by the variety of aircraft and the different ADR methods each demands. See T.O. 35E2-5-1, , Crushed Stone Repair and Line-of-Sight Profile Measurement for Rapid Runway Repair, and UFC 3-270-07 to determine which repair method to use and crater repair site clearing procedures.

**10.5. Initial Upheaval Determination.** The determination of how much upheaved pavement must be removed at the start of a crater repair is accomplished by a process called crater profile measurement (CPM). The same process is used after repairs are complete to see if repairs have been performed within the tolerances specified by the RQC discussed in the previous chapter. Crater profile measurement will also be employed at various times following aircraft trafficking in order to determine if crater maintenance is necessary due to base course compression. It is of paramount importance that engineering command and control personnel know the exact extent of the upheaval damage as well as the quality of a completed repair effort. Without this information, ADR repairs will be relegated to “seat of the pants guesswork” and aircraft sortie generation damage is almost a certainty. **Figure 10.4.** provides an example of upheaval around a crater. NOTE: Procedural details regarding upheaval determination are provided in T.O. 35E2-5-1.



**Figure 10.3. Upheaval Around Crater.**

**10.6. Removing Upheaval, Excavating and Filling Crater.** With the extent of upheaval determined, the next step in the ADR process is the removal of unsound and upheaved pavement. Unsound pavement is pavement that has been damaged to the point where there is a reasonable possibility that it might break apart under traffic and present a FOD problem. Based on the repair method chosen, the crater must be excavated or filled with useable debris. Since AM-2 and FFM repairs are compatible with irregularly shaped craters, the pattern of upheaval breakout is not critical. Removing more pavement than necessary will increase the time to complete the repair and could enlarge the crater to the extent where additional FOD cover sections are required. See T.O. 35E2-5-1 for specific upheaval removal, crater excavating and filling procedures.

**10.7. Intermediate Crater Profile Check.** As upheaval is being removed, intermediate upheaval measurements are required to ensure all upheaval has been identified and removed. Use the same method as used when performing initial upheaval determination. Check multiple points as upheaval is being removed. Follow the procedures described in T.O. 35E2-5-1.

**10.8. Crater Edge Cleaning, Leveling Fill Material, and Overfilling Crater.** Clean edges of the crater by making the top 18 inches of the sidewalls as vertical as possible. Then, level the top layers of fill material. Use shovels to level areas near the crater's edge. Next, fill and compact the crater with crushed stone material using six-inch lifts. Overfill the crater by approximately three inches above the original pavement surface height. See UFC 3-270-07 for specific details regarding these procedures.

**10.9.** Rough Leveling and Initially Compacting the Filled Crater. When the crater has been filled with the top layer of crushed stone, it requires leveling and compacting to achieve its greatest load bearing capacity. Perform crater rough leveling and initial compacting as described in UFC 3-270-07.

**10.10.** Final Grade and Compaction. To ensure the final crater surface is flush and not below the original pavement height, final grade and compaction procedures must be performed. This step is essential before a FOD cover can be installed. Follow the procedures in UFC 3-270-07.

**NOTE:** The crushed stone layer should have a minimum 25 California Bearing Ratio (CBR) to support C-17, C-130, and/or fighter operations.

**10.11.** Dual-Crater Repair. It is more efficient to repair two craters concurrently than to complete one crater before beginning the second crater. Command and control has the single greatest impact in a dual-crater repair scenario. Refer to dual-crater repair procedures in T.O. 35E2-5-1.

**10.12.** FOD Covers. After an air attack, runways and taxiways must be repaired to a standard that allows operations to be resumed with minimal risk to the aircraft. Since the folded fiberglass mat repair method can be accomplished in a flush manner, this method is the primary one used for MOS repairs. AM-2 matting method inherently has a 1.5-inch rise due to the thickness of the matting. As a result, AM-2 repairs are normally relegated to taxiways where aircraft speeds are much slower and less aircraft damage is liable to result. Both of these repair systems essentially require the same basic crater preparation prior to installing the repair surface. These steps include a simple survey to determine the extent of upheaval, removal of unsound pavement and upheaval, backfilling with debris and/or rock, leveling and compaction of crushed stone fill material, and lastly, placement and anchoring of the FOD cover.

10.12.1. AM-2 Mat. AM-2 aluminum matting is hand-assembled and anchored over a crater prepared with crushed stone. This repair surface is the most manpower intensive of the two primary techniques (**Figure 10.5**). Once the mainstay of rapid runway crater repairs, AM-2 has now been mostly relegated to a secondary use for taxiway repairs and parking apron expansion. It does, however, represent an option for runway repairs if other methods cannot be used. A limited number of AM-2 aluminum mat kits are prepositioned at selected airfields overseas for ADR. The size of a standard AM-2 patch is 54 feet wide by 77 feet, 6 inches long. Mat size can be reduced for small craters and increased for larger ones by simply decreasing or increasing the number of panels used. For example, when using AM-2 for taxiway repairs, a patch is usually only 30 feet by 60 feet, since taxiing aircraft normally only require a 25-foot width. To this end, it may be worthwhile to configure some AM-2 bundles to support such activities. By doing this, time could be saved when actual taxiway crater repairs are required. Obviously, such modified bundles would have to be marked conspicuously to avoid possible confusion with those AM-2 bundles configured in the standard manner. AM-2 mat repairs must meet the RQC for its location on the runway. AM-2 mat repairs are generally acceptable for fighter aircraft and C-130s but inadequate for jet cargo aircraft landing strips. AM-2 mats can be used to repair taxiways and aprons if braking and tight turns are limited on the mat. Procedural details regarding AM-2 installation are provided in T.O. 35E2-2-7, AM-2 Landing Mat and Accessories and UFC 3-270-07.

**Figure 10.4. AM-2 Mat Repair Method.**

10.12.2. Folded Fiberglass Mat. The second FOD cover to be discussed is the FFM (Figure 10.6). This procedure, which is currently the primary MO S repair method, involves the installation of an anchored FFM over a crater that was prepared with a top layer of well-compacted crushed stone. Crater preparation is essentially identical to that used with the AM-2 matting system. The folded fiberglass mat has several advantages; it is air transportable, can be moved more easily by vehicle, can be positioned at greater distances from airfield pavement surfaces, and can be stored indoors out of the elements. Procedural details regarding FFM installation are provided in T.O. 35E2-3-1, Folded Fiberglass Mats for Rapid Runway Repair, and UFC 3-270-07.

**Figure 10.5. FFM Repair Method.**



10.12.2.1. Specification. A standard folded fiber glass mat weighs about 3,000 pounds and consists of nine fiberglass panels, each 6 feet wide, 30 feet long, and about 3/8-inch thick. Elastomer hinges, approximately 3 inches wide, connect the panels. When folded, the mats are 6 feet wide, 30 feet long, and 8 to 10 inches thick. In addition to the folded fiberglass mats, this ADR system also includes joining panels and two mat support kits. The joining panels come in 24- and 30-foot lengths. One of each size is needed to connect two 30- by 54-foot mats together. The resulting 54-foot long by 60-foot wide mat is the normal size suitable for most crater repairs. If larger FOD covers are required, additional mats may be spliced together to form almost any size. Mat kit "A" contains all the necessary tools and hardware required to assemble, install, and maintain the system. Mat kit "B" contains the anchor systems required to attach the mat to a range of airfield pavement surfaces.

**NOTE:** Although FFM is the preferred FOD cover on the MOS primary takeoff and landing surface, flush crushed stone repairs without FFM will be used for C-17 Globemaster, C-5 Galaxy, C-141 Starlifter, and KC-10 Extender operations until more permanent repairs can be made.

**10.13.** Sweeping the Crater Area. Regardless of what type of FOD cover is used, sweeping and clean up of the repair area is a mandatory final step. All equipment must be removed and either sent to other job sites or sent back to dispersal sites. Excess materials must be reclaimed or moved out of the immediate MOS area. The crater and its surrounding area must be thoroughly swept to eliminate the potential of FOD damage to aircraft which will be using the MOS immediately afterwards. Lastly, ensure that all debris resulting from the initial bombing attack and that generated from the crater preparation process is off of the MAOS and does not present a hazard to flying operations or the functioning of aircraft arresting systems and airfield lighting systems.

**10.14.** Repair Activity Sequencing. Although this chapter has looked at crater repair as an individual step-by-step process, if ADR is physically performed as described, recovery teams will never be capable of meeting the time frames dictated by the Operations community. To reduce ADR time, five basic requirements involving ADR team members need to be met. Each member of the ADR team must: 1) know his or her individual tasks and responsibilities; 2) be fully proficient in his or her individual tasks; 3) know how his or her tasks interface with the ADR process as a whole; 4) know the steps and sequencing of ADR activities; and 5) receive extensive hands-on training and practice on the ADR process.

10.14.1. If these five requirements are satisfied, ADR time frames can be drastically shortened since people will anticipate their next actions, assist others without hesitation, and be able to do their jobs right the first time. To see how these requirements apply, let us look at the efforts involved in a dual crater repair.

10.14.2. As stated earlier, many ADR activities must overlap or be performed concurrently to cut down on ADR operation time. **Table 10.1**, graphically illustrates a two-crater repair effort using folded fiberglass mats. When studying this table, several instances where tasks overlap can be seen. If ADR team members know where and when these occur, they can respond accordingly and the ADR process will be accelerated. A few examples include:

10.14.2.1. Transportation of FFMs occurs while crater upheaval is being removed.

10.14.2.2. Clearing areas for mat assembly occurs simultaneously with upheaval removal.

**Table 10.1. Dual Crater Folded Fiberglass Mat Repair Timeline.**

Activity	Time (Hours)								
	0.5	1.0	1.5	2.0	2.5	3.0	3.5	4.0	
Initial Debris Clearance	█								
Clear Mat Assembly Area	█								
Unload Mat		█							
Unfold and Splice Mat		█							
Initial Surface Roughness	█								
Backfill Crater		█							
Break Concrete		█							
Remove Upheaval		█							
Intermediate Surface Roughness			█						
Crushed Stone Placement			█						
Rough Level Fill				█					
Initial Compaction				█					
Grade					█				
Final Compaction						█			
Final Surface Roughness							█		
Pull Mat Into Place								█	
Anchor Mat									█
Clear Excess Debris						█			
Final Sweep									█

CRATER 1 █

CRATER 2 █

10.14.2.3. Backfilling of craters starts before upheaval removal is completed.

10.14.2.4. Grading and compacting of crushed stone can be concurrent events.

10.14.2.5. Final clean up and debris clearance may begin before the FFM is fully anchored.

10.14.3. These examples just relate to the repair of one of two craters assigned to a crater repair crew. However, about 80% of the time two craters will be worked concurrently. For a smooth operation, all ADR team members must thoroughly know the procedure and sequencing of ADR activities. These “knowns” must be mastered if the “unknowns” of wartime equipment losses and personnel attrition are to be faced with any degree of success.

**10.15. Debris Clearance.** The peacetime standard of cleanliness for runways and taxiways requires that they be kept free of any debris that could cause FOD to aircraft. In wartime, the runway surfaces will be extensively covered with debris after each air attack, and no equipment available can rapidly clear the surface to peacetime standards. In any case, the risk to aircraft being launched from a “dirty” runway is much less than if aircraft were caught in an air attack while sitting on the ramp waiting for sweeping operations to be completed.

10.15.1. Clearance Procedures. Different standards of cleanliness can be achieved by using various combinations of equipment in the ADR equipment sets. Tests have shown that very little benefit is achieved by making more equipment coverages than the following recommendations:

10.15.1.1. The cleanest surface is achieved by making one “fast” (4-to-5 mph) sweep of the area with a grader, followed by two coverages with a vacuum sweeper traveling at 3.5- to 4-mph.

10.15.1.2. A clean surface is achieved by conducting one fast (4 -to 5-mph) grader coverage followed by one coverage of the tractor with a front-mounted broom traveling at approximately 5.5 mph. These speeds are effective only if the debris is mostly dry. If the debris is wet and sticky, a broom cannot produce a good clean surface.

10.15.1.3. A slow (2- to 3-mph) grader coverage followed by a second, faster (3-to 5-mph) coverage will leave a “dirty” surface, because more large stones are left on it.

10.15.1.4. The “dirtiest” surface, but fastest operation, is left by conducting one “fast” (4-to 5-mph) coverage with a grader only.

**10.16. Clearing and Sweeping Recommendations.** Recommendations for clearing and sweeping activities include:

10.16.1. Sweep all areas to be trafficked by aircraft even if debris appears minimal. It is essential to remove as much shrapnel as possible since even small pieces of sharp metal can damage tires.

10.16.2. Clear taxiways and a strip about 25 feet wide on both sides of the MOS with one fast grader coverage. Also make a single coverage about 15 feet wide with the grader down the center of what will be the overruns of the MOS to provide open access for airfield lighting placement. The length of this run will depend on the type of expedient lighting system available. A better standard of sweeping is required on parking aprons and uphill sections of the taxiway where the aircraft needs to use more power and is therefore likely to suck up more debris. Use a kickbroom sweeper or second grader coverage at these locations.

10.16.3. Clear the first 300 feet of the MOS (the most critical area) with a vacuum sweeper.



10.16.4. Clear the next 800 feet of the MOS with a vacuum sweeper, if possible.

10.16.5. Clear remainder of MOS with kick broom sweeper or by two passes with the grader.

10.16.6. The above recommendations should be considered just that—recommendations. They are not the minimum requirements. As time and vehicles permit, remove as much FOD as possible from all airfield pavements to be used for launch and recovery purposes. Rest assured that sweepers will be running continuously and requests for sweeper support will be never-ending. Plan on making frequent trips to the MOS for FOD clean up—aircraft activity and winds will continually blow additional debris across the airstrip. Once airfield pavement debris clearance is under control, you can expect demands from wing leadership to clean base thoroughfares leading to the flightline from maintenance facilities, munitions storage areas, and POL storage sites.

**10.17. Equipment Repair and Recovery Planning.** Considering the magnitude of ADR, vehicular equipment will experience breakdowns during operations. Planning for such an eventuality will avoid lengthy downtime that could seriously delay repair efforts. Petition the vehicle maintenance section to provide a minimum of two ADR dedicated special purpose vehicle mechanics to support operations. Where this support can be provided, the two-person team should be equipped with a mobile maintenance vehicle of some sort, a means of two-way radio communication (radio/cellular phone), tool boxes, a supply of common replacement spare parts, and remain on the MAOS during the ADR operation to quickly respond to equipment break-downs. In addition, all front-end loaders and dozers should be equipped with towing straps to recover any equipment stuck in a crater or to remove any disabled vehicles from the MOS area.

**10.18. Equipment Substitution.** When a specific item of equipment does break down, do not let the ADR operation grind to a halt. There are many cases where other pieces of equipment may substitute and perform a task almost equally as well. **Table 10.2.** provides an equipment hierarchy illustrating what types of tasks various pieces of equipment can perform. The equipment items are listed in descending order of precedence. For example, for grading the primary vehicle to use would be the grader, followed by a front-end loader and then the excavator. The point to remember is that there are alternatives. You are not locked into following a strict set of procedures. Use initiative, be innovative, and be flexible.

**Table 10.2. Equipment Hierarchy.**

Crater Preparation	Crater Clearance	Aggregate Hauling
4 YD3 Loader	Loader	Dump Truck
Excavator	Excavator	Loader
2.5 YD3 Loader	Dozer	
Dozer	Grader	
Grading	Compacting	Loading/Hauling
Grader	Roller	4 YD3 Loader/w Fork Atch
Loader	Excavator	2.5 YD3 Loader/w Fork Atch
Excavator		Forklift (All Terrain)
Spall Cleaning	Leveling	Debris Clearance
Compressor	Grader	Loader
Backpack Leaf Blower	Loader	Grader
Vacuum Sweeper	Excavator	Excavator
Vehicle Vacuum System	Dozer	Dozer
Transporting Mats	Sweeping	
Tractor/Trailer	Tractor Mounted Broom Sweeper	
4 YD3 Loader	Vacuum Sweeper	
2.5 YD3 Loader	Hand Broom	
Excavator		
<b>NOTE:</b> Equipment under each heading is listed in descending order of precedence.		

## Chapter 11

### AUXILIARY SYSTEMS

**11.1. Introduction.** Repairing damaged pavement is not the only tasks involved in ADR operations. To bring the MOS to its full capability, support crews must perform MOS marking and paint striping, install aircraft arresting systems, and install airfield lighting systems.

#### 11.2. Overview.

11.2.1. This chapter will briefly describe the MOS marking system, to include marking procedures that may be required if a grass, dirt, or other unimproved landing strip is developed to support contingency operations. In addition, marking of obstructions, damaged areas, or other hazards that may have been caused by an attack will be discussed.

11.2.2. The importance of having an aircraft arrestment capability will also be discussed in this chapter. After an aerial bombardment, the probability that the permanently installed aircraft arresting system of the base will be either functional or properly situated on the new MOS is highly remote at best.

11.2.3. Finally, the chapter will discuss the necessity of airfield lighting for nighttime operations. Restoration of the existing permanent lighting system may not be feasible due to the extent of damage or location of existing lighting relative to the MOS. If this situation prevails, an EALS will have to be installed.

**11.3. Airfield Marking Procedures.** The marking of an airfield must adhere to precise guidelines. AFI 32-1042, Standards for Marking Airfields, and USAF Engineering Technical Letter (ETL) 04-2, Standard Airfield Marking Schemes, outline very specific requirements for marking airfield surfaces to conform to recognized standards for aircraft operations. While these markings are considered ideal under normal circumstances, it is unlikely that sufficient time will exist to restore the markings to their original condition following an enemy attack. Repair crews will be rapidly repairing craters and other attack damage. The marking team must be ready to apply expedient techniques that will mark the usable runway surface in the shortest possible time if combat aircraft are to be launched and recovered in a timely fashion. For a more detailed description of the various system components, discussions of preattack and postattack activities, and the basic layouts for marking and striping a MOS, see T.O. 35E2-6-1, Minimum Airfield Operating Surface Marking System (MAOSMS) and AFH 10-222, Volume 16, Guide for Use of the Minimum Airfield Operating Surface Marking System.

11.3.1. Restrictions. The methods discussed in this chapter are intended for use during extreme emergencies, such as enemy attacks, to restore a runway to some degree of usefulness quickly. The techniques described must not be employed as replacements for standard runway markings during peacetime. Specifically, these expedient procedures and marking configurations should be employed only when marking a MOS under base recovery after attack conditions, or a contingency scenario where a damaged enemy airbase has been seized.

11.3.2. MAOS Marking System (MAOSMS). The dimensions of the MOS repaired by ADR crews will vary primarily according to the type of aircraft the base will support and the environmental conditions to be expected following an attack. Although the nominal MOS dimensions for fighter aircraft operations are 50- by 5,000-feet, the length and width of the selected MOS could be greater. The ADR MOS marking crew must be flexible enough to respond to any number of MOS marking require-

ments. The MOS marking system that this crew employs provides much of this flexibility. This system includes four major components: edge markers, distance-to-go markers, aircraft arresting system markers, and a paint striping system. Each of the components can be used separately or in combination with each other, depending upon the extent of need. The components can also be installed in any order in case time does not permit the entire system to be installed all at once. The MOS marking system contains sufficient material and equipment to mark a 10,000- by 150- foot MOS. Although it is doubtful that a MOS of this length will ever be a requirement for fighter operations, a system with this capability provides material redundancy for shorter MOS needs and the potential for expansion to support aircraft that may require much longer landing and takeoff surfaces.

11.3.3. Marking of Unimproved Landing Strips. Under some conditions it may become necessary to use grass, dirt, or other unimproved landing zones for military operations (usually involving C-130 aircraft). When the area in use is large and relatively uniform, it may not be crucial to define specifically the limits of the landing area. Where the lateral and longitudinal limits of a runway do require visual definition, single markers are placed within 15 feet of the edge of the runway, and opposite each other on both sides of the runway at intervals not to exceed 300 feet. Double markers are provided on each side of the runway at both ends, and at 100 feet inward from the runway in the direction of landing. The outer of the two markers are located not more than 15 feet laterally from the inner row of markers. Detailed instructions for construction and placement of these markers are covered in ETL 04-7, C-130 and C-17 Landing Zone (LZ) Dimensional, Marking, and Lighting Criteria, dated 29 March 2004, and AFI 13-217, Drop Zone and Landing Zone Operations.

11.3.4. Marking of Obstructions/Hazardous Areas. An extensive enemy attack on an air base is sure to damage airfield surfaces beyond what can quickly be repaired. Even after a MOS has been selected, repaired, and marked, damage will remain which could cause hazards to aircraft operating in and out of the airfield. ETL 04-2 outlines procedures that are to be used to identify pavements that are closed or hazardous to aircraft traffic. Although these procedures may not apply following an enemy attack, they do serve as excellent guides for the development of methods for marking hazardous pavements during emergencies.

11.3.4.1. Closed Areas. According to ETL 04-2, mark closed runways, taxiways, and aprons with a non-reflective yellow capital "X."

11.3.4.2. Hazardous Areas. Where a hazardous area, such as a bomb crater, exists in or adjacent to an active pavement that cannot be closed to aircraft traffic, the area should be outlined with markers and lights. At all corners and ends, dual markers and lights should be used. A single marker and light should be positioned every 50 feet or less between the corners. The markers may be either low (1-foot or less in height) or high (2 to 3 feet in height) profile barricades (see ETL 04-2).

**11.4. Mobile Aircraft Arresting System (MAAS).** Under most circumstances, an arresting system must be in place for the possible engagement of high-speed fighter aircraft returning to the base with battle damage and other emergencies. This is where the MAAS comes into play. It was specifically designed to fulfill the need for an expedient aircraft recovery which is capable of high-cycle arrestment (up to 20 aircraft engagements per hour) of arresting hook equipped tactical aircraft on bomb-damaged surfaces. The MAAS is a self-contained system that can be installed in less than 40 minutes by a crew of six trained personnel on a concrete, asphalt, or soil surface. Additional details regarding specific applications and capabilities of this system are discussed in length in T.O. 35E8-2-10-1, Arresting Systems, Aircraft, Mobile (MAAS) and AFH 10-222V8, Guide to Mobile Aircraft Arresting System Installation.

11.4.1. If an existing arresting system remains functional, is located longitudinally correct on the MOS, and is situated within the crater free restrictions, its pendant must span the MOS properly to prevent an aircraft from being pulled to one side or the other after engagement. Off-center engagement capability for the MAAS and BAK-12 is half the distance to the runway edge from each side of the runway centerline. If the centerline of the selected MOS is within the off-center engagement capability of the existing system, the existing system can be used, but pilots must be cautioned to engage as near to MOS centerline as possible. If the MOS centerline is not within the off-center engagement capability of the existing system, the existing system cannot be used (see **Figure 6.1.**). Regardless of whether a MAAS or an in-place system is operated, the compulsory use of an arresting system will reduce launch or recovery (LOR) status due to the time involved in arresting system recycling operations.

11.4.2. Use of Aircraft Arresting Systems. In many situations, aircraft landing operations will require more pavement length than takeoff—especially in wet or icy conditions. If an arresting system is available, the landing length can be shortened with an accompanying decrease in the ADR effort needed. Be sure, however, that sufficient undamaged pavement exists before planning on the use of an arresting system. About 2,000 feet of pavement with no repair patches is necessary to use the arresting system in a bidirectional mode. In wet and icy conditions, most aircraft will require more than 5,000 feet to land.

11.4.3. Original System Limitations. The original MAAS was configured and intended to be used primarily for base recovery after attack (BRAAT). This operation scenario allowed for only unidirectional engagements and did not provide for both approach and departure end engagements. Furthermore, since the trailers were installed 7.5 feet from the runway edge, the relatively narrow cross-runway span did not allow for wide-body aircraft operations—an undesirable limitation.

11.4.4. System Upgrades. Since the MAAS is essentially a trailer-mounted BAK-12, these initial system limitations could be overcome. Making the system bidirectional simply involved adding 12 additional cruciform stakes (per trailer) and extending the tape run out from 990 feet to 1,200 feet. Furthermore, by also adding a lightweight fairlead beam (LWFB) or a Mobile Runway Edge Sheave (MRES), the MAAS trailers could be set back as much as 200 feet from the runway edge, thus allowing the room required for wide-body aircraft operations.

11.4.5. If an arresting system is necessary, its location will have been marked by MOS layout personnel prior to the arrival of the arresting system installation team. Prior to initial movement of the ADR forces, the support team chief ascertains from the team's OIC whether the arresting system will be unidirectional or bidirectional. This information is passed to the arresting system installation team chief. As soon as possible after the arresting system location has been marked, the arresting system installation team starts its efforts. If debris clearance is required at the installation site, the arresting system team chief requests such assistance through the support team OIC. Once the arresting system is installed, the arresting system team chief checks the tape sweep area for cleanliness. If debris has to be moved out of the tape sweep area, this is also coordinated through the support team OIC. The arresting system team chief retains the responsibility for ensuring the tape sweep area is usable even after requesting debris removal support. He/she must not declare the arresting system serviceable until the tape sweep area is completely clear of any object that could interfere with the arresting system operation and can certify that the installation is in accordance with T.O. 35E8-2-10-1. NOTE: For new installations or for cases where major civil works have been accomplished that may affect system

alignment, a task-certified Power Production 7-level technician or the civilian WG 5378 equivalent must certify the system ready for use (AFI 32-1043).

**11.5. Installing Airfield Lighting.** Airfield lighting may not be important for daytime aircraft operations, but it is essential for flight in an environment with limited visibility. Procedures for installing portable lighting systems, as well as guidance on salvaging the existing system, are provided in T.O. 35F5-3-17-1, Lighting System, Airfield, Emergency A/E82U-2, and AFH 10-222V7, Emergency Airfield Lighting System.

11.5.1. In most cases, the question will be when to install the lighting system, not whether one is necessary. If considerable daylight will be available after all other ADR operations are anticipated to be complete, airfield lighting should not prove to be immediately critical to aircraft launch and recovery efforts. On the other hand, if the onset of darkness is a factor, airfield lighting installation must be started as soon as possible. The ADR OIC will have to decide the timing for this operation based on inputs from the EOC and ICC and the situation at hand.

11.5.2. If lighting installation crews can wait until final MOS clearance is completed before beginning their operations, ease of operation would be enhanced and de-conflicting activities would be reduced significantly. Two consequential examples of potential problems can be brought about by attempting to install the system too early in the scheme of things. First, personnel attrition may be experienced since the airfield lighting regulator, generator, and associated connecting cables are positioned very close to the fringes of the initial UXO cleared zone (EOD personnel initially clear only 100 feet out from each side of the MOS). Second, debris clearing operations conflicts may develop, since the debris-clearing zone extends well beyond the area where airfield lighting is actually installed. All MOS debris must be removed a minimum of 25 feet beyond each MOS edge.

11.5.3. If it is necessary to install the lighting system concurrently with other ADR operations, the lighting installation team starts the task as soon as possible. Because the edges of the MOS may not be marked and considerable debris may be remaining in the area, final placement of the fixtures probably will not be possible when the team first starts its efforts. The cabling and fixtures can, however, be assembled 25 feet or so off of the probable MOS edges and moved into place once all major debris has been moved from the final installation area. Placement of the airfield lighting regulator and generator can also be accomplished early. The support team OIC must also make a concerted effort to dovetail the heavier debris clearance activities with the lighting installation. Since access to the areas around craters that are being repaired will usually be limited, the airfield lighting team should initially concentrate its activities on other areas where access is not hampered by either debris or equipment operations. Obviously, such decisions are on-scene judgments with the potential of involving unlimited variations. The basic point here is not to expect the airfield lighting team to be able to start at one end of the MOS and work to the other end without interruption—there usually will be too many other major activities ongoing on and around the MOS to allow this. While the support team OIC will have much coordination to do with respect to airfield lighting installation, the lighting installation team chief retains the primary responsibility for proper installation and performance of the system. This individual should not permit the installation team to leave the MOS area until the system is fully functional and correctly installed.

11.5.4. Planning Factors. Ideally, if the situation permits, light assembly and installation can be conducted simultaneously with aircraft takeoff and landing. However, regardless of when the system is



installed, the following factors should be considered when planning an airfield lighting system installation:

11.5.4.1. Personnel Requirements. Four people (at least two electrical systems [3E0X1] personnel) are needed.

11.5.4.2. Equipment Requirements. One 6-passenger (4 by 4) pickup truck with a pintle hook to tow the EALS.

## 11.6. Summary.

11.6.1. The need to mark the MOS quickly following an attack by hostile forces requires that expedient runway marking procedures be used. There is not time to restore the entire airfield to the standards required during peacetime operations. The MOS marking system provides the basic components for establishing the minimum markings required for combat aircraft launch and recovery. Any existing runway markings that could cause confusion regarding the location of the MOS must be obliterated. The information provided in this chapter is intended as general guidance for expedient marking of airfield surfaces. The specific tasks required to mark a runway surface quickly following an attack will vary with each situation. Use AFI 32-1042, T.O. 35E2-6-1, AFH 10-222V16, ETLs 04-2 and 04-7, and your experience and engineering knowledge to accomplish runway-marking requirements.

11.6.2. An arresting system must be in place for the possible engagement of tail hook equipped fighter aircraft returning to the base with battle damage and other emergencies. Additional details regarding specific applications and capabilities of this system are discussed at length in T.O. 35E8-2-10-1 and AFH 10-222V8.

11.6.3. Airfield lighting is essential for flight in an environment with limited visibility. If the onset of darkness is probable before or upon the completion of ADR activities, airfield lighting installation must be started as soon as possible. The ADR OIC will have to decide the timing for this operation based on inputs from the EOC and ICC and the situation at hand. Detailed procedures for installing emergency airfield lighting systems are provided in T.O. 35F5-3-17-1 and AFH 10-222V7.

## Chapter 12

### INFORMATION COLLECTION, RECORDS, AND FORMS

**12.1.** Information Collections. No information collections are created by this publication.

**12.2.** Records. The program records created as a result of the processes prescribed in this publication are maintained in accordance with AF MAN 33-363 and disposed of in accordance with the AFRIMS RDS located at [https://afrims.amc.af.mil/rds\\_series.cfm](https://afrims.amc.af.mil/rds_series.cfm).

**12.3.** Forms (Adopted and Prescribed).

12.3.1. Adopted Forms:

AF Form 847, Recommendation for Change of Publication.

AFTO Form 71, Repair Quality Criteria (RQC) Environmental Data

AFTO Form 72, Repair Quality Criteria (RQC) Values Worksheet

AFTO Form 73, Repair Quality Criteria (RQC) Value Summary

KEVIN J. SULLIVAN, Lieutenant General, USAF  
DCS/Logistics, Installations & Mission Support

**Attachment 1****GLOSSARY OF REFERENCES AND SUPPORTING INFORMATION*****References***

Air Force Publications

AFI 10-210, Prime Base Engineer Emergency Force (BEEF) Program, 24 July 2006

AFI 10-211, Civil Engineer Contingency Response Planning, 6 April 2006

AFI 10-404, Base Support and Expeditionary Site Planning, 9 Mar 2004

AFI 10-2501, Full Spectrum Threat Response (FSTR) Planning and Operations, 24 January 2007

AFI 25-101, War Reserve Materiel (WRM) Program Guidance and Procedures, 2 May 2005

AFI 32-1042, Standards for Marking Airfields, 27 October 2005

AFI 32-1043, Managing, Operating, and Maintaining Aircraft Arresting Systems, 4 April 2003

AFI 32-3001, Explosive Ordnance Disposal Program, 8 October 2004

AFMAN 10-2602, Nuclear, Biological, Chemical, and Conventional (NBCC) Defense Operations and Standards, 29 May 2003

AFMAN 32-4005, Personnel Protection and Attack Actions, 30 October 2001

AFMAN 33-363, Management of Records, 1 March 2008

AFPAM 10-219, Volume 1, Contingency and Disaster Planning, 1 December 1995

AFPAM 10-219, Volume 2, Preattack and Predisaster Preparations, 1 November 1996

AFPAM 10-219, Volume 3, Postattack and Postdisaster Procedures, 1 April 1997

AFPAM 10-219, Volume 5, Bare Base Conceptual Planning Guide, 1 June 1996

AFH 10-222, Volume 1, Guide To Bare Base Development, 1 February 2006

AFH 10-222, Volume 2, Guide To Bare Base Assets, 1 April 2006

AFH 10-222, Volume 7, Emergency Airfield Lighting System (EALS), 1 May 2006

AFH 10-222, Volume 8, Guide to Mobile Aircraft Arresting System Installation, 1 May 2006

AFH 10-222, Volume 16, Guide for use of the Minimum Airfield Operating Surface Marking System, 1 December 2005

TO 35E2-2-7, AM-2 Landing Mat and Accessories, 6 September 1985

TO 35E2-3-1, Folded Fiberglass Mats for Rapid Runway Repair, 1 November 1992

TO 35E2-4-1, Repair Quality Criteria System for Rapid Runway Repair, 23 January 1998

TO 35E2-5-1, Crushed-Stone Crater Repair and Line-Of-Sight Profile Measurement for Rapid Runway Repair, 1 February 1992

TO 35E2-6-1, Minimum Airfield Operating Surface Marking System (MAOSMS), 30 May 2000

TO 35E8-2-10-1, Arresting Systems, Aircraft, Mobile (MAAS), 2 June 2006

TO 35F5-3-17-1, Lighting System, Airfield, Emergency A/E82U-2, 1 October 2000

TO 36C35-7-1, Paint Stripping Set (AF120 SET), 13 July 1995

TO 36Y27-5-1, Concrete Cutting Saw Set (Model MSCRRR-01), 15 March 1994

Unified Facilities Criteria Documents

UFC 3-220-08FA, Engineering Use of Geotextiles, 16 January 2004

UFC 3-260-01, Airfield and Heliport Planning and Design, 1 November 2001

UFC 3-260-02, Pavement Design for Airfields, 30 June 2001

UFC 3-270-01, Asphalt Maintenance and Repair, 15 March 2001

UFC 3-270-02, Asphalt Crack Repair, 15 March 2001

UFC 3-270-07, Airfield Damage Repair, 12 August 2002

UFC 3-270-03, Concrete and Partial Depth Spall Repair, 15 March 2001

UFC 3-270-04, Concrete Repair, 15 March 2001

NOTE: The acronyms and terms shown in this attachment may not always agree with Joint Publication 1-02 (DOD Dictionary of Military and Associated Terms) or AFDD 1-2 (Air Force Glossary). However, the acronyms and terms included are common to the engineering community as a whole.

### *Abbreviations and Acronyms*

**AAS**—aircraft arresting system

**ABO**—air base operability

**ACS**—agile combat support

**ADAT**—airfield damage and assessment team

**ADR**—airfield damage repair

**AEF**—Air and Space Expeditionary Force

**AF**—Air Force

**AFB**—Air Force Base

**AFCESA**—Air Force Civil Engineer Support Agency

**AFH**—Air Force handbook

**AFI**—Air Force instruction

**AFJMAN**—Air Force Joint Manual

**AFMAN**—Air Force Manual

**AFPAM**—Air Force pamphlet

**AFRC**—Air Force Reserve Command

**AFS**—Air Force specialty

**AFTO**—Air Force Technical Order

**AM-2**—aluminum mat-2

**ANG**—Air National Guard

**ARH**—Airborne RED HORSE

**AS**—allowance standard

**ATO**—air tasking order

**BCE**—base civil engineer

**BDOC**—base defense operations center

**BEEF**—Base Engineer Emergency Force

**BRAAT**—base recovery after attack

**C2**—command and control

**C4**—command, control, communications, and computer systems

**CAGE**—commercial and government entity

**CAT**—category

**CBRN**—chemical, biological, radiological, and nuclear

**CBRNE**—chemical, biological, radiological, nuclear, and high yield explosives

**CE**—civil engineering/civil engineer

**CL**—centerline

**COB**—collocated operating base

**CONOPS**—concept of operations

**CONTEST**—contingency testing

**CONUS**—Continental United States

**CPM**—crater profile measurement

**CRG**—contingency response group

**CW**—chemical warfare

**CWD**—chemical warfare defense

**DART**—damage assessment and response team

**DAT**—damage assessment team

**DCC**—Damage Control Center

**DEFCON**—defense readiness condition

**DO**—Director of Operations

**DOD**—Department of Defense

**DR**—density ratio

**DTG**—distance-to-go

**EAF**—expeditionary air and space forces

**EALS**—Emergency Airfield Lighting System

**EAP**—emergency action procedures

**EM**—emergency management

**EMP**—emergency management plan

**EOC**—Emergency Operations Center

**EOD**—explosive ordnance disposal

**EOR**—explosive ordnance reconnaissance

**ESSP**—expeditionary site survey process

**ETL**—engineering technical letter

**FEL**—front-end loader

**FFM**—folded fiberglass mat

**FGM**—fiberglass mat

**FM**—frequency modulation

**FOB**—forward operating base

**FOD**—foreign object damage

**GCA**—ground controlled approach

**GCE**—ground crew ensemble

**GM**—global mobility

**HMMWV**—high mobility multipurpose wheeled vehicle

**IC**—Installation Commander

**ICC**—Installation Control Center

**ICS**—Incident Command System

**IPE**—individual protective equipment

**ISR**—intelligence, surveillance, and reconnaissance

**J-2**—intelligence directorate of a joint staff; intelligence staff section

**JCS**—Joint Chiefs of Staff

**JSCP**—Joint Strategic Capabilities Plan

**LIMFAC**—limiting factor

**LOR**—launch or recovery



**LRC**—logistics readiness center  
**LWFB**—lightweight fairlead beam  
**MAAS**—Mobile Aircraft Arresting System  
**MAJCOM**—Major Command (USAF)  
**MAOS**—minimum airfield operating surface  
**MAOSMS**—minimum airfield operating surface marking system  
**MDAS**—Manual Damage Assessment System  
**MOB**—main operating base  
**MOS**—minimum operating strip  
**MRES**—mobile runway edge sheave  
**MRSP**—mobility readiness spares package  
**MSG**—mission support group  
**NAVAID**—navigational aid  
**NCO**—noncommissioned officer  
**NCOIC**—noncommissioned officer in charge  
**NSN**—National Stock Number  
**O&M**—Operation and Maintenance  
**OCONUS**—outside the Continental United States  
**OI**—operating instruction  
**OIC**—officer in charge  
**OPLAN**—operation plan  
**OPR**—office of primary responsibility  
**PACAF**—Pacific Air Forces  
**PAPI**—precision approach path indicator  
**PB**—Prime BEEF  
**PFM**—polyurethane fiberglass mat  
**POL**—petroleum, oils, and lubricants  
**RCR**—runway condition reading  
**RDS**—records disposition schedule  
**RED HORSE**—Rapid Engineer Deployable Heavy Operational Repair Squadron Engineer  
**REOTS**—Regional Equipment Operator Training Site  
**RQC**—repair quality criteria

**RRR**—rapid runway repair  
**RSC**—runway surface condition  
**SF**—security forces  
**SFES**—Silver Flag Exercise Site  
**SMUD**—standoff munition disrupter  
**SOF**—supervisor of flying  
**STS**—specialty training site  
**STT**—special tactics team  
**SWA**—Southwest Asia  
**TACAN**—tactical air navigation  
**TM**—technical manual  
**TO**—technical order  
**TOL**—takeoff and landing  
**TPFDD**—time-phased force deployment document  
**TTP**—tactics, techniques, and procedures  
**UFC**—Unified Facilities Criteria  
**US**—United States (adj.)  
**USAFE**—United States Air Forces in Europe  
**UTC**—unit type code  
**UXO**—unexploded explosive ordnance  
**VASI**—visual approach slope indicator  
**VDAS**—vehicle damage assessment system  
**WMP**—War and Mobilization Plan  
**WRM**—war reserve materiel  
**WRSP**—war readiness spares package  
**WTS**—wartime task standard

### ***Terms***

**access route**—The route aircraft must take from the parking area/shelter to the MOS. Typically the route will meander to avoid damage. The time to clear or repair the access route is a consideration in MOS selection. The terms “transition path, taxiway, and transition route” are sometimes used to indicate an access route on a launch/recovery surface.

**actual crater diameter**—Opening in the airfield surface after all the debris and upheaved surface have been removed. Also measured from lip-to-lip, and in most cases is significantly larger than the apparent diameter.

**air base operability (ABO)**—The integrated capability of an installation to defend against, survive the effects of, and recover from hostile action, thus supporting effective wartime employment of air power. Air base operability provides the sustained operational capability to wage war.

**airborne RED HORSE (ARH)**—Combat engineer capability to “assess, prepare and establish” contingency airbases in remote locations through airdrop, air-insertion, or air-delivery.

**airfield**—An airfield may be captured, constructed, or provided by the host nation, and may consist of any suitable aircraft operating surface.

**agile combat support (ACS)**—An Air Force core competency which encompasses the process of creating, sustaining, and protecting all aerospace capabilities to accomplish mission objectives across the spectrum of operations. (AFDD 1-2)

**alarm black**—An alert condition signifying that the attack is over, but that chemical agent contamination is possible. Personnel are cleared to leave the shelters, but they must wear chemical protective ensembles.

**apparent crater diameter**—Opening in the airfield surface that can be seen before any work is accomplished on the crater; measured from upheaval lip-to-lip.

**area-denial weapons**—Weapons designed to deny personnel access to an area. They usually are delayed-fusing munitions, such as mines or submunitions, that explode from time delay, disturbance, movement, or other such target activation.

**base defense operations center (BDOC)**—A command and control facility established by the base commander to serve as the focal point for base security and defense. It plans, directs, integrates, coordinates, and controls all base defense efforts and coordinates and integrates into area security operations with the rear area operations center/rear tactical operations center. (JP 1-02)

**base recovery after attack (BRAAT)**—A theater concept of recovering a base after a conventional attack where resumption of flying operations is the first priority. Other recovery activities may be conducted concurrently; however, these activities must not impede the resumption of flying operations.

**camouflage**—The use of natural or artificial material on personnel, objects, or tactical positions with the aim of confusing, misleading, or evading the enemy.

**camouflage, concealment, and deception (CCD)**—The use of concealment, disguise, and decoys to minimize the possibility of detecting or identifying troops, material, equipment, and installations. It includes taking advantage of the natural environment, as well as applying natural and artificial materials.

**camouflet**—The resulting cavity in a deep underground burst when there is no rupture of the surface. See also crater.

**cannibalize**—To remove serviceable parts from one item of equipment in order to install them on another item of equipment.

**chemical, biological, radiological, and nuclear incident (CBRN)**—An emergency resulting from the deliberate or unintentional, release of nuclear, biological, radiological, or toxic/poisonous chemical materials.

**chemical monitoring**—The continued or periodic process of determining whether or not a chemical agent is present.

**chemical warfare (CW)**—All aspects of military operations involving the employment of lethal and incapacitating munitions/agents and the warning and protective measures associated with such offensive operations. Since riot control agents and herbicides are not considered chemical warfare agents, those two items will be referred to separately or under the broader term “chemical,” which will be used to include all types of chemical munitions/agents collectively.

**chemical warfare defense (CWD)**—The methods, plans, and procedures involved in establishing and executing defensive measures against an attack involving chemical agents.

**collateral protection**—This is a term used to describe the level of protection provided by the Survivable Collective Protection System (SCPS). This method protects from weapon fragments, ground shock, and blast over pressures associated with the detonation of a 1000-pound general-purpose bomb at a miss distance of 21 feet. This includes a surface burst and a 14-foot depth of burial burst. This is the lowest level of protection to which chemical processing capability should be coupled.

**collocated operating base (COB)**—A base belonging to an ally, that can be used to beddown Air Force augmenting forces. COBs require CE support to accommodate reception, beddown, launch, and recovery of USAF aircraft. A COB may be a main, standby, or limited base of the allies.

**collective protection shelter**—Shelter area which can provide protection from the effects of nuclear, biological, chemical, or conventional weapons for more than one individual.

**command and control (C2)**—The exercise of authority and direction by a properly designated commander over assigned and attached forces in the accomplishment of the mission. Command and control functions are performed through an arrangement of personnel, equipment, communications, facilities, and procedures employed by a commander in planning, directing, coordinating, and controlling forces and operations in the accomplishment of the mission. (JP 1-02)

**command, control, communications, and computer systems (C4)**—Integrated systems of doctrine, procedures, organizational structures, personnel, equipment, facilities, and communications designed to support a commander’s exercise of command and control across the range of military operations. (JP 1-02)

**concept of operations (CONOPS)**—A verbal or graphic statement, in broad outline, of a commander’s assumptions or intent in regard to an operation or series of operations. The concept of operations frequently is embodied in campaign plans and operation plans; in the latter case, particularly when the plans cover a series of connected operations to be carried out simultaneously or in succession. The concept is designed to give an overall picture of the operation. It is included primarily for additional clarity of purpose. (JP 1-02)

**Continental United States (CONUS)**—United States territory, including the adjacent territorial waters, located within North America between Canada and Mexico.

**contingency**—An emergency involving military forces caused by natural disasters, terrorists, subversives, or by required military operations. Due to the uncertainty of the situation, contingencies require plans, rapid response, and special procedures to ensure the safety and readiness of personnel, installations, and equipment.

**contingency response group (CRG)**—Provides warfighting capabilities to accomplish the Air Force's "open the airbase" mission in austere environments.

**contingency response plan**—A base CE plan of action developed in anticipation of all types of contingencies, emergencies, and disasters.

**Contingency Testing (CONTEST)**—An engineering evaluation program designed to assist commanders in assessing the individual knowledge level of Prime BEEF team members on contingency matters. Tests are structured into two categories: general knowledge and AFS specific.

**conventional weapon**—A weapon that is not nuclear, biological, or chemical.

**crater**—The pit, depression, or cavity formed in the surface of the earth by an explosion. It may range from saucer shaped to conical, depending largely on the depth of burst. In the case of a deep underground burst, no rupture of the surface may occur. The resulting cavity is termed a "camouflet."

**crater-actual diameter**—The actual crater diameter is the diameter across the crater after the heaved pavement has been removed; in other words, the actual size of the required repair.

**crater-apparent diameter**—The apparent crater diameter is the visible diameter of the crater, inside edge to inside edge, at the original surface level, prior to debris being removed. In actual practice, this can be measured from pavement edge to pavement edge. Apparent diameter is the information forwarded to the EOC by the damage assessment teams.

**Crater-large**—Pavement damage from conventional weapons that penetrate or disturb the sub grade, resulting in a pavement damage area in excess of 20 feet in diameter.

**Crater-small**—Similar to a large crater, except the pavement damage area is 20 feet or less in diameter.

**damage assessment**—1. The determination of the effect of attacks on targets. 2. (DOD only) A determination of the effect of a compromise of classified information on national security. 3. (AF/CE) The process of identifying and locating damage and unexploded ordnance following an attack. Damage assessment activities generally are separated into two categories: airfield pavements and facility/utility.

**damage assessment team (DAT)**—A team directed by the EOC used to identify and locate bomb damage and UXO following an attack. Their initial efforts are normally targeted towards the airfield proper; but can also be employed elsewhere as deemed necessary. The airfield damage assessment team (ADAT) usually will consist of one engineering technician, one EOD technician, and one or two augmentees. The ADAT should be equipped with an armored vehicle and communications enabling them to report their observations to the EOC. The ADAT must be accurate in their runway damage reports because this information is used in MOS selection.

**damage assessment and response team (DART)**—Teams formed from CE forces responsible for facility and utility damage assessment and isolating/safing damaged utility systems. These teams are assigned to the DCC.

**Damage Control Center (DCC)**—The operations center established by the BCE to control and conduct postattack recovery operations with BCE forces. The DCC usually is headed by the BCE operations (O&M) chief and manned from the appropriate BCE Staff. Rapid runway repair and other BCE recovery operations are controlled from the DCC.

**debris**—Material ejected from the crater including broken pavement and soil. Debris is sometimes usable as backfill material particularly for large crater repair, but for small crater or spall repair it is generally not advisable

**depot maintenance**—That maintenance performed on material requiring major overhaul or a complete rebuild of parts, assemblies, subassemblies, and end-items, including the manufacture of parts, modifications, testing, and reclamation as required. Depot maintenance serves to support lower categories of maintenance by providing technical assistance and performing that maintenance beyond their responsibility. Depot maintenance provides stocks of serviceable equipment by using more extensive facilities for repair than are available in lower level maintenance activities.

**direct combat support (DCS)**—Work essential to the direct support of combat operations in an overseas theater; that is, work which if not performed could cause immediate impairment to the Air Force combat capability.

**dispersal**—Relocation of forces (and assets) for the purpose of increasing survivability.

**ejecta**—The debris and other material ejected from a crater during detonation of a bomb.

**emergency airfield lighting system (EALS)**—A complete mobile airfield lighting system intended for postattack recovery and/or base beddown operations. It consists of preformed cables, runway edge and threshold lights, and anchors for either soil or pavement installation. It also includes approach lights, taxiway lights, strobe lights, and precision approach path indicators. The system is packaged, shipped, and stored unassembled.

**Emergency Operations Center (EOC)**—Provides command and control for recovery operations and directs team efforts for damage assessment after an attack. The EOC provides expeditionary combat support strategic level planning, information, and resources to IC, ICS staff, and ICC elements as needed. Acts as coordination function to local off-base EOC counterparts as needed and coordinates notifications and mission impact priorities with the Command Post and Commander's senior staff. It maintains overall situational awareness through the common operational picture.

**exercise**—A military maneuver or simulated wartime operation involving planning, preparation, and execution. It is carried out for the purpose of training and evaluation. It may be a multinational, joint, or single-Service exercise, depending on participating organizations.

**expedient airfield repair**—Provides an accessible and functional MAOS that will sustain 100 C-17 passes with a gross weight of 227,707 kg (502 kips), or 100 C-130 passes with a gross weight of 79,380 kg (175 kips), or 100 passes of a particular aircraft at its projected mission weight if other than the C-17 or C-130, or the number of passes required to support the initial surge mission aircraft.

**expeditionary site survey process (ESSP)**—Defines the capability and procedures to identify potential operational locations effectively and collect, store, and access site data in support of warfighter decision-making processes. The ESSP provides the expeditionary site planning process a standard operational method for data collection and data storage for potential operating locations.

**explosive ordnance (EO)**—All munitions containing explosives, nuclear fission or fusion materials, and biological and chemical agents. This includes bombs and warheads; guided and ballistic missiles; artillery, mortar, rocket, and small arms ammunition; all mines, torpedoes and depth charges; demolition charges; pyrotechnics; clusters and dispensers; cartridge and propellant actuated devices; electro-explosive devices; clandestine and improvised explosive devices; and all similar or related items or components explosive in nature.



**explosive ordnance disposal (EOD)**—The detection, identification, on-site evaluation, rendering safe, recovery, and final disposal of an exploded explosive ordnance. It may also include explosive ordnance which has become hazardous by damage or deterioration.

**explosive ordnance reconnaissance (EOR)**—Reconnaissance involving the investigation, detection, location, marking, initial identification, and reporting of suspected unexploded explosive ordnance.

**facility**—A real property entity consisting of one or more of the following: a building, a structure, a utility system, pavement, and underlying land.

**fall back**—Crater material which is ejected at such a high angle that it falls back into the crater. This material is characteristically loose, requiring either compaction or removal before repairs can be made.

**fiberglass mat (FGM)**—A large one-piece fiberglass mat (either 30-feet long by 54-feet wide or 60-feet long by 54-feet wide) used as a FOD cover over crater repairs. It is anchored to the runway surface only on the leading and trailing edges.

**folded fiberglass mat (FFM)**—A 30-foot long by 54-foot wide fiberglass mat made in 6-foot wide by 30-foot long panels with flexible joining hinges to allow folding for shipment. The mats are shipped in a 6-foot wide by 30-foot long stack.

**foreign object damage (FOD)**—Rags, pieces of paper, line, articles of clothing, nuts, bolts, or tools that, when misplaced or caught by air currents normally found around aircraft operations (jet blast, rotor or prop wash, engine intake), cause damage to aircraft systems or weapons or injury to personnel.

**forward operating base (FOB)**—An airfield used to support tactical operations without establishing full support facilities. The base may be used for an extended time period. Support by a MOB will be required to provide backup support for a forward operating base. (JP 1-02)

**ground crew ensemble (GCE)**—The total set of individual protective clothing that, when worn and fitted properly, will provide protection against threat chemical agents. It consists of charcoal undergarments, gloves, socks, mask, goggles, outer garments, hood, and boots. The GCE is part of (IPE).

**hardened site**—A site, normally constructed under rock or concrete cover, designed to provide protection against the effects of conventional weapons. It may also be equipped to provide protection against the side effects of a nuclear attack and against a chemical or a biological attack.

**heaved lip**—See pavement upheaval.

**host nation (HN)**—A nation that receives the forces and/or supplies of allied nations, coalition partners, and/or NATO organizations to be located on, to operate in, or to transit through its territory.

**individual protective equipment (IPE)**—In nuclear, biological and chemical warfare, the personal clothing and equipment required to protect an individual from biological and chemical hazards and some nuclear effects.

**initial reconnaissance**—The initial, long-range damage assessment conducted from observation posts, control towers, airbase point defense positions, and other airfield vantage points.

**intelligence, surveillance, and reconnaissance (ISR)**—Integrated capabilities to collect, process, exploit and disseminate accurate and timely information that provides the battlespace awareness necessary to successfully plan and conduct operations. (AFDD 1-2)

**joint-use WRM**—WRM that can be used in daily operations, in accordance with maintenance and operational readiness parameters spelled out in the WRM directives.

**Joint Strategic Capabilities Plan (JSCP)**—The Joint Strategic Capabilities Plan provides guidance to the combatant commanders and the Joint Chiefs of Staff to accomplish tasks and missions based on current military capabilities. It apportions resources to combatant commanders, based on military capabilities resulting from completed program and budget actions and intelligence assessments. The Joint Strategic Capabilities Plan provides a coherent framework for capabilities-based military advice provided to the President and Secretary of Defense. (JP 1-02)

**large crater**—See Crater-Large.

**launch/recovery surfaces (LOR)**—All pavement areas large enough for a MOS and suitable for launch/recovery of aircraft. Primary and secondary runways are potential MOS areas as well as aprons or taxiways of sufficient size and construction and free of airfield obstacles.

**limiting factor (LIMFAC)**—A factor or condition that, either temporarily or permanently, impedes mission accomplishment. Illustrative examples are transportation network deficiencies, lack of in-place facilities, malpositioned forces or materiel, extreme climatic conditions, distance, transit or overflight rights, political conditions, etc.

**magnesium phosphate cements**—Magnesium phosphate cements are inorganic compounds which can be used in a way similar to quick setting cement/grout for spall repair. They are all water based, can displace water from a wet spall, and bond well to wet or dry concrete or asphalt.

**main operating base (MOB)**—A base on which all essential buildings and facilities are erected. Total organizational and intermediate maintenance capability exists for assigned weapon systems. The intermediate maintenance capability may be expanded to support specific weapon systems deployed to the MOB.

**minimum airfield operating surface (MAOS)**—The combined requirement for airfield surfaces for both runway and access routes. For example, the MOS is part of the MAOS.

**minimum airfield operating strip marking system (MAOSMS)**—The MAOSMS is a visual marking system that provides enough material and equipment to mark a MOS between 50 and 150 feet wide and between 5,000 and 10,000 feet long. In addition, the system can mark 25 to 50 feet wide taxiways.

**minimum operating strip (MOS)**—1. A runway which meets the minimum requirements for operating assigned and/or allocated aircraft types on a particular airfield at maximum or combat gross weight. 2. The MOS is the smallest amount of area that must be repaired to launch and recover aircraft after an attack. Selection of this MOS will depend upon mission requirements, taxi access, resources available, and estimated time to repair. For fighter aircraft, the typically accepted dimensions are 5,000 feet long by 50 feet wide.

**mobile aircraft arresting system (MAAS)**—An aircraft arresting system mounted on two identical, four-wheeled towable trailers, one on each side of the runway. Each trailer serves as a storage and ground transportation and as a platform for securing the basic arresting gear components: BAK-12 energy absorber, pendent tape, tape connector, hook cable, rewind system, and cooling system. The MAAS can be anchored in concrete, asphalt, or soil in less than 1 hour and is capable of 20 arrested landings per hour. The MAAS is capable of bidirectional arrestment, but if configured for airfield survivability application (aborted takeoff and landing aircraft), is unidirectional.

**mobility readiness spares package (MRSP)**—Spare parts designated for specific equipment. These parts are maintained in a ready status and are assembled in a flyaway-type container, to be deployable with a unit in minimum time. Routine peacetime usage is not allowed, except with specific authorization.

The contents of the kits are normally high-consumption items that should enable a unit to operate the equipment at a forward location for a short time (usually 2 weeks to 30 days).

**MOS selection**—The process of plotting damage and UXO locations on an airbase runway map and using this information to select a portion of the damaged runway which can be repaired most quickly to support aircraft operations.

**operational plans (OPLANS)**—An operation plan for the conduct of joint operations that can be used as a basis for development of an operation order (OPORD). An OPLAN identifies the forces and supplies required to execute the CINC's Strategic Concept and a movement schedule of these resources to the theater of operation. The forces and supplies are identified in time-phased force deployment data (TPFDD) files. OPLANS will include all phases of the tasked operation. The plan is prepared with the appropriate annexes, appendixes, and TPFDD files as described in the Joint Operation Planning and Execution Systems manuals containing planning policies, procedures, and formats.

**operator maintenance**—That level of maintenance conducted on equipment, usually on-site, preventive in nature, and consisting of minor adjustments, and routine checking and servicing of fluid and pressure levels.

**pavement upheaval**—The vertical displacement of the airfield pavement around the edge of an explosion-produced crater. The pavement upheaval is within the crater damage diameter, but is outside the apparent crater diameter. In other words, it is that part of the pavement out of "flush" tolerance which is elevated above the adjacent undamaged surface.

**petroleum, oils and lubricants (POL)**—A broad term that includes all petroleum and associated products used by the Armed Forces. (JP 1-02)

**Prime Base Engineer Emergency Force (BEEF)**—A Headquarters US Air Force, MAJCOM, and base-level program that organizes CE forces for worldwide direct and indirect combat support roles. It assigns civilian employees and military personnel to both peacetime real property maintenance and wartime engineering functions.

**priority intelligence requirements**—Those intelligence requirements for which a commander has an anticipated and stated priority in the task of planning and decision making. (JP 1-02)

**rapid runway repair (RRR)**—The process of using construction equipment, tools, portable equipment, expendable supplies, and temporary surfacing materials to provide a minimum operating surface through expedient repair methods.

**rapid runway repair (RRR) minikit**—A rapid runway repair training program developed by HQ AFESC (now HQ AFCESA) in 1989, the goal of which was to provide CONUS Prime BEEF teams with the means (equipment and vehicles) to effect a realistic home station RRR training program. The concept included both individual and team proficiency training. Each unit involved in the program received a training syllabus, and the vehicle and equipment packages necessary to conduct the required training. RRR Mini-kit authorizations are listed in AS 019 and 429.

**RED HORSE**—Air Force units wartime-structured to provide a heavy engineer capability. They have a responsibility across the operational area, are not tied to a specific base, and are not responsible for base operation and maintenance. These units are mobile, rapidly deployable, and largely self-sufficient for limited periods of time.

**Regional Equipment Operator Training Site (REOTS)**—A MAJCOM operated training site where individuals in the heavy equipment career field (AFS 3E2X1) receive extensive hands-on instruction on four equipment items which are essential to ADR (excavator, dozer, grader, and 4-cy loader).

**RRR set**—A standardized set of equipment and vehicles provided to selected MOBs, enabling base CE forces to conduct rapid runway repair. The sets are graduated in a building-block manner to provide the following crater-plus-spall-repair capability:

**R-1**—The basic set of vehicles, equipment, and materials to enable the BCE to form the RRR forces into three crater repair crews, each capable of repairing one crater in 4 hours.

**R-2**—Equipment and vehicles, that when added to the R-1 set, provide the capability to form mixed repair teams (three teams for the runway MOS; three teams for the taxiway), each capable of repairing one crater in 4 hours. Thus, R-2 equates to a capability for six crater repairs in 4 hours.

**R-3**—Additional equipment and vehicles, when added to the R-1 and R-2 sets, provide the capability for six crater repair teams to each repair two craters within 4 hours. Thus, R-3 equates to a capability for 12 craters repairs in a 4-hour period.

**SALTY DEMO**—A RRR demonstration conducted in Europe in May 1985 to evaluate the capability of accepted methods of RRR.

**semi hardened facility**—This term refers to NATO semi hardened criteria—a list of weapons at specific miss distances a structure is designed to resist. The list includes near misses of general-purpose bombs and direct hits of smaller munitions. A typical design is an aboveground structure with 65-cm thick reinforced concrete walls with spall plates, blast valves, and blast doors. Examples of semi hardened facilities are aircraft shelters, squadron operations facilities, and POL truck shelters.

**Silver Flag Exercise Site (SFES)**—These are MAJCOM operated locations where unit Prime BEEF personnel are trained and evaluated and then the unit Prime BEEF team is certified in specific contingency/wartime skills.

**small crater**—See crater—small.

**spalls or scabs**—Pavement surface damage that does not penetrate the pavement base course and results in a pavement damage area that could typically be up to 5 feet in diameter.

**special tactics team (STT)**—A task-organized element of special tactics that may include combat control, pararescue, and combat weather personnel. Functions include austere airfield and assault zone reconnaissance, surveillance, establishment, and terminal control; terminal attack control; combat search and rescue; combat casualty care and evacuation staging; and tactical weather observations and forecasting. (JP 1-02)

**splinter protection**—This method protects from weapons fragments and small arms fire and prevents magnification of the blast pressure from reflection off vertical surfaces. Examples of this method are sand-filled metal bins, earth berms, and modular concrete sections, i.e. the Bitburg revetment. When coupled with dispersal, splinter protection can provide a relatively high degree of survivability for short- and long-term deployments.

**Tactical air navigation (TACAN)**—An ultrahigh frequency electronic air navigation system, able to provide continuous bearing and slant range to a selected station. The term is derived from tactical air navigation.

**transition route**—See access route.

**unexploded explosive ordnance (UXO)**—Explosive ordnance which has been primed, fused, armed or otherwise prepared for action, and which has been fired, dropped, launched, projected or placed in such a manner as to constitute a hazard to operations, installations, personnel, or material and remains unexploded either by malfunction or design or for another cause.

**unimproved surface**—A takeoff and landing (TOL) surface that has not been improved through paving with asphalt, concrete, or other durable substance. For example, grass or dirt landing strip.

**unit type code (UTC)**—A Joint Chiefs of Staff developed and assigned code, consisting of five characters that uniquely identify a “type unit.”

**war and mobilization plan (WMP)**—Five volumes published to fulfill the US Air Force requirement for a plan in support of the Joint Strategic-Capabilities Plan (JSCP) and DOD mobilization planning directives. Volume 1 is the Wartime Planning Guide, and Volume 3 is the unit type code description.

**war reserve materiel (WRM)**—Materials required in addition to primary operating stocks and mobility equipment to attain the operational objectives in the scenarios authorized for sustainability planning in the defense planning guidance. Broad categories are: consumables associated with sortie generation (to include munitions, aircraft external fuel tanks, racks, adapters, and pylons); vehicles; 463L systems; material handling equipment; aircraft engines; bare base assets; individual clothing and equipment; munitions and subsistence.

## Attachment 2

### SEQUENTIAL ADR FUNCTIONS

**A2.1.** General. Functional areas in postattack repair operations remain similar for either the AM-2 mat or the folded fiberglass mat repair systems. However, functional procedures will differ depending upon the system employed. The intent of this attachment is to present ADR postattack activities in an abbreviated, sequential format. The topics covered are:

- A2.1.1. Airfield Damage Assessment.
- A2.1.2. MOS Selection.
- A2.1.3. UXO Safing.
- A2.1.4. UXO Removal.
- A2.1.5. Temporary MOS Markers (if needed).
- A2.1.6. Crater and Spall Repair.
- A2.1.7. MAAS Installation.
- A2.1.8. MAOS Clearing and Sweeping.
- A2.1.9. MOS Marking System Installation.
- A2.1.10. Airfield Lighting Repair/Installation.

**A2.2.** Damage Assessment System. Damage assessment is normally the first function performed after an attack. It is extremely important to receive a damage picture of the entire area of interest (runway, taxiways, shelter access, etc.). The ADAT typically use an armored vehicle to survey assigned sections of the airfield in order to locate craters, spalls and utilitybreaks, and make an initial UXO reconnaissance. In the absence of a suitable vehicle, the assessment team proceeds on foot. The number of ADATs required is dependent upon the size of the airfield; however, most bases will posture three of these teams. Today's threats dictate that the damage assessment and UXO reconnaissance reports need to be received quicker than what has been acceptable in the past.

A2.2.1. Quick initial reconnaissance to provide assessment of installation damage after an attack is a key part of recovery. All base personnel and organizations have a responsibility to report to the EOC, through their respective control centers, any facility damage, casualties, suspected contamination, and unexploded ordnance within and around their specific areas. Each organization should identify and train specific damage reconnaissance personnel for this purpose. While base organizations report damage in and around their immediate areas, DATs assigned to the EOC perform damage assessment in specific areas, such as airfield surfaces.

A2.2.2. Airfield damage assessment team manning normally involves one engineering technician (3E5X1), one EOD technician (3E8X1), and one or two augmentees (any AFS). These teams, under the EOC direction, should survey the runways and taxiways using pre-assigned routes. The engineering technician will determine the location and size of craters and spalls while the EOD technicians will identify UXO by type, location, and, when possible, by fuse. Generally, the augmentee will be trained as a driver/observer and will serve as a data recorder. The team uses a grid-reference system and available visual references, such as prepositioned pavement reference markers, runway distance



markers, centerline, runway edge, taxiway locations, runway lights, etc., to estimate the location of damage and UXO. The team also monitors vehicle-mounted detectors and M-8 paper for the presence of chemical agents. During this damage assessment period, speed is of the essence. All findings uncovered by the team are immediately passed onto the EOC. Damage assessment procedural details are presented in **Chapter 2** of this volume.

**A2.3. MOS Selection.** The EOC receives the damage information by radio, telephone, or runner; and plots the data on the MOS selection maps. Key MOS selection elements are plotting data, selecting the MOS, designating damage to repair, designating the area to clear of UXO, assigning RQC, and estimating recovery time. Damage plotting and MOS selection are usually accomplished simultaneously. Repair quality criteria are normally accomplished after MOS candidates have been ascertained. The damage to repair then may be worked with charts containing aircraft loading information and RQC for the appropriate aircraft. This information is used to determine the minimum acceptable repair qualities for each crater, depending on the crater's location, length, and spacing. The MOS is selected and recommended to the wing commander for approval. After MOS selection is approved, the EOC passes MOS location and repair instructions through the engineer DCC to the ADR OIC who makes appropriate team assignments. The EOC also will direct UXO teams to begin safining and clearing the selected MOS. Details regarding MOS selection procedures are presented in **Chapter 3** of this volume.

**A2.4. UXO Safing/Removal.** Various render-safe procedures will be used to neutralize UXO on the MOS, access routes, and near the repair areas. Large UXO and some submunitions may be attacked with the standoff munition disrupter (SMUD) technique, if possible; otherwise, manual procedures will be used.

A2.4.1. Buried UXO, identified by an entrance hole with no accompanying upheaval, usually will remain undisturbed, depending on the situation and location. Holes of entry and camouflages normally will be filled or covered on the MOS or access routes. These will be recorded and the ordnance will be attended to as operations permit.

A2.4.2. Removing the safed UXO is accomplished by bomb-removal teams who haul or drag the UXO to a designated holding area(s).

A2.4.3. At best, UXO safining is dangerous and time-consuming, but it must be conducted before beginning repair operations. Unexploded explosive ordnance removal can and, in many instances, will be conducted in conjunction with ADR operations. The UXO teams should concentrate their initial efforts on the access routes and areas immediately adjacent to the craters and spalls, so repair teams can begin work as soon as possible. During repair operations, at least one UXO safining crew will be available in the repair area to support ADR in case UXO are uncovered during crater excavation, or discovered in the crater or debris. In such situations, personnel and equipment will move away from the crater area, and the EOC will be notified. The EOC will dispatch the nearest UXO team to minimize repair delay.

**A2.5. MOS Layout.** Identification of an undamaged usable MOS that is immediately available will require outlining and marking with temporary MOS markers to designate its boundaries. However, if MOS damage requires repairs, the MOS may still need outlining to identify boundaries for repair crews. The MOS marking team's first step is to locate the MOS centerline references. A MOS centerline is then marked with traffic cones or paint. The MOS edges are established by measuring from the centerline, and

an outline is laid using portable edge markers. Details regarding MOS layout are included in TO 35E2-6-1 and AFH 10-222, Volume 16.

**A2.6.** Crater Repair. FFM is the primary FOD cover for all MOS repairs. Use AM-2 matting only on taxiways unless FFM is not available for MOS repairs. Extensive spacing between patches is required and transitional ramps are a must if AM-2 caps the MOS repairs. Procedural details regarding both systems are included in T.O.s 35E2-5-1, Crushed-Stone Crater Repair and Line-Of-Sight Profile Measurement for Rapid Runway Repair, 35E2-2-7, AM-2 Landing Mat and Accessories, and 35E2-3-1, Folded Fiberglass Mats for Rapid Runway Repair.

**NOTE:** Foreign object damage covers are not currently approved for C-17 Globemaster, C-5 Galaxy, C-141 Starlifter, KC-10 Extender, and KC-135 Stratotanker operations (see paragraph 10.4).

A2.6.1. FFM FOD Cover Method. A FEL, excavator, or grader will clear debris from around the crater and then extent of upheaval measured and marked using the line-of-sight technique. Upheaval is broken from the crater lip by creating a break line with the moil point attached to the excavator. The fractured pavement is removed using the excavator bucket attachment, dozer, or FEL. Next, an intermediate profile measurement is performed to ensure all upheaval pavement was removed. The crater is then backfilled with debris if conditions are dry or with ballast rock and a geotextile membrane if wet, and topped with crushed stone. A vibratory roller compacts the fill and a grader then grades it level with the surrounding pavement. The team chief designates a mat delivery and assembly team that concurrently assembles the mat near the crater, having it ready when crater repair is complete. The team ensures the crater repair does not exceed RQC limits with a final crater profile measurement. The last step is to cap the repair by towing the folded fiberglass mat over the repair and anchoring it in place.

A2.6.2. AM-2 FOD Cover Method. When capping a crater with an AM-2 FOD cover, the crater repair procedures are the same as those outlined for the FFM above. An AM-2 FOD cover is not likely used on the MOS because of a transitional bounce problem created by aircraft traffic. AM-2 matting will more commonly cover taxiway crater damage. Here, repair criterion is not nearly as stringent as that for a MOS. According to the RQC technical manual (35E2-4-1), a taxiway crater repair can have up to 6 inches of “bump” and a maximum 2-inch sag for fighters and a 3-inch sag for heavy aircraft operations not exceeding 5 knots. Other procedural differences involved in taxiway repair include:

A2.6.2.1. Anchoring AM-2 matting may not be necessary on taxiway repairs unless at pivot and brake points.

A2.6.2.2. Often, the actual patch is reduced to a width of only 30 feet.

A2.6.2.3. Aircraft braking over the patch should be avoided as much as possible.

A2.6.2.4. A taxiway patch can be constructed with or without a key lock.

A2.6.2.5. AM-2 matting can be employed as a transitional taxiway when damage to the original taxiway is extensive.

**NOTE:** A new rapid ramp expansion kit designed to replace AM-2 matting is under development. The intent of this effort is to produce a much lighter and thinner mat that has comparable strength to the original AM-2 product and requires less maintenance. If the composite mat research and development effort is successful, the new system would prove effective for the construction of expedient landing strips, aircraft parking ramps, and other projects that require covering of a large surface.

**A2.7. Spall Repair.** Compressed air blows small debris and moisture from the spall. Rapid-setting material is hand mixed according to manufacturer's instructions and poured into each spall, and then leveled with a trowel. A bonding agent may be necessary before adding the rapid-setting material. Pea gravel may be suitable as an extender if authorized by manufacturer's instructions. The mixture should support aircraft operations within minutes. UFC 3-270-07 contains detailed spall repair procedures.

**A2.8. MAAS Installation.** The MAAS provides a capability for relatively quick arresting system installation configured on a soil or paved surface. Under ideal conditions, the MAAS can arrest an aircraft every 3 to 5 minutes. The MAAS installation team usually concurrently installs the arresting system with crater repair operations. Procedural details regarding MAAS installation are contained in T.O. 35E8-2-10-1 and AFH 10-222, Volume 8.

**A2.9. Debris Clearance and Sweeping.** While repairs are being completed, undamaged areas of the MOS and access taxiways are cleared and swept of fragments and debris. As soon as repairs are completed, FELs and graders clear remaining heavy debris on the MOS. Dozers and FELs level the cleared debris so it is no closer than 25 feet from the edge of the MOS and no higher than 3 feet. Graders, front-mounted sweepers, or vacuum sweepers clear the remaining foreign object damage material.

**A2.10. MOS Marking.** The MOS must be marked sufficiently to identify at least the thresholds, centerline, edges, and remaining distances. A paint machine, edge markers, distance-to-go markers, and arresting system markers are included as part of the MOS marking system. The MOS marking team must work at a speed that allows completion of all marking shortly after the last MOS crater repair. This effort must also include obliteration of any original runway markings no longer usable. T.O. 35E2-6-1 and AFH 10-222, Volume 16, contain MOS marking procedures.

**A2.11. Airfield Lighting.** The EALS provides temporary lighting for ADR. When possible, disperse the system as part of preattack activities. Once the attack is over, move the EALS trailers with other ADR assets to the staging area. Factors such as UXO clearance, night versus daytime operations, and MOS layout will directly impact the start of the EALS installation. However, the airfield lighting team should plan to have the EALS operational when the MOS is ready to support aircraft generation. To accomplish this, initial installation may have to commence about 25 to 75 feet off the edge of the MOS. Once debris clearance is complete, relocate and anchor the assembled lights and wires into their proper position 4-10 feet off the MOS edge. Procedural details regarding EALS installation are included in T.O. 35F5-3-17-1 and AFH 10-222, Volume 7.

## Attachment 3

## CRATER-CREW CHECKLIST

Table A3.1. Crater-Crew Checklist.

CRATER-CREW CHECKLIST (Dual Crater Fiberglass Mat Repair)		
1. Manpower	<input type="checkbox"/> a. Crew chief	
	<input type="checkbox"/> b. Three equipment operators—AFSC 3E2X1 (minimum)	
	<input type="checkbox"/> c. One engineering journeyman/craftsman—AFSC 3E5X1 (conduct repair quality criteria measurements – may perform other tasks when not directly involved with crater repair)	
	<input type="checkbox"/> d. Four support personnel (mat assembly, anchoring, vehicle spotting, etc)	
2. Equipment and Materials	<input type="checkbox"/> a. Two 4-cubic yard front-end loaders	
	<input type="checkbox"/> b. One excavator	
	<input type="checkbox"/> c. One vibratory roller	
	<input type="checkbox"/> d. Fiberglass mats	
	<input type="checkbox"/> e. Mat component kit/tools	
	<input type="checkbox"/> f. Radio	
	<input type="checkbox"/> g. Upheaval measurement devices	
	<input type="checkbox"/> h. ADR concrete cutting saws kit and water truck (optional)	
3. Repair Procedures	Activity Personnel/Equipment	
<input type="checkbox"/> a.	Travel to first crater with equipment operators driving equipment & front-end loaders lead convoy with buckets down clearing debris	Crater repair crew & associated equipment
<input type="checkbox"/> b.	Clear debris around crater #1 to expose extent of upheaval—most debris can be pushed back into the crater.	2 FELs
<input type="checkbox"/> c.	Clear area for crater #1 mat assembly	FOD team's grader & sweeper
<input type="checkbox"/> d.	Determine & mark extent of upheaval of crater #1	Engineer & support personnel
<input type="checkbox"/> e.	Send one FEL to crater #2 to clear debris around crater & mat assembly area	FEL & FOD team's grader and sweeper
<input type="checkbox"/> f.	Unload crater #1 mat	Haul team
<input type="checkbox"/> g.	Backfill crater #1 with debris to within 18 inches of surface—if water intrusion is a problem, use ballast rock & geotextile fabric	FEL & excavator
<input type="checkbox"/> h.	Determine & mark crater #2 upheaval	Engineer & support personnel

( ) i.	Break up heaved pavement at crater #1	Excavator
( ) j.	Backfill crater #2 with debris to within 18 inches of surface—if water intrusion is a problem, use ballast rock & geotextile fabric	FEL
( ) k.	Unfold & splice crater #1 mat	Engineer & support personnel
( ) l.	Unload crater #2 mat	Haul team
Table A3.1 continued on next page.		
3. Repair Procedures	Activity Personnel/Equipment	
( ) m.	Remove crater #1 upheaval	2 FELs
( ) n.	Verify sufficient upheaval has been removed at crater #1 using line-of-sight procedures	Engineer & support personnel
( ) o.	Unfold and splice crater #2 mat	Engineer & support personnel
( ) p.	Break-up heaved pavement at crater #2	Excavator
( ) q.	Fill crater #1 with a minimum of 18 inches of crushed stone & compact in 6 inch lifts—overfill the crater by approximately 3 inches above pavement surface height	FEL & vibratory roller
( ) r.	Remove crater #2 upheaval	FEL
( ) s.	Verify sufficient upheaval has been removed at crater #2 using line-of-sight procedures	Engineer & support personnel
( ) t.	Fill crater #2 with a minimum of 18 inches of crushed stone & compact in 6 inch lifts—overfill the crater by approximately 3 inches above pavement surface height	FEL & vibratory roller
( ) u.	Grade crater #1 to approximately 1 inch above the pavement surface & compact	FOD team's grader & vibratory roller
( ) v.	Grade crater #2 to approximately 1 inch above the pavement surface & compact	FOD team's grader
( ) w.	Compact crater #2	Vibratory roller
( ) x.	Perform profile measurement on crater #1	Engineer & support personnel
( ) y.	Tow crater #1 mat into place	FEL
( ) z.	Perform profile measurement on crater #2	Engineer & support personnel
( ) aa.	Anchor crater #1 mat	Support personnel
( ) ab.	Tow crater #2 mat into place	FEL
( ) ac.	Anchor crater #2 mat	Support personnel
( ) ad.	Clear excess debris and sweep repair areas	2 FELs & FOD team

**NOTES:**

1. Many of the activities listed should overlap during actual ADR operations--this checklist is meant to provide a general order for these activities. Detailed folded fiberglass mat installation procedures are outlined in TO 35E2-3-1 and UFC 3-270-07.
2. Though the ADR concrete cutting saws were primarily procured for the now obsolete concrete slab repair technique, they can be effectively employed in both the AM-2 and fiberglass crater repair procedure in certain circumstances. An example of the saws usefulness is when there is a shortage of available excavators, the ADR concrete saws can make heaved lip removal much easier and faster for the substitute FELs by scoring the heaved material to be removed.



## Attachment 4

## SPALL REPAIR TEAM CHECKLIST

Table A4.1. Spall Repair Team Checklist.

SPALL REPAIR TEAM CHECKLIST	
1. Manpower	<input type="checkbox"/> a. Crew chief
	<input type="checkbox"/> b. Two helpers
	<input type="checkbox"/> c. One driver
2. Equipment	<input type="checkbox"/> a. One dump truck
	<input type="checkbox"/> b. Two shovels
	<input type="checkbox"/> c. Two hand brooms
	<input type="checkbox"/> d. One pick-ax
	<input type="checkbox"/> e. Two bricklayer's trowels
	<input type="checkbox"/> f. Two bricklayer's floats
	<input type="checkbox"/> g. One bucket (for solvent to clean tools)
	<input type="checkbox"/> h. Eight pairs of chemical resistant gloves
	<input type="checkbox"/> i. Six chemical cartridge respirators (if required)
	<input type="checkbox"/> j. Six pairs of safety goggles
	<input type="checkbox"/> k. Emergency eyewash or 5-gallon can of water
	<input type="checkbox"/> l. Fire extinguisher
	<input type="checkbox"/> m. One radio
	<input type="checkbox"/> n. Jackhammer and air compressor (joint use with crater repair teams)
<input type="checkbox"/> o. Concrete saw	
3. Materials	<input type="checkbox"/> a. Spall repair material
	<input type="checkbox"/> b. Fill make-up material per instructions if required (pea gravel, etc.)
	<input type="checkbox"/> c. Solvent to clean tools
4. Safety	<input type="checkbox"/> Adhere to manufacturers' safety warnings and cautions. Some materials require chemical resistant gloves/respirators and are highly flammable.

5. Repair Procedures	( ) a. Locate and mark spall areas
	( ) b. Square edges as vertically as possible & remove loose debris
	( ) c. Groove spall bottom surface if surface of spall is smooth
	( ) d. Prepare spall surface in accordance with manufacturer's instructions
	( ) e. Prepare repair materials per manufacturer's instructions
	( ) f. Place repair material in spall area
	( ) g. Smooth surface: - Grouts: screed off surface even with surrounding pavement - Cold mix materials: place material in 2" thick layers compacting each layer with a plate compactor. Overfill the repair by 1.5" & finish compacting with plate compactor, or a vibratory roller for large repairs. - Finished surface should be flush with existing pavement
6. Acceptance Criteria	( ) RQC specify that spall repairs should be flush with surrounding undamaged pavement with a tolerance of + 0.75"

## Attachment 5

## AM-2 ASSEMBLY CHECKLIST

Table A5.1. AM-2 Assembly Checklist.

AM-2 ASSEMBLY CHECKLIST (Build as You Go Method)	
1. Manpower	<input type="checkbox"/> a. Crater Crew chief or designated other
	<input type="checkbox"/> b. One qualified forklift operator (to load & unload matting)
	<input type="checkbox"/> c. Four support personnel (mat assembly, anchoring, vehicle spotting, etc)
2. Equipment and Materials	<input type="checkbox"/> a. One front-end loader with forklift attachment
	<input type="checkbox"/> b. One tractor trailer or 22-ton ADR tilt trailer
	<input type="checkbox"/> c. One AM-2 mat kit (81 bundles)
	<input type="checkbox"/> e. Mat component kit and tool chest
	<input type="checkbox"/> f. Radio
	<input type="checkbox"/> g. Area lighting set (for night operation)
3. Assembly Procedures	Activity
<input type="checkbox"/> a.	Load matting onto trailers—load in reverse order of use to save time
<input type="checkbox"/> b.	Deliver matting to crater location (1)
<input type="checkbox"/> c.	Clear debris from the mat assembly area (2)
<input type="checkbox"/> d.	Select keylock location and start unloading matting bundles (3)
<input type="checkbox"/> e.	Assemble keylock at approximate center of mat assembly area & perpendicular to MOS/taxiway centerline
<input type="checkbox"/> f.	Connect two long mandrels on each side of the keylock (4)
<input type="checkbox"/> g.	Slide 2 starter tubes into position, center on each mandrel at center connector fitting (5)
<input type="checkbox"/> h.	Start placing matting on the keylock (20-foot side) by installing a row of four full size mats (12-foot) and one short mat (6-foot), always lay mat from left to right (6)
<input type="checkbox"/> i.	Install a locking bar at the end of each joint and both towing tube connections
<input type="checkbox"/> j.	Install a regular towing tube on each mandrel to receive the next row of matting
<input type="checkbox"/> k.	Install 2nd row of matting starting with a short mat followed by 4 long mats (7)
<input type="checkbox"/> l.	Install locking bar (T-Spacer) in each joint between rows of matting (4 T-Spacers per row of matting)—T-Spacers maintain patch alignment (8)
<input type="checkbox"/> m.	Once two rows of matting have been positioned on the 20-foot side of the keylock, mat laying on the short side of the keylock can begin

<input type="checkbox"/> n.	Continue mat laying procedure on both sides of patch until desired length is reached (77'6" for a standard patch)
<input type="checkbox"/> o.	Install stops & end caps, make sure long end of stops are facing towards patch
<input type="checkbox"/> p.	Attach towing harness and position over repaired crater
<input type="checkbox"/> q.	Attach ramps and anchor patch if required
See notes on next page.	

**NOTES:**

1. Matting is usually loaded on a “lowboy” or the 22-ton tilt trailer.
2. The assembly location must be swept of all loose debris. Furthermore, the assembly area should be located as near as possible to the crater that the patch is to be used on, but far enough out of the way as to not cause interference with crater repair activities.
3. For ease of installation, bundles should be spaced to minimize walking. To do this, the bundles located closest to the keylock are positioned 10 feet from the keylock; all subsequent bundles should be spaced at 8-foot intervals.

HINT: Always place the first two bundles on the long (20-row) side. Also, place bundles with female lip towards the keylock. To ease the removal of metal strapping and end-plates and preclude damaging the bottom mat during placement, set bundles on wooden dunnage.

4. When working with standard tubes, use one long and five short mandrel connectors on each side of the keylock. However, when working with reverse tubes, use two long and four short mandrel connectors on each side of the keylock.
5. Starter tubes are 1-inch shorter than standard tubes and do not have a hole for installation of a towing clamp. Tubes on the left side of the keylock will have the prongs facing outside the mat and are rotated 180 degrees to install locking bars. Whereas, tubes on the right side of the keylock will have prongs facing inward toward the mat and are rotated 180 degrees before installing a locking bar in the previous row.
6. It is important that the first row is straight on the keylock—double check to be sure.
7. This alternating procedure prevents the joining seams of one row from being aligned with those of an adjacent row. Once the second row is properly placed, install a locking bar in the same manner as was accomplished in the first row.
8. Once a three row buffer has been established, alternate removing and adding T-Spacers between the oldest and newest rows of matting. This addition/deletion procedure is conducted on both the long and short sides of the keylock.

**ADDITIONAL INFORMATION:**

1. AM-2 mats are packaged in pallets (bundles) for storage and shipping. Each AM-2 bundle contains 16 full sheets and 4 half sheets.
2. The matting contained in one bundle of AM-2 matting will provide 4 rows (8 feet in length) on a standard AM-2 FOD cover. A standard patch is 54 feet wide x 77 feet 6 inches long.
3. Keylock sections are fastened together using keylock connectors and associated bolts.
4. Tow clamps provided with the kit are used for side pulling. A locally fabricated pull assembly built from a piece of AM-2 matting or commercial version (Pull Fixture) must be used for an end pull.

## Attachment 6

## FFM ASSEMBLY CHECKLIST

Table A6.1. FFM Assembly Checklist.

FFM ASSEMBLY CHECKLIST	
1. Manpower	<input type="checkbox"/> a. Crater Crew chief or designated other
	<input type="checkbox"/> b. One qualified forklift operator (to load & unload matting)
	<input type="checkbox"/> c. Four support personnel (mat assembly, anchoring, vehicle spotting, etc)
2. Equipment and Materials	<input type="checkbox"/> a. One front-end loader with forklift attachment
	<input type="checkbox"/> b. One tractor trailer or 22-ton ADR tilt trailer
	<input type="checkbox"/> c. One FFM mat kit (includes joining panels & 1 ea support mat kit A & B)
	<input type="checkbox"/> e. Radio
	<input type="checkbox"/> f. Area lighting set (for night operation)
3. Assembly	Activity
<input type="checkbox"/> a.	Load matting onto trailers (1)
<input type="checkbox"/> b.	Deliver matting to crater location
<input type="checkbox"/> c.	Clear debris from the mat assembly area (2)
<input type="checkbox"/> d.	Unload mats and place end-to-end about 1.2 m (4 ft) apart with first panel up and positioned so both mats unfold in same direction (toward centerline of MOS)
<input type="checkbox"/> e.	Unfold mat by attaching nylon strap to sixth hole from either end of mat, loop a chain through nylon strap loops, attach other end of chain to tow vehicle (3)
<input type="checkbox"/> f.	place forklift, or four people, on opposite side of mat to lift each successive panel as it is unfolded—use a shovel to lift top hinge to insert forklift tines
<input type="checkbox"/> g.	If resin flaking at the mat hinge is apparent, make one pass with a vibratory roller down each hinge, followed by a sweeper (4)
<input type="checkbox"/> h.	Join mats together so they are aligned, the 9.14-m (30-ft) edges are even, and the 16.46-m (54-ft) edges are roughly parallel with each other
<input type="checkbox"/> i.	Lift one end of the 16.46-m (54-ft) edge and slip either the 7.32-m (24-ft) or 9.14-m (30-ft) section of joining panel underneath raised edge—align mat holes with joining panel holes and install top joining bushing and tighten by hand
<input type="checkbox"/> j.	Repeat this process at other end of 16.46-m (54-ft) edge of same mat using remaining joining panel and hand tighten bushing
<input type="checkbox"/> k.	Tow second mat to first mat with joining panel attached
<input type="checkbox"/> l.	Align a hole near end of second mat with its counterpart on joining panel and then install a top joining bushing

( ) m.	Using end connection as a pivot point, move second mat into position so all remaining holes on joining panel are in alignment—install remaining top bushings and tighten all second mat bushings with an impact wrench
( ) n.	Revert to first top joining bushings and tighten with impact wrench
( ) o.	Before towing, sweep the area between mat assembly area and crater repair (5)
( ) p.	With mat hinges parallel to direction of MAOS traffic, align joining panel with center of crater and use a front-end loader, or similar vehicle, to tow mat over crater with hinges perpendicular to direction of tow (6)
( ) q.	With mat in position over crater, anchor in place using proper method for type of pavement surface (7)

**NOTES:**

1. Matting is usually loaded on a “lowboy” or the 22-ton tilt trailer. Use two forklifts to load (and unload) mat assembly onto trailer. Forks should be long enough to support width of mat assembly. Dunnage is required under and between mat assemblies.
2. The mat assembly area can be any area near the crater repair. This area must be cleared of all debris and swept. It must be large enough to accommodate the unfolding of both mats, allow equipment operations around the mat, and not interfere with crater repair activities. This area should be approximately 100 foot by 100 foot square, and located a minimum of 100 foot from the crater.
3. Attach nylon straps by inserting shovel point under edge of mat panel.
4. Resin flaking at the mat hinge can occur and create a FOD problem with mats procured from the initial manufacturing techniques. On e pass with a vibratory roller down each hinge, followed by a sweeper, normally loosens and removes the flaking material from the hinges.
5. Any debris picked up under the mat while towing could damage the matting and affect smoothness of the repair.
6. The mat should not be more than 5 degrees off parallel.
7. The three different anchoring surface types are concrete, asphalt over concrete, and asphalt



## Attachment 7

## FFM INSPECTION AND MAINTENANCE CHECKLIST

Table A7.1. FFM Inspection and Maintenance Checklist.

FFM INSPECTION AND MAINTENANCE CHECKLIST		
No. of Passes		1. FOD Inspection
( )	First 5 to 12	a. Remove any stone or gravel that may have been blown out from joining panel area or under edge of mat
( )	First 20 to 30	b. Inspect all anchor bolts and joining bushings for looseness—remove any FOD noted (1)
( )	First 75 to 100	c. Inspect all anchor bolts and joining bushings for looseness—remove any FOD noted (1)
		2. Mat Condition Inspection (2)
( )	First 50 to 60	a. Inspect each panel section for delamination and small rising dimples or holes that may have developed from small stones or rocks under mats
( )	First 50 to 60	b. Inspect hinge and hinge border areas for tears, cuts, and peeling of elastomer
		3. Follow-on Inspections
( )	Intervals of 150	a. Repeat FOD inspection step 1c and both Mat Condition inspection steps as long as same mat remains in place (3)
4. Maintenance Requiring Mat Removal		
( )	a. Remove all anchor bolts, sleeves, washers, and bushings and store out of the way	
( )	b. If any bolt sleeves slightly protrudes above pavement and cannot be easily removed, use sledge hammer to drive sleeve flush with pavement	
( )	c. Attach nylon straps to mat and tow clear of crater—perpendicular to hinges if possible(4)	
5. Maintenance Requiring Mat Repositioning		
( )	a. Use tow vehicle to reposition used or new mat over crater	
( )	b. Realign mat so holes in mat are at least 6 inches from original holes in pavement	
6. Anchoring a Repositioned or Replacement Mat (5)		
( )	a. Install new anchor bolts following procedures for anchoring a new mat (6)	
( )	b. Reuse anchor bushings previously removed	
7. Temporary Delamination Repair		
( )	a. Cut away loose fiberglass with grinder	
( )	b. Smooth edges of repair perimeter enough so jet blast cannot get under repair and cause additional delamination	
8. Narrow Patch Repair		

( )	a. Remove sufficient number of anchor bolts and/or upper joining bushings so mats can be lifted
( )	b. If damage is near edge of mat, center a joining panel over tear and extend panel at least 1 foot beyond ends of tear
( )	c. With grease pencil and a joining panel as a template, mark joining panel holes on mat
( )	d. Remove joining panel and lift mat edge with forklift tines and lift so the hole saw will not contact pavement or crushed stone as holes are sawed through mat
( )	e. Use a ½-inch drill with 2 ¼-inch hole saw to saw a hole at each mark on mat
( )	f. Position joining panel under mat making sure holes and joining panel bushings align
( )	g. Align one hole and joining panel bushing—install an upper joining bushing hand tight
Table continues on next page.	
( )	h. Align remaining holes and bushings as mat is lowered—install remaining bushings and tighten all bushings on repair
( )	i. If joining panel extends beyond edge of mat, raise mat edge with a shovel and insert a pry block under edge—using circular saw, cut off extended portion of joining panel
( )	k. If upper joining bushings were removed to repair mat, install bushings now
( )	l. If anchor bolts were removed to repair mat, raise mat edge with a shovel and use a ½-inch drill with a 2 ¼-inch hole saw to saw new holes through mat 6 inches from previous holes
( )	m. Drill new anchor holes and install anchor bushings and new anchor bolts
9. Wide Patch Repair	
( )	a. Remove sufficient number of anchor bolts and/or upper joining bushings so mats can be lifted
( )	b. Center a selected repair panel over tear and extend panel at least 1 foot beyond ends of tear—use grease pencil to mark panel 1 foot beyond ends of tear, or if tear extends to mat edge, mark at edge of damaged mat
( )	c. Place a joining panel on several pry blocks and with a circular saw, cut joining panel into halves lengthwise
( )	d. If holes are not present in repair panel, use joining panel halves as templates to mark joining panel holes on repair panel with grease pencil—mark joining panel halves to show edge of mat and mark 1 foot beyond ends of tear
( )	e. Remove joining panel halves and raise repair panel with pry blocks—Use ½-inch drill with a 1 ¼-inch hole saw to saw holes through panel at each mark
( )	f. Using circular saw, cut repair panel at marked ends of repair or even with mat edge
( )	g. Replace repair panel over repair again—using panel as a template, mark panel holes on damaged mat with a grease pencil
( )	h. Remove repair panel—insert forklift tines under mat edge and lift mat so hole saw will not contact pavement as holes are sawed
( )	i. Using a ½-inch drill and 1 ¼-inch hole saw, saw a hole at each mark on damaged mat
( )	j. Position joining panel halves under mat making sure holes in damaged mat are aligned

<input type="checkbox"/>	k. Align repair panel holes over damaged mat and install one upper joining bushing hand tight
<input type="checkbox"/>	l. Lower damaged mat, align remaining holes, and install remaining upper joining bushings—using impact wrench, tighten all bushings on repair
<input type="checkbox"/>	m. If joining panel halves extend beyond edge, raise mat edge with a shovel, insert a pry block under edge of mat, and use circular saw to cut off extending portion of panel halves
<input type="checkbox"/>	n. If upper joining bushing were removed to repair mat, install bushings now
<input type="checkbox"/>	o. If anchor bolts were removed to repair mat, raise mat edge with a shovel and use a ½-inch drill with a 2 ¼-inch hole saw to saw new holes through mat 6 inches from previous holes
<input type="checkbox"/>	p. Drill new anchor holes and install anchor bushings and new anchor bolts
10. Repair Loose Bolts (7)(8)	
<input type="checkbox"/>	a. Visually inspect for loose bolts whenever possible
<input type="checkbox"/>	b. If mat has shifted and there is a permanent wave or bow in mat, remove anchor bolts, sleeves, and bushings on damaged end—attach towing straps and stretch mat until it lies flat
<input type="checkbox"/>	c. Install new anchors 6 inches from old anchor locations (9)
<input type="checkbox"/>	d. If tear is severe and time allows, install an anchor on either side of tear, or remove and replace mat
<input type="checkbox"/>	e. Remove joining panel halves and raise repair panel with pry blocks—Use ½-inch drill with a 1 ¼-inch hole saw to saw holes through panel at each mark
<b>NOTES:</b>	
1. Kick each bushing on right side while walking over it. If the bolts are loose, this shoe-to-hardware contact will cause a counterclockwise motion of the bolt and/or bushing.	
Notes continued on next page.	

2. Any damage or deterioration that allows crater repair material/FOD to escape to the top of the mat shall be cause to halt flight operations. Mat must be removed for replacement or repair in accordance with the appropriate maintenance section in TO 35E2-3-1.
3. When a new mat is placed over a crater, the inspection sequence will start again.
4. If sealer has recently been applied to aircraft operating surface, raise mat edges to break the mat free from sealer before towing mat. Failure to do so may cause damage to mat.
5. In most cases, replacing a damaged mat with a new or previously repaired mat is quicker than making a repair. The damaged mat can be towed to another location for repair.
6. Ensure that all new holes are drilled in sound pavement.
7. Do not tighten anchor bolts in polymer plugs as a damage hazard could be created. If obvious loosening of bolts has occurred, the bolts should be removed, holes drilled, and new anchor bolts installed.
8. A loose bolt is not a hazard unless it creates a tire-cutting hazard, or allows jet blast to lift the mat sufficiently to create a FOD hazard.
9. The only limit to how many bolts can be added is the area of sound pavement beneath the mat. Although it is desirable to locate a new bolt in line with the original bolt, it also can be placed inside the original bolt (toward the crater) if sufficient sound pavement exists. The bolt must also be at least 6 inches from the mat edge, the edge of the pavement and at least 1 foot from the crater edge.