



# Oraltec Dental Catalogue

October 2017



Your Premium Dental Partner



## Your Premium Dental Partner

### Welcome to the **Oraltec 2017 Product Catalogue.**

Oraltec is committed to the future of dentistry and specialises in the supply of premium dental supplies for the modern dental professional. We believe there is a place for a private and wholly New Zealand owned dental supply company that is committed to bringing only the very best to New Zealand. Our products are from carefully selected best-in-product-type manufacturers from within New Zealand and around the world.

Oraltec's close ties with the profession allows us to assess new products prior to introduction to the market and we are able to offer sound clinical advice and technical support. We prefer to deal with specialist manufacturers whose product range ensures a higher level of quality and innovation. This focus allows Oraltec to build strong relationships with the manufacturers we represent, which in turn allows us to provide a greater level of product knowledge to the dental profession.

This Oraltec catalogue provides information on our products with colour images to help you with product selection. In addition to products shown in the catalogue we have access to a broad range of products that can be indented for special orders. Please contact us for more information. Our office is open Monday to Friday from 8.30am until 5.00pm.

You can also browse our online shop for product information and material safety data sheets. To obtain login details please phone or email us.

Our bimonthly Oraline magazine enables you to keep up to date with new products, special offers and discounts.

We look forward to assisting you with your dental product requirements in the future.



### Delivery

Courier bags - overnight service

Larger items - allow 1-3 days

Orders valued over \$150.00 (exclusive of GST) are delivered freight free (with the exception of those items which are subject to bulk freight charges).

Orders under \$150.00 (exclusive of GST) will be subject to freight at the rate applicable (calculated on the weight, size and destination).

*See also terms and conditions below.*



### Guarantee

All items are guaranteed to your complete satisfaction. If you are unhappy with your purchase, for any reason, please contact your Oraltec Representative as soon as possible.



### Credits

Returns will be accepted within 30 days of purchase except for items specially indented which may not be able to be returned. A copy of the invoice should accompany the goods and items must be in the original condition and packaging. Conditions may apply.



### Payments

Accounts are payable 20th of the month following delivery/invoice.



### Customer Service

Visit [oraltec.co.nz](http://oraltec.co.nz) to view our full product range and log in to check pricing.

For any questions, for further assistance or to place an order, call our Customer Service team between 8.30am and 5.00pm, Monday to Friday.



0508 478 222 (or Auckland 478 2229)



09 478 2221 (fax)



[orders@oraltec.co.nz](mailto:orders@oraltec.co.nz)



[www.oraltec.co.nz](http://www.oraltec.co.nz)



16 Parkway Drive, Mairangi Bay, Auckland 0632  
PO Box 33087, Takapuna, Auckland 0740

### My ORALTEC details

Customer Number \_\_\_\_\_

Oraltec Representative \_\_\_\_\_

Oraltec Representative Phone No. \_\_\_\_\_

Oraltec web login username \_\_\_\_\_

Oraltec web login password \_\_\_\_\_

**Terms & Conditions:** For Oraltec's current Terms & Conditions of Trade, or to apply for an account, for further details, please visit [oraltec.co.nz](http://oraltec.co.nz).

**Delivery:** Delivery is free for orders over \$150.00 (excluding GST) with the exception of cartons of gloves, cartons of paper products, 25kg stone and 20kg plaster - all of which are subject to bulk freight charges. Orders under \$150.00 (excluding GST) will be subject to freight at the rate applicable (calculated on the weight, size and destination). Oraltec NZ Ltd cannot be held responsible for delays caused by couriers or weather conditions but will work with the courier companies to ensure best possible delivery/service including following up on overdue and lost or damaged items.

**Copyright and Ownership Notice:** It is an infringement of the intellectual property rights of Oraltec NZ Ltd for any person to modify, copy, distribute, transmit, display, reproduce, sell or otherwise deal with this catalogue or any part of it without the prior written permission of Oraltec NZ Ltd. All rights are reserved.

**E&OE:** While every endeavour has been made to ensure accuracy at the time of print, Oraltec NZ Ltd shall not be held responsible for any errors or omissions in this catalogue.

# Contents

<b>Bleaching Products</b> .....	<b>6-7</b>	<i>Endodontic applicators</i> .....	40
<i>Pre whitening products</i> .....	6	<i>Other endodontic products</i> .....	40
<i>Whitening products</i> .....	6	<i>Endodontic instruments</i> .....	41
<i>Post whitening products</i> .....	7	<i>Endodontic cleaners</i> .....	41
<i>Endodontic bleach</i> .....	7	<i>Endodontic measurers and boxes</i> .....	41
<i>Bleaching sheets</i> .....	7	<i>Endodontic equipment</i> .....	41-42
<i>Plastic boxes</i> .....	7	<b>Finishing and Polishing Products</b> .....	<b>44-46</b>
<b>Burs</b> .....	<b>8-21</b>	<i>Polishing points</i> .....	44
<i>Intensiv diamond burs</i> .....	8-17	<i>Polishing accessories</i> .....	45
<i>North Bel diamond burs</i> .....	18	<i>Polishing discs and strips</i> .....	45-46
<i>North Bel carbide burs</i> .....	19	<b>Handpieces</b> .....	<b>47-52</b>
<i>Intensiv crown cutting burs</i> .....	19	<i>High speed turbines</i> .....	47
<i>Jet carbide burs</i> .....	20	<i>Contra angle complete handpieces</i> .....	48
<i>Thomas steel burs</i> .....	20	<i>Contra angle EX shank and heads</i> .....	50
<i>Bur accessories</i> .....	21	<i>Electric motors</i> .....	51
<b>Cotton Products</b> .....	<b>22</b>	<i>Air motors</i> .....	51
<b>Denture Products</b> .....	<b>23-27</b>	<i>Oscillating handpiece</i> .....	52
<i>Pala heat cure acrylics</i> .....	23	<i>Handpiece maintenance</i> .....	52
<i>Pala cold cure acrylics</i> .....	23	<b>Impression Materials</b> .....	<b>53-63</b>
<i>Meliodent acrylic products</i> .....	24	<i>Tissue management</i> .....	53
<i>Other acrylics</i> .....	24-25	<i>Impression preparation</i> .....	53
<i>Retention set</i> .....	25	<i>Impression mixing equipment</i> .....	54
<i>Reline materials</i> .....	26	<i>Clinical digital impression scanner</i> .....	54
<i>Base plates</i> .....	26	<i>Impression trays</i> .....	55
<i>Denture brushes</i> .....	26	<i>Impression compound</i> .....	55
<i>Denture accessories</i> .....	27	<i>Alginates</i> .....	56
<i>Polishing pastes</i> .....	27	<i>Alginate adhesives</i> .....	56
<i>Plaster solvent</i> .....	27	<i>Silicone adhesives</i> .....	56
<i>Pumice cleaner</i> .....	27	<i>Alginate accessories</i> .....	58
<b>Digital Dentistry</b> .....	<b>28-34</b>	<i>Impression preparation</i> .....	58
<i>Ceramic materials</i> .....	28	<i>Alginate alternatives</i> .....	58
<i>Hybrid ceramic materials</i> .....	28	<i>Bite registration</i> .....	59
<i>Acrylic materials</i> .....	28	<i>Clear bite registration</i> .....	59
<i>CAD/CAM waxes</i> .....	28-29	<i>Crown &amp; bridge silicones</i> .....	60-61
<i>Ceramill colouring liquids</i> .....	29	<i>Mixing tips</i> .....	62
<i>Ceramill polishing products</i> .....	29	<i>Intraoral tips</i> .....	62
<i>Ceramill burs and trimmers</i> .....	29	<i>Dispensers</i> .....	62
<i>Clinical digital impression scanner</i> .....	30	<i>Impression tray cleaners</i> .....	62
<i>Laboratory digital scanners</i> .....	30	<i>Impression disinfectants</i> .....	63
<i>Design (CAD)</i> .....	31	<i>Special tray material</i> .....	63
<i>Milling (CAM)</i> .....	32	<i>Laboratory putty</i> .....	63
<i>Air compressors</i> .....	34	<b>Infection Control Products</b> .....	<b>64-71</b>
<i>Sintering</i> .....	34	<i>Autoclavable pouches and reels</i> .....	64
<b>Endodontic Products</b> .....	<b>35-42</b>	<i>Bibs and bib holders</i> .....	64
<i>Rubber dam products</i> .....	35-36	<i>Hand cleaning</i> .....	65
<i>Hand files</i> .....	37	<i>Hand sanitiser/disinfection</i> .....	65
<i>Endodontic stoppers</i> .....	37	<i>Impression disinfectants</i> .....	65
<i>Rotary NiTi files</i> .....	38	<i>Water distiller cleaner</i> .....	65
<i>Reamers and gates glidden</i> .....	38	<i>Instrument cleaning and disinfection</i> .....	66
<i>Other endodontic instruments</i> .....	38	<i>Ultrasonic cleaners</i> .....	66
<i>Endodontic lubricants</i> .....	39	<i>Instrument cleaning</i> .....	66
<i>Endodontic irrigation system</i> .....	39	<i>Soaking tanks</i> .....	66
<i>Endodontic dressings</i> .....	39	<i>Bur disinfection boxes</i> .....	68
<i>Paper points</i> .....	39	<i>Surface cleaning and disinfection</i> .....	68
<i>Gutta percha products</i> .....	40	<i>Surface disinfection</i> .....	68
<i>Endodontic sealant</i> .....	40	<i>Suction system cleaners</i> .....	69
		<i>Disposable triplex syringes</i> .....	69

# Contents

Protective sleeves and covers.....	70	Other accessories.....	101
Sterile tubing covers.....	71	Laboratory putty.....	102
Eye and face shields.....	71	Impression compound.....	102
Masks.....	71	Slow set bite registration.....	102
Gloves.....	71	Plaster solvent.....	102
<b>Instruments.....</b>	<b>72-87</b>	Pumice cleaner.....	102
LM Instruments.....	72	Giroform products.....	103
Diagnostic instruments.....	72	Giroform plates.....	104
Periodontic instruments.....	73-78	Other giroform products.....	104
LM ErgoMix instruments.....	78	<b>Occlusion Products.....</b>	<b>105-109</b>
Restorative instruments.....	78-80	Artex articulators.....	105
Cement mixing spatulas.....	80	Artex facebow.....	106
Composite instruments.....	81	Splitex calibration.....	107
Endodontic instruments.....	81	Articulating paper.....	108
Orthodontic instruments.....	81	Articulating forceps.....	109
Instrument sharpening products.....	82	Intra oral measuring strips.....	109
Mirror handles.....	83	<b>Office Products.....</b>	<b>110-114</b>
Mirror heads.....	83	Tork paper products.....	110
Mouth props.....	83	Tork hygienic bins.....	110
Scissors.....	84	Record cards and envelopes.....	112
Tweezers.....	84	Analgesics.....	112
Amalgam carriers.....	84	First aid kits and supplies.....	112
Instrument maintenance.....	85	Moisturisers and hand creams.....	112
Coding products.....	85	Tork foam and liquid soaps.....	114
Multiholder system.....	85	<b>Oral Care Products.....</b>	<b>115-124</b>
Instrument trays.....	86	Ultrasonic scalers and polishers.....	115-116
Instruments cassettes.....	87	Air scaler.....	117
<b>Laboratory Products.....</b>	<b>88-98</b>	Air powered tooth polishing system.....	117
Plaster knives.....	88	Listerine mouthwashes.....	118
Wax knives.....	88	Other mouthwashes.....	118
Plaster spatulas.....	88	Toothbrushes.....	119
Cavers and modelling instruments.....	88	Denture brushes.....	119
Pliers.....	89	Reach floss and flossers.....	119
Nippers and wire cutters.....	89	Specialist floss.....	119
Other laboratory instruments.....	89	Interdental brushes.....	120
Laboratory composite.....	90	Desensitisers.....	120-121
Brushes, buffs and cones.....	91	Analgesics.....	121
Polishing pastes.....	91	Oral medicine.....	121-122
Acrylic polishers.....	92	Fissure sealing.....	122
Laboratory burs.....	92	Disclosing products.....	122
Thermoforming finishers.....	93	Prophy products.....	124
Laboratory equipment.....	94-95	Dappen dishes.....	124
Giroform pin drill.....	95	<b>Orthodontic Products.....</b>	<b>125-131</b>
Laboratory micro motors.....	96	Clasps.....	125
Alginate mixer.....	97	Wires.....	125
Plaster mixers.....	97	Vector expansion screws.....	126
Steam cleaner.....	98	Thermoforming machine.....	127
Electric bunsen burner.....	98	Thermoforming material.....	127-128
Sintering.....	98	Thermoforming accessories.....	128
<b>Model and Casting Products.....</b>	<b>99-104</b>	Resin.....	128
Die stone spacers and accessories.....	99	Orthodontic instruments.....	129
Alloys.....	99	Specialist instruments.....	129-131
Investment.....	100	Orthodontic accessories.....	131
Stone.....	100	<b>Portable Equipment.....</b>	<b>132</b>
Plaster.....	100	<b>Restorative Products.....</b>	<b>133-152</b>
Casting accessories.....	100-101		
Separating fluids.....	101		

# Contents

Bonds.....	133-134	Piezo bone surgery system .....	168
Etch .....	134	Surgical motor and handpieces .....	168
Liners.....	134-135	Surgical handpieces .....	169
Temporary cements.....	135	<b>Teeth .....</b>	<b>171-172</b>
Zinc oxide eugenol cements.....	135	Kulzer PALA teeth .....	171-172
Permanent cements.....	135	Wrights Senator teeth.....	172
Composites.....	137-138	Wrights Monarch teeth .....	172
Ormocer materials .....	140	Gebdi Tribos 501 teeth.....	172
Bulk fill composites.....	142	<b>Thermoforming Products .....</b>	<b>173-180</b>
Flowable composites .....	143	Thermoforming equipment .....	173
Specialised composites .....	144	Applications for Ministar and Biostar .....	173
Glass Ionomers.....	145	Thermoforming materials .....	174-177
Core build up materials.....	146-147	Resin.....	178
Temporary materials.....	147-148	Bleaching sheets .....	178
Amalgam.....	148	Deep sleep medicine .....	179
Sectional matrix system.....	149	Light curing gel and putty .....	180
Matrix retainers and bands.....	149	Accessories.....	180
Applicators .....	150	<b>Wax Products.....</b>	<b>181-183</b>
Strip crowns.....	151	For acrylic work .....	181
Accessories.....	151	Block out materials.....	181
Dispensers.....	152	Dipping wax.....	181
Capsule mixer .....	152	Orthodontic wax.....	181
Curing lights.....	152	Preformed wax pattern .....	182
<b>Suction Products .....</b>	<b>153-154</b>	Wax wire.....	182
High volume suction tips .....	153	Waxes for Crowns & Bridges .....	182
Low volume suction tips.....	153	CAD/CAM waxes .....	182
Suction system cleaners .....	154	Model casting wax.....	183
Suction systems.....	154	Insulating liquid .....	183
<b>Surgical Products.....</b>	<b>155-169</b>	Wax instruments .....	183
Sterile tubing covers.....	155	Other.....	183
Sterile drapes.....	155	<b>Xray Products .....</b>	<b>184-185</b>
Mouth props.....	155	Xray film .....	184
Absorbent products.....	155	Xray chemicals.....	184
Scalpel blades and handles.....	156	Xray filing products .....	184
J&J Ethicon sutures.....	157	Xray covers.....	184
Salvin Surgipoint Sutures.....	157-158	Xray film holders .....	184
Unik silk sutures.....	158	Xray film and phosphor plate holders .....	185
Retractors.....	158	Lead aprons.....	185
Artery and tissue forceps.....	159	<b>Index .....</b>	<b>186-190</b>
Needle holders.....	159	<b>Our Business Partners.....</b>	<b>191</b>
Metal dishes .....	159		
Scissors .....	160		
Tweezers.....	160		
Periotomes & periosteal elevators .....	160		
Anaesthetic syringes .....	162		
Needles.....	162		
Surgical aspirators.....	162		
Other surgical instruments.....	162		
Surgical burs .....	163		
Trephine drills.....	163		
Bone grafting.....	163		
Salvin torque driver .....	163		
Luxating instruments.....	164		
Elevating instruments.....	165		
Root elevators.....	165		
Root tip pick .....	165		
Extraction instrument maintenance.....	165		
Hammacher extraction forceps .....	166-167		

# Bleaching Products

## PRE WHITENING PRODUCTS

### BITE&WHITE STAINLESS

*Extreme cleaning activator*

Cavex Bite&White StainLess is a pre-treatment paste especially developed to realise optimum whitening results.

StainLess cleans the tooth surface thoroughly, thus optimising the contact between the bleaching gel and tooth tissue. It raises the pH value in the mouth. This creates ideal conditions for the rapid activation of the bleaching gel so that it can bleach more efficiently.

- Intense cleaning and stain removal
- Raises pH in mouth for optimal whitening conditions
- Fresh taste
- Supplied as a 50g tube

**CAVEX**



CABW070 Cavex Bite&White StainLess

### PETROLEUM JELLY

- For gingival protection
- Supplied as a 500g jar



MUJEL500 Petroleum jelly

## WHITENING PRODUCTS

### PDS NoW WHITENING SYSTEM

**PDS**

The NoW whitening system enables efficient teeth whitening without the time and expense of making individual custom trays. The trays have been designed to flex without distorting and the multiple finger grips on the inside surfaces of the trays hold them comfortably in place against your teeth. These reusable upper and lower trays fit most mouths.

The NoW uniquely designed and patented trays are made from medical grade silicone and are ribbed to allow flexing with minimal distortion. The trays remain comfortably in place and ensure the NoW gel is in close contact with patients teeth.

The NoW high viscosity whitening gel is available in both 10% and 16% carbamide peroxide solutions.

PD34425 NoW 16 Whitening Kit  
Kit contains 1 x 30ml tube of NoW high viscosity gel (16% carbamide peroxide), 2 x NoW whitening trays (1 x upper and 1 x lower), patient information + instructions



PD34422 NoW 16 refill - 30ml

PD34427 NoW 10 Whitening Kit  
Kit contains 1 x 30ml tube of NoW high viscosity gel (10% carbamide peroxide), 2 x NoW whitening trays (1 x upper and 1 x lower), patient information + instructions



PD34420 NoW 10 refill - 30 ml

### CAVEX BITE&WHITE IMPACT

*Complete home whitening system that does not need refrigeration*

Cavex Bite and White Impact is a home whitening system that contains everything patients need to whiten their teeth at home.

It contains the active ingredient PVP (polyvinyl-pyrrolidone) at a strength which is equivalent to 6% hydrogen peroxide. It is effective when stored at room temperature. The gel is dispensed from a tube which combined with a boil-and-bite tray provides an easy, cost effective whitening alternative.

**CAVEX**

CABW040 Cavex Bite&White Impact kit  
Kit includes 1 x 30ml tube of whitening gel, one boil-and-bite whitening tray that covers both upper and lower arches and instructions



CABW041 Cavex Bite&White refill - 30ml tube

### CAVEX TOOTH WHITENING PEN

*A "brush-on" on-the-go whitening pen*

Ideal to bleach a small area or to touch-up. Simply take off the cap, turn the pen button until a small droplet of whitening gel appears and apply directly to the teeth.

For any tooth whitening pen, maximum peroxide stability is required in both content and viscosity. The use of the revolutionary new PVP (polyvinylpyrrolidone) offers this stability. The Cavex Bite&White Tooth Whitening Pen can be stored at room temperature and the reaction will only then start when there is contact with the teeth.

- Does not need refrigeration
- Effective and safe
- Maximum 6% hydrogen peroxide
- Leak free pen

**CAVEX**



CABW080 Cavex Bite&White whitening pen - 2ml

### PDS BRIGHT TEETH KIT

- Carbamide peroxide 10% gel
- For vital teeth whitening
- Pack of 8 patient units

**PDS**

PD34409  
Bright Teeth kit  
Kit includes 8 x 30ml bleaching gel, mouthguard boxes, thermo splints and accessories



### PERIOPACK MINI

*The long-term, non-staining pharmacological solution to the management of gingivitis, periodontal disease and peri implantitis*

- Alternate brushing with Chlorofluor and Bright Teeth gel rapidly resolves gingival inflammation and assists with the management of periodontitis and peri implantitis while whitening teeth over time
- Easy to use - patients simply brush teeth with Chlorofluor prior to retiring and then in the morning, after breakfast, with Bright Teeth gel for one minute. They should not rinse or drink for at least an hour after brushing.
- Aids in management of residual pockets which helps gingival tissues to heal themselves

**PDS**

PD35512 Periopack Mini  
Kit contains 30ml Chlorofluor gel, 30ml Bright Teeth gel and instructions



# Bleaching Products

## PDS BRIGHT TEETH

- 10% carbamide peroxide
- Mint flavoured gel
- Supplied as a 30ml refill bottle

PD34412 Bright Teeth



## PDS WHITE LIGHTENING

- 16% carbamide peroxide
- Mint flavoured gel
- Supplied as a 30ml refill bottle

PD34415 White Lightening



## POST WHITENING PRODUCTS

### LISTERINE WHITENING PLUS ENAMEL PROTECTION

*2-in-1 formula whitens and strengthens tooth enamel*

- Contains 2% hydrogen peroxide pre-brush rinse
- Clean mint taste
- Supplied as a 470ml bottle



JJ330703101 Listerine Whitening

### BITE&WHITE EXSENSE

*Tooth conditioner*

Cavex Bite&White ExSense offers fast and long-lasting relief from sensitive teeth thanks to a revolutionary blend of hydroxyapatite and a 'hydro-dispersing clay'.

The areas causing sensitivity are sealed off completely, while at the same time, a process of crystallisation helps to restore micro-hardness and accelerates the re-mineralisation process.

- Reduces tooth sensitivity
- Helps prevent sensitive teeth
- Accelerates and enhances the remineralisation process
- Leaves the surface of the teeth smooth and gleaming - the lustre effect
- Strengthens and extends the whitening effect after bleaching
- Slows down the process of plaque formation



CABW060 Cavex Bite&White ExSense 50g tube

### SUPER SEAL DESENSITISER

*Potassium oxalate based, acid resistant liner and desensitiser that assists in the removal of the smear layer and seals the tubules*

SuperSeal can be used for a wide range of applications including:

- Before and after bleaching
- Treating exposed root surfaces
- Before and after prophylaxis
- Thermal sensitivity
- Under restorations
- During temporisation

- Glutaraldehyde free
- Water-based potassium oxalate
- Soft tissue friendly
- Removes smear layer
- Re-wetting agent
- Do not refrigerate
- No light curing
- Simple one step process



PH100295 SuperSeal - 5ml bottle

## REMIN PRO

*Natural, milk-free remineralising cream for teeth*

With Remin Pro, teeth are strengthened, remineralisation and desensitisation are promoted, salivation is stimulated and the acidic environment is neutralised. It assists with sealing open dentine tubes.

Remin Pro combines three proven components for effective protection against demineralisation and erosion:

- Fluoride
- Hydroxyl apatite
- Xylitol



Available in melon, mint or strawberry

- 1 x 40g tube - specify flavour
- 3-pack (3 x 40g tubes, either one of each flavour or assorted pack)
- 12-pack (12 x 40g tubes, 4 of each flavour)
- Box of 50 x 2.5g SingleDose - specify flavour

## ENDODONTIC BLEACH

### PDS ENDO PREP BLEACH POWDER

- For bleaching in endodontic therapy
- Fine sodium perborate powder
- Supplied as a 25g jar



PD34121 Endo Prep bleach powder

## BLEACHING SHEETS

### BLEACH (CLEAR) SHEETS

- Sold individually
- Available in round or square



120mm

127mm

- SORO1CL Clear sheet 120mm x 1mm - round
- SOSQ1CL Clear sheet 127mm x 1mm - square
- SORO2CL Clear sheet 120mm x 2mm - round
- SOSQ2CL Clear sheet 127mm x 2mm - square

### BIOPLAST® BLEACH

*For fabrication of bleaching splints on Scheu thermoforming machines*

- Soft pliable rubber like material
- Does not bond to acrylic
- Clear-transparent
- Round 125mm diameter



125mm

- SC3190 Bioplast bleach 125mm x 1mm - packet of 10
- SC31902 Bioplast bleach 125mm x 1mm - packet of 100



*For more information, on the Scheu thermoforming machines, please refer to page 173*

## PLASTIC BOXES

### PLASTIC BOXES

*Ideal for bleaching trays*

- 25mm deep
- With ventilation holes and hole for cord (not included)
- Available in blue, green, pink, white and yellow
- Sold individually



LAG45\_ Mouthguard box - specify colour

# Burs

## INTENSIV DIAMOND BURS

### Proper Use

- The bur shanks must be inserted as deeply as possible into the chuck
- Reach the required working speed before making contact with the working surface
- Never exceed the specified maximum speed
- Use adequate water irrigation (minimum 50ml/min)
- Clean the instruments and remove debris after each use, so as to maintain their abrasive ability

### Maintenance of diamond Instruments

- Instruments are delivered non-sterile. They must be disinfected, cleaned and sterilised prior to first use on the patient and immediately after each use.

### Disinfection

- Disinfect diamond instruments separately from non-stainless steel instruments, such as polishers and abrasives
- Use only cleaning/disinfection solutions that provide corrosion protection to ensure maximum life

### Sterilisation

- Sterilisation must be performed with validated procedures
- Avoid temperatures above 180°C which may affect the durability of the instruments
- Keep the original package for the whole life cycle of the instrument, in order to ensure batch traceability



### Colour codes of the grit sizes

	544	150 µm	125 µm*	Super coarse
	534	125 µm	106 µm*	Coarse
	524	106 µm	60/80/90 µm*	Standard
	524	80 µm		Medium
	524	60 µm		Medium
	514	50 µm		Golden Burs GB
	514	40 µm		Fine
	514	25 µm		Fine
	504	15 µm		Extra fine
	494	8 µm		Ultra fine

### Symbols of indications



■ Cavity preparation



■ Crown separation



■ Amalgam removal



■ Crown preparation



■ Root planing



■ Prophylaxis



■ Finishing of the filling



■ Orthodontics

























Following are some popular Intensiv burs. To view the complete range, please ask your Oraltec representative for the latest Intensiv catalogue.

























Intensiv diamond burs supplied as a packet of 6











# Burs









## Round Shape







Ball round																
	<b>801</b>															
	ISO ø 1/10 mm		006	007	008	009	010	011	012	013	014	015	016	017	018	
	<b>FG</b>															
	314 001 524		189	199		200S	200N		200		201S		201N		201	
	314 001 544										201SCB		201NCB			
	314 001 534								200C		201SC		201NC		201C	
	314 001 524					8200S			8200						8201	
	314 001 514					200SGB	200NGB		200GB		201SGB		201NGB		201GB	
	314 001 514			4199	4200S			4200		4201S				4201		
314 001 514			3200S			3200						3201				
314 001 504								5201S				5201				

Ball round															
	<b>801</b>														
	ISO ø 1/10 mm		019	021	022	023	024	025	026	027	028	029	033	034	036
	<b>FG</b>														
	314 001 524			400A		400S		400N		400		400B			401
	314 001 544		201CB				400SCB		400NCB		400CB				401CB
	314 001 534			400AC		400SC		400NC		400C		400BC			401C
	314 001 524					8400S		8400N		8400					
	314 001 514				400SGB		400NGB		400GB					401GB	
	314 001 514				4400S		4400N		4400					4401	
314 001 514			3400S		3400N		3400					3401			
314 001 504			5400S				5400					5401			
314 001 494						9400						9401			

## Pear Shape

Pear convex tip						
	<b>830</b>					
	ISO ø 1/10 mm		010	010	011	012
	L mm		2.8	3.0	3.0	3.0
	<b>FG</b>					
	314 235 524		218B			219B
314 235 524		8218				

Pear round							
	<b>830R</b>						
	ISO ø 1/10 mm		009	010	011	011	012
	L mm		2.8	2.8	2.8	3.0	3.0
	<b>FG</b>						
	314 237 524			218			219

Pear long, round					
	<b>830RL</b>				
	ISO ø 1/10 mm		012	016	018
	L mm		4.2	5.0	5.0
	<b>FG</b>				
	314 238 524		225	226	227



Intensiv diamond burs supplied as a packet of 6

Red = also in RA



# Burs

## Cylinder Shape

Cylinder short	835								
	ISO ø 1/10 mm	008	008	009	009	010	010	012	014
	L mm	3.0	4.0	3.0	4.0	3.0	4.0	4.0	4.0
314 109 524	211S		212S	212	210	211	214	204	
314 109 544	■				212SCB	212CB			
314 109 534	■			212C	210C	211C	214C	204C	
314 109 524	■		8212S			8211	8214	8204	

Cylinder short, rounded edge	835KR	
	ISO ø 1/10 mm	012
	L mm	4.0
314 156 524		263
314 156 534	■	263C

Cylinder short, parallel shoulder	836			
	ISO ø 1/10 mm	012	013	014
	L mm	6.0	6.0	6.0
314 110 524	114S		114	
314 110 544	■			
314 110 534	■	114SC	114C	

Cylinder extra long, rounded edge	837KR				
	ISO ø 1/10 mm	011	012	013	014
	L mm	8.0	8.0	8.0	8.0
314 158 524					
314 158 534	■	712C		611C	
314 158 524	■	8712		8614	

Cylinder medium, rounded edge	836KR		
	ISO ø 1/10 mm	011	014
	L mm	6.0	6.0
314 157 524			
314 157 534	■		
314 157 524	■	8414	
314 157 514	■		
314 157 514	□	3414	

Cylinder medium, rounded edge	836KR		
	ISO ø 1/10 mm	010	014
	L mm	5.0	5.0
314 156 524	■	8710	8714
314 156 514	□	3710B	3714B

Cylinder end-coated only	839		
	ISO ø 1/10 mm	011	014
	L mm		
314 150 524			
314 150 534	■		
314 150 524	■	01480	
314 150 514	■	01140	01440



Cylinder short, rounded edge	838		
	ISO ø 1/10 mm	009	010
	L mm	4.0	4.0
314 139 524	412	411	

Cylinder torpedo, extra long	879	
	ISO ø 1/10 mm	011
	L mm	10.0
314 290 524		
314 290 544	■	
314 290 534	■	
314 290 524	■	
314 290 514	■	310GB
314 290 514	■	4310

Cylinder round	880			
	ISO ø 1/10 mm	010	011	012
	L mm	6.0	6.0	6.0
314 140 524	305S		305	
314 140 544	■	305SCB		
314 140 534	■	305SC	305C	
314 140 514	■	305GB		
314 140 514	■	4305		

Intensiv diamond burs  
supplied as a packet of 6

Red = also in RA





---

# Constant Superior Quality

**Intensiv SA**  
Via al Molino 107  
6926 Montagnola  
Switzerland

Tel. +41 91 986 50 50  
Fax +41 91 986 50 59  
info@intensiv.ch  
www.intensiv.ch



# Burs

Cylinder round, long			
	ISO ø 1/10 mm		010
	L mm		8.0
	FG		
	314 141 524		309
	314 141 544	■	
314 141 534	■	309C	

Cylinder round, extra long					
	ISO ø 1/10 mm		011	012	013
	L mm		10.0	10.0	10.0
	FG				
	314 142 524		307A	305L	
	314 142 544	■			305LCB
	314 142 534	■	307AC	305LC	
	314 142 524	■		8305L	
	314 142 514	■	305LGB		307NGB
	314 142 514	■	4305L		4307N



## Flame Shape

Flame cylindrical, short				
	ISO ø 1/10 mm		012	013
	L mm		5.0	5.0
	FG			
	314 247 524		205S	
	314 247 544	■		
	314 247 534	■	205SC	
	314 247 514	■		205GB
	314 247 514	■		4205
	314 247 514	□	3205	
314 247 504	■	5205		

Flame cylindrical, normal								
	ISO ø 1/10 mm		009	010	011	012	013	014
	L mm		7.0	7.0	7.0	7.0	7.0	7.0
	FG							
	314 248 524				205L			285L
	314 248 544	■				205LCB		
	314 248 534	■			205LC			285LC
	314 248 514	■			205LGB			
	314 248 514	■			4205L			
	314 248 514	□		3205L				
314 248 504	■		5205L					

Flame cylindrical, long				
	ISO ø 1/10 mm		011	012
	L mm		10.0	10.0
	FG			
	314 250 524			405L
	314 250 544	■		
	314 250 534	■		405LC
	314 250 524	■		
	314 250 514	■	405LGB	
	314 250 514	■	4405L	
314 250 514	□			
314 250 504	■		5505	



Intensiv diamond burs supplied as a packet of 6







Red = also in RA





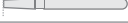



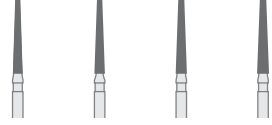
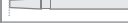

# Burs

## Tapered Shape



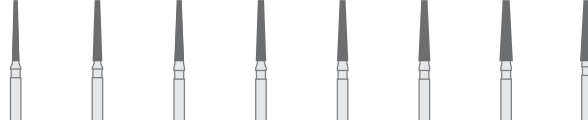

Tapered medium			
	<b>846</b>		
	ISO ø 1/10 mm	015	016 018
	L mm	6.0	6.0 6.0
	FG		
	314 171 524		109 113
	314 171 544	■	106CB
	314 171 534	■	109C 113C





Tapered long			
	<b>848</b>		
	ISO ø 1/10 mm	013	014 015 016
	L mm	10.0	10.0 10.0 10.0
	FG		
	314 173 524		D15 D5
	314 173 544	■	
	314 173 534	■	D15C D5C

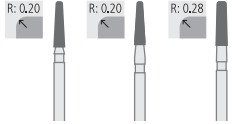



Tapered short			
	<b>845</b>		
	ISO ø 1/10 mm	014	
	L mm	4.0	
	FG		
	314 170 524		208

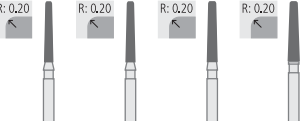



Tapered			
	<b>847</b>		
	ISO ø 1/10 mm	010	012 013 014 015 016 017 018
	L mm	8.0	8.0 8.0 8.0 8.0 8.0 8.0 8.0
	FG		
	314 172 524	116A 116	116N 117 117N
	314 172 544	■	116CB 117CB
	314 172 534	■	116C 116NC 117C 117NC
	314 172 524	■	8117

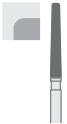



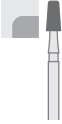

Tapered rounded edge			
	<b>846KR</b>		
	ISO ø 1/10 mm	016	016 016
	L mm	6.0	6.0 6.0
	FG		
	314 545 524		417R
	314 545 544	■	
	314 545 534	■	417RC
	314 545 524	■	8417R
	314 545 514	■	
	314 545 514	□	3513 3525

Tapered rounded edge, normal			
	<b>847KR</b>		
	ISO ø 1/10 mm	012	013 014 016
	L mm	8.0	8.0 8.0 8.0
	FG		
	314 546 524		422R
	314 546 544	■	422RCB
	314 546 534	■	422RC
	314 546 524	■	8427 8422R
	314 546 514	■	
	314 546 514	■	4427 4422R
	314 546 514	□	3427 3422R
	314 546 504	■	5422R

Tapered rounded edge, long			
	<b>848KR</b>		
	ISO ø 1/10 mm	016	
	L mm	10.0	
	FG		
	314 553 524		
	314 553 544	■	
	314 553 534	■	
	314 553 524	■	
	314 553 514	■	
	314 553 504	■	5423R

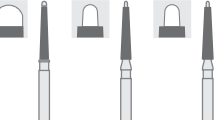







Tapered rounded edge			
	<b>845KR</b>		
	ISO ø 1/10 mm	021	
	L mm	4.0	
	FG		
	314 544 524		411R







Tapered round, safe end			
	<b>851</b>		
	ISO ø 1/10 mm	012	015 016
	L mm	8.0	8.0 8.0
	FG		
	314 219 524		19 18
	314 219 534	■	19C 18C

Red = also in RA

















# Burs







Tapered round, normal							
	<b>856</b>						
	ISO ø 1/10 mm		015	015	016	016	018
	L mm		8.0	8.0	8.0	8.0	8.0
	<b>FG</b>						
	314 198 524				D18		235
	314 198 544	■					
	314 198 534	■			D18C		
	314 198 524	■					8235
	314 198 514	■	D18GB				4235
314 198 514	■	40D18					





Tapered round, long					
	<b>850</b>				
	ISO ø 1/10 mm		012	013	016
	L mm		10.0	10.0	10.0
	<b>FG</b>				
	314 199 524		233		
	314 199 544	■		233CB	
	314 199 534	■	233C		
	314 199 524	■			
	314 199 514	■			
314 199 514	■			4236	
314 199 514	□			3236	
314 199 504	■		5234	5236	

## Pointed Shape

Pointed round						
	<b>955</b>					
	ISO ø 1/10 mm		007	008	009	010
	L mm		4.0	4.0	4.0	4.0
	<b>FG</b>					
	314 699 524					D9
	314 699 534	■				D9C
	314 699 524	■				80D9
	314 699 514	■			D9GB	
	314 699 514	■			40D9	
314 699 504	■		50D9			

Pointed cone						
	<b>858</b>					
	ISO ø 1/10 mm		010	010	011	012
	L mm		7.0	7.0	7.0	7.0
	<b>FG</b>					
	314 165 524		D11			D2
	314 165 534	■	D11C			D2C
	314 165 514	■	D11GB		D2GB	
	314 165 514	■			40D2	
	314 165 514	□		30D2		
314 165 504	■		50D2			

Pointed cone					
	<b>859</b>				
	ISO ø 1/10 mm		014	015	016
	L mm		10.0	10.0	10.0
	<b>FG</b>				
	314 166 524		D34		D4
	314 166 534	■	D34C		D4C
	314 166 524	■			80D4
	314 166 514	■		D4GB	
	314 166 514	■		40D4	
314 166 514	□	30D4			
314 166 504	■	50D4			

Pointed cone				
	<b>859</b>			
	ISO ø 1/10 mm		011	012
	L mm		11.0	11.0
	<b>FG</b>			
	314 167 524			D3
	314 167 534	■		D3C
	314 167 524	■		80D3
	314 167 514	■		D3GB
	314 167 514	■		40D3
314 167 514	□		30D3	
314 167 504	■		50D3	







Intensiv diamond burs supplied as a packet of 6





Red = also in RA







# Burs

## Torpedo Shape



Torpedo conical					
	<b>878K</b>				
	ISO ø 1/10 mm		014	015	016
	L mm		8,0	8,0	8,0
	<b>FG</b>				
					
	314 298 524		181N		182
	314 298 544	■			
314 298 534	■	181NC		182C	
314 298 514	■		182GB		
314 298 514	■		4182		
314 298 504	■	5182			







Torpedo conical				
	<b>877K</b>			
	ISO ø 1/10 mm		015	016
	L mm		6,0	6,0
	<b>FG</b>			
				
	314 297 524			162
	314 297 544	■		
314 297 534	■		162C	
314 297 514	■		162GB	
314 297 514	■		4162	











Torpedo conical			
	<b>879K</b>		
	ISO ø 1/10 mm		018
	L mm		10,0
	<b>FG</b>		
			
	314 299 524		193
	314 299 544	■	
314 299 534	■	193C	
314 299 524	■		
314 299 514	■		
314 299 514	■		
314 299 504	■		
314 299 494	■	9195	

Intensiv diamond burs  
supplied as a packet of 6

## Football Shape

Football conical bud			
	<b>368</b>		
	ISO ø 1/10 mm		018
	L mm		3,5
	<b>FG</b>		
			
314 257 524		255A	

Football conical bud					
	<b>368</b>				
	ISO ø 1/10 mm	021	022	023	024
	L mm	5,0	5,0	5,0	5,0
	<b>FG</b>				
					
	314 257 524			255	
	314 257 544	■			255CB
	314 257 534	■		255C	
	314 257 524	■		8255	
314 257 514	■		255GB		
314 257 514	■		4255		
314 257 514	□	3255			
314 257 504	■	5255			

Football egg									
	<b>379</b>								
	ISO ø 1/10 mm	016	017	018	021	022	023	031	032
	L mm	3,5	3,5	3,5	4,5	4,5	4,5	6,0	6,0
	<b>FG</b>								
									
	314 277 524	268		257			258		
	314 277 544	■							
	314 277 534	■	268C	257C			258C		
	314 277 524	■		8257			8258		
314 277 514	■		257GB		258GB		259GB		
314 277 514	■		4257		4258	4258A	4259		
314 277 514	□	3257			3258		3259		
314 277 504	■	5257			5258		5259		



Intensiv diamond burs  
supplied as a packet of 6

Red = also in RA



# Burs

Football egg		ISO 1/10 mm			
379 Slim		021	022	022	023
L mm		5.0	5.0	5.0	5.0
FG					
314 277 524					250
314 277 544	■				
314 277 534	■				250C
314 277 524	■				8250
314 277 514	■		250GB		
314 277 514	■		4250	4250B	
314 277 514	□	3250			
314 277 504	■	5250			
314 277 494	■				

Football grenade		ISO 1/10 mm	
390			015
L mm			3.0
FG			
314 274 524			
314 274 534	■		
314 274 514	■	274GB	
314 274 514	■	4274	

Intensiv diamond burs supplied as a packet of 6

Red = also in RA



## Wheel Shape

Wheel wide		ISO 1/10 mm	
909		034	039
L mm		1.0	1.3
FG			
314 068 524		10A	11A
314 068 544	■		
314 068 534	■	10AC	11AC

Wheel		ISO 1/10 mm	
818			040
L mm			1.0
FG			
314 041 524			111
314 041 534	■		111C
314 041 514	■		



## Special Shape

Depth marker		Penetration depth 1/10 mm		
834		004	008	012
FG				
314 552 524		S4	S8	S12

Cylindrical, spiral groove		ISO 1/10 mm	
842			016
L mm			9.0
FG			
314 115 524			450

Conical, spiral groove		ISO 1/10 mm	
848		020	023
L mm		9.0	9.0
FG			
314 177 524		451	6S



To view the complete range, please ask for a copy of the latest Intensiv catalogue





# Burs

## CEREC SET

*Diamond instruments for Cerec restorations*

### Indication

- Preparation and finishing of inlay and veneer cavities for the Cerec method



ITSET022  
Cerec Restoration Kit 022



### Set includes

- 1 cylindrical bur for cavity preparation (ISO size 014, head length 6.0mm, 106µm grit)
- 1 cylindrical bur for finishing the cavity margins (ISO size 011, head length 6.0mm, 25µm grit)
- 2 tapered burs for slight occlusal enlargement of the cavity (ISO sizes 010 and 018, 25µm grit)
- 1 torpedo bur for substance-preserving veneer preparation (ISO size 011, head length 10.0mm, 40µm grit)
- 2 inverted cone burs with rounded edges for occlusal contouring (40µm and 8µm grit)
- 1 bud-shaped bur for fissure contouring (8µm grit)

Ref. 022								
ISO ø 1/10 mm	014	011	010	013	018	011	015	012
L mm	6.0	6.0	8.0	3.0	8.0	10.0	5.0	4.5
µm	106	25	25	8	25	40	40	8
524	414							
514						4310	4323	
514		3414	3116		3526			
494				9274				9223
ISO No.	314 157	314 157	314 172	314 274	314 546	314 290	314 234	314 234

## PROXOSHAPE SET

*Set includes 10 oscillating diamond-coated files for the removal of overhangs and finishing of proximal filling surfaces*

### Product description

- 4 files as in the Proxoshape set
- 3 files with extended working area (grits 90, 40 and 15µm)
- 2 narrow files, 40 and 15µm grits
- 1 distal diamond-coated file in 15µm grit, special file PS3G for polishing root surfaces with difficult access

Ref. 115										
L mm	8.5	8.5	8.5	8.5	11.0	11.0	11.0	8.5	8.5	3
µm	125	90	40	15	90	40	15	40	15	15
524		PS1			PS1L					
534		PS0								
514			PS2		PS2L		PS2S			
504				PS3		PS3L		PS3S	PS3G	

*Use in combination with Intensiv Swingle oscillating handpiece - for more information, please refer to HANDPIECES, page 52.*

### Indications

- Removal of filling and cement overhangs
- Finishing and trimming of proximal crown margins in gold or ceramic
- Contouring and finishing of proximal restoration surfaces

### Benefits

- Easier access to the interdental space
- No iatrogenic damage to adjacent teeth
- Prevention of surface wave generation caused by rotating burs



ITSET115  
Proxoshape Set 115

*Proxoshape files also sold separately*



## ORTHO-STRIPS ONE-SIDED SET

*Set includes six oscillating diamond strips for one-sided interdental reduction of tooth size and proximal polishing in orthodontics (stripping)*

### Product description

- Flexible strips, one-sided diamond coating
- 3 different grits: 40, 25 and 15µm files for reduction, contouring, finishing and polishing
- Left ("L") and right ("R") versions for mesial and distal in the upper and lower jaw

Ref. 064						
µm	40	25	15	40	25	15
514		OS40L		OS40R		
514			OS25L		OS25R	
504				OS15L		OS15R
	Contouring	Finishing	Pre-polishing	Contouring	Finishing	Pre-polishing

### Indications

- Opening and enlargement of the interdental spaces in orthodontics without iatrogenic damage to adjacent teeth
- One-sided proximal contouring, finishing and polishing

*Use in combination with Intensiv Swingle oscillating handpiece - for more information, please refer to HANDPIECES, page 52.*



ITSET064  
Ortho-Strip One-Sided Set

*Ortho-Strip files also sold separately*

*Also available in double-sided sets and strip files - for more information please refer to ORTHODONTIC PRODUCTS, page 130.*



# Burs

## NORTH BEL DIAMOND BURS

### SHANK KEY

FG - Friction Grip High Speed  
 FGSH - Friction Grip Short  
 RA - Right Angle Latch Grip

### GRIT KEY

M - Blue Stripe Medium  
 X - Green Stripe Coarse  
 F - Red Stripe Fine  
 C - Yellow Stripe Extra Fine  
 CS - White Stripe Ultra Fine



North Bel diamond burs supplied as a packet of 5



**801**



FGM	008	009	010	012	014	016	018	021	023	035
FGSHM	-	-	010	-	014	-	018	-	-	-
RAM	-	-	-	012	014	-	-	-	023	035
FGC	-	-	-	-	014	-	-	-	-	-
FGCS	-	-	-	-	014	-	018	-	-	-



**845**



FGM	009	010	012	014
-----	-----	-----	-----	-----



**846**



FGM	014	016	021
-----	-----	-----	-----



**847**

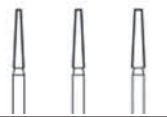

FGM	014	016	018
FGF	014	016	-



**848**



FGM	016	018	021
FGC	-	018	-
FGCS	-	018	-



**806**



FGM	010	012	014	016	018
-----	-----	-----	-----	-----	-----



**809**



FGM	012
-----	-----



**850**



FG	016	021
----	-----	-----



**852**



FGM	010	012
FGC	-	012
FGS	-	012



**858**



FGM	014	016
FGF	014	-



**830**



FGM	008	010	012	016	021
-----	-----	-----	-----	-----	-----



**860**



FGM	010	012	014	016
FGF	-	012	-	-



**862**



FGM	012	014	016
FGF	012	-	-
FGC	012	-	-
FGCS	012	-	-
FGX	012	-	-

North Bel diamond burs supplied as a packet of 5



**836**



FGM	012	014
-----	-----	-----



**837**



FGM	012	014	016
-----	-----	-----	-----



**868**



FGM	016	018	021	024
FGC	-	018	-	-
FGS	-	018	-	-



**877**



FG	010	012
----	-----	-----



**879K**



FG	014
----	-----



**838**



FGM	010	012
-----	-----	-----



**839**



FGM	016
-----	-----



**881**



FG	012	014	016
----	-----	-----	-----



**909**



FG	031	035	042	055
----	-----	-----	-----	-----

# Burs

## NORTH BEL CARBIDE BURS

**north bel**  
International Srl

North Bel carbide burs  
supplied as a packet of 5



### ROUND - NO10\_



US-No	1/4	1/2	1	2	3	4	5	6	7
	006	007	008	010	012	014	016	018	021
FG	.	.	.	.	.	.	.	.	.
CA	.	.	.	.	.	.	.	.	.



### PEAR - NO70\_



US-No	329	330	331	332	330L	331L	332L
	006	008	010	012	008	010	012
FG	.	.	.	.	.	.	.

LONG



### TAPER Flat End Plain NO23\_



US-No	169	170	171
	009	010	012
FG	.	.	.



### STRAIGHT Round End Cross Cut NO31R0\_



US-No	1556	1557	1558
	008	010	012
FG	.	.	.
CA	.	.	.



### AMALGAM - NO2450\_

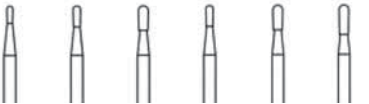

US-No	244	245	246	256	257	271
	006	010	012	009	011	014
FG	.	.	.	.	.	.

## INTENSIV CROWN CUTTING BURS

### INTENSIV CROWN CUTTING BURS

*Carbide instruments for crown cutting*

Instruments with rounded and plain working surfaces with unique cutting edges for precise, vibration-free division.



#### Indications

- Cutting of crowns and bridges made of metal, metal-ceramic

#### Advantages

- Swiss premium quality
- Excellent cutting performance
- High resistance to instrument breakage
- Low vibration of instrument



Supplied as a packet of 6

ITC4\_ Intensiv carbide crown cutting burs

<b>Cylinder 835</b>				
ISO ø 1/10 mm		009	010	012
L mm		4.1	4.1	4.1
FG 500 314 107 008		CU41009	CU41010	CU41012

<b>Cylinder rounded 838</b>			
ISO ø 1/10 mm		010	012
L mm		3.9	3.9
FG 500 314 137 008		CU41310	CU41312

<b>Tapered 845</b>			
ISO ø 1/10 mm		012	016
L mm		3.9	3.9
FG 500 314 168 008		CU41612	CU41616

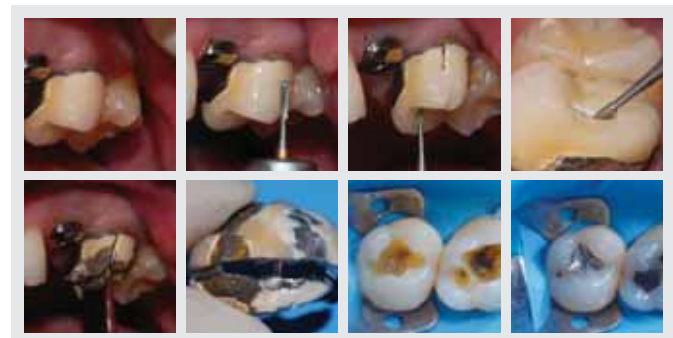

# Burs

## JET CARBIDE BURS

### ROUND CARBIDE BURS RA or FG - 6 blades - packet of 5

	<b>Round</b> JE00_										
	Bur No	1/4	1/2	1	2	3	4	5	6	7	8
	Size	006	007	008	010	012	014	016	018	021	023
	FG	.	.	.	.	.	.	.	.	.	.
	RA	.	.	.	.	.	.	.	.	.	.

### REGULAR BURS 6 blades - packet of 5

	<b>Pear</b>				
	Bur No	329FG	330FG	331FG	332FG
	Size	006	008	010	012

	<b>Pear Long</b>			
	Bur No	331L	332L	333L
	Size	010	012	014

	<b>Cylinder (Straight Fissure)</b>	
	Bur No	57FG 58FG
	Size	010 012

	<b>Cylinder (Cross Cut)</b>	
	Bur No	557FG
	Size	010

	<b>Cylinder (Straight Fissure) with Dome</b>			
	Bur No	1156FG	1157FG	1158FG
	Size	009	010	012

	<b>Cylinder (Cross Cut) with Dome</b>		
	Bur No	1558FG	1557FG
	Size	012	010

Jet carbide burs  
supplied as a packet of 5

	<b>Straight Fissure Tapered Long</b>		
	Bur No	170LFG	171LFG
	Size	010	012

	<b>Straight Fissure Tapered</b>			
	Bur No	170FG	171FG	172FG
	Size	010	012	016

	<b>Taper Fissure with Dome</b>		
	Bur No	1171FG	1172FG
	Size	012	016

	<b>Straight Fissure Tapered (Cross Cut)</b>	
	Bur No	701FG
	Size	012

	<b>Taper Fissure (Cross Cut)</b>			
	Bur No	700FG	701FG	702FG
	Size	010	012	016

**Kerr**

### FINE CROSS CUT BURS - packet of 5

	<b>Straight Fissure with Dome</b>		
	Bur No	1957FG	1958FG
	Size	010	012

	<b>Cross Cut Straight Fissure</b>	
	Bur No	2158FG
	Size	012

	<b>Dome Taper Fissure</b>	
	Bur No	1970FG
	Size	010

	<b>Straight Fissure</b>		
	Bur No	2056FG	2057FG
	Size	009	010

	<b>Straight Fissure Dome Long</b>	
	Bur No	1958LFG
	Size	012

	<b>Taper Fissure</b>	
	Bur No	2069FG
	Size	009

### TRIMMING & FINISHING BURS 12 blades - packet of 5

	<b>Egg</b>			
	Bur No	7404FG	7406FG	7408FG
	Size	014	018	023

	<b>Bullet shape</b>			
	Bur No	7801FG	7802FG	7803FG
	Size	009	010	012

	<b>Needle</b>			
	Bur No	7901FG	7902FG	7903FG
	Size	009	010	012

**Kerr**

	<b>Flame</b>			
	Bur No	7104FG	7106FG	7108FG
	Size	014	018	023

	<b>Ball</b>		
	Bur No	7004FG	7006FG
	Size	009	012

	<b>Taper Finishing</b>		
	Bur No	7702FG	7713FG
	Size	010	012

	<b>Long Tapered Trimming</b>	
	Bur No	7714FG
	Size	014

	<b>Tapered Trimming</b>	
	Bur No	7214FG
	Size	010

### FINE FINISHING BURS 30 blades - packet of 5

	<b>Ball with Dome</b>			
	Bur No	9004FG	9006FG	9008FG
	Size	014	018	023

	<b>Concave Shape</b>	
	Bur No	9103FG
	Size	012

	<b>Tapered Trimming</b>	
	Bur No	9214FG
	Size	010

	<b>Egg</b>	
	Bur No	9406FG
	Size	018

	<b>Bullet</b>	
	Bur No	9803FG
	Size:	012

	<b>Needle Long</b>		
	Bur No	9903FG	9904FG
	Size	012	014

	<b>Long Tapered Trimming</b>	
	Bur No	9714FG
	Size	014

	<b>E/Long Tapered Trimming</b>	
	Bur No	9642FG
	Size	010

## THOMAS STEEL BURS

### ROUTINE BURS - packet of 6

**THOMAS**

	<b>101 CAVITY - Round Plain Cut No 1</b>															
	006	007	008	009	010	012	014	016	018	019	021	023	025	027	029	031
	1/4	1/3	00	0	1	2	3	4	5	6	7	8	9	10	11	12
	RA	.	.	.	.	.	.	.	.	.	.	.	.	.	.	.
	RAL	.	.	.	.	.	.	.	.	.	.	.	.	.	.	.

Code: TH101\_

# Burs

## BUR ACCESSORIES

### MAGNETIC BUR BLOCK

The magnetic bur blocks offer accessible storage for all types of rotary cutting instruments

- Made of sturdy polypropylene plastic
- Can be ultrasonically cleaned
- Compatible with most chemical disinfectants
- Can be autoclaved
- Accepts all shank sizes: right angle, friction grip and handpiece
- Available in a range of colours
- Available in 3 sizes

8 bur holder (round)  
14 bur holder (rectangle)  
24 bur holder (round)

KR31\_  
Magnetic bur blocks  
- specify size and colour

**Kerr**

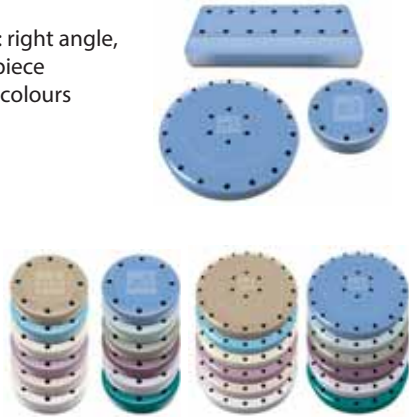

### INTENSIV HYGIENIC TRAYS

Resistant high quality stainless steel instrument trays for all rotating instruments for routine treatment protocols

#### HT100 - 3 dismantable parts

(foldable cover, instrument tray, bottom)

- Folded back cover serves as base for the tray during treatment
- Ergonomic instrument access due to high and inclined tray position

#### HT200 - 2 dismantable parts (foldable cover, instrument tray)

- Ergonomic instrument access due to standalone tray

#### HT300 - 2 dismantable parts (foldable cover, instrument tray)

- Folded back cover keeps the instrument tray in place during treatment
- Ergonomic instrument access due to low and inclined tray position



ITHT100

ITHT200

ITHT300

#### HT3000 - 2 dismantable parts

- Without hard to reach fissures and hollows
- Rounded edges
- Suitable for standard sterilisation trays
- 36 FG and 18 RA instrument holders arranged irregularly to each other

ITHT3000

**Intensiv**  
Swiss Dental Products



### PRACTICUS BUR POLISHING CADDY

Autoclavable polisher and bur caddy

- The caddy holds rotating instruments with space for 12 FG and 6 RA instruments
- Ergonomic handling with one hand is possible
- Additional storage space is available when the lid is open
- Due to the snap lock, the caddy can be easily closed
- Autoclavable at 135°C
- Available in 3 colours

**KENDA**  
DENTAL POLISHERS



KE270 Practicus polisher caddy - blue  
KE272 Practicus polisher caddy - white  
KE273 Practicus polisher caddy - violet

### LARIDENT BUR CASSETTES

- Cassette holds 12 burs (8 FG and 4 RA)
- Ideal for use in the ultrasonic cleaner
- Autoclavable
- Lid locks open or closed

**LARIDENT**

Available in 3 colours

LABURL84B Blue  
LABURL84G Green  
LABURL84Y Yellow

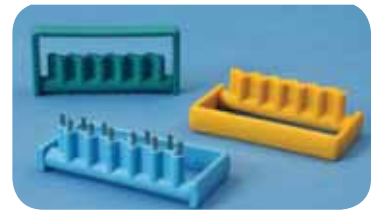

### BUR DISINFECTION BOX

Handy plastic container for presoaking burs

- Specially designed for soaking burs
- Lift out basket makes handling easy
- Hole in the lid allows bur to be dropped in with lid on



LABURBOX Bur disinfection box

### RUBBER BLOCK FOR CLEANING BURS

Diakleen rubber block for rapid cleaning of clogged diamond instruments

IT6000  
Rubber block

**Intensiv**  
Swiss Dental Products



### STONE FOR CLEANING BURS

Cleaning stone for burs  
(10cm x 2.5cm)

DF15000 Cleaning stone

**DFS**  
DENTAL FINISHING SYSTEMS

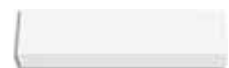

### BUR BRUSHES

Plastic handle bur brush  
STWB022

Metal handle bur brush  
STWB022B



# Cotton Products

## RICHMOND COTTON ROLLS

- Available in braided and plain

RI200215	Braided cotton rolls - packet 10,000	
RIROL2500	Braided cotton rolls - packet 2,500	
RI200404	Plain cotton rolls - packet 2,000	
RI216206	EconoRolls plain cotton rolls - packet of 2,000	

## COTTON ROLL DISPENSERS

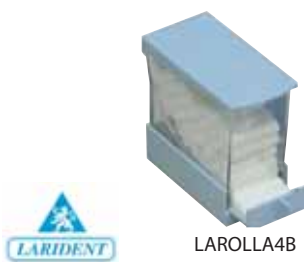

LAROLLA4B



LAROLLA45B

LAROLLA4_	50 roll capacity dispenser - white or blue
LAROLLA45_	Individual dispensing - white or blue

## RICHMOND COTTON PELLETS

RI100107	Cotton pellets #2 (large)	
RI100108	Cotton pellets #3 (medium)	
RI100109	Cotton pellets #4 (small)	

## COTTON PELLET DISPENSERS

- Medium hole - with spring
- Available in plastic or metal



LAPELLETDIP  
Plastic dispenser  
A20.2



LAPELLETDMP  
Metal dispenser  
A20.5

## THROAT PACK

- Soft, absorbent gauze and cotton wool
- High quality throat pack
- 10 metres long x 7cm wide

CHTHROAT	10 metre roll	
----------	---------------	---

## BULK RATE

Purchase 10 or more and receive a 10% discount

## GAUZE ROLL

- Gauze absorbent roll
- 9cm x 100m

MUGAUZE90	Gauze roll	
-----------	------------	---

## NON WOVEN GAUZE SQUARES

- 4 ply gauze squares
- Available in two sizes
- Supplied as a packet of 100

INSWAB5	5cm x 5cm	
INSWAB7	7.5cm x 7.5cm	

## STERIPOCKETS

Prepackaged pre-sterilised packets of non-woven sponges

- Perfect for use post extraction
- Size 5cm x 5cm
- Supplied as 300 packets of two gauze squares (a total of 600 squares)

RI300408	Gauze swabs - packet of 300	
----------	-----------------------------	---

## DRI-AID

- Thin, absorbent, protective wafers that provide a dry working field
- Improve access and retain their shape
- Use with bonding, restorations, cementation and sealing

YO331125	Dri-Aid small - packet of 250	
----------	-------------------------------	---

## REFLECTIVE SHIELDS PLUS

Large reflective shields with gauze pads

- Better illumination of the oral cavity
- Non-woven material for good moisture retention
- Heart shape accommodates buccal anatomy
- Size 41.8mm wide

RI600700	Reflective Shields - packet of 50	
----------	-----------------------------------	---

## SPONGOSTAN

Dental haemostatic sponges

- Cube shaped porcine gelatine sponge designed for dental use
- Size 1cm x 1cm x 1cm
- Supplied as a packet of 24

JMMS0005	Spongostan	
----------	------------	---

## SURGICEL ABSORB HAEMOSTAT

The original loose knit structured material that drapes and wraps well

- Proven bactericidal properties in vitro
- Size 1.3 x 5.1cm

JM1906GB	Surgicel - packet of 12	
JM1955	Surgicel - packet of 24	

## PELE TIM

Foam pellets for applying liquid and paste preparations

### Indications

- Removal of material excess while cementation or sealing
- Vitality tests

VO2250	Pele Tim No. 0 - 3,000 x 3mm	
VO2252	Pele Tim No. 1 - 3,000 x 4mm	
VO2253	Pele Tim No. 2 - 1,000 x 5mm	
VO2254	Pele Tim No. 3 - 500 x 8mm	
VO2255	Pele Tim No. 4 - 500 x 6 x 8mm	

## COTTON BUDS

- 100% pure cotton
- Supplied as a packet of 150

JJ21533038	Cotton buds	
------------	-------------	---

# Denture Products

## PALA HEAT CURE ACRYLICS

### PALADENT 20®

Heat curing denture base resin for fabrication of full and partial dentures

- 20 minute polymerisation time
- Heat curing freely dosable denture base resin for fabrication of a full and partial dentures using the press pack technique
- Cadmium free
- Precise
- Working time up to 30 minutes

#### Indications

- Total dentures
- Partial dentures



KL64707776 Paladent 20 powder R50 veined 1kg  
 KL64707772 Paladent 20 liquid 500ml

### PALADON 65®

60 minute polymerisation time

Paladon 65 excels for its exceptional mechanical qualities. It is easily processed, without use of complex devices. Because of the extended processing time of up to 60 minutes - multiple prostheses can be fabricated simultaneously.

To prevent knitline formation, Paladon 65 can be injected with the Palajet, thereby significantly increasing the precision of fit.

Paladon 65 exhibits very little polymerisation shrinkage, very good shade stability, and a very low rate of residual monomers.

#### Advantages

- Long cure for less residual monomer
- Denture standard for more than 70 years
- Long-term stability and precision fit
- Very good mucosal tolerance because of low residual monomer content
- Good shade stability
- Cadmium free
- Biocompatible (certified)
- Injectable using Palajet
- Low polymerisation shrinkage

#### Indications

- Total dentures
- Partial dentures
- Extensions
- Indirect relines
- Extensions



KLPALAD65P Paladon 65 powder R50 veined 1kg  
 KLPALAD65C Paladon 65 powder clear 1kg  
 KLPALAD65L Paladon 65 liquid 500ml

## PALA COLD CURE ACRYLICS

### PALADUR®

The fast-curing, cold-curing polymerising denture acrylic for reliable and economic denture repairs

Because of its remarkable physical properties, Paladur is the perfect denture material for rehabilitating a denture, eg, a Paladon 65 denture, after a fracture or chip.

- Easy processing and drop-by-drop flow consistency enable performance of a reliable restoration or support - simply and quickly
- Carefully designed formula allows curing of thinner layers without the use of polymerisation equipment
- Low shrinkage index ensures long-lasting precision of denture fit after the repair
- Wide selection of shades and special shade matching with all of the Kulzer denture materials make the repairs almost invisible
- Very simple processing
- Reliable and fast curing, without use of devices
- Cadmium free



KL64707967 Paladur powder R50 veined 1kg  
 KL64707938 Paladur liquid 500ml

### PALAPRESS®

Castable cold-curing denture acrylic

Palapress is fast and economic, whether being used for cast model finishing, supports or repairs. The casting time of about 2 minutes and a working time of up to 7 minutes ensure a highly efficient acrylic procedure.

#### Advantages

- Short processing time
- Very good mucosal tolerance because of low residual monomer content
- Biocompatible (certified)
- Cadmium free
- High conformal accuracy
- Shade-stable using a catalyst system without tertiary amines

#### Indications

- Partial dentures
- Completing CoCr RPD metal framework dentures
- Marginal shaping
- Repairs
- Indirect relines
- Extensions



KL64707817 Palapress powder clear 1kg  
 KL64707798 Palapress powder R50 veined 1kg  
 KL64707785 Palapress liquid 500ml

All PALA products are biocompatible and certificates are available

We have a wide range of teeth available - please refer to TEETH section, pages 170-172

# Denture Products

## PALAXPRESS®

*Cold curing universal denture material*

Full dentures can be fabricated with the matched PalaXpress/Palajet system using the injection method. PalaXpress is used for casting partial dentures, repairs and supports. This enables full and partial dentures and repairs to be finished with a shade harmonisation never previously possible.

- Full maxillary and mandibular dentures (injection method)
- Model cast denture finishing (casting technique)
- Margin forming
- Repairs and extensions
- Indirect supports

### Advantages

- Cadmium free
- Biocompatible (certified)
- Very good mucosal tolerance because of low residual monomer content
- Highest precision and accuracy of fit
- Reduced and visible positioning in the laboratory
- Shade-stable using a catalyst system without tertiary amines
- Unique dosing system

### Indications

- Partial dentures
- Completing CoCr RPD metal framework dentures
- Marginal shaping
- Repairs
- Indirect relines
- Extensions



- KL64710516 PalaXpress powder R50 1kg
- KL64711485 PalaXpress powder clear 1kg
- KL66021842 PalaXpress powder natural pink 1kg
- KL64710513 PalaXpress liquid 500ml



Palamat® Elite  
Polymerisation Unit



Palajet® Pneumatic  
Injection Unit

Dentures fabricated using Palamat® Elite and Palajet® with PalaXpress acrylic have a very high precision fit. For more information on these units, please refer to LABORATORY PRODUCTS, pages 94-95.

All PALA products are biocompatible and certificates are available

## MELIODENT ACRYLIC PRODUCTS

- Cadmium free
- Uniform particle size guarantees good polishing
- Lower residual monomer content reduces the risk of irritation for the patient



### MELIODENT HEAT CURE

- 6 minute dough time enables time savings by packing dentures earlier
- Working time in excess of 30 minutes
- Curing time 22 minutes
- Competitive price



- KL64713213 Powder clear 1kg
- KL64713271 Powder pink veined H65 1kg
- KL64713308 Liquid 500ml

### MELIODENT RAPID REPAIR

- Cold cure acrylic for repairing dentures



- KL64713413 Powder pink veined H65 1kg
- KL64713415 Liquid 500ml

### MELIODENT ORTHODONTIC ACRYLIC

- Strong and rigid when cured, allowing the stress load of the wires to be better accommodated
- Better clinical fit



- KL64713414 Powder clear 1kg
- KL64713416 Liquid 500ml

## OTHER ACRYLICS

### PALAVIT 55 VS®

*Universal synthetic, tooth-coloured, self-curing acrylic for repairs and long-term provisionals*

#### Advantages

- High lustre polishing and shade stability
- High mechanical strength and low water intake

#### Range of applications

- Restoration of facets
- Repair of methyl methacrylate crown and bridge veneers
- Bonding of prefabricated facets (to metal frameworks)
- Fabrication of long-term provisionals (facet technique)
- Aesthetic augmentation of prefabricated teeth
- Fabrication of tooth-coloured prosthesis bases
- Fabrication of veneer facets



Available in shades A2, A3, A3.5, B3, D3, Incisal

- KLPALV55L Palavit 55 liquid 45m
- KLPALV55\_ Palavit 55 powder 100g - specify shade





# Denture Products

## PALASEAL® Denture Sealant

Light-curing, transparent, one-component, PMMA-based sealant for sealing the surfaces of:

- Laboratory-prepared materials for provisionals
- Sealing permanent prostheses



### Advantages

- Increased surface hardness
- Long-term stability of bonds to acrylic
- Smooth surface
- Low plaque deposition
- No polishing required



KL64708063 Palaseal 2 x 15ml bottles

## PALABOND® Secure bonding agent for use between denture material and acrylic teeth



Consistent use of the transparent bonding agent Palabond increases the bonding between the teeth and the denture base and also improves the bonding between repairs and denture base materials.

### Advantages

- Secure bonding, even in difficult situations
- Durable and gap free bonding
- Transparent, invisible colour
- Usable for all prosthetic materials and acrylic teeth

### Application

- Between denture material and acrylic teeth
- Between denture material and repairs

### Preparation procedure

- Effective within 10 minutes after application
- No light curing required



KL64708082 Palabond 45ml

## AISLAR® Separating fluid



Aislar is a formaldehyde-free, aqueous solution for separating plaster surfaces from denture acrylics and composites.

- Very high precision (no layer formation)
- Excellent for separating plaster from acrylics
- Smooth surfaces
- Applicable to all plasters and all cold and curing acrylics
- Short drying time
- Formaldehyde-free
- Reliable curing of the denture surface
- Good stability during storage



KL64708058 Aislar 2 x 1000ml

## SIGNUM CONNECTOR Light curing bonding agent between prosthetic acrylic materials and light curing veneering materials

- For individual colour and shape modifications on ready-made dentures
- For the individual colouring of prosthetic based acrylics



KL64714211 Signum connector - 5ml bottle

## PALA CRE-ACTIVE® Light curing colourfluid system for customised characterisation of dentures

Use in combination with Signum connector for heat-curing and cold-curing resins. Suitable for customised characterisation of full and partial dentures and implant-retained dentures. The different consistencies and shades make it possible to give different parts of the gingiva light red or dark red tones.



### Benefits

- Easy, fast application
- Easy gingival customisation
- 6 intensive shades
- 6 gingiva materials base materials
- Easily trimmed and polished



### Indications

- Customisation of full and partial dentures
- Customisation of implants
- Production of gingival masks

Set includes 12 x 3g syringes (see below), 1 x Pala cre-active shade guide, 20 x (metal) cannulae 1.2mm, 5 x (plastic) cannulae 1.87mm and 1 x brush



KL66033445 Pala cre-active set

### Syringe colours

Colour fluids: white, polar, pink, red, maroon, black  
Gingiva materials: pink, shade 200, R50, light pink, clear, gum

### Pala cre-active refills

- Available in various colours (see syringe colours above)



KL66033463 Pala cre-active refills 3g syringe - specify shade

## RETENTION SET

### CEKA PRECI-LINE PERMA-RET SET Mechanical retention for acrylic and composite teeth

- A recess is drilled with the twist drill
- The precious metal wire is threaded into the recess and cut
- Can be bent for additional retention

AL1601  
Preci-Line Perma-Ret set includes 1 wire holder, 100cm of Perma-Ret wire and 3 twist drills



### Kit contents are also available separately:

- AL1602 100cm of Perma-Ret wire
- AL1604 Wire holder
- AL1606 Perma-Ret burs - packet of 3

# Denture Products

## RELINE MATERIALS

### MUCOPREN SOFT

*Permanent soft relining material on a vinyl polysiloxane base for direct and indirect application*



#### Advantages

- Excellent bond
- Very smooth, hydrophobic silicone surface for high resistance to contamination
- Unique sealing with Mucopren® silicone sealant for an optimum bond and smooth, shiny surface
- Permanent elasticity ensures a high degree of comfort during wear
- High tear resistance, easily trimmed, best mechanical properties
- Neutral taste and odour

KT28105 Mucopren soft liner set  
Set includes 50ml Mucopren Soft, 50ml Mucopren silicone sealant, 10ml Mucopren adhesive, 7 mixing tips (ø 6,5mm), 20 mixing tips (ø 3,2mm), 1 brush holder, 20 single-use brushes, 1 steel cutter + accessories

KT15686 Mucopren Soft silicon sealer - 1 x 50ml

KT15687 Mucopren Soft liner - 2 x 50ml

### UFI GEL® SC SOFT LINER

*Permanent soft, cold-curing relining material on silicone base*

#### Indications

- Permanent soft relining for total and partial dentures
  - to eliminate pressure spots
  - for cases of flabby ridges with insufficient retention
  - to cushion sharp-edged alveolar processes
  - to support the healing process in implantology

#### Advantages

- Biocompatible (methacrylate-free)
- Remains permanently soft
- Neutral odour and taste
- Special adhesive for extreme bonding of silicone to denture
- Stable, aesthetic colour with chameleon effect
- Labside use: fewer steps than with other cold-cured materials
- For all PMMA based dentures
- Easy and fast application of direct and indirect relining
- Excellent adaptation to fine details for a precise fit of the denture
- Resistant against standard denture cleansers

VO2041 Ufi Gel® SC soft liner set  
Set includes cartridge 50ml, adhesive bottle 10ml, glazing base 10ml, glazing catalyst 10ml + accessories

VO2040 Ufi Gel® SC soft liner cartridge 50ml + accessories

VO2029 Ufi Gel® SC soft liner adhesive - 10ml



### UFI GEL® HARD C LINER

*Hard direct denture relining*

#### Indications

- Hard, permanent total or partial relines to restore the functions of partial and total denture
- Lengthening of denture margins

#### Advantages

- Biocompatible (methacrylate-free)
- Neutral taste and odour
- As easy as taking an impression
- Aesthetic, high patient acceptance and comfort
- Smooth surface
- New layers can be added at any time

VO2215 Ufi Gel® hard C cartridge set

Set includes cartridge 80g, adhesive bottle 10ml + accessories

VO2216 Ufi Gel® hard C cartridge 80g + accessories

VO2217 Ufi Gel® hard C adhesive - 10ml



## BASE PLATES

### CAVEX BASE PLATES

- Simple technique
- Rapid processing, due to short heating time
- Shape-retaining, does not distort at mouth temperature
- Strong and dimensionally stable
- Standard thickness
- Economical

#### Advantages of Mica-free

- Reduced risk of burning
- Improved end result
  - smoother surface
  - shiny
  - less porous due to homogenous compounds

Supplied as a packet of 100

CABASEU Cavex Baseplates - upper

CABASEL Cavex Baseplates - lower



## DENTURE BRUSHES

### DENTURE BRUSHES

*This well proven denture brush is totally manufactured in New Zealand*

The Luxident twin tuft denture brush is a well proven, effective design for cleaning partial and full dentures, with two brush heads for more efficient cleaning. It is ergonomically styled with elegance, providing a strong and comfortable non-slip handle, which can be easily gripped by those with arthritic hands.

- Available in pastel or bright colours, with soft or medium bristles
- Supplied as a packet of 12 individually packaged denture brushes

LU491 Denture brushes - soft, pastel colours

LU413 Denture brushes - medium, pastel colours

LU413B Denture brushes - medium, bright colours

*Personalised denture brushes are also available (minimum quantities apply) - please ask your Oraltec representative for more information*



# Denture Products

## DENTURE ACCESSORIES

### ATLAS FLASKS

- Constructed of special alloy bronze
- Fitted with hardened stainless steel alloy rear tapered guide pins
- Glass-like smooth surfaces
- Lower flask is constructed with a slanted heel section to accommodate cases with high condyles



HN44L Atlas flask - lower  
HN44U Atlas flask - upper

**HANDLER**

### FLASK CLAMPS

- For use when curing two flasks simultaneously
- Sturdily built of bronze alloy
- Rustproof cast body
- Allen wrench, wood capped holding handle and brass lifting handle are supplied with each compress



HN61B Two flask clamp 61B

### APEX ARTICULATOR

- Constructed of bronze castings
- Centre support for durability and better plaster retention



HN72 Apex articulator

### RELINING JIG

- Fast relining jig
- For a fast relining of partial and complete dentures, used for each polymerisation device



DF81010 Okklamat fast relining jig

**HANDLER**

### BENCH PRESS

- Made from 1" steel plate
- Used for trial packing dentures
- Threaded centre screw and insert replaceable if needed



HN39 Bench press

**HANDLER**

## DENTURE EQUIPMENT

Please refer to LABORATORY PRODUCTS, pages 94-95, for more information on denture equipment

## ACRYLIC POLISHERS

Please refer to LABORATORY PRODUCTS, page 92, to see the range of acrylic polishers and burs

## POLISHING PASTES

### POLISHING PASTE

*Universal high shine blue polishing paste for acrylic, gold, composites and chrome cobalt*



KE24401 Hi-Shine polish stick - 75ml

**KENDA**  
DENTAL POLISHES

### DIA GLACE

*A polishing medium to obtain perfect surfaces of ceramic restorations*

- High diamond content
- High gloss within a few seconds at a speed of 7500 r/min
- Economical
- Hard consistency with a very small quantity needed
- No wasted material

Dia Glace can also be used on composites, veneer plastics and alloys.



YE3000000 Dia Glace - 5g

**YEMMI**  
DENTAL

## PLASTER SOLVENT

### PLASTER SAFE

*Plaster solvent and tray cleaner*

- Ready-to-use economic solution to aid the safe removal of dental plaster and stone from the fitted surface of a denture
- A water-based solution with no harmful chemicals
- Easy to use - remove any excess plaster from the denture then immerse in Plaster Safe for as long as required
- Can be used in an ultrasonic cleaner

Supplied as 1 litre bottle



ASLAB906 Plaster Safe solvent

**kemdent**  
Quality and Reliability

## PUMICE CLEANER

### PUMICE SAFE

*Universal cleaner*

- Use in a pumice tray instead of water to produce a minty fragranced microorganism free slurry
- Use as a soak for lathe brushes to reduce the risk of burning the acrylic during polishing
- As the liquid becomes contaminated, it changes colour from pale blue to dark green and the solution should be changed
- Alcohol-free with a glycerine and emollient content
- Non irritant

Supplied as 500ml spray bottle



ASSUN268 Pumice Safe universal cleaner

**kemdent**  
Quality and Reliability

## SPECIAL TRAY MATERIAL

Please refer to IMPRESSION MATERIALS, page 63, to see the range of special tray materials available



# Digital Dentistry

## CERAMIC MATERIALS

### CERAMILL ZOLID FX MULTILAYER

- Extra-high translucent zirconia blank with graduated shading, dental arch shape
- High strength of 700 Mpa
- All 16 VITA shades can be covered with only 10 blanks



AM761734	Ceramill Zolid FX multilayer O/A1 71 (16mm)
AM761738	Ceramill Zolid FX multilayer A2/A3 71 (16mm)
AM761739	Ceramill Zolid FX multilayer A2/A3 71L (20mm)
AM761742	Ceramill Zolid FX multilayer A3.5/A4 71 (16mm)
AM761746	Ceramill Zolid FX multilayer O/B1 71 (16mm)
AM761750	Ceramill Zolid FX multilayer B2/B3 71 (16mm)
AM761758	Ceramill Zolid FX multilayer C1/C2 71 (16mm)
AM761766	Ceramill Zolid FX multilayer D2/D3 71 (16mm)

### CERAMILL ZOLID FX CLASSIC

- Extra high translucency zirconia blank, dental arch shape

AM760123	Ceramill Zolid FX 71S (14mm)
AM760124	Ceramill Zolid FX 71 (16mm)
AM760125	Ceramill Zolid FX 71M (18mm)
AM760126	Ceramill Zolid FX 71L (20mm)
AM760127	Ceramill Zolid FX 71XL (25mm)



### CERAMILL ZOLID CLASSIC

- High translucency zirconium-oxide blank, dental arch shape

AM760162	Ceramill Zolid Classic 71XS (12mm)
AM760163	Ceramill Zolid Classic 71S (14mm)
AM760164	Ceramill Zolid Classic 71 (16mm)
AM760165	Ceramill Zolid Classic 71M (18mm)
AM760166	Ceramill Zolid Classic 71L (20mm)
AM760167	Ceramill Zolid Classic 71XL (25mm)



### CERAMILL ZOLID PRESHADE (PS)

- Preshaded high translucency zirconium oxide blanks, dental arch shape

AM760344	Ceramill Zolid 71 (16mm)
AM760345	Ceramill Zolid 71L (20mm)



## HYBRID CERAMIC MATERIALS

### VITA ENAMIC for Ceramill Motion 2

*For crowns, crowns on implants, inlays/onlays and veneers*

- Supplied as a packet of 5

AM761215	Vita Enamic, EM-14, 3M2-HT
AM761213	Vita Enamic EM-14 1M2-HT
AM761214	Vita Enamic EM-14 2M2-HT



### LAVA™ ULTIMATE restoration material for Ceramill Motion 2

*For inlays/onlays and veneers*

- Supplied as a packet of 5

AM761303	Lava™ Ultimate, 14L, A2-LT
AM761307	Lava™ Ultimate 14L, C2-LT
AM761312	Lava™ Ultimate HT block A3



## ACRYLIC MATERIALS

### CERAMILL PEEK

- High-performance polymer, dental arch shape

AM760390	Ceramill PEEK 71XS (13mm)
AM760392	Ceramill PEEK 71L (20mm)



### CERAMILL PPMA

- Acrylic which burns out without residue, dental arch shape

AM760303	Ceramill PPMA 71L (20mm)
----------	--------------------------



### CERAMILL TEMP

- Dyed PMMA, dental arch shape

AM760324	Ceramill TEMP middle 71L (20mm)
----------	---------------------------------



### CERAMILL TEMP MULTILAYER

- Shaded PMMA with colour gradient, dental arch shape

AM760380	Ceramill TEMP multilayer A1/A2 XS (13mm)
AM760381	Ceramill TEMP multilayer A3 71XS (13mm)
AM760384	Ceramill TEMP multilayer A1/A2 71L (20mm)



### CERAMILL SPLINTEC

- Splints-acrylic, PMMA, MPG Class 2a, dental arch shape

AM760396	Ceramill Splintec Standard 71L (20mm)
----------	---------------------------------------



### CERAMILL M-PLAST

- Model resin, dental arch shape

AM760519	Ceramill M-Plast 71 (30mm)
----------	----------------------------



## CAD / CAM WAXES

### CERAMILL MILLING WAX

*Milling wax that burns out without residue ensuring perfect casting results*



- Homogeneous preshaded blanks ensure shade stability
- Easy, reproducible CAD/CAM-controlled fabrication of wax patterns facilitate the casting and press techniques
- Virtually no cutter wear or clogging of the cutter by wax

AM760307	Ceramill Wax 13mm D block
AM760302	Ceramill Wax 20mm D block



### CAD/CAM SCAN WAX

*Laser-opaque and light-opaque sculpturing wax for CAD/CAM technique*

- Size 98.5mm diameter
- Highly opaque wax for optimal scan data
- Excellent as block out wax
- Superb modelling qualities
- Supplied as a 45g tin



YE7295000	CAD/CAM scan wax, beige
-----------	-------------------------



# Digital Dentistry

## CAD/CAM WAX BLANKS

- Size 98.5mm diameter
- Homogenous surfaces - mirror smooth milled surfaces
- Produced from residue-free, temperature stable and investment compatible micro-waxes



### Green, elastic (hardness 1) - model casting

- Sold individually

YE7950020	CAD/CAM wax, green 20mm disc
YE7950025	CAD/CAM wax, green 25mm disc
YE7950030	CAD/CAM wax, green 30mm disc



## CERAMILL COLOURING LIQUIDS

### CERAMILL LIQUID for Ceramill Zolid Classics

- Colouring solutions
- Available in 12 shades - A1, A2, A3, A3.5, A4, B1, B2, B3, C1, C2, C4, D3
- Supplied as a 100ml bottle



AM760\_ Ceramill liquid - specify shade

### CERAMILL FX LIQUID

- Colouring liquids
- Available in 10 shades - A1, A2, A3, A3.5, B1, B2, B3, C3, D2, D3
- Supplied as a 100ml bottle



AM761\_ Ceramill liquid FX - specify shade

### Ceramill dimmer liquid thinner

- For use with Ceramill FX liquids
- Supplied as a 250ml bottle



AM760449 Ceramill dimmer liquid refill (thinner)

## IMPLANT COMPONENTS

All major implant company components are available for Ceramill - please ask for more information



## DIGITAL TEETH

Kulzer Pala Mix&Match for full dentures digital teeth are available for Ceramill - please ask for more information



## CERAMILL POLISHING PRODUCTS

### CERAMILL POLISHING KIT

*Zircon oxide-polishing set for the dental technician*

Comes complete with the following:

- AM875501 **1** PRE-Wheel medium (without mandrel) wheel, grain: medium, before sintering
- AM875502 **2** PRE-Cone medium cone, grain: medium, before sintering
- AM875503 **3** PRE-Wheel fine (without mandrel) cone, grain: fine, before sintering
- AM875504 **4** PRE-Cone fine cone, grain: fine, before sintering
- AM875505 **5** POST-Disc medium disc, grain: medium, before sintering
- AM875506 **6** POST-Wheel medium wheel, grain: medium, before sintering
- AM875507 **7** POST-Disc fine disc, grain: fine, before sintering
- AM875508 **8** POST-Wheel fine wheel, grain: fine, before sintering

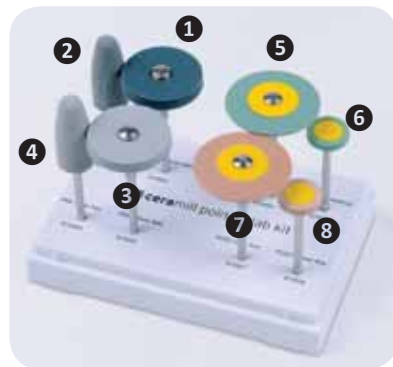

AM875500 Ceramill polish - lab kit

## CERAMILL BURS AND TRIMMERS

### CERAMILL ROTO BURS

*Cutter for wet and dry processing*

- Each with magnet holder
- Sold individually



AM760604	Ceramill Roto bur 1.0 - ø 1.0mm
AM760605	Ceramill Roto bur 2.5 - ø 2.5mm
AM760606	Ceramill Roto bur 0.6 - ø 0.6mm
AM760607	Ceramill Roto bur 0.3 - ø 0.3mm



### CERAMILL DIAMANT TRIMMERS

*Diamond rotary instrument for wet processing of glass and hybrid ceramics*

- Each trimmer with magnet holder
- Sold individually



AM760627	Ceramill Motion 2 Diamant 0.4 - ø 0.4mm
AM760624	Ceramill Motion 2 Diamant 1.0 - ø 1.0mm
AM760625	Ceramill Motion 2 Diamant 1.4 - ø 1.4mm
AM760626	Ceramill Motion 2 Diamant 1.8 - ø 1.8mm

# Digital Dentistry

## CLINICAL DIGITAL IMPRESSION SCANNER

### CS 3600 INTRAORAL 3D SCANNER

*Seamless integration with CAD CAM systems, including Ceramill... and with no license fees*

The Carestream CS 3600 intraoral scanner makes digital impression capture fast and easy.

It is ideal for capturing images and sending files to your digital laboratory for crowns and bridges.

The Carestream CS 3600 produces highly accurate full HD 3D colour images with enhanced quality and texture which facilitates dentist/patient communication and increases case acceptance.

CS3600 Carestream intraoral CS 3600 3D scanner



For more information on the CS 3600 intraoral 3D scanner, please refer to IMPRESSION MATERIALS, page 54

## LABORATORY DIGITAL SCANNERS

### CERAMILL MAP 400

*The "functional scanner" with Splitex integration*

Fast and precise, high resolution scanning data – these are all features of the fully automated stripe light Ceramill Map400 scanner with its high-sensitivity 3D sensors and a sophisticated and newly developed "DNA Speed Scanning" strategy. It reduces scanning times by up to 50% whilst retaining consistent precision. As a result, a full jaw scan with results for unlimited use is possible in only 24 seconds.

Ceramill Map400 generates open stl files.

#### Benefits

- Full jaw scan with results for unlimited use in only 24 seconds due to DNA Speed Scanning
- High precision digitisation of models with jaw relation
- Versatile use (e.g. impression scan triple tray and full arch, models, multi die, all-in, colour texture scans)
- Universal-carrier plate allows flexible scanning of numerous different model systems
- Individually adaptable scanning sequence

### CERAMILL TRANSFER KIT FIXATOR

*1:1 Transfer of patient data into the Ceramill Map400*

To make use of the functionality of the virtual articulator, it is essential to transfer the model situation from the "actual articulator" 1:1 to the scanner. The Ceramill System provides for this with the Ceramill Fixator – a combination of transfer jig and model holder, based on the Splitex®, used for holding the model in the scanner. The Ceramill Fixator enables the model to be transferred to the scanner while retaining the axis relationship of the "real articulator".

The Ceramill Fixator is specially calibrated for the Ceramill Map400 Scanner with Splitex® holder to ensure maximum precision when digitalising the model situation.

#### Benefits

- Transferring the articulated situation in Ceramill Fixator without loss of precision
- Maximum precision due to patient analogues working
- Scanning in Splitex precision with exact patient data

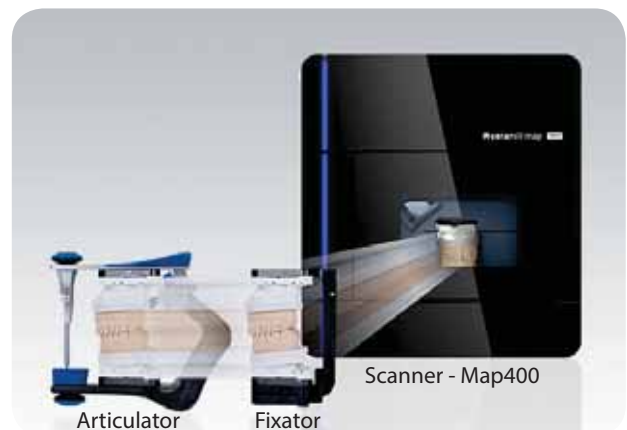

  
AMANNGIRSBACH

# Digital Dentistry

## DESIGN (CAD)

### CERAMILL MIND

*The intelligent design software*



The Ceramill Mind design software is developed in close collaboration with dental technicians.

The Ceramill Map400 Scanner and the Ceramill Mind integrate seamlessly into the architecture of the Ceramill system, resulting in ease of operation, process reliability and precision.

The user interface of the CAD programme, which is orientated to the conventional laboratory workflow, considerably simplifies the framework fabrication process and covers a comprehensive range of indications from crowns, bridge, inlays/onlays and telescope crowns to customised abutments.

#### Benefits

- Simultaneous designing in the upper and lower jaw
- Library teeth automatically adapt to the scanned diagnostic model
- Automatic defining of the preparation margins
- Intuitive work-flow for comfortable and reliable use
- The order button integrated in the programme makes sending the construction data simple
- Open for every type of construction data (File type: stl), increases flexibility



#### Indication spectrum

- Fully anatomical and anatomically reduced crowns and bridges
- Inlays/Onlays
- Veneers
- Reducing wax-ups
- Telescopes Individual abutments (Upgrade Ceramill M-Plant module)
- Multi-unit, screw-retained bridges (Upgrade Ceramill M-Plant module)
- Attachment Bars (Upgrade Ceramill M-Bars module)
- Splints (Upgrade Ceramill M-Splint module)
- Provisional shell restorations (Upgrade Ceramill Microshell module)

*Comes complete with PC including monitor, keyboard and mouse*

### CERAMILL MATCH

*Inhouse milling with premium performance, usability and precision*

The automatic and transparent user interface of the Ceramill Match 2 CAM software form the basis for a reliable and easy operation.



No CAM or milling know-how is required to use it. Even users with little experience may quickly and easily establish the milling programmes to manufacture crown and bridge frameworks.

- Quick and practical nesting of the design in the blank
- Simplified handling with a focus on the essential elements for use in the dental laboratory
- Easy positioning and alignment of designs in the blank
- Easy adjustment of the position, size and alignment of connectors
- Nesting for different shapes of blank
- Quick calculation of the milling path
- Quick milling times for excellent surface quality of the milling result

 **ceramill**®

  
**AMANNGIRRBACH**



DNA GENERATION.

POWER + DENTAL TECHNOLOGY INTELLIGENCE = PERFORMANCE

# Digital Dentistry

## MILLING (CAM)

### CERAMILL MIKRO 4X

*4-axis dry unit - easy entry or efficient upgrading*

- Low investment costs with high amortisation rate
- Versatile thanks to dry processing, also including hybrid ceramics
- High performance components and extremely robust design ensure permanently high milling results



### CERAMILL MIKRO IC

*4-axis wet processing with speed-grinding function*

- Carving mode grinding technique - for up to 60% time saving when processing glass/hybrid ceramic
- Intelligent machine design with powerful super-high-frequency spindle for maximum speed with the highest precision
- Special holder design for easy handling and highest degree of accuracy when processing hard materials



### CERAMILL MIKRO 5X

*5-axis dry milling in minimum space*

- Maximum range of indication in the 5-axis dry milling sector
- Speedy, efficient due to dental-optimised control and milling strategies
- Monocoque design guarantees absolute stability and low-vibration processing



### CERAMILL MOTION 2 5X

*5-axis wet and dry processing - versatile and future-proof*

- Maximum range of materials and indications
- Innovative processing procedures for maximum ROI (rotational milling of titanium, carving mode grinding technique, etc)
- Intelligent machine design with powerful super-high-frequency spindle for maximum speed with the highest precision
- Intelligent machine design guarantees optimum protection of all electronics components during wet processing



### CERAMILL AIRSTREAM

*Suction for Ceramill milling units*



### CERAMILL COOLSTREAM

*Integrated coolant preparation for wet milling*

- Comes complete with trolley (as pictured below)



AMANN GIRRBACH





# Digital Dentistry

## CERAMILL PACKAGES

Ceramill packages are tailored to suit user needs. Please contact us for more information.



AMANNGIRSBACH



## AIR COMPRESSORS

### COMPRESSORS

*Cattani - a compressor for every situation*

With an extensive range Cattani have the right size compressor for virtually every clinic and laboratory milling system

- Superior performance
- 5 year warranty
- Low maintenance
- Extensive range
- Available with optional acoustic hood which lowers the noise level



Model	No of Surgeries	Performance	Tank Size
K100	1	67 N l/min	25 litre
K200	2-3	160 N l/min	50 litre
K300	3-4	238 N l/min	75 litre
K400	5-6	320 N l/min	100 litre



CTK\_ Cattani compressor

Contact **Oraltec** for all your dental supply requirements

Proud to be New Zealand owned and operated



## SINTERING

### CERAMILL THERM S FURNACE

*The speed sinter furnace for greater flexibility in everyday laboratory routines*

The Ceramill Therm S provides laboratories with a new level of flexibility. In addition to the option of sintering single tooth restorations in only two hours, the compact and energy-efficient furnace offers a superior spectrum of use. It is able to sinter up to 6-pontic restorations and glaze firing is not a problem for the agile device.

Furthermore, the Therm S sets new benchmarks in terms of user friendliness. In addition to a 10.4" touch display and an intuitive user interface, the furnace can be connected directly to the internet via a network interface, making tedious updates and protocol archiving a thing of the past. This and other service and remote functions can be managed directly and conveniently via an internet database.

#### Benefits

- More flexibility in everyday laboratory routines with a 2-hour speed sintering programme for single tooth restorations
- Greatest possible user versatility through Autodry® drying function, sintering mode for up to 6-pontic restorations and glaze firing mode
- Easy handling via 10.4" touch display and internet connection for programmes and protocols



*Ceramill Therm S sintering furnace comes complete with sintering bowl, Therm S tongs and sintering pearls 200g (ø 1mm)*



Also available

### ARGOTHERM 2 FURNACE

*Shielding gas sinter furnace and flood chamber for Ceramill Sintron*



For more information on the Argotherm 2 furnace, please contact us.



AMANNGIRSBACH

# Endodontic Products

## RUBBER DAM PRODUCTS

### IVORY RUBBER DAM CLAMPS

Kulzer manufactures many Ivory rubber dam clamps to meet the most demanding situations.

Tooth	Clamp
1	4, 5, 8, 8A, 12A, 14, 26N
2	4, 5, 8, 8A, 12A, 14, 26N
3	4, 5, 8, 8A, 12A, 14, 14A, 26N, 56
4	0, 1, 1A, 2A, 27N
5	0, 1, 1A, 2A, 27N
6	6, 9, 212, 212SA
7	6, 9, 212, 212SA
8	6, 9, 212, 212SA
9	6, 9, 212, 212SA
10	6, 9, 212, 212SA
11	6, 9, 212, 212SA
12	0, 1, 1A, 2A, 27N
13	0, 1, 1A, 2A, 27N
14	4, 5, 8, 8A, 13A, 14, 14A, 26N
15	4, 5, 8, 8A, 13A, 14, 14A, 26N
16	4, 5, 8, 8A, 12A, 14, W14, 14A, 26N, 56
17	3, 7, 7A, 8A, 12A, 14, 14A, 27, 56
18	3, 7, 7A, 8A, 12A, 14, 14A, 27, 56
19	3, 7, 7A, 8A, 12A, 14, 14A, 27, 56
20	0, 1A, 2, 2A, 6, 27N
21	0, 1A, 2, 2A, 6, 27N
22	00, 6, 9, 212, 212SA
23	00, 6, 9, 212, 212SA
24	00, 6, 9, 212, 212SA
25	00, 6, 9, 212, 212SA
26	00, 6, 9, 212, 212SA
27	00, 6, 9, 212, 212SA
28	0, 1A, 2, 2A, 6, 27N
29	0, 1A, 2, 2A, 6, 27N
30	3, 7, 7A, 8A, 12, 12A, 14, 14A, 27, 56
31	3, 7, 7A, 8A, 12, 12A, 14, 14A, 27, 56
32	3, 7, 7A, 8A, 14, 14A, 27, 56

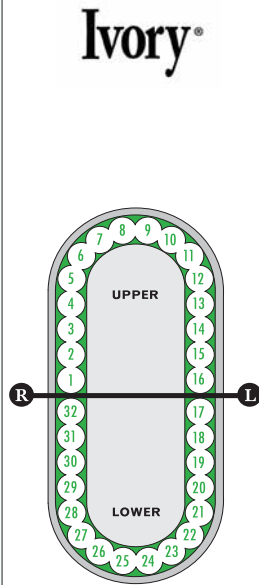

### Molar Clamps

<b>3°</b> SHINY MATTE For small lowers. Narrow, flat jaws so as not to impinge in tissue. Also available wingless - W3	
<b>4°</b> SHINY MATTE For small uppers. Narrow jaws designed to fit necks of round-shaped teeth. Also available wingless - W4	
<b>5°</b> SHINY For large uppers. Jaws conform to curvature at gum line. Also available wingless - W5	
<b>7°</b> SHINY MATTE General purpose lower. Medium-sized bow and jaws. Flat jaws. For teeth which tend to be square in form. Also available wingless - W7	
<b>7A</b> SHINY For large lowers. Same as #7 only larger. Large bow, broad jaws.	
<b>8°</b> SHINY MATTE General purpose upper. For round upper teeth. Jaws fit curvature at gum line to prevent rotating. Also available wingless - W8	
<b>8A°</b> SHINY MATTE For upper, lower molar roots. 4-point jaws grasp root at corners. Jaws set dam beneath gum line when released. Also available wingless - W8A	
<b>10</b> SHINY For small molars with short crowns. Buccal jaw broader than lingual (10=right, 11=left).	
<b>11</b> SHINY For small molars with short crowns. Buccal jaw broader than lingual (10=right, 11=left).	
<b>12A</b> SHINY MATTE For all lowers, particularly third molars and partially erupted teeth. Available with serrated jaws only (12A=right, 13A=left).	
<b>13A</b> SHINY MATTE For all lowers, particularly third molars and partially erupted teeth. Available with serrated jaws only (12A=right, 13A=left).	
<b>14°</b> SHINY MATTE For partially erupted, undersized, round teeth or for teeth sloping from gum line. Small bow. Also available wingless - W14	
<b>14A°</b> SHINY MATTE Same as #14, only larger in every way. Also available wingless - W14A	
<b>26</b> SHINY For small lower molars.	
<b>26N*</b> SHINY MATTE Universal upper with festooned jaws. Available wingless only	
<b>27</b> SHINY For large molar distal cavities.	
<b>28N*</b> SHINY General purpose lower molar clamp. Available wingless only	
<b>56°</b> SHINY MATTE For all large molars. Also available wingless - W56 56 and W56 are SHINY, 56T is MATTE	

### Labial Clamps

<b>6</b> SHINY For labial cavities on centrals and cuspids. For second bicuspid and second upper molars.	
<b>9T</b> SHINY MATTE For labial cavities on all anterior teeth.	

### Bicuspid Clamps

<b>0°</b> SHINY MATTE For teeth that are elongated or have small necks. High bow, small jaws. Also available wingless - W0	
<b>00</b> SHINY MATTE For small lower anteriors and teeth set irregularly in arch. High bow, narrow jaws.	
<b>1°</b> SHINY MATTE General purpose upper. Jaws fit curvature at gum line. Also available wingless - W1	
<b>2°</b> SHINY MATTE General purpose lower. Same as #1 only jaws are flat so as not to impinge on tissue. Also available wingless - W2	
<b>2A°</b> SHINY MATTE For bicuspid with large necks. Broad jaws Also available wingless - W2A	
<b>27N*</b> SHINY Universal bicuspid clamp. Jaws conform to curvature at gum line. Available wingless only	

- \* Available wingless only
- Also available wingless
- T Also available with serrated jaws (Tiger clamps)
- A Slightly larger
- N No wing

Ivory®

# Endodontic Products

## KERR SOFTCLAMP

*Universal rubber dam clamp*

The Kerr SoftClamp design distributes the force of the clamp evenly, reducing the pressure on the contact area. The SoftClamp engages the tooth surface gently but firmly, minimising the risk of slippage.

- Secure - provides solid retention
- Safe - no sharp edges
- Versatile - stable fit for varying molar tooth anatomies and sizes
- Compatible - accommodates all types of rubber dam forceps
- Satin beige colour - minimises light reflection
- Autoclavable - suitable for multiple use
- Radiopaque

**Kerr**

Supplied as a packet of 5

KR5250 SoftClamp



## RUBBER DAM COMPLETE KIT

Complete kit includes

- 1 each of clamp 0, 2, 2A, 7, 8A, 9, 14, 14A (Starter Kit)
- 1 box 6 x 6 blue rubber dam (packet of 36)
- 1 only 6 x 6 marking template
- 1 x dam frame
- 1 x clamp forceps
- 1 x dam punch



IVCOMPLETE

Rubber dam complete kit

## RUBBER DAM STARTER KIT

*Offers a selection of the most widely used clamps to fulfil most needs*

Starter kit includes 1 each of clamps 0, 2, 2A, 7, 8A, 9, 14, 14A

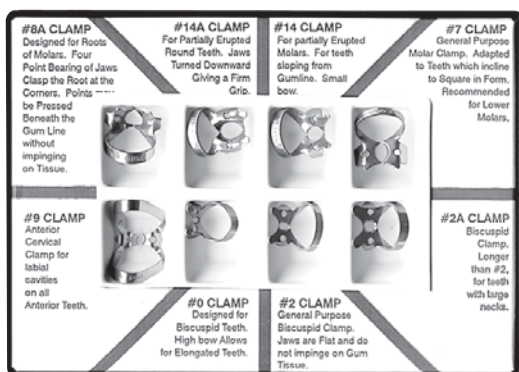

IVSTARTER Rubber dam starter kit

## PETROLEUM JELLY

- For gingival protection
- Supplied as a 500g jar

MUJEL500 Petroleum jelly



## IVORY RUBBER DAM

*Made from natural latex, Ivory Dam has extremely high tear strength, is thin and pliable*

**Ivory**



- Each supplied as packet of 36 precut sheets

IVDAMBLUE5	5" x 5" (for children) - blue
IVDAMBLUE6	6" x 6" (for adults) - blue
IVDAMGREE5	5" x 5" (for children) - green
IVDAMGREE6	6" x 6" (for adults) - green

## IVORY RUBBER DAM PUNCH

This precision instrument is made from high quality stainless steel.

The unique floating plunger strikes all edges of the cutting disc evenly, guaranteeing a perfect, tear-resistant hole every time.

The cutting disc rotates through a range of 6 hole sizes, providing the correct opening for the smallest anterior tooth to the largest molar.

IVPUNCH Rubber dam punch



## IVORY RUBBER DAM FORCEPS

The Ivory forceps are made from high grade stainless steel to ensure many years of use.

The forceps will reach around the bow of any clamp without tilting, which is especially important when reversing a clamp.

The straight head design allows easy gripping and placement of any clamp size.

IVFORCEP Rubber dam forceps



## METAL RUBBER DAM FRAMES

IVFRAMEC 5" x 5" (child)  
IVFRAMEA 6" x 6" (adult)

**Ivory**



## PLASTIC RUBBER DAM FRAME

SVED0200  
Plastic rubber dam frame (adult)

**SVENSKA DENTORAMA AB**



# Endodontic Products

## HAND FILES

### THOMAS K-FILES

- Made from high grade stainless steel
- ISO colour coded handle
- 21mm, 25mm, 28mm or 31mm
- Sizes 08 to 140 and in assorted pack sizes of 15-40, 45-80, 90-140

THK\_ Thomas K-files - packet of 6



### KERR K-FILES

*Stainless steel endo handfile*

The strongest of the hand files bypassing obstructions with far greater ease, K-files for endodontics are produced to give the operator a smooth tactile sense inside the canal during instrumentation.

- Available in 21mm, 25mm and 30mm lengths
- Sizes 6 to 80 and assorted packs

KR60\_ Kerr K-files - packet of 6



### KERR K-FLEX FILES

*Stainless steel endo handfile*

Kerr K-Flex stainless steel hand files are more flexible than conventional endo files of comparable size, particularly in sizes #30 and above, which facilitates the negotiation of curved canals and their preparation with minimal potential for ledging and perforating.

- Available in 21mm, 25mm and 30mm lengths
- Sizes 6 to 80 and assorted packs

KR15\_ Kerr K-Flex files - packet of 6



### LM ENDO-MAX K-FILES

*LM Endo K-files with large, ergonomic, comfortable handles*

LM K-files have an extremely flexible triangular profile blade. The larger cutting angle enhances instrument use compared to a similar square profile instrument. Preparation waste can also be removed from the canal more easily, because there is more room in the instrument threads.

- 21mm or 25mm
- Sizes 006, 008, 010, 015, 020, 025, 030, 035, 040, 045, 050, 055, 060, 070, 080
- Also available in assorted pack sizes 015 - 040 and 045 - 080



LMK21\_ LM Endo-Max K-files - 21mm - packet of 6

LMK25\_ LM Endo-Max K-files - 25mm - packet of 6

### THOMAS HEDSTROM FILES

- Made from high grade stainless steel
- ISO colour coded handle
- 21mm, 25mm, 28mm or 31mm
- Sizes 08 - 140 and in assorted pack sizes of 15-40, 45-80, 90-140

THH\_ Thomas Hedstrom files - packet of 6



### KERR HEDSTROM FILES

*Stainless steel endo handfile*

Kerr Hedstrom files are ground from stainless steel wire. The flute depth increases with the taper, creating a sharper, more flexible instrument.

- Available in 21mm, 25mm and 30mm lengths
- Sizes 15 to 80 and assorted packs

KR60\_ Kerr Hedstrom files - packet of 6



### LM ENDO-MAX HEDSTROM FILES

*LM Endo-Max H-files with large, ergonomic, comfortable handles*

The blade on LM-Hedstrom files is milled instead of threaded like on other root canal instruments. Especially well suited to procedures where space is made for the root canal orifice (coronal flare). Hedstrom files are only intended for use with filing, back-and-forth preparation motions.

- 25mm
- Sizes 008, 010, 015, 020, 025, 030, 035, 040, 045, 050, 055, 060, 070, 080
- Also available in assorted pack sizes 015 - 040 and 045 - 080



LMH25\_ LM Hedstrom files - 25mm - packet of 6

### THOMAS CANAL PROBES

- A special type of K-file - size 12
- Minimal taper helps to perform intermediate steps in calcified or curved canals
- Available in lengths 21mm and 25mm - ISO size 12

THCANAL\_ Canal probes - packet of 6



### KERR PATHFINDER FILES

*Stainless steel endo handfile*

Stainless steel endo handfiles, Pathfinder instruments feature a minimal taper and are used for negotiating difficult or calcified canals.

- Available in 21mm and 25mm

KR170\_ Kerr Pathfinder SS files - packet of 6



### KERR PATHFINDER™ CS FILES

*Carbon steel endo handfile*

Pathfinder instruments feature the same minimal taper as stainless steel Pathfinders but are made with carbon steel to help negotiate difficult or calcified canals faster and more efficiently.

- Available in 21mm and 25mm
- Available in taper sizes K1 (approx size #7, brown tip) and K2 (approx size #9, orange tip)

KR234\_ Kerr Pathfinder CS files - packet of 6



## ENDODONTIC STOPPERS

### ENDODONTIC STOPPERS

- Supplied as a packet of 60

THSTOPPER Black stoppers 4mm



# Endodontic Products

## ROTARY NITI FILES

### K3 NITI ENDO FILES

#### NiTi Endo Files

Kerr K3 is a third-generation, triple, fluted, asymmetric endodontic file system

- Available in 21mm, 25mm and 30mm lengths
- Available in taper sizes 0.04 and 0.06
- Also available in assorted pack sizes 15 - 40

KR825\_ K3 NiTi endo files - packet of 6



**Kerr**

### KERR TF FILES

#### NiTi Endo Twisted Files

The Twisted File combines three unique and proprietary processes to deliver optimal strength and flexibility:

- **R-phase™ heat treatment technology**

This patented technology optimises the molecular phase and properties of nickel titanium (NiTi). R-Phase increases file flexibility and resistance to cyclic fatigue.

- **Twisted design, not ground**

Twisting helps preserve grain structure and reduces formation of microfractures, making the file even more durable.

- **Strength and flexibility that can be measured**

Twisted files can withstand approximately 60% more torque than files made using a traditional manufacturing process.

Supplied as a packet of 3 in various sizes, including assorted packs Available in lengths 23mm and 27mm

KR822\_ Kerr Twisted Files - packet of 3



**Kerr**

### KERR TF ADAPTIVE (TFA) FILES

*TF Adaptive is the innovative endodontic file system combining the intelligence of the Elements Motor with the flexibility of the NiTi Twisted Files*

#### Elements Motor

- Better resistance to cyclic fatigue
- No need to switch between programmes

#### NiTi Twisted Files

- Better stress absorption
- Greater range of elasticity

#### The System

- Reduced risk of file breakages
- Superior strength and higher durability



For more information on the Elements Motor, please refer to pg 42

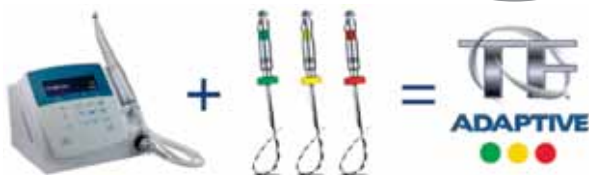

- Supplied as a packet of 4
- Available in lengths 23mm and 27mm
- Available in small (SM) and medium/large (ML)

KR817\_ Kerr TFA NiTi files - specify size

**Kerr**

## REAMERS & GATES GLIDDEN

### REAMERS

- Made from high grade stainless steel
- Comfortable ISO colour coded handle
- 21mm, 25mm
- Sizes 08 to 140 and in assorted pack sizes of 15-40, 45-80, 90-140
- Size 28mm - available only in assorted pack sizes



**THOMAS**

THR\_ Reamer - packet of 6

### PEESO REAMERS

- Designed for mechanical preparation of root canals
- Made from high grade stainless steel
- Sizes 1 to 6 and as an assorted pack (one of each size)
- 32mm



THPEESO\_ Peeso Reamers - packet of 6

### LM ENDO-MAX REAMERS

*LM Endo reamers with large, ergonomic, comfortable handles*

LM-Reamers have loosely twisted and flexible triangular cross-section instrument blades. The instrument is primarily designed for the apical preparation of straight canals.

- 25mm
- Sizes 008, 010, 015, 020, 025, 030, 035, 040, 045, 050, 055, 060, 070, 080
- Also available in assorted pack sizes 015 - 040 and 045 - 080



LMR25\_ LM Reamers - 25mm - packet of 6

### GATES GLIDDEN DRILLS

- Made from high grade stainless steel
- Sizes 1- 6 and as an assorted pack (one of each size)
- 32mm



THGATE\_ Gates Glidden drills - packet of 6

## OTHER ENDODONTIC INSTRUMENTS

### PASTE FILLERS

- 21mm or 25mm
- Sizes 25, 30, 35, 40 and in assorted pack sizes 25 - 40

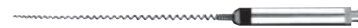

THP\_ Paste fillers - packet of 4

### FINGER SPREADERS

- 25mm
- Sizes 2 and 3 and in assorted pack size 1-6



THF25\_ Finger spreaders - packet of 6

### FINGER PLUGGERS

- 25mm
- Sizes 20, 30, 40, 60 and in assorted pack sizes 15 - 40 and 45 - 80



THPL25\_ Finger pluggers - packet of 6

### BARBED (NERVE) BROACHES

- 21mm or 25mm
- Sizes 20, 25, 30, 35, 40 and in assorted pack size 25-40



THBR\_ Barbed broaches - packet of 6

# Endodontic Products

## ENDODONTIC LUBRICANTS

### ENDO PREP EDTA

For facilitating access to root canals and lubricating instruments in endodontic therapy

- EDTA with added cetrime antimicrobial agent
- Available in gel or liquid solutions



PD33306



PD33326



PD33330

PD33306	EndoPrep solution 30ml
PD33326	EndoPrep solution 250ml
PD33330	EndoPrep Gel 2 x 3ml syringes



### SLICK GEL

Canal lubricant

SlickGel ES is a specially formulated canal lubrication used to aid in the negotiation of root canals by endodontic instruments.

Each MicroDose™ polytube contains EDTA that chelates calcifications in the root canal system.

- Supplied as a packet of 12 x 1ml polytubes

KR9731015 SlickGel

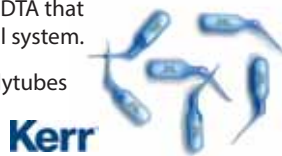

## ENDODONTIC IRRIGATION SYSTEM

### VIBRINGE ENDODONTIC SONIC SYRINGE

Active irrigation system for more effective endodontic treatments

The Vibringe device activates the irrigation solution through sonic vibrations.

- Easy to use - solution applied and activated in a single step
- Irrigates and activates - activated irrigation for more effective cleaning in one step
- Can be used with all solutions
- Suitable for use with all needles - compatible with all endodontic luer-lock needles
- Cleans better and faster (of necrotic tissue, debris and biofilm)
- Provides patient comfort (with the white LED light)
- Ergonomic design - lightweight, single button operation and cordless
- Prevents air entrapment
- Removes biofilm
- No sterilising required



CAVI001 Vibringe dock with inductive charging system  
CAVI011 Vibringe disposable syringes - packet of 50

## ENDODONTIC DRESSINGS

### LEDERMIX

Anti-inflammatory cortisone with an antibiotic for the rapid relief of pain caused by pulpitis

- Available as a paste which is an ideal root canal dressing
- Available as cement (powder and liquid hardener) for use for pulp capping

LE7698	Ledermix paste 5g
LE7699	Ledermix cement powder 3g
LE7694	Liquid hardener, fast set 2.5ml
LE7696	Liquid hardener, normal set 2.5ml



### CALCICUR

Ready-to-use calcium hydroxide paste



#### Indications

- Indirect capping
- Direct capping when the pulp is opened or a pulpotomy is performed
- Lining of cavities
- For temporary filling of root canals

#### Advantages

- Suitable for use under any lining or restorative material
- Immediately ready for use
- Antimicrobial effect due to high pH value (12.5)
- Calcium hydroxide content of 45 %
- Radiopaque
- Promotes the formation of tertiary dentine
- Effective pulp protection

Supplied as 1 x 2.5g syringe

VO1093 Calcicur syringe



## PAPER POINTS

### GAPADENT PAPER POINTS

Hand rolled paper points

- 34 points per vial (6 vials per box)
- Colour coded
- Sizes 08, 10, 15, 20, 25, 30, 35, 40, 45, 50, 55, 60, 70, 80, 90, 100, 110, 120, 130, 140
- Also available in assorted pack sizes of 15-40 and 45-80

GAPPV\_ Paper points



#### BULK RATE

Purchase 1 box (6 vials) of one size and receive 15% discount

### KERR PAPER POINTS

SybronEndo absorbent points are pre-sterilised and highly absorbent

SybronEndo absorbent points are sized to correspond with the dimensions of SybronEndo standardised endodontic instruments.

- Available in sizes 25 to 45
- Supplied as a box of 200

KR139\_ Kerr paper points - specify size



# Endodontic Products

## GUTTA PERCHA PRODUCTS

### GAPADENT GUTTA PERCHA POINTS

*Hand rolled gutta percha points*

- 20 points per vial (6 vials per box)
- Colour coded
- Sizes 08, 10, 15, 20, 25, 30, 35, 40, 45, 50, 55, 60, 70, 80, 90, 100, 110, 120, 130, 140
- Also available in assorted pack sizes of 15-40 and 45-80



GAGPV\_ Gutta percha points - specify size

#### BULK RATE

**Purchase 1 box (6 vials) of one size and receive 15% discount**

### GUTTA PERCHA ACCESSORY POINTS

*Hand rolled gutta percha cones*

- Sizes XF, FF, FM, F, MF, M, ML, L
- Supplied as a box of 100



GAGPT\_ Gutta percha accessory points

### GUTTA PERCHA POINTS TAPERED

*Hand rolled gutta percha points, greater taper*

- ISO sizes
- 0.04 taper
- Sizes 15, 20, 25, 30, 35, 40, 45, 50
- Supplied as a box of 60



GAGPT\_ Gutta percha points 0.04 tapered

### KERR TF ADAPTIVE (TFA) GUTTA-PERCHA POINTS

Kerr TFA gutta percha is made specifically for matching Kerr TFA files sizes and tapers with same colour coding.

- Supplied as a box of 50 points



- KR8151540 TFA GP points SM2 - small, yellow
- KR8151541 TFA GP points SM3 - small, red
- KR8151542 TFA GP points assorted - small, SM2, SM3
- KR8151543 TFA GP points ML1 - medium/large, green
- KR8151544 TFA GP points ML2 - medium/large, yellow
- KR8151545 TFA GP points ML3 - medium/large, red
- KR8151546 TFA GP points assorted - medium/large ML1, ML2, ML3

### KERR TF GUTTA PERCHA POINTS TAPERED

*TF gutta-percha points (pre-sterilised) are fabricated specifically for use with the TF rotating NiTi files*

- 50 points per box



- KR8220010 Size 25 - taper 0.04-0.12
- KR8220020 Sizes 30-50 - taper 0.04-0.06

### KERR GUTTA PERCHA DISPOSABLE CARTRIDGES

*Used in conjunction with ElementsFree Obturation units*

- Single-use cartridges with built-in finger grips
- Supplied as a packet of 10



See page 45 for details of sizes

## ENDODONTIC SEALANT

### SEALAPEX

*Non-eugenol, calcium hydroxide polymeric root canal sealant*

This formulation produces rapid healing and hard tissue formation

- Supplied as 12g base + 12g catalyst

KR18432 Sealapex



## ENDODONTIC APPLICATORS

### MICROBRUSH X EXTENDED REACH MICROBRUSHES

*Extra thin black applicators, ideal for confined spaces*

- Excellent for bonding posts
- With stiffer non-linting fibres
- Patented bending portion bendable up to 90°



Supplied as a packet of 100

HYPX100  
Microbrush X



Bonding posts



Inlay/Onlay  
Cementation



Perio/Subgingival



### ENDO TIM BLACK APPLICATORS

*Flexible, disposable applicators to be used in the root canal*

- Supplied as a packet of 50

VO2246 Endo tim applicators



## OTHER ENDODONTIC PRODUCTS

### COLD SPRAY

- Fastcold Plus is used to freeze cotton rolls or pellets for the purpose of thermo testing of tooth vitality
- Also suitable for the cooling of impression materials eg hydrocolloid, etc.
- Approximately -50°C at the application cannula (plastic)
- Non-toxic and CFC free
- Orange flavour

LASPRAYR22 Fastcold Plus - 200ml can



### ENDODONTIC NEEDLES AND SYRINGES

- Disposable luer lock syringes
- Each supplied as a packet of 10

- LAC84 2.5ml syringes
- LAR84 5ml syringes
- LAR82 Disposable 25g needles



#### BULK RATE

**Purchase any 10 packets and receive 15% discount**



### PDS ENDO PREP BLEACH POWDER

- For bleaching in endodontic therapy
- Fine sodium perborate powder
- Supplied as a 25g jar



PD34121 Endo Prep bleach powder





# Endodontic Products

## ENDODONTIC INSTRUMENTS

### ENDODONTIC EXPLORER

- Used to locate and enlarge the root canal orifice
- Shank angulations are ideal for anterior and posterior



LM2728\_ Root canal explorer

### ENDODONTIC EXCAVATOR

- Root canal excavators have longer lower shanks and sharper blade angles than round excavators



LM612622\_ Root canal excavator 1mm



LM632642\_ Root canal excavator 1.5mm



LM652662\_ Root canal excavator 2mm

### ENDODONTIC SPREADERS

- For the compacting of root canal filling materials during lateral condensation



LM24\_ Endodontic spreader 0.4mm



LM22\_ Endodontic spreader 0.23mm

### ENDODONTIC PLUGGER

- For the vertical plugging of root canal filling



LM4142\_ Endodontic plugger 0.5mm - 1.0mm

All of these LM instruments are available with either ErgoMax or ErgoSense handles - see pg 72 for further information on handle types

## ENDODONTIC CLEANERS

### ENDODONTIC INSTRUMENT CLEANER

- For cleaning endodontic instruments



- LAENDOQ62 Endodontic instrument cleaner - plastic  
 LAENDOQ25 Endodontic instrument cleaner - metal  
 LAENDOFR90 Endodontic clean sponges 0.5cm thick - packet of 50  
 LAENDOFR92 Endodontic clean sponges 1cm thick - packet of 25



## ENDODONTIC MEASURERS & BOXES

### ROUND ENDODONTIC INSTRUMENT MEASURER



LAENMEARD Endodontic instrument measurer

### RECTANGULAR ENDODONTIC INSTRUMENT MEASURER

Q14



LAENMEARE Endodontic instrument measurer

### ENDODONTIC BOX

- Endodontic instrument box with lid
- Available in large or mini



LAENDOBOX Mini box - Q15  
 LAENDOBQ4 Large box - Q4

## ENDODONTIC EQUIPMENT

### APEX ID LOCATOR

Digital Apex Locator



- Apex ID has been designed to work in almost any root canal condition
- Whether dry, wet, bleeding, filled with saline, EDTA, NaOCl, chlorhexidine, the Apex ID can still provide accurate, consistent and dependable readings
- Apex ID continuously calibrates for accurate, uninterrupted readings in real-time



KR9720090 Apex ID

### IPEX II

Advanced Apex Locator

- High-precision root canal measurement generated by using SmartLogic
- Auto-detects the apex accurately in any conditions, dry or wet
- A stylish and compact body requiring only a small space
- 3 different alert sounds depending on the location of the file tip, ensuring precise procedures
- A 3-colour LCD panel with very low reflectivity, allowing clinicians to accurately and instantly monitor procedure progress
- Energy saving and low operation cost



NKY1002208 iPex II complete set

Set includes control unit, iPex II probe (1.8m), iPex II file clip (3 pieces), lip hook (3 pieces), AAA manganese dry batteries (3 pieces) and iPex II tester

### VITALITY SCANNER™ 2006

Electronic Pulp Tester

- Dependable and pain-free pulp testing
- Automatically controlled
- Features large digital readouts

KR9730234  
 Vitality scanner  
 Model 2006



# Endodontic Products

## ELEMENTS™ MOTOR

### Endodontic Motor with Adaptive Motion

- The Elements Motor adapts the motion based on the amount of pressure on the file. It may or may not reciprocate and does not pull into the canal.
- Reciprocating angles may vary - no load 600° forward and 0° backwards, loaded 370° forward and up to 50° backwards, based on file load.
- 6 Presets - this motor provides recommended settings for TF Adaptive, K3/K3XF, TF, Lightspeed, M4 and custom settings
- 8:1 Contra Angle - smooth operation - handpieces are available in latch and push-button
- Fully autoclavable motor/cable - easily detaches from the console
- Intuitive user interface - with an easy to read LCD screen, the Elements Motor is easy to learn how to use



TF Adaptive starter kit



- KR8151500 Elements Motor with handpiece  
 KR8151532 Elements Motor with TF Adaptive starter kit  
 Kit includes Elements Motor with contra angle, 14 x assorted TFA files, 6 x K-files 25mm (2 each of #8, #10, #15) and 1 x LA Axxess 2.0 bur kit

## ELEMENTS™ FREE OBTURATION SYSTEM

### A System-Based Approach

Designed for use with the warm vertical condensation technique, the Elements™Free obturation system offers both downpack and backfill capabilities in a cordless design.

- Features a 360° one-touch activation ring to instantly heat the plugger and quickly cool upon deactivation
- Digital temperature control for procedural accuracy
- Downpack heats to 200°C in less than 0.5 seconds and with an adjustable heating range of 100 – 400°C
- Motorised extrusion for less hand fatigue
- Single-use cartridges with built-in finger grips for ease of use
- Element is insulated for safety

Gutta percha disposable refill cartridges available separately



Dual unit

Downpack unit

Backfill unit

- KR9730500 Elements Free dual unit system  
 KR9730502 Elements Free downpack with base  
 KR9730504 Elements Free backfill unit

## Accessories for ElementsFree Obturation units

### Buchanan Heat Pluggers

- Designed in shapes that closely match final root canal preparations



- KR9520004 Buchanan heat plugger, fine, 0.06 taper (red)  
 KR9520031 Buchanan heat plugger, extra-fine, 0.04 taper (green)

### Buchanan Hand Pluggers

- Feature tapered nickel-titanium and stainless steel tips (ends)
- The NiTi ends are colour coded for identification



- KR9740060 Buchanan hand plugger, size #0  
 KR9740058 Buchanan hand plugger, size #1  
 KR9740059 Buchanan hand plugger, size #2

Kerr

### Kerr Gutta Percha Disposable Refill Cartridges

- Single-use cartridges with built-in finger grips for ease of use
- Supplied as a packet of 10



- KR9721003 Elements GP cartridge 25 gauge (light body)  
 KR9721002 Elements GP cartridge 23 gauge (medium body)  
 KR9721005 Elements GP cartridge 23 gauge (heavy body)

## ENDOTOUCH TC2

### Cordless Endodontic Motor

Kerr

- The EndoTouch TC2 has a large LCD display, simple 5-key operation and a lightweight, ergonomic design to assure comfort and ease of use during even the most delicate endodontic procedures
- The auto reverse and alarm functions indicate the load is about to reach the preset torque level, allowing you to unload the file even before the auto reverse sets in
- With the new digital operating interface, changing settings on the TC2 is easier and intuitive



- KR8159140 EndoTouch TC2 Cordless Motor

## ENDO-MATE TC2

### Cordless endodontic handpiece with torque control and auto reverse

NSK

- Slim head and neck assures higher visibility
- Large LCD panel and access-friendly key
- Lightweight, ergonomic design
- Smart auto reverse and alarm function
- 5 programmes for different file systems
- Last programme settings can be memorised
- 90 minute quick charge with non-contact type charger



- NKY1001027 Endo-Mate TC2 complete set  
 Includes MP-F16R head, Endo-Mate TC2 motor and battery charger  
 NKY1001028 Endo-Mate TC2 complete MPA set  
 Includes MPA-F16R head, Endo-Mate TC2 motor and battery charger

**NEW** **elements<sup>TM</sup>free**  
OBTURATION SYSTEM

# It's time to cut the cord...

*“The downpack and backfill of the elementsfree equipment lost the cords but none of the System-B functionality,”*

Dr. Steve Buchanan



## *A System-based Approach:*

- Cordless emulation of the Elements Obturation Unit
  - same Continuous Wave downpack tips
  - same backfilling cartridges
  - same performance-without the cord!
- Sleek, coordinated look with ergonomic balance
- Intuitive user interface
- Lithium-ion batteries
- Smooth surface
- JumpStart feature

**Dentistry***unleashed*

Contact Oraltec Call Free 0508 478 222 to book your no obligation, in-surgery **elementsfree** demonstration.

As a special thank you, customers of Oraltec will receive 4 Packets of Kerr Ni Ti Files **Free** at their demonstration with the compliments of **Kerr**.

# Finishing and Polishing Products

## POLISHING POINTS

### KENDA POLISHERS

- Manufactured in Liechtenstein according to ISO9001 quality specifications
- Autoclavable at 135°C



### CGI 3-Step System

For universal composites, compomers and glass-ionomers

The CGI polishing system contains specific polishers in 3 grades for contouring, finishing and polishing

- Available as an introductory kit and also in coarse, medium and ultra-fine refill packs
- Introductory kit includes one of each type of the refills

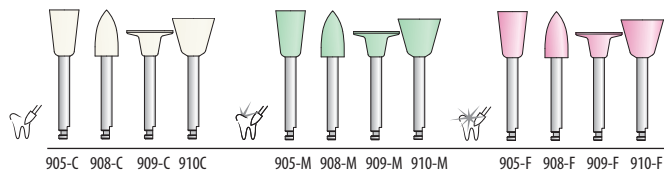

KE900 CGI introductory kit (as per pic)  
KE09\_ CGI refill packs - packet of 12

### Nobilis Diamond Polishers

1-step diamond polishing system for composite and ceramic

- Fine grit for smooth surfaces
- Can be used before Unicus polishers as a 2-step system
- Available as an introductory kit (assorted) and also refill packs
- Introductory kit includes two of each of the refills
- Recommended speed 7,500 - 10,000 rpm

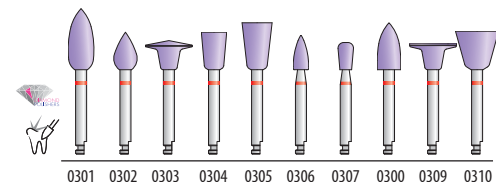

KE0300012 Nobilis introductory kit (as per pic)  
KE03\_ Nobilis refill packs - packet of 12

### Unicus Diamond Polishers

Diamond polishing system for final polish of composite and ceramic

- Extra fine grit for ultra smooth surfaces
- Can be used after Nobilis polishers for final polishing
- Available as an introductory kit (assorted) and also refill packs
- Introductory kit includes two of each of the refills
- Recommended speed 7,500 - 10,000 rpm

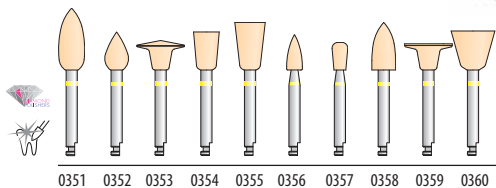

KE0350012 Unicus introductory kit (as per pic)  
KE035\_ Unicus refill packs - packet of 12

### Composite Microfill Polishers

For polishing all microfilled composite materials

Also, suited for simply removing cement remnants of orthodontic bands (brackets)

- Available as an introductory kit (KE750) and also refill packs
- Introductory kit includes 6 x prepolishers (yellow) and 6 x hi-shine polishers (blue) (4001-4006 and 5001-5006)



Intro kit  
KE750

#### Prepolisher Yellow

- For prepolish of microfilled composite, removal of cement remnants
- Recommended speed 7,500 - 10,000 rpm

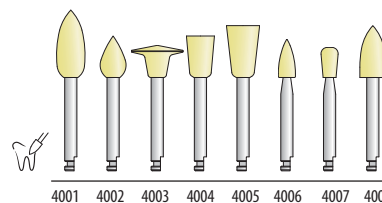

KE400\_ Composite prepolisher yellow - packet of 12

#### Hi-Shine Polisher Blue

- For optimal, long lasting shine in a matter of seconds
- Recommended speed 5,000 - 7,500 rpm

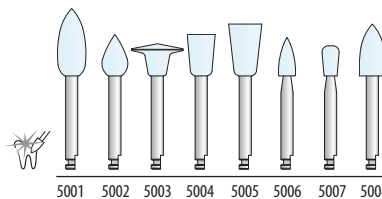

KE500\_ Composite hi-shine polisher blue - packet of 12

### Zircovis Diamond Polishers

Hard, robust, diamond polishers for cerec and ceramic

- Available as an introductory kit and also in medium and fine grit refill packs
- Introductory kit includes two of each type of the refills

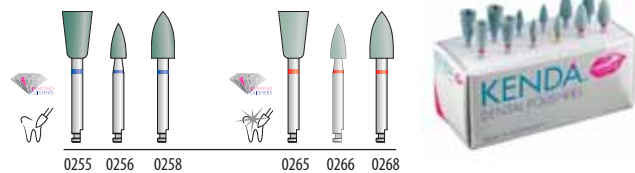

KE0250012 Zircovis introductory kit (as per pic)  
KE02\_ Zircovis refill packs - packet of 12

To view the complete range of KENDA POLISHERS, please ask for a copy of the latest Kenda catalogue



# Finishing and Polishing Products

## IDENTOFLEX COMPOSITE POLISHERS

*Finishing and polishing system for composites*

- Optimised Identoflex composite polishers for a high surface shine
- Optimum price-to-performance ratio
- Colour coding of the polishers for easy identification at each stage
- Designed for all surfaces

Available in yellow (prepolisher) and white (high gloss polisher)  
Available in 4 shapes - flame, point, cup, disc  
Each supplied as a packet of 12 (of one size)



ID5\_ Identoflex composite polishers - specify shape

## INTENSIV UNIGLOSS POLISHERS

*For final high gloss polishing of concave and convex surfaces of aesthetic restorations*

- For highly smooth and shiny surfaces of aesthetic restorations
- Diamond polymer filled polished highly loaded with ultra fine diamond pieces
- Autoclavable, multiple-use
- Two shapes available - slim point (flame) and cup
- Shape stable - does not lose shape or distort with use
- Core of flame and cup shape and mandrel consist of one piece of hard turquoise plastic (metal-free)
- The tip remains a tip even with multiple-use



Each supplied as a packet of 6

- IT2300 Unigloss polisher kit  
*includes 3 x flame polishers and 3 x cup polishers*
- IT23106 Unigloss polisher flame refill
- IT23206 Unigloss polisher cup refill

## POLISHING ACCESSORIES

### INTENSIV UNIGLOSS DIAMOND PASTE

*Clinically tested and scientifically approved by the University of Zurich*

One step universal extra fine grit diamond paste with uniquely surface adapted micro grain for high gloss shining of all aesthetic restorations.

- Final polishing and high gloss shining for the surfaces of all aesthetic dental materials
- Can be used with either standard nylon bristle junior cup brush or prophylaxis rubber cup
- Splatter free
- Fast high gloss polishing in 15 seconds

Supplied as a 2.5g syringe



IT2500 Unigloss diamond polishing paste

## PROPHY CUPS

*Oraltec private label Oracups*

- Each supplied as a packet of 36

- ORCUPRA Latch grip/RA - white
- ORCUPSC Screw in - white
- ORO54201 Screw in - blue (latex free)
- ORCUPSNP Snap on - blue (latex free)

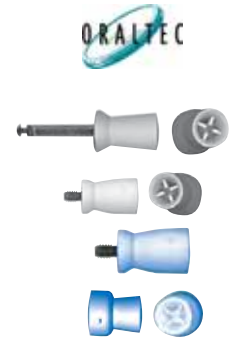

## PROPHY BRUSHES - Stoddard Junior

**Screw type**

- STBRUSS36 Screw - packet of 36
- STBRUSS144 Screw - packet of 144

**Latch grip/right angle type**

- STBRUSR36 Latch grip/RA - packet of 36
- STBRUSR144 Latch grip/RA - packet of 144



## OPTISHINE POLISHING BRUSHES

*Concave-shaped polishing brush allowing simpler, quicker smooth finishes on all tooth surfaces*

Bristles are embedded with polishing particles (silicone carbide) that polish to an extremely high lustre, eliminating the need for a proprietary paste.

- Fully autoclavable
- Supplied as a packet of 10

- KR2514 OptiShine polishing brushes



## POLISHING DISCS AND STRIPS

### KERR OPTIDISCS

*The high performing polishing disc*

- Translucent disc allows enhanced working surface visibility
- Disc is very thin for greater disc flex
- Long lasting due to the durable polyester material used
- Ready to use with high polishing ability from the start
- Supplied in packets of 100 (except for 80µm which is supplied in packets of 80 only)



Grit	9.6mm	12.6mm	15.9mm
80µm, extra coarse	KR4197	KR4198	KR4199
40µm, coarse	KR4181	KR4184	KR4191
20µm, fine	KR4182	KR4185	KR4192
10µm, extra fine	KR4183	KR4186	KR4193

### OptiDisc Mandrels

- Supplied as a packet of 5

- KR195 Standard mandrel
- KR196 Short mandrel



# Finishing and Polishing Products

## MOORES DISCS - PAPER - 5/8" and 1/2"

- Available in 3 grits - fine, medium, coarse
- Supplied as a packet of 50 discs

MRSAN\_PA\_ Sand 5/8" or 1/2"  
MRGAR\_PA\_ Garnet 5/8" or 1/2"



## MOORES DISCS - PLASTIC - 5/8" and 1/2"

- Available in 3 grits - fine, medium, coarse
- Supplied as a packet of 50 discs

MRSAN\_PL\_ Sand 5/8" or 1/2"  
MRGAR\_PL\_ Garnet 5/8" or 1/2"

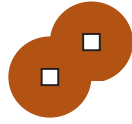

## Moore's mandrels

MRMANHP7 Moore's mandrel #7 HP  
MRMANRA2 Moore's mandrel #2 RA



## MOORE-FLEX COMPOSITE POLISHING DISCS

- Aluminium oxide, brass centered thin flexible discs
- Colour-coded for easy identification
- Autoclavable to 135°C
- Available in three sizes: 3/8", 1/2" and 5/8"
- Available in four grits: white/coarse, green/medium, blue/fine, brown/ultra fine
- Supplied as a packet of 100 discs

MRBC381\_ M-Flex 3/8"  
MRBC121\_ M-Flex 1/2"  
MRBC581\_ M-Flex 5/8"



## M flex mandrels

MRBC2RAM M-Flex mandrel

## MOORES ALUMINIUM FINISHING STRIPS

### Aluminium oxide strips

- Available in dual grits - medium/coarse + fine/ultra fine
- Supplied as a packet of 100

MRFSGMORF Medium (green) + coarse (white)  
MRFSGMORP Fine (blue) + ultra fine (tan)

## LM-CELLO METAL STRIP HOLDER

### For finishing proximal surfaces

- For removal of calculus
- For removal of cement
- For finishing of cement seams
- Single or double-sided strips, with or without blank in the strip



When grinding the filling on a proximal surface, slacken the tension of the strip. Press the strip against the filling and move back and forth. The slackened strip follows the tooth contours and does not damage the gums. Retighten the strip for removal.

LM2010C LM-Cello metal strip holder

## Metal strips for LM-Cello strip holder

- Supplied as a packet of 50



## Strips with blanks

LM5502 One-sided, width 2mm x 0.12mm thick  
LM5503 One-sided, width 3mm x 0.12mm thick  
LM5503D Double-sided, width 3mm x 0.18mm thick

## Strips without blanks

LM5512 One-sided, width 2mm x 0.12mm thick  
LM5513 One-sided, width 3mm x 0.12mm thick  
LM5513D Double-sided, width 3mm x 0.18mm thick

## METAL DIAMOND STRIPS

### Diamond coated metal strips with insertion gap

- Metal strips, diamond-coated on one side, with two working areas of different grit sizes
- Diamond-free zone between the diamond-coated surfaces
- Grip secure strip ends, perforated and ergonomically designed
- Sterilisable and reusable

## ProxoStrips (original)

### For finishing and polishing

- 40µm (red) and 15µm (yellow)
- Supplied as a packet of 12



Total length  
80mm

ITPX401512 ProxoStrips (original)

## ProxoContour

### For removal of excess material and contouring and finishing

- 60µm (brown) and 40µm (red)
- Supplied as a packet of 6



Total length  
80mm

ITPXC60406 ProxoContour Strips

## ProxoContour Coarse

### For removal of excess material and contouring and finishing

- Perforated with three rows of holes
- 80µm (blue) and 40µm (red)
- Supplied as a packet of 6



Total length  
80mm

Perforated metal strip

ITPXC60406 ProxoContour Strips

## ProxoPolish

### For stain removal and gloss polishing

- 15µm (yellow) and 8µm (orange)
- Supplied as a packet of 6



Total length  
80mm

ITPXPO15086 ProxoPolish strips

## ProxoStrip Anterior

### For interproximal finishing of anterior restorations

- 40µm (blue) and 15µm (yellow)
- Supplied as a packet of 6



Total length  
55mm

ITPXA40156 ProxoStrip Anterior

## ProxoStrip Trial Kit

- Assorted kit including  
2 x ProxoStrips  
1 x ProxoStrip Anterior  
2 x ProxoContour Coarse  
and 1 x ProxoPolish



ITPXTASST6 ProxoStrip trial kit



# Handpieces

## HIGH SPEED TURBINES

### TITANIUM HIGH SPEED HANDPIECES

#### Ti-Max Z

- Titanium body with scratch resistant DURAGRIP
- Cellular glass optics
- Ceramic bearings
- Clean head system
- Push button chuck
- Quattro spray
- Microfilter

The Z turbine delivers consistent power and is ergonomically designed.

#### For NSK couplings



**Miniature head:** Power 23W, speed 360,000-440,000 min, head size  $\varnothing$  10.8 x H12.1mm

**Standard head:** Power 26W, speed 320,000-400,000 min, head size  $\varnothing$  12.5 x H13.1mm

Quattro spray

#### Connect direct to NSK coupling



Miniature	<b>Optic</b>	Model Z800L	Code NKP1110
Standard	<b>Optic</b>	Model Z900L	Code NKP1111

#### For other couplings



**Miniature head:** Power 21W, speed 360,000-440,000 min, head size  $\varnothing$  10.8 x H12.1mm

**Standard head:** Power 24W, speed 320,000-400,000 min, head size  $\varnothing$  12.5 x H13.1mm

Quattro spray

#### Connect direct to KaVo® LED coupling



Miniature	<b>Optic</b>	Model Z800KL	Code NKP1112
-----------	--------------	--------------	--------------

#### Connect direct to Sirona® LED coupling



Miniature	<b>Optic</b>	Model Z800SL	Code NKP1114
Standard	<b>Optic</b>	Model Z900SL	Code NKP1115

#### Connect direct to W&H® coupling



Miniature	<b>Optic</b>	Model Z800WL	Code NKP1120
Standard	<b>Optic</b>	Model Z900WL	Code NKP1121

### TITANIUM 45° ANGLED HIGH SPEED HANDPIECE

#### Ti-Max Z

- Titanium body with scratch resistant DURACOAT
- 45° angle head
- Cellular glass optics
- Ceramic bearings
- Clean head system
- Push button chuck
- Triple water jet

The slim-form Ti-Max X450 has a unique 45° angled head specially designed to access hard-to-reach areas for sectioning and extraction of third molars and other impacted teeth.

#### Connect direct to NSK couplings



Triple Water Jet



<b>Optic</b>	Model X450L	Code NKP1078
--------------	-------------	--------------

Power 21W, speed 380,000-450,000 min, head size  $\varnothing$  11 x H13.5mm

- For FG extra-long burs (25mm) only

Also available with KaVo, Sirona and W&H couplings

### STAINLESS STEEL HIGH SPEED HANDPIECES

#### S-Max M

- Stainless steel body
- Cellular glass optics
- Ceramic bearings
- Clean head system
- Push button chuck
- Quattro spray

Slim ergonomic design and unrivalled cutting performance.

#### For NSK couplings



**Miniature head:** Power 16W, speed 380,000-450,000 min, head size  $\varnothing$  10.6 x H12.4mm

**Standard head:** Power 20W, speed 360,000-430,000 min, head size  $\varnothing$  12.1 x H13.3mm

Quattro spray

#### Connect direct to NSK coupling



Miniature	<b>Optic</b>	Model M500L	Code NKP1001
Miniature	<b>Non-Optic</b>	Model M500	Code NKP1003



Standard	<b>Optic</b>	Model M600L	Code NKP1002
Standard	<b>Non-Optic</b>	Model M600	Code NKP1004

# Handpieces

## For other couplings



Quattro spray

**Miniature head:** Power 16W, speed 380,000-450,000 min, head size  $\varnothing$  10.6 x H12.4mm

**Standard head:** Power 20W, speed 360,000-430,000 min, head size  $\varnothing$  12.1 x H13.3mm

### Connect direct to KaVo® coupling



Miniature  
Miniature

**Optic**  
**Non-Optic**

Model M500KL  
Model M500K

Code NKP1005  
Code NKP1007



Standard  
Standard

**Optic**  
**Non-Optic**

Model M600KL  
Model M600K

Code NKP1006  
Code NKP1008

### Connect direct to Sirona® coupling



Miniature  
Standard

**Optic**  
**Optic**

Model M500SL  
Model M600SL

Code NKP1009  
Code NKP1010

### Connect direct to W&H® coupling



Miniature  
Standard

**Optic**  
**Optic**

Model M500WLED Code NKP1114  
Model M600WLED Code NKP1115

## CONTRA ANGLE COMPLETE HANDPIECES

### TITANIUM SLOW SPEED HANDPIECES

#### Ti-Max Z

- Titanium body with scratch resistant DURAGRIP
- Cellular glass optics
- Clean head system (exclude Z84L)
- Push button chuck
- Microfilter



Quattro spray



**Optic** Model Z95L Code NKC1034

- 1:5 Increasing • Exceptional durability • Quattro spray
- For FG burs ( $\varnothing$  1.6) • Ceramic bearings • DLC coating
- Anti heat system • Max speed 200,000 min



Single spray



**Optic** Model Z85L Code NKC1062

- 1:5 Increasing • Exceptional durability • Single spray • Miniature head
- For FG burs ( $\varnothing$  1.6) • Ceramic bearings • DLC coating
- Anti heat system • Max speed 200,000 min

\* Short shank burs only



Single spray



**Optic** Model Z25L Code NKC1038

- 1:1 Direct Drive • Single spray • For CA burs ( $\varnothing$  2.35)
- Max speed 40,000 min



**Optic** Model Z24L Code NKC1126

- 1:1 Direct Drive • Single spray • Miniature head
- For CA burs ( $\varnothing$  2.35) • Max speed 40,000 min



**Optic** Model Z15L Code NKC1039

- 4:1 Reduction • Single spray • For CA burs ( $\varnothing$  2.35)
- Max speed 10,000 min



**Optic** Model Z10L Code NKC1040

- 16:1 Reduction • Single spray • For CA burs ( $\varnothing$  2.35)
- Max speed 2,500 min

To view the complete range of NSK products,  
please ask for a copy of the latest NSK catalogue





**NSK**

CREATE IT.



TiMax Z Air Turbine



NLX nano



VIVAMATE G5



Ti-Max Z  
Contra-angle



VarioSurg3



ENDOMATE TC2

iCare



VOLVERE i7



Varios 970



TAKE  
THE  
LEADING  
EDGE.



SHAPE  
AN  
INSPIRING  
SMILE.



# Handpieces

## TITANIUM 45° ANGLED SLOW SPEED HANDPIECE

### Ti-Max Z

- Titanium body with scratch resistant DURAGRIP
- 45° angle head
- Cellular glass optics
- Ceramic bearings
- Clean head system
- Push button chuck
- Quattro spray (water jet / mist)
- Microfilter
- Anti heat system
- DLC coating

#### Two-way spray function



Water jet

Mist

The world's first two-way spray function allows you to instantly choose a mist or jet spray depending on the conditions and procedure. The water jet spray prevents subcutaneous emphysema in surgical procedures and the mist spray effectively cools the bur while cutting.



**Optic** Model Z45L Code NKC1064

**1:4.2 Increasing** • For FG burs (ø 1.6) • Max speed 168,000 min



Single spray



**Optic** Model M25L Code NKC1024  
**Non-Optic** Model M25 Code NKC1027

1:1 Direct Drive • Single spray • For CA burs (ø 2.35)  
• Max speed 400,000 min



**Optic** Model M15L Code NKC1025  
**Non-Optic** Model M15 Code NKC1028

4:1 Reduction • Single spray • For CA burs (ø 2.35)  
• Max speed 10,000 min

### Straight handpiece



**Non-Optic** Model M65 Code NKH1008

1:1 Direct Drive • Single spray • For HP burs (ø 2.35)

## TITANIUM SLOW SPEED HANDPIECES

### Ti-Max X

- Titanium body with scratch resistant DURACOAT
- Cellular glass optics
- Clean head system
- Push button chuck (except models X65L and X65)
- Microfilter

#### Straight handpiece



**Optic** Model X65L Code NKH273  
**Non-Optic** Model X65 Code NKH274

1:1 Direct Drive • Single spray • For HP burs (ø 2.35)  
• For CA burs (ø 2.35)\* • Max speed 40,000 min  
\*Need to insert the supplied bur stopper

## CONTRA ANGLE EX SHANK & HEADS

With External Water Spray

### Shank for EX heads

Model ECM  
Code NKC100007

- 1:1 Direct Drive



Handpieces and heads are sold separately.  
You can combine handpieces and heads as required.

## STAINLESS STEEL SLOW SPEED HANDPIECES

### S-Max M

- Stainless steel body
- Cellular glass optics
- Clean head system
- Push button chuck (except M65)



Quattro spray



**Optic** Model M95L Code NKC1023  
**Non-Optic** Model M95 Code NKC1026

1:5 Increasing • Quattro spray • For FG burs (ø 1.6)  
• Ceramic bearings • Max speed 200,000 min

### Heads for General Application - Non-Optic

Model FPB-Y Code NKC875

- For CA burs (ø 2.35) • Clean head system
- Push button chuck • Ball bearing • Max speed 40,000 min



Model NAC-Y Code NKC032002

- For CA burs (ø 2.35) • Latch type
- Max speed 30,000 min



### Heads for Prophylaxis Application - Non-Optic

Model AR-Y (S) Code NKC187

- For screw-in cups and brushes
- Max speed 5,000 min



Model AR-Y (K) Code NKC188

- For snap-on cups
- Max speed 5,000 min



# Handpieces

## ELECTRIC MOTORS

### NLX NANO ELECTRIC MICROMOTOR INTEGRATED SYSTEM

- Optic
- Internal water spray
- Speed: 1,000-40,000 min, Torque: 3.4 Ncm

Brushless



#### Integrated System Individual Components

- Model NLX BF Code NKY1002122
- Power module with lamp and air function for integrated system
  - Dimensions with case: W115 x D68.5 x H40 mm



- Model NLS ADP Code NKU1020050
- 24Vac - 32Vdc converter for integrated system



- Model NLS SEL Code NKY1001808
- Selector module for integrated system
  - Dimensions: W62 x D50 x H28.6 mm



- Model NLX nano Code NKE1044051
- NLX nano micromotor only (cord not included)
  - Solid titanium body
  - Autoclavable up to 135°C



- Model NLX CDB Code NKE1044066
- NLX nano micromotor cord for integrated system (2.2m)



- Model Multi Pad Auto Select Code NKY1001846
- Multi-control panel for built-in system
  - Dimensions: W95 x D138 x H31 mm



### NLX PLUS ELECTRIC MICROMOTOR INTEGRATED SYSTEM

- Optic
- Internal water spray
- Speed: 1,000-40,000 min, Torque: 4.0 Ncm, with Endo Function

Brushless



#### Features of NLX Plus

- Torque control and auto reverse feature
- 3 working modes: Auto-reverse on, auto-stop or auto-reverse off
- Autoclavable titanium body
- LED illumination
- Installable built-in type conforms to most dental equipment

#### Integrated System Individual Components

- Model NLX BF Code NKY1002122
- Power module with lamp and air function for integrated system
  - Dimensions with case: W115 x D68.5 x H40 mm



- Model NLS ADP Code NKU1020050
- 24Vac - 32Vdc converter for integrated system



- Model NLS SEL Code NKY1001808
- Selector module for integrated system
  - Dimensions: W62 x D50 x H28.6 mm



- Model NLX plus Code NKE1040051
- NLX plus micromotor only (cord not included)
  - Solid titanium body
  - Autoclavable up to 135°C



- Model plus CD Code NKE1040062
- NLX plus micromotor cord for integrated system (2.2m)



- Model Multi Pad Auto Select Code NKY1001846
- Multi-control panel for built-in system
  - Dimensions: W95 x D138 x H31 mm



## AIR MOTORS

### TI-MAX TITANIUM AIR MOTOR

with internal water spray

LED

#### Advantages

- Shorter and lighter unsurpassed balance air motor
- 360°C swivel with LED illumination (32,000 LUX)

#### Optic

Model X205L Code NKM1013



NSK

- 360°C swivel with LED illumination • 32,000 LUX
- Titanium body with scratch-resistant DURACOAT
- Non-retraction valve • Max 25,000 min

### S-MAX STAINLESS STEEL AIR MOTOR

with internal water spray

#### Non-Optic

Model M205 Code NKM1007



NSK

- Stainless steel body • Non-retraction valve
- Midwest 4 hole • Max 25,000 min

# Handpieces

## OSCILLATING HANDPIECE

### INTENSIV SWINGLE



The contra-angle Intensiv Swingle has two functions: the freely rotating axial position to use with diamond coated files (eg., Intensiv Proxoshape) and fixed axial position. The contra-angle head is small to allow an extensive view on the operating field.



- Contra-angle with integrated water spray and optional light
- Stroke 0.9mm
- 20,000 oscillating movements with 40,000 rpm
- Toggle switch to select rotating or fixed position
- 12 different axial fixed positions on 360°
- File ejector and cleaning needle (water spray canals) are included in delivery



#### Benefits

- 2 applications with one contra-angle only, axially freely rotating or axially fixed files
- Extensive view on the operating field due to small size contra-angle head and light
- Better grinding and polishing efficiency
- Two-year warranty
- Sterilisable



ITWG69LTRS Intensiv Swingle starter kit  
Includes contra-angle handpiece, ejector and spray canal cleaner needle



ITWG69LTRP Intensiv Swingle professional restorative kit  
Includes contra-angle handpiece, ejector, spray canal cleaner needle, 3 x Proxoshape coarse, 2 x Proxoshape PS1, 2 x PS2 and 2 x PS3



ITWG69LTO Intensiv Swingle professional orthodontic kit  
Includes contra-angle handpiece, ejector, spray canal cleaner needle and 1 x each of Ortho-Strips (a) opener, (b) extra coarse, (c) coarse, (d) medium, (e) fine and (f) polishing

For more information on Intensiv Proxoshapes and Ortho-Strips, please refer to BURS, page 17

## HANDPIECE MAINTENANCE

### iCARE

Automatically cleans and lubricates

- Preset solution volume based on handpiece type (high-speed handpieces and low-speed handpieces)
- Thorough cleaning and lubrication with simple operation
- Chuck cleaning function ensures that the chuck is thoroughly cleaned and lubricated
- Purging select mode ensures complete removal of excess oil
- Integrated large oil tank (1.2 litre)
- Compact with small footprint



Contents include iCare unit, power cord, chuck cleaning nozzle, maintenance oil for iCare (1 litre), mist filter set, oil absorber sheet and air tube



NKY1002787 iCare C2 type, complete unit (with dual standard connectors and dual rotation connectors)

NKY1002788 iCare C3 type, complete unit (with single standard connectors and triple rotation connectors)

#### Refill Maintenance Oil

NKZ016130 Maintenance oil for iCare 1 litre

NKY900159 Mist filter set - pack of 12

NKU433135 Oil absorber sheet - pack of 10



### PANA SPRAY PLUS

Alcohol-contained lubricant for high and low speed handpieces and air motors

Apply PANA SPRAY Plus every time before autoclaving any handpiece or air motor for performance and durability.

NKZ182100 PANA SPRAY Plus - 480ml

NKZ020201 Replacement tip/spray nozzle



### SPRAY MIST ABSORBER

A convenient way to prevent mist spray from escaping into the environment

Simply insert the handpiece into the absorber pack then apply the spray lubricant.

- Supplied as a packet of 10

NKY900084 Spray Mist Absorber



### PDS ROTAGEN SPRAY LUBRICANT

High pressure rapid lubricant for handpiece turbines and air motors

Contains ultra pure, autoclavable lubricating solution which leaves no residue.

- Supplied as a 350g can

PD36350 Rotagen spray lubricant



# Impression Materials

## TISSUE MANAGEMENT

### GINGIVAL RETRACTION AND HAEMOSTATIC SYSTEM

*Expasyl™ is especially formulated for all cases of sulcular deflection and/or haemostatis, including:*

- Prior to impression taking with or without tooth preparation
- Prior to prosthetic seating
- Restoring class II and V cavities
- Arresting heavy surgical bleeding eg second stage implant surgery



AC294100  
Expasyl introductory kit

#### Composition

Aluminium chloride  
(= 15%), Kaolin, Excipients



#### Properties

*Expasyl™ paste ensures temporary gingival retraction, haemostasis and a dry sulcus. The main characteristics of Expasyl™ are as follows:*

- **Gentle, non-invasive protocol:** unlike other techniques which can damage the epithelial attachment, Expasyl™ is especially formulated to exert 10 grams of pressure which is sufficient to obtain access to the preparation yet gentle enough to respect soft tissue. This removes the risk of gingival recession and/or future bone resorption.
- **Easy to use & time saving:** Expasyl™ allows retraction and haemostasis to occur simultaneously in most cases. Total application time from application to removal in less than 3 minutes. Being water soluble, Expasyl™ is simply removed with the air/water spray leaving a dry, retracted sulcus.
- **Haemostatic and astringent:** unbeatable haemostasis, even in cases of heavy surgical bleeding due to Expasyl's unique chemical and mechanical properties. Kaolin and aluminium chloride work to leave a site free of any crevicular fluid and/or blood.
- **Painless and reversible:** Expasyl™ is so gentle that no anaesthesia is required for endodontically treated teeth. At end of session the gingival space returns to normal.
- Each carpule contains material for 5 - 8 applications

#### Expasyl Carpules

AC261030 Original - packet of 20  
AC261001 Strawberry - packet of 20



#### Disposable Tips

AC261040 Straight - packet of 40  
AC261005 Straight - packet of 100  
AC261045 Pre-bent - packet of 40  
AC261015 Pre-bent - packet of 100



#### Expasyl Introductory Kit

AC294100 Kit contains one gun, 6 x strawberry carpules and 12 straight tips

#### Applicator Gun

AC260900 Expasyl applicator gun



### GINGIBRAID+™ RETRACTION CORD

GingiBRAID+ is a specially treated, impregnated\* or non-impregnated retraction cord braided together for quick absorption, providing immediate and effective use. The braided retraction material is made of cotton fibre that will not split or collapse in the sulcus.

- Can be used with any type of packing instrument
- Easiest to work with when the cord is wetted prior to packing
- Available in 4 diameters, both in bottle or in dispenser with the built-in ShortCut all-in-one delivery system



#### ShortCut™ Dispenser System

ShortCut features a built-in cord cutter and a dial.

Each click of the dial delivers 1cm of cord.

3-4 clicks for anterior and 4-5 clicks

for posterior teeth.

Each ShortCut and bottle contains 183cm

of braided gingival retraction cord.



#### Impregnated with 10% aluminium potassium sulphate

KR13210 Bottle - OA, fine, yellow  
KR13211 Bottle - 1A, small, yellow with purple strand  
KR13212 Bottle - 2A, medium, yellow with green strand  
KR13730 ShortCut - OA, fine, yellow  
KR13731 ShortCut - 1A, small, yellow with purple strand  
KR13732 ShortCut - 2A, medium, yellow with green strand

#### Non-impregnated

KR13740 ShortCut - ON, fine, white  
KR13741 ShortCut - 1N, small, white with purple strand  
KR13742 ShortCut - 2N, medium, white with green strand

### CORD PACKERS

- For packing retraction cord into the gingival pocket



LM490491\_ Cord packer 2mm



LM492493\_ Cord packer 2.6mm

Available in either ErgoMax or ErgoSense handles - please refer to page 72 for more information on handle types

## IMPRESSION PREPARATION

### ORTHOSKAVIDENT C

*Orthoskavident C is an application liquid for cleaning and drying prepared cavities and teeth*



It can be used for all external applications in the dental practice that require a clean, grease-free surface eg;

- removing the smear layer on the surface of prepared teeth before taking impressions
- fitting fixed restorations or placing fillings
- replacement or repair of a damaged veneer intraorally
- sealing of teeth
- bonding brackets in orthodontics etc.

Supplied as a 150ml bottle

KT13063 Orthoskavident C



# Impression Materials

## IMPRESSION MIXING EQUIPMENT

### ALGINATE MIXER

*Consistent, dense bubble free alginate mixes every time*

- Smooth and homogenous mix in 8 seconds
  - No air bubbles - resulting in a more accurate impression
  - Uniform consistency - increased tear resistance and elasticity
  - Less wasted alginate
  - 3 preset programmes
    - 1 scoop for 6-9 seconds
    - 2 scoops for 7-10 seconds
    - 3 scoops or more for 8-11 seconds
- or adjust manually from 1-16 seconds as required



MIGX300 Algimax II

*includes 1 x spatula for mixing, 1 x stirrer stick, 1 x small magnetic basket, 4 x mixing cups and 1 x water dosing bottle*

### SYMPRESS DISPENSER MIXING MACHINE

*For accurate mixing, dispensing and application of silicone materials*

Electrical dispensing and mixing system for automatic mixing of impression materials of the Kettenbach jumbo system and similar systems in a mixing ratio of 5:1

#### Advantages

- Exact, standardised dispensing, mixing and delivery provides a reproducible mixing quality independent of the operator
- Homogenous, bubble-free mixing ensures optimum material properties and impression results
- Hygienic working at the press of a button; only the required amount of material is delivered
- Flow rate can be adjusted for loading trays or syringes, automatic forward and return flow
- Easy, reliable operation, outstanding service, 3-year manufacturer guarantee



KT35910 Sympress dispenser mixing machine

## CLINICAL DIGITAL IMPRESSION SCANNER

### CS 3600 INTRAORAL 3D SCANNER

*Seamless integration with the best CAD CAM system, including Ceramill... and with no license fees*

The Carestream CS 3600 intraoral scanner makes digital impression capture fast and easy. It is ideal for capturing images and sending files to your digital laboratory for crowns and bridges.

- You can start, stop or rescan from anywhere in the mouth
- Broad focal length means you can hover around, above or rest the scanner on the tooth
- Easy to remove any excess scanned tissue as needed and add to the data without starting again
- Easy to use making the transition to digital easy, with step by step user interface
- Highly accurate images which facilitate precise clinical results
- Improve image capture and patient comfort with rounded, shorter trips



The Carestream CS 3600 produces highly accurate full HD 3D colour images with enhanced quality and texture which facilitates dentist/patient communication and increases case acceptance.

CS3600 Carestream intraoral CS 3600 3D scanner



# Impression Materials

## IMPRESSION TRAYS

### DISPOSABLE PERFORATED PLASTIC IMPRESSION TRAYS

- Cost effective
- Rigid plastic which does not distort
- Good retention of impression materials
- Ideal for open tray impressions for implants
- Available in a range of sizes

SGTRAYLL	Large lower
SGTRAYLU	Large upper
SGTRAYML	Medium lower
SGTRAYMU	Medium upper
SGTRAYSL	Small lower
SGTRAYSU	Small upper
SGTRAYPA	Partial side A
SGTRAYPB	Partial side B
SGTRAYPAL	Partial anterior lower
SGTRAYPAU	Partial anterior upper



Easy to expand the tray using a denture bur for implant impressions

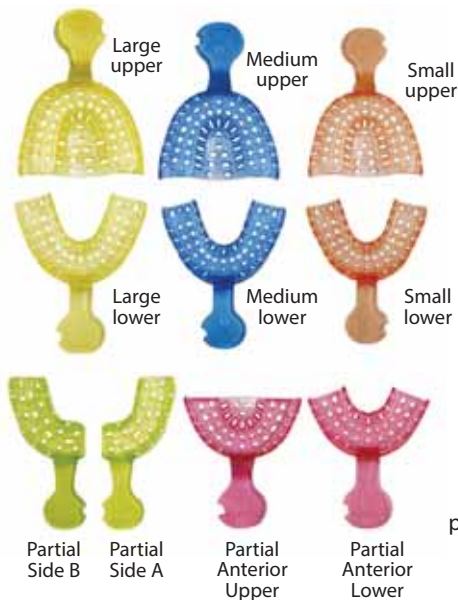

SGTRAY\_  
Plastic  
Impression Trays

Supplied as a packet of 48 trays or 40 large trays

### PLASTIC DISPOSABLE EEZITRAY IMPRESSION TRAYS

- Perforated green trays
- Supplied as a packet of 25 (of one size) + one handle
- Additional/replacement handles sold separately

WRTRAY3	#3 upper edentulous - large
WRTRAY4	#4 lower edentulous - large
WRTRAY5	#5 upper edentulous - average
WRTRAY6	#6 lower edentulous - average
WRTRAY11	#11 upper dentate - large
WRTRAY12	#12 lower dentate - large
WRTRAY13	#13 upper dentate - average
WRTRAY14	#14 lower dentate - average
WRTRAY15	#15 upper dentate - ortho
WRTRAY16	#16 lower dentate - ortho
WRTRAY17	#17 upper dentate - small
WRTRAY18	#18 lower dentate - small
WRTRAY20	#20 upper / lower sectional anterior
WRTRAY21	#21 upper / lower sectional ½ (left)
WRTRAY22	#22 upper / lower sectional ½ (right)



**WRIGHT**  
DENTAL LABORATORIES

WRTRAYHAND  
Eezitray replacement handles - packet of 10



### HAMMACHER METAL IMPRESSION TRAYS

- Wirolock impression trays made of high quality corrosion-resistant Wironit steel
- Available in a range of sizes (XL, L, M, S, anterior, child)
- Available in solid and perforated, dentate and edentulous

HMHWL3_	Solid dentate impression trays
HMHWL3_	Solid edentulous impression trays
HMHWL3_	Perforated dentate impression trays
HMHWL3_	Perforated edentulous impression trays

**Hammacher**  
Instrumente



### MULTI TRAY BITE TRAYS

Partial plastic, single use impression trays for taking anatomical impressions with opposing dentition impression all in one

- Saves time
- Thin, tear resistant gauze
- No adhesive required
- Ideal for impressions for temporary crowns
- Supplied with patient identification sticker
- Three variations available



SGMULTIP	Posterior - packet of 50
SGMULTIA	Anterior - packet of 30
SGMULTIQ	Quadrant - packet of 50

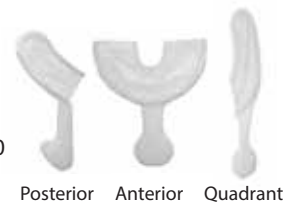

## IMPRESSION COMPOUND

### IMPRESSION COMPOUND CAKES AND STICKS

*For full/partial impressions or copper bands/tracing*

Kerr impression compound comes in cakes of convenient size for full or partial impressions and sticks for copper band impressions or for adding to the periphery of an impression or custom tray.

Each colour has a controlled working temperature for a specific use.



KR004\_ Compound cake - 227g (8 pieces)  
Available in red, green or grey

**Kerr**



KR004\_ Compound stick - 113g (15 pieces)  
Available in red, green or grey

# Impression Materials

## ALGINATES

### CAVEX CREAM

*For exceptional detail*

This modern, scannable, alginate is easily mixed into a superbly smooth and creamy substance.

- 5µm detail reproduction
- Easy to mix
- High tear strength and elastic
- Purple colour
- Bubblegum fragrance
- Dust free
- Fast set (140 seconds including mixing, set time 60 seconds)
- Normal set (210 seconds including mixing, set time 90 seconds)
- Scannable
- Supplied as a 500g bag



CAAA600 Cavex Cream alginate - normal set  
CAAA605 Cavex Cream alginate - fast set

### CAVEX IMPRESSIONAL

*Amazingly elastic*

Thanks to a winning combination of exceptionally high elasticity strength, Impressional is ideally suited to working around metal frameworks and noticeable undercuts.

- 25µm detail reproduction
- High tear strength and elastic
- Blue colour
- Spearmint fragrance
- Dust free
- Fast set (150 seconds including mixing, set time 60 seconds)
- Normal set (210 seconds including mixing, set time 90 seconds)
- Supplied as a 500g bag



CAALGINN Cavex Impressional alginate - normal set  
CAALGINF Cavex Impressional alginate - fast set

### CAVEX COLOUR CHANGE

*9 days dimensional stability*

This fast set alginate, which features a colour change system, is highly elastic and tear resistant. This unique alginate is dimensionally stable for 9 days.

- 25µm detail reproduction
- High tear strength and elastic
- Innovative colour change (end of mixing time: violet to pink) (end of setting time in mouth: pink to white)
- Mint fragrance
- Dust free
- Fast set (150 seconds including mixing, set time 60 seconds)
- Supplied as a 500g bag



CAALGC500 Cavex ColourChange alginate

### Cavex alginates are one of a kind

**Five-year shelf life** - Stays in perfect condition for 5 years

**Snap-set** - Short setting time - better for the patient

**Tear resistant and strong** - At least two pourings



### CAVEX ORTHOTRACE

*Extra fast setting for orthodontics*

This alginate does not flow into the back of the mouth, so the gag reflex is avoided. The red fruit fragrance and attractive magenta colour is appealing to patients.

- 50µm detail reproduction
- Easy to mix
- High tear strength and elasticity
- Pink colour
- Berry fruit fragrance
- Dust free
- Extra fast set (130 seconds including mixing, set time 60 seconds)
- Optimal gypsum compatibility
- Can be cast twice
- Supplied as a 500g bag



CAAA380 Cavex Orthotrace alginate

## ALGINATE ADHESIVES

### CAVEX LIQUID ALGINATE ADHESIVE

*Cavex alginate adhesive improves the adhesion between the impression tray and alginate*

- For use with alginate impression material on both metal and resin trays
- Every bottle cap has a small brush making it easier to apply adhesive
- Over 50 applications per bottle

Supplied as 2 x 14ml bottles

CAAB010 Cavex alginate adhesive



### REDIFIX SPRAY ADHESIVE

*Ensures positive retention when used with all types of alginate impression materials or trays*

- Supplied as a 200ml spray can

WRADHESP Redifix alginate spray adhesive



## SILICONE ADHESIVES

### PANASIL ADHESIVE

*Panasil® adhesive ensures adequate adhesion between the impression tray and A-silicone impression tray material*

Panasil® adhesive can be used with all A-silicone-based tray materials.

- Good visual control
- Easy to apply
- Rapid evaporation time

Supplied as a 10ml bottle

KT14101 Panasil adhesive



### KERR VPS SILICONE TRAY ADHESIVE

*VPS adhesive is an impression tray adhesive for addition silicones*

- Supplied as a 60ml bottle

KR25777 Kerr VPS silicone tray adhesive





CAVEX

# Let us impress you with the Cavex Cream Alginate

5µm  
High detail  
reproduction

Dust  
Free

Scannable

Smooth  
creamy  
consistency

Rapid  
water  
absorption

Bubble  
gum  
flavour



## CAVEX CREAM ALGINATE

### CAVEX YOUR IMPRESSION IS OUR CONCERN

Cream Alginate is the latest generation of alginate from Cavex, the world's leading manufacturer of high quality alginates. Cavex Cream Alginate boasts an impressive fine 5µm reproduction, a level commonly found only in silicone impression materials. Thanks to Cavex Cream Alginate's rapid absorption of water the alginate mixes into a smooth creamy consistency. Cavex Cream Alginate incorporates all the other high quality essential features you expect from Cavex alginates including high tear strength & high elasticity, bubble free consistency and 5 year shelf life.

# Impression Materials

## ALGINATE ACCESSORIES

### STORAGE CONTAINERS

- For storing alginate
- Available in blue or pink

CAAT240 Blue storage container  
CAAT260 Pink storage container



### PLASTIC WATER MEASURE AND SCOOP

CAALGPLM Plastic water measure and scoop



### CAVEX WATER DOSING BOTTLE

- Water is at room temperature ensuring a constant setting time
- Accurate water dosing by simply squeezing the bottle

CAAT2021 Water dosing bottle



### DEIONISED WATER

- Supplied as a 5 litre bottle

GEWATER Deionised water



### CAVEX MIXING BOWL AND SPATULA

CAAT041 Cavex mixing bowl - blue (approx size 12.5cm width/top)  
CAAT042 Mixing spatula - plastic



### FLEXIBLE MIXING BOWLS

LAMIXBOWL3 Large D3 bowl



LAMIXBOWL4 Jumbo D4 bowl



## IMPRESSION PREPARATION

### ORTHOSKAVIDENT C

*Orthoskavident C is an application liquid for cleaning and drying prepared cavities and teeth*

It can be used for all external applications in the dental practice that require a clean, grease-free surface eg., removing the smear layer on the surface of prepared teeth before taking impressions, fitting fixed restorations or placing fillings, replacement or repair of a damaged veneer intraorally, sealing of teeth, bonding brackets in orthodontics etc.

Supplied as a 150ml bottle

KT13063 Orthoskavident C



## ALGINATE ALTERNATIVES

### SILGINAT

*Ideal for anatomical impressions*

Medium viscosity, elastomer A-silicone with an alginate-like consistency, specially developed for the opposing jaw, temporary crowns/bridges and for the fabrication of splints.

#### Advantages

- Opposing jaw impressions on an A-silicone base
- High dimensional stability, very thixotropic, high flowability
- Impression is stable when stored
- Can be poured several times, even after a long storage time
- Scannable for use in CAD/CAM systems with optimum reproduction values



Available in 50ml refills and 380ml (jumbo) cartridges

KT13846 Silginat 50ml cartridge pack (1:1)  
*includes 6 x 50ml cartridge + 6 mixing tips*

KT14712 Silginat intro pack (5:1)  
*includes 1 x 380ml cartridge, 10 dynamic jumbo mixing tips + 4 multi trays*

KT14713 Silginat refill pack  
*includes 2 x 380ml cartridges (760ml)*

### ALGINOT™

*Cost-effective, reliable alginate alternative*

This high-quality impression material delivers exceptional accuracy and performance.

#### Indications

Suitable for impressions in preparation of case study models, orthodontic models, opposing models, simple removable dentures, removable retainers and splints, provisional crown and bridge, and dental impressions.

- No hand mixing which eliminates cleanup - saving time and material
- You can pour immediately or when it's convenient
- Impressions retain dimensional stability for months
- Can be disinfected
- Peppermint scent



KR33034 Alginot intro kit  
*includes 6 x 50ml cartridges + 12 mixing tips*



# Impression Materials

## BITE REGISTRATION

### FUTAR & FUTAR D FAST

*Syringeable, elastomer, addition-curing silicone bite registration material with high final hardness for recording the occlusal relationship*

#### Advantages

- Addition cured silicone material
- Thixotropic with controlled flow properties
- Extra quick working time of 15 seconds
- Extra fast intraoral setting time of 45 seconds



Supplied as 2 x 50ml cartridge + 12 mixing tips

KT11926 Futar Fast - high final hardness of Shore A-90

KT11961 Futar D Fast - extra high final hardness of Shore D-43

### CAVEX SILICON-A BITE

*Vinyl polysiloxane bite registration*



- Scannable
- Superior hardness of Shore D 40
- Working time and setting time of 30 seconds, total time 1 minute
- Highly thixotropic; stays exactly where you want it to be
- Easily distinguishable lavender colour
- Easy to trim with a scalpel or bur

Supplied as 2 x 50ml cartridge with 12 x mixing tips + 12 x (wide) bite registration tips

CABITE Cavex SiliconA Bite

### REGISTRADO X-TRA

*Extra hard, fast and flexible bite registration A-silicone*

#### Advantages

- Optimised final hardness
- Allows application without time pressure
- Highly thixotropic qualities
- Good grinding properties
- Very precise impressions



Supplied as 2 x 50ml cartridges + mixing tips (type 16) + intraoral tips (type 2)



VO2035 Registrado X-tra

### TAKE 1 ADVANCED BITE REGISTRATION

*Vinyl polysiloxane (VPS) material designed for making accurate inter occlusal records*

- Easy to trim with a scalpel or bur
- Accurate
- Excellent dimensional stability
- High final hardness (85A)
- Setting time 55 seconds



Supplied as a 2 x 50ml cartridge + 6 large mixing tips + 6 bite registration intraoral tips

KR33975 Take 1 Advanced bite registration

## CLEAR BITE REGISTRATION

### MEMOSIL® 2

*Transparent A-silicone for special indications*

- Transparent registration material enables a visual check
- It allows filling and bonding materials to be cured through Memosil 2 using visible light curing
- Sets in 3 minutes
- Does not break or tear
- Neutral taste and odour
- For special indications in implantology and orthodontology
- Shore hardness - 78 Shore A



Implantology



Orthodontology

Supplied as 2 x 50ml cartridges + 12 mixing tips



KL50035018 Memosil 2

### REGISTRADO CLEAR

*Transparent, fast setting, addition-cured bite registration material*



#### Advantages

- High final hardness combined with high transparency
- Convincing material consistency, ensures adherence to the row of teeth
- Work without time pressure thanks to temperature-controlled curing process (accelerated curing starts only when mouth closed)
- High dimensional and shape stability (>99%)
- Light-curing can be carried out perfectly

Supplied as 1 x 50ml cartridge + mixing tips (type 16) + wide intraoral tips (type 2)

VO2037 Registrado Clear

# Impression Materials

## CROWN & BRIDGE SILICONES

### PANASIL MONOPHASE MEDIUM

#### (Monopren Transfer)

*Panasil monophase medium is a medium viscosity, elastomer, syringeable monophase impression material on an A-silicone base*

The high final hardness of Panasil monophase medium makes it ideal for pick-up impressions with fixed/ removable prosthetic restorations and in implantology.

It is also indicated for taking impressions for fabricating crowns/ bridges, inlays/onlays and veneers due to its pronounced initial hydrophilicity.

- Thixotropic with controlled flow properties
- Low contact angle of less than 10°
- Working time of 2 minutes
- Fast setting time of 2 minutes
- Hard final hardness of Shore A-60
- Can be used in conjunction with a light body material



- KT13501 Panasil monophase medium normal pack Regular set (1:1) - 2 x 50ml cartridges + 6 mixing tips
- KT14708 Panasil monophase medium intro pack Regular set (5:1) - 1 x 380ml cartridge + 10 dynamic mixers
- KT14709 Panasil monophase medium refill pack Regular set (5:1) - 2 x 380ml cartridges

### PANASIL TRAY (Heavy Body)

*Panasil® tray is a high viscosity, addition-curing, precision impression material on a vinyl polysiloxane base*

- Dimensionally accurate elastic recovery
- Easy, reliable removal from the mouth
- Easy, hygienic mixing at the press of a button in the practical 380ml jumbo cartridge or in the conventional 50ml cartridge
- **Fast set:** working time 1 minute, intraoral setting time 2 minutes
- **Soft:** reduced final hardness for even easier removal from the mouth, working time 2 minutes, intraoral setting time 2 minutes



- KT14704 Panasil Tray Fast Heavy intro pack - 1 x 380ml
- KT14705 Panasil Tray Fast Heavy refill pack - 2 x 380ml



- KT14706 Panasil Tray Soft Heavy intro pack - 1 x 380ml + 10 dynamic mixing tips
- KT14707 Panasil Tray Soft Heavy refill pack - 2 x 380ml
- KT13561 Panasil Tray Soft Fast Heavy refill pack - 2 x 50ml

### PANASIL PUTTY - Fast and Soft

*Panasil® Putty is a kneadable, addition-curing, elastomeric precision impression material based on vinyl polysiloxane, quick setting*

Available as Putty Fast or Putty Soft

- Good elastic properties
- Non-sticky
- Easy to knead
- **Putty Soft:** working time 2 minutes, intraoral setting time 2 minutes
- **Putty Fast:** working time 1 minute 30 seconds, intraoral setting time 2 minutes



Panasil Putty Fast



Panasil Putty Soft

Each set contains  
1 x 450ml catalyst  
1 x 450ml base  
2 x dispensing scoops

- KT11121 Panasil Putty Soft
- KT11141 Panasil Putty Fast

### PANASIL BINETICS PUTTY - Soft

*Panasil® binetics Putty for jumbo mixing machines*

- Dimensionally accurate elastic recovery and easy, reliable removal from the mouth
- Easy, hygienic mixing at the press of a button in the practical 380ml jumbo cartridge
- Reduced final hardness for even easier removal from the mouth
- Working time 2 minutes, intraoral setting time 3 minutes



- KT14702 Panasil Binetics Putty Soft intro pack (5:1) - 1 x 380ml + 10 dynamic mixing tips
- KT14703 Panasil Binetics Putty Soft refill pack (5:1) - 2 x 380ml

# Impression Materials

## PANASIL INITIAL CONTACT (Light Body)

*Panasil® initial contact is a light body addition-curing, precision impression material on a vinyl polysiloxane base with a very high initial hydrophilicity*

Ideal in combination with Panasil® heavy body, medium body or putty tray materials.

- Exceptional initial hydrophilicity from the first second
- Pronounced flowability and highly thixotropic
- Dimensionally accurate elastic recovery
- Easy, reliable removal from the mouth
- Working time 1 minute, intraoral setting time 2 minutes

Each supplied as 2 x 50ml cartridge and 12 mixing tips



X-Light



Light



Regular



- KT13461 Panasil Initial Contact - X-light fast set
- KT13471 Panasil Initial Contact - light fast set
- KT13481 Panasil Initial Contact - regular fast set

## FIT TEST® C & B

*Addition-curing silicone material for checking of prosthetic reconstructions*

### Indications

- Control of precision of fit, marginal adaptation and marginal gaps of:
  - full or partial crowns as well as bridges
  - inlays/onlays
  - cast post abutments / post crowns
  - metal denture bases
  - implant-supported crowns and bridges
  - attachments and other secondary parts of dentures



### Advantages

- Fast diagnostic help for all restorative pieces
- QuickMix syringe for simple handling
  - automatic bubble-free mixing
- Direct application
- Optimal colour for metal and ceramic restorations
- Fast results due to short working and setting time

Supplied as a 5ml syringe + accessories



- VO2095 Fit Test® C&B QuickMix syringe

## TAKE 1™ ADVANCED™ VPS

*Vinyl polysiloxane (VPS) impression material*

- **Outstanding tear strength and elongation.** Strong, flexible impression material stretches around undercuts without tearing or distorting.
- **Hydrophilic dental wash material.** Displaces intraoral fluids to produce impressions with great detail and no voids or gaps.
- **Excellent dimensional stability.** Impression will not distort due to dimensional change or temporary deformation.
- **Widest selection of viscosities, set times and delivery methods.** Helps overcome common difficulties in impression taking, and matches doctor preference.



### Take 1 Advanced - light body wash

Supplied as a 2 x 50ml cartridge + 6 large mixing tips  
 KR33951 Two-pack light - regular set (orange)  
 KR33953 Two-pack light - fast set (orange)

### Take 1 Advanced - medium body wash

Supplied as a 2 x 50ml cartridge + 6 large mixing tips  
 KR33959 Two-pack medium - fast set (light blue)  
 KR33969 Two-pack regular - regular set (light green)

### Take 1 Advanced - heavy body tray material

Supplied as a 2 x 50ml cartridge + 6 large mixing tips  
 KR33963 Tray regular set (dark blue)  
 KR33965 Tray fast set (dark blue)  
 KR33967 Tray super fast set (dark blue)



### Take 1 Advanced - heavy body volume tray

Supplied as 2 x 380ml cartridges  
 KR34695 Volume tray heavy body - regular set  
 KR34696 Volume tray heavy body - fast set



### Take 1 Advanced Putty

Supplied as 1 x base (400g) + 1 x catalyst (400g)  
 KR34070 Take 1 Advanced Putty - 2 x 400g

# Impression Materials

## MIXING TIPS

### ORAMIX MIXING TIPS

#### Green Tips

*For mixing medium and heavy body impression materials*

Suitable for use with most brands

- 6.5mm wide x 87.8mm long

SGORAMIXG Mixing tips, green - packet of 50



Oraltec  
private label

#### Yellow Tips

*For mixing light body impression materials*

Suitable for use with most brands

- 4.2mm wide x 70mm long

SGORAMIXY Mixing tips, yellow - packet of 50



### CAVEX MIXING TIPS

- Supplied as a packet of 48

CAAS94 Light body - yellow

CAAS95 Heavy body - green



### KETTENBACH MIXING TIPS

KT17234 Heavy/medium body - green - packet of 100

KT17900 Dynamic jumbo mixing tips - packet of 50



### VOCO MIXING TIPS

- Supplied as a packet of 50

VO2196 Mixing tip green type 16



## INTRAORAL TIPS

### ORAMIX INTRA ORAL TIPS

#### White Tips

*Ideal for use with monophasic technique*

Intra oral tips to fit SGORAMIXTG (green) tips

- Tip 23.9mm long

SGS116 Intra oral tips, white - packet of 50



Oraltec  
private label

#### Yellow Tips

Intra oral tips to fit SGORAMIXTY (yellow) tips

- Fits mixing tips 4.2mm wide

- Tip 23.9mm long

SGS115 Intra oral tips, yellow - packet of 50



### CAVEX INTRA ORAL TIPS

- Supplied as a packet of 96

CAAS96 Intra oral tips - yellow

CAAS97 Intra oral tips - white



### KETTENBACH INTRA ORAL TIPS

- Supplied as a packet of 96

KT17221 Intra oral tips - white

KT17222 Intra oral tips - yellow



### VOCO INTRA ORAL TIPS

- Supplied as a packet of 50

VO2140 Intra oral tip (wide), type 2



## DISPENSERS



KT17203

CAAS70

KT17203 Kettenbach Applifix 4 dispensing gun 2:1 or 1:1

CAAS70 Cavex dispensing gun 1:2 or 2:1 each

KT17204 Kettenbach Applifix 5 - suitable for all syringeable impression materials includes 2 x plastic application syringes, 12 syringe tips + accessories



## IMPRESSION TRAY CLEANERS

### CAVEX GREEN CLEAN

*The pH neutral alginate remover*

- Removes alginate and gypsum from impression trays, spatulas and other instruments
- 100% biodegradable - it can be poured safely down the sink
- Fast working and harmless to metal trays
- Economical - 1kg will clean approximately 500 impression trays
- Fresh lemon aroma

Supplied as a 1kg tub

CAHA001 Cavex Green Clean



### TRAYPUROL® TABLETS

*Active-tabs for cleaning impression trays and instruments*

- Removes alginates and cements within a short amount of time
- No vigorous stirring necessary
- Tabs automatically dissolve when placed in water
- Suitable for all rustproof metals (including aluminium) and plastics
- Biodegradable and pH-neutral
- Can be used in ultrasonic baths

Supplied as a box of 50 tablets

VO2355 Traypurol® tabs



### TRAYPUROL® LIQUID

*Concentrated cleaning agent for impression trays and instruments*

- Simply dilute in water
- Removes residues of alginates, zinc oxide eugenol, glass ionomer, carboxylate and phosphate cements
- Cleans trays and instruments reliably overnight
- Can be used in ultrasonic devices
- Suited also for non-oxidising metals and plastic
- Biodegradable and gentle

Supplied as a 1 litre bottle

VO2289 Traypurol® liquid



# Impression Materials

## IMPRESSION DISINFECTANTS

### CAVEX IMPRESAFE

Highly concentrated disinfectant for all alginate, polyether and silicone impressions

- Fast and efficient - 3 minute contact time
- Concentrate - 1 litre of product = 33 litres of disinfectant
- Safe - 100% aldehyde-free, non-toxic formulation, neutral smell
- Change once a week

CAHA053 Cavex Impresafe Starter Kit  
(Kit includes 1 litre Impresafe liquid, a disinfection container, shipping bag, timer and protocol for use)

CAHA050 Cavex Impresafe 1 litre refill bottle  
CABAG Impression plastic shipping bags - packet of 50  
CATANK Cavex Impresafe soak tank



### IMPRESAFE DISINFECTING SPRAY

Liquid for effective disinfection of impressions, dentures, etc.

- Supplied as a 750ml spray bottle

UNIMPRESAFE Impresafe disinfecting spray



## SPECIAL TRAY MATERIAL

### CAVEX LIGHT CURE TRAY MATERIAL

For the fabrication of individual and functional impression trays

- Pink opaque colour
- Large sheets for better use with dentate jaws
- Dimensionally stable after curing
- Only one sheet model for upper and lower
- Cures in 3 - 5 minutes with halogen or UV
- Light curing and cures on demand
- 3 years shelf life

CABP010 Cavex LC tray material



### PRECI TRAY MATERIAL

Light curing tray material (ideal for use with Preci Light)

- Fits the upper and lower jaws
- Easy to adapt to the model
- Sheet size: 70 x 100 mm
- Thickness: 2.2 mm
- Packet of 50



YE8901000 Preci Tray - pink  
YE8901010 Preci Tray - blue  
YE8901020 Preci Tray - white



For more details on Preci Light, light curing box (for special trays and base plates), please refer to LABORATORY PRODUCTS, page 95

### INDIVIDIDO® LUX

For the fabrication of individual trays from contoured plates for maxillae and mandibles



#### Advantages

- Stable trays
- Pleasant mint flavour
- Non-sticky consistency
- Light-cured with standard halogen light or UVA lights

Available in blue transparent or blue opaque colour

Supplied in packets of 50 pieces

VO240\_ Individido® Lux maxillae - specify colour  
VO240\_ Individido® Lux mandibles - specify colour

## LABORATORY PUTTY

### PROTESIL LABOR PUTTY

Laboratory Silicone Putty with high final hardness

#### Advantages

- Highly resistant to curing temperatures of heat curing resins without deformation
- Dimensionally stable

VA057005 Protesil Labor putty 2kg tub

VA057007 Protesil Labor catalyst 60ml tube



### GIROFORM PUTTY

Silicone putty for placing and blocking the mould on the mould carrier, saves plaster as well as subsequent trimming and grinding

- Pleasant lemon fragrance
- Great time savings as a result of quick blocking
- Saves plaster and therefore increase the cost-effectiveness
- No subsequent trimming or grinding required
- Reusable

AM576461 Giroform putty - 1kg

AMANN GIRRIBACH



### PALA LAB PUTTY 90

High definition laboratory A-silicone putty material

Designed for accurate and fast working in dental laboratories. The easy 1:1 mixing guarantees high fitting accuracy and exact reproduction of details.

#### Advantages

- Easy to mix in 1:1 ratio
- Fast setting time (6 minutes)
- High reproduction of details (20µm)
- Good tear resistance
- Shore hardness A90
- Dimensionally stable over time (<0.05% after 24 hours)
- Resistant to standard polymerisation temperatures
- Simple dosing with included spoons

Supplied as 1 x 1.5kg base and 1 x 1.5kg catalyst

KL66057432 Pala Lab Putty 90 (base + catalyst)



# Infection Control Products

## AUTOCLAVE POUCHES & REELS

### SELF-SEALING POUCHES

- Triple sealed
- Easy to open
- 8 sizes available
- One-side clear film
- One-side medical grade paper
- Once sterilised, the arrow changes colour



Medipack®

#### For multiple small items

MUAUTO355 3½ x 5¼" (90 x 135mm) - packet of 300

#### For handpieces and hand instruments

MUAUTO275 2¾ x 9" (70 x 230mm) - packet of 300

MUAUTO359 3½ x 9" (90 x 230mm) - packet of 300

#### For burs, implants and clamps

MUAUTO225 2¼ x 4" (60 x 100mm) - roll of 500

#### For multiple instruments

MUAUTO49 4 x 9" (100 x 230mm) - packet of 200

MUAUTO525 5¼ x 10" (135 x 254mm) - packet of 200

MUAUTO12 12 x 15" (300 x 365mm) - packet of 200

#### For cassettes

MUAUTO725 7½ x 13" (190 x 330mm) - packet of 200

**BULK RATE: Purchase ANY 5+ boxes and receive a 15% discount**

### PEELVUE+ STERILISATION POUCHES

*Featuring patented internal multiparameter indicators and patented 'closure validators' (to create a proper seal)*

- Made with easy to peel and seal and printed with lead-free inks on medical-grade, non-recycled paper
- Each box contains 200 pouches

- KR31610 3½ x 5¼" (red)
- KR31611 2¾ x 9" (green)
- KR31612 3½ x 9" (orange)
- KR31613 2¼ x 4" (silver)
- KR31616 3¼ x 12" (purple)
- KR31617 4¼ x 12" (gold)
- KR31614 5¼ x 6½" (blue)
- KR31619 5¼ x 12" (brown)
- KR31618 8 x 12" (black)
- KR31615 8½ x 15" (pink)

Kerr



### AUTOCLAVE REEL

- One-side clear film for easy identification of contents
- One-side medical grade paper suitable for steam
- With sterilisation indicators

Size 75mm x 200m roll

MUFR075200 Autoclave reel

Medipack®



### AUTOCLAVE INDICATOR TAPE

- Specially formulated adhesive tape
- White indicating lines turn black after sterilisation

Medipack®

Size 25mm x 55m roll

MUSTR2555 Autoclave indicator tape



## BIBS & BIB HOLDERS

### BLUE PLASTIC PATIENT BIB

- Velcro fastening with a shallow front pocket
- 435mm wide x 550mm long
- Sold individually



WRBIBBLUE Blue plastic patient bib

### BIBS 4PLY

- White, plastic backed bibs
- 4 ply
- Size: 20 x 30cm
- Sold as a carton of 1,000 (4 bundles x 250 sheets)



TO2150779 4ply plastic backed bibs

### BIBS 3PLY

- Blue, plastic backed bibs
- 3 ply (2 paper ply, 1 PE ply)
- Size: 45 x 32cm
- Supplied in a box of 500



LAC42AZ 3ply plastic backed bibs

### BIB HOLDERS

- Available in metal and plastic
- Sold individually



- RA129 Red metal holder
- RA130 Blue metal holder
- RA134 White metal holder



- RA135 Red plastic holder
- RA136 Blue plastic holder
- RA140 White plastic holder



RA587 Autoclavable metal holder



### BIB-EZE DISPOSABLE BIB HOLDERS

*Single use disposable bib holders*

Bib-Eze disposable bib holders are lightweight, stretchable paper holders that attach to the dental napkin bib with easy to peel, self-adhesive ends, which can easily be removed after the procedure.

- Supplied as a box of 250



Kerr



KR35053 Bib-Eze disposable bib holders

### REUSEABLE BIB HOLDERS "SLIP-NOTS"

*The extra wide neck band prevents bib from sliding out of place*

- Available individually in blue, pink, green and violet or as an assorted pack of 4

- KRBIBB Slip-Nots blue
- KRBIBP Slip-Nots pink
- KRBIBG Slip-Nots green
- KRBIBV Slip-Nots violet
- KR2000A1 Slip-Nots assorted pack (one of each colour)



Kerr



# Infection Control Products

## HAND CLEANING

### DERMOCOL WASH

*Formulated for frequent hand washing prior to the use of an alcohol based hand disinfectant*

A mild, efficient pH neutral soap for frequent hand washing without irritation even on sensitive skin

- pH neutral (ideal for sensitive skin)
- Soap free
- Contains emollients to protect the skin from the drying effect of water
- Lightly perfumed
- Excellent skin tolerance
- Supplied as a 500ml bottle with pump



**UNIDENT**  
SWISS

UN1704247 Dermocol Wash

### FOAM SOAP (for use in dispensers)



#### Tork Premium Extra Mild Foam Soap S4

- No perfume, colour or sulphate
- Not irritating to eyes
- Supplied as a 1 litre bottle



TO520701 Extra mild foam soap S4  
TO561500 Soap dispenser S4, white

#### Tork Premium Luxury Foam Soap S3

- For use with modern aluminium sensor dispenser
- Moistening formula produces rich lather
- Cost saving as one portion sufficient to wash hands
- Supplied as an 800ml box



TO500902 Luxury foam soap S3  
TO561500 Soap dispenser S3 sensor, white

### LIQUID SOAP (for use in dispensers)



#### Tork Premium Soap S1 (Perfumed)

- Perfect for all normal hand washing
- Cleans and actively conditions the skin with a skin friendly, mild formulation
- Awarded Nordic ecolabel
- NZFSA accredited
- Supplied as a 1 litre bottle



TO420501 Premium soap S1 perfumed  
TO560000 Soap dispenser S1, white

#### Tork Premium Soap S1 Extra Hygiene

- Perfect to use in hygiene sensitive environments
- Highly effective against bacteria and approved according to European Norms (EN 1040 and EN 1499)
- Perfume and colour free, minimises the risk for allergic reactions
- NZFSA accredited
- Supplied as a 1 litre bottle



TO420810 Premium soap S1, extra hygiene  
TO560000 Soap dispenser S1, white

## HAND SANITISER / DISINFECTION

### DERMOCOL GEL

*A ready to use, hydro alcoholic thixotropic gel for hygienic and surgical hand disinfection*

**UNIDENT**  
SWISS

Contains protective substances which moisturise your hands and preserve the skins natural pH.

- Ethanol based gel
- Contact time : 30 seconds (hygienic treatment)
- Non-sticky formulation
- Ideal for frequent use
- Moisturising, prevents drying
- Excellent spectrum of efficacy\*



Available in two fragrances - almond (silk) and mint (new)

UN2307247 Dermocol Gel Silk (clear/almond) - 500ml with pump  
UN1706247 Dermocol Gel New (blue/mint) - 500ml with pump

*\*Efficacy - Bactericide, Mycobacterium terrae, MRSA, Candida albicans, HIV-1, PRV (Surrogate of Hepatitis B), BVDV (Surrogate of Hepatitis C), Herpes virus, Rotavirus, Adenovirus, Poliovirus, Norovirus, Coronavirus (Surrogate of SARS), Influenza virus H1N1*

## IMPRESSION DISINFECTANTS

### CAVEX IMPRESAFE

*Highly concentrated disinfectant for soaking all alginate, polyether and silicone impressions*

- Fast and efficient - 3 minute contact time
- Concentrate - 1 litre of product = 33 litres of disinfectant
- Safe - 100% aldehyde-free, non-toxic formulation, neutral smell
- Change once a week

CAHA053 Cavex Impresafe Starter Kit  
*Starter kit contains 1 litre Impresafe liquid, a disinfection container, shipping bag, timer and protocol for use*  
CAHA050 Cavex Impresafe 1 litre refill bottle  
CABAG Impression plastic shipping bags - packet of 50  
CATANK Cavex Impresafe soak tank



**CAVEX**

### IMPRESAFE DISINFECTING SPRAY

*Liquid for effective disinfection of impressions, dentures, etc.*

- Supplied as a 750ml spray bottle

**UNIDENT**  
SWISS

UNIMPRESAFE Impresafe disinfecting spray

## WATER DISTILLER CLEANER

### WATER DISTILLER CLEANER

*Distiller descaler and cleaner*

- Supplied as a 480g tub

WADISCLEAN Water distiller cleaner



# Infection Control Products

## INSTRUMENT CLEANING & DISINFECTION

### MICRO 10 PLUS

*Instrument cleaner and disinfectant*

- Economical 2% dilution (20ml per litre water)
- Contact time 15 minutes
- Contains corrosion inhibitors to protect instruments against rusting
- CE marked - complies with Medical Devices Directive 93/42/EEC
- Odourless, pale yellow colour
- Renew the solution 2-3 times a week, minimum once a week



**UNIDENT**  
SWISS

*Efficacy: Bactericide, Mycobacterium tuberculosis (Tb), Candida albicans, HIV-1, PRV (Surrogate of Hepatitis B), BVDV (Surrogate of Hepatitis C), Herpes virus*

UN1625537	Micro 10 Plus - 1 litre
UN1625558	Micro 10 Plus - 2.5 litres
UN1625540	Micro 10 Plus - 5 litres

### MICRO 10 ENZYME 2

*Powerful, tri-enzymatic aldehyde-free concentrated solution, for pre-sterilisation disinfection and cleaning of all dental and surgical instruments*

Micro 10 Enzyme 2 has a broad spectrum of efficacy and a high level of detergency. The enzymatic activity safely reduces proteins in to amino acids, breaks down sugars and acts on complex substrates including polysaccharides.

- Very economical: 1% dilution (1litre provides 100 litres of diluted solution)
- 3 enzymes – protease, amylase and mannanase
- Rapid action, effective from just 5 minutes
- Proven efficacy against all enveloped viruses
- Chloride free and contains corrosive inhibitors to protect instruments
- Compatible with all types of material
- Suitable for use in ultrasonic cleaners
- Diluted product not classified as dangerous to the environment
- Citrus fragrance
- CE marked – complies with Medical Devices Directive 93/42/EEC



**UNIDENT**  
SWISS

*Efficacy: Bactericide, Tuberculocide, Candida albicans, HIV-1, PRV (Surrogate of Hepatitis B), BVDV (Surrogate of Hepatitis C), Herpes virus, Vaccinia virus*

UN2472773	Micro 10 Enzyme2 - 1 litre
UN2472778	Micro 10 Enzyme2 - 2.5 litres
UN2472433	Micro 10 Enzyme2 - 5 litres

## ULTRASONIC CLEANERS

### ULTRASONIC CLEANERS

*Sonoswiss Ultrasound with powerful piezo-transducer systems and microprocessor-controlled generators*

- 3 setting options:
  - a) Sweep - for the even distribution of the ultrasonic power in the bath
  - b) De-gas - for the quick de-gassing before cleaning
  - c) Boost - for additional power
- Drain on the 5.75 litre model (SW6H) for easy emptying
- Cover for noise reduction or to be used as dripping tray for the wet cleaning basket
- Both ultrasonic cleaners include plastic lids and stainless steel baskets
- Made in Switzerland

**SONO SWISS**  
High Quality Ultrasonic Systems



SW6H model



SW3 model

SN100317	Ultrasonic cleaner SW3 - 3 litre
SN100333	Ultrasonic cleaner SW6H - 5.75 litre

## INSTRUMENT CLEANING

### MICRO 10 POWER CLEAN

*Instrument cleaner only - for ultrasonic cleaners*

- Very economical 0.5% dilution (5ml per litre water)
- Effective from just 1 minute
- Proven efficiency on biofilm in 5 minutes
- Easy rinsing
- Medical Device Class I (Directive 93/42/EEC modified)
- Odourless, blue colour
- Renew the solution daily

**UNIDENT**  
SWISS

UN2262558	Micro 10 Power Clean 2.5 litres
-----------	---------------------------------



## SOAKING TANKS

### DISINFECTION TRAY

- For instruments and larger items
- Tray handle stays dry
- Holds 1.25 litres



LAG11	Disinfection tray tank G11
-------	----------------------------

### DISINFECTION SOAK TRAY/TANK

- 3 litre with basket

**UNIDENT**  
SWISS

UNTRAY	Disinfection soak tray/tank 3L
--------	--------------------------------



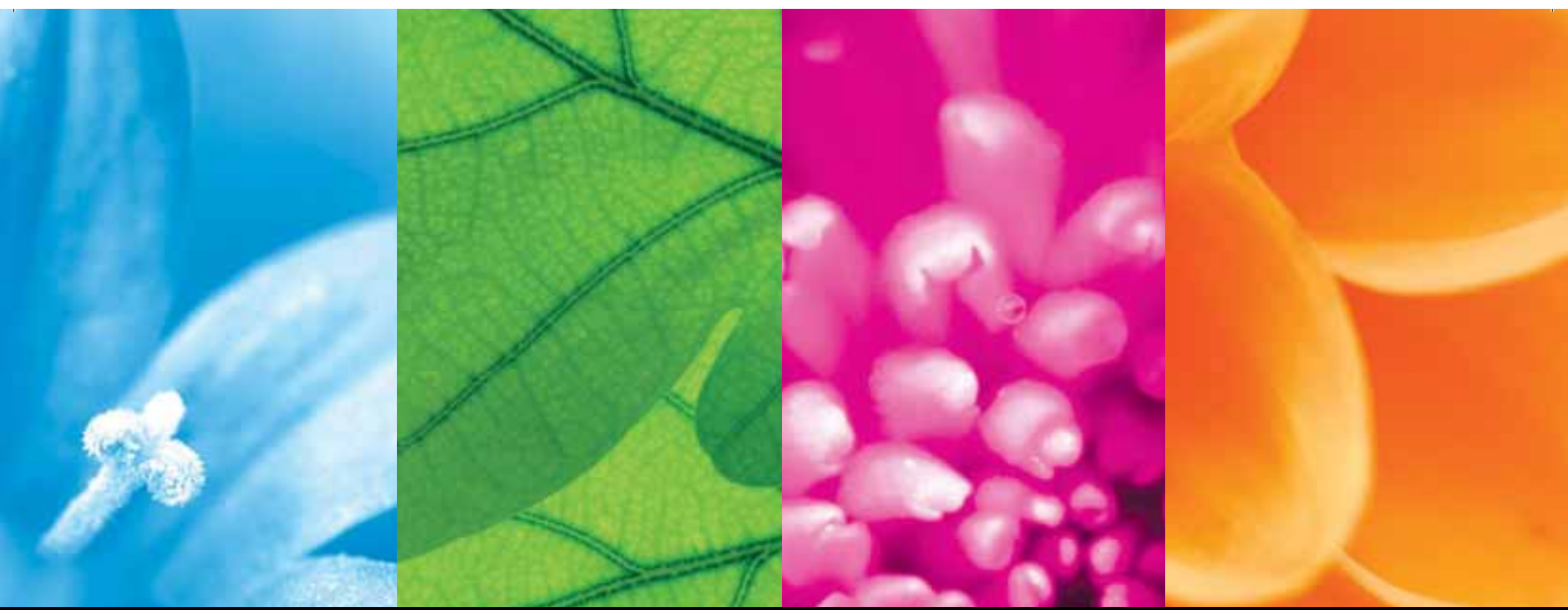

# Protection 4U

A NEW GENERATION

Swiss quality is at the heart of the Unident range of products for hygiene and disinfection. This quality philosophy is a guarantee of unprecedented protection for you, your staff and your patients. All Unident products are designed and developed with respect to the people who use them and to the environment.



Photos non-contractual - 03/2017



[www.usfhealthcare.com](http://www.usfhealthcare.com)

USF Healthcare S.A.

Rue François Perréard 4 | CH-1225 Chêne Bourg | Geneva | Switzerland  
Tel + 41 22 839 79 00 | Fax + 41 22 839 79 10 | [info@usfhc.com](mailto:info@usfhc.com)



**A Mark of Confidence!**

# Infection Control Products

## BUR DISINFECTION BOXES

### BUR DISINFECTION BOX

*Sterilisable box for disinfecting burs*

- Lift out basket makes handling easy
- Hole in the lid allows bur to be dropped in with lid on

LAG5

Bur box G5



### ROUND BUR/ENDO DISINFECTION SOAK TANK

*Plastic container for presoaking burs*

- With internal filter

UN404050

Round bur/endo tank

**UNIDENT**  
SWISS



## SURFACE CLEANING & DISINFECTION

### UNISEPTA FOAM 2 WIPES

*Ready-to-use alcohol-free wipes for the rapid disinfection and cleaning of medical devices*

- Impregnation solution formulated without alcohol
- Contact time : 1 – 5 minutes
- Made from 100% biodegradable viscose
- Non-perfumed
- Ideal for alcohol sensitive materials including the dental chair
- Wipe size: 180 x 200mm
- CE marked – complies with Medical Devices Directive 93/42/EEC
- VAH/DGHM certificated
- 100 wipes per pack
- Supplied in a soft packet

*Efficacy of impregnation solution:*

*Bactericide, MRSA, Candida albicans, PRV (Surrogate of Hepatitis B), BVDV (Surrogate of Hepatitis C), Rotavirus, HIV-1, Herpes virus, Vaccinia virus, RSV Influenza virus H1N1*

UN2476655

Unisepta Foam 2 wipes

**UNIDENT**  
SWISS



### UNISEPTA FOAM 2 SPRAY

*Ready-to-use alcohol-free disinfection and cleaning foam for surfaces*

Unisepta Foam 2 is particularly suitable for areas that are sensitive to alcohol, including the upholstery of the dental chair.

Unisepta Foam will preserve the natural suppleness of such surfaces preventing drying, cracking or peeling.

- Contact time : 1 – 5 minutes
- Formulated without alcohol
- Excellent material compatibility
- Fresh orange fragrance
- Leaves no residue or smearing
- CE marked – complies with Medical Devices Directive 93/42/EEC
- VAH/DGHM certificated

*Efficacy: Bactericide, MRSA, Candida albicans, PRV (Surrogate of Hepatitis B), BVDV (Surrogate of Hepatitis C), Rotavirus, HIV-1, Herpes virus, Vaccinia virus RSV, Influenza virus H1N1*

UN1702241

Unisepta Foam 2 spray - 750ml spray bottle

UN2458539

Unisepta Foam 2 bottle - 5 litre refill

**UNIDENT**  
SWISS



## SURFACE DISINFECTION

### UNISEPTA PLUS

*A high quality, ready to use, alcohol based solution for the rapid disinfection of surfaces of medical devices*

- Rapid action
- Contact time : 30 seconds
- Excellent spectrum of efficacy
- Leaves no residue or smearing
- Fresh citrus fragrance
- CE marked – complies with Medical Devices Directive 93/42/EEC
- VAH/DGHM certificated

*Efficacy: Bactericide, Mycobacterium terrae, MRSA, Candida albicans, HIV-1, PRV (Surrogate of Hepatitis B), BVDV (Surrogate of Hepatitis C), Herpes virus, Rotavirus, Adenovirus, Coronavirus (Surrogate of SARS), Influenza virus H1N1*

UN1529648

Unisepta Plus - 750ml spray bottle

UN1529539

Unisepta Plus - 5 litre refill

**UNIDENT**  
SWISS



### UNISEPTA PLUS WIPES

*High quality, rapid acting, alcohol-based wipes for cleaning and disinfection of medical devices*

- Rapid action, ideal between patients
- 30 second contact time
- Dries without trace
- Pleasant scent
- Multi purpose
- Non woven fabric
- 150 wipes per refill pack/tub

UN1529328

Unisepta Plus wipes tub

UN1529774

Unisepta Plus wipes refill

**UNIDENT**  
SWISS



**UNIDENT**  
SWISS

### The USF Healthcare ECOEngage commitment

With almost 50 years' experience, USF Healthcare recognises how its day to day activities can impact on the environment both at a local level and globally.

ECOEngage is a voluntary undertaking by USF to a continual improvement programme in safety and environmental performance, at all levels of their organisation.

This voluntary approach forms part of their integrated management system, Quality, Safety and Environment (QSE)



**ECOEngage**

Our Ecological Engagement

# Infection Control Products

## SUCTION SYSTEM CLEANERS

### VACUCID 2 SUCTION CLEANER

*Disinfection, deodorisation, cleaning and care of all dental suction systems*

Vacucid® 2 dissolves solid debris, eliminates cleaning or changing of the trap. Daily application dissolves solids and keeps suction lines cleaned, disinfected and free from biofilm build up.

- Aldehyde and foam-free
- Dissolves debris
- 5 litre concentrate makes 250 litres

*Efficacy: Bactericide, Mycobacterium tuberculosis (Tb), Candida albicans, HIV-1, HBV, BVDV*

UNVACUCID Vacucid 2 suction cleaner - 5 litres



### Vacucid Systematic Dosing System

*Dosing system used in conjunction with Vacucid suction cleaner*



UNIDENT  
SWISS

UN424051 Vacucid Systematic dosing system

### PULI-JET GENTLE SUCTION CLEANER

*Keeps suction lines clean*

Puli-Jet Gentle is suitable for dental suction systems

Puli-Jet Gentle has a simple and accurate dispensing cup, making it easier to measure

- 1 litre bottle makes 30 x 2.5L solutions

CTM060970 Puli-Jet Gentle suction cleaner



### Cattani Pulse Cleaner Bucket

*Used in conjunction with Puli-Jet Gentle*

CT040720 Cattani Pulse cleaner bucket

CTC040398 Reducer adaptor for tubings to fit Pulse Cleaner



## ANTIFOAMING DISINFECTANT TABLETS

Simply place a tablet in the primary filter at the beginning of the day - whenever fluids pass through the filter, the tablet releases both disinfecting and antifoaming agents.

- Supplied as a packet of 50 tablets



CTM140825 Antifoaming disinfectant tablets

## CATTANI LUBRI-JET DROPS

*Designed to increase the life of rubber and plastic components in the suction system*

- Recommended for use on o-rings, suction terminals, connections and all rubbing surfaces in the suction system
- Especially suited for lubricating articulations of clamps and scissors before placing them in the autoclave
- Supplied as a 4 x 30ml bottles

CTM040727 Lubri-Jet drops



## DISPOSABLE TRIPLEX SYRINGES

### RISKONTROL® SYRINGE TIPS

Due to its unique system, two independent tubes guide air and water of the syringe to the extremity of the tip, ensuring totally dry air free of any trace of humidity; essential for cementing and any operation requiring a completely dry surface.



Riskontrol syringe tips are made from entirely recyclable food quality plastic.



- The RISKONTROL tips are disposable
- The risk of direct or cross contamination is eliminated
- RISKONTROL ensures your patient's and your own protection
- The RISKONTROL range includes almost 70 different adaptors able to equip 145 types of instrument delivery systems
- The adaptor is left permanently in place
- Smooth end of the tips for patient comfort
- RISKONTROL syringe tips are flexible and bendable, they are made from non-shape-memory plastic
- They allow access to the most difficult parts of the mouth, while ensuring good quality spray
- The plastic syringe tip is non-conductive, avoiding thermal exchanges between the tip and the tooth

Supplied as a box of 250 tips

### Classic range

AC201664 Riskontrol - white  
AC201665 Riskontrol - blue



### Art range (coloured and scented)

AC201701 Riskontrol Art - orange/mandarin  
AC201702 Riskontrol Art - grey/liquorice  
AC201703 Riskontrol Art - green/aniseed  
AC201704 Riskontrol Art - purple/blackcurrant  
AC201700 Riskontrol Art - white/mint



- Supplied as a packet of 50 tablets



Please talk to your Oraltec representative about the range of adaptors available



# Infection Control Products

## PROTECTIVE SLEEVES & COVERS

### PINNACLE COMPLETE CURING LIGHT SLEEVES

*Universal, single use, protective plastic sleeve designed to cover the DEMI light curing unit*

New shape vented to maximise the flow of air and keep your curing light cool and ready for the next patient.

- Supplied as a packet of 250

KRDEMI2501 Curing light sleeves for Demi



### PINNACLE CURING LIGHT SLEEVES

*Custom-fitted for the Kerr Demi Ultra LED curing light, with ultra-soft material, and no excessive plastic*

- Supplied as a packet of 100

KRDEMIULTRA  
Curing light sleeves for Demi Ultra



### PINNACLE CURING LIGHT SLEEVES

*Disposable cover for curing light tips*

- Reduces cross-contamination
- Prevents composite from bonding to the end of the tip, which would decrease curing depth
- Supplied as packets of 400

KR45001 Curing light sleeves for 7 & 8mm tips  
KR4511 Curing light sleeve for 11mm tips  
KR4513 Curing light sleeve for 13mm tips



### PINNACLE HEADREST COVER

*Disposable plastic covers for headrests*

- Size = W11.5" x L9.5" (27.9cm x 24.1cm)
- Supplied as a packet of 250

KR35111 Headrest covers



### PINNACLE LIGHT SLEEVE FOR L STYLE

*The light sleeve for L style light handles*

- Size: 3.8cm x 20.3cm
- Supplied as a packet of 500

KR3650 Light sleeve for L style



### PINNACLE SYRINGE SLEEVES

*Disposable sleeves made to cover the 3-way syringe, HVE and saliva ejector valves*

- Syringe sleeves W2.5" x L10" (6.4 cm x 25.4 cm)
- Available in 3 styles
- Supplied as packets of 500

KR37601 Pinnacle syringe sleeve XL  
*Longer version of syringe sleeve designed to cover more of the dental tubing*

KR3763WA1 Syringe sleeve with adhesive  
*Unique tape strip fastens bag to tubing to prevent sliding*

KR3767WO1 Syringe sleeve with opening  
*Exclusive pre-cut opening allows the user to simply slide the syringe tip through the end of the bag*



### PINNACLE SENSOR COVERS

*Disposable covers for the sensor on digital xray imaging systems*

- Supplied as packets of 500

KR3735 Sensor covers 1 3/8 x 8" (3.5 x 20.5cm)  
KR3736 Sensor covers 1 1/8 x 8" (4 x 21cm)



### PINNACLE TRAY SLEEVES

*Instruments can be placed directly on top of the disposable plastic sleeve*

Unique fold lock end keeps the tray safely locked inside the sleeve. Minimises staff time spent on cleaning the tray.

- Supplied as packets of 500

KR3300F1 Tray sleeves (18.75 x 26.25cm)  
KR3000B1 Tray sleeves (26.25 x 35cm)



### PINNACLE COVER-ALL BARRIER FILM

*Thin sheet of adhesive plastic*

- Disposable, easy to apply and remove and will not leave a residue
- The table top dispenser makes removal of films quick and effortless

KR16001 Dispenser  
KR3700-C Clear 4 x 6" (10 x 15cm)  
KR3710-B1 Blue 4 x 6" (10 x 15cm)



### BARRIER FILM

- On a roll and perforated for easy use
- Fine tacky adhesive
- Clear peel, no residue
- Available in blue or clear
- 1,200 sheets per box
- Size 4 x 6" (10 x 15cm)

MUBARRIERB Barrier film - blue  
MUBARRIERC Barrier film - clear



### SMALL CAMERA SLEEVES

- Custom made for intraoral cameras with adjustment ring
- Size 1.8/3.4 x 9.5 cm
- No wrinkles distorting images as the highly transparent foil fits tightly
- Optimal handling, easy to mount and to take off
- Supplied as a packet of 250

MG70311 Small camera sleeves



### INTRA ORAL CAMERA SLEEVES

- Universal fit – for use with all available camera systems
- Hygienic
- Easy to use - insert camera into sleeve, fold the top of the sleeve over and secure with red dot sticker
- Highly transparent foil allows top quality images
- Size 4.6 cm x 23.5 cm

Supplied as a packet of 250 sleeves

MG70310 Intra oral camera sleeves

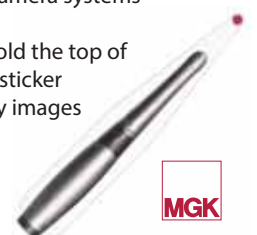

# Infection Control Products

## HYGIENE OPG BITE BLOCK SLEEVES

- Size 5.1cm x 2.1cm (2.1cm-side open)
- In continuous dispenser box
- Supplied as a packet of 500

MG70302 Hygiene OPG bite block sleeves



## DIGITAL X-RAY SLEEVES/COVERS

- For intra oral xray
- Size 4cm x 21cm
- Single in dispenser box
- Supplied as a packet of 500



MG70301 Digital xray sleeves/cover

## PHOSPHOR PLATE SLEEVES/COVERS

- Size 2
- 3cm x 4cm
- Supplied as a packet of 300



MG70602 Phosphor plate sleeves/covers

## STERILE TUBING COVERS

### SANISLEEVEES

*Effective barrier protection for handpieces and hoses*

- Latex free
- Disposable drape
- Prevents cross contamination
- Suitable for all exposed cables, cords and hoses
- Individually packaged
  - D60mm x L1650mm
- Supplied as a box of 24



DASANI24 Sanisleeves

### BULK RATE:

Purchase 3 or more boxes and receive a 25% discount

### SALVIN RAPID-ROLL™

*Effective barrier protection for handpieces and hoses*

- Latex-free
- Compacted sleeve slips over long hoses in seconds without drag
- Individually packaged
  - 65" (165cm) long
- Supplied as a packet of 25



SARAPID Rapid-Roll sterile surgical tubing covers

## EYE & FACE SHIELDS

### EYE SHIELDS

*Protective polycarbonate eyeshields*

- 0.12mm thick
- Autoclavable 121° plastic
- Supplied as frame with 30 eyeshields (with double sided protection foil)
- Available in either blue or white



LAR56B Blue frame + 30 shields

LAR56W White frame + 30 shields

## FACE SHIELDS

*Protective polycarbonate visor*

- 0.22mm thick
- 121° plastic
- Supplied as frame with clips + 6 shields
- Available in either blue or white



LAR62B Blue frame + 6 shields

LAR62W White frame + 6 shields

LAR64 Replacement visors - - packet of 12 (with double sided protection foil)



## MASKS

### ORAMASKS

*Oraltec's private label masks*

Available in standard and anti-fog  
Available in tie-on and earloop

- Ultrasonically welded on all four sides
- High filtration efficiency
- Latex free
- Fluid resistant



Earloop



Tie-on

### Standard Pleated

MUMASK305 Standard tie-on mask - box of 50

MUMASK306 Standard earloop mask - box of 50

### Anti-fog Pleated

*With bendable metal strip across the nose, ideal for professionals who wear glasses*

MUMASK311 Anti-fog tie-on mask - box of 50

MUMASK312 Anti-fog earloop mask - box of 50

Masks are sold by the box

**BULK RATES: Save 15% when buying by cartons of 6 boxes**

## GLOVES

### ORAGLOVES

*Oraltec's private label gloves, available in latex or nitrile*

- Ambidextrous
- Non sterile
- CE marked
- Powder-free
- 100 gloves per box



Latex powder-free

### Latex powder-free gloves

(hypoallergenic, textured, white)

Available in 5 sizes - XS, S, M, L, XL

ORGLOVEF\_ Oraglove latex powder-free



Nitrile Blue

### Nitrile gloves

Available in blue (5 sizes - XS, S, M, L, XL)

and pale white (3 sizes - S, M, L)

ORGLOVENB\_ Oraglove nitrile blue

ORGLOVENW\_ Oraglove nitrile pale white



Nitrile Pale White

Gloves are sold by the box

### BULK RATES:

**Ask about carton rate (10 boxes)\* and bulk rates (2+ cartons)\***

*\*mix and match sizes and type to make up cartons*

# Instruments

## LM INSTRUMENTS

### The Ultimate In Metallurgy

The high wear resistance of the blade metal is one of the most significant features of a hand instrument. LM-DuraGradeMAX supersteel used in LM hand instruments represents the ultimate in the field of metallurgy. According to independent research studies, the wear resistance of LM curettes is significantly better than that of the comparative instruments – whether sharpened regularly or not sharpened at all.

LM

feel the difference

### Colourful Ergonomics

An ergonomically designed, lightweight, and correctly shaped instrument will not strain muscles or tissue. Procedures can be performed efficiently with even the lightest grip.

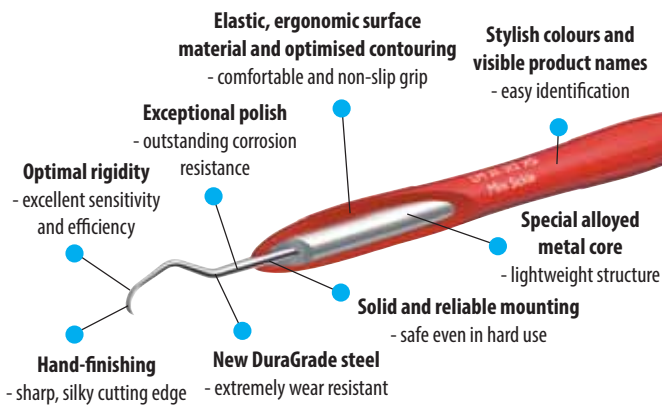

### LM HANDLE SELECTION

LM instruments are available with a selection of different handles. All instruments are exceptionally ergonomic due to the elastic silicone coating and optimised contouring.



LM-ErgoMax (XSI) handle ø 11.5mm



LM-ErgoSense (ES) handle ø 13.7mm



LM-ErgoMix (EM) handle ø 12.5mm



LM-ErgoAccess (EASI) handle ø 11.5mm curved

Unless stated, all LM instruments are available with your choice of ErgoMax or ErgoSense handles

## DIAGNOSTIC INSTRUMENTS

### MIRROR HANDLES



LM25B\_ Mirror handle - blue



LM25G\_ Mirror handle - grey



LM25R\_ Mirror handle - red



LM2526\_ Orthodontic mirror handle with ruler  
*Bausch-Verbiest design*  
For measuring the sagittal overjet and vertical overbite  
Millimetre scale, total length 25mm

The above are LM mirror handles.

For other brands, including metal handles, please refer to page 106.

### EXPLORERS

For diagnosing calculus and caries, exploring of pockets, restorations and furcations



LM58\_ Explorer 5-8 DE



LM1723\_ Explorer 17-23 SDE  
For distal surfaces



LM17C23\_ Explorer 5 centred DE - 17C-23  
Centred tip, for distal surfaces



LM36\_ Explorer 3-6



LM1112\_ Explorer 11-12  
Angles similar to Gracey 11/12



LM1819\_ Explorer 18-19 - Prosthetic  
For prosthetic crowns, bridges and inlay/onlay fillings



LM1819\_ Flexplorer 11F-12F  
Flexible explorer angulated similarly to Gracey 11/12  
Well suited for periodontal diagnosing of subgingival calculus and probing deep pockets



# Instruments

## SINGLE-ENDED PERIODONTAL PROBES



## EXPLORER PERIO PROBES COMBINED (EXPRO)

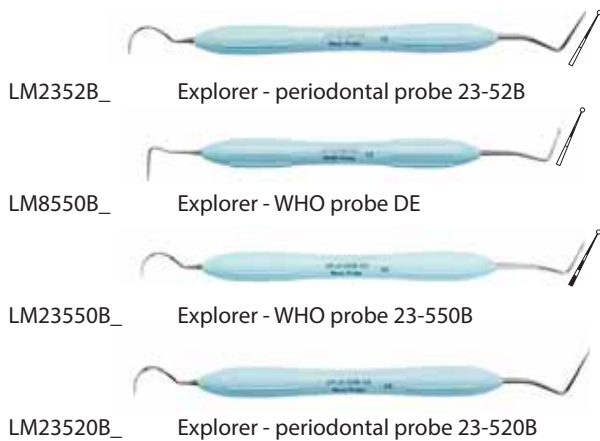

## FURCATION PROBES

For probing the extent and depth of furcation lesions

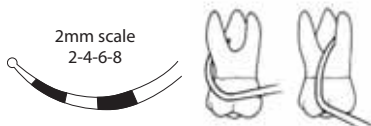
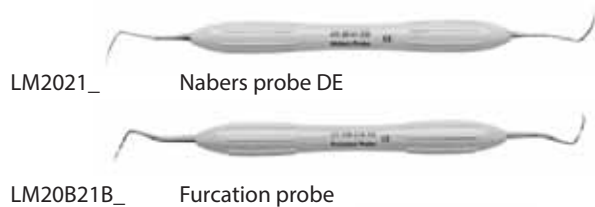

Examination of furcation lesions from different angles in both the upper and lower jaws

## PERIODONTIC INSTRUMENTS

### SCALERS

For the removal of supragingival calculus

- Triangular cross section
- Face perpendicular to the lower shank
- Two cutting edges
- Pointed tip

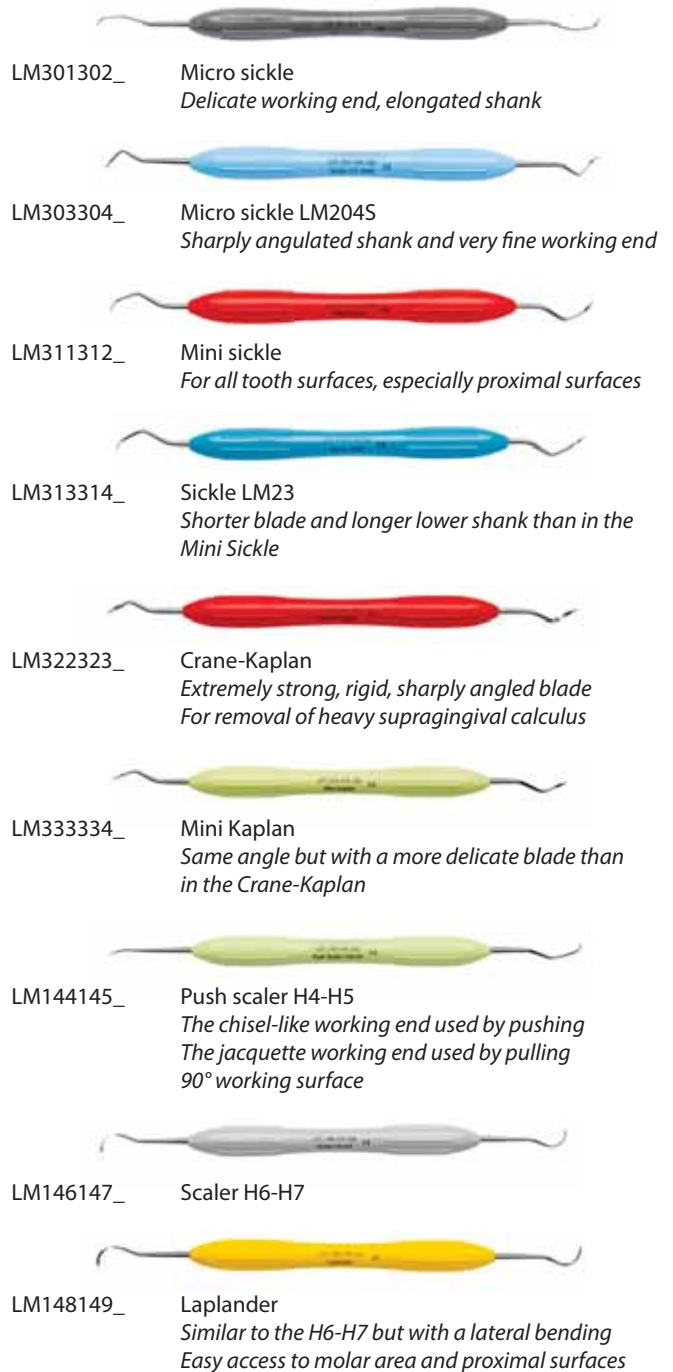

Contact **Oraltec** for all your dental supply requirements

Proud to be New Zealand owned and operated



Unless stated, all LM instruments are available with your choice of ErgoMax or ErgoSense handles

# Instruments

## SHARPEN-FREE DIAMOND COATED INSTRUMENTS

*Sharp Diamonds are completely sharpen free*

- Long lasting superior sharpness
- Save time and money
- Available in ErgoSense handles only

LM301302SDES	Micro Sickle SD <i>Delicate working end Elongated shank</i>
LM311312SDES	Mini Sickle SD <i>Fine, slightly angled back For all tooth surfaces</i>
LM215216MSDES	Mini Syntette SD <i>LM-Dual Gracey</i>
LM201202MSDES	Mini Gracey 1/2 SD <i>For incisors and premolars</i>
LM207208MSDES	Mini Gracey 7/8 SD <i>For premolars and molars For buccal, mesial and lingual surfaces</i>
LM211212MSDES	Mini Gracey 11/12 SD <i>For premolars and molars mesial surfaces</i>
LM213214MSDES	Mini Gracey 13/14 SD <i>For premolars and molars distal surfaces</i>
LM245246MSDES	Mini Gracey 15/16 SD <i>For molars mesial surfaces Blade shank more sharply angulated than in Mini Gracey 11/12 for better access</i>
LM247248MSDES	Mini Gracey 17/18 SD <i>For molars distal surfaces Blade shank more sharply angulated than in Mini Gracey 13/14 for better access</i>

## UNIVERSAL CURETTES

*For the removal of supra- and sub-gingival calculus*

- Working end perpendicular to the lower shank
- Two cutting edges
- Pointed tip



LM222223_	McCall 13S-14S <i>For incisors and premolars</i>
LM222223M_	Mini McCall 13S-14 <i>For deep, narrow pockets Sharper, slightly rounded tip (not sickle-shaped)</i>
LM233234_	Goldman- Fox 3 <i>For premolars and molars</i>
LM281282_	Langer 1/2 <i>For premolars and molars in the lower jaw</i>
LM283284_	Langer 3/4 <i>For premolars and molars in the upper jaw</i>
LM285286_	Langer 5/6 <i>For incisors in the upper and lower jaw</i>
LM281282M_	Mini Langer 1/2 <i>For premolars and molars in the lower jaw</i>
LM283284M_	Mini Langer 3/4 <i>For premolars and molars in the upper jaw</i>
LM285286M_	Mini Langer 5/6 <i>For incisors in the upper and lower jaw</i>
LM217218_	Columbia 2L-2R <i>For incisors and premolars</i>
LM219220_	Columbia 4L-4R <i>For incisors, canines and premolars</i>
LM237238_	Columbia 13/14 <i>For molars</i>
LM277228_	Barnhart 5-6 <i>For molars</i>

LM ErgoSense

LM

# SHARP DIAMOND

feel the difference



SHARPEN FREE  
MICRO COATING



## CHOOSE SHARP.

Opposites attract. This holds true with high-quality, periodontal instruments. Optimally they are razor sharp, extremely hard, yet smooth and light. A new micro membrane coating made using modern Physical Vapor Deposition (PVD) technology enables LM to create Sharp Diamond instruments with the optimum combination of these features. Sharp Diamonds are completely sharpen free, tough but refined, offering unique benefits for you and your patient.



LM Dental  
www.lm-dental.com

### SHARPEN FREE MICRO COATING

Savings of time & money

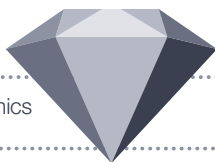

Long-lasting superior sharpness

Highest rated ergonomics with sensational grip\*

Improved productivity & clinical results

You will enjoy full control and improved tactile sense, while easily shaving off calculus instead of fracturing it.

### DIAMOND-LIKE FEATURES

- Sharpen free ..... 
- Superior sharpness ..... 
- Highest rated ergonomics ..... 
- Minimum maintenance ..... 

### HARDNESS

Hardness contributes to the durability of the instrument. Sharp Diamond reach hardness of over 63 on Rockwell scale.



### WEAR RESISTANCE\*\*

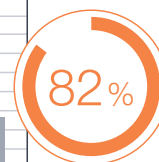
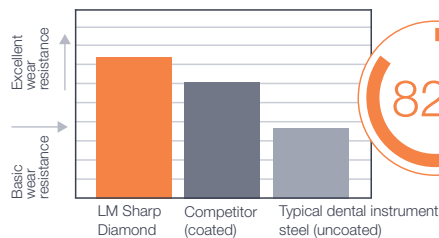

decrease in wear compared to typical dental hand instrument material.



Cutting edge of the Sharp Diamond curette and the magnification of the edge after the test.

Cutting edge of an typical non-coated curette and the magnification of the edge after the test.

Reference studies: \*(1) Sormunen E., Nevala N: Evaluation of ergonomics and usability of dental scaling instruments; Dental scaling simulation and Field study, part III. Finnish Institute of Occupational Health, LM-Instruments Oy. (2) Nevala N, Sormunen E, Remes J, Suomalainen K: Ergonomic and productivity evaluation of scaling instruments in dentistry. The Ergonomics Open Journal 2013; 6, 6-12. \*\* Leppänen J. et al: The influence of PVD coatings on the wear performance of steel dental currettes. Key Engineering Materials Vol. 674 (2016), 289-295.

# Instruments

## UNIVERSAL IMPLANT CURETTE (with ErgoMix tips)

*Titanium tipped instrument for implant maintenance*

- Delicate working end
- Especially for tight interdental spaces
- ErgoMix implant instruments can be re-tipped
- Titanium tips available separately



LM283284TE Universal implant curette - replacement tips available

## SYNTETTES

*For the removal of supra- and subgingival calculus*

- Two elliptical cutting edges
- Rounded toe



LM215216\_ LM-Syntette  
LM Dual-Gracey



LM215216M\_ LM-Syntette mini  
Mini model excellent in tight, deep pockets  
Particularly well adapted for use on premolars  
and incisors palatal and lingual surfaces

## FURCATOR

*For cleaning of furcation roof and inner surfaces*



LM259260\_ Furcator KS  
Delicate, angled instrument

## ERGOACCESS INSTRUMENTS

*Solution for calculus removal from problematic areas*

- Curved handle provides a natural hand-fit and allows easy access to difficult-to-reach treatment areas
- Ideal for use on distal surfaces of third molars and inclined lower incisors
- Available with ErgoAccess handles only



LM112156E H-Scaler I  
The curved handle allows access to hard-to-reach areas such as distal surfaces of molars and lingually inclined incisors



LM156157E H-Scaler II  
Provides easy access to molar area even with smaller oral aperture



LM301302E Micro Sickle EASI  
Fits well into the approximal surfaces in the front

## HOE SCALERS

*For the removal of supra- and subgingival calculus*

- Fine hoe-shaped blade with rounded corners
- Elliptical cutting edge
- Suitable for deep, narrow pockets and concave root surfaces
- For both vertical and horizontal technique



LM112113\_ Hoe scaler, anterior  
For the anterior labial and lingual surfaces  
Works well also with lower incisors that are orally inclined



LM134135\_ Hoe scaler, lateral  
For the buccal and lingual surfaces of all teeth  
Can also be used for furcations



LM156157\_ Hoe scaler, posterior  
For the mesial and distal surfaces of molars  
Can also be used for furcations

## DIAMOND FILES

*Diamond coated files are designed for cleaning deep concave root surfaces in anatomically difficult areas*



LM255256D\_ Concavity diamond file SV 5-6  
Diamond coated round curved toe  
For acute furcation lesions



LM257258D\_ Furcation diamond file SV 7-8  
Diamond coated egg-shaped toe  
For deep furcation lesions



LM263264D\_ Diamond file mesial-distal  
Extremely delicate diamond coated instrument for definitive scaling of the root surface  
Easy access with a fine, flexible blade in mesial-distal line angles and developmental grooves



LM261262D\_ Furcation diamond file  
Extremely delicate diamond coated instrument for definitive calculus removal in furcations and root depressions  
Easy access with a fine, flexible blade design

Unless stated, all LM instruments are available with your choice of ErgoMax or ErgoSense handles

# Instruments

## GRACEY FINISHING CURETTES

*Area specific curette for the removal of deep subgingival calculus and the finishing of subgingival root surfaces*

- Working surface included 20° to the lower shank
- One curved cutting edges
- Rounded cutting tip

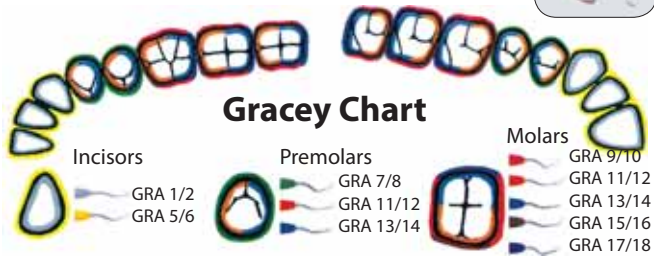

## Standard Gracey Curettes

- LM201202\_ Gracey 1/2  
*For incisors and premolars*
- LM203204\_ Gracey 3/4  
*For incisors and premolars*
- LM205206\_ Gracey 5/6  
*For incisors and premolars  
Especially useful in proximal surfaces*
- LM207208\_ Gracey 7/8  
*For premolars and molars  
For buccal, mesial and lingual surfaces*
- LM209210\_ Gracey 9/10  
*For molars buccal and lingual surfaces using  
horizontal technique*
- LM211212\_ Gracey 11/12  
*For premolars and molars mesial surfaces*
- LM213214\_ Gracey 13/14  
*For premolars and molars distal surfaces*
- LM245246\_ Gracey 15/16  
*For molars mesial surfaces  
Blade shank more sharply angulated than in  
Gracey 11/12 for better access*
- LM247248\_ Gracey 17/18  
*For molars distal surfaces  
Blade shank more sharply angulated than in  
Gracey 13/14 for better access*

## Macro Gracey Curettes

- LM205206AF\_ Macro Gracey 5/6  
*For incisors and premolars  
Especially useful in proximal surfaces*
- LM207208AF\_ Macro Gracey 7/8  
*For premolars and molars  
For buccal, mesial and lingual surfaces*
- LM211212AF\_ Macro Gracey 11/12  
*For premolars and molars mesial surfaces*
- LM213214AF\_ Macro Gracey 13/14  
*For premolars and molars distal surfaces*

## Mini Gracey Curettes

- LM201202M\_ Mini Gracey 1/2  
*For incisors and premolars*
- LM207208M\_ Mini Gracey 7/8  
*For premolars and molars  
For buccal, mesial and lingual surfaces*
- LM211212M\_ Mini Gracey 11/12  
*For premolars and molars mesial surfaces*
- LM213214M\_ Mini Gracey 13/14  
*For premolars and molars distal surfaces*
- LM245246M\_ Mini Gracey 15/16  
*For molars mesial surfaces  
Blade shank more sharply angulated than in  
Mini Gracey 11/12 for better access*
- LM247248M\_ Mini Gracey 17/18  
*For molars distal surfaces  
Blade shank more sharply angulated than in  
Mini Gracey 13/14 for better access*

Unless stated, all LM instruments are available with your choice of ErgoMax or ErgoSense handles

# Instruments

## Mesial-distal Graceys

*Combining a mesial and distal working end in one instrument. Useful when treating one quadrant at a time.*

All mesial-distal Gracey's have code rings that make it easy to identify which working end is mesial (blue code ring) and which is distal (orange code ring).



LM211214X Gracey 11/14



LM212213X Gracey 12/13



LM245248X Gracey 15/18



LM246247X Gracey 16/17

## LM ERGOMIX INSTRUMENTS

### Instruments with exchangeable tips

When there is a need for tip replacement, the lock grip is opened, a new tip is inserted and the lock grip is closed again. No extra tools are needed.



### LM ERGOMIX INSTRUMENTS



LM301302E Micro sickle



LM215216ME Mini syntette



LM201202ME Mini Gracey 1/2



LM211212ME Mini Gracey 11/12



LM213214ME Mini Gracey 13/14

### UNIVERSAL IMPLANT CURETTE (with ErgoMix tips)

*Titanium tipped instrument for implant maintenance*

- Delicate working end
- Especially for tight interdental spaces
- ErgoMix implant instruments can be re-tipped
- Titanium tips available separately



LM283284TE Universal implant curette  
NB: LM Mini Gracey 1/2, 11/12 and 13/14 also available with titanium tips for implants

LM ErgoMix replacement tips are also available

## RESTORATIVE INSTRUMENTS

### SPOON EXCAVATORS

*For the removal of softened carious dentine and temporary fillings*



- Spoon shaped working end
- Rounded tip
- Long cutting edge, which can easily treat broader areas



LM522523\_ Spoon excavator 1mm



LM533534\_ Spoon excavator 1.5mm

### ROUND EXCAVATORS

- Round working end
- Curved cutting edge



*Cariology: For the removal of softened carious dentine and temporary fillings*

*Surgery: To sever the periodontal ligament prior to extraction and the removal of granulation tissue after extraction*



LM6162\_ Round excavator 1mm



LM6364\_ Round excavator 1.5mm



LM6566\_ Round excavator 2mm

### BASE CARRIERS

*For carrying base or thin liner to dentine surfaces*



LM29H30H\_ Base carrier, rigid



LM3034\_ Base carrier - condenser, malleable tip  
Tip (30) can be bent into the desired form, allowing for easier access to hard to reach areas

### BURNISHERS



LM471473\_ Burnisher - pluggers  
Ball ended, 1.5mm - 2.5mm



LM372373\_ Burnisher 21





# Instruments

## LM-ARTE INSTRUMENTS

LM-Arte is a set of innovative instruments for aesthetic restorations and designed especially for composite layering. Each instrument is colour coded and named by its main function to enable easy, efficient and quick restorative treatments.

LM-Arte instruments have been developed in co-operation with Style Italiano, a study group of passionate clinicians and researchers specialised in aesthetic restorative dentistry.

- 

LM4649\_ LM-Arte Applica  
*A very thin and flexible spatula for transporting and modelling of the composite*
- 

LM464494\_ LM-Arte Applica Twist  
*Thin and narrow spatula with angles for modelling difficult to reach areas such as approximal walls or the marginal ridge in matrix*
- 

LM442443\_ LM-Arte Modella  
*A very thin and flexible spatula for transporting and modelling of the composite*
- 

LM488489\_ LM-Arte Condensa  
*A long and round plugger especially for modelling composite*
- 

LM481487\_ LM-Arte Fissura  
*Sharp pointed tips for modelling of occlusal surface structures*
- 

LM496497\_ LM-Arte Misura  
*For horizontal and vertical measuring of thickness of composite layers on the restorations*
- 

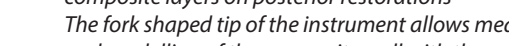
LM498499\_ LM-Arte Posterior Misura  
*Posterior version of the popular Misura instrument. For horizontal and vertical measuring of thickness of composite layers on posterior restorations. The fork shaped tip of the instrument allows measuring and modelling of the composite wall with the presence of a matrix*
- 

LM307308\_ LM-Arte Eccesso  
*For the removal of composite and bonding residue*

## DARK DIAMOND INSTRUMENTS

LM-ErgoSense Dark Diamond instruments with non-stick coating for easy placing and contouring of composite resins. The diamond like coating reduces the stickiness and allows for pleasant and precise restorative instrumentation.

### Dark Diamond features

- Exclusive diamond-like coating
- Hard surface
- Smooth surface
- Dark colour coating
- Available with **ErgoSense handle only**





- 

LM3132DDES Burnisher  
*For packing and modelling composite*
- 

LM471473DDES Burnisher - Plugger, ball ended, 1.5-2.5mm  
*For modelling composite*
- 

LM708709DDES Modeller MH  
*For packing large approximal fillings. Cylinder shaped working end will not get stuck into the composite while light curing*
- 

LM707708DDES Modeller MH mini  
*For packing small and medium approximal fillings. Cylinder shaped working end will not get stuck into the composite while light curing*
- 

LM707708DDES Packer-Modeller IO  
*For packing and modelling composite. Conical working ends optimal for shaping occlusal surfaces*
- 

LM4347DDES Plastic instrument, anterior  
*For placing, packing and contouring composite*
- 

LM48702DDES Plastic instrument, posterior  
*For placing, packing and contouring composite*
- 



LM444445DDES Mini spatula  
*For placing and contouring composite*

Unless stated, all LM instruments are available with your choice of ErgoMax or ErgoSense handles







# Instruments





## PLUGGERS

- LM330331\_  Micropacker 0.8mm
- LM330350\_  Plugger, cylindrical, 0.8mm - 1.2mm
- LM340360\_  Plugger, cylindrical, 1mm - 1.5mm
- LM350360\_  Plugger, cylindrical, 1.2mm - 2mm

## PLASTICS



- LM4347\_  Plastic instrument, anterior  
*For placing, packing and contouring composite*
- LM48702\_  Plastic instrument, posterior  
*For placing, packing and contouring composite*
- LM702703\_  Form condenser, 1.5mm - 2.5mm
- LM444445\_  Mini spatula - composite instrument  
*For placing and contouring composite*
- LM446447\_  Composite spatula 6  
*For placing and contouring composite*

## CARVERS



- LM741751\_  1/2 Hollenback
- LM7475\_  Nystrom I
- LM7677\_  Nystrom III
- LM731732\_  Cleoid-Discoid

Unless stated, all LM instruments are available with your choice of ErgoMax or ErgoSense handles

## EXCESS SCALERS

- LM785795\_  Excess scaler  
*For the removal of adhesive, cement and composite excesses*
- LM784794\_  Mini excess scaler  
*An effective excess remover in extremely tight interdental spaces*





## CORD PACKERS

- LM409491\_  Cord packer 2mm  
*For packing retraction cord into the gingival pocket*
- LM492493\_  Cord packer 2.6mm  
*For packing retraction cord into the gingival pocket*

## CROWN OFF

- LM767768\_  Crown Off  
*Blade double angled with a 45° twist  
Can be used for all types of levering and removing in the mouth*

## CEMENT MIXING SPATULAS

- HMHSH09800  Cement spatula DE
- HMHW23900  Cement spatula DE with round handles
- HMHSH09236  Cement spatula (no.336)
- HMHSH10100  Spatula, double-ended

Hammacher  
Instrumente

## EXTRACTION INSTRUMENTS

For extraction instruments and accessories, please refer to SURGICAL PRODUCTS, pages 164-157





# Instruments

## COMPOSITE INSTRUMENTS

### WIROFILL GOLD COMPOSITE INSTRUMENTS

- Designed for working with composite materials
- They are non-stick which makes composite placement easier and faster for the clinician

- HMHWH53011 Wirofill gold composite burnisher 2mm-1.7mm  
*For burnishing and modelling*
- HMHWH52405 Wirofill gold composite instrument 2.5mm - 1.5mm
- HMHWH52708 Wirofill gold composite instrument 3mm - 2.5mm
- HMHWH52709 Wirofill gold composite instrument 1.3mm
- HMHWH52103 Wirofill gold composite micro spatula DE
- HMHWH52102 Wirofill gold composite spatula DE 1.8mm
- HMHWH52203 Wirofill gold pear composite condenser  
1.5mm - 2mm

Hammacher  
instrumente

## ENDODONTIC INSTRUMENTS

### ENDODONTIC EXPLORER

*Used to locate and enlarge the root canal orifice*

- Shank angulations are ideal for anterior and posterior



### ENDODONTIC EXCAVATOR

- Root canal excavators have longer lower shanks and sharper blade angles than round excavators



### ENDODONTIC SPREADERS

*For the compacting of root canal filling materials during lateral condensation*

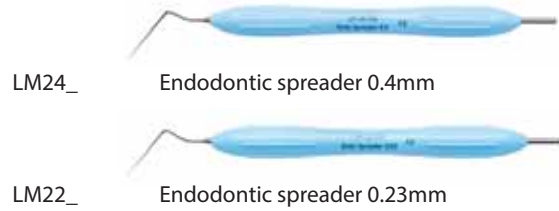

### ENDODONTIC PLUGGER

*For the vertical plugging of root canal filling*



### APEXCAVATOR GFV

*For retrograde cavities and for the removal of demineralised dentine, guttapercha and cement from the tip of the root*



## ORTHODONTIC INSTRUMENTS



Unless stated, all LM instruments are available with your choice of ErgoMax or ErgoSense handles

# Instruments

## ORTHODONTIC PLIERS



HMHSL37116 Orthodontic Kalthoff pliers, 160mm



HMHSL37213 Young loop bending pliers, 135mm  
For hard wire up to  $\varnothing 0.7\text{mm}$  (.028")



HMHSL37713 Pliers clasp/wire bending Schwartz, 135mm  
For hard wire up to  $\varnothing 0.7\text{mm}$  (.028")



HMHSL39713 Sling clasp wire bending pliers, 130mm



HMHSL40113 Pliers bird beak - Angel, no 139, 130mm  
For hard wire up to  $\varnothing 0.7\text{mm}$  (.028")

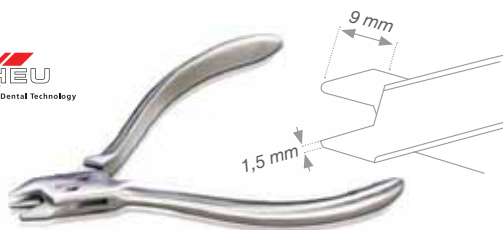

SC2044 Carat Aderer pliers  
Aderer wire bending pliers, three prong with reinforced plier tip - suitable for wires up to  $\varnothing 0.9\text{ mm}$

For more orthodontic instruments,  
please refer to ORTHODONTIC PRODUCTS, page 129

## INSTRUMENT SHARPENING PRODUCTS

### LM-RONDO PLUS

*Instrument sharpening machine*

#### Easy and Quick

- Simple method - the blade is held in the correct sharpening position and the grinding stone rotates

#### Versatile

- For both right or left handed
- The direction of rotation can be selected

#### Accurate and Safe

- The original blade form is preserved
- Low rotational speed: the blade will not heat up nor will its temper be affected
- Finer and coarser sharpening stones are available as spare parts

#### Supplied with Fingo test sticks

- Sharpness can be tested both with Fingo mounted on the LM-RondoPlus or your finger
- Fingo is made of an acrylic plastic and is sized to fit all users



#### LM-RondoPlus LM 8600 package includes

- Sharpening machine
- Foot pedal
- 400 grit sharpening stone
- 2 x LM-Fingo test sticks
- 5 x emery tapes
- Instruction CD and quick guide



LM8600 LM-RondoPlus sharpening machine/package

LM8602 LM-Fingo test sticks refills x 2

## GRINDING STONES

- For use with LM-RondoPlus sharpening machine

LM8660 600 grit (white) - fine grinding stone

LM8640 400 grit (grey) - coarser grinding stone

LM8632 320 grit (black) - coarsest grinding stone

## SHARPENING STONES

### LM Sharpening Stone for extraction instruments

*Cylindrical stone ideal for sharpening luxating instruments*



LM818002 LM sharpening stone

### Arkansas Sharpening Stones

*Arkansas stones to give fine cutting edges on dental instruments*

RA150 Wedge - size 10 x 5cm

RA151 #2 flat - size 10 x 2.5cm

RA157 India Rectangle - size 10 x 5cm



# Instruments

## MIRROR HANDLES

### MIRROR HANDLES

- All sold individually

#### Metal mirror handles

HMHSJ10400  Mirror handle, metal round, large, ø 8mm

HH426  Mirror handle, metal round solid

HMHSJ10900  Mirror handle, metal, hollow

#### ErgoForm handles from Hahnenkratt

- Made of Peek plastic
- Autoclavable to 134°C
- Length 135mm



HH542  ErgoForm handle - pastel blue

HH543  ErgoForm handle - pastel mint

HH547  ErgoForm handle - ocean blue

HH548  ErgoForm handle - turquoise/green

#### Mirror handles from LM

LM

feel the difference

LM25B\_  Mirror handle - blue

LM25G\_  Mirror handle - grey

LM25R\_  Mirror handle - red

LM2526\_  Orthodontic mirror handle with ruler  
*Bausch-Verbiest design*  
*For measuring the sagittal overjet and vertical overbite - millimetre scale, total length 25mm*

Unless stated, all LM instruments are available with your choice of ErgoMax or ErgoSense handles

## MIRROR HEADS

### MIRROR HEADS

- Sizes 3, 4 and 5
- Plane or front surface
- Supplied as a packet of 12



HH7023 Mirror head plane 3  
HH7024 Mirror head plane 4  
HH7025 Mirror head plane 5



HH7213 Mirror head front surface 3  
HH7214 Mirror head front surface 4  
HH7215 Mirror head front surface 5

### PHOTO MIRROR with dual view

- Shows buccal, occlusal and lingual surfaces with one mirror



SAPHOTODU Photo mirror with dual view

### FOG OFF MIRROR CLEANER

- A long lasting, mint scented anti-fogging and cleaning fluid for mouth mirrors, protective glasses and loupes

PD33705 Fog Off spray - 30ml  
PD33707 Fog Off spray - 50ml  
PD33710 Fog Off mirror cleaner - 250ml



## MOUTH PROPS

### HAMMACHER MOUTH PROPS

- Black, latex-free, rubber mouth props
- Autoclavable to 134°C



Available in three sizes - small, medium and large



HMHSJ16502 Bite block - adult/large  
HMHSJ16401 Bite block - child/medium  
HMHSJ16300 Bite block - child/small

### SALVIN MOUTH PROPS

- Beige, latex-free, silicone mouth props
- Autoclavable to 134°C



Available in child and adult

Each supplied as a set of 2 (same size)

SAMOUTH C Mouth prop child x 2  
SAMOUTH P Mouth prop adult x 2



# Instruments

## SCISSORS



Straight

HMHSB01010 Gum scissors, straight, 105mm, sharp  
HMHSB01110 Gum scissors, curved, 105mm, sharp



Curved

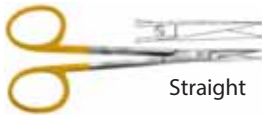

Straight

HMHSB30011 Gold gum scissors, carbide, straight, 115mm  
HMHSB30111 Gold gum scissors, carbide, curved, 115mm



Curved



Straight

HMHSB39010 Gum scissors, super cut, straight, 105mm  
HMHSB39110 Gum scissors, super cut, curved, 105mm



Curved

HMHSB08411

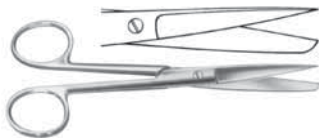

HMHSB08411 Scissors, straight, sharp-blunt, 115mm  
HMHSB08613 Scissors, straight, sharp-blunt, 130mm



HMHSB12114 Scissors, baby-Metzenbaum, curved, delicate, blunt-blunt, 145mm



HMHSB31714 Scissors, Metzenbaum, fine, curved, delicate, sharp-sharp, tungsten carbide inserts, 145mm



Hammacher Instrumente

HMHSB63010 Small foil cutting scissors for foils and splints, curved with micro saw edge, stainless steel, 105mm

SC3461 Large, robust trimming scissors - durable scissors for cutting splints or inserting cuts into splints after pressure moulding



## TWEEZERS



LATWEEZER Larident college tweezers, 15cm



IT1001A Intensiv college tweezers, diamond inside



RENTDF68 NiTin band placement forceps/tweezers



HMHSC07514 Hammacher dressing tweezers, curved, 145mm



HMHSC24315 Hammacher Gillies tweezers, 150mm



HMHSC03115 Hammacher tweezers with ratchet, 155mm

## AMALGAM CARRIERS

### Metal Amalgam Carriers



HMHSH07100 Amalgam carrier straight with metal tip, 150mm



HMHSH07300 Amalgam carrier RA with metal tip, 130mm

HMHSH07400 Spare metal tip for amalgam carrier



### Plastic Amalgam Carriers

- Larident autoclavable plastic amalgam carriers
- Available with four different angled tips

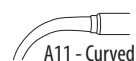

A11 - Curved

LAAMALRAC Amalgam Carrier A11 curved Replacement tip - curved A11.1

LAAMALS Amalgam Carrier A12 straight Replacement tip - straight A12.1

LAAMALRA Amalgam Carrier A13 right angle 90° Replacement tip - right angle A13.1

LAAMALBA Amalgam carrier A14 back action 110°



A12 - Straight



A13 - Right angle



A14 - Back action

# Instruments

## INSTRUMENT MAINTENANCE

### DISINFECTION TRAY

- For instruments and larger items
- Tray handle stays dry
- Holds 1.25 litres

LASTERIBO  
Disinfection Tray Tank G11



### DISINFECTION SOAK TANK

- 3 litre with basket

**UNIDENT**  
SWISS

UNTRAY  
Disinfection soak tray/tank 3L



For instrument cleaning and disinfecting solutions,  
please refer to INFECTION CONTROL, page 66

## CODING PRODUCTS

### LM-SERVO CASSETTE CODE BUTTONS

- On both sides of the LM cassettes there are holes for 3 code buttons
- Code buttons can be used to identify
- Available in four colours individual dentists or procedures
- Supplied as a packet of 20



LM600\_ Code buttons - specify colour

### LM CODE RINGS

- To code instruments to identify individual dentists or procedure, etc.
- Autoclavable
- Available in blue, green, orange, red, yellow, black, white, brown, pink and lime
- Supplied as a packet of 50



LM500\_ Code rings  
- specify colour

### TAPE N TELL ADHESIVE TAPE

- Adhesive tape for colour coding instruments
- Adapts to instruments of any size and shape
- 9 foot roll
- Available in various colours



MRTAPE\_ Tape N Tell - specify colour



## MULTIHOLDER SYSTEM

### MULTIHOLDER INSTRUMENTS

- Ergonomic LM instruments with disposable working ends
- Optimal combination of steel and plastic
- Angle options allow for easy access
- Available in ErgoMax or ErgoSense handles



LM750756\_ MultiHolder PK I



LM752754\_ MultiHolder PK II



LM752756\_ MultiHolder PK III

### Disposable working ends for multiholder



#### Gingival Retractors (blue)

*For establishing optimum working conditions for procedures at the gum line*

- To provide visibility of the area being treated
- Protects against the tissue damage
- Supplied as a packet of 60 (except for assorted pack)



LM7502  
Small



LM7504  
Medium



LM7506  
Large

LM7500 Assorted - packet of 90 (30 pieces of each size)

LM7502 Small

LM7504 Medium

LM7506 Large

#### Cervical Matrices

*For making anatomically correct fillings at the gum line*

- Covers the area being treated
- Protects from moisture
- Protects air bubbles
- Supplied as a packet of 60 (except for assorted pack)



LM7602  
Incisal



LM7604  
Canine



LM7606  
Small molar



LM7608  
Large molar

LM7600 Assorted - packet of 120 (30 pieces of each size)

LM7602 Incisal

LM7604 Canine

LM7606 Small molar

LM7608 Large molar

#### Contact Formers

*Transparent tip for making correctly formed and tight approximal contact*

- Suitable for use with all matrices
- Will not stick to composite material
- Supplied as a packet of 60 (except for assorted pack)



LM7622  
Extra Small



LM7624  
Small



LM7626  
Medium



LM7628  
Large

LM7620 Assorted - packet of 120 (30 pieces of each size)

LM7622 Extra small

LM7624 Small

LM7626 Medium

LM7628 Large

# Instruments

## MULTILEVER

- For the easy removal of plastic working ends



LM7550 MultiLever

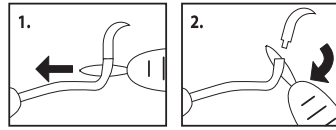

## MULTIHOLDER INTRODUCTION KIT



Intro kit contains LM-MultiHolder instruments PK I and PK II, a MultiLever and samples of all available working ends

There are a total of 44 working end (4 of each size)

LM7555K\_ LM-MultiHolder introduction kit

Unless stated, all LM instruments are available with your choice of ErgoMax or ErgoSense handles

## INSTRUMENT TRAYS

### KERR PLASTIC TRAYS

Kerr TotalCare offers a variety of dental trays, including Size B flat, Size B divided, and Size F mini.

The Size B trays fit bracket table/control head surfaces and cabinets. Both the flat and divided Size B trays measure 13 1/2" width x 9 5/8" depth x 7/8" height.

The Size F mini trays are ideal for exam or prophylaxis procedures. They are half the size of the B trays, measuring at 9 5/8" width x 6 3/8" depth x 7/8" height.

- All trays can be autoclaved
- Available in a range of colours



KR321\_ Kerr plastic trays



### PLASTIC INSTRUMENT TRAYS

- Plastic tray with moulded rack
- Cold sterilisable
- Size 28.4 x 18.3 x 1.7 cm



LAG8A Instrument tray with rack - blue  
LAG8B Instrument tray with rack - white  
LAG8R Instrument tray with rack - red

### ALUMINIUM TRAY SYSTEM

- Made from anodised aluminium
- 2 sizes available - standard and mini
- Lids sold separately (as listed) and only in silver

#### STANDARD TRAYS

- Size 284 x 184 x 17 mm
- Available in four colours - blue, grey, red or green



LAQ16\_ Standard instrument tray - solid - specify colour  
LAQ32AL Standard instrument tray - perforated - silver only

#### Tray lid for standard trays

- Silver colour only

LAQ161 Standard tray lid



#### Tray rack for standard trays

- 28cm high
- 6 levels

LATRAYQ166 Standard tray rack Q166



Q166 Standard tray rack



Q177 Mini tray rack

### MINI TRAYS

- Size 185 x 140 x 17 mm
- Available in four colours - blue, grey, red or green



LAQ17\_ Mini instrument tray - solid - specify colour

#### Tray lid for mini trays

- Silver colour only

LAQ171 Mini tray lid



#### Tray rack for mini trays

- 28cm height
- 6 levels

LATRAYQ177 Mini tray rack Q177



# Instruments

## INSTRUMENT CASSETTES

### LM-SERVO CASSETTES

Hand instruments inside LM-Servo cassettes are held securely but rotate freely for optimal cleaning and guaranteed infection control. The cassettes can be coded with silicone code buttons and attached to the LM-ServoMax tray with metal clips (LM6415).

- LM cassettes serve as an instrument tray during procedures making treatment easier and quicker
- They protect instruments during maintenance and reduce the risk of staff injuries
- They are made of durable resin which is easy to maintain
- They tolerate all common detergents and can be autoclaved up to 180°C
- Available in two sizes

LM6650  
**Servo5 cassette**  
 For 5 instruments  
 (180 x 86 x 28 mm)



LM6680  
**Servo8 cassette**  
 For 8 instruments  
 (180 x 136 x 28 mm)



### LM-SERVO E CASSETTES

The LM-Servo evolution series is designed to improve safety and traceability. Cassettes are equipped with safety shields preventing sharp injuries and protecting the blades. The option for RFID (radio-frequency identification) tagging enables complete and reliable traceability with unique LM Dental Tracking System™.

The cassettes can be coded with silicone code buttons.

- Available in two sizes
- Both cassettes are equipped with safety shields
- Each available in 4 colours

#### LM-Servo 5E

For 5 instruments  
 (180 x 83 x 26 mm)

- LM6551 grey
- LM6552 blue
- LM6553 green
- LM6554 yellow



#### LM-Servo 8E

For 8 instruments  
 (180 x 133 x 26 mm)

- LM6581 grey
- LM6582 blue
- LM6583 green
- LM6584 yellow



Please ask for more information about the LM Dental Tracking System™



### LM-SERVO MAX

*Optimal work flow and rational maintenance*

- LM-ServoMax tray system is a modular system that organises and rationalises the handling of dental instruments and accessories during the procedures and maintenance
- It facilitates good infection control and saves time by reducing the handling of individual items
- It also prolongs the life span of instruments and protects personnel
- Its versatile modules keep all instruments and accessories organised in a single tray
- The system is adaptable to treatment specific and individual needs

LM-ServoMax modules are sold separately



LM6410 LM-ServoMax tray set  
 Includes 1 set of universal trappers and 2 metal clips  
 Dimensions - 288 x 185 x 29 mm



LM6416 LM-ServoMax universal trapper, 2 pieces



LM6415 LM-ServoMax metal clips, 2 pieces

### Accessories



LM6420 LM-ServoMax standard case



LM6430 LM-ServoMax restoration/endo case



LM6460 LM-ServoMax ultrasonic tip case













LM6450 LM-ServoMax bur endofile case  
 For 8 burs and 14 files  
 Includes adjustment and measuring scales for files



LM6495 LM-ServoMax syringe holder  
 A stand attachable to the LM-ServoMax tray to place the anaesthetic syringe safely in the needle guard

# Laboratory Products

## PLASTER KNIVES

- HMHSL12118  Plaster knife, 180mm
- HMHSL12216  Plaster knife, Gritman, 165mm
- No.6  No.6
- No.7  No.7
- HMHSL12567  Buffalo plaster knife kit, no 6 & 7  
Consisting of Original Buffalo no 6 & no 7
- HMHSL12707  Plaster knife, no 7, 135mm
- HMHSN23213  Plaster knife, 230mm
- HMHWL10314  Plaster knife, 140mm
- HMHWL10617  Plaster knife, 170mm
- ASPJC102  Plaster knife, dumpy 102, plastic handle
- ASPJC104  Plaster knife, Gritman 104, plastic handle

## WAX KNIVES





- HMHSL10917  Wax knife Fahnstock, metal, 175mm
- HMHSL11517  Wax knife Fahnstock wooden handle 175mm
- HMHSL11917  Wax knife, Lessman, 175mm, stainless,  
black wooden handle

**Hammacher**  
Instrumente





## PLASTER SPATULAS

### METAL PLASTER SPATULAS

- Stainless steel laboratory spatulas

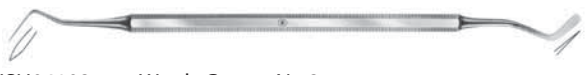
- ASPJC308  Small flexible spatula - plastic handle
- ASPJC304  Medium flat spatula - plastic handle
- ASPJC303  Medium curved tip spatula - plastic handle
- HMHWN27222  Plaster spatula made from Wironit steel, 220mm



## CARVERS & MODELLING INSTRUMENTS

- HMHSH04102  Wards Carver, No.2
- HMHSL05012  Carver mini Le Cron
- HMHSL05117  Carver Le Cron
- HMHSL05300  Modelling instrument

### ARTLINE INSTRUMENTS

- Ergonomically designed and made in Germany
- Temperature isolated and non-slippery
- Tips are made of high-quality steel, are hand-sharpened and polished



- YE8501000  Red - carving sharp + carving round
- YE8502000  Silver - modelling tip medium + modelling tip large
- YE8503000  Gold - modelling tip extra fine + modelling tip fine

### PK THOMAS WAX INSTRUMENT SET

Includes 5 instruments with coloured handles and brush, in a case

- HMHSL02315  
PK Thomas wax instrument set

**Hammacher**  
Instrumente





# Laboratory Products

## PLIERS



HMHSL35913 Adams pliers, 130mm  
For hard wire up to  $\varnothing 0.7 \text{ mm} / .028'' \text{ max}$



HMHSL41111 Wire and clasp bending pliers  
Aderer, very delicate, 115mm (4½"), steriliser bar  
For wire of thicknesses  $\varnothing 0.36 \text{ mm}$  and  $0.4 \text{ mm}$   
Particularly recommended for all NiTi and thermal arches



HMHSL42312 Wire and clasp bending pliers  
Aderer, 125mm (4¾"), sterilisable  
For hard wire up to  $\varnothing 0.9 \text{ mm} (0.35'' )$



SC2044 Carat Aderer pliers  
Aderer wire bending pliers, three prong with reinforced plier tip - suitable for wires up to  $\varnothing 0.9 \text{ mm}$

## CROWN MASTER PLIERS

- Heat resistance to 200°C
- Ideal for holding bridges & crowns to remove the sprues



DF12019 Crown Master pliers

## PLIERS RACK

- Made of acrylic
- Holds 9 pairs of pliers

LARACKF37 Pliers rack



## NIPPERS & WIRE CUTTERS



HMHSL65019 Hard plaster nipper forceps, 190mm



HMHSL50416 Wire cutters/nipper, 165mm  
For hard wire up to  $\varnothing 1.2 \text{ mm} (0.047'' )$

## OTHER LAB INSTRUMENTS

### MODEL SAW AND MULTIFLEX SAW BLADES

#### Model Saw

*A handsaw for separating pin-models*

The anatomically shaped handle of the Yeti model saw provides a safe grip and precise guided cuts



YE9830000 Model saw

#### Multiflex Saw Blades

- Made of durable steel
- Blade length: 75mm
- Supplied as a packet of 12



YE9760000 0.18 x 3mm

YE9720000 0.25 x 3mm



### MEASURING RULER



HMHSL25215 Measuring ruler 15cm (6")

### CRUCIBLE TONGS



HMHWN33855 Crucible tongs 550mm made from Wironit steel

### CARAMISTA BRUSH SET

*Brushes for ceramic with a unique finish which combines the benefits of synthetic and natural bristle*

- Very good liquid retention
- Easy dispersal from spatula and tip
- Set of 5 brushes



YE3125000 Caramista Brush Set



# Laboratory Products

## LABORATORY COMPOSITE

Signum is a modular designed system made up of universal and special veneering composites, colouring kits, tools and accessories resulting from research.



### SIGNUM COMPOSITES

Signum composite veneering system is ideal for covering metal frameworks. For long-lasting restorations and exemplary occlusal comfort.

#### Benefits

- High filler content over 65% for permanent attractive aesthetics
- Very good shade matching to prosthetic teeth
- Individual shade nuancing possible by mixing with Signum matrix
- Versatile processing options

#### Signum Masking Composite

Available in shades OA1, OA2, OA3, OA3.5, OA4, OB1, OB4, OC1, OC2, OC4, OD2, OD4 and pink



KL66020\_ Signum masking refills (opaque) - 3g syringes

#### Signum Composite Dentine

Available in shades DA1, DA2, DA3, DA3.5, DA4, DB1, DC1, DC2, DC3, DC4, DD2, DD3 and DD4



KL660200\_ Signum composite dentine shade refills - 4g syringes

#### Signum Composite Flow

Signum Flow composite flow dentines can be processed and combined in a variety of ways. They can be combined with Signum composite and also Signum matrix.



Available in Vita shades

KL6604\_ Signum flowable composite refills - 4g syringes

### SIGNUM MATRIX

*Perfect finish with flow for restorations with and without metal*

Signum matrix consists of flowable components that are compatible with Signum composite which gives the tooth a natural, living appearance. The result: The Signum matrix hybrid composite generates a dynamic interaction of fluorescence, opalescence and transparency that makes the tooth appear alive. The optical properties of a tooth depend on its structure.

#### Benefits

- Flowable composite
- For perfectly natural light dynamics
- Perfect for incisal or occlusal finishes

#### Advantages

- Ideal combination of paste and flow
- Perfect control of opalescence, transparency and fluorescence

Available in various shades

KL66019\_ Signum Matrix refills - 4g syringes



### SIGNUM CRE-ACTIVE

*For characterisation*

Signum cre-active is the creative module for characterising and simulating prominent details such as white spots, enamel cracks, etc. Artificial teeth can be modified with Signum cre-active.

#### Benefits

- Customised processing
- Can be combined with Signum matrix
- Also suitable for acrylic teeth in combination with Signum Connector



KL66033446 Signum cre-active set

Set includes 8 x 3g Signum cre-active syringes (white, polar, umbra, corn, mango, caramel, maroon, black) and 2 x 3g Signum cre-active transparent (T1, T2) and accessories



KL660200\_ Signum cre-active refills - 3g syringes (specify shade)



### SIGNUM CONNECTOR

*Light curing bonding agent between prosthetic acrylic materials and light curing veneering materials*

- For individual colour and shape modifications on ready-made dentures
- For the individual colouring of prosthetic based acrylics

Supplied as a 5ml bottle

KL64714211 Signum connector



### SIGNUM INSULATING GEL

*Ensures optimum polymerisation of the veneer surface*

Applied before final polymerisation, the gel prevents the formation of a dispersion layer on the veneer surface.

#### Benefits

- For optimum polymerisation of the veneer surface
- Water-soluble and can be completely washed off the model material
- Can be used for any model material

Supplied as a 10g pottle

KL64706307 Signum insulating gel



# Laboratory Products

## PALA CRE-ACTIVE®

*Light curing colourfluid system for customised characterisation of dentures*

In combination with Signum connector for heat-curing and cold-curing resins are particularly suitable for customised characterisation of full and partial dentures and implant-retained dentures. The different consistencies and shades make it possible to give the different parts of the gums smooth or rough surfaces in light red or dark red tones.



### Benefits

- Easy, fast application
- Easy gingival customisation
- 6 intensive shades
- 6 gingiva materials base materials
- Easily trimmed and polished



### Indications

- Customisation of full and partial dentures
- Customisation of implants
- Production of gingival masks

KL66033445  
Pala cre-active set

Set includes 12 x 3g syringes (see below), 1 x Pala cre-active shade guide, 20 x (metal) cannulae 1.2mm, 5 x (plastic) cannulae 1.87mm and 1 x brush



### Syringe colours

Colourfluids: white, polar, pink, red, maroon, black

Gingiva materials: pink, shade 200, R50, light pink, clear, gum

### Pala cre-active refills

- Available in various colours (see syringe colours above)



KL66033463 Pala cre-active refills 3g syringe - specify shade

## SIGNUM METAL BOND

*Signum Metal Bond bonds acrylic and composite to any type of metal structure including gold, titanium, non-precious and CoCr very quickly and easily*

### Surgery applications

- Addition of composite to chipped crowns and bridges with exposed metal
- Bonding of composite to implants for long term temporaries
- Maryland bridges
- Bonding to metal posts



### Laboratory applications

- Masking of clasps on chrome frames
- Bonding of acrylic and composite to implants
- Bonding of acrylic or composite to abutments

KL66033913 Signum Metal Bond kit  
Set includes 1 x 4ml bottle each of Bond I and Bond II

KL66033915 Signum Metal Bond I refill - 4ml

KL66033916 Signum Metal Bond II refill - 4ml

## BRUSHES, BUFFS & CONES

### LATHE BRUSHES

- Plastic centred
- Supplied as a packet of 10



PIBRUSH2R Pioneer lathe brush - 2 row (65mm)

PIBRUSH4R Pioneer lathe brush - 4 row (80mm)

PIBRUSH5R Pioneer calibris - 5 row (65mm)

### LATHE BRUSHES

- Metal centred
- Supplied as a packet of 10

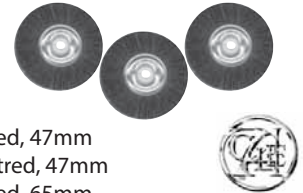

ATBRUSH10 Brush metal centred, 47mm

ATBRUSH15 Calibris metal centred, 47mm

ATBRUSH20 Brush metal centred, 65mm

### PALATE BRUSH

- 19mm diameter
- Sold individually



ATBRUSH10 Palate brush

### CALICO BUFFS

- Sold individually

BUCALICO Calico buff - 10cm, 4", 30 ply

BU07860 Calico buff - 5cm, 2", 30 ply

WRBR028 Calico buff unstitched - firm 40x100

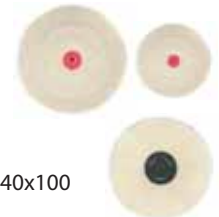

### FELT CONES

- Sold individually



BUFELTCONS Felt cone - small -  $\varnothing 1/2"$  x 1" long

BUFELTCONM Felt cone - medium -  $\varnothing 3/4"$  x 1 1/2" long

BUFELTCONL Felt cone - large -  $\varnothing 1"$  x 2" long

## POLISHING PASTES

### POLISHING PASTE

*Universal high shine blue polishing paste for acrylic, gold, composites and chrome cobalt*

- Supplied as a 75ml stick

KE24401 Hi-Shine polish stick



### DIA GLACE

*A polishing medium to obtain perfect surfaces of ceramic restorations*

- High diamond content
- High gloss within a few seconds at a speed of 7500 r/min
- Economical
- Hard consistency with a very small quantity needed
- No wasted material

Dia Glace can also be used on composites, veneer plastics and alloys.

YE3000000 Dia Glace - 5g



# Laboratory Products

## ACRYLIC POLISHERS

### KENDA QUEEN

#### 2-step finishing and polishing system

For fast smoothing and polishing of acrylic resin for partial and full dentures



- Black, medium grit, high speed
- Recommended speed 10,00-15,000 rpm

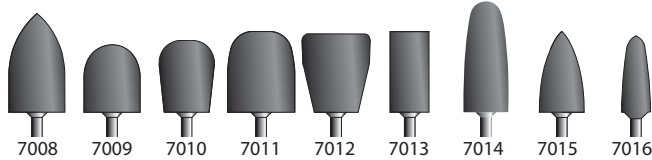

KE70\_ Medium grit - packet of 6

For efficient removal and initial polishing of acrylic resin

- Green, coarse grit, high speed
- Recommended speed 10,000-15,000 rpm

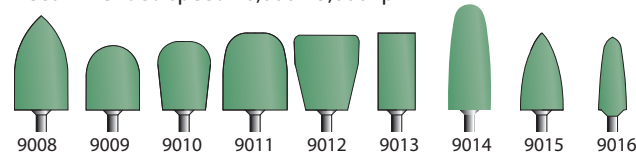

KE70\_ Coarse grit - packet of 6

### KENDA ACRYLIC BLUE

#### 3-step polishing system



- Blue / coarse - ideal for fast trimming of acrylics
- Light blue / medium grit - ideal for fast smoothing of acrylics
- Recommended speed 10,000-15,000 rpm
- Supplied as packets of 6

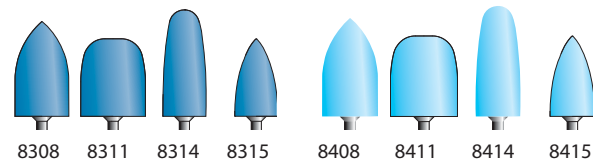

KE83\_ Coarse grit - specify shape  
KE84\_ Medium grit - specify shape

### IDENTOFLEX SUPER ACRYLIC POLISHERS

Specially developed polishers for acrylics

The dark blue polisher (coarse) is used during the initial polishing phase. It will smooth away coarse and rough areas of the prostheses without damaging teeth. The light blue (fine) polisher prepares the prostheses for final lathe polishing.

- Excellent durability
- Maximum speed 15,000 rpm
- Supplied as packet of 6

For finishing - coarse/dark blue

- ID2312 Flame
- ID2322 Grenade
- ID2332 Narrow flame
- ID2342 Cylinder

For polishing - fine/light blue

- ID2412 Flame
- ID2422 Grenade
- ID2432 Narrow flame
- ID2442 Cylinder



### IDENTOFLEX LAB-MINI POLISHERS

Special unmounted polishers for acrylics and other synthetic resins, gold and non-precious metals and hard or soft relined materials

- Enable a rapid performance and generate no heat
- High quality long lasting rubber polishers
- Maximum speed 15,000 rpm
- Supplied as a packet of 12 + 1 mandrel

Lab-Mini Pre Polishers - coarse/brown

- ID1510 Torpedo

Lab-Mini Gloss Polishers - fine/grey

- ID1610 Torpedo

Also available separately

- ID1702 Mandrel



## LABORATORY BURS

### CARBIDES

Super Fine • Fine • Coarse • Super Coarse



- Sold individually

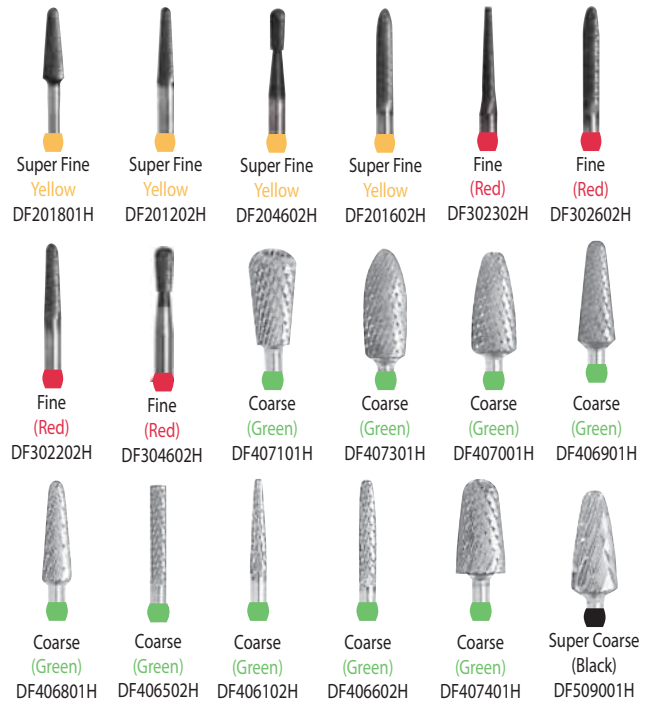

- DF20\_ Carbide bur - super fine/yellow
- DF30\_ Carbide bur - fine/red
- DF40\_ Carbide bur - coarse/green
- DF50\_ Carbide bur - super coarse/black

### SINTERED DIAMONDS

Fine • Medium • Coarse • Extra Coarse



- Sold individually

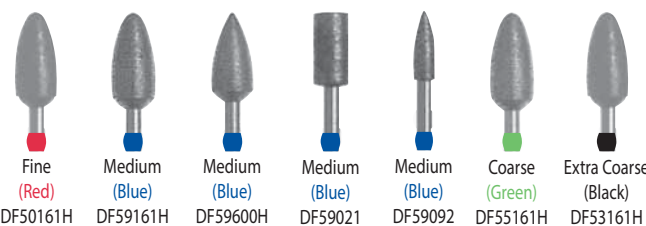

- DF5\_ Sintered diamond burs

# Laboratory Products

## THERMOFORMING FINISHERS

### FINISHING SET

For finishing of all pressure moulding materials

- Finishing set includes 4 burs, 3 initial polishers and 1 final polisher

SC3378 Finishing set



### Finishing Set Refills:

#### Cutting bur (white)

Spiral cutting bur for quick, neat cutting of all hard pressure moulding materials

- Supplied as a packet of 6

SC3214 Cutting bur (white)



#### HM-Carbide cutter (yellow)

Triangular carbide cutting bur for quick, neat cutting of hard pressure moulding materials

- Supplied as a packet of 6

SC3369 HM-Carbide cutter (yellow)



#### HM-Tricutter fine (green)

Fine triangular bur for interdental finishing of splints

- Supplied as a packet of 6

SC3370 HM-Tricutter Fine (green)



#### Finishing bur (red)

Square cutting bur made of special soft alloy that won't damage clasps and wires

- Supplied as a packet of 6

SC3377 Finishing bur (red)



#### Bioperm trimmer

For trimming and initial polishing of soft-elastic and compound material

- Supplied as a packet of 2

SC3226 Bioperm (blue) trimmer



#### Polyfix

Disc for trimming and initial polishing of soft-elastic and compound material

- Supplied as 1 disc + mandrel

SC3371 Polyfix (brown) disc + mandrel



#### Osamu polishers

For finishing and polishing of soft-elastic and compound material

- Supplied as a packet of 2

SC3247 Osamu (grey) polishers



#### Dimo trimming wheels

Stable and flexible trimming wheel with extended working time, supplied with mandrel

- Supplied as a packet of 10

SC3382 Dimo wheel brown/coarse  
 SC3383 Dimo wheel green/medium  
 SC3384 Dimo wheel maroon/fine  
 SC3380 Dimo wheel mandrel



#### Dimo®Pro trimming wheels

For finishing rims and for final and mirror finish polishing of splints, positioners, mouthguard and orthodontic appliances

- Long lasting
- Supplied as a packet of 10

SC3381 Dimopro trimming wheel - 24 x 6mm  
 SC3376 Dimopro slim trimming wheel - 24 x 4mm



## Set up an Oraltec web account

- Prices and current specials at your fingertips
- View and print your statements and invoices
- Track your spending to ensure you receive free freight on orders over \$150<sup>00</sup> (excluding GST and items which are subject to bulk freight charges)

As an Oraltec customer, we can set you up with a web account without the need for you to fill in any forms.

Simply provide us with a contact name and an email, and we'll do the rest.

You will then receive a password to get you started.



[www.oraltec.co.nz](http://www.oraltec.co.nz)

For more information, please talk your Oraltec representative or phone 0508 478 222 or email [orders@oraltec.co.nz](mailto:orders@oraltec.co.nz)



# Laboratory Products

## LABORATORY EQUIPMENT

### LATHE 26E

- A full ¼ HP, 1725/3450 rpm lathe for use on top of laboratory bench
- 11.4cm shaft height allows for easy use by the technician with hands resting on the tabletop
- Each lathe includes a right and left chuck remover, which provides easy removal of standard dental chucks
- Suitable for polishing and grinding



**HANDLER**

HN26E Lathe 26E

### Also available with chuck changer

- Designed to provide automatic, precision changing of 6mm and 2mm diameter burs, mandrels and accessories while the motor is turning



with chuckchanger

HN16B Lathe 26E with chuck changer

### MODEL TRIMMER

- ½ HP ball bearing, capacitor start motor
- Front housing opens for easy clean and wheel change
- Full wheel radius water spray
- Drain trough completely surrounds model tray to prevent water leakage
- Finished with a durable, baked coating



HN31E Model trimmer, standard 10"  
 HN31ENZWKD Model trimmer, diamond 10"  
 HN31AC Replacement wheel, standard, 10" coarse  
 HN31KD Replacement wheel, diamond, 10"

### LATHE SPLASH GUARDS

- With insert pan (no light)
- Unit dimensions 30cm x 15cm x 25cm

HN83NL Splash guard aluminium



**HANDLER**

### VIBRATOR HEAVY DUTY

- Variable vibration speed
- Desktop use
- Hard-wearing finish
- Removable rubber cover
- Rubber top size:  
L180mm x W135mm



**HANDLER**

HN78RE Heavy duty vibrator

### DUST EXTRACTOR

*Simple, practical and robust, the dust eliminator is the perfect dust extraction system for the laboratory*

- Quiet – only 58 db(A)
- Small – W410mm x L340mm x H430mm
- 5 year warranty
- Switches on and off with handpiece
- High airflow



CTC\_ Dust extractor

Available for up to 12 workstations

### HILITE® POWER

*High performance light polymerisation device*

The HiLite power creates the perfect polymerisation for all light curing dental materials.

#### Advantages

- Optimised polymerisation performance through the new lamp procedure (U-Lamp) and new useable space geometry
- Integrated monitoring of the lamp's performance with status display for safe polymerisation results
- Heightened polymerisation receptacle with a drawer mechanism for quick, comfortable handling
- Additional 6 seconds pre polymerisation facility level - easy operation

#### Easy to use

- Short polymerisation times secured through an electromagnetic lock

#### Applications

- Veneering composite materials
- Light curing, prosthetic materials
- Blocking out materials
- Light curing silicon key

KL66037191 HiLite Power



### PALAJET® PNEUMATIC INJECTION UNIT

The injection unit for the preparation of full dentures has been precisely adapted to the material properties of PalaXpress and is very easy to operate without any application of force.

The sophisticated dosing system prevents dosing errors and achieves consistent processing properties.

#### Advantages

- Efficient preparation of full dentures
- No bite elevation
- High accuracy of fit and flawless seating
- Minimal post processing
- Very user friendly
- Maintenance free operation
- Only requires compressed air connection (4 bar)
- No application of force required to operate

KL66020450 Palajet base unit



### Palajet Accessories

#### Double flask

Two flasks cure simultaneously for two dentures in a single procedure giving better efficiency



KL64715798 Palajet duoflask includes socket wrench, spacer and place holder

#### Single flask

KL64710524 Single flask



#### Filling cylinder inserts

KL64710519 12 x filling cylinder inserts + lids + 50 sealing gaskets  
 KL64714213 20 x filling cylinder inserts + 20 covers

#### Sprue wax

KL64710520 Sprue wax - 32 strips x 7mm and 32 strips x 3mm

# Laboratory Products

## PALAMAT® ELITE HEATING BATH

*High-pressure curing device Palamat Elite offers 4 different temperature programmes for performance of heat and cold curing*

In addition, you can simultaneously cure up to 3 Palajet flasks and therefore up to 6 dentures.

### Advantages

- Can be used with different denture acrylics
- Timer function for customised polymerisation
- Preset selectable polymerisation times
- Accepts almost all articulator sizes
- Fits up to 3 Palajet flasks
- Easy installation
- User-friendly touch screen and LED display

KL66057663 Palamat Elite



## HILITE PRE

*A mobile pre-polymerisation lamp with a separate charging station used to pre-cure flowable veneering composite and light cured prosthetic materials prior to full polymerisation*

This powerful LED lamp ensures quick pre-curing of the material within a few seconds. Illumination with HiLite Pre ensures rapid and reliable pre-polymerisation.

### Advantages

- Optimised polymerisation performance through the new lamp procedure (U-Lamp) and new useable space geometry

### Indication

- Short polymerisation times secured through an electromagnetic lock

KL66034243 HiLite Pre



## PRECI LIGHT - LIGHT CURING BOX

*Ideal for special trays and base plates*

- Short-waved ultraviolet light
- 4 exchangeable fluorescent tubes
- Operational by switching on / off
- CE examined unit
- Process of polymerisation: 5 minutes
- 230 volt - Power: ca. 28 watt
- Holds up to 4 models at once

YE4949000  
Preci light box



For special tray materials used in the Preci light box, please refer to IMPRESSION MATERIALS, page 63

## GIROFORM PIN DRILL

*Perfect operation, highly precise and economical*

The pin drill allows precise, fast and safe determination of the desired drill position. Drilling starts at the press of a button. The plate holder is fastened magnetically, securing the drill position.

In order to guarantee pin friction, identical, smooth-faced and regular holes are drilled into the giroform base plate. The precise drill guide also enables uniform drilling depth.

These specific characteristics of the Giroform pin drill guarantee precise, fast and cost-effective model manufacture.

- Laser beam for easy drill positioning
- Plate holder smoothly adjustable thus ensuring safe and fast operation
- Plate holder is secured magnetically and automatically when drilling starts
- Semi-automatic drilling at the press of a button (0.5 seconds per hole)
- Automatic drill advance guarantees identical boreholes in the plates
- Ergonomically positioned tip-on buttons for a high degree of operating convenience and easy activation of drilling
- Guide grooves ensure easy drill change

AM176701 Giroform pin drill machine

*Comes complete with the following which are also available separately:*

- AM176710 Tungsten carbide bur
- AM176712 Plate support L
- AM176733 Impression carrier
- AM176702 Tubular socket wrench
- AM176703 Holding pin
- AM176004 Screw driver for adjustment



## GIROFORM PINS

*Precision brass pins*

- With smooth finish on tapered section for accurate fit in base plate hole
- With active retention area for perfect grip in dental arch plaster



- AM576450 Giroform pins - packet of 1,000
- AM576451 Giroform pins - packet of 10,000



## GIROFORM PIN DRILL

*Conical hard metal drill, cutting geometry perfectly matches the giroform base plate material*

- Short chips smooth cladding



AM176710 Giroform pin drill



# Laboratory Products

## LABORATORY MICRO MOTORS

### VOLVERE i7 CORELESS MICROMOTOR

#### Features

- Light and compact to fit into the smallest space
- Microcomputer control
- Auto cruise function

#### Powerful torque and high efficiency micromotor

- Comfort grip
- Built-in special dust-proof mechanism
- High precision
- Lightweight and compact
- Low vibration and noise
- Speed 1,000-35,000 min
- Max torque 4.1 Ncm



#### Standard Set

Model VOLVERE i7 RM  
Code NKY1003493

Set includes control unit, micromotor handpiece, foot control and handpiece stand

Brushless



### ULTIMATE XL BRUSHLESS MICROMOTORS

#### Features

- Ripple-free smooth rotation with 180° vector control system
- Powerful and stable torque across the entire speed range
- Easy to hold handpiece design ensures precision
- Lightweight compact body reduces hand fatigue and improves balance
- Unique dust-proof mechanism prevents contamination therefore achieving higher durability
- Minimal vibration and noise from hermetically shielded micromotor unit
- Approximately 30% increased chuck strength enables you to work on a wider variety of materials

#### Torque Micromotor and cord

- Speed: 1,000-50,000min
- Max torque: 8.7 Ncm



Model UMXL-T Code NKY141440

• Dimensions L151 x Ø 29 mm  
• Weight 181g (cord not included) • Cord length 1.2m

#### Compact Micromotor and cord

- Speed: 1,000-50,000min
- Max torque: 6 Ncm



Model UMXL-C Code NKY141444

• Dimensions L144 x Ø 27 mm  
• Weight 181g (cord not included) • Cord length 1.2m

## ULTIMATE XL CONTROL UNITS

The Ultimate XI Series offers a choice control units according to space and user requirements.

#### Advantages

- Lightweight and compact body
- Long-term durability
- Ergonomic shaped handpiece
- Minimal noise and vibration
- Special dust proof mechanism



### Bench Top System

#### Features

- Speed of 1,000-50,000 min
- Digital speed display
- Maintenance mode setting
- Auto cruise function
- Error code display function

Brushless

Each system includes control unit, micromotor handpiece, foot control and handpiece stand

#### Torque System

Model UMXL-GT  
Code NKY141469

#### Compact System

Model UMXL-GC  
Code NKY141470



### Bench Top Tower System

#### Features

- Speed of 1,000-50,000 min
- Digital speed display
- Maintenance mode setting
- Auto cruise function
- Error code display function

Brushless

Each system includes control unit, micromotor handpiece, foot control and handpiece stand

#### Torque System

Model UMXL-DT  
Code NKY141504

#### Compact System

Model UMXL-DC  
Code NKY141505



### Knee Control System

#### Features

- Speed of 1,000-50,000 min
- Digital speed display
- Maintenance mode setting
- Auto cruise function
- Error code display function

Brushless

Each system includes control unit, micromotor handpiece and handpiece stand

#### Torque System

Model UMXL-KT  
Code NKY141495

#### Compact System

Model UMXL-KC  
Code NKY141496





# Laboratory Products

## MULTI 600 MICRO MOTOR

*Innovative double purpose with one unit*

- Speed 1,000 - 50,000 rpm
- Low noise / low vibration
- Excellent durability brushless motor eliminates the need to change brush
- Digital display

Brushless

soeyang



BM50S1 handpiece



Desktop or Knee Control

SY600 Marathon Multi 600 complete (unit + handpiece)  
 SYBM50S1 BM50S1 handpiece only (50,000rpm)

## ECO-450 MICRO MOTOR

- Automatic safety overload protection system
- Digital speed display window
- Variable speed control pedal
- Speed 50,000 rpm



SM45C handpiece



H37L handpiece

SYECO450S Marathon Eco-450 + SM45C  
 - suitable for continuous work in a lab  
 SYECO450H Marathon Eco-450 + H37L  
 - suitable for a dental practice  
 SYSM45C SM45C handpiece only  
 SYH37L1 H37L1 handpiece only

soeyang

## ALGINATE MIXER

### ALGINATE MIXER

*Consistent, dense bubble free alginate mixes every time*

- Smooth and homogenous mix in 8 seconds
- No air bubbles - resulting in a more accurate impression
- Uniform consistency - increased tear resistance and elasticity
- Less wasted alginate
- 3 preset programmes
  - 1 scoop for 6-9 seconds
  - 2 scoops for 7-10 seconds
  - 3 scoops or more for 8-11 seconds
- or adjust manually from 1-16 seconds as required

MONITEX



MIGX300 Algimax II  
 includes 1 x spatula for mixing, 1 x stirrer stick, 1 x small magnetic basket, 4 x mixing cups and 1 x water dosing bottle

## PLASTER MIXERS

### SMARTMIX X2

*The universal and future-proof vacuum-mixing machine*

AMANNGIRRBACH

When processing homogenous plaster, investment material or paste silicon and impression material, the Smartmix vacuum-mixing machine is an indispensable and productive piece of equipment.

- Multi-functional dial/button for quick and easy programme selection and programming
- Homogenous, consistent mixing quality
- Quick access to all mixing parameters: mixing duration, speed, direction of rotation, interval times, pre-mixing, pre-vacuum, post-vacuum and programme name
- Space saving design
- Less re-work required due to consistent mixing results

*Supplied with basic unit with beaker 500ml with mixing blade, for wall-mounting, drilling template, 4 screws with dowels, 1 replacement filter*

AM115700 Smartmix X2 mixer (for wall mounting)  
 AM115730 Stand for Smartmix X2 mixer



### SMARTBOX X2

*The most homogenous plaster dispensing method yet*

Weighing and mixing plaster and water by hand is imprecise and time-consuming.

Using the dosage technology, the plaster is sprinkled very finely into the mixing beaker, which noticeably increases the homogeneity of the mixture.

- Time, material and plaster savings
- Multifunctional turn/push button for simple and quick programming and programme selection
- Easy operation - error-free working for everyone
- Reproducible mixing ratio at the push of a button, accurate to within a gram
- Integrated scales automatically measure the dosage or for manual weighing
- Enables clean and dust-free operation



AM116170 Smartbox X2 mixer (for wall mounting)

*Supplied with basic unit with integrated 8kg plaster container, 3 litre water container and power cable*

AMANNGIRRBACH

# Laboratory Products

## STEAM CLEANER

### STEAMER X3

*State-of-the-art technology and a professional appearance - with Steamer X3, you have a functional and productive auxiliary tool at your disposal in the laboratory*

Steamer X3 has all the features that are needed in everyday laboratory procedures. By focussing on the basics, it guarantees maximum reliability and longevity and thereby enables greatest productivity.

- Large capacity tank - 3.7 litres
- High-end components offer maximum reliability and productivity
- Clear function display eg the minimum water quantity
- Rust-proof tank provides extended life-span
- Smooth, rounded surfaces for easy cleaning
- Drain valve positioned at the very bottom guarantees complete rinsing of limescale deposits in the tank
- Floor mounted or wall mounted



  
AMANNGIRRBACH



Steamer X3 is filled without funnel

The ergonomic hand piece is always within reach

Sealing lid without vulnerable pressure control valve

AM116910 Steamer X3

## ELECTRIC BUNSEN BURNER

### NOFLAME PLUS ELECTRIC BUNSEN BURNER

*The "electric Bunsen Burner" in the form of compact induction heating replaces the open flame*

Within seconds, the modelling instrument is heated up in the coil opening at very low power consumption.

- Mobile and immediately operational, no gas required
- Handling as usual, no adjustment required
- Eliminates the risks of getting burned or causing fire
- No heat emission into the environment; does not consume oxygen
- Clean, i.e. no soot particles on instrument and/or material
- Saves 75% of energy expenses; saves the environment

  
AMANNGIRRBACH

AM116250  
Noflame Plus electric bunsen burner



## SINTERING

### CERAMILL THERM S FURNACE

*The speed sinter furnace for greater flexibility in everyday laboratory routines*

The Ceramill Therm S provides laboratories with a new level of flexibility. In addition to the option of sintering single tooth restorations in only two hours, the compact and energy-efficient furnace offers a superior spectrum of use. It is able to sinter up to 6-pontic restorations and glaze firing is not a problem for the agile device.

Furthermore, the Therm S sets new benchmarks in terms of user friendliness. In addition to a 10.4" touch display and an intuitive user interface, the furnace can be connected directly to the internet via a network interface, making tedious updates and protocol archiving a thing of the past. This and other service and remote functions can be managed directly and conveniently via an internet database.

#### Benefits

- More flexibility in everyday laboratory routines with a 2-hour speed sintering programme for single tooth restorations
- Greatest possible user versatility through Autodry® drying function, sintering mode for up to 6-pontic restorations and glaze firing mode
- Easy handling via 10.4" touch display and internet connection for programmes and protocols



*Ceramill Therm S sintering furnace comes complete with sintering bowl, Therm S tongs and sintering pearls 200g (ø 1mm)*



Also available

### ARGOTHERM 2 FURNACE

*Shielding gas sinter furnace and flood chamber for Ceramill Sintron*



For more information on the Argotherm 2 furnace, please contact us.

  
AMANNGIRRBACH

# Model and Casting Products

## DIE STONE SPACERS & ACCESSORIES

### DIE SPACERS

*Spacers seal plaster and simulate the space needed for fixing cement between the crown and the die*

- Smooth and homogeneous layering
- Scratch-resistant and even surfaces in different layer thicknesses
- Available in 7 colours including clear

Supplied as a 20ml bottle

YE5010001	Die spacer - clear (3 my)
YE5000001	Die spacer - red (7 my)
YE5020001	Die spacer - yellow (7 my)
YE5060001	Die spacer - dentine (10 my)
YE5050001	Die spacer - blue (10 my)
YE5040001	Die spacer - gold (13 my)
YE5030001	Die spacer - silver (13 my)



### UNIVERSAL THINNER FOR ALL YETI SPACERS

The evaporation of components within the spacer, caused by unclosed or badly closed bottles, sometimes cannot completely be avoided. Using thinner, the original consistency is re-established.

YE5100001 Thinner for spacers - 20ml

NB: Not for light curing liquids or Yeti STEAM OFF



### YETI LUBE INSULATING LIQUID

*Matches perfectly with all Yeti waxes and spacers*

- It does not contain any alcohol or solvents, it is water soluble and does not react with the investment material
- Even small quantities prove the great separating effect
- YETI LUBE isolates wax against plaster, metal and wax
- The separating effect lasts for more than 24 hours

YE5500001 Yeti Lube - 20ml  
YE5500250 Yeti Lube - 250ml



### DIE HARDENER

*Completely absorbed by the plaster and does not leave any residue*

- Cures, seals and smoothens the plaster surface
- Protects the plaster
- Best results for the production of wax-copings
- Stain and water repellent

Recommended also for inlays and partial bridges within the margin line area. For the remaining areas, spacers have to be used.

YE5400001 Die hardener - 20ml



## ALLOYS

### TILITE® CERAMIC ALLOYS

Talladium's Tilite® Alloys are ISO 9002 Certified and have earned the CE mark. They have the same qualifications as artificial heart valves, joint implants and bone splints.

All alloys are biocompatible with living tissue and can be used with implants.

Talladium offers four different coefficients to match all porcelains on the market.



TALLOYO	Tilite O (Omega)
TALLOYP	Tilite P
TALLOY S	Tilite S (Star)
TALLOY V	Tilite V



### PREMIUM PRE-SOLDER FLUX

*To be used for patching holes or to make marginal adjustments on the Tilite alloys*

The Premium Pre-Solder contains 70% precious metals, 30% tilite metal and is silver free.

TAPRESOLD Pre-Solder Flux for Tilite



### POST-SOLDER FLUX

*For post-soldering Talladium's medically pure tilite alloys. It can also be used to solder tilite alloy to ceramic precious or semi-precious alloys and full cast crowns.*

The Post-Solder contains 10% precious metals and 90% semi-precious metals.

TASOLDERP Post-Solder Flux for Tilite



### WIRONIT® CHROME ALLOY

*Classic CoCr alloy for partial dentures with clasps*



- Easy processing and polishing due to reduced hardness
- Clasps can be easily activated
- Biocompatible and corrosion-resistant

Composition in %:  
Co 64.0; Cr 28.5; Mo 5.0; Si 1.0;  
Mn 1.0; C < 1.0.

Supplied as 1,000g box

BE50000 Wironit chrome alloy



### WIRONIT® LA CHROME ALLOY

*CoCr alloy for partial dentures with clasps and combination work*

- Excellent laser welding properties based on the controlled contents of carbon as well as the addition of tantalum
- Low heat conduction for a high wearing comfort
- Clasps can be easily activated
- Biocompatible and corrosion-resistant

Composition in %:  
Co 63.5; Cr 29.0; Mo 5.5; Si 1.2;  
Ta. N. Mn. C < 1.0.

Supplied as 1,000g box

BE50100 Wironit LA chrome alloy



# Model and Casting Products

## INVESTMENT

### HERAVEST PRESS

*Phosphate bonded investment material for pressable ceramics*

- Does not leave a residual layer
- Speed heating
- Excellent fit
- High strength
- Easily divested
- Supplied as 50 x 100g bags (5kg)
- Used in conjunction with BS1 liquid (KL66019993)



KL66020402 Heravest Press

### MOLDAVEST MASTER

*Phosphate bonded, graphite free precision investment material for the entire cast partial denture in cobalt chromium (CoCr) and precious metal*

- Suitable for silicone and gel duplication
- For conventional programmed preheating process
- Outstanding flowability
- Excellent fit
- Smooth surface
- Results-oriented and laboratory tested
- Supplied as 20.25kg carton containing 45 x 450g bags
- Used in conjunction with BS1 liquid (KL66019993)



KL66009782 Moldavest Master

### MOLDAVEST FUTURA

*Crown & bridge investment for precious metal*

- Phosphate bonded, graphite-free
- Compressive strength Ca 3-0
- Speed plus programmed heating
- Supplied as 4.5kg carton containing 75 x 60g bags
- Used in conjunction with BS2 liquid (KL66019996)



KL66013511 Moldavest Futura



### MOLDAVEST MASTER/HERA BSI LIQUID

*Standard liquid for Heravest Press, Moldavest Exact and Moldavest Master*

Extra liquid for telescopes and tapered crowns for Moldavest Futura

- Supplied as 900ml bottle

KL66019993 BS1 liquid

*NB: Mixing liquids must be protected from freezing and should not be stored below 5°C*



### MOLDAVEST FUTURA BS2 LIQUID

*Standard liquid for Moldavest Futura*

- Supplied as 900ml bottle

KL66019996 BS2 liquid



## STONE

### PROMODEL YELLOW STONE

- Available in 5kg and 25kg

BRSTONES Stone 5kg  
BRSTONE25 Stone 25kg



### CAVEX INSTANT STONE

*A perfect plaster mould in just 10 minutes!*

Many dental practices do not have a separate room for casting impressions and few will have access to a plaster (vacuum) mixer

- Quick and clean
- Accurate and efficient



Supplied as a tray of 18 sets of powder and activator liquid

CAVT010 Instant stone powder and liquid

## PLASTER

### PLASTER

- Available in 5kg and 20kg

GEPLAST5 Plaster 5kg  
GEPLAST Plaster 20kg



## CASTING ACCESSORIES

### CASTING FUNNEL

- White plastic
- Supplied as a packet of 50

YE1410000 Casting Funnel



### GLASS BEADS

*For blasting of gold cast alloys*

- 50 µm
- 25kg carton

KU64500657 Strahlperlen glass beads



### STEEL CASTING RINGS

KU64500692 Casting Ring 1 - 30mm diameter  
KU64500694 Casting Ring 3 - 48mm diameter  
KU64500696 Casting Ring 6 - 65mm diameter



### CONE/CRUCIBLE FORMERS

*Hard rubber formers with brass rims*

KU64500706 Cone Former 1  
KU64500706 Cone Former 3  
KU64500706 Cone Former 6



### CASTING RING LINERS

*Casting ring liners are made of flexible fabric and are asbestos free and biologically degradable*

- Supplied as a 25 metre x 55mm roll

KU64500700 Casting ring liner



# Model and Casting Products

## INSTRUMENTS

To see the range of instruments for model and casting, please refer to LABORATORY PRODUCTS, page 88-89

## SEPARATING FLUIDS

### AISLAR®

#### Separating fluid

Aislar is a formaldehyde-free, aqueous solution for separating plaster surfaces from denture acrylics and composites.

- Very high precision (no layer formation)
- Excellent for separating plaster from acrylics
- Smooth surfaces
- Applicable to all plasters and all cold and curing acrylics
- Short drying time
- Formaldehyde-free
- Reliable curing of the denture surface
- Good stability during storage

KL64708058 Aislar 2 x 1000ml



**KULZER**  
WITH CHEMICALS GROUP

### BIOPLAST SEPARATOR

Insulating agent for plaster models when working with BIOPLAST pressure moulding foils, especially when fabricating positioners and mouthguards

- Provides absolute transparency and smooth inner surfaces
- Supplied as 1 x 500ml bottle

SC3189 Bioplast separator



**SCHEU**  
Dental Technology

## OTHER

### MODEL FORMERS

Rubber base trays for model pouring

- Allows consistent size bases when pouring models
- Stone can be poured quite wet whilst not slumping

Approximate sizes:

Large = W10cm x L8cm

Medium = W9cm x L7cm

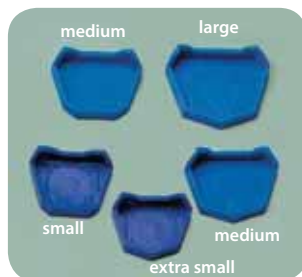

LAIMPTRAY Set of 5 assorted model formers  
LA00642 Model former - medium  
LA00643 Model former - large



### FLEXIBLE MIXING BOWLS

LAMIXBOWL3  
Large D3 bowl



LAMIXBOWL4  
Jumbo D4 bowl



### BLOCK OUT GEL

Light curing block out material

- Blocking out of plaster models
- Blue colour for simple application control
- Easy application directly from the syringe

Supplied as 4 x 1.2ml syringes  
+ application cannulae (type 44)

VO1661 Block Out Gel

**VOCO**  
THE DENTALISTS



### BLUE BLOKKER LIGHT CURING PUTTY

Light curing, blue translucent blocking out and modelling material with excellent flow characteristics

- For fabrication of space maintainers for bleaching splints and medical trays as well as for sealing sawing cuts for set-up models
- Combustible leaving no residue and therefore recommended as well in prosthodontics when fabricating fixed or removable prostheses
- Telescope constructions are stable and can be removed without tension
- Curing in the range of 380 – 470 nm

Supplied as 4 x 1.5g syringes

SC5276 Blue Blokker



**SCHEU**  
Dental Technology

### DIE SILICONE

Extra oral fabrication of cavity models and models of individual, or groups of teeth

Addition-curing silicone for extra oral fabrication of dental models.

Indirect composite restorations can be fabricated chairside on this silicone model.

The die silicone's special curing formula allows you ample time to apply the material. The material is fully cured after 3 minutes at which time you can then start modelling the restorations.

Can be used in conjunction with GrandioSO Inlay system (refer page 144 for more details).

Supplied as 2 x 50ml cartridges  
and 10 x blue mixing tips (type 20)

VO1186 Die silicone



**VOCO**  
THE DENTALISTS

### OCCCLUSAL SPRAY

For recognition of high spots

- Two different nozzles enable fine dosing
- 100% water soluble
- Easily washed off sealed plaster surfaces
- Adheres to metal, ceramics, plaster and synthetics
- Environment friendly

Supplied as a 75ml spray can

YE5802007 Occlusal spray - green

YE5802010 Occlusal spray - white



**YETI**  
DENTAL

# Model and Casting Products

## LABORATORY PUTTY

### PROTESIL LABOR PUTTY

*Laboratory Silicone Putty with high final hardness*

#### Advantages

- Highly resistant to curing temperatures of heat curing resins without deformation
- Dimensionally stable

VA057005	Protesil Labor putty 2kg tub
VA057007	Protesil Labor catalyst 60ml tube



### GIROFORM PUTTY

*Silicone putty for placing and blocking the mould on the mould carrier*

- Pleasant lemon fragrance
- Saves time
- Saves plaster and more cost-effective
- No subsequent trimming or grinding required
- Reusable

AM576461	Giroform putty - 1kg
----------	----------------------

AMANN GIRR BACH



### PALA LAB PUTTY

*High definition laboratory A-silicone putty material*

Designed for accurate and fast working in dental laboratories. The easy 1:1 mixing guarantees high fitting accuracy and exact reproduction of details.

#### Advantages

- Easy to mix in 1:1 ratio
- Fast setting time (6 minutes)
- High reproduction of details (20µm)
- Good tear resistance
- Shore hardness A90
- Dimensionally stable over time (<0.05% after 24 hours)
- Resistant to standard polymerisation temperatures

Supplied as 1 x 1.5kg base and 1 x 1.5kg catalyst + spoons

KL66057432	Pala Lab Putty 90 (base + catalyst)
------------	-------------------------------------



KULZER  
DENTAL CHEMICALS GROUP

## IMPRESSION COMPOUND

### IMPRESSION COMPOUND CAKES + STICKS

*For full/partial impressions or copper bands/tracing*

Kerr Impression compound comes in cakes of convenient size for full or partial impressions and sticks for copper band impressions or for adding to the periphery of an impression or custom tray.

Each colour has a controlled working temperature for a specific use.



KR004_	Compound Cake Available in red, green or grey - 227g (8 pieces)
KR004_	Compound Stick Available in red, green or grey - 113g (15 pieces)

## SLOW SET BITE REGISTRATION

### FUTAR D SLOW

*Futar® D Slow is a syringeable, elastomer, addition-curing silicone bite registration material with extra-high final hardness and extra-long working time*

Futar® D Slow can be comfortably trimmed and is suitable for various areas of application in the practice and laboratory.

#### Advantages

- No springing when aligning the models due to extra-high final hardness (Shore D-43)
- Best elastomeric properties ensure dimensionally accurate elastic recovery and easy, reliable removal from the mouth
- Extra-long working time (90 seconds) for various applications, e.g. for customised marginal contouring, as fixation or isolation material, for myocentric registration or in situations where a very hard A-silicone is required
- High thixotropy with controlled flow properties



KETTENBACH

Supplied as 2 x 50ml cartridge + 12 mixing tips

KT11951	Futar D Slow
---------	--------------

## PLASTER SOLVENT

### PLASTER SAFE

*Plaster solvent and tray cleaner*

- Ready-to-use economic solution to aid the safe removal of dental plaster and stone from the fitted surface of a denture
- A water-based solution with no harmful chemicals
- Easy to use - remove any excess plaster from the denture then immerse in PlasterSafe for as long as required
- Can be used in an ultrasonic cleaner

Supplied as 1 litre bottle

ASLAB906	Plaster Safe solvent
----------	----------------------

kemdent  
Quality and Reliability



## PUMICE CLEANER

### PUMICE SAFE

*Universal cleaner*

- Use in a pumice tray instead of water to produce a minty fragranced micro organism free slurry
- Use as a soak for lathe brushes to reduce the risk of burning the acrylic during polishing
- As the liquid becomes contaminated, it changes colour from pale blue to dark green and the solution should be changed
- Alcohol-free with a glycerine and emollient content
- Non irritant

Supplied as 500ml spray bottle

ASSUN268	Pumice Safe universal cleaner
----------	-------------------------------

kemdent  
Quality and Reliability



# Model and Casting Products

## GIROFORM PRODUCTS

### GIROFORM PIN DRILL

*Perfect operation, highly precise and economical*

The pin drill allows precise, fast and safe determination of the desired drill position. Drilling starts at the press of a button. The plate holder is fastened magnetically, securing the drill position.

In order to guarantee pin friction, identical, smooth-faced and regular holes are drilled into the giroform base plate. The precise drill guide also enables uniform drilling depth.

These specific characteristics of the Giroform pin drill guarantee precise, fast and cost-effective model manufacture.

- Laser beam for easy drill positioning
- Plate holder smoothly adjustable thus ensuring safe and fast operation
- Plate holder is secured magnetically and automatically when drilling starts
- Semi-automatic drilling at the press of a button (0.5 seconds per hole)
- Automatic drill advance guarantees identical boreholes in the plates
- Ergonomically positioned tip-on buttons for a high degree of operating convenience and easy activation of drilling
- Guide grooves ensure easy drill change

AM176701 Giroform pin drill machine

*Comes complete with the following which are also available separately:*

- AM176710 Tungsten carbide bur
- AM176712 Plate support L
- AM176733 Impression carrier
- AM176702 Tubular socket wrench
- AM176703 Holding pin
- AM176004 Screw driver for adjustment



  
AMANNGIRRBACH

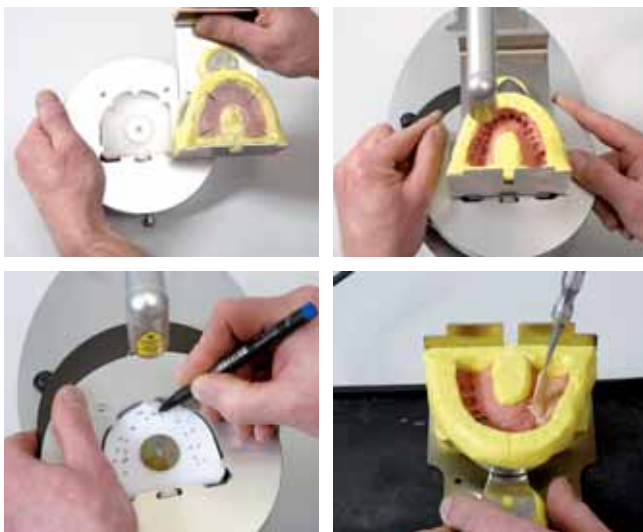

### GIROFORM PINS

*Precision brass pins*

- With smooth finish on tapered section for accurate fit in base plate hole
- With active retention area for perfect grip in dental arch plaster



- AM576450 Giroform pins - packet of 1,000
- AM576451 Giroform pins - packet of 10,000

### GIROFORM PIN DRILL

*Conical hard metal drill, cutting geometry perfectly matches the giroform base plate material*

- Short chips smooth cladding

AM176710 Giroform pin drill



### GIROFORM STARTER KIT INTERNATIONAL

*Comes complete with the following which are also available separately:*

- AM176710 ① Tungsten carbide bur
- AM176733 ② Impression carrier x 2
- AM321070 ③ NT-Cutter
- AM359010 ④ Hammer with aluminium handle
- AM576450 ⑤ Giroform pins (1,000)
- AM576461 ⑥ Giroform putty (1kg)
- AM576710 ⑦ Giroform base plate Premium + (100)
- AM576515 ⑧ Giroform secondary plate XL with magnet (5 pieces)
- AM576765 ⑨ Adjustment plate clear (2 pieces)
- AM576950 ⑩ Giroform sleeve "kombi"
- AM576805 ⑪ Giroform space retainer foil (50)
- AM815300 ⑫ Arbor band mandrel 2.35mm
- AM815330 ⑬ Arbor band, grain 120 (50)
- AM990252 ⑭ Timer
- AM5767201 Classic Plate (10 pieces)
- AM512500 Magnets (100 pieces)
- AM5767161 Classic ret. disc (10 pieces)
- AM576716 Magnetic plates incl. screw (10 pieces)
- AM576717 Screwdriver

  
AMANNGIRRBACH



AM576702INT Giroform starter kit international

# Model and Casting Products

## GIROFORM PLATES

### GIROFORM PREMIUM+ BASE PLATES

*Dimensionally stable plastic plates for saw, counter, combination, situation and diagnostic models*

- Save one work step and prevent plaster expansion
- Highly accurate and homogeneous plate material ensures smooth drillings and guarantees clean pin guidance
- Plane surface of the base plate enables the control of the individual segments with one glance
- Bevelling on the back side of the plate facilitates the insertion into the plate attachment and the removal of the models from the articulator
- Supplied as a packet of 100



AM576710 Giroform Premium+ L base plates

### GIROFORM CLASSIC BASE PLATES

Using the Giroform base plate means that the model is already half finished. The base plate is expansion-resistant, saves one working step and prevents plaster expansion.

Prior to using the paste, the pinhole is set into the base plate, recording the position of the individual segment.

The high-precision homogenous plate material provides for smooth drill holes and guarantees precise pin guidance.

The flat surface of the base plate enables simple control of the segment position via an easily recognizable light gap. Cost-effectiveness is further increased by the possibility to re-use the base plate and the retention disc.

- Large plates supplied as a packet of 100
- XL plates supplied as a packet of 10



AM576720 Giroform Classic L base plates - white  
 AM576726 Giroform Classic L base plates - blue  
 AM576740 Giroform classic XL base plates - white

### GIROFORM ADJUSTMENT PLATES

For the accurate positioning of the impression on the impression support and for checking the height of the tooth arch with inserted pin.

- Supplied as a packet of 2 (clear)



AM576765 Giroform adjustment plate L  
 AM576766 Giroform adjustment plate XL

### GIROFORM SECONDARY PLATE

- Split cast check enables passive (non-magnetic) precision fit to the base plate
- The balanced magnetic force and high material strength prevent deformation
- The retention pattern on the rear has been optimised to provide excellent grip for the plaster during insertion in the articulator but also its easy removal after use
- Supplied as a packet of 50



AMANNGIRRBACH

AM576750 Giroform secondary plate - L with magnet

### GIROFORM QUADRANT BASE PLATES

*Shape retaining acrylic base plate for quadrant impressions*



AMANNGIRRBACH

AM576770 Giroform quadrant base plates - 100 pieces  
 AM576771 Giroform adjustment plate for quadrant - 2 pieces

## OTHER GIROFORM PRODUCTS

### GIROFORM PUTTY

*Silicone putty for placing and blocking the mould on the mould carrier*

AMANNGIRRBACH

- Pleasant lemon fragrance
- Saves time
- Saves plaster and more cost effective
- No subsequent trimming or grinding required
- Reusable



AM576461 Giroform putty - 1kg

### GIROFORM M3 RETENTION DISCS

- Supplied as a packet of 100
- Including screws (10 pieces)



AM576716 Giroform M3 retention discs

### GIROFORM ADAPTOR VERTEX

- Supplied as a packet of 100



AM576790 Giroform adaptor vertex

### ABRASIVE BELT & MANDREL

*For pre-trimming of model stumps and trimming of tooth arches*

- Quick, efficient and vibration-free removal of material

AM815300 Abrasive belt arbor mandrel, cylindrical

AM815330 Arbor band, grain 120, ISO 070, length 11mm - packet of 50



### GIROFORM DUPLICATING FLASK

*Universal solution for individual refractory dies, several segments or entire dental arch*

- Ceramic firing pins allow duplicate casts to be made with refractory investment
- Saves refractory investment and duplicating silicone by reducing duplication area
- The extension of the labial area also allows duplication of protrusive anterior teeth



AM576670 Giroform duplicating flask

AMANNGIRRBACH



# Occlusion Products

## ARTEX ARTICULATORS

### The Basic Principles Of All Artex Articulators

- Integrated magnetic model plate system
- Lower part of articulator made of carbon - lightweight, strong and ergonomic
- Adjustable scaled anterior guidance pin (-5mm to +10mm)
- Support pin for upper part of the Artex articulator flipped back
- Calibration using Splitex plate system

### NON-ARCON DESIGN

- Safe and easy handling due to positively driven condyle balls
- The anatomy is upside-down. The condyle ball is on the upper part, the condyle guidance plane is in the lower part of the articulator
- The upper and lower parts of the non-arcon articulator are in unison, even in an open centric position

#### Artex CN articulator

*The non-Arcon carbon base model - the entry to the world of Artex-Carbon*

- "Click" - centric quick lock
- Fixed average condyle track inclination at 35°
- Bennett angle adjustable from 0 to 20°

AM217310 Artex CN articulator



#### Artex CT articulator

*The non-Arcon workhorse - the prosthetic articulator*

- Partially adjustable non-Arcon articulator
- "Click" - centric quick lock
- Adjustable inclination of the condyle track inclination from -15° to 60°
- Bennett angle adjustable from 0 to 20°
- Arbitrary pins for facebow adaption

AM217320 Artex CT articulator



### ARCON DESIGN

- As found in natural anatomy: The condyle ball is on the lower part, the condyle guidance plane is on the upper part of the articulator
- Adjustment of the condyle guidance elements is possible using an individual position registration

#### Artex CP articulator

*The Arcon base model*

- Partially adjustable Arcon articulator with super smooth condyle track guide
- High-precision and robust centric quick lock via mechanically guided semi axis
- Adjustable inclination of the condyle track inclination from -20° to +60°
- Distraction permitting release of compressed mandibular joints from 0 to 3mm
- Arcon clip prevents separation of upper and lower articulator parts while centric is open
- Bennett angle adjustable from -5° to +30°

AM218750 Artex CP articulator



#### Artex CR articulator

*Fully adjustable Arcon model*

- Provides comprehensive adjustment possibilities
- True masticatory simulator for practice and laboratory
- Fully adjustable Artex carbon articulator offering additional functions:
  - Variable sideshift function for transversal clearance, adjustable from 0 to 1.5mm (for each side)
  - Variable protrusion, adjustable from 0 to 6mm
  - Variable retrusion, adjustable from 0 to 2mm
- Ideal for model analysis, splint manufacture and correction
- Adjustable inclination of the condyle track inclination from -20° to +60°
- Bennett angle adjustable from -5° to +30°

AM218760 Artex CR articulator



AMANNGIRRBACH

### TECHNICAL DATA CHART

Non Arcon-Design	Artex CN	Artex CT	Arcon-Design	Artex CP	Artex CR
	Basic	Semi adjustable		Semi adjustable	Fully adjustable
SCI (Sagittal condylar inclination)	35°	-15° to +60°	SCI (Sagittal condylar inclination)	-20° to +60°	-20° to +60°
Bennett-angle (HCI)	0 to +20°	0 to +20°	Bennett-angle (HCI)	-5° to +30°	-5° to +30°
Protrusion	-	-	Protrusion	-	0 to 6mm
Retrusion	-	-	Retrusion	-	0 to 2mm
ISS (Immediate Sideshift)	-	-	ISS (Immediate Sideshift)	-	0 to 1.5mm (per side)
Distraction	-	-	Distraction	0 to 3mm	0 to 3mm
Centric design	Centric click	Centric click	Centric design	Centric lever for semi-axes	Centric lever for semi-axes
Upper and lower arms prevented from separating in open centric by:	Centric plate	Centric plate	Upper and lower arms prevented from separating in open centric by:	Arcon-clip	Arcon-clip
Arbitrary pins for direct transfer with Artex facebow	No	Yes	Arbitrary pins for direct transfer with Artex facebow	Yes	Yes

# Occlusion Products

## ARTEX FACEBOW

### ARTEX FACEBOW

*Anatomically correct fixation of the cranial-axis relationship in just 2 minutes*

The Artex Facebow is not just a success on account of its ease of handling, but it is possible to work rapidly and economically; in just two minutes, the cranium/axis relation is determined in correspondence to the patient's anatomy.

In functional diagnostics and treatment, it is an indispensable tool which considerably reduces grinding time at chairside.

- Cranium/axis relation determined in corresponding to the patient's anatomy in just two minutes
- Quick and secure the 3D universal joint
- Cranium-axis orientated transfer of the maxillary model to the articulator transfers the real jaw positioning precisely to the articulator and consequently reduces grinding time at the chairside
- Reliable reproducibility of arbitrary axis position using cushioned Leipzig Nasion



Bite fork insertion



Face bow attached to the patient



Removing joint support with bite fork record from the face bow

Comes complete with the following:

- AM218620 ① Joint Support
- AM218680 ② Leipzig Nasion
- AM218607 ③ Porus buttons "standard"
- AM217650 ④ Artex Quickbite
- AM217928 ⑤ Tray handle

 AMANNGIRRBACH

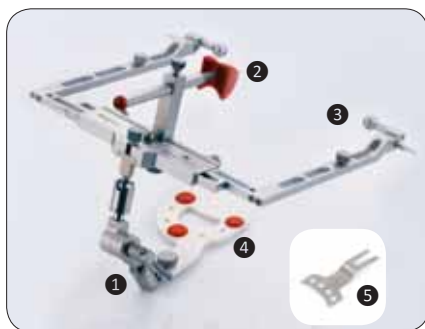

AM218600  
Artex Facebow

### ARTEX QUICKBITE

- Disposable bite forks
- Supplied as a packet of 10

AM217650 Artex Quickbite



### METAL BITE FORK

- Supplied as a packet of 2

AM217611 Bite forks



### ARTEX/SPLITEX MOUNTING ARTICULATOR

The mounting articulator is calibrated to the working articulator. It is used to mount models in the laboratory using the Splitex Transfer stands and tables. This keeps the working articulator free of plaster and stone residue and allows free interchange of models between similarly calibrated instruments.

- Safeguards articulators against water and plaster dirt
- Compatible with all types of facebow and transfer systems
- Centric and vertical height are fixed using rigid hinge axis/incisal pins
- Easy removal of the models due to a detachable magnet in the upper frame

 AMANNGIRRBACH



AM216020C  
Splitex mounting articulator, 126mm carbon-version

### ARTEX/SPLITEX TRANSFER STAND COMPLETE

*For safe transport of the facebow registration to the lab*

The universal joint with bite fork is removed from the facebow and inserted into the reception of the transfer stand. There, the registration is fixed in plaster.

The detachable transfer table safely and unshakeably takes this important patient information to the lab.



AM216240 Splitex transfer stand complete

### ARTEX TRANSFER TABLE WITH SPLITEX PROFILE

The detachable part of the transfer stand, either with screw for model plates or furnished with Splitex magnetic plate. Several transfer tables are necessary in case of short registration intervals (whereas only one facebow and one transfer stand are required).

- Saves money as only one facebow is required
- Saves plaster work at the practice but ensures safe transport to the lab



AM216270 Transfer table with Splitex profile

### APEX ARTICULATOR

- Constructed of bronze castings
- Centre support for durability and better plaster retention

 HANDLER

HN72 Apex articulator



# Occlusion Products

## ARTIGATOR ARTICULATOR

*For the expert and artistic processing of the "triple-tray technique" by the dental technician*

- Sturdy unit with safe centric and artex "click" lock
- Performs average-value movements as well as immediate side-shift (ISS)
- Full frontal access for proper adjustability thanks to the crank pin
- Direct segment model in magnetic pin plate
- Replaces four work steps with one, saves half the plaster consumption
- Quick amortisation due to enormous time and material saving



AM218950 Artigator articulator including 2 base plates (blue)

**Artigator base plates** also sold separately

- Blue base plates
- Supplied as a packet of 50



AM218941 Artigator base plates

## SPLITEX PLATE SET FOR ARTEX

*Comes complete with the following:*

- AM216100C ① - ⑥ Splitex plate set, C-version
- AM216110C ① Splitex base plate (TOP) without magnet
- AM216120C ② Splitex adjustment plate without magnet
- AM216160 ③ 1 magnet removal pin, 2 pieces
- AM216150 ④ Retention discs, 10 pieces
- AM216111C ⑤ Splitex magnet (set - pieces included)
- AM216112C ⑥ Assembly wrench

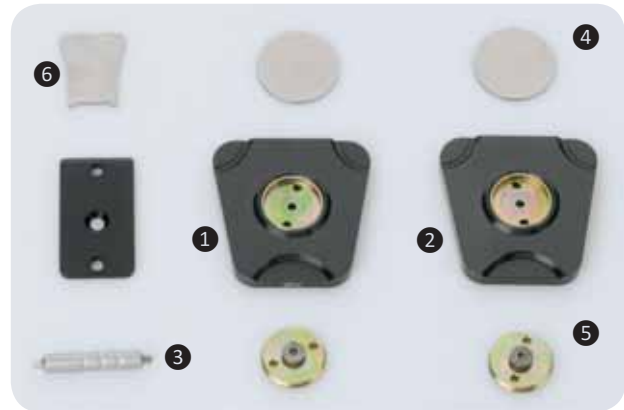

AM216100C Splitex plate set for Artex

## SPLITEX CALIBRATION

### SPLITEX MASTER PLATFORM SET (1 to 3 parts)

*For the production of Splitex Counter plates made from surplus stone*

- Magnetically connects to the Splitex plates

*Comes complete with the following:*

- AM216200 ① Set, 3-parts
- AM216150 ② Retention discs, 100 pcs
- AM216211 ③ Master platform set
- AM216220 ④ Rubber frames for socket
- AM216205 ②-④ Set, 1-part
- AM216141 1 magnet (built-in)
- AM216221 Rubber frame for socket, low-level

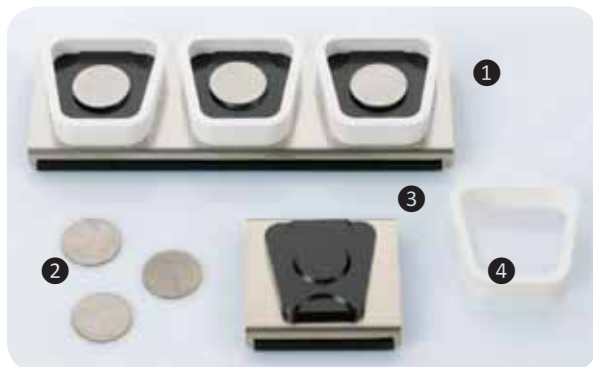

AM216200 Splitex master platform set

### SPLITEX COUNTER PLATE

The shock-resistant plastic material reliably adapts the Splitex plinth plate without distortion. Plates are suitable for multiple use.

- Quick and precise
- Prevents the risk of ill fit since no plaster expansion takes place
- Supplied as a packet of 10



AM216235 Splitex counter plate, classic black

### SPLITEX DISTANCE PLATE FOR ARTEX

AM216011 Splitex distance plate for Artex 

### RETENTION DISCS

- Ø 36.5 x 1.5 for Splitex
- Supplied as a packet of 10



AM216150 Retention discs

### SPLITEX MAGNETS

- Supplied as a packet of 6



AM216140 Splitex magnets

### MODEL BOX

- Deep-drawn box for transporting dental models, self-locking, with 2 foam rubber cushions
- Holds 4 models



AM511540 Model box

### MODEL CASES

- Small (78 x 70 x 45)
- Supplied as a packet of 30



AM511430 Model cases

To view the complete range of ARTEX products, please ask for a copy of the latest Amann Girschbach catalogue



# Occlusion Products

## ARTICULATING PAPER

### BAUSCH ARTICULATING PAPER

- Bausch articulating paper with progressive colour transfer
- To improve the clear visibility of colour on moist polished occlusal surfaces, formula is used
- More intensely marked spots (= strong pressure) indicate that more colour is being squeezed out, normal spots (= light or normal pressure)

### ARTICULATING PAPER - 200 microns

With Bausch 200µm paper, the lighter the bite, the lighter the mark and the harder the bite the darker the mark.



- |          |                                    |
|----------|------------------------------------|
| BABK01   | 300 strips - blue                  |
| BABK02   | 300 strips - red                   |
| BABK1001 | 300 strip refill - blue            |
| BABK1002 | 300 strip refill - red             |
| BABK03   | 50 sheets horseshoe - blue         |
| BABK04   | 50 sheets horseshoe - red          |
| BABK05   | Straight book of 300 sheets - blue |



### PROGRESS 100° - 100 microns

Hydrophilic properties makes this 100µm paper ideal for use on moist occlusal surfaces - a highly desirable attribute.



- |        |                                     |
|--------|-------------------------------------|
| BABK51 | Plastic dispenser 300 strips - blue |
| BABK52 | Plastic dispenser 300 strips - red  |

### ARTICULATING PAPER - Micro Thin° - 40 microns

Bausch 40µm, micro-thin articulating papers are extremely thin and tear-resistant and are coated with liquid colours on both sides. These papers mark precisely because of the thin material. False or smear contacts can thus be avoided.



Clearly visible anterior tooth and canine tooth relationship



Marking of the concentric occlusion & eccentric occlusion in red or blue



- |        |                                       |
|--------|---------------------------------------|
| BABK09 | Booklet of 200 blue strips - straight |
| BABK10 | Booklet of 200 red strips - straight  |
| BABK13 | Roll W16mm x L15m - blue              |
| BABK80 | Booklet of 200 strips - blue/red      |
| BABK81 | Horseshoe 150 sheets - blue/red       |
| BABK17 | Horseshoe 150 sheets - blue           |



### GNATHO FILM - Ultra Thin° - 16 microns

- Developed to meet the need for a soft and flexible occlusal film
- Ultra-thin 16µm polyethylene film with a 6µm soft colour-coating consisting of waxes with hydrophilic components
- Extremely tear resistant - this unique film adapts perfectly to the individual conditions of the respective occlusal surface



- |         |                                       |
|---------|---------------------------------------|
| BABK120 | 50 sheets, 20 x 60mm, 1 sided - black |
| BABK121 | 50 sheets, 20 x 60mm, 1 sided - red   |
| BABK123 | 50 sheets, 20 x 60mm, 1 sided - blue  |

### ARTI-FOL FILM



#### 8 microns - 1 sided - 22mm wide *Ultra-thin, tear resistant*

- |        |                               |
|--------|-------------------------------|
| BABK20 | Plastic dispenser - 20m black |
| BABK21 | Plastic dispenser - 20m red   |
| BABK22 | Plastic dispenser - 20m green |
| BABK23 | Plastic dispenser - 20m blue  |



#### 8 microns - 1 sided - 75mm wide *Ultra-thin, wide film used mainly in laboratories so the full dental arch can be tested*

- |        |                |
|--------|----------------|
| BABK71 | 20m roll - red |
|--------|----------------|



#### 8 microns - 2 sided - 22mm wide *Ultra-thin, tear resistant*

- |        |                               |
|--------|-------------------------------|
| BABK24 | Plastic dispenser - 20m black |
| BABK25 | Plastic dispenser - 20m red   |
| BABK26 | Plastic dispenser - 20m green |
| BABK27 | Plastic dispenser - 20m blue  |



#### 12 microns - 1 sided - 22mm wide (Shimstock film) *Tear resistant and antistatic metallic polyester film with excellent colour transfer*

- |        |                               |
|--------|-------------------------------|
| BABK30 | Plastic dispenser - 20m black |
| BABK31 | Plastic dispenser - 20m red   |



#### 12 microns - 2 sided - 22mm wide (metallic) *Tear resistant and antistatic metallic polyester film with excellent colour transfer*

- |        |                                   |
|--------|-----------------------------------|
| BABK28 | Plastic dispenser - 20m black/red |
|--------|-----------------------------------|



### ARTICULATING PAPER - DETEX

- Colour - blue
- 120mm x 25mm x 40µm thick
- Each sheet double sided
- Supplied as 144 strips

The special vegetable wax coating and pure colouring ingredient ensure Detex does not stain patients lips.

- |           |                               |
|-----------|-------------------------------|
| ASARTICBL | Detex blue articulating paper |
|-----------|-------------------------------|



# Occlusion Products

## ARTICULATING FORCEPS

### ARTI-FOL FORCEPS

*Arti-fol approximal contact forceps with high clamping force of the forceps to tighten the occlusion film on both sides to allow accurate contact correction*

- The film can be inserted quickly and easily
- The forceps are manufactured from high-quality steel which guarantees a long life



**Bausch**



BABK145

Arti-fol approximal contact forceps

### ARTICULATING FORCEPS

BABK132

Articulating Arti-fol forceps



HMHSC50201

Articulating forceps curved 150mm



HMHSC50002

Articulating forceps extra curved 150mm



BABK142

Articulating forceps Miller



HMHSC50100

Articulating forceps Miller straight 150mm

### BITE FRAME 'Y' SHAPED FORCEPS

BABK140

Y-shaped forceps to be used with Arti-Fol up to 75mm wide



## INTRA ORAL MEASURING STRIPS

### FLEXIMETER - STRIPS

- These strips are flexible measuring instruments in three different thicknesses
- They measure the height of the preparation on grinding teeth for restoration (eg., crowns, bridges or telescopic crowns)
- The thicknesses of the Fleximeter-Strips 1mm, 1.5mm and 2mm can also be used to enlarge the vertical dimension (bite height)
- They are made from a special silicone rubber that can be sterilised up to a temperature of 200°C

**Bausch**

Supplied as a packet of 15



BABK250  
Pink strips  
(1mm)

BABK251  
Green strips  
(1.5mm)

BABK252  
Blue strips  
(2mm)



### FLEXIBLE CLEARANCE TABS™

*Designed to make direct intraoral measurements of occlusal and interproximal tooth preparation clearances*

Dentist places individual Flex Tab between the prepared tooth and its opposing occlusal surface to ensure sufficient clearance for the laboratory to develop a perfect restoration.



**Kerr**

- Single use
- Packed individually
- Available in three sizes - 2.0mm (blue) 1.5mm (green) 1.0mm (pink) and as an assorted pack



KR00400\_

Flex Tab - specify size

KR004009

Flex Tab - 3 pack assorted (blue, green, pink)

**At Oraltec we specialise in the supply of premium dental products for the modern dental professional. We have the solutions to make your life easier.**

#### • Quality and innovation

We select the best-in-category products usually from specialist manufacturers that concentrate on quality and innovation.

#### • Superior product knowledge

We build strong relationships with the manufacturers we represent which allows us to provide a greater level of product knowledge, clinical advice and technical support.

#### • Personal attention

Our sales representatives operate throughout New Zealand and our specialist focus ensures we provide the highest level of customer service possible.

Visit our website or speak to one of our team. We will take care of you.

**Oraltec. Your Premium Dental Partner.**

**ORALTEC**



Proud to be New Zealand owned and operated

# Office Products

## TORK PAPER PRODUCTS

### TORK MATIC TOWEL ROLL - H1 SYSTEM

*A cost effective, portion controlled hand towel dispensing system automatically cuts and dispenses roll towel one sheet at a time*

- Highly absorbent for efficient hand drying

TO290016	Tork Matic Premium towel roll White/blue leaf, 2ply, 100m Rolls sold individually (6 per carton)
TO551000	Tork Matic H1 dispenser



### INTERFOLD SLIMLINE TOWELS - H2 SYSTEM

*A slim dispensing system for smaller washrooms where space is at a premium*

- Dispenser size -  
W302mm x H444mm x D102mm

TO120289	Tork Interfold Slimline towels, white/silver leaf, 2 ply Carton of 3,780 towels (21 bundles x 180 leaves)
TO2148430	Tork Interfold Slimline Advanced hand towels White, 1 ply Carton of 3,200 towels (16 bundles x 200 leaves)
TO552030	Interfold Slimline H2 dispenser - white



### INTERFOLD ZIGZAG TOWELS - H3 SYSTEM

- Soft 2 ply lint-free paper
- Sold as a carton of 3,750 towels (15 bundles x 250 sheets)
- Dispenser size - W333mm x H439mm x D136mm



TO290163	Interfold Zigzag towels - white
TO290179	Interfold Zigzag towels - green
TO553000	Interfold Zigzag H3 dispenser - white



### MINI TORK ROLLS - M1 CENTRE FEED

*Narrower hand wiping towels*

- Standard - 1 ply, 120m roll
- Plus - 2 ply, 75m roll
- Rolls sold individually (11 rolls per carton)
- Dispenser size - W174mm x H321mm x D165mm

TO100130	Mini Tork rolls - Standard
TO101221	Mini Tork rolls - Plus
TO558030	Mini Tork roll M1 dispenser - white



### M TORK ROLLS - M2 CENTRE FEED

*Wider hand wiping towels*

- Standard - 1 ply, 275m roll
- Plus - 2 ply, 160m roll
- Rolls sold individually (6 rolls per carton)
- Dispenser size -  
W239mm x H360mm x D227mm

TO100134	M Tork rolls - Standard
TO101250	M Tork rolls - Plus
TO559030	M Tork roll M2 dispenser - white



### T TORK TOILET ROLLS - T2 SYSTEM

*Toilet tissue for T Box Mini*

- Plus - 2 ply, 170m roll
- Rolls sold individually (12 rolls per carton)
- Dispenser size  
- W345mm x H275mm x D132mm

TO110253	T Tork toilet rolls - Mini Plus
TO555000	T Tork toilet roll T2 dispenser



**Dispensers free on loan - please ask for more information**

### TORK ADVANCED TOILET ROLLS

- Individually wrapped toilet rolls
- Soft 2 ply paper
- Sold individually (48 per carton)

TO0000234	Toilet rolls
-----------	--------------



### WIPER CLEANING CLOTHS

- Economical: Excellent wet strength and absorbency
- Versatile: Clean into corners and confined spaces thanks to the soft, light and flexible material
- Time saving: Consistent quality product every time



TO510178



TO510150

TO510178	Wiper cleaning cloths x 150 cloths (size folded = 42cm x 38cm)
----------	---

TO510150	Wiper cleaning cloth x 55 cloths (1 ply, 32cm x 39cm)
----------	--



### TORK PREMIUM FACIAL TISSUES

- Soft 2 ply tissues
- Supplied as a box of 100 or 224 tissues

TO2311408	Tissues - box of 100
TO2170303	Tissues - box of 224



## TORK HYGIENIC BINS

The Tork B1 bin is suitable for a wide range of rest rooms and can be flexibly mounted to the wall or floor where needed

- Reduce mess with a high capacity 50L bin, ideal for busy washrooms
- Easy maintenance with ergonomic bin liner arm for easy loading and unloading

TO563000	Large white bin B1 - 50 litre
----------	-------------------------------

The Tork B3 bin is designed for compact spaces and provides a modesty tray and self closing lid

- A compact 5L bin that is simple to service and a hygienic disposal option

TO564000	Small white bin B3 - 5 litre
----------	------------------------------





## The easiest way to hands-free hygiene



Hands-free hygiene

Unbeatable  
consumption control

Simple and reliable



These sensor-driven, high capacity dispensers ensure you only touch the soap or paper you are using – making them perfect for hygiene sensitive work environments such as the dental profession.

### Hands-free hygiene

- Optimum hygiene through Tork® touch-free sensor dispensing
- High capacity reduces risk of unhygienic run-out

### Unbeatable consumption control

- One-at-a-time dispensing reduces consumption, costs and waste
- Control consumption with adjustable sheet length for hand towels
- Reduce consumption without frustration with a 0.5 sec delay on soap dispensing

### Simple and reliable

- Minimised maintenance through easy refilling
- Long battery life – lasts up to 5 cases of hand towel, 90,000 doses of soap



Tork Foam Soap  
Intuition™ Sensor S4 System  
TO561600 White TO460009 Stainless Steel



Tork Mild  
Foam Soap  
TO520501



Tork Extra Mild  
Foam Soap  
TO520701



Tork Antimicrobial  
Foam Soap  
TO520801



Tork Matic Hand Towel Roll  
Intuition™ Sensor H1 System  
TO551100 White TO460001 Stainless Steel



Tork Matic Extra Soft  
Hand Towel Roll  
TO290016  
408 sheets



Tork Matic Soft  
Hand Towel Roll  
TO290067  
612 sheets



Tork Matic Blue  
Hand Towel Roll  
TO290068  
612 sheets

# Office Products

## RECORD CARDS & ENVELOPES

### PATIENT RECORD CARDS

- Available in double/foldout or single cards



GERECORDF Double foldout cards - packet of 100  
GERECORDS Single record cards - packet of 200

### PLASTIC ENVELOPES

- Patient record cards fit inside
- Packet of 100

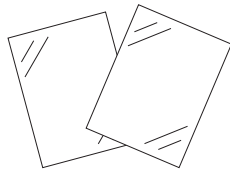

GEENVELOPE Plastic envelopes

### PAPER ENVELOPES

- Patient record cards fit inside
- Printed front and back
- Packet of 100



GERECORDE Paper envelopes

## ANALGESICS

### IBUPROFEN®

*A well-known and well-tolerated analgesic and anti-inflammatory*

**Dose:** Packs have directions of use: 1-2 tablets every 4 hours, maximum 6 tablets per day. Interactions include: digoxin, lithium, methotrexate, tacrolimus, warfarin

**Contra indications:** Allergy to any NSAID, onset of asthma, rhinitis, nasal polyps with any NSAID, peptic ulcer, gastro-intestinal bleeding

**Precautions:** Pregnancy, breast-feeding, history of gastro-intestinal disease, renal disease, asthma, coagulation disorders, elderly

**Side effects:** Gastric upset, dizziness, allergy, worsening of asthma

- Lowers temperature, relieves pain and reduces inflammation
- Effective for dental pain
- Contains 200mg ibuprofen per tablet



MUIP20047 Ibuprofen - 20 tablets

### PARACETAMOL®

*A well-known and well tolerated analgesic that can be taken by almost all patients*

**Dose:** Packs have directions of use: 1-2 tablets every 4 hours, maximum 8 tablets in 24 hours

**Contra indications:** Paracetamol allergy

**Precautions:** Hepatic or renal disease

Avoid concomitant use of other paracetamol containing products

**Side effects:** Rarely hypersensitivity, skin rash

- Lowers temperature, relieves pain and reduces inflammation
- Effective for dental pain
- Contains 500mg paracetamol per tablet



MUPARA20 Paracetamol - 20 tablets

## FIRST AID KITS & SUPPLIES

### MANAGED FIRST AID KITS

**Protect you, your staff and your patients**

*Kits are fully managed and stocked using hospital grade supplies*

- Meets OSH guidelines
- Sturdy, wall mounted cabinets supplied free on loan
- Transparent clearly labelled, injury-specific modules - easy to find the right supplies
- Suitable for up to 15 employees
- Checked and updated quarterly with recorded service dates
- Expired stock donated to charitable organisations



Please ask your Oraltec representative for more information

- First aid kits serviced quarterly
- Invoiced monthly through your Oraltec account
- Terms and conditions apply

ZFIRSTAID Managed first aid kits

### BAND-AID FABRIC STERILE STRIPS

*Helps cuts heal twice as fast as uncovered cuts*

- Quilt-aid/non-stick pad technology
- Full width pad
- Supplied as a box of 50 sterile fabric strips



JJ37401196 Band-Aid fabric sterile strips

### BAND-AID PLASTIC STERILE STRIPS

*Adhesive bandages - plastic*

- Quilt-aid/non-stick pad technology
- Breathable protection
- Supplied as a packet of 25



JJ20612802 Band-Aid plastic sterile strips

## MOISTURISERS & HANDCREAMS

### AVEENO DAILY MOISTURISER

*Daily moisturising lotion with natural colloidal oatmeal*

- Relieves and protects dry skin
- Moisturisers for 24 hours
- Fragrance-free
- Supplied as a 225ml tube



JJ48308043 Aveeno daily moisturiser

### NEUTROGENA NORWEGIAN HAND CREAM

*Concentrated relief for dry chapped hands*

- Dermatologist recommended
- Fragrance-free
- Supplied as a 56g tube (over 200 applications)



JJ50203201 Neutrogena Norwegian hand cream



# ALSCO MANAGED FIRST AID KITS

**THE SAFE, RELIABLE OPTION FOR WORKPLACE FIRST AID.**

The checking is done for you!



- Stocked using hospital grade supplies
- Injury-specific 'Grab and Go' modules
- Removable door liner – replaced and recorded at each scheduled service
- 100% compliant with new Workplace H&S regulations

## ALSCO IN THE COMMUNITY

IN THE LAST 12 MONTHS ALSCO HAS DONATED:



ALSCO has initiated programmes to repurpose, reuse, recycle and redistribute linen, textiles, dispensers and expired first aid supplies.

We support a wide range of non for profit, sporting and local community organisations and initiatives. We are also involved in three key sponsorship initiatives with Medical Aid Abroad, Auckland City Mission and the Westpac Rescue Helicopter.

**6,820**  
SHEETS AND  
PILLOWCASES

**818**  
FIRST AID  
KITS

**460**  
HAND SANITISERS

**PLUS MUCH MORE!**



Contact Oraltec for more information



# Office Products

## TORK FOAM & LIQUID SOAPS

### FOAM SOAP

For use in dispensers



#### Tork Premium Extra Mild Foam Soap S4

- No perfume, colour or sulphate
- Not irritating to eyes
- Supplied as a 1 litre bottle

TO520701 Extra mild foam soap S4  
TO561500 Soap dispenser S4, white



#### Tork Premium Luxury Foam Soap S3

- For use with modern aluminium sensor dispenser
- Moistening formula produces rich lather
- Cost saving as one portion sufficient to wash hands
- Supplied as a 800ml box

TO500902 Luxury foam soap S3  
TO561600 Soap dispenser S3 sensor, white



### LIQUID SOAP

For use in dispensers



#### Tork Premium Soap S1 (Perfumed)

- Perfect for all normal hand washing
- Cleans and actively conditions the skin with a skin friendly, mild formulation
- Awarded Nordic ecolabel
- NZFSA accredited
- Supplied as a 1 litre bottle

TO420501 Premium soap S1, perfumed  
TO560000 Soap dispenser S1, white



#### Tork Premium Soap S1 Extra Hygiene

- Perfect to use in hygiene sensitive environments
- Highly effective against bacteria and approved according to European norms (EN 1040 and EN 1499)
- Perfume and colour free, minimises the risk for allergic reactions
- NZFSA accredited
- Supplied as a 1 litre bottle

TO420810 Premium soap S1, extra hygiene  
TO560000 Soap dispenser S1, white



## Think global, act local

Support the only local manufacturer of professional hygiene products in New Zealand.

Choosing Tork environmentally responsible solutions makes sense for your business as well as the planet.



What	Made in New Zealand	A responsible choice	Global innovation
<b>How</b>	<ul style="list-style-type: none"> <li>- The only manufacturer of tissue products in New Zealand</li> <li>- Directly employs more than 400 New Zealanders</li> </ul>	<ul style="list-style-type: none"> <li>- Tork dispensers are designed to reduce consumption and waste</li> <li>- Largest number of eco accredited products in the market</li> </ul>	<ul style="list-style-type: none"> <li>- #1 Professional Hygiene brand in the world*</li> <li>- Breadth of hygiene solutions and a dedicated global innovation team</li> </ul>
<b>Benefits to you</b>	<ul style="list-style-type: none"> <li>- Reliable supply</li> <li>- Visibility and control over the supply chain</li> <li>- Ability to support local economy</li> </ul>	<ul style="list-style-type: none"> <li>- Confidence</li> <li>- Compliance</li> <li>- Consumption reduction</li> </ul>	<ul style="list-style-type: none"> <li>- Confidence in industry leading expertise</li> <li>- Assurance of global industry best practice</li> <li>- Access to on-going global innovation</li> </ul>



For more information visit [tork.co.nz](http://tork.co.nz)

\* Based on 2013 Shared Market View data, input from certain local markets and some assumptions for Asia and MEIA, we are confident that with 14.8% of the global market, Tork is by far the biggest Professional Hygiene brand in the world.

# Oral Care Products

## ULTRASONIC SCALERS & POLISHERS

### LM PROPOWER DEVICES



#### UltraLED

LM-ProPower UltraLED is the ultimate tool for ultrasonic treatment. Due to its wide power range and a variety of tips, the scaler is designed to meet the needs of demanding professionals, still valuing patient comfort.



#### AirLED

LM-ProPower AirLED is a prophylaxis polisher with light. The powerful LED lights and precise powder jet ensure reliable and continuous operation, making the polisher a perfect cleaning tool for the diverse areas of dentistry.



#### CombiLED

LM-ProPower CombiLED conjoins the various features of the AirLED and the UltraLED into one versatile appliance that can be used for a wide range of ultrasonic and polishing treatments. It is an ultimate and undisputed power tool for upgrading your working environment to a new level of quality.



All devices available with tap water connector or bottle dispenser

### PROPHY POWDER

**LM air polishing prophylaxis powders - supragingival - used in conjunction with LM-ProPower devices**



An effective and reliable sodium bicarbonate powder for heavy stain and plaque removal from intact enamel surfaces.

LM-Sodium bicarbonate has a natural Xylitol-sweetener added which makes the taste even more fresh.

Available in 5 flavours - lemon, cherry, black raspberry, spearmint, and neutral

Available in 250g bottles or packs of 4 (either 4 of same flavour or a mixed pack of the 4 flavours, excluding neutral)



- LM10076SB\_ LM-Sodium prophylaxis powder - black raspberry
- LM10076SC\_ LM-Sodium prophylaxis powder - cherry
- LM10076SL\_ LM-Sodium prophylaxis powder - lemon
- LM10076SS\_ LM-Sodium prophylaxis powder - spearmint
- LM10076SN1 LM-Sodium prophylaxis powder - neutral (1 only)
- LM10076SMIX LM-Sodium prophylaxis powder - assorted flavours (4)

### LM SCALING TIPS

#### Heavy Calculus Removal

##### PE-32

Code LM100132

- Used for lingual and buccal supragingival scaling



##### PE-39

Code LM100139

- Used for universal, lingual and buccal supragingival scaling



##### PE-41A

Code LM100141A

- Used for universal, lingual and buccal supragingival scaling



#### Universal



##### PE-37

Code LM100137

- Universal tip especially developed for subgingival scaling, furcations, supragingival fine scaling and spot removal



##### PE-41P

Code LM100141P

- Used for universal, lingual and buccal supragingival scaling
- Can also be used for shallow pockets



#### Periodontics

##### PE-38

Code LM100138

- Used for lingual and buccal subgingival scaling and furcations
- Also suitable for supragingival fine scaling and spot removal



##### PE-40H

Code LM100140H

- Used for deeper subgingival scaling
- Especially suitable for lingual scaling of incisors



##### PE-40HS

Code LM100140S

- Universal tip for supra- and subgingival scaling
- Similar to PE-40H tip but with a slimmer shape
- The new thinner design enables better reachability into approximal spaces and deeper periodontal pockets



##### PE-41PS

Code LM100141PS

- Used for deeper lingual and buccal subgingival scaling
- Also suitable for supragingival fine scaling and spot removal



Ask about the complete range of scaler tips available

### LM-DURAGRADE TIP WRENCHES

LM10089S

Universal tip wrench



LM10088S

Torque tip wrench



# Oral Care Products

## VARIOS 970 IPIEZO SCALER

*Multifunction portable unit for extreme versatility*

*Available in Optic and Non-Optic*

### Advantages

- Stable vibration and powered by iPiezo engine
- Convenient large capacity bottles of 400ml each or different solutions with independent pumps
- Excellent illumination of the treatment area is guaranteed by the twin LEDs guided through twin glass rods

### Features

- Easily changeable solution bottles
- Designed for easy on site maintenance
- Touch control mode indicator endo, prior, general mode
- Clear power display for 10 power and irrigation flow setting
- Easy to use memory function to store user settings
- Touch control irrigation status selection - choose between dry operation, bottled solutions or external water supply
- Dual water adjustment controls for bottled or external water



Large LED display



Changeable bottles

NKY1001168 Varios 970 **Optic** (VA970 LUX) complete set  
 NKY1001175 Varios 970 **Non-Optic** (VA970) complete set

*Sets include control unit, handpiece, handpiece cord, 3 scaling tips (G4, G6, G8), foot control (FC-70), 2 x irrigation bottles, 3 x tip wrench with torque limiter, AC power cord and sterilisation case*

## VARIOS 170 IPIEZO SCALER

*Available in Optic and Non-Optic*

Varios 170 is a small built-in optic control module. It features the NSK iPiezo engine which ensures stable power output all the times. The slim and extremely lightweight handpiece with twin LED is easily added to the existing handpiece delivery unit and is controller via the existing foot control.



Sterilisation case

NKY1001351 Varios 170 **Optic** (VA170 LUXS1) complete set  
 NKY1001352 Varios 170 **Non-Optic** (VA1780S1) complete set

*Sets include built-in module, handpiece, handpiece cord, 3 scaling tips (G4, G6, G8), 3 x tip replacement wrench with torque limiter, sterilisation case (where the handpiece, tips and tip wrenches can be sterilised together)*

## VARIOS ULTRASONIC SCALER TIPS

### Scaling



- G1  
Code NKZ217101
- G2  
Code NKZ217102
- G3  
Code NKZ217103
- G4  
Code NKZ217104
- G5  
Code NKZ217105
- G6  
Code NKZ217106
- G8  
Code NKZ217108
- G9  
Code NKZ217109
- G11  
Code NKZ217411
- G12  
Code NKZ217412
- G13  
Code NKZ217413



### Perio (root planing)



- P1  
Code NKZ217404
- P1D  
Code NKZ217405 *Diamond coated*
- P2D  
Code NKZ217402 *Diamond coated Right curved type*
- P3D  
Code NKZ217403 *Diamond coated Left curved type*
- P10  
Code NKZ217410 *Sharp edge*



# Oral Care Products

## AIR SCALER

### TI-MAX S970 SERIES

The S970 air scaler offers a wide power range with easy swivel power adjustment and an extensive tip range for a wide variety of applications ranging from general scaling and root canal irrigation, to minimally invasive procedures. The wide range of applications, comfortable grip and ease of maintenance, makes the S970 air scaler the instrument of choice for dentists and hygienists alike. A titanium body and sleek, seamless design make the S970 really comfortable to hold even during long procedures whilst allowing for excellent visibility of the operating site at all times.

#### Advantages

- Twin LED lights through twin optical glass rods
- Optic and non-optic handpieces available
- Extensive tip range for a wide range of applications

#### Features

- Titanium body with scratch resistant DURACOAT
- 3 level power ring
- Frequency of oscillation: 5,800-6,200 Hz
- Cellular glass optics
- Includes 3 tips (S1, S2 and S3), tip wrench (CR-20) and tip cover (L)



- NKT1005 Ti-Max S970L\* Optic  
 NKT1020 Ti-Max S970\* Non-Optic  
 \*with NSK coupling



Also available for KaVo and Sirona couplings

### TI-MAX AIR SCALER TIPS

#### Scaling

- |                      |  |                |
|----------------------|--|----------------|
| S1<br>Code NKZ252411 |  | Universal type |
| S2<br>Code NKZ252413 |  | Sickle type    |
| S3<br>Code NKZ252412 |  | Perio type     |

#### Perio

- |                        |  |                                 |
|------------------------|--|---------------------------------|
| S10<br>Code NKZ252420  |  | Universal type, slim line       |
| S20<br>Code NKZ252441  |  | Root planing (straight tip)     |
| S21R<br>Code NKZ252442 |  | Root planing (right curved tip) |
| S21L<br>Code NKZ252443 |  | Root planing (left curved tip)  |

## AIR POWERED TOOTH POLISHING SYSTEM

### PROPHY-MATE NEO

Air powered tooth polishing system



#### Features

- Newly introduced selectable 60° and 80° nozzles increase cleaning efficiency
- Lightweight and compact handpiece
- Two 360° twist-free swivel joints for better access and more comfort

#### Applications

- Removal of plaque and discolouration
- Etching of enamel, dentine and porcelain prior to bonding
- Preparation for pit and fissure sealant

#### Advantages

- Sturdy and reliable
- Simple to operate
- Easy maintenance
- Quick connect to major turbine couplings



NKPMNGPTLP Proply-Mate neo complete system\*  
 \*with NSK coupling

Includes handpiece with 60° nozzle head, powder case, replacement nozzle head 80°, 5 pieces x 15g sachets of FLASH pearl cleaning powder and maintenance kit

Also available for KaVo, Sirona, W&H, Bien-Air, M4 and B2 couplings

### FLASH PEARL CLEANING POWDER

Used in conjunction with NSK Proply-Mate NEO

Spherical particulate powder designed to roll smoothly over tooth surfaces and penetrate all corners for rapid cleaning. The spherical shape of the powder granules lessens the likelihood of damage to teeth and soft tissue while removing stains and plaque quickly and safely.

- Powerful, quick results
- Soft and gentle
- Sodium-free natural taste
- Biodegradable and non-clogging
- Suitable for all other manufacturers' air polishing systems



Supplied as 1 x 300g bottle with measuring cup

NKY900698 Flash Pearl cleaning powder

Contact **Oraltec** for all your dental supply requirements

Proud to be New Zealand owned and operated



# Oral Care Products

## LISTERINE® MOUTHWASHES

### TOTAL CARE®

*A unique, 6 in 1 formula with proven benefits*

Listerine Total Care® is the most comprehensive Listerine® mouthwash ever developed, providing a whole mouth clean - an integral part of the Brush + Floss + Rinse regime.

#### Proven efficacy with added benefits

- Essential oils interfere with bacterial adsorption onto teeth and slow bacterial regeneration time
- Contains fluoride to strengthen teeth enamel and help resist decay
- Contains zinc chloride to slow the formation calculus on teeth

JJ303044 Listerine Total Care - 500ml  
JJ303044 Listerine Total Care - 1 litre



### ZERO

*The less intense, zero alcohol formula cleans deep to kill millions of bad breath germs for a cleaner, fresher mouth*

- Clean mint flavour
- Unique alcohol-free formula

JJ43302056 Listerine Zero - 500ml  
JJ43302057 Listerine Zero - 1 litre



Contains no alcohol

### TOTAL CARE SENSITIVE

*Provides all-round protection against sensitive teeth, targeting the multiple causes of sensitivity*

- Essential oils interfere with bacterial adsorption onto teeth and slow bacterial regeneration time
- Contains potassium nitrate which reduces sensitivity

JJ43309033 Listerine Total Care Sensitive - 500ml



### TEETH DEFENCE®

*Strengthens teeth against cavities and kill germs that cause bad breath, plaque and gingivitis*

- Essential oils interfere with bacterial adsorption onto teeth and slow bacterial regeneration time
- Contains 100ppm sodium fluoride to strengthen enamel

JJ304033 Listerine Teeth Defence - 500ml  
JJ304035 Listerine Teeth Defence - 1 litre



### TARTAR CONTROL

*Fights and reduces tartar build-up and kills the germs that cause gingivitis, plaque and bad breath*

- Contains zinc chloride to reduce tartar build up

JJ303033 Listerine Tartar Control - 500ml



### COOLMINT® and FRESHBURST®

*Antiseptic mouthwash kills the germs that cause bad breath, plaque and gingivitis*

JJ301050 Listerine Coolmint - 500ml  
JJ301048 Listerine Coolmint - 1 litre  
JJ301056 Listerine Freshburst - 500ml  
JJ301058 Listerine Freshburst - 1 litre



### LISTERINE SMART RINSE - BERRY SHIELD

*An anti-cavity alcohol free mouthwash with fluoride that helps strengthen teeth against cavities*

- Active ingredient cetylpyridinium chloride (CPC)
- Specially developed for children six years plus

JJ313033 Listerine Smart Rinse Berry Shield - 500ml



Contains no alcohol

## OTHER MOUTH WASHES

### MINT AND BERRY DROPS

*Fresh mint and berry flavoured mouthrinse concentrates for pre-operative and post-operative rinsing*

- Contains 33% alcohol



Supplied as a 200ml pump bottle

PD33904 Mint drops mouthrinse  
PD33905 Berry drops mouthrinse



### ALCOHOL-FREE MINT DROPS

*Pleasant flavoured concentrate that, when diluted in water, refreshes the mouth on rinsing before and after dental procedures*

- Spearmint flavour



Supplied as a 200ml pump bottle

PD33907 Alcohol-free mint drops mouthrinse



Contains no alcohol

### FRESH4SURE MOUTH CARE SYSTEM

*Cavex Fresh4Sure – breathe freshness*



Cavex Fresh4Sure (F4S) is a unique 3-step mouth care system which helps to restore the balance between beneficial and problem bacteria in a natural manner. This creates a healthy oral environment as well as a fresh oral odour.

- No alcohol
- No SLS (sodium lauryl sulphate)
- No antibiotics

CAMW010 Fresh4Sure mouthwash 500ml  
CAMW020 Fresh4Sure tongue gel 45g  
CAMW030 Fresh4Sure kit  
(includes tongue cleaner, mouthwash, tongue gel)



Contains no alcohol

### CHLOROFLUOR MOUTH RINSE with fluoride

*Chlorhexidine and fluoride mouth rinse for use in the treatment of oral gingival infections and plaque control*

- For the control of minor infections and to ease associated discomfort
- Used as an aid to oral hygiene after oral surgical procedures or jaw fixation
- Used to control plaque growth on removable prosthodontic or orthodontic appliances

#### Composition

- Chlorhexidine gluconate 0.2% w/v
- Sodium fluoride 0.003% w/v
- Alcohol 8.9% v/v



Supplied as a 250ml bottle

PD35500 Chlorofluor mouth rinse



### PLASTIC CUPS

- Thin and light white polystyrene cups
- 210ml / 7oz
- Box of 1,000 cups (packed 10 x 100 cups)

GECUPS Plastic cups



# Oral Care Products

## TOOTHBRUSHES

### REACH TOOTHBRUSHES

- Ask about the latest range of toothbrushes from Reach



### LUXIDENT TOOTHBRUSHES

- Ask about the latest range of toothbrushes from Luxident



### CAVEX RUSH BRUSH

*Disposable toothbrushes with toothpaste*

- Soft toothbrushes pre-impregnated with invisible fresh minty toothpaste
- The small head and soft round bristles for both adults and children
- Individually packed in a sealed bag



Supplied as a box of 100 (of four assorted colours - green, blue, red, yellow)

CAHA090 Cavex Rush Brush - box of 100

### TOOTHBRUSHING DEMONSTRATOR

- Hinged upper and lower
- Great for giving chairside demonstration of brushing techniques
- Teeth model and tooth brush sold separately

SVPRO50 Teeth model (upper and lower)

SVPR0055 Toothbrush demonstrator



## DENTURE BRUSHES

### DENTURE BRUSHES

*This well proven denture brush is totally manufactured in New Zealand*



The Luxident twin tuft denture brush is a well proven, effective design for cleaning partial and full dentures, with two brush heads for more efficient cleaning. It is ergonomically styled with elegance, providing a strong and comfortable non-slip handle, which can be easily gripped by those with arthritic hands.

- Available in pastel or bright colours with soft or medium bristles

Supplied as a packet of 12 individually packaged denture brushes



LU491 Pastel colours - soft  
LU413 Pastel colours - medium  
LU413B Bright colours - medium



Please also ask about personalised denture brushes (conditions apply)

## REACH FLOSS & FLOSSERS

### REACH CLEANBURST SPEARMINT FLOSS

- Spearmint
- Waxed
- Supplied as 6 packets of 50m floss



JJ41914031 Reach Cleanburst floss

### REACH WAXED FLOSS

- Shred resistant
- Waxed, plain
- Supplied as 6 packets of 50m floss



JJ41802036 Reach waxed floss

### REACH DENTOTAPE

- Extra wide waxed floss/tape
- Supplied as 6 packets of 20m floss



JJ41901037 Reach Dentotape

### REACH CLEANPASTE FLOSSER

*A solution to help patients floss more often*



- Disposable snap-on head
- Icy-mint flavour
- Available as a starter pack and in refill packs

JJ42031036 Cleanpaste flosser starter kit (6 x flossers each with 8 heads)

JJ42031037 Cleanpaste flosser refills (6 x strips of 28 heads)



## SPECIALIST FLOSS

### BRIDGE AND IMPLANT FLOSS

*For cleaning of dental bridge and implants*

A special-use, interproximal dental cleaner that features an extra-thick brush section to clean around dental implants and under bridgework. An ultra-stiff threader on each end of the brush allows the user to thread the product without the need for a separate floss threading loop. This product is also excellent for cleaning around braces.



TRFLOSSBD Box of 30 pre-cut strands



### PERIODONTAL FLOSS

*For periodontal disease and other gum ailments*

A special use, dental floss that features a built-in-ultra-stiff threader, floss and extra thick brush section to clean large spaces between teeth that are caused by gum recession.



TRFLOSSPD Box of 75 pre-cut strands

### 3 IN 1 FLOSS

*For all purpose flossing*



A special everyday floss, built-in threader, brush and floss section, all on one strand. For cleaning and "brushing" teeth, under bridges, and around braces.



TRFLOSS3D Box of 100 pre-cut strands

# Oral Care Products

## INTERDENTAL BRUSHES

### PROXIMALL BRUSHES

*ProximAll's soft ergonomic handle provides the user with maximum grip, comfort and control*

- High quality, long-lasting Tynex bristles are used for effective cleaning
- Wires are plastic coated and flexible
- Each brush is supplied with a plastic cap
- 7 colour coded sizes from 0.45mm to 1.1mm
- 4 brushes neatly packed in colour-coded compact packaging



Supplied as a box of 12 packets of 4 (of same size) (ie 48 per box)



- |        |                            |
|--------|----------------------------|
| CR6704 | Pink - XXXX fine (0.45mm)  |
| CR6706 | Orange - XXX fine (0.50mm) |
| CR6708 | Red - XX fine (0.60mm)     |
| CR6710 | Blue - X fine (0.70mm)     |
| CR6712 | Yellow - fine (0.80mm)     |
| CR6714 | Green - medium (0.90mm)    |
| CR6716 | Purple - large (1.1mm)     |



### INTERBRUSH INTERDENTAL CLEANERS

*Soft, wire-free interdental brushes*

- The economic option for your surgery
- The unique InterBrush design prevents trauma to teeth, gums, implants, crowns and bridges
- InterBrush has no metal parts
- The tapered brush tips ensure easy insertion with improved cleaning and stimulation of the gingival tissue



Supplied as a pack of 36 cases per box (10 brushes per case)

Available in three sizes

- |        |                               |
|--------|-------------------------------|
| CR7115 | Blue - small (1.5 - 3.5mm)    |
| CR7120 | Orange - medium (2.6 - 4.4mm) |
| CR7125 | Purple - large (2.1 - 7mm)    |

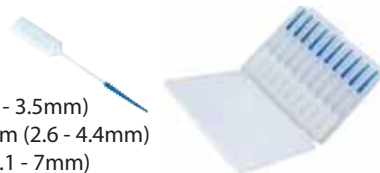

### PERIOPROX HANDLE WITH TAPERED BRUSH

*Interdental handle and brush*

Unique angled brush head ideal for getting into all those difficult hard to get areas

- |        |  |
|--------|--|
| CR6600 | Perioprox handle with tapered brush - supplied as a packet of 12                             |
| CR6610 | Perioprox tap brush refill - supplied as a packet of 12 drums, each drum contains 10 brushes |



## DESENSITISERS

### SUPER SEAL DESENSITISER

*Potassium oxalate based, acid resistant liner and desensitiser that assists in the removal of the smear layer and seals the tubules*

SuperSeal can be used for a wide range of applications including:

- Before and after prophylaxis
- Treating exposed root surfaces
- Before and after bleaching
- Thermal sensitivity
- Under restorations
- During temporisation

- Glutaraldehyde free
- Water-based potassium oxalate
- Soft tissue friendly
- Removes smear layer
- Re-wetting agent
- Do not refrigerate
- No light curing
- Simple one step process



PH100295 SuperSeal - 5ml

### BITE&WHITE EXSENSE

*Tooth conditioner*



Cavex Bite&White ExSense offers fast and long-lasting relief from sensitive teeth thanks to a revolutionary blend of hydroxyapatite and a 'hydro-dispersing clay'.

The areas causing sensitivity are sealed off completely, while at the same time, a process of crystallisation helps to restore micro-hardness and accelerates the remineralisation process.

- Reduces tooth sensitivity
- Helps prevent sensitive teeth
- Accelerates and enhances the remineralisation process
- Leaves the surface of the teeth smooth and gleaming
- Strengthens and extends the whitening effect after bleaching
- Slows down the process of plaque formation



CABW060 Cavex Bite&White ExSense - 50g tube

### BIFLUORID 10

*Fluoride varnish for the treatment of dental hypersensitivity*

**Treatment of hypersensitivity including:**

- sensitivity after professional cleaning and calculus removal
- cervical area and crown margins
- tooth surfaces after preparation and/or grinding
- worn occlusal surfaces and teeth carrying clasps
- after injury of the enamel (eg fractures, chips)
- sealing cavity margins after restoration, especially after the etching technique
- as a dentine protection/lining under amalgam fillings

**Advantages**

- Immediate relief
- Formation of a protective coat against thermal and mechanical influences
- Transparent - no discolouration of teeth
- Long-term effects and deep fluoridation



VO1616 Bifluorid 10 - 10g bottle  
VO1618 Bifluorid 10 SingleDose - box of 50





# Oral Care Products

## ADMIRA PROTECT

*Light-curing Ormocer-based protective desensitiser*

Ideal for the treatment of hypersensitive dentine and cervical areas

### Advantages

- Permanent elimination of hypersensitivity
- Biocompatible
- Fluoride release
- Reliable adhesion
- High abrasion resistance
- Tooth coloured



VO1650 Admira Protect 4.5ml bottle  
VO1651 Admira Bond SingleDose - box of 50

## REMIN PRO

*Natural, milk-free remineralising cream for teeth*



With Remin Pro, teeth are strengthened, remineralisation and desensitisation are promoted, salivation is stimulated and the acidic environment is neutralised. It assists with sealing open dentine tubes.

Remin Pro combines three proven components for effective protection against demineralisation and erosion:

- Fluoride
- Hydroxyl apatite
- Xylitol

Available in three flavours - melon, mint or strawberry

### Available in

- 1 x 40g tube - specify flavour
- 3-pack (3 x 40g tubes, either one of each flavour or assorted pack)
- 12-pack (12 x 40g tubes, 4 of each flavour)
- Box of 50 x 2.5g SingleDose - specify flavour



Patient brochures also available on request

## PROFLUORID VARNISH

*Fluoride-containing dental desensitising varnish (5% NaF)*

For treatment of hypersensitive teeth and sealing the dentinal tubules for cavity preparations or on sensitive root surfaces.

### Advantages

- Tooth-shaded varnish
- Easy to apply - with excellent adhesion even to wet tooth surfaces
- Economical application in thin layers, high yield
- Ideal for treating cervical areas after professional cleaning and calculus removal



Available in tubes (10ml)

VO1267 Melon  
VO2232 Caramel  
VO2233 Cherry  
VO2234 Mint

Also available in practical SingleDose boxes (0.4ml) in 50 or 200

- Easy, quick and hygienic
- No additional devices required
- No spilling in any position

VO22\_ SingleDose boxes  
- specify flavour and box size (50 or 200)



## ANALGESICS

### IBUPROFEN®

*A well-known and well-tolerated analgesic and anti-inflammatory*

**Dose:** Packs have directions of use:

1-2 tablets every 4 hours, maximum 6 tablets per day. Interactions include: digoxin, lithium, methotrexate, tacrolimus, warfarin

**Contra indications:** Allergy to any NSAID, onset of asthma, rhinitis, nasal polyps with any NSAID, peptic ulcer, gastro-intestinal bleeding

**Precautions:** Pregnancy, breast-feeding, history of gastro-intestinal disease, renal disease, asthma, coagulation disorders, elderly

**Side effects:** Gastric upset, dizziness, allergy, worsening of asthma

- Lowers temperature, relieves pain and reduces inflammation
- Effective for dental pain
- Contains 200mg ibuprofen per tablet



Supplied as a box of 20 tablets

MUIP20047 Ibuprofen

### PARACETAMOL®

*A well-known and well tolerated analgesic that can be taken by almost all patients*

**Dose:** Packs have directions of use:

1-2 tablets every 4 hours, maximum 8 tablets in 24 hours

**Contra indications:** Paracetamol allergy

**Precautions:** Hepatic or renal disease

Avoid concomitant use of other paracetamol containing products

**Side effects:** Rarely hypersensitivity, skin rash

- Lowers temperature, relieves pain and reduces inflammation
- Effective for dental pain
- Contains 500mg paracetamol per tablet



Supplied as a box of 20 tablets

MUPARA20 Paracetamol

## ORAL MEDICINE

### AFTAMED

*For the management of aphthous ulcers and lichen planus*

Contains hyaluronic acid in a special mucoadhesive matrix. The combination of these two factors is effective.

- Effective
- Provides immediate pain relief
- Promotes healing
- Helps prevent recurrences
- Safe



BOAFTAMEDG Aftamed gel - 15ml tube  
BOAFTAMEDS Aftamed spray - 20ml spray  
BOAFTAMEDM Aftamed mouthwash - 150ml bottle

*Copies of scientific studies also available on request*

# Oral Care Products

## CHLOROFLUOR GEL

*Mouth gel with fluoride*

Chlorofluor Gel is used for the control of minor infections and to ease associated discomfort. Also used as an aid to oral hygiene after oral surgical procedures or jaw fixation and to control plaque growth on removable prosthodontic or orthodontic appliances.

- Aids in the treatment of gingivitis
- Helps prevent tooth decay
- Ideal for use following oral surgery
- Aids with healing of oral mucosa
- Reduces inflammation



### Composition

- Chlorhexidine gluconate 0.2% w/v
- Sodium fluoride 0.003% w/v

PD35530 PDS Chlorofluor gel - 30ml plastic dropper bottle

PD35533 PDS Chlorofluor gel - 100ml pump bottle

PD35532 PDS Chlorofluor gel - 250ml bottle

## PERIOPACK MINI

*The long-term, non-staining pharmacological solution to the management of gingivitis, periodontal disease and peri implantitis*

- Alternate brushing with Chlorofluor and Bright Teeth gel rapidly resolves gingival inflammation and assists with the management of periodontitis and peri implantitis
- Easy to use - patients simply brush teeth with Chlorofluor prior to retiring and then in the morning, after breakfast, with Bright Teeth gel for one minute. They should not rinse or drink for at least an hour after brushing.
- Aids in management of residual pockets which helps gingival tissues to heal themselves



PD35512 Periopack Mini

Kit contains 30ml Chlorofluor gel and 30ml Bright Teeth gel and instructions



## FISSURE SEALING

### GRANDIO® SEAL

*Light-curing nano-hybrid fissure sealant*

#### Advantages

- Optimal flow behaviour
- 70% w/w highest filler content
- Low abrasion
- High strength
- Low shrinkage values
- Excellent handling



VO1061 Grandio® Seal - 2 x 2g syringes

### FISSURIT® F

*Light-curing fissure sealant with fluorides, white*

#### Advantages

- Quick and direct application
- Excellent flow properties and low viscosity
- High stability and good adhesion to enamel
- Perfect marginal adaptation
- Continuous fluoride release



Supplied as 2 x 2g syringes + accessories

VO1292 Fissurit® F

## GUARDIAN SEAL FILLED PIT AND FISSURE SEALANT

*Fluoride-releasing pit and fissure sealant, which provides superior protection against occlusal decay.*

This 30%-filled material offers the perfect combination of flow, opacity and wear-resistance.



- High concentration of fluoride release
- Easy placement of material
- Opaque enough to see on the occlusal surface, yet translucent enough to detect caries



Supplied as a packet of 4 x 1g syringes sealant material + 40 brush tips

KR31169 Guardian Seal

## DISCLOSING PRODUCTS

### PLAQUE DISCLOSING GEL

*To make dental plaque visible during demonstration of oral hygiene procedures*

For surgery and home use

Erythrosine stains dental plaque pink on affected teeth

PD33405

Disclosing gel - 30ml

PD33425

Disclosing gel - 250ml



### PLAQUE 2 TONE DISCLOSING SOLUTION

*Two tone disclosing solution*

- Pink colour indicates NEW plaque
- Purple colour indicates OLD plaque

Supplied as a 30ml bottle

PD33406

Plaque 2 Tone disclosing solution



### TRACE DISCLOSING TABLETS

*To make dental plaque visible during demonstration of oral hygiene procedures*

Trace® disclosing tablets stain plaque red without leaving a bitter aftertaste in the patient's mouth.

Supplied as a box of 250 tablets

YO232225

Disclosing tablets



### RONDELL PLAQUE DISCLOSING PELLETS

*A unique and swift system for checking plaque*

Presoaked pellets which can be applied to the tooth surfaces with the help of a pair of tweezers.

- Plaque younger than 3 days old will turn red
- Plaque older than 3 days will turn blue
- Mild peppermint flavour
- Supplied as a packet of 100 pellets

SVPRO155

Disclosing pellets



**now** There has never been a better time to refresh your smile than **now**.



- The **now** Whitening system enables super-efficient teeth whitening without the time and expense of making individual custom trays.
- The innovative reusable silicon trays fit comfortably, and the carbamide peroxide gel ensures little or no sensitivity with superior whitening results.

Available in 10% and 16% Carbamide Peroxide  
View the **now** Teeth Whitening Video here:

<https://youtube/BMOablWdeSA>



Order Codes:

- 34427 - NOW 10 Whitening Kit (contains 2 silicon trays, storage box, 30ml whitening gel)
- 34420 - NOW 10 Refill 30ml
- 34425 - NOW 16 Whitening kit (contains 2 silicon trays, storage box, 30ml whitening gel)
- 34422 - NOW 16 Refill 30ml gel

## PERIOPACK and PERIOPACK+

Brushing alternately morning and night with Chlorofluor and Bright Teeth gel will:

- resolve gingival bleeding,
- reduce dental decay,
- whiten the teeth.

Chlorofluor combines chlorhexidine with fluoride to improve gingival health and reduce caries. Bright Teeth gel, 10% carbamide peroxide, assists with gingival bleeding and will whiten the teeth.

Watch the video here: <http://youtube/Xs5pBVaaCyM>



Order codes:

- 35512 - Periopack (1 x 30 ml Chlorofluor gel and 1 x 30ml Bright Teeth gel)
- 35511 - Periopack + (1 x 30 ml Chlorofluor gel, 1 x 30 ml Bright teeth gel, 1 mouthguard container, 2 x thermosplints)



The 3 in 1 solution for Healthy Teeth and Gums

## Chlorofluor

Chlorhexidine and Fluoride Gel for use in the treatment of oral gingival infections and plaque control. Also improves resistance to dental caries. Can be used in custom made trays or applied with a toothbrush.

**Chlorofluor contains:** Chlorhexidine Gluconate 0.2% w/v and Sodium Fluoride 0.0033 % w/v  
Clinical studies show that anti-plaque efficacy is greater when fluoride is combined with Chlorhexidine \*

### INDICATIONS

- Chlorofluor Gel and Mouthrinse is used for
- the control of minor oral infections.
- to resolve gingival bleeding
- an adjunct in the treatment of gingivitis and periodontal disease.
- assists with oral hygiene after oral surgical procedures including jaw fixation
- control of plaque growth on removable prosthodontic or orthodontic appliances.



Order Codes:

- 35533 - 100ml Pump Pack
- 35532 - 250ml bottle
- 35530 - 30ml I bottle
- 35500 - 250ml mouthrinse

\*J Clin Diagn Res. 2016 Jul;10(7):ZC62-5. doi:10.7860/JCDR/2016/18080.8186. Epub 2016 Jul 1. Effect of Chlorhexidine with Fluoride Mouthrinse on Plaque Accumulation, Plaque pH - A Double Blind Parallel Randomized Clinical Trial.



PROFESSIONAL DENTIST SUPPLIES PTY LTD

3/8 Nicole Close, Bayswater Nth, Vic 3153, Australia

T +613 9761 6615 | F +613 9761 6566 | E: [sales@profdent.com.au](mailto:sales@profdent.com.au) | [www.profdent.com.au](http://www.profdent.com.au)

# Oral Care Products

## PROPHY PRODUCTS

### PROPHY PASTE

Available in pink (bubblegum) or white (spearmint) and with fluoride, unless otherwise stated

Supplied as a 250g jar

YO033309	Pink, fine
YO033409	Pink, coarse
YO033109	White, fine
YO033209	White, coarse
YO033609	White, coarse without fluoride



### PROPHY POWDER

*LM air polishing prophylactic powders - supragingival - used in conjunction with LM-ProPower devices*

An effective and reliable sodium bicarbonate powder for heavy stain and plaque removal from intact enamel surfaces.

LM-Sodium bicarbonate has a natural Xylitol-sweetener added which makes the taste even more fresh.

Available in 5 flavours - lemon, cherry, black raspberry, spearmint, and neutral

Available in 250g bottles or packs of 4 (either 4 of same flavour or a mixed pack of the 4 flavours, excluding neutral)

LM10076SB_	LM-Sodium prophylactic powder - black raspberry
LM10076SC_	LM-Sodium prophylactic powder - cherry
LM10076SL_	LM-Sodium prophylactic powder - lemon
LM10076SS_	LM-Sodium prophylactic powder - spearmint
LM10076SN1	LM-Sodium prophylactic powder - neutral (1 only)
LM10076SMIX	LM-Sodium prophylactic powder - assorted flavours (4)



### FLASH PEARL CLEANING POWDER

*Used in conjunction with NSK Prophy-Mate NEO*

Spherical particulate powder designed to roll smoothly over tooth surfaces and penetrate all corners for rapid cleaning. The spherical shape of the powder granules lessens the likelihood of damage to teeth and soft tissue while removing stains and plaque quickly and safely.

- Powerful, quick results
- Soft and gentle
- Sodium-free natural taste
- Biodegradable and non-clogging
- Suitable for all other manufacturers' air polishing systems

Supplied as 1 x 300g bottle with measuring cup

NKY900698	Flash Pearl cleaning powder
-----------	-----------------------------



### PROPHY CUPS

*Oraltec private label Oracups*

- Each supplied as a packet of 36

ORCUPRA	Latch grip/RA - white
ORCUPSC	Screw-In - white
ORO54201	Screw-In - blue (latex free)
ORCUPSNP	Snap-On - blue (latex free)

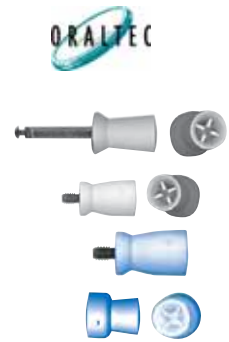

### PROPHY BRUSHES - Stoddard Junior

#### Screw type

STBRUSS36	Screw - packet of 36
STBRUSS144	Screw - packet of 144

#### Latch grip/right angle type

STBRUSR36	Latch grip/RA - packet of 36
STBRUSR144	Latch grip/RA - packet of 144



## DAPPEN DISHES

### RING POTS

- Single use device
- Easy to be mounted, "elastic" (all finger sizes), stays in place during paste application
- Can be used with all delivery types of pastes (jar, tubes and monodoses)
- Ergonomic shape

Supplied as a packet of 100 blue dappen dishes

KR985	Ring pots
-------	-----------



### GLASS DAPPEN DISHES

- Made from high quality glass
- Sold individually

SVAUX088	Glass dappen dish - dark blue
LAV2AM	Glass dappen dish - amber
LAV2BL	Glass dappen dish - blue
LAV2TR	Glass dappen dish - clear
LAV2GR	Glass dappen dish - green



### PLASTIC DAPPEN DISHES

- Inexpensive plastic disposable dappen dishes
- Assorted colours - white, blue, red and yellow (can supply individual colours on request)

Supplied as a packet of 100

SVDIS250	Plastic dappen dishes
----------	-----------------------



### DAPPEN SILICONE BOWL

- Silicone dappen bowl 5ml
- Approximate size - ø 2.5cm x H2.8cm

LABOWLD12	Dappen bowl D12
-----------	-----------------



# Orthodontic Products

## CLASPS

### ADAMS CLASPS

*Modified form for optimised retention and easy adjustment*

- Made of nickel-free menzanium alloy
- Sizes - 6mm, 8mm, 10mm (W) x 0.7mm (D)
- Supplied as a packet of 100

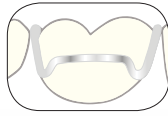

- SC2104 Adam clasp 6mm  
 SC2106 Adam clasp 8mm  
 SC2108 Adam clasp 10mm



### BALL ANCHOR CLASPS

*Unique retention and spring force - made of high-corrosion resistant stainless steel alloys*

- Supplied as a packet of 10 or 100
- Available in lengths 0.7mm, 0.8mm, 0.9mm, 1mm and 1.2mm

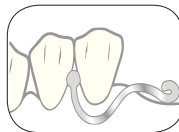

- SC20\_ Ball clasp - specify size

### J CLASPS

- Supplied as a packet of 10 or 100

- SC1017 J clasp 0.8mm - packet of 10  
 SC10172 J clasp 0.8mm - packet of 100  
 SC1018 J clasp 0.9mm - packet of 10  
 SC10182 J clasp 0.9mm - packet of 100  
 SC1019 J clasp 1.0mm - packet of 10  
 SC1023 J clasp 1.2mm - packet of 10



### JM CLASPS

- Supplied as a packet of 100

- SC1023 JM clasp 1.2mm

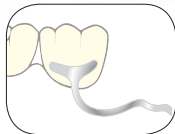

### J CLASP OBLIQUE

- Supplied as a packet of 10 or 100
- Packets include pairs of left and right

- SC1020 J clasp oblique 0.8mm - packet of 10  
 SC10202 J clasp oblique 0.8mm - packet of 100  
 SC1021 J clasp oblique 0.9mm - packet of 10  
 SC10212 J clasp oblique 0.9mm - packet of 100  
 SC1022 J clasp oblique 1.0mm - packet of 10

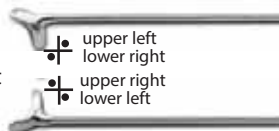

### N CLASPS

- Supplied as a packet of 10

- SC1009 N clasp 0.9mm  
 SC1010 N clasp 1.0mm

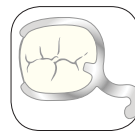
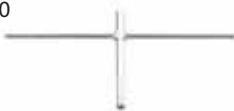

### NK CLASPS

- Supplied as a packet of 10

- SC1013 NK clasp 0.8mm



### O CLASPS

- Supplied as a packet of 10 or 100

- SC1002 O clasp 0.9mm - packet of 10  
 SC10022 O clasp 0.9mm - packet of 100

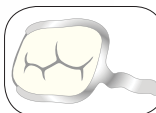

## TRIANGLE CLASPS

*Made of nickel-free menzanium alloy, cold-formed, with highly polished surface*

- Excellent elasticity and strength
- Supplied as a packet of 100

- SC2288 Triangle clasps 0.7mm  
 SC2322 Triangle clasps 0.8mm

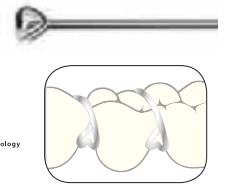

## LINGUAL BARS

- Elliptical profile bar (200mm) made of a hard chrome-nickel-alloy
- Supplied as a packet of 5

- SC1051 Lingual bar, curved, small (L60mm)  
 SC1052 Lingual bar, curved, medium (L70mm)  
 SC1053 Lingual bar, curved, large (L80mm)

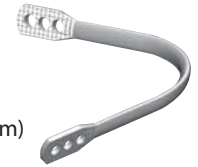

## WIRES

### CHROMIUM COILED WIRE

- Chromium coil wire is diamond drawn and highly polished and can be used for joining techniques, laser welding and welding

Hard 1400 - 1600 N/qmm			Spring Hard 1800 - 2000 N/qmm		
mm Ø	Length M	Code	mm Ø	Length M	Code
0.50	50	8323	0.50	50	8330
0.60	40	8324	0.60	40	8331
0.70	30	8325	0.70	30	8332
0.80	20	8326	0.80	20	8333
0.90	10	8327	0.90	10	8334
1.00	10	8328	1.00	10	8335
1.10	10	8329	1.10	10	8338



- SC832\_ Chromium wire, hard - specify size  
 SC833\_ Chromium wire, spring hard - specify size

### MENZANIUM COILED WIRE

- Menzanium is a nickel-free alloy, fabricated in a patented high-pressure melting process replacing allergenic nickel components by manganese and nitrogen
- Higher corrosion resistance and strength
- Spring-hard (1,800 - 2,000 N/mm<sup>2</sup>)



- SC8462 Menzanium wire - spring hard 0.8mm x 20m  
 SC8463 Menzanium wire - spring hard 0.9mm x 10m  
 SC8464 Menzanium wire - spring hard 1.0mm x 10m  
 SC8466 Menzanium wire - spring hard 1.2mm x 10m

# Orthodontic Products

## VECTOR EXPANSION SCREWS

### VECTOR® 50

- Skeletal miniature expansion screw with bright yellow directional arrow for transverse expansion of the lower jaw
- Can be used in narrow upper jaws as well as for single tooth movement
- Supplied as a packet of 10

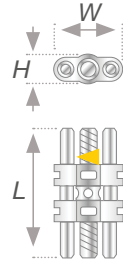
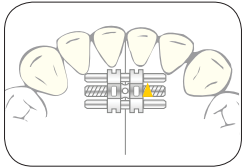

SC2489 Vector 50 expansion screws  
W4.8 x H2.5 x L10 mm, expansion 3mm

### VECTOR® 90

- Expansion screw with bright yellow directional arrow used for transverse and sagittal expansion of the lower and upper jaw
- Notches on the guide pins prevent screw from exceeding maximum expansion
- Supplied as a packet of 10

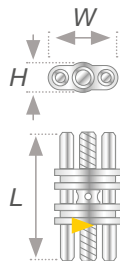
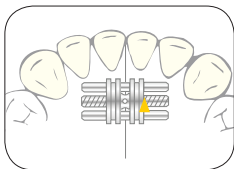

SC2491 Vector 90 expansion screws  
W6.2 x H3 x L10 mm, expansion 4mm

### VECTOR® 140

- Expansion screw with bright yellow directional arrow used for transverse and sagittal expansion of the lower and upper jaw
- Notches on the guide pins prevent screw from exceeding maximum expansion
- Supplied as a packet of 10

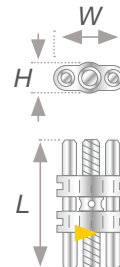
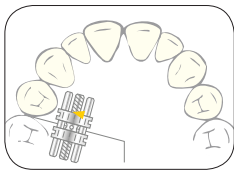

SC2494 Vector 140 expansion screws  
W7.5 x H3.3 x L12 mm, expansion 5mm

### VECTOR® 190

- Stable expansion screw with bright yellow directional arrow used for transverse expansion of the upper and lower jaw and bimaxillary appliances
- Additional retention holes in the housing of the screws for maximum retention in the acrylic
- Supplied as a packet of 10

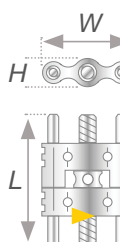
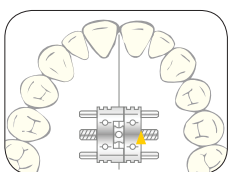

SC2497 Vector 190 expansion screws  
W9.8 x H3.1 x L10 mm, expansion 5mm

### VECTOR® 350

- Skeletal miniature sector expansion screw with bright yellow directional arrow for single tooth movement and segment movement in upper and lower jaw
- Supplied as a packet of 10

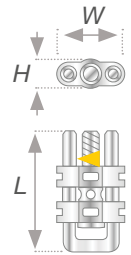
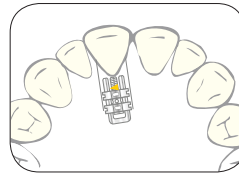

SC2509 Vector 350 expansion screws  
W4.8 x H2.5 x L10 mm, expansion 4mm

### VECTOR® 720 acc. to Bertoni

- Special expansion screw with bright yellow directional arrows for insertion in multi-sector plates, enabling separate protrusion and symmetric resp. asymmetric transverse expansion by double (VECTOR 720) or triple (VECTOR 730) spindles working independently from each other
- Supplied as a packet of 2

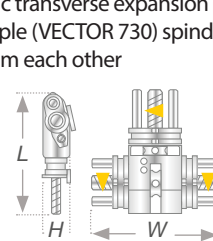
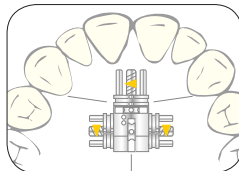

SC2530 Vector 720 expansion screws  
W17 x H3.6 x L15.7 mm  
frontal expansion 5.5mm, transversal expansion 7mm

### VECTOR® 800/VECTOR 820

- This special miniaturised screw has been designed for expansion of upper and lower arches
- It is also suitable for rapid palatal expansion and incorporates 60mm long stable retention arms
- Two integrated polyamid sleeves avoid undesired backing up
- Laser marking on housing
- Includes security expansion screw/key
- Sold individually

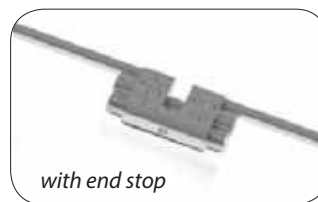

with end stop

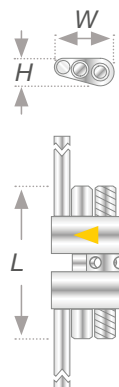

SC2533 Vector 800 expansion screws  
W7 x H3.3 x L16.5 mm, expansion 9mm  
SC2534 Vector 820 expansion screws  
W7 x H3.3 x L18.5 mm, expansion 11mm

### KEY FOR EXPANSION SCREWS

For precision adjustment of VECTOR® expansion screws

- Supplied as a packet of 100

SC2101 Key for expansion screws



# Orthodontic Products

## THERMOFORMING MACHINE

Scheu have a range of thermoforming machines suitable for orthodontics from the top of the line versatile Biostar with 6 bar working pressure, to the Ministar with 4 bar pressure.

Scheu thermoforming machines heat the side of the material placed directly over the model. The surface temperature of this side is much higher which gives a better result.

### MINISTAR® S

*Thermoforming machine for a wide range of applications, ideal for orthodontic practices*

- 4 bars of pressure results in a more accurately fitting appliance
- Even pressure is applied over entire model surface as opposed to vacuum pulling around the model ensuring a consistent thickness of material
- Heated side of foil contacts model which gives an accurate fit and better bonding of laminated appliances
- Scanner means accurate heating time of material which reduces time and waste
- Very quiet
- Easy to use and no guesswork needed

The scanner reads the bar coded material, allowing programming of all important data such as heating time, temperature and cooling time.



SC3500 Ministar S thermoforming machine

*For information on the Biostar machine, refer to page 173*

**Materials for use in a Ministar or Biostar, specifically for orthodontics**

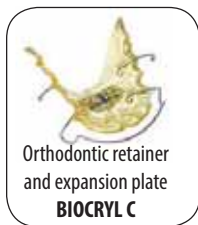

## THERMOFORMING MATERIAL

### BIOCRYL® C

*For denture bases, immediate dentures, orthodontic retainers*

- Break-resistant acrylic blanks made of pure PMMA material, monomer-free, without allergic reaction
- Bonds to acrylic
- Supplied as a packet of 10



- SC3145 Biocryl C - transparent 1.5mm
- SC3147 Biocryl C - transparent 2mm
- SC3149 Biocryl C - red 2mm
- SC3150 Biocryl C - blue 2mm
- SC3151 Biocryl C - yellow 2mm
- SC3152 Biocryl C - rosa transparent 2mm
- SC3153 Biocryl C - transparent 3mm



### BIOCRYL® M

*For orthodontic plates and retainers*

- Hard-elastic, monomer-free material, without allergenic irritants
- Bonds to acrylic
- Supplied as a packet of 10



- SC3228 Biocryl M - multi colour set 2mm
- SC3230 Biocryl M - zebra 2mm
- SC3231 Biocryl M - rainbow 2mm
- SC3232 Biocryl M - tiger 2mm
- SC3233 Biocryl M - camouflage 2mm
- SC3229 Biocryl M - polka dots 2mm



### DURAN®

*Miniplast splints, occlusal splints, interim splints, fluoride splints, drilling/xray templates, anti-snoring appliances, invisible retainers, temporary crowns and bridges*

- Hard-elastic transparent material, bonds to DURASPLINT® and DURASPLINT® LC acrylics
- Apply LC-Primer prior to using DURASPLINT® LC
- No pre-drying



- SC3411 Duran 0.5mm - packet of 10
- SC3409 Duran 0.625mm - packet of 10
- SC3413 Duran 0.75mm - packet of 10
- SC34132 Duran 0.75mm - packet of 100
- SC3415 Duran 1mm - packet of 10
- SC34152 Duran 1mm - packet of 100
- SC3417 Duran 1.5mm - packet of 10
- SC34172 Duran 1.5mm - packet of 100
- SC3419 Duran 2mm - packet of 10
- SC3421 Duran 3mm - packet of 10



For more information on thermoforming machines and materials, please refer to THERMOFORMING PRODUCTS, page 173

# Orthodontic Products

## DURAN® + A2

*Tooth-coloured temporaries, splints for planning and demonstration for aligner treatments*

- With integrated insulation foil
- Pre-dried and individually vacuum packed for instant use
- Supplied as a packet of 10

SC3422 Duran + A2 - 0.5mm  
SC3423 Duran + A2 - 0.75mm



## IMPRELON® S

*OSAMU-Retainer, miniplast splints, occlusal and retention splints*

- Extremely break- and abrasion resistant material
- Pre-dried and individually vacuum packed for instant use

Supplied as a packet of 10

SC3322 Imprelon S - 0.75mm  
SC3322 Imprelon S - 1mm  
SC3322 Imprelon S - 2mm



## THERMOFORMING ACCESSORIES

### BIOPLAST SEPARATOR

*Insulating agent for plaster models when working with BIOPLAST pressure moulding foils, especially when fabricating positioners and mouthguards*

- Provides absolute transparency and smooth inner surfaces
- Supplied as 1 x 500ml bottle

SC3189 Bioplast separator



### STAINLESS STEEL PELLETS

*For embedding models in pressure moulding machine*

- Highly polished stainless steel pellets
- Models are securely positioned and cannot be pressed into the pellets
- Supplied as 1kg pot

SC3222 Stainless steel pellets



### FOIL CUTTING SCISSORS A

*Small trimming scissors*

- Specially designed for cutting foils and splints with ease
- Ideal for trimming mouthguards and bleaching materials
- Made from German Wironit steel
- Curved blade

HMHSB63010 Foil cutting scissors A

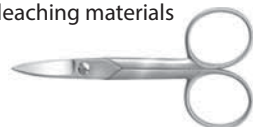

### FOIL CUTTING SCISSORS B

*Large, robust trimming scissors*

- Durable scissors for cutting splints or inserting cuts into splints after pressure moulding

SC3461 Foil cutting scissors B



## FINISHING SET

*For finishing of all pressure moulding materials*

- Finishing set includes 4 burs, 3 initial polishers and 1 final polisher

SC3378 Finishing set



*All components of the finishing set are also available separately - please also refer to page 93 for more details*

## GEORGE GAUGE BITE REGISTRATION KIT

*For simple and precise registration of occlusion in snoring therapy and orthodontics*

*Kit includes 3 bite forks (1 fork for each size)*

SC5471 George Gauge bite registration kit



*Bite forks also sold separately - see page 179 for more details*

## RESIN

### STEADY-RESIN S

*Cold cure resin for the "salt and pepper" technique*

This polymer meets all requirements for "salt and pepper" technique, such as high stability and wettability.

- Supplied as 1kg powder

SC8134 Steady-Resin S powder



### STEADY-RESIN S+M

This monomer is an all-purpose monomer and can be used with all Steady-Resin polymer versions. The clear monomer can be mixed with Steady-Resin coloured monomers.

- Supplied as a 500ml bottle

SC8136 Steady-Resin S+M liquid - clear  
SC8137 Steady-Resin S+M liquid - rose



### STEADY RESIN NEON POWDER

*Pre-mixed polymer in attractive neon colours*

Special colour pigments lead to uniform dispersion and streak-free, translucent material.

- Supplied as a 200g bottle

SC8125 Steady Resin Neon - yellow  
SC8126 Steady Resin Neon - purple  
SC8127 Steady Resin Neon - red  
SC8128 Steady Resin Neon - blue  
SC8129 Steady Resin Neon - green



### MICA GLITTER POWDER

*For individual mixing with STEADY-RESIN polymer*

The blends rainbow, rainbow green and rainbow violet are completely metal-free, creating iridescent gleam in pastel colours.

- Supplied as a 50g bottle

SC8150 Mica - rainbow  
SC8151 Mica - rainbow green  
SC8152 Mica - rainbow violet





# Orthodontic Products

## ORTHODONTIC INSTRUMENTS



HMHSL37116 Orthodontic Kalthoff pliers, 160mm



HMHSL37213 Young loop bending pliers, 135mm  
For hard wire up to  $\varnothing 0.7\text{mm}$  (.028")



HMSHL39713 Sling clasp wire bending pliers, 130mm



HMHSL40113 Pliers bird beak - Angel, no 139, 130mm  
For hard wire up to  $\varnothing 0.7\text{mm}$  (.028")



HMHSL22212 Bracket removing pliers, 130mm



HMHSL272413 Weingart wire seizing pliers, 135mm



HMHSL331111 Distal end cutting pliers for small wire



HMHSL22614 Band pinching and ligature locking pliers, 140mm



SC2044 Carat Aderer pliers  
Aderer wire bending pliers, three prong with reinforced plier tip - suitable for wires up to  $\varnothing 0.9\text{mm}$



LM2526\_ Orthodontic mirror handle with ruler  
For measuring the sagittal overjet & vertical overbite - millimetre scale, total length 25mm



HH474 Metal mirror handle with ruler



LM416417\_ Ligature applicator  
The flattened ball ends have 1mm hooks to place the orthodontic wire to facilitate placing and bending



LM41417CL\_ Ligature on-off SL



LM414415\_ Ligature tucker



LM414150\_ Ligature tucker - scaler U15



HMHSL80400 Ligature instrument

## SPECIALIST INSTRUMENTS

### ORTHO STRIP PST TOOL SET with distance gauge

Set according to Dr. Pablo Echarri for use in the progressive stripping therapy (PST) containing CA® stripping tools with double-sided diamond coating in five diamond particle sizes.

- Ensures a very smooth enamel finish using an EVA handle
- Autoclavable

Aluminium case containing  
1 x CA® stripping tool in 90  $\mu\text{m}$ \* (green), 60  $\mu\text{m}$  (grey), 40  $\mu\text{m}$  (red), 25  $\mu\text{m}$  (white) and 15  $\mu\text{m}$  (yellow), double-sided diamond coating and CA® gauge

SC5341 Ortho-Strip PST tool set with distance gauge



\* not to be used for enamel removal, only for reduction of fillings and crowns

# Orthodontic Products

## APPROXOPENERS

Manual and serrated diamond coated metal strip for opening of tight contact points in orthodontics



For use when orthodontic treatment requires the reduction of tooth mesial/distal dimensions (called "stripping") when the contact points in crooked tooth position are extremely tight.

### Description

- Diamond coated manual metal strip clamped into a small metal bow
- Two versions:
  - Serrated and one-sided diamond coating (8µm), thickness approx. 0.09mm
  - Serrated and double-sided diamond coating (8µm), thickness approx. 0.10mm
- Height of strip: 4mm
- Length of strip: 20mm
- Total height of the instrument: 18mm
- Total length of the instrument: 27.5mm
- Stainless steel
- Sterilisable, reusable



Each supplied as a packet of 3 (of one version)

ITAO2018	ApproxOpener - uncoated
ITAO2018OS	ApproxOpener - one sided
ITAO2018DS	ApproxOpener - two sided



## INTENSIV IPR-DISTANCE CONTROL

Manual stainless steel instrument for the measurement and control of tooth distances created during IPR protocols

With the stripping method, measurable and calibrated spaces are created through the removal of dental tissue in order to obtain exactly the space necessary for the movement of teeth into a harmonious and correct position.

- Intensiv IPR (InterProximalReduction)-Distance Control is a manual measuring instrument made of stainless steel
- It consists of an eight-part instrument set made of stainless steel with handle (finger grip)
- Thicknesses: 0.10mm, 0.15mm, 0.20mm, 0.25mm, 0.30mm, 0.40mm, 0.50mm, 1.0mm
- The thickness indication is marked on each instrument
- Height of measuring section: 4mm
- Length of measuring section: 40mm
- Total length of the instrument: 50mm
- Removable plastic rivet to secure the 8 instruments
- Sterilisable, reusable
- Durable stainless steel
- Secure application due to the handle
- Precise measurement of distances thanks to the calibrated millimetre scale
- Easy reading of the gauge dimension



ITIPRDCSET Intensiv IPR-distance control set contains one of each of the 8 thicknesses + 5 clips

## INTENSIV SWINGLE

The dual contra-angle Intensiv Swingle for application with oscillating Intensiv Ortho-Strips



The contra-angle Intensiv Swingle combines both functions:

- Free axial rotating of the strip, being applied with finishing and polishing of prepared surfaces
- Fixed axial position (12 positions at each 30° within 360°) for exact positioning of the strip, being applied in the resolution of the contact point and for enamel reduction

The small sized contra-angle head allows a significantly improved view of the operating/surgical field.

### Product description

- Contra-angle with integrated water spray and optional light
- Stroke 0.9mm
- 20,000 oscillating movements with 40,000 rpm



### Indications

- Interproximal space creation by stripping according to the protocol IPR (InterProximalReduction) in orthodontic treatments
- Finishing and final polishing of the treated dental surfaces

### Benefits

- Safe, efficient and precise interproximal enamel reduction as part of orthodontic treatment
- Easy, controlled opening of the contact points
- Homogeneous and smooth surfaces of the treated teeth
- Two-year warranty
- Sterilisable



ITWG69LTO Intensiv Swingle starter orthodontic kit

Kit includes contra-angle handpiece with light, ejector, spray canal cleaner needle, 1 x Ortho-strip opener and 1 box each of Ortho-strips extra coarse, coarse, medium, fine and polishing

## INTENSIV ORTHO-STRIPS SYSTEM

Oscillating diamond strips for the reduction of the tooth size used in conjunction with the Intensiv Swingle handpiece



Available in two versions:

(1) **Double-sided Ortho-Strips** - for the bilateral interdental reduction of the tooth size in orthodontics (stripping)

### Indications

- Opening of the interdental contact points
- Widening of the interdental spaces in orthodontics by bilateral tooth size reduction
- Elimination of minor crowding and treatment finishing in orthodontics
- Bilateral proximal enamel polishing

# Orthodontic Products



	08	80	60	40	25	15
494	OS08OP-DS					
524		OS80XC-DS				
514			OS60C-DS			
514				OS40M-DS		
514					OS25F-DS	
504						OS15POL-DS
	Opening	Reduction	Contouring	Contouring	Finishing	Polishing
	Diamond-coated on both sides					

**ITSET060A** Intensiv Ortho-Strips system, double-sided set includes an assortment of 4 oscillating strips (OS60C-DS, OS40M-DS, OS25F-DS and OS15POL-DS)

**ITOS\_** Ortho-Strips double-sided are available separately

(2) **One-sided Ortho-Strips** - for the monolateral interdental reduction of the tooth size and the proximal polishing in orthodontics (stripping)

### Indications

- Opening and enlargement of the interdental spaces in orthodontics without iatrogenic damage to adjacent teeth
- One-sided proximal contouring, finishing, and polishing



	08	80	60
494	OS08OP-R OS08OP-L		
524		OS80XC-R OS80XC-L	
514			OS60C-R OS60C-L
514			
514			
504			
	Opening	Reduction	Contouring
	Diamond-coated on one side. L = Left R = Right		



	40	25	15
494			
524			
514			
514	OS40M-R OS40M-L		
514		OS25F-R OS25F-L	
504			OS15POL-R OS15POL-L
	Contouring	Finishing	Polishing

**ITSET064** Intensiv Ortho-Strips system, one-sided set includes an assortment of 6 oscillating strips (OS40M-L, OS25F-L, OS15POL-L, OS40M-R, OS25F-R and OS15POL-R)

**ITOS\_** Ortho-Strips one-sided are available separately

## ORTHODONTIC ACCESSORIES

### CETRON CLEANING POWDER

For the hygienic and lasting care of orthodontic retainers



- Available as a set or in powder sachets

**SC3235** Cetron cleaning care set (includes cleansing box, brush and 5 bags of 15g Cetron cleansing powder)

**SC32391** Cetron cleaning powder - 5 x 15g powder sachets

### PLASTIC BOXES

Ideal for orthodontic models

- 42mm deep
- With ventilation holes and hole for cord (cord not included)
- Supplied in packet of 10 with assorted colours



**LAORTHOB** Ortho mouthguard box G3



### ORTHODONTIC TRAY WAX

For post damming of impression trays

A soft, white plastic wax stick for orthodontic use in the extension of periphery, post-damming and stops for impression trays.

- Supplied as 48 sticks (175g)

**KR9246** Orthodontic tray wax



### HAMMACHER PHOTO MIRRORS

- Rhodium coated mirrors ideal for distortion-free extra-oral images
- Durable and robust
- Autoclavable with removable silicone handle

**HMHSJ15401** Photo mirror - small (40 x 163mm)

**HMHSJ15502** Photo mirror - medium (69 x 163mm)



Small Medium  
Hammacher Instrumente

### SALVIN PHOTO MIRRORS

- Front surface float glass for reflected image with no distortion
- Mirror surface on both sides
- Sterilisation up to 220°C

**SAPHOTOB2** Photo mirror - buccal 2 adult (57mm x 152mm)

**SAPHOTOOA** Photo mirror - occlusal adult (68mm x 100mm)

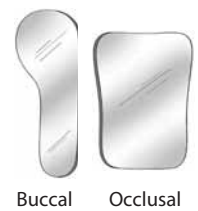

Buccal Occlusal



# Portable Equipment

## PORTABLE DENTAL SYSTEMS

### TRANSPORT III PORTABLE DENTAL SYSTEM

*The Transport III features noise reduction technology, an intuitive user interface and 40k rpm brushless autoclavable micromotor*

It is easy to set up, operate, and pack down. All components fit neatly into the impact resistant carrying case with wheels.

Delivery module and user interface panel mount externally on a secure handle, placing controls and instruments at a comfortable level.

Dual level fluid sensors alert the user when the tank is 75% full for better procedure planning. "Full" level sensor shuts the compressor off. Externally mounted waste containers mean faster and cleaner waste disposal.

- High torque electric motor
- Fibre optic electric handpiece connection
- High volume evacuator
- Saliva ejector
- Quiet, intuitive, powerful
- Built-in maintenance free compressor
- Water port for cavitron/scaler
- Dual voltage
- Optional fibre optic scaler
- 25.8 kg (57 lb)
- 45.5 x 26.4 x 56.1 cm (17.9" x 10.4" x 22.1")



AEU525S Transport III with scaler  
AEU525 Transport III without scaler

**Aseptico**  
Made in the USA

### EXPRESS PORTABLE DENTAL SYSTEM

*The Express is a fully self-contained, lightweight, air-driven portable dental system*

This powerful unit features up to two handpiece connections, high volume and saliva ejector suction, internal water reservoir, three-way syringe and integrated air compressor.

Foot control options include on/off electric or variable rheostat. The Express is transported using a pullout handle and built-in wheel assembly. Its compact size allows for convenient storage, while the impact-resistant case makes the Express ideal for any field environment. Designed for global use, the Express is compatible with 110V or 220V power sources.

- Available with one or two air handpiece connections
- High volume evacuator
- Saliva ejector
- Built-in maintenance free compressor
- Water port for cavitron/scaler
- 1 gallon waste container
- 110V or 220V switchable voltage
- 19.7kg (43.5lb)
- 27 x 36 x 61 cm (10.5" x 14.5" x 24")



ADU17A2/17X2 Express with two handpiece connections  
ADU17A/17X Express with one handpiece connection

**Aseptico**

## PORTABLE CHAIR & STOOL

### ASEPTICHAIR

- Sturdy, high-strength steel construction
- Lightweight, only 13.5kg (30lb)
- 300lb weight capacity
- Back rest adjusts from fully upright to supine
- Includes padded case, arm slings and headrest cushion
- Adjustable seat height: 11 x 55.9 cm (11" x 22")
- Padded carrying case: 58 x 86 x 20.3 cm (23" x 34" x 8")

**Aseptico**



AEADC01 AseptiChair

### ASEPTISTOOL

- Easy set up and storage
- Includes padded case
- Adjustable seat height: 48.3 x 55.9 cm (19" -22")
- Weighs: 6.75kg (15lb)
- Padded carrying case: 48 x 53 x 23 cm (18" x 22" x 8")



ADC08 AseptiStool

## PORTABLE OVERHEAD LIGHT

### PORTABLE LED LIGHT

- Adjustable LED with seven beam diameters
- Amber filter for working with composites
- Durable construction
- Includes padded carrying case
- 5.4kg (12lb)
- Padded carrying case: 114.5 x 23 x 14 cm (45" x 9" x 5.5")



ALU40LED Portable LED light

## PORTABLE AIR COMPRESSOR

### AIRPAC III PORTABLE TWO-UNIT AIR COMPRESSOR

- Designed for mobility and ease of use
- Compressed air for two portable dental systems
- 1 x HP oilless motor
- Built-in wheels and pull handle
- 45.7 x 55.9 x 26.7 cm (closed) (18" x 22" x 10.5")
- 20.9kg (46 lbs)



AA100 AirPac III portable two-unit air compressor

## PORTABLE AIR COMPRESSOR

### PORTABLE SALIVA EJECTOR

- Great for mobile dentistry or as a backup for sedation dentistry
- Powered by rechargeable battery pack, wall outlet or 12VDC vehicle source
- Battery operating time: Up to 60 minutes on a single charge
- 800cc waste canister
- 2.9kg (6.3lb)
- 22.8 x 17.8 x 20 cm (9" x 7" x 8")



AA20  
Portable saliva ejector

# Restorative Products

## BONDS

### OPTIBOND SOLO PLUS

*Total etch, single component dental adhesive*

- Ethanol based
- Filled technology - 15% filled with a 0.4 micron filler
- Versatile - use in moist or dry environment
- Proven long term performance

Available as a 5ml bottle or as a unidose refill

- KR31513 OptiBond Solo Plus - 5ml bottle  
 KR29669 OptiBond Solo Plus - unidose refill\*  
 \*100 adhesive packets (10ml total)



### OPTIBOND XTR

*Self etch, light cure universal adhesive*

The unique chemistry of an enhanced self etch primer and optimised adhesive gives outstanding bond strengths to enamel and dentine. Compatible with all resin cements, core build up materials and dental materials.

- KR35106 OptiBond XTR intro kit

*Kit contains  
 1 bottle self-etching primer (5ml),  
 1 bottle universal adhesive (5ml),  
 100 applicators and 25 four-cavity  
 mixing wells, directions for use  
 + technique guide*



- KR35108 OptiBond XTR adhesive - 5ml  
 KR35107 OptiBond XTR primer - 5ml

### OPTIBOND FL

*Filled, light-cure total-etch dental adhesive*

- Two-bottle or unidose delivery with only one step
- Two-bottle primer/adhesive for all direct restorations and for indirect core build-up
- Reliable, with a one-coat primer and a one-coat adhesive that can be applied on wet or dry surfaces

#### Features

- Unique structural bond with 48% filler load
- Efficient application flow - one coat primer - one coat adhesive - one light curing - wet or dry preparations
- Highly radiopaque
- Proven long-term performance

- KR26684 OptiBond FL bottle kit

*Kit contains  
 1 x 8ml OptiBond FL prime  
 bottle, 1 x 8ml OptiBond FL  
 adhesive bottle, 1 x 3g syringe  
 gel etchant, 10 x disposable  
 gel etchant syringe tips,  
 25 x 4-cavity disposable  
 mixing wells, 50 x disposable  
 applicator tips and  
 technique card*



- KR35266 OptiBond FL adhesive - 8ml  
 KR35265 OptiBond FL primer - 8ml

### FUTURABOND® U

*Dual-curing universal adhesive*

#### Indications

- Direct and indirect restorations using any light-curing, self-curing or dual-curing methacrylate-based restorative, core build-up or luting composite
- Intraoral repair of fillings, ceramic veneers and all-ceramic restorations without additional primer
- Treatment of hypersensitive tooth necks
- Protective varnish for glass ionomer cement restorations
- Sealing of cavities prior to amalgam restorations or prior to temporary luting
- Luting of root posts with dual-curing or self-curing luting composites

#### Advantages

- One bond for all situations
- Self-etch, selective-etch or total-etch
- Applied in one layer – only 35 seconds total working time
- Outstanding adhesion
- Moisture tolerant
- Refrigeration not necessary

Supplied in practical, hygienic single dose sachets

- VO1571 Futurabond® U SingleDose - packet of 50  
 VO1572 Futurabond® U SingleDose - packet of 200

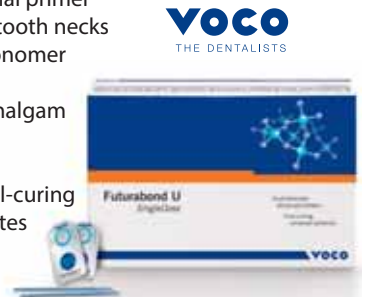

### FUTURABOND® DC

*Dual-curing self-etch bond reinforced with nano-fillers*

#### Indications

- Direct self- or dual-curing composite restorations and core build-ups
- Direct light-curing restoration with composite-, compomer- and ORMOCER®-based restoratives
- Adhesive luting of root pins/posts with dual or self-curing composite cements
- Indirect restoration when using dual- and self-curing resin cements for luting of inlays, onlays, crowns and bridges

#### Advantages

- Chemical-curing in areas inaccessible with a curing light
- Futurabond DC achieves the same adhesive properties as total-etch preparations without separate etching of the tooth substance
- Durable marginal integrity
- Easy and fast application - one-coat, one-cure technique
- Contains fluorides
- Moisture-tolerant
- Refrigeration not necessary



Supplied in practical, hygienic single dose sachets

- VO1163 Futurabond® DC bottle 2 x 4ml  
 VO1164 Futurabond® U SingleDose - packet of 50  
 VO1165 Futurabond® U SingleDose - packet of 200

# Restorative Products

## ADMIRA® BOND

*One-component dentine and enamel bond Ormocer® based*

### Indications

- Direct restoration with all types of light-curing restoratives (Ormocer®s, composites, compomers)

### Advantages

- Ormocer® based
- High adhesion and long-lasting marginal tightness
- One component – one layer
- Universal for all light-curing restoratives

VO2432 Admira® Bond - 2 x 4ml bottle

VO2479 Admira® Bond - 1 x 4ml bottle



## SIGNUM METAL BOND

*Signum Metal Bond bonds acrylic and composite to any type of metal structure including gold, titanium, non-precious and CoCr very quickly and easily*

### Surgery Applications

- Addition of composite to chipped crowns and bridges with exposed metal
- Bonding of composite to implants for long term temporaries
- Maryland bridges
- Bonding to metal posts

### Laboratory Applications

- Masking of clasps on chrome frames
- Bonding of acrylic and composite to implants
- Bonding of acrylic or composite to abutments

KL66033913 Signum Metal Bond kit

*Set includes 1 x 4ml bottle each of Bond I and Bond II*

KL66033915 Signum Metal Bond I refill - 4ml

KL66033916 Signum Metal Bond II refill - 4ml



## GEL ETCHANT

*37.5% phosphoric acid gel*

Kerr's distinctive purple-coloured 37.5% phosphoric acid gel is designed for maximum etching efficiency.

- Perfect viscosity - stays where you place it
- No separation - delivery is always clean and easy
- Vibrant purple colour - highly visible
- Rinses clean with minimum effort, easy to use

Supplied as 3 x 3g syringes

+ 30 dispensing tips (disposable)

KR31297 Gel Etchant 3-Pack



## LINERS

### LIFE

*Calcium hydroxide cavity liner*

Life is a hard-set calcium-hydroxide base indicated for use as a direct and indirect pulp-capping material and as a cement base for all restorative filling materials.

- Regular set
- Set contains 12g base, 12g catalyst and 1 mixing pad

KR29674 Life



### CAV-HYCAL™

*Light-curing calcium hydroxide cavity liner*

- Radiopaque
- Setting time (under halogen lamp): < 55s
- Depth of polymerisation (EN 24 049): 4-6mm
- Resistance to compression: 111-135MPa
- Insoluble after polymerisation
- No resorption after polymerisation

*Kit contains 2 x 4g syringes + 20 disposable tips*

AC213866 Cav-Hycal



## ETCH

### VOCOCID®

*Etchant for acid-etch-technique*

### Indications

- Etching liquid / gel for use in the enamel etching or in the total-etch technique

### Advantages

- Available as fluid (36.1 % phosphoric acid) or gel (35 % phosphoric acid)
- Blue colouring for visual monitoring during application
- Stable, non-dripping gel



VO1063 Vococid® etch gel blue - 1 x 5ml syringes

VO1066 Vococid® etch gel blue - 2 x 3ml bottles

VO1224 Vococid® etch gel blue - 5 x 2ml syringes



### CALCIMOL

*Self-curing radiopaque calcium hydroxide paste*

### Indications

- Indirect pulp capping
- Lining under all filling materials

### Advantages

- Effective protection of the pulp
- Easy application
- Suitable working time
- Short setting time
- Contains 26 % calcium hydroxide
- Radiopaque
- Supports the formation of tertiary dentine

Supplied as 1 x base (13g) and 1 x catalyst (11g)

VO1097 Calcimol - base and catalyst



# Restorative Products

## IONOSEAL

*Light-curing glass ionomer composite liner*

### Indications

- Lining under all types of filling material
- Extended fissure sealing
- Restoration of smaller lesions



VO1326

### Advantages

- Ready-to-use one-component material
- Time-saving: light-curing in seconds
- Quick and hygienic application
- High compressive strength (226 MPa)
- Fluoride release against secondary caries
- High biocompatibility
- Radiopaque

**VOCO**  
THE DENTALISTS



VO1126

VO1126 Ionoseal 2 x 4g tubes

VO1326 Ionoseal 3 x 2.5g syringe + accessories

## TEMPORARY CEMENTS

### BIFIX® TEMP

*Dual-curing, composite-based temporary luting material*

### Indications

- Temporary luting of provisional restorations



### Advantages

- Film thicknesses of less than 5µm - the accuracy of fit is not affected
- Dual-curing - flexible setting times by use of a polymerisation light
- Simple removal of excess material - can be removed in one piece following brief light-curing

**VOCO**  
THE DENTALISTS

VO1055 Bifix® Temp QuickMix syringe 5ml, universal + accessories

### PROVICOL® QM

*Eugenol-free temporary luting cement with calcium hydroxide*

### Indications

- Temporary luting of inlays, onlays, crowns, partial crowns, bridges, attachments and posts
- Temporary filling of small one-surface cavities

**VOCO**  
THE DENTALISTS

### Advantages

- Fast application without mixing
- Bubble-free perfect mixing
- Direct application



VO1074 Provicol® QM syringe 5ml + accessories

### CAVEX TEMPORARY CEMENT

*For the cementation of temporary crowns and bridges*

- Easy and convenient
- Easy to mix catalyst and base pastes
- Eugenol free
- 4 - 5 minutes 'in the mouth' set time
- Yellowish colour for easy detection
- Less than 10µm film thickness



**CAVEX**

Supplied as 1 x base (35g) and 1 x catalyst (15g)

CATEMPCEM Cavex Temporary Cement

## TEMP-BOND CEMENT

*Temporary cement for trial cementing restorations or cementing temporary crowns and bridges*

- Flows and mixes easily
- High bond strength
- Easy to remove



### Temp-Bond Original

KR29675 Temp-Bond original tubes

*contains 1 x 50g base + 15g accelerator + 1 x mixing pad*

KR31377 Temp-Bond original unidose

*contains 50 unidose packets (2.4g each packet /120g total) + 1 mixing pad*

### Temp-Bond NE (non-eugenol)

KR29676 Temp-Bond NE tubes

*contains 1 x 50g base + 15g accelerator + 1 x mixing pad*

KR31973 Temp-Bond NE unidose (50 x unidose)

*contains 50 unidose packets (2.4g each packet /120g total) + 1 mixing pad*

KR33217 Temp-Bond NE automix syringe

*contains 2 syringes (11.8g each), 20 mixing tips*

### Temp-Bond Clear with Triclosan

KR33351 Temp-Bond clear automix

*contains 1 x 6g syringe, 10 mixing tips*

**Kerr**

## ZINC OXIDE EUGENOL CEMENTS

### ALGANOL

*Alganol is a modified zinc oxide eugenol cement*

The material has a pH value 7-8 and combines low solubility and high compressive strength to produce an exceptionally durable material in the mouth.



### Indications

- Routine cavity linings under amalgam and silicate restorations
- Temporary filling which can be left for several weeks
- Pulp capping to protect pulp from thermal change and acid irritation of cements
- Temporary seal for medicament dressing

ASALGANPD Alganol powder 90g

ASALGANLQ Alganol liquid 30ml

**kemdent**  
Quality and Reliability

### ZONALIN

*Zonalin is a modified accelerated setting zinc oxide eugenol cement*

Used for cavity linings under amalgam and silicate restorations, for pulp capping (to protect the pulp from thermal change and acid irritation of cements) and as a temporary seal for medicament dressings.



*Do not use as a base for composite restorations.*

ASZONALINF Zonalin fast set powder 28g

ASZONALINL Zonalin liquid 10ml

**kemdent**  
Quality and Reliability

# Restorative Products

## PERMANENT CEMENTS

### NX3

#### Permanent resin cement

- Ideal for all indirect applications
- Dual cure material in an automix syringe which can be used for all indirect applications
- Automix syringe is easy to use and eliminates hand mixing
- Excellent adhesion to dentine, enamel, CAD/CAM blocks, ceramics, porcelain, resin and metal
- Can be used with both self etch and total etch bonding materials
- Superior colour stability ensures long term aesthetics
- Gel consistency provides excellent handling and easy cleanup

Supplied as a 5g syringe

KR33643 NX3 clear  
KR33645 NX3 yellow  
KR33644 NX3 white



**Kerr**

### OPTIBOND XTR/NX3, combination pack

#### NX3 Nexus™ Third Generation & OptiBond™ XTR

NX3 XTR cementation system blends the versatility of NX3 Nexus™ third generation universal dental cement with the adhesion superiority of OptiBond™ XTR self-etch, universal dental bonding agent for a new standard of permanent cementation for all esthetic materials.

- Effortless removal
- Superior colour stability
- High adhesion
- Minimal post-op sensitivity

**Kerr**



The combination of NX3 dental cement and the OptiBond® XTR bonding agent provides dental professionals with the features of two of Kerr's most advanced solutions. The resulting benefits make this combination the optimum solution for cementing virtually any type of CAD/CAM dental restoration.

KR35617 OptiBond XTR/NX3 combination pack contains 1 x NX3 dual-cure syringe (clear) (5ml), 1 x OptiBond XTR primer bottle (5ml) and 1 x OptiBond XTR adhesive bottle (5ml)

### MAXCEM ELITE CHROMA

Self-etch, self-adhesive resin dental cement with colour cleanup indicator, dispensing pink before fading at the gel state, telling you the optimal time to cleanup excess cement

#### Features

- Enhanced bond strength
- One-peel™ cleanup
- Dual-cure
- Radiopaque
- Dual-barrel automix delivery system
- Compatibility – all indirect restorations, including ceramics, PFMs, zirconia and metal restorations and cad/cam materials
- Easy storage without refrigeration

Available in shades clear, white and yellow

Supplied as 2 x 5g syringes

KR363\_ Maxcem Elite Chroma refill - specify shade



**Kerr**

### BIFIX® QM

Dual-curing universal composite-based luting system

#### Indications

- Adhesive luting of inlays, onlays, veneers, crowns, partial crowns, pins, posts, bridges and adhesive bridges (Maryland bridges)

#### Advantages

- For all materials (metal, composite inlays and ceramic, also zirconium dioxide)
- Bubble-free perfect mixing
- Direct application
- Excellent adhesion to dentine, enamel and to metals
- Special one-step Ceramic Bond for optimal adhesion to porcelain
- Radiopaque

Available in three shades - universal, transparent and white-opaque  
Supplied as 1 x 10g syringe

VO121\_ Bifix QuickMix syringe - specify shade

**VOCO**  
THE DENTALISTS



### MERON PLUS · MERON PLUS AC

Resin reinforced glass ionomer luting cement

#### Indications

- Luting of:
  - porcelain-fused-to-metal crowns, bridges on hard dental tissue and on cores rebuilt with amalgam, composites or glass ionomer materials
  - metal inlays, onlays, crowns and bridges
  - root posts
  - all-ceramic crowns manufactured from silicate ceramic, zirconium dioxide-only or alumina-only ceramic cores
  - orthodontic appliances

#### Advantages

- Excellent adhesion to the dental structure
- Precise marginal fit
- Moisture and acid resistant
- Long elastic phase for efficient excess removal
- Self-adhesive: secure and quick bonding without primer or conditioner
- Thixotropic: no unwanted run-off, no rotating instruments required
- Suited for high-strength zirconium dioxide ceramic pieces

VO1731 Meron Plus powder - 15g  
VO1732 Meron Plus liquid - 10ml

**VOCO**  
THE DENTALISTS



VO1733 Meron Plus AC (application capsules) - 48 pieces



# Restorative Products

## COMPOSITES

### GRANDIO®SO

*Universal nano-hybrid 89% filled restorative*

#### Indications

- Class I to V fillings
- Locking, splinting of loosened teeth
- Repairing veneers
- Restoration of deciduous teeth
- Composite inlays

#### Advantages

- Excellent aesthetics
- Very high-filler content of 89 % w/w
- All-purpose for both the anterior and posterior teeth
- Excellent light resistance
- Optimal coordination of opacity and translucency for results that mirror the natural tooth using only one shade
- Smooth consistency, non-sticky, best sculptability
- Easily polishes to a high gloss – lasting, smooth surface
- Compatible with all conventional bonds

Available in syringes (4g) or capsules (16 x 0.25g)

Available in shades A1, A2, A3, A3.5, A4, B1, B2, B3, C2, D3, Incisal, OA1, OA2, OA3.5, BL, GA3.25, GA5

VO26\_ Grandio®SO syringes and capsules - specify shade

Also available in sets



### GRANDIO®

*Universal nano-hybrid 87% filled restorative*

#### Indications

- Class I to V fillings
- Locking, splinting of loose anteriors
- Repair veneers
- Especially suitable for composite inlays

#### Advantages

- Excellent physical properties for long-lasting restorations
- Significantly lower polymerisation shrinkage than conventional composites
- High filler content of 87% w/w
- High transverse strength
- Smooth consistency for convenient handling
- Excellent aesthetics
- Compatible with all conventional bonds

Available in syringes (4g) or capsules (20 x 0.25g)



Available in shades A1, A2, A3, A3.5, A4, B1, B2, B3, C2, C3, D2, D3, Incisal, OA2, OA3.5, BL

VO18\_ Grandio® syringes and capsules - specify shade

Also available in sets

### AMARIS®

*Highly aesthetic light-curing restorative material*

#### Indications

- Aesthetic restoration of class III, IV and V cavities in anterior teeth
- Aesthetic restoration of class I, II and V cavities in posterior teeth
- Reconstruction of traumatically damaged anterior teeth
- Direct and indirect composite veneers
- Shape and shade correction for improved aesthetics
- Repairing highly aesthetic porcelain, eg., veneers
- Direct and indirect composite inlays
- Splinting of anterior teeth



#### Advantages

- Layering like in nature: shades are created from the inside of the tooth
- Simple and precise but flexible shade system
- Natural shade transitions automatically
- Natural aesthetics can be achieved with 11 shades in a simple layer technique
- Easy to learn
- Intuitive approach, no preconceived shades
- Non-sticky consistency is ideal for modelling and shaping
- Resistant to ambient and chair light
- Optimal polishability
- Natural fluorescence and high colour stability
- Good chameleon effect for invisible restorations



Available in syringes (4g) or capsules (16 x 0.25g)

Available in shades O1, O2, O3, O4, O5, O Bleach, (light) TL, (neutral) TN, (dark) TD and Amaris® Flow special shades (high translucent) HT and (high opaque) HO

VO19\_ Amaris® syringes and capsules - specify shade

Also available in sets

### AMARIS GINGIVA

*Highly aesthetic light-curing restorative material in gingival shades*

#### Indications

- Class V restorations (cervical caries, root erosion, V-shaped defects) especially in cases of retreating gingiva eg., as a result of periodontal disease
- Covering exposed discoloured hypersensitive cervical areas, especially in the visible anterior area
- Highly aesthetic correction of malposition's of teeth, for direct veneers, facings and corrections of the red-white aesthetics



#### Advantages

- One base shade, combined with three mixable opaquers, can reproduce almost all gingival shades
- Aesthetic and functional solution for cavities and V-shaped defects in cervical areas exposed by gingival recession

VO1970 Amaris® Gingiva syringe set

Syringe set includes 4g base shade, syringe 3g x 1.2g opaquers (white, light, dark), shade guide + accessories

VO1971 Amaris® Gingiva syringe 4g - nature

# Restorative Products

## ARABESK

*Light-curing micro hybrid composite restorative material*

### Indications

- Class I to V fillings
- Reconstruction of traumatically affected anteriors
- Shape and shade corrections for improved aesthetic appearance
- Locking and splinting of loose anteriors
- Extended fissure sealing for molars and premolars
- Veneer repairs
- Core build-up under crowns

### Advantages

- High abrasion resistance and stability
- Good packability and shaping
- Good aesthetics and shade adaptation to the tooth
- Excellent polishability
- Universal for all cavity classes



Available in shades A1, A2, A3, A3.5, B2, B3, Incisal

VO13\_ Arabesk syringes (4g) - specify shade

## QUADRANT UNIVERSAL LIVING COLOUR (LC)

*Universal hybrid composite enriched with nanoparticles*

This unique and well-balanced composition makes it easy to handle with perfect wall adaption and beautiful high gloss polishability.

### Indications

- Class I, II, III, IV and V restorations

### Features

- Strong chameleon effect
- Natural fluorescence
- Enriched with nanoparticles
- Optimal consistency
- Does not stick to instruments
- Radiopaque
- Colour stable
- Durable and wear resistant
- Perfect aesthetics

CAVEX



Available in shades A1, A2, A3, A3.5, A4, B2, B3, C2, C3, OA2 and Incisal

CAFU\_ Quadrant universal LC syringes (4g) - specify shade

## HARMONIZE™

*Universal composite with adaptive response technology*

Infused with Adaptive Response Technology, Harmonize helps you achieve lifelike restorations with more ease and simplicity than ever before.

Additionally, the nanoparticle filler network provides better blending capabilities and enhanced structural integrity to ensure your restorations have exceptional strength and unmatched esthetics without compromise.

### Features

- Superior blending and chameleon effect due to the unique filler particles which refract and diffuse light, similar to enamel
- Unmatched gloss retention
- Exceptional handling makes the composite soft and highly moldable without stickiness
- Easier sculpting and holding power reduces the time needed for trimming and finishing
- Better polymerisation, more integration with the resin, strength, and durability

Kerr



Available in enamel or dentine

Available in various shades

KR364\_ Harmonize syringe (4g) - specify shade

KR364\_ Harmonize unidose (20 x 0.25g) - specify shade

## HERCULITE XRV ULTRA

*Herculite® XRV Ultra™ is based on nanofiller technology*

In addition to offering improved handling, polishability and wear resistance, Herculite XRV Ultra delivers a lifelike appearance to final restorations by replicating the opalescence and fluorescence of the natural tooth.

- Supplied as syringe (1 x 4g) or unidose tips (20 x 0.2g)
- Available in enamel or dentine
- Available in various shades

Kerr



KR3400\_ Herculite XRV Ultra - syringe or unidose - specify shade

## Six good reasons to choose Oraltec as your preferred supplier

- *New Zealand owned*
- *High quality, trusted product range*
- *Innovative, up to date products*
- *Excellent customer service with fast delivery*
- *Superior product knowledge with clinical and technical support*
- *Friendly staff able to offer personal attention*

*Visit our website or speak to one of our team.  
We will take care of you.*

**Oraltec.** Your Premium Dental Partner.

ORALTEC



Proud to be New Zealand  
owned and operated



ESTHETICS

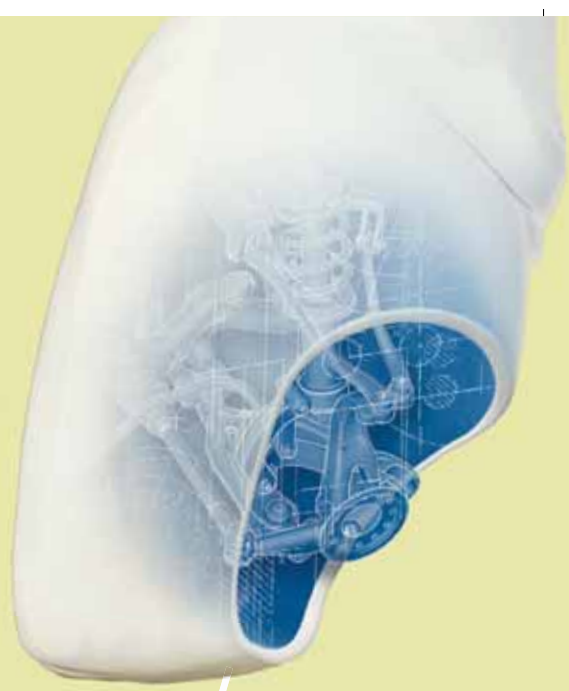

ENGINEERING

You know what it takes to make your restoration undetectable.

STRENGTH

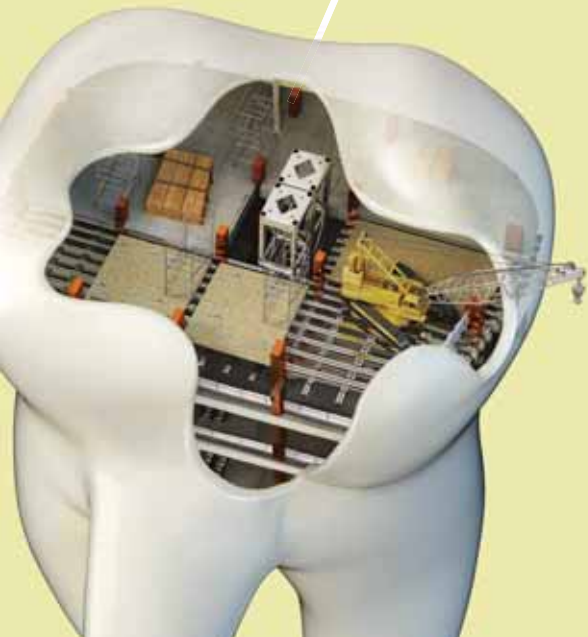

Introducing Harmonize™—the next generation composite infused with Adaptive Response Technology.

Harmonize™  
Nanohybrid Universal Composite



**Kerr**  
RESTORATIVES



Together, we're more.™

# Restorative Products

## ORMOCER MATERIALS

### ADMIRA® FUSION

*Universal nanohybrid ORMOCER® restorative material*

#### Indications

- Class I to V restorations
- Base in class I and II cavities
- Reconstruction of traumatically damaged anteriors
- Correction of shape and shade for improved aesthetic appearance
- Locking, splinting of loose anteriors
- Repairing veneers, small enamel defects
- Extended fissure sealing
- Restoration of deciduous teeth
- Core build-up
- Composite inlays

#### Advantages

- The first purely ceramic-based restorative material
- Lowest polymerisation shrinkage (1.25% by volume) and particularly low level of shrinkage stress in comparison to all conventional restorative composites
- Inert, highly biocompatible and very resistant to discolouration
- Excellent handling
- High surface hardness guarantee long-term results
- Compatible with all conventional bonding agents

Available in syringes (3g) or capsules (packet of 15 x 0.2g)



Available in shades A1, A2, A3, A3.5, A4, B1, B2, B3, C2, D3, OA1, OA2, OA3, OA3.5, BL, Incisal, GA3.25 and GA5

VO27\_ Admira® Fusion capsules or syringes - specify shade

Also available in sets

### ADMIRA® BOND

*One-component dentine and enamel bond Ormocer® based*

#### Indications

- Direct restoration with all types of light-curing restoratives (Ormocer®s, composites, compomers)

#### Advantages

- Ormocer® based
- High adhesion and long-lasting marginal tightness
- One component – one layer
- Universal for all light-curing restoratives

VO2432 Admira® Bond - 2 x 4ml bottle

VO2479 Admira® Bond - 1 x 4ml bottle



### ADMIRA® FUSION FLOW

*Flowable light-curing nanohybrid Ormocer® restorative material*

#### Indications

- Filling of small cavities and extended fissure sealing
- Blocking out undercuts
- Lining or coating cavities
- Fillings of class III - V cavities
- Locking, splinting of loose teeth

#### Advantages

- The first purely ceramic-based flowable restorative material
- Pure Silicate Technology with matrix based on silicon oxide
- Contains no classic monomers
- Extremely low polymerisation shrinkage (2.75% by volume) and particularly low level of shrinkage stress in comparison to conventional flowable restorative composites
- Inert and biocompatible
- Extremely resistant to discolouration
- "Flow on demand" – the material becomes flowable only when under pressure or in motion
- Excellent handling
- High surface hardness guarantee long-term results
- Compatible with all conventional bonding agents



Available in shades A1, A2, A3, A3.5, A4, B1, B2, C2, Incisal, OA2, BL and WO

VO28\_ Admira® Fusion Flow (2 x 2g) syringe - specify shade

### ADMIRA® FUSION X-TRA

*Nanohybrid ORMOCER® bulk fill restorative material, 4 mm*

- Purely ceramic-based, bulk fill restorative material
- Fast and high-quality – reliable curing of 4mm layers
- Extremely low polymerisation shrinkage (1.25% per volume) and particularly low level of shrinkage stress
- Universal shade with chameleon effect

#### Indications

- Class I and II posterior restorations
- Base in class I and II cavities
- Class V restorations
- Locking, splinting of loose anteriors
- Repairing veneers, small enamel defects and temporary crown and bridge materials
- Extended fissure sealing
- Restoration of deciduous teeth
- Core build-up



VO2810 Admira® Fusion x-tra - 3g syringe universal

VO2811 Admira® Fusion x-tra - 15 x 0.2g capsules universal

# One step ahead.

## Admira Fusion

Nano-hybrid ORMOCER®

2003 Nano-hybrid

1999 ORMOCER®

1993 Compomer

Micro-hybrid



### THE FIRST CERAMIC FOR DIRECT FILLINGS

- Pure Silicate Technology: fillers and resin matrix based purely on silicon oxide
- Lowest polymerisation shrinkage (1.25 % by volume) and particularly low level of shrinkage stress\*
- Inert, so highly biocompatible and extremely resistant to discolouration
- Excellent handling, simple high-lustre polishing procedure coupled with high surface hardness guarantee first-class long-term results
- Compatible with all conventional bonding agents
- Also as a flow and bulk fill

\*in comparison to all conventional restorative composites

## Admira Fusion



# Restorative Products

## BULK FILL COMPOSITES

### SONICFILL 2

The SonicFill™ 2 system enables clinicians to perform posterior restorations with an easy-to-use, one-step procedure that provides everything needed for reliable bulk filling: the adaptation of a flowable during placement, a high depth-of-cure, low polymerization shrinkage stress and high strength and good aesthetics.

SonicFill™ 2's composite incorporates a highly-filled proprietary resin with special modifiers that react to sonic energy. As sonic energy is applied through the handpiece, the modifier causes the viscosity to drop (up to 84%), increasing the flowability of the composite, enabling quick placement and precise adaptation to the cavity walls. When the sonic energy is stopped, the composite returns to a more viscous, non-slumping state that is perfect for carving and contouring.

- No voids, gaps or seams
- Excellent marginal integrity
- Outstanding adaptation to cavity surfaces
- High depth of cure
- Excellent strength, polishability & wear resistance
- Low sensitivity to ambient light



KR36044 SonicFill 2 Intro kit  
Intro kit contains 1 x SonicFill handpiece, 40 x unidose™ tips in A2, 10 x unidose tips in A1, 10 x unidose tips in A3, 1 x getting started kit, directions for use, technique guide and technique video

KR36043 SonicFill 2 Value kit  
Value kit contains 1 x SonicFill handpiece, 40 x unidose™ tips in A1, 40 x unidose tips in A3, 220 x unidose tips in A2, directions for use and technique guide

Unidose refills - each contains 20 x unidose tips

- KR36051 SonicFill 2 unidose refill A1
- KR36052 SonicFill 2 unidose refill A2
- KR36053 SonicFill 2 unidose refill A3
- KR36054 SonicFill 2 unidose refill B1

Contact **Oraltec** for all your dental supply requirements

Proud to be New Zealand owned and operated



### X-TRA BASE®

Flowable light-curing base composite



#### Indications

- Base in class I and II cavities
- Cavity lining under direct restorative materials in class I and II cavities
- Small, non occlusal stress-bearing class I restorations according to minimally invasive filling therapy
- Class III and V restorations
- Extended fissure sealing
- Undercut blockout
- Repair of small enamel defects

#### Advantages

- Curing time only 10 seconds
- Low shrinkage stress
- 4mm restoration base in one simple step
- High radiopacity (350% Al)
- Can be combined with any methacrylate-based bonding or composite

- VO1790 X-tra base® syringe - 2 x 2g universal + accessories
- VO1791 X-tra base® syringe - 2 x 2g A2 + accessories
- VO1794 X-tra base® capsules - 16 x 0.25g universal
- VO1795 X-tra base® capsules - 16 x 0.25g A2



### X-TRA FIL®

Light curing posterior filling material

#### Indications

- Class I and II posterior fillings
- Core build-up

#### Advantages

- 4mm composite layer in one step
- Curing depth 4 mm
- Curing time only 10 seconds
- Universal shade
- Long-lasting and economic
- Easy handling
- Excellent physical properties

- VO1740 X-tra fil® syringe - 1 x 5g universal
- VO1741 X-tra fil® capsules - 20 x 0.25g universal



### ADMIRA® FUSION X-TRA

Nanohybrid ORMOCER® bulk fill restorative material, 4 mm

- Purely ceramic-based, bulk fill restorative material
- Fast and high-quality – reliable curing of 4mm layers
- Extremely low polymerisation shrinkage (1.25% per volume) and particularly low level of shrinkage stress
- Universal shade with chameleon effect

#### Indications

- Class I and II posterior restorations
- Base in class I and II cavities
- Class V restorations
- Locking, splinting of loose anteriors
- Repairing veneers, small enamel defects and temporary crown and bridge materials
- Extended fissure sealing
- Restoration of deciduous teeth
- Core build-up

- VO2810 Admira® Fusion x-tra syringe - 1 x 3g universal
- VO2811 Admira® Fusion x-tra capsules - 15 x 0.2g universal



# Restorative Products

## FLOWABLE COMPOSITES

### GRANDIO®SO HEAVY FLOW

*Flowable universal nano-hybrid restorative material - high viscosity*



#### Indications

- Fillings of class I to V cavities
- Extended fissure sealing
- Blocking out undercuts
- Lining or coating cavities
- Repairing fillings and veneers
- Interlocking and splinting teeth (e.g. with glass fibre strands)
- Use as a base material in combination with glass fibres or similar products for fabricating semi-permanent crowns and bridges

#### Advantages

- Increased stability in comparison to conventional flowables
- Universal application
- Very high filler content of 83 % w/w
- Ideal for use in combination with GrandTEC splint system (pg 144)

Available in shades A1, A2, A3, A3.5, A4, A5, B1, B2, C2, OA2, BL, WO

VO26\_ Grandio®SO Heavy flow syringes (2 x 2g) - specify shade

### GRANDIO®SO FLOW

*Flowable universal nano-hybrid restorative material*



#### Indications

- Fillings of Class I - V cavities
- Extended fissure sealing
- Blocking out undercuts
- Lining or coating cavities
- Repairing fillings and veneers
- Interlocking and splinting teeth (eg, with glass fibre strands)
- Use as a base material in combination with glass fibres or similar products for fabricating semi-permanent crowns and bridges

#### Advantages

- Universal application
- Very high filler content of over 80% w/w

Available in shades A1, A2, A3, A3.5, A4, A5 B1, B2, C2, OA2, BL, WO

VO27\_ Grandio®SO Flow syringes (2 x 2g) - specify shade

### GRANDIO® FLOW

*Flowable universal nano-hybrid restorative material*



#### Indications

- Filling minimally invasive cavities of all classes
- Filling small class I cavities and extended fissure sealing
- Filling class II - V cavities including V-shaped defects and cervical caries
- Blocking out of undercuts
- Lining or coating cavities

#### Advantages

- Optimal flowability
- High filler content of 80 % w/w
- Significantly lower polymerisation shrinkage than conventional flowables
- Very good abrasion resistance
- High transverse strength

Available in shades A1, A2, A3, A3.5, B1, B2, C2, D2, OA2, BL, WO

VO18\_ Grandio® Flow syringes (2 x 2g) - specify shade

### AMARIS® FLOW

*Highly aesthetic light-curing flowable restorative material*



#### Advantages

- The ideal addition to Amaris
- Simple modelling of the incisal edge



#### Amaris Flow® special shades

VO1945 Amaris® Flow 2 x 1.8g syringes - HT (high translucent)  
VO1946 Amaris® Flow 2 x 1.8g syringes - HO (high opaque)

### ADMIRA® FUSION FLOW

*Flowable light-curing nanohybrid Ormocer® restorative material*

#### Indications

- Filling of small cavities and extended fissure sealing
- Blocking out undercuts
- Lining or coating cavities
- Fillings of class III - V cavities
- Locking, splinting of loose teeth



#### Advantages

- The first purely ceramic-based flowable restorative material
- Pure Silicate Technology with matrix based on silicon oxide
- Contains no classic monomers
- Extremely low polymerisation shrinkage (2.75 % by volume) and particularly low level of shrinkage stress in comparison to conventional flowable restorative composites
- Inert and biocompatible
- Extremely resistant to discolouration
- "Flow on demand" – the material becomes flowable only when under pressure or in motion
- Excellent handling
- High surface hardness guarantee long-term results
- Compatible with all conventional bonding agents



Available in shades A1, A2, A3, A3.5, A4, B1, B2, C2, Incisal, OA2, BL and WO

VO28\_ Admira® Fusion Flow (2 x 2g) syringe - specify shade

### HERCULITE ULTRA FLOW

*Nanohybrid flowable composite*

Herculite Ultra Flow combines the long-standing expertise of the Herculite brand with an innovative flowable composite.

It is the perfect match with the esthetics and performance of Herculite Ultra. Featuring Smart Placement Technology, Herculite Ultra Flow flows easily when used as a base/liner and maintains its shape when used in small restorations.

- Smart placement technology
- Outstanding flexural strength
- Over 300% radiopacity
- Low shrinkage
- Easy polishability, excellent gloss retention and low wear

Supplied as 2 x 2g syringe

Available in various shades

KR3539\_ Herculite Ultra Flow - specify shade



# Restorative Products

## SPECIALISED COMPOSITES

### GRANDTEC®

Resin-impregnated light-curing glass fibre strands for dental adhesive technique

#### Indications

- Stabilisation of teeth
  - after orthodontic therapy
  - after periodontal therapy
- For support in trauma therapy
  - for locking and splinting avulsed or loosened teeth
  - fragment fixation after fracture
- For reinforcing / fabricating provisional bridges made from composite and temporary C&B materials
- For temporary treatment after extraction and replacing a missing tooth using an artificial tooth
- For temporary treatment after placing an implant during the osseointegration of the implant

#### Advantages

- Additional product for reinforcing composite / flow composite in traumatology, periodontics, orthodontics, conservative dentistry and prosthodontics
- Ideally used with GrandioSO heavy flow composite

VO1168 Glass fibre strands 5 x 55mm

VO1169 GrandTEC® test kit

Kit includes 5 glass fibre strands (55mm each), model, application aids, GrandioSO Heavy Flow syringe 2 x 2g A3 + accessories



### FINAL TOUCH STAINING SYSTEM

Light-curing characterisation material

#### Indications

- Personalised characterisation of direct and indirect composite restorations
- Masking of tooth discolourations
- Characterisation of chairside CAD/CAM veneers

#### Advantages

- Reproduction of fissures, white spots and individual enamel characteristics
- Perfect extension of VOCO's composite and ORMOCER® restorative materials
- Excellent handling for high-aesthetic results
- Fine material structure and homogeneous consistency for an accurate application
- In the non-dripping NDT®-syringe
- 5 colours with corresponding opacity to the field of application (white, blue, yellow, orange, brown)

VO2321 FinalTouch syringe set

Set includes 5 x 1.5g syringes (white, blue, yellow, orange, brown) + accessories



VO232\_ FinalTouch syringe - specify shade

### GRANDIOSO INLAY SYSTEM

Complete kit for chairside fabrication of indirect composite inlays

#### Advantages

- Complete set for chairside fabrication of 15 composite inlays
  - full added value retained in the practice, no laboratory involvement
  - less expensive than CAD/CAM fabricated inlay
- Highest quality, perfectly coordinated components
  - quick and simple fabrication of models
  - GrandioSO guarantees durability and aesthetics
  - Futurabond DC and Bifix QM for secure bonding and luting
- Simple and efficient method
  - easy and convenient to fabricate, even for large multi-surface restorations
  - fabrication of a row of inlays for treatment of neighbouring teeth
  - perfect occlusal anatomy - modelled extraorally



VO2642 GrandioSO Inlay System set

Set includes 3 x 50ml cartridges die silicone, GrandioSO caps 15 x 0.25g (5 each of A2, A3, A3.5), Futurabond DC SingleDose 15 pieces, QuickMix syringe Bifix QM 10g universal, Dimanto set (one each of small point, large point, small cup, large cup, lens) + accessories

VO1186 Die silicone refill cartridge

- 2 x 50ml cartridges + 10 x blue mixing tips (type 20)

### QUICK UP®

Self-curing luting material for attachments and secondary denture parts

#### Indications

- Gingiva-coloured composite for luting attachments, such as ball, Locator® and telescope retention elements in prostheses with plastic bases
- Reluting secondary elements in prostheses with plastic bases, e.g. connecting bars

#### Advantages

- Very simple chairside use
- High strength values
- Complete set for immediate use, including checking and blockout material for primary structures that require protection, e.g. implants
- Ideal combination of self-curing luting material and light-curing correction material

VO1625 Quick Up syringe set

Syringe set includes QuickMix syringe 7.5g, Quick Up LC syringe 2g, adhesive bottle 4ml, Fit Test C&B QuickMix syringe 5ml + accessories

VO1626 QuickMix syringe 7.5g + accessories

VO1627 Quick Up LC syringe 2g + accessories





# Restorative Products

## GLASS IONOMERS

### VOCO IONOFIL® MOLAR AC QUICK

*Glass ionomer restorative material*

#### Indications

- Restorations of class II cavities (not occlusion-bearing)
- Temporary long-term treatment of class I and II cavities
- Build-up fillings and linings
- Core build-up
- Restoration of deciduous teeth
- Restoration of V-shaped defects and cervical enamel or root erosions including class V cavities

#### Advantages

- Very good packability
- Non-sticky consistency
- Very high abrasion resistance, compressive and transverse strength
- Continuous high fluoride release
- Biocompatible
- Tooth-like aesthetic translucency
- Setting time of 2.5 minutes

Supplied as a packet of 48 capsules

- VO1631 VOCO Ionofil Molar AC Quick A1  
 VO1632 VOCO Ionofil Molar AC Quick A2  
 VO1633 VOCO Ionofil Molar AC Quick A3



### IONOLUX®

*Light-curing glass ionomer restorative material*

#### Indications

- Class III and V restorations, primarily cervical fillings and root caries
- Restoration of deciduous teeth
- Small class I fillings
- Temporary fillings



#### Advantages

- Excellent working time – setting time adjustable by light-curing
- No need for conditioning of dental hard tissue
- Immediately packable after placement in the cavity
- Does not stick to the instrument, easy to model
- Fill, polymerize and finish – no varnish required
- Fluoride release
- Biocompatible
- Radiopaque

Powder/liquid sets available in shades A1, A2 or A3

VO199\_ Ionolux® powder/liquid (12g/5ml) + accessories - specify shade

Capsules available in shades A1, A2, A3, A3.5 and B1

Supplied as a pack of 20 capsules

VO21\_ Ionolux® capsules - specify shade



### IONOSTAR® MOLAR

*Glass ionomer restorative material*

#### Indications

- Restorations of non occlusion-bearing class I cavities
- Semi-permanent restorations of class I and II cavities
- Restorations of cervical lesions, class V cavities, root caries
- Restorations of class III cavities
- Restoration of deciduous teeth
- Base / liner
- Core build-up
- Temporary restorations

#### Advantages

- Variable mixing time for adjustment of consistency
- Easy application and perfect marginal adaptation
- Can be modelled immediately after insertion without sticking to the instrument
- The new capsule design reaches smaller cavities and difficult-to-access areas in the mouth
- High compressive strength and abrasion resistance
- With proven VOCO glass technology

Available in shades A1, A2 and A3

Supplied as a packet of 20 capsules



VO252\_ Ionostar® Molar capsules - specify shade

### EASY GLAZE

*Nano-filled light-curing protective coating for surface sealing*

#### Indications

- Surface sealing of provisional crowns and bridges, glass ionomer restorations and definitive composite restorations
- Protecting glass ionomer surfaces against the effects of moisture and dehydration immediately after placement
- Sealing glass ionomer liners / build-up restorations before taking impressions
- Sealing and protecting adhesive interfaces between restoration and tooth structure



#### Advantages

- Glossy and aesthetic surfaces
- Easy to use
- Provides protection against discolouration

#### In combination with VOCO Ionofil® Molar and IonoStar®

- Protects against moisture and dehydration immediately after filling placement
- Tooth-like fluorescence
- Natural gloss

Supplied as a 5ml bottle

VO1016 Easy Glaze



# Restorative Products

## CORE BUILD UP MATERIALS

### REBILDA® DC

*Dual-curing flowable core build-up composite*

#### Indications

- Adhesive core build-up on vital and non-vital teeth
- Luting of fibre-reinforced resin posts

#### Advantages

- Light-curing for time-saving application
- Chemical curing for complete curing
- Optimised small mixing tips save material
- Low heat development even in bulk application
- Flowable



VO1395 Rebilda DC cartridge set  
*Cartridge set includes cartridge 50g dentine, Futurabond DC bottle each of 4ml liquid 1 and 2, dispenser type 3 + accessories*

VO1396 Rebilda DC cartridge dentine 50g + accessories

VO1398 Rebilda DC cartridge white 50g + accessories

VO2259 Dispenser type 3 for Rebilda DC  
for 1:1 or 1:2 cartridges (25ml)



VO1403 Rebilda DC QuickMix syringe dentine 10g + accessories

VO1405 Rebilda DC QuickMix syringe white 10g + accessories

### REBILDA® FORM

*Moulds for adhesive core build-up*

#### Indications

- Shaping aids for adhesive core build-up in cases of severely damaged teeth with or without the use of an endodontic post

#### Advantages

- Simple use with all composite core build-up materials
- Three surgery-oriented sizes
- Translucent for photo polymerisation
- The special shape provides quick adaptation to the tooth
- Does not bond to standard composite materials

Supplied as a packet of 20 pieces



VO1407 Rebilda® Form - small

VO1408 Rebilda® Form - medium

VO1409 Rebilda® Form - large

### REBILDA POSTS

#### Indications

- Endodontic post build-up for support and anchoring of coronal restoration in situations with insufficient tooth substance

#### Advantages

- Dentine-like elasticity behaviour, high transverse strength
- High radiopacity (35% Al)
- Anatomical shape
- Adhesive luting



#### Post sizes:

Post 10 (1.0mm, red)

Post 12 (1.2mm, green)

Post 15 (1.5mm, black)

Post 20 (2.0mm, yellow)

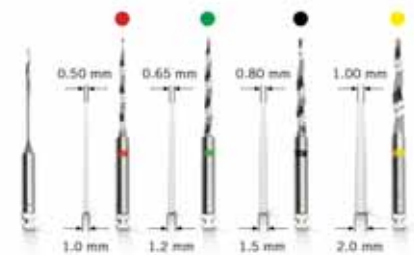

#### Drill sizes:

Drill 10 (1.0mm)

Drill 12 (1.2mm)

Drill 15 (1.5mm)

Drill 20 (2.0mm)



VO177\_ Rebilda posts, 5 pieces - specify size

VO177\_ Rebilda drills, 1 piece - specify size

VO1769 Rebilda Post reamer (0.7mm) - 3 pieces



VO1770 Rebilda Post set only

*Set includes 5 posts each of (1.2mm, 1.5mm, 2.0mm), 1 drill each of (1.2mm, 1.5mm, 2.0mm)*



VO1771 Rebilda Post System complete kit

*Kit includes 5 posts each of (1.2mm, 1.5mm, 2.0mm), 1 drill each of (1.2mm, 1.5mm, 2.0mm), 1 reamer (0.7mm), Ceramic Bond bottle 5ml, Futurabond DC SingleDose 15 pieces, Rebilda DC dentine QuickMix syringe 10g + accessories*

# Restorative Products

## CORE BUILD UP MATERIALS (continued)

### VISALYS CORE

*Visalys® Core core build-up material with unique Active-Connect-Technology (ACT) for bonding reliably with light and dual-curing one step and multi step adhesives*

**Bisphenol A free:** No health risk to the dentist or patient by exposure to bisphenol A and its derivatives.

#### Benefits

- **Active-Connect-Technology:** Top bond strength with light and dual-curing one step and multi step adhesives – without an additional activator
- For cores and cementing root posts
- Dual-curing saves time and provides dependability
- Excellent positional stability yet good flowability and low extrusion force; easily trimmed
- Minimal smear layer, even without light-curing

#### Advantages

- Existing adhesive system can still be used
- Optional light-curing saves time, self-cures dependably even in deep areas

Supplied as 2 x 5ml syringes - in white or dentine shades

KT13860 Visalys Core - white  
KT13861 Visalys Core - dentine



## TEMPORARY MATERIALS

### VISALYS TEMP

*Visalys® Temp is a temporary crown and bridge material based on a multifunctional acrylic composite*

It is suitable for the fabrication of temporary crowns, partial crowns, bridges, inlays, onlays and veneers.

#### Advantages

- Very stable and fracture resistant – long periods in situ, fewer repairs
- Easy to process, can be trimmed with minimum dust generation
- Curing with minimum inhibition layer, virtually no reworking required
- High fluorescence and translucency (chameleon effect), therefore also suitable for esthetically demanding temporary anterior restorations
- Smooth surface and high lustre, even without polishing
- Also suitable as long-term temporary restoration (> 4 weeks)
- Free of bisphenol A

Supplied as 1 x 50ml cartridge

KT13780 Visalys Temp A1  
KT13781 Visalys Temp A2  
KT13782 Visalys Temp A3  
KT13790 Visalys Temp A3.5



## Highly acclaimed product performance – From impression to resin materials



A wide range of choices for a wide range of indications. Kettenbach offers you modern high quality impression and composite materials for superior precision and performance even in extreme situations. Try by yourself.

[www.kettenbach.com](http://www.kettenbach.com)

# Restorative Products

## TEMPORARY MATERIALS (continued)

### STRUCTUR PREMIUM

*Highly aesthetic composite material for the fabrication of provisional crowns and bridges*

#### Indications

- Fabrication of highly aesthetic temporary crowns, bridges, inlays and onlays

#### Advantages

- Aesthetic like porcelain
- High stability of shape and shade
- Natural fluorescence
- Brilliant gloss
- As hard as enamel
- Extremely high fracture resistance
- Perfect handling
- Convenient work steps, easy to trim and polish
- Can be used for long term temporaries

Available in shades A1, A2, A3, A3.5 and B1



VO171\_ Structur Premium 75g cartridge + mixing tips  
- specify shade

### STRUCTUR 2 SC

*Self-curing composite material for the fabrication of provisional crowns and bridges*

#### Indications

- Fabrication of aesthetic temporary crowns, bridges, inlays and onlays

#### Advantages

- Less than 1 minute setting time in the mouth
- Easy to shape and polish
- Economical due to minimal material loss
- Natural fluorescence



Supplied as 75g cartridge + mixing tips

VO1479 Structur 2 SC A1  
VO1480 Structur 2 SC A2  
VO1481 Structur 2 SC A3  
VO1490 Structur 2 SC A3.5  
VO1482 Structur 2 SC B1

VO1478 Structur 2 SC cartridge set  
Set includes 75g cartridge A3, dispenser type 2 + accessories

### CLIP FLOW

*Flowable, light-curing filling material for temporary restorations*

#### Indications

- Temporary inlay and onlay treatments of the cavity
- Sealing of openings for implant screws
- Relining material for temporary crowns and bridges
- Block out material for retentive areas in the dental arch eg., before taking impressions
- Covering of the gingival margin
- Fixing of resin matrix during filling placement
- Temporary filling of cavities and sealing of root canal orifices

#### Advantages

- Easy to place  
– easy to remove in one piece
- Durable and saliva-proof
- Time-saving and economical
- Flowable



VO1282 Clip Flow syringe 2 x 1.8g + accessories

### CLIP & CLIP F

*Light-curing filling material for temporary restorations*

#### Indications

- Temporary fillings
- Temporary sealing of cavities, especially in inlay/onlay technique

#### Advantages

- Easy to place – easy to remove in one piece
- Time-saving and economical
- Specifically useful in inlay/onlay technique



#### Clip

VO1284 Clip syringe 2 x 4g  
VO1287 Clip capsules 25 x 0.25g



#### Clip F with fluoride

VO1289 Clip F syringe 2 x



## AMALGAM

### CAVEX AMALGAM CAPSULES

- Safe, self-activating, reclosable capsules
- Gamma 2-free Cavex admix amalgam
- Corrosion resistant
- No discolouration
- Meets the ISO and ADA standards
- Made up of dispersed alloy containing 70% lathe cut and 30% spherical
- High silver content (69.2%) making it very durable
- Competitively priced



#### 50 capsules

CALK021 1 spill  
CALK022 2 spill  
CALK023 3 spill

#### 300 capsules

CALK031 1 spill  
CALK032 2 spill  
CALK033 3 spill



# Restorative Products

## SECTIONAL MATRIX SYSTEM

### NITINOL SECTIONAL MATRIX SYSTEM

*The advanced matrix technology for Class II composite restorations*

#### Advantages of the NiTin System

- Ring is made from drawn nitinol wire which makes it stronger and gives tight contacts
- Ring lasts longer and less likely to break due to metal fatigue
- Improved tip design gives the ring better grip so it is less likely to slip off the tooth
- Matrix bands are full curve shape and match tooth anatomy better
- Matrix bands have an easy insert tab making them easy to place
- Band forceps grip bands firmly and are good for wedge insertion
- Ring forceps have curved tips for secure hold
- Ring forceps are comfortable to hold

*NiTIn Complete Kit includes:*

- 1 x premolar NiTin ring
- 1 x new molar NiTin ring
- 80 x assorted full curve matrices
- 80 x assorted edges
- 1 x ring placement forceps
- 1 x band forceps



RENTKMN01 NiTin complete kit

#### Also sold separately:

##### Rings

- Supplied as a packet 2

RENT400 NiTin molar rings  
RENT500 NiTin premolar rings



##### Wedges

- Available in 4 sizes or as a kit
- Supplied as a packet of 100 (except for kit\*)

RENTYL NiTin wedge - yellow/xsmall  
RENTBL NiTin wedge - blue/small  
RENTOR NiTin wedge - orange/medium  
RENTGR NiTin wedge - green/large  
RENTK4 NiTin wedge kit - packet of 400  
(\*includes 100 of each size)



##### Matrix Bands

- Available in 5 sizes
- Supplied as a packet of 50

RENTM100 NiTin metal matrix band premolar 4.4mm  
RENTM175 NiTin metal molar band 5.6mm  
RENTM150 NiTin metal premolar band with extension 6.0mm  
RENTM200 NiTin metal tall molar band 6.6mm  
RENTM300 NiTin metal tall molar band with extension 8.7mm



RENTM100 RENTM175 RENTM150 RENTM200 RENTM300

##### Instruments

RENTMRDF100 NiTin ring placement forceps  
RENTDF68 NiTin band forceps/tweezers



## MATRIX RETAINERS & BANDS

### MATRIX BAND RETAINERS

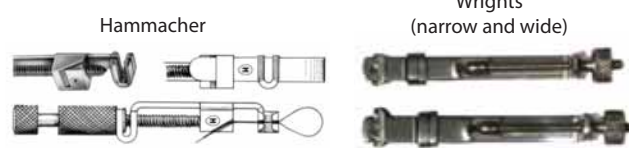

HMHSH13600 Hammacher tofflemire-universal retainer  
WRRETAINN Wrights narrow siqveland retainer  
WRRETAINW Wrights wide siqveland retainer

### SIQVELAND MATRIX BANDS

- Available in two sizes
- Supplied as packets of 12

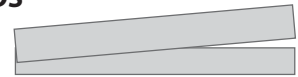

WRBANDN Siqveland matrix bands - narrow  
WRBANDW Siqveland matrix bands - wide

### RAND TOFFLEMIRE MATRIX BANDS

- Supplied as packets of 12

RA051 Matrix bands - #1  
RA053 Matrix bands - #2  
RA055 Matrix bands - #3  
RA057 Matrix bands - #13



### HAWE TOFFLEMIRE MATRICES

- Supplied as packets of 30

KR100130 No.1 - 0.050mm  
KR110130 No.1 - 0.038mm  
KR100230 No.2 - 0.050mm  
KR110230 No.2 - 0.038mm  
KR100330 No.3 - 0.050mm  
KR110330 No.3 - 0.038mm  
KR101330 No.13 - 0.050mm  
KR101330 No.13 - 0.038mm



### MATRIX HO BANDS

*HO Bands™ are stainless steel .001 thick matrix bands*

- Easy to contour and adapt to any tooth structure
- Available in regular or dead soft
- Supplied as a packet of 100

YO351110 Matrix HO band 1 - thin deadsoft  
YO350110 Matrix HO band 1 - thin regular  
YO351210 Matrix HO band 2 - thin deadsoft



### CLEAR RUA MATRIX STRIPS

- Straight or curved
- 8mm or 10mm wide
- Packet of 200

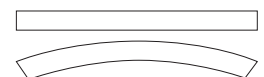

ASMATRIXC Clear Rua matrix strips, curved 8mm  
ASMATRIXC1 Clear Rua matrix strips, curved 10mm  
ASMATRIXS Clear Rua matrix strips, straight 8mm  
ASMATRIXS1 Clear Rua matrix strips, straight 10mm



### HAWE STRIPROLL

*Transparent polyester strip in handy dispenser for all anterior teeth filling materials*

- 0.050mm thickness

KR685 6mm wide x 15 metres long  
KR686 8mm wide x 15 metres long  
KR687 10mm wide x 15 metres long



# Restorative Products

## APPLICATORS

### MICROBRUSHES

*Disposable micro-applicators*



For precise applications in areas of limited access.

Multiple applicator colours are available to identify different materials during a procedure.

#### Usage

- Sealants
- Bonding agents
- Etchants
- Haemostatic solutions
- Cavity liners
- Disclosing solutions



Available in three precise sizes (to match the size of the preparation)

- **Regular** (2.0mm) in purple, peach, blue and green
- **Fine** (1.5mm) in pink and yellow
- **Superfine** (1.0mm) in white

Sold as 4 refill cartridges of 100 applicators each

Available in tubes or refills (to be used in dispensers)



Regular Tube  
HYMRA400



Fine Tube  
HYMFA400



Super Fine Tube  
HYMSF400



Regular Refill  
HYPR400



Fine Refill  
HYPF400



Super Fine Refill  
HYPSF400

#### Dispenser kits

- Supplied as 4 refills of 100 + dispenser

HYMPR400K Regular kit

HYMPF400K Fine kit



### ULTRABRUSH APPLICATORS

- Chemical resistant fibres
- Bendable plastic handle
- Excellent for:
  - Sealants
  - Adhesives
  - Fluoride
  - Resins
  - Whitening



#### Ultrabrush 1

- Orange and blue
- 100 fibres per brush
- 2 refills of 100

HYU1R200 - Ultrabrush 1



#### Ultrabrush 2

- Green and gold
- 200 fibres per brush
- 2 refills of 100

HYU2R200 - Ultrabrush 2

### MICROBRUSH X EXTENDED REACH MICROBRUSHES

*Extra thin black applicators, ideal for confined spaces*

- Excellent for bonding posts
- With stiffer non-linting fibres
- Patented bending portion bendable up to 90°



Bonding posts



Inlay/Onlay  
Cementation

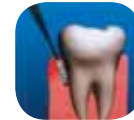

Perio/Subgingival



Supplied as a packet of 100

HYPX100 Microbrush X



### MICRO-STIX

*Adhesive tip applicators*



- Disposable adhesive applicators which hold restorations as necessary
- Pick up item, place and twist to release
- Ideal for holding veneers, inlays, onlays, bands, brackets, clasps
- **Original hold - Blue** - strong adhesive for extra holding strength
- Supplied as 4 packets of 16 applicators



Pick...

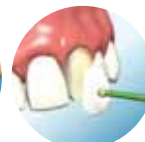

Place...

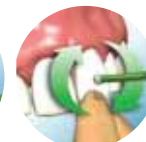

Twist.



HYSTIX64B Micro-Stix applicators - original hold (blue)

### PELE TIM

*Foam pellets for applying liquid and paste preparations*

#### Indications

- Vitality tests
- Removal of material excess while cementation or sealing



#### Advantages

- Pain free application without pressure
- Economical application
- Hygienic application without fluff

VO2250	Pele Tim No. 0 - 3,000 x 3mm
VO2252	Pele Tim No. 1 - 3,000 x 4mm
VO2253	Pele Tim No. 2 - 1,000 x 5mm
VO2254	Pele Tim No. 3 - 500 x 8mm
VO2255	Pele Tim No. 4 - 500 x 6 x 8mm



### BRUSH TIPS AND HANDLE

- Long bristle brush tips for better accessibility
- Short bristle brush tips
- Supplied as a packet of 100



LAT34100	White, black tip, fine
LAT33100	White, black tip, extra fine
LAT32100	White, white tip, fine
LAT32100	White, white tip, extra fine
LAHANDLE	Black brush handle (each)



# Restorative Products

## STRIP CROWNS

### ASSOCIATED STRIP CROWNS

Kemdent's range of strip crowns offers the dentist a comprehensive selection of anatomically contoured flexible tooth forms, catering for upper anteriors - centrals, laterals, canines and premolars as well as lower incisors.

#### Uses

- Making temporary jacket and post crowns directly in the mouth
- As a matrix for making individual teeth for partial dentures
- For repairing or facing a broken incisal edge
- As part of the build-up technique



Standard assortment kit



- Supplied as a packet of 2 (ie left and right)
- Available in assorted kits (incisal or standard) or refill packs
- Incisor (I), premolar (P), canines (C)

ASCROWN1 Strip crown incisal assortment kit

Contains 15 pairs (left and right) of the following (30 in total):  
1 x I105, 1 x I100, 1 x I95, 1 x I90, 1 x I85, 1 x I80, 1 x I75, 1 x I70, 1 x I65,  
1 x P70, 1 x P75, 1 x C65, 1 x C75, 1 x C85, 1 x C95

ASCROWNS Strip crown standard assortment kit

Contains 15 pairs (left and right) of the following (30 in total):  
1 x I05, 1 x I00, 2 x 95, 2 x 90, 2 x 85, 2 x 80, 2 x 75, 2 x 70, 1 x 65

ASCROWC\_ Canine refills - packet of 2 (pair)  
Choose from C65, C75, C85, C95

ASCROWP\_ Premolar refills - packet of 2 (pair)  
Choose from P70, P75

ASCROWI\_ Incisor refills - packet of 2 (pair)  
Choose from I65, I70, I75, I80, I85, I90, I95, I100, I105

## ACCESSORIES

### PDS LIGHT FILTER PADDLE

- Shields eyes from potentially damaging UV light
- Size: 250 x 127mm



PD35100 Orange light filter paddle  
PD35103 Red light filter paddle

### PDS PATIENT MIRROR

- 250 x 127mm

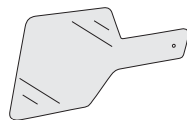

PD35101 Patient mirror

### GLASS MIXING SLABS

- Sold individually



LASLAB77 Glass mixing slab - 7 x 7cm

### MGK MIXING PADS

- Made from specially coated, abrasion resistant paper
- Four sizes available

MG80801 Small 3.5 x 4.5cm - 40 sheets  
MG80820 Universal 7 x 8cm non skid - 60 sheets  
MG80822 Medium 12.5 x 18cm - 25 sheets  
MG80823 Large 15 x 24cm - 35 sheets



### HAWE INTERDENTAL WOODEN WEDGES

- Anatomical shape with concave sides
- Made from splinter-free sycamore wood
- Available in different shapes
- Colour coded for easy identification
- Available as a packet of 100 or an assorted set



KR822\_ Inter dental wood wedges - specify size/colour  
KR823 Assorted set

### BARMANS WOODEN WEDGES

- Barmans anatomical wedges, with curved sides for correct matrix band support and optimal lateral pressure at wedge edge
- Supplied as a packet of 200



SVAUX095 Large - blue  
SVAUX090 Small - natural  
SVAUX100 Assorted - large and small

### GLASS DAPPEN DISHES

- Made from high quality glass
- Sold individually



SVAUX088 Glass dappen dish - dark blue  
LAV2AM Glass dappen dish - amber  
LAV2BL Glass dappen dish - blue  
LAV2TR Glass dappen dish - clear  
LAV2GR Glass dappen dish - green

### PLASTIC DAPPEN DISHES

- Inexpensive plastic disposable dappen dishes
- Assorted colours - white, blue, red and yellow (can supply individual colours if requested)



Supplied as a packet of 100

SVDIS250 Plastic dappen dishes

### DAPPEN SILICONE BOWL

- Silicone dappen bowl 5ml
- Approximate size - ø 2.5cm x H2.8cm

LABOWLD12 Dappen bowl D12



### PETROLEUM JELLY

- For gingival protection
- Supplied as a 500g jar

MUJEL500 Petroleum jelly



# Restorative Products

## DISPENSERS

### COMPOSITE CAPSULE DISPENSERS



VOCO capsule dispenser  
VO9301



Kerr compule gun  
For unidose applications  
KR21782

### FORCEPS-TYPE APPLICATORS FOR GLASS IONOMER CAPSULES



VOCO applicator - AC type 1  
VO2331



VOCO applicator - AC type 2  
VO2334

### CARTRIDGE DISPENSERS



VOCO dispenser - type 2  
For 1:1/1:2 for 50ml cartridges  
VO2158



VOCO dispenser - type 3  
For 1:1/1:2 for 25ml cartridges  
Suitable for Rebuilda DC  
VO2259



Kettenbach Applifix 6 dispensing gun  
For 4:1/10:1 for 50ml cartridges  
Suitable for Visalys Temp  
KT17208

## CAPSULE MIXER

### OPTIMUM CAPSULE MIXER AMALGAMATOR

a.max AM-1 capsule mixer is a mixing unit for all capsules of dental restorations including capsuled amalgam, glass ionomer and other predosed dental material in capsules.

It is safe, powerful, stable and quiet.

- User friendly
- Ergonomic design
- Homogeneous mixing
- High quality performance
- Quiet and stable operation
- Easy loading and sturdy capsule holder



MIAM1  
Optimum capsule mixer amalgamator

## CURING LIGHTS

### DEMI PLUS WAND CURING LIGHT

- Lightweight, ergonomic design
- Interchangeable light guides
- Whisper-quiet fan
- Multiple curing options
- Periodic level shifting



KR910860 Demi Plus LED wand curing light  
Contains 1 handpiece, 1 standard 8 mm turbo light guide, 1 lithium-ion demi battery pack, 1 battery charger, 1 power supply, 1 protective light shield

### DEMI™ ULTRA WAND CURING LIGHT

LED ultracapacitor curing light system

- U-40 Ultracapacitor re-energizes to full power in under 40 seconds, for incomparable convenience
- C.U.R.E (Curing Uniformity and Reduced Energy) Technology delivers uniform depth of cure with industry-leading low temperatures
- Easy Suite provides for simple, intuitive operation in a durable yet lightweight design



KR35664 Demi Ultra LED wand curing light

Contains 1 handpiece, 1 8mm light attachment, 1 charging dock with radiometer, 1 power supply, 1 protective light shield, IFU

### SILVER LED CORDLESS WAND CURING LIGHT

The stylish silver metallic LD-M1 LED WAND style curing light has a light output of 1,400mW/cm<sup>3</sup> with three functional modes:

U1 - full power, U2 - ramping up, U3 - pulse



- The small charger base is very stable
- A built-in sleep mode saves battery energy
- Supplied with a rechargeable batter that can easily be replaced by the user when necessary



MILDM1 Silver LED cordless wand curing light

### BLUELEX GT1200 LED CORDLESS GUN CURING LIGHT

BlueLex GT-1200 is a powerful cordless LED curing light that comes with a built-in radiometer and cooling fan that keeps the unit cool for continuous operation. With a high light intensity of 1,200 mW/cm and three modes, GT-1200 is suitable for curing all types of light-curing resin composites. Curing durations can be adjusted in 5 second increments.



MIGT1200 BlueLex GT1200 LED cordless gun curing light

Also available, the BlueLex GT1200W curing light has an additional selection of a whitening mode to use in combination with the provided whitening arch.

This allows users to not only quickly cure resin-based composite materials, but also provide whitening treatments when used in conjunction with whitening gels.



Bleaching arch included

MIGT1200W BlueLex GT1200W LED cordless gun curing light with whitening mode



# Suction Products

## HIGH VOLUME SUCTION TIPS

### SURGICAL ASPIRATOR TIPS

- Autoclavable up to 134°C
- Silent
- Ergonomic design
- Two lengths available for adults and children
- Supplied as packets of 10

#### Surgical Aspirator Tips for Adults

- Length 140mm
- Two diameter sizes available - 11mm and 16mm

DP40001BC Surgical aspirator tips 11mm - white  
 DP40002BC Surgical aspirator tips 16mm - white  
 DP40004BL Surgical aspirator tips 16mm - blue

#### Surgical Aspirator Tips for Children

- Length 110mm
- Diameter 16mm

DP60001BC Surgical aspirator tips, bambino - white  
 DP60004BL Surgical aspirator tips, bambino - blue



### METAL SURGICAL ASPIRATORS

- Sold individually

SA15P1A Surgical aspirator, metal  
 - 1.5mm tip

SA15P3A Surgical aspirator, metal  
 - 3mm tip

SA16RSA Surgical aspirator, metal  
 - 4mm tip



### SILICONE TIP ASPIRATOR KIT

- Autoclavable silicone tips prevent metal contact with implant
- Tips are easily modified with scissors or knife



SA46YST Silicone tip aspirator kit  
 Kit includes stainless steel aspirator and 1 trimmable silicone tip



### VERITIP STERILE SURGICAL SUCTION TIPS

*Recommended for implantology, endodontic treatments and surgery*

- Tip-opening:  $\varnothing$  2-8mm
- Length 200mm
- Individually packed for single use

Supplied as a packet of 20 aspirators plus 1 double adaptor to fit most suction tubings (from 6mm - 11mm and 11mm - 16mm)

DPTIP025 Veritip suction tips



## CATTANI SUCTION TIPS AND ADAPTORS

- All tips and adaptors are autoclavable to 135°C

### High volume evacuator (HVE) tips

Tip #17 - spray interceptor

- To fit 11mm hose
- Tip width 18mm including flange
- Supplied as a packet of 3

CTCT17 HVE tip #17

Tip #22 - high volume tip

- To fit 17mm hose
- Tip width 18mm including flange
- Supplied as a packet of 3

CTCT22 HVE tip #22

### Surgical suction tip

Tip #9 - surgical tip

- To fit 11mm hose
- Tip width 6mm
- With smaller diameter for more precise evacuation of fluids
- Supplied as a packet of 3

CTCT9 Surgical suction tip #9



### Reducer adaptor for suction tips

- Reduces the internal bore diameter of the 17mm hose terminal to 11mm for fitment of 11mm suction tips
- Sold individually



CTCT16 Reducer adaptor



## LOW VOLUME SUCTION TIPS

### D FLEX SALIVA EJECTORS

- Mouldable, foldable, disposable
- Non-toxic
- Soft and comfortable for the patient
- Transparent with white tips

Supplied as a packet of 100



SVDIS110 D flex saliva ejectors - transparent with white tips

### MULTI FLEX SALIVA EJECTORS

- A combined disposable saliva ejector and tongue holder that is adjustable and once placed in the mouth will stay in the desired position

Supplied as a packet of 100

SVDIS120 Multi flex saliva ejectors - white



# Suction Products

## SUCTION SYSTEM CLEANERS

### VACUCID 2 SUCTION CLEANER

*Disinfection, deodorisation, cleaning and care of all dental suction systems*

Vacucid® 2 dissolves solid debris, eliminates cleaning or changing of the trap. Daily application dissolves solids and keeps suction lines cleaned, disinfected and free from biofilm build up.

- Aldehyde and foam-free
- Dissolves debris
- 5 litre concentrate makes 250 litres

*Efficacy: Bactericide, Mycobacterium tuberculosis (Tb), Candida albicans, HIV-1, HBV, BVDV*

UNVACUCID Vacucid 2 suction cleaner - 5 litres



### Vacucid Systematic Dosing System

*Dosing system used in conjunction with Vacucid Suction cleaner*



UNIDENT  
SWISS

UN424051 Vacucid Systematic dosing system

### PULI-JET GENTLE SUCTION CLEANER

*Keeps suction lines clean*

Puli-Jet Gentle is suitable for dental suction systems

Puli-Jet Gentle has a simple and accurate dispensing cup, making it easier to measure

- 1 litre bottle makes 30 x 2.5L solutions

CTM060970 Puli-Jet Gentle suction cleaner



### Cattani Pulse Cleaner Bucket

*Used in conjunction with Puli-Jet Gentle*

CT040720 Cattani Pulse Cleaner bucket  
CTC040398 Reducer adaptor for tubings to fit Pulse Cleaner



### ANTIFOAMING DISINFECTANT TABLETS

Simply place a tablet in the primary filter at the beginning of the day - whenever fluids pass through the filter, the tablet releases both disinfecting and antifoaming agents.

- Supplied as a packet of 50 tablets



CTM140825 Antifoaming disinfectant tablets

### CATTANI LUBRI-JET DROPS

*Designed to increase the life of rubber and plastic components in the suction system*



- Recommended for use on o-rings, suction terminals, connections and all rubbing surfaces in the suction system
- Especially suited for lubricating articulations of clamps and scissors before placing them in the autoclave
- Supplied as a 4 x 30ml bottles

CTM040727 Lubri-Jet drops



### SUCTION SYSTEM CLEANING BRUSHES

*Two types available*

#### Coloured bristles

Assorted blue, yellow and white

- Diameter 20mm
- Overall length 200mm with a stronger handle
- Supplied as a packet of 6

DP0868086 Suction brushes - assorted



#### White bristles

- Diameter 4mm
- Overall length 230mm
- Flexible handle
- Supplied as a packet of 12

DP085008 Suction brushes - white



## SUCTION EQUIPMENT

### TURBO SMART SUCTION SYSTEM

- Consistent suction
- High airflow (provides well over 300 L/min per surgery)
- Generates very little heat
- Energy saving
- Compact

CTK\_ Cattani Suction System



### PORTABLE SALIVA EJECTOR

- Great for mobile dentistry or as a backup for sedation dentistry
- Powered by rechargeable battery pack, wall outlet or 12VDC vehicle source
- Battery operating time: Up to 60 minutes on a single charge
- 800cc waste canister with float shut-off
- 2.9kg (6.3lb)
- 22.8 x 17.8 x 20 cm (9" x 7" x 8")

AA20  
Portable saliva ejector



# Surgical Products

## STERILE TUBING COVERS

### SANISLEEVEES

Effective barrier protection for handpieces and hoses

- Latex free
- Disposable drape
- Prevents cross contamination
- Suitable for all exposed cables, cords and hoses
- Individually packaged  
- D60mm x L1650mm
- Supplied as a box of 24



DASANI24 Sanisleeves

### BULK RATE:

Purchase 3 or more boxes and receive a 25% discount

### SALVIN RAPID-ROLL™

Effective barrier protection for handpieces and hoses

- Latex-free
- Compacted sleeve slips over long hoses in seconds without drag
- Individually packaged  
- 65" (165cm) long
- Supplied as a packet of 25



SARAPID Rapid-Roll sterile surgical tubing covers

## STERILE DRAPES

### EYE COVERED DRAPE

- Size 38½" x 55" (97.5 x 139.5cm)
- Sterile
- Packet of 24



SADRAPE33 Eye covered drape

## MOUTH PROPS

### HAMMACHER MOUTH PROPS

- Black, latex-free, rubber mouth props
- Autoclavable to 134°C



Available in three sizes - small, medium and large



HMHSJ16502 Bite block - adult/large  
HMHSJ16401 Bite block - child/medium  
HMHSJ16300 Bite block - child/small

### SALVIN MOUTH PROPS

- Beige, latex-free, silicone mouth props
- Autoclavable to 134°C



Available in child and adult

Each supplied as a set of 2 (same size)

SAMOUTHC Mouth prop child x 2  
SAMOUTHPA Mouth prop adult x 2



## ABSORBENT PRODUCTS

### STERIPOCKETS

Prepackaged pre-sterilised packets of non-woven sponges

- Perfect for use post extraction
- Size 5cm x 5cm
- Supplied as 300 packets of two gauze squares (a total of 600 squares)

RI300408 Steripockets



### SPONGOSTAN

Dental haemostatic sponges

- Cube shaped porcine gelatine sponge designed especially for dental use
- Size 1cm x 1cm x 1cm
- Supplied as a packet of 24

JMMS0005 Spongostan



### SURGICEL ABSORB HAEMOSTAT

The original loose knit structured material that drapes and wraps well

- Proven bactericidal properties in vitro
- Size 1.3 x 5.1cm

JM1906GB Surgicel - packet of 12  
JM1955 Surgicel - packet of 24



### GAUZE ROLL

- Gauze absorbent roll
- 9cm x 100m

MUGAUZE90 Gauze roll



### NON WOVEN GAUZE SQUARES

- 4 ply gauze squares
- Available in two sizes
- Supplied as a packet of 100

INSWAB5 Gauze 5cm x 5cm  
INSWAB7 Gauze 7.5cm x 7.5cm



### THROAT PACK

- Soft, absorbent gauze and cotton wool
- High quality throat pack
- 10 metres long x 7cm wide

CHTHROAT 10 metre roll



### BULK RATE

Purchase 10 or more and receive a 10% discount

# Surgical Products

## SCALPEL BLADES & HANDLES

### STERILE SCALPEL BLADES

- Supplied as a packet of 100



SW118114	Scalpel blade #10
SW118116	Scalpel blade #11
SW118117	Scalpel blade #12
SW11812D	Scalpel blade #12D
SW118118	Scalpel blade #15
SW118115C	Scalpel blade #15C
SW118121	Scalpel blade #22
SW118122	Scalpel blade #23



### STANDARD SCALPEL BLADES

Carbon steel blades for regular scalpel handles

- Extremely sharp
- Sterile and individually wrapped
- Supplied as a packet of 100



SABLAD12B	Scalpel blade #12B
SABLAD15C	Scalpel blade #15C



### DISPOSABLE SCALPEL BLADE AND HANDLE

Single use, disposable

- Supplied as a packet of 10



SW118154	Disposable scalpel handle #11
SW118155	Disposable scalpel handle #12
SW118156	Disposable scalpel handle #15

### SURGICAL HANDLES

Swann Morton stainless steel scalpel blade - no.3 size

- Suitable with blades #10, #11, #12, #15



SW118195	Scalpel handle #3
----------	-------------------



Swann Morton stainless steel scalpel blade - no.4 size

- Suitable with blades #22 and #23



SW118196	Scalpel handle #4
----------	-------------------

### SURGICAL HANDLE - LM-ERGOHOLD 3

- Excellent grip with elastic silicone coating
- Precise blade control
- Controlled rotation
- Blade position responsiveness maintained
- Controlled movement through tissue
- Fits all blade with fitment no.3



LM9003 LM-Ergohold 3 surgical handle

### BENDABLE SURGICAL BLADES

- Bendable to create the surgeon's preferred angle of access
- Uncompromised sharpness and cutting ability
- Blades are sterile and individually wrapped
- Use as straight blade or use needle holder to bend blade to desired angle (up to 45°)



#### Bendable miniature surgical blades

- Supplied as a box of 6

SABLADM69	Mini blade #69 - full radius edge
-----------	--------------------------------------



#### Bendable micro-miniature surgical blades

- Supplied as a box of 6

SABLADM64	Micro blade #64
-----------	-----------------



SABLADNORL	Nordland micro blade #6900 - full radius edge
------------	--



#### Scalpel handle for bendable blades

- Sold individually



SABLADHAND	Scalpel handle for bendable blades
------------	------------------------------------

### SCALPEL BLADE REMOVERS

- Designed to remove surgical blades from no.3 or no.4 handles
- Protects staff against cuts during removal
- Non-sterile

Supplied as a packet of 50

SWSCABLR	Scalpel blade removers
----------	------------------------



Contact **Oraltec** for all your dental supply requirements

Proud to be New Zealand owned and operated







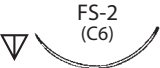

# Surgical Products

## J&J ETHICON SUTURES

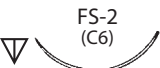



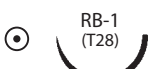





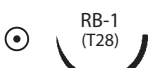





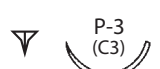

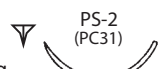
### CHROMIC GUT SUTURES

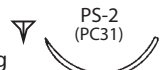
- Resorbs in 7-14 days
- Natural resorbable gut

JM635H	Chromic gut - box of 36 Size 4/0, 19mm, L70cm, chromic 3/8 circle reverse cutting	 
JM636H	Chromic gut - box of 36 Size 3/0, 19mm, L70cm, chromic 3/8 circle reverse cutting	 
JM752G	Chromic gut - box of 12 Size 4/0, 13mm, L30cm, chromic 3/8 circle reverse cutting	 
JMU203H	Chromic gut - box of 36 Size 4/0, 17mm, L70cm, chromic 1/2 circle taper point	 

### COATED VICRYL RAPIDE® SUTURES



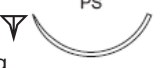









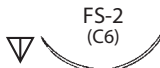

- Resorbs in 7-14 days
- Polyglactin 910 braided sutures

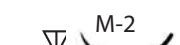
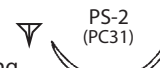
JMVR214	Vicryl Rapide® suture - box of 12 Size 4/0, 17mm, L70cm, undyed 1/2 circle taper point	 
JMVR416	Vicryl Rapide® suture - box of 12 Size 3/0, 26mm, L70cm, undyed 1/2 circle taper point	 
JMVR493	Vicryl Rapide® suture - box of 12 Size 5/0, 13mm, L45cm, undyed 3/8 circle precision point reverse cutting	 
JMVR494	Vicryl Rapide® suture - box of 12 Size 4/0, 13mm, L45cm, undyed 3/8 circle precision point reverse cutting	 
JMVR496	Vicryl Rapide® suture - box of 12 Size 4/0, 19mm, L75cm, undyed 3/8 circle precision point reverse cutting	 
JMVR497	Vicryl Rapide® suture - box of 12 Size 3/0, 19mm, L70cm, undyed 3/8 circle precision point reverse cutting	 
JMW9922	Vicryl Rapide® suture - box of 12 Size 4/0, 19mm, L45cm, undyed 3/8 circle precision point reverse cutting	 
JMW9923	Vicryl Rapide® suture - box of 12 Size 3/0, 19mm, L45cm, undyed 3/8 circle precision point reverse cutting	 
JMW9927	Vicryl Rapide® suture - box of 12 Size 3/0, 22mm, L45cm, undyed 1/2 circle conventional cutting P needle	 
JMW9932	Vicryl Rapide® suture - box of 12 Size 3/0, 26mm, L75cm, undyed 3/8 circle precision point reverse cutting	 

### COATED VICRYL® SUTURES

- Resorbs in 21-28 days
- Polyglactin 910 braided sutures











JMJ422H	Vicryl suture - box of 36 Size 4/0, 19mm, L70cm, undyed 3/8 circle reverse cutting	 
JMJ423H	Vicryl suture - box of 36 Size 3/0, 19mm, L70cm, undyed 3/8 circle reverse cutting	 
JMJ493G	Vicryl suture - box of 12 Size 5/0, 13mm, L45cm, undyed 3/8 circle precision point reverse cutting	 
JMJ494G	Vicryl suture - box of 12 Size 4/0, 13mm, L45cm, undyed 3/8 circle precision point reverse cutting	 
JMJ497H	Vicryl suture - box of 36 Size 3/0, 19mm, L45cm, undyed 3/8 circle precision point reverse cutting	 
JMJ824G	Vicryl suture - box of 12 Size 3/0, 19mm, L45cm, undyed 3/8 circle conventional cutting prime	 
JMW9505T	Vicryl suture - box of 24 Size 5/0, 16mm, L45cm, undyed 3/8 circle conventional cutting prime	 
JMW9506T	Vicryl suture - box of 24 Size 4/0, 16mm, L45cm, undyed 3/8 circle conventional cutting prime	 
JMW9515T	Vicryl suture - box of 24 Size 4/0, 19mm, L45cm, undyed 3/8 circle precision point reverse cutting	 

## SALVIN SURGIPOINT SUTURES

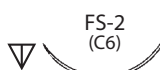
### CHROMIC GUT SUTURES

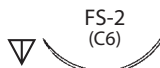
- Resorbs in 7-14 days
- Natural resorbable gut



SAL560B	Chromic gut L-560B - box of 12 Size 3/0, L27" (68cm) 3/8 circle reverse cutting	 
SAL525B	Chromic gut L-525B - box of 12 Size 3/0, L18" (45cm) 3/8 circle reverse cutting	 
SAL558B	Chromic gut L-558B - box of 12 Size 4/0, L18" (45cm) 3/8 circle reverse cutting	 
SAL1248B	Chromic gut L-1248B - box of 12 Size 5/0, L18" (45cm), 3/8 circle premium reverse cutting	 
SAL590B	Chromic gut L-590B - box of 12 Size 5/0, L14" (35cm), 1/2 circle taper point (for connective tissue grafts)	 

# Surgical Products

## PLAIN GUT SUTURES

- Resorbs in 5-10 days
- Natural resorbable gut

SAL554B	Gut-plain L-554B - box of 12 Size 3/0, L27" (68cm) 3/8 circle reverse cutting
SAL591B	Gut-plain L-591B - box of 12 Size 4/0, L18" (45cm) 3/8 circle reverse cutting
SAL592B	Gut-plain L-592B - box of 12 Size 3/0, L18" (45cm) 3/8 circle reverse cutting

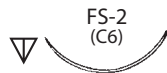

## FAST ABSORBING PGA POLYGLYCOLIC ACID SUTURES

- Resorbs in 7-14 days
- PGA polyglycolin acid synthetic absorbable-braided fast absorbing
- Great tensile strength
- Unique PolyGlide coating for smooth no-drag passage through tissue

SAL493N	PGA LVFA-493N - box of 12 Size 3/0, L18" (45cm), undyed 3/8 circle reverse cutting
SAL492N	PGA LVFA-492N - box of 12 Size 4/0, L18" (45cm), undyed 3/8 circle reverse cutting
SAL422N	PGA LVFA-422N - box of 12 Size 4/0, L30" (76cm), undyed 3/8 circle reverse cutting
SAL442N	PGA LVFA-442N - box of 12 Size 3/0, L30" (76cm), undyed 3/8 circle reverse cutting



## PGA POLYGLYCOLIC ACID SUTURES

- Resorbs in 21-28 days
- Synthetic absorbable, braided coated polyglycolic acid
- Great tensile strength
- Unique polyguide coating for smooth no-drag suture passage through tissue

SALV423B	PGA LV-423B - box of 12 Size 3/0, L30" (76cm), undyed 3/8 circle reverse cutting
SALV422B	PGA LV-422B - box of 12 Size 4/0, L30" (76cm), undyed 3/8 circle reverse cutting
SALV497B	PGA LV-497B - box of 12 Size 3/0, L18" (45cm), undyed 3/8 circle premium reverse cut
SALV496B	PGA LV-496B - box of 12 Size 4/0, L18" (45cm), undyed 3/8 circle premium reverse cut

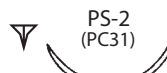
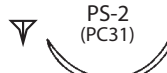

## UNIK SILK SUTURES

### SILK SUTURES

- Made from fine quality degummed silk
- Reverse cutting needle tip
- Supplied as a packet of 24

UIISC193	Silk 3/0 - 19mm, 3/8 needle
UIISC194	Silk 4/0 - 19mm, 3/8 needle
UIISC203	Silk 3/0 - 20mm, 1/2 needle



## RETRACTORS

### LARIDENT CHEEK RETRACTORS

- Child or adult sizes
- Available joined or separate
- Supplied as a pair



#### Single

LACHEEKA8	Cheek retractor - adult
LACHEEKA9	Cheek retractor - child



#### Joined

LACHEEKA2	Cheek retractor - adult
LACHEEKA3	Cheek retractor - child



### DP CHEEK AND LIP RETRACTORS

- Child or adult size
- Available joined or separate
- Autoclavable to 121°C
- Supplied in packets of 2



#### Single

DP5003A	Cheek retractor - adult
DP5003E	Cheek retractor - child



#### Joined

DP5004A	Cheek retractor - adult
DP5004E	Cheek retractor - child



### LIP RETRACTOR



HMHSF09412	Lip retractor Sternberg, 120mm
------------	--------------------------------

### MINNESOTA RETRACTORS



SAMINN	Minnesota retractor
--------	---------------------



HMHSF09114	Minnesota retractor, 140mm
------------	----------------------------

### LASTER 3RD MOLAR RETRACTOR



SALASTERR	Laster 3rd molar retractor
-----------	----------------------------

### IMPLANT RETRACTOR

*With ergonomic handle*

- Vestibular retractor



SAIMPLANTRE	Implant retractor with ergonomic handle
-------------	---

### SALVIN AUSTIN RETRACTOR

SAAUSTINR	Salvin Austin retractor
-----------	-------------------------



# Surgical Products

## ARTERY & TISSUE FORCEPS



SAMOSQCURV Mosquito haemostat forceps, curved, 127mm



HMHSC08712 Dressing forceps, curved, 120mm



HMHSC20011 Tissue forceps, straight, 115mm



HMHSC20414 Tissue forceps, straight, 145mm



HMHSC20616 Tissue forceps, straight, 160mm



HMHSE02212 Artery forceps, Halsted-Mosquito, straight, 120mm



HMHSE02312 Artery forceps, Halsted-Mosquito, curved, 120mm



HMHSE02414 Artery forceps, Halsted, straight, 140mm



HMHSE02514 Artery forceps, Halsted-Mosquito, curved, 140mm



HMHSE02812 Forceps, Mosquito, straight, 120mm



HMHSE02912 Forceps, Mosquito, curved, 120mm

## NEEDLE HOLDERS



HMHSD07113 Halsey, serrated, 135mm



HMHSD08415 Crile-Wood, 150mm



HMHSD23715 Baby Crile-Wood, 150mm with tungsten-carbide inserts



## METAL DISHES

### KIDNEY DISHES



HMHW08300 Kidney dish, small - 170 x 100 x 35 mm

HMHW08400 Kidney dish, medium - 250 x 140 x 40 mm

HMHW08500 Kidney dish, large - 275 x 150 x 45 mm

# Surgical Products

## SCISSORS



Straight

HMHSB01010  
HMHSB01110

Gum scissors, straight, 105mm, sharp  
Gum scissors, curved, 105mm, sharp



Curved



Straight

HMHSB30011  
HMHSB30111

Gold gum scissors, carbide, straight, 115mm  
Gold gum scissors, carbide, curved, 115mm



Curved



Straight

HMHSB39010  
HMHSB39110

Gum scissors, super cut, straight, 105mm  
Gum scissors, super cut, curved, 105mm



Curved

HMHSB08411

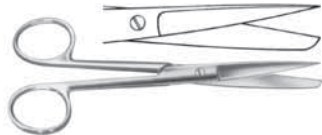

HMHSB08411  
HMHSB08613

Scissors, straight, sharp-blunt, 115mm  
Scissors, straight, sharp-blunt, 130mm



HMHSB12114

Scissors, baby-Metzenbaum, curved, delicate,  
blunt-blunt, 145mm



HMHSB31714

Scissors, Metzenbaum, fine, curved, delicate,  
sharp-sharp, tungsten carbide inserts, 145mm



HMHSB10013

Scissors, straight, 130mm



HMHSB28312

Suture scissors, curved, 125mm

## TWEEZERS



LATWEEZER

Larident college tweezers, 15cm



IT1001A

Intensiv college tweezers, diamond inside



RENTDF68

NiTIn band placement forceps/tweezers



HMHSC07514

Hammacher dressing tweezers, curved, 145mm



HMHSC24315

Hammacher Gillies tweezers, 150mm



HMHSC03115

Hammacher tweezers with ratchet, 155mm

## PERIOTOMES & PERIOSTEAL ELEVATORS



HMHSK38001

Periotome 170mm, 1.8mm



HMHSK38102

Periotome 170mm, 2.5mm



HMHSK38203

Periotome 170mm, 1.8mm - 2.5mm



HMHSK00803

Periosteal elevator Pritchard 210mm



HMHSK01108

Periotome Periosteal Elevator Molt 8, 180mm



HMHSK01109

Periotome Periosteal Elevator Molt 9, 190mm

Hammacher  
Instrumente



# Karl Hammacher GmbH

## Instruments for Professionals

Karl Hammacher is a family business that have been making instruments for professionals for more than 90 years.

Based in Solingen, Germany, they produce high quality products made from stainless steel and Wironit which are distributed worldwide.

Their product range includes precision instruments for dentists, dental technicians, orthodontists and hospitals.



Ask for your copy of the latest dental, orthodontic or laboratory catalogue

# Surgical Products

## ANAESTHETIC SYRINGES

### ASPIRATING SYRINGE

- USA thread
- Ring type



HMHSA84218 Aspirating syringe 1.8ml  
HMHSA84322 Aspirating syringe 2.2ml



### SELF ASPIRATING SYRINGE

- USA thread
- Bar type



HMHSA83218 Self aspirating syringe 1.8ml

### INTRALIGAMENTARY SYRINGE

- Positive pressure design creates extra leverage without fatigue
- One complete trigger squeeze delivers 0.2cc
- Uses standard carpules



SAINTRALIG Intraligamentary syringe

## NEEDLES

### 30 GAUGE NEEDLES

- Supplied as a box of 100 needles
- Available in short and extra short
- Made in Japan



HA30S Needles, red, 30 gauge x 25mm, short  
HA30XS Needles, white, 30 gauge x 12mm, extra short

## SURGICAL ASPIRATORS

### METAL SURGICAL ASPIRATORS

- Sold individually



SA15P1A Surgical aspirator, metal - 1.5mm tip



SA15P3A Surgical aspirator, metal - 3mm tip



SA16RSA Surgical aspirator, metal - 4mm tip



### SILICONE TIP ASPIRATOR KIT

- Autoclavable silicone tips prevent metal contact with implant
- Tips are easily modified with scissors or knife



SA46YST Silicone tip aspirator kit includes stainless steel aspirator and 1 trimmable silicone tip

## OTHER SURGICAL INSTRUMENTS

### BOWDLER HENRY RAKE



SABOWDLER Bowdler Henry Rake



### GINGIVECTOMY KNIVES



HMHSG26200 Gingivectomy knife Kirkland 15/16 DE



HMHSG26800 Gingivectomy knife Orban Fig 1/2



HMHSG05100 Mitchells Osteo trimmer



HMHSK05202 Surgical curette raspatory Miller-Colburn, fig 2, 170mm



HMHSK08404 Bone file Miller-Colburn, fig 4, 180mm



Contact **Oraltec** for all your dental supply requirements

Proud to be New Zealand owned and operated



# Surgical Products

## SURGICAL BURS

### PIKOS SCORING BUR

- #8 round scoring bur
- Depth marked at 15mm
- Fits straight handpieces
- 44mm long



SAPIKOSSC Pikos scoring bur

### PIKOS OSTEOTOMY BURS

- Fits straight handpieces
- 44mm long

SAPIKOSBURS

Pikos Osteotomy bur 702-L



SAPIKOSBURL

Pikos Osteotomy bur 703-L



### LINDEMANN SIDE CUTTING BUR HP

- Fits straight handpieces
- 44mm long



SALINDMHP Lindemann side cutting bur HP

## TREPHINE DRILLS

*For failed implant retrieval and bone harvesting*

- 3.5mm inside diameter (4.5mm outside) x 22mm barrel
- 4.25mm inside diameter (5mm outside) x 22mm barrel

SATREPH35 Trephine drill 3.5mm



SATREPH4 Trephine drill 4.25mm



## BONE GRAFTING

### OSSEOUS COLLECTION TRAP

*Simplify bone harvesting with the Osseous trap*



- Use in line with your suction
- Osseous material is collected directly into a filter
- Autoclavable
- Fits regular high volume suction as well as silicone or latex surgical suction tubing



SAOCT

Osseous collection trap includes 3 single use filters

SAOCTFILT

Set of 3 replacement single use filters  
- supplied non-sterile  
- autoclave before using



## SALVIN TORQUE DRIVER

- Right angle torque wrench adjustable from 10 to 35 ncm
- Excellent ergonomics with great access in difficult to reach areas
- Rotation easily torques or loosens screws
- Seven torque settings - 10, 15, 20, 25, 30, 32 and 35 norm



SAACCESST

Access torque RA torque driver

**Everything For Your Implant Practice But The Implants®**  
2017 Catalog | 800-535-6566 | www.salvin.com



**Everything for your implant practice but the implants®**

To view the extensive product range from Salvin, please ask for your copy of the latest catalogue



# Surgical Products

## LUXATING INSTRUMENTS

### LM-LIFTOUT INSTRUMENTS (with fixus cassette)

*Luxating instruments for atraumatic extraction*

LM-LiftOut instruments allow tooth extraction to be done as atraumatically as possible. This is important in order to enable rapid healing and future implant placement. The thin tip of the instrument is introduced into the periodontal space and slowly advanced toward the apex of the root.

**LM-LiftOut is not suitable for use as an elevator.**



LM812220 LM-LiftOut S2 - straight 2.5mm



LM812230 LM-LiftOut S3 - straight 3mm



LM812240 LM-LiftOut S4 - straight 4mm



LM812250 LM-LiftOut S5 - straight 5mm



LM812430 LM-LiftOut C3 - curved 3mm



LM812440 LM-LiftOut C4 - curved 4mm



LM812450 LM-LiftOut C5 - curved 5mm



### LM-SLIMLIFT INSTRUMENTS (with fixus cassette)

*Luxating instruments designed for extremely narrow places*

LM-SlimLift instruments are especially slim and are designed to reach narrower places than traditional luxating instruments. It allows tooth extraction to be done as atraumatically as possible. This is important in order to enable rapid healing. The instrument is narrower than the LM-LiftOut. The instrument is slowly advanced towards the apex of the root while turning the instrument gently back and forth.

**LM-SlimLift is not suitable for use as an elevator.**



LM812630 LM-SlimLift S3 - straight 3mm



LM812640 LM-SlimLift S4 - straight 4mm



LM812650 LM-SlimLift S5 - straight 5mm



LM812830 LM-SlimLift C3 - curved 3mm



LM812840 LM-SlimLift C4 - curved 4mm



LM812850 LM-SlimLift C5 - curved 5mm

### LM-ROOTOUT (with fixus cassette)

- 1mm wide tip
- Designed for delicate root teasing procedures
- Not recommended for more substantial root tip removal
- Ergonomically designed handle for a good grip



LM812210X LM-RootOut



# Surgical Products

## ELEVATING INSTRUMENTS

### LM-TWISTOUT INSTRUMENTS (with fixus cassette)

*Elevators for more forceful extraction*

LM-TwistOut instruments are suitable for tooth extraction in situations where torque is needed and leverage is applied.



LM814230 LM-TwistOut S3 - straight 3mm



LM814240 LM-TwistOut S4 - straight 4mm



LM814250 LM-TwistOut S5 - straight 5mm



LM814430 LM-TwistOut C3 - curved 3mm



LM814440 LM-TwistOut C4 - curved 4mm



LM814450 LM-TwistOut C5 - curved 5mm

Contact **Oraltec** for all your dental supply requirements

Proud to be New Zealand owned and operated 

## ROOT ELEVATORS

### HAMMACHER ROOT ELEVATORS



HMHSA64727 Root elevator Cryer left 27



HMHSA64728 Root elevator Cryer right 28

## ROOT TIP PICK

### LM ROOT TIP PICK

*For the removal of root tip pieces*



LM769771\_ Root tip pick  
*Suits well in all difficult to reach areas*

## EXTRACTION INSTRUMENT MAINTENANCE

### LM FIXUS CASSETTE

LM-LiftOut and LM-TwistOut instruments are supplied in a convenient cassette that protects both the instrument and the handler during the maintenance cycle.

The cassette keeps the instrument from puncturing the sterilisation pouch, so sterility is more likely to be assured.

- The cassette can be colour-coded
- The cassette is compatible with LM-ServoMax tray



### LM Sharpening Stone

Sharpen the extractors occasionally using the round sharpening stone as a simple and quick way to keep them in top condition and always ready to use

- Suitable for LM-SlimLift, LM-LiftOut, LM-TwistOut and LM-RootOut instruments



LM818002 LM sharpening stone

To view the complete range of LM INSTRUMENTS, please ask for a copy of the latest LM catalogue



# Surgical Products

## HAMMACHER EXTRACTION FORCEPS

- With teflon disc in the lock for easy and smooth opening and closing
- English pattern with non-slip jaws
- Made in Germany



### EXTRACTION FORCEPS FOR ADULTS



HMHSA10001  
Upper central 1

HMHSA10102  
Upper canine 2



HMHSA10207  
Upper bicuspid 7



HMHSA11113  
Lower premolar 13



HMHSA10317  
Upper molar right 17



HMHSA10418  
Upper molar left 18



HMHSA11322  
Lower molar 22



HMHSA11433  
Lower root 33



HMHSA11533  
Lower roots 33A



HMHSA10551  
Upper root 51



HMHSA10651  
Upper root 51A



HMHSA10767  
Upper wisdom 67

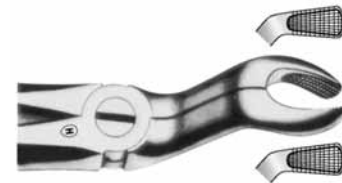

HMHSA11673  
Lower molar 73



HMHSA11774  
Lower roots 74



HMHSA12079  
Lower wisdom 79



# Surgical Products

## EXTRACTION FORCEPS FOR CHILDREN



HMHSA33122  
Child lower molars 22S



HMHSA32029  
Child upper root 29S



HMHSA32130  
Child upper bicuspid  
and roots 30S



HMHSA32237  
Child upper centrals  
and canines 37S



HMHSA32339  
Child upper molar 39S



HMHSA32439  
Child upper molar 39A



HMHSA32639  
Child upper molar left 39L



HMHSA32539  
Child upper molar right 39R



HMHSA583161  
Child lower molars 161

**Hammacher**  
Instrumente

## MINIATURE EXTRACTION FORCEPS FOR CHILDREN

- Arquatus, coloured forceps for children

**Hammacher**  
Instrumente



HMHSA35001  
Upper incisors



HMHSA35405  
Lower incisor



HMHSA35203  
Upper molar



HMHSA35506  
Lower molar



HMHSA35304  
Upper root



HMHSA35607  
Lower root



HMHSA35102  
Upper premolar

# Surgical Products

## PIEZO BONE SURGERY SYSTEM

### VARIOSURG 3 ULTRASONIC SYSTEM

#### Features

- Super-slim, lightweight, ergonomic VarioSurg3 handpiece with LED illumination
- A variety of tips makes procedures easier and stress-free to help provide more precise and efficient treatment
- The control unit has a compact body and large LCD panel and has a choice of three modes: P (perio), E (endo) and S (surg) to cover a wide range of applications, from bone cutting to post-surgical maintenance
- Hands-free programme adjustments via foot control

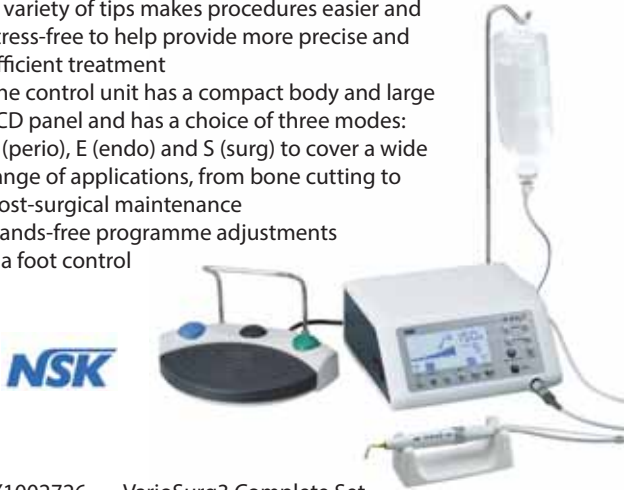

NKY1002726 VarioSurg3 Complete Set (Model VarioSurg3)

*Includes control unit, LED handpiece with 2m cord, FC-78 foot control, sterilisation cassette, handpiece stand, irrigation tube (5 pieces) and other accessories, basic H-S kit (H-SG1, SG3, SG5, SG6D, SG7D, SG11 {as shown below} and tip holder)*

### ULTRASONIC SURGERY TIPS

- With TIN coating
- For VarioSurg unit

#### Bone Surgery

Model SG1

Code NKZ305101

- Dots mark 3, 6 and 9mm from top of tip
- Five teeth; 0.6mm thick



#### Scraper

Model SG3

Code NKZ305104

- Triple sided edge spatula tip



Model SG5

Code NKZ305106

- Rounded edge spatula tip



#### Sinus Lift (diamond coating)

Model SG6D

Code NKZ305107



Model SG7D

Code NKZ305108



#### Sinus Membrane Detachment

Model SG11

Code NKZ305112

- Cone compressor



### Complete range of ultrasonic surgery tips

*Choose from over 50 ultrasonic tips according to the clinical procedure:*

- Bone surgery
- Endodontics
- Extraction
- Implant preparation
- Maintenance (V-tip)
- Perio (root planing)
- Scaling
- Scraper
- Sinus lift
- Sinus membrane detachment
- Socket lift tips (Crestal approach)

*Please ask about the complete range of VarioSurg ultrasonic tips*



## SURGICAL MOTOR & HANDPIECES

### SURGIC PRO+ CONTROL UNIT

#### Features

- Control unit incorporating an array of sophisticated functions
- Compact body and large LCD display
- Advanced and extremely quiet irrigation pump
- Memorises 8 different implant systems, a total of 64 programmes (parameters are gear ratio, speed, rotation direction, torque limit, coolant solution volume and illumination intensity)
- Data log function (can record and store speed, torque values and other patient treatment data)
- Easily accessed and downloaded data management
- Easy treatment data handling - no specific software required



NKY10002096 Surgic Pro+ complete set (with data storage facility) with X-DSG20L optic handpiece

*Includes control unit with data storage facility, SGL70M LED micromotor, FC-78 foot control, X-DSG20L optic handpiece (20:1 reduction), irrigation tube (5 pieces) and other accessories*

### SURGIC PRO SURGICAL MOTOR

#### Features

- Shorter (16.2mm), lighter (42g) and more powerful consistently excellent clinical performance
- An advanced surgical motor for demanding clinical environments
- LED light for high visibility with up to 80Ncm of torque for diverse surgical procedures

#### Optic

Model SGL70M

Code NKNKE1023



#### Non-Optic

Model SG70M

Code NKNKE1025



- Solid titanium body • with cord (2m)



# Surgical Products

## SURGICAL HANDPIECES

### DISMANTABLE CONTRA-ANGLE HANDPIECES

Handling up to 80Ncm of torque

- The Ti-Max DSG20 contra-angle series can be disassembled with a simple twist for easy internal cleaning
- NSK's unique locking mechanism prevents accidental disassembly during operation
- NSK's unique double sealing system prevents blood and other contaminants from entering the instrument head to ensure longevity of the instruments

#### Ti-Max X-DSG20L



**Optic** Model X-DSG20L Code NKC1068  
**Non-Optic** Model X-DSG20 Code NKC1067

- 20:1 Reduction · Titanium body with scratch resistant DURACOAT
- Cellular glass optics · Push button chuck
- External and internal cooling (Kirshner and Meyer)
- Double sealing system · Max torque 80Ncm · Max speed 2,000 min

### Implant Handpieces

#### Ti-Max X-SG20L



Double water injection

Double water injection maximises the cooling effect. External and internal cooling (Kirshner and Meyer) ensures that water is continuously delivered to the treatment area, as required. Both injection nozzles are fully autoclavable.



**Optic** Model X-SG20L Code NKC1003

- 20:1 Reduction · Titanium body with scratch resistant DURACOAT
- Cellular glass optics · Push button chuck
- External and internal cooling (Kirshner and Meyer)
- Double sealing system · Max torque 80Ncm · Max speed 2,000 min

#### S-Max SG20



**Non-Optic** Model SG20 Code NKC1010

- 20:1 Reduction · Stainless steel body · Push button chuck
- External and internal cooling (Kirshner and Meyer)
- Double sealing system · Max torque 80Ncm · Max speed 2,000 min

#### Ti-Max X-SG93L



Triple spray



**Optic** Model X-SG93L Code NKC1004  
**Non-Optic** Model X-SG93 Code NKC1007

- 1:3 Increasing · Titanium body with scratch resistant DURACOAT
- For FG burs (ø 1.6) · Cellular glass optics (X-SG93L)
- Clean head system · Push button chuck · External cooling
- Max speed 120,000 min

#### Ti-Max X-SG25L



**Optic** Model X-SG25L Code NKC1011

- 1:1 Direct Drive · Titanium body with scratch resistant DURACOAT
- For CA burs (ø 2.35) · Cellular glass optics · Clean head system
- Push button chuck · External cooling · Max speed 40,000 min

#### Ti-Max X-SG65L

##### Straight handpiece



**Optic** Model X-SG65L Code NKH1009  
**Non-Optic** Model X-SG65 Code NKH1038

- 1:1 Direct Drive · Titanium body with scratch resistant DURACOAT
- For HP burs (ø 2.35) · Cellular glass optics (X-SG65L)
- Clean head system · Push button chuck · External cooling
- Max speed 40,000 min

#### Ti-Max Z-SG45L



**Optic** Model X-SG45L Code NKC1107  
**Non-Optic** Model X-SG45 Code NKC1108

- 1:3 Increasing · Titanium body with scratch resistant DURAGRIP
- Cellular glass optics (Z-SG45L) · Ceramic bearings
- Clean head system · Push button chuck · External cooling
- For FG burs (ø 1.6 / 20-25 mm)
- Anti heat system · DLC coating · Max speed 120,000 min

To view the complete range of NSK handpieces, please ask for a copy of the latest NSK catalogue





## Pala Mix & Match

The freedom to combine aesthetic and functionality at your will.

- » Includes our tooth lines Pala Premium, Pala Idealis, Pala Mondial and PalaVeneer
- » Perfectly harmonized denture tooth combination system
- » More flexibility for individual and professional results

Giving a hand to oral health.



**KULZER**  
MITSUI CHEMICALS GROUP

# Teeth

## KULZER PALA TEETH

### PALA MIX & MATCH COMBINATION PRINCIPLE

*A perfectly harmonised denture tooth combination system around Pala Idealis, Pala Premium and Pala Mondial*

Pala Mix & Match principle allows you to unite all Pala Mix & Match denture teeth to get individual, professional results. The Pala Idealis posterior denture tooth gives you more combination possibilities for Pala denture teeth. You can cater for individual requirements with considerably more flexibility and even better provide patients with precision dentures. Combining CAD CAM technology and the INCOMP procedure maintains exemplary form and functional accuracy.

- Highest flexibility for the fabrication of individualized prosthetics
- For all indications
- Reliable, true to life colour, form and function
- Particularly resistant to fracture, abrasion and plaque thanks to NanoPearls® technology

The Mix & Match tooth lines in detail:



#### Pala Premium

The Pala Premium tooth line with its fully anatomical morphology and its natural light dynamic yields very high aesthetic results, particularly for removable and fixed dentures.

#### Pala Idealis

The Pala Idealis posterior tooth line with its naturally reduced cusps is ideal for implants and prostheses for the elderly.

#### Pala Mondial

The Pala Mondial tooth line with its wide range of shapes offers a high degree of flexibility in all areas of removable prosthetics.

#### PalaVeneer

The PalaVeneer veneer system based on Pala Premium and Pala Idealis rounds off the product range of the Pala brand perfectly.

### PALA PREMIUM 6 AND PREMIUM 8 TEETH

*Highly aesthetic teeth for the highest demands*

Pala Premium is Kulzer's tooth line for the highest demands for aesthetics, function and natural appearance. With its fully anatomical morphology and its natural light dynamic, it yields very high quality results, particularly for removable and fixed dentures, and thus facilitates effective integration to the residual dentition.

The Pala Premium tooth line includes Premium 6 for anterior teeth and Premium 8 for posterior teeth.

- Maximum aesthetics with natural appearance of tooth shapes
- Individual set up without compromise
- High abrasion and natural opalescence is guaranteed with the NanoPearls® dental material
- Multifunctional in any setup concept as well as for eugnathic and disgnathic jaw relationships ensure more flexibility for the dental technician
- Absolutely lifelike: True to nature moulds identical to natural teeth
- Hardly distinguishable from residual dentition
- Widened base and increased volume for improved papillae contouring
- Labial twist for improved morphology



#### Shades and Moulds

- **Premium 6** - 16 shades (A1-D4), 2 shades bleach (BL2-BL3), 22 moulds (14 upper anterior, 8 lower anterior)
- **Premium 8** - 16 shades (A1-D4), 2 shades bleach (BL2-BL3), 8 moulds (4 upper posterior, 8 lower posterior)



### PALA IDEALIS 8 TEETH

*Posterior teeth with reduced cusp angles for implant-borne prosthetics and prostheses for the elderly*

The Pala Idealis posterior tooth with its wide tooth neck and high volume is the ideal solution for implants and tertiary structures. The large proximal areas provide a very good interdental closure and make oral care simple for the patient. The patient also benefits from the very high comfort resulting from reduced initial abrasion. Pala Idealis posterior teeth can be combined with both Pala Mondial and Pala Premium anterior teeth as required.

- Reduced shear forces for healthy and comfortable function
- Basal expansion for aesthetic gingival shaping
- Ideal soft tissue support with cheek supporting contour
- Optimal covering of tertiary and implant structures through wide cervical areas and high volume
- High abrasion and fracture resistance with NanoPearls® technology

#### Shades and Moulds

- 16 shades (A1-D4), 2 shades bleach (BL2-BL3), 8 moulds (4 upper posterior, 4 lower posterior)



### PALA MONDIAL 6 AND MONDIAL 8 TEETH

*Proven function that caters for all demands*

The Pala Mondial tooth line with its wide range of shapes offers a high degree of flexibility in all areas of removable prosthetics. The universal tooth line has proven its worth in all areas of modern removable prosthetics. The precisely defined centric makes set up safe and easy. Pala Mondial teeth require virtually no grinding to ensure precise function for every tooth.

- Fast and easy set up
- Precisely defined centric means simplified set up
- Precise function without time consuming spot grinding
- NanoPearls® guarantees high abrasion resistance and durability
- Lifelike and vivid surface structures match the basis tooth form and appear harmonious
- Widened tooth base and increased volume aid papillae contouring and eliminate dark recesses and vertical edges

#### Shades and Moulds

- **Mondial 6** - 16 shades (A1-D4), 2 bleach shades (BL2-BL3), 36 moulds (18 upper anterior, 10 lower anterior, 6 upper anterior, 2 lower anterior)
- **Mondial 8** - 16 shades (A1-D4), 2 bleach shades (BL2-BL3), 10 moulds (5 upper posterior, 5 lower posterior)



All PALA products are biocompatible and certificates are available

# Teeth

## PALAVENEER 6 AND PALAVENEER 8 TEETH

*The PalaVeneer veneer system based on Pala Premium and Pala Idealis rounds off the product range of the Pala brand from Kulzer*

Thanks to the modular structure of Pala tooth lines, it is possible to combine full-contour teeth and veneer shells in the Pala Mix & Match concept.

The thin multi-layered PalaVeneer veneer shells gives the maximum attainable overall aesthetic, even when space is limited or in functionally difficult cases. This makes it possible for the technician to achieve highly aesthetic, Premium identical layering in the anterior region. Despite the very thinly shaped veneers, the shells alone achieve a shade very close to the desired target shade. The extended cervical area offers the best covering for implants and tertiary structures.

- The maximum attainable overall aesthetic in limited space and functionally difficult cases
- Thin shells, reduced fissure depth and an extended cervical area
- Able to be combined with all Pala tooth lines and PalaVeneer veneer shells in the Pala Mix & Match concept
- Absolute trueness to shade, form and function
- Tooth material with NanoPearls® for the highest abrasion stability and fracture resistance



### Shades and Moulds

- PalaVeneer 6 - 16 shades (A1-D4), 12 moulds (9 upper anterior, 3 lower anterior)
- PalaVeneer 8 - 16 shades (A1-D4), 6 moulds (3 upper anterior, 3 lower posterior)



## OPTOSTAR TEETH

*4 layered anterior teeth*



The wide range of shades and moulds available with these anatomically shaped teeth permits perfect adaptation to existing dentition or in the situation where complete dentures are indicated. The special layer of the Optostar ensures that the teeth look natural under any light.

### Shades and Moulds

- 16 shades (A1-D4), 35 moulds (23 upper anterior, 12 lower anterior)



## WRIGHTS SENATOR TEETH

### SENATOR TEETH

*Three layered anterior teeth*

- Functional and easily set up
- Suitable for most clinical cases

### Shades and Moulds

- 12 Vita shades
- 11 upper and 6 lower anterior moulds
- 6 upper and 6 lower posterior moulds



## WRIGHTS MONARCH TEETH

### MONARCH TEETH

*Four layered anterior teeth*

Monarch are carefully constructed in multiple layers using the latest biocompatible polymers. Not only does this give the teeth terrific strength and wear resistance, it also gives them optical characteristics which reflect those found in nature.

By incorporating multi cross-linked technology with both inorganic fillers and monomer resin based Bis GMA, Wrights Healthcare (of Scotland) have developed a sophisticated double-crosslinked polymer system which results in a tooth that demonstrates the following physical properties:

- Improved colour stability
- Plaque adhesion resistance
- Enhanced toughness and reduced chipping
- Greater abrasion resistance and hardness
- Guaranteed bonding to all acrylic denture bases



### Terms and conditions of guarantee

Monarch teeth are manufactured using only materials of the highest quality. Wright Health Group back this up with a **5-year guarantee** that covers denture teeth against excessive wear and tear from the date the denture was first fitted.

### Shades

- 15 shades compatible with Vita



## GEBDI TRIBOS 501 TEETH

### TRIBOS 501 TEETH

*Perfect portrait where shape, function and aesthetics are taken from nature*



Gebdi is an innovative German company (sister company to Yeti Dental) who manufacture products for acrylic dental laboratories throughout the world. Gebdi's Tribos 501 teeth are manufactured in Germany and the teeth morphology is derived from the theory "natural and functional prosthesis" which is the result of 3 years of morphology study, competence and experience of Dieter Schultz.

Tribos 501 are high quality teeth developed in diagonal grid PMMA structure, produced in a new condensation method "Mega-Press-Inject" to optimise the density and hardness of the tooth surface. This production in 3 layers affords the same quality performance in all areas of the tooth. This impacts especially on the durability and plaque sensitivity of a prosthesis.

- Brilliant natural layering
- Good incisal seam
- Imitation of opacity effects
- Age-typical silky structure of surface

### Shades

- 16 Vita shades



# Thermofforming Products

## THERMOFORMING EQUIPMENT

### MINISTAR® S

*Innovative pressure moulding technique for dental practice and laboratories*

- 4-bar working pressure
- Reaches working temperature in just 1 second
- Patented thermostatic heater control
- Featuring scanning technology
- Ergonomic pellet container
- Acoustic and optical user guidance
- Clearly structured display
- Surrounding channel for excess pellets



SC3500 Ministar Thermoforming Machine

### BIOSTAR®

*Top performance in all pressure moulding applications in dental practice and laboratories*

- 6 bar working pressure
- Reaches working temperature in just 1 second
- Patented thermostatic heater control
- Featuring scanning technology
- Ergonomic pellet container
- Coloured 3.2" LCD display
- Acoustic and optical user guidance
- Data bank with information on scanned material and indications
- Illustrated application hints and animated videos
- Enlarged model cup
- USB port for simple updating



SC3000 Biostar Thermoforming Machine

## APPLICATIONS FOR MINISTAR & BIOSTAR

### FOR BOTH MINISTAR S AND BIOSTAR

### ADDITIONAL APPLICATIONS FOR BIOSTAR ONLY

# Thermoforming Products

## THERMOFORMING MATERIALS

### BIOPLAST® COLOUR

*Coloured mouthguard, positioner*

- Soft, pliable rubber material
- Does not bond to acrylic
- Supplied as a packet of 10



SC3271 Bioplast 3mm - colour set  
*includes 10 assorted colours*

- SC3356 Bioplast 3mm - blue-transparent
- SC3355 Bioplast 3mm - red-transparent
- SC3445 Bioplast 3mm - white
- SC3448 Bioplast 3mm - black
- SC3352 Bioplast 3mm - neon red
- SC3353 Bioplast 3mm - neon green
- SC3354 Bioplast 3mm - azure blue
- SC3281 Bioplast 3mm - yellow



- SC3362 Bioplast 5mm - blue-transparent
- SC3365 Bioplast 5mm - neon red
- SC3366 Bioplast 5mm - neon green

### BIOPLAST® MULTICOLOUR

*Multi-coloured mouthguard, positioner*

- Soft, pliable rubber material
- Does not bond to acrylic
- 3mm thickness
- Supplied as a packet of 10



- SC3390 Bioplast Multicolour - Germany (yellow/red/black)
- SC3391 Bioplast Multicolour - France (red/white/blue)
- SC3399 Bioplast Multicolour - Green dots (black/green)
- SC3392 Bioplast Multicolour - Italy (green/white/red)
- SC3393 Bioplast Multicolour - Spain (red/yellow/red)
- SC3395 Bioplast Multicolour - Brazil (green/blue/yellow)
- SC3397 Bioplast Multicolour - Atlantis (blue/red/blue)
- SC3396 Bioplast Multicolour - Transylvania (black/red/black)
- SC3398 Bioplast Multicolour - White dots (blue/white)
- SC3394 Bioplast Multicolour - Sweden (blue/yellow/blue)
- SC3400 Bioplast Multicolour - Multicolour set (1 of each colour)



### BIOPLAST® XTREME

*BIOPLAST® XTREME material is best suited for simple and secure fabrication of individual mouthguard*

A hard V-shaped reinforcement layer ensures additional protection in the anterior region, allowing precise positioning and dimensioning. Soft layer can be used for lamination with BIOPLAST® or for insertion of the counter bite.

- Supplied as a packet of 10



- SC3295 Bioplast Xtreme - 4mm red
- SC3296 Bioplast Xtreme - 4mm blue
- SC3297 Bioplast Xtreme - 4mm black
- SC3298 Bioplast Xtreme - 4mm clear
- SC3286 Bioplast Xtreme - 5mm red
- SC3287 Bioplast Xtreme - 5mm blue
- SC3288 Bioplast Xtreme - 5mm black
- SC3289 Bioplast Xtreme - 5mm clear



### BIOPLAST® XTREME KIT

*Two different degrees of hardness in one pressure moulding blank thanks to the integrated reinforcement in the delicate anterior region, absorbs hard and flat impacts in contact sports*

V-shaped harder insert for variable size of front tooth protection.

*Kits include:*

- 1 BIOPLAST® XTREME (5mm × 125mm)
- 1 bag of 15g CETRON® cleansing powder
- 1 BIOPLAST® insulating agent
- Retainer box



- SC3283 Bioplast Xtreme kit - 5mm red
- SC3284 Bioplast Xtreme kit - 5mm blue
- SC3285 Bioplast Xtreme kit - 5mm black

### BIOPLAST® XTREME PRO KIT

*For professional sports where hard and flat impacts often occur*

Additional hard-elastic layer for integrated reinforcement in the anterior region.

*Kits include:*

- 1 BIOPLAST® XTREME (4mm × 125 mm)
- 1× BIOPLAST® (2mm × 125mm)
- 1× DURAN® (0.75mm × 125mm)
- 1 x bag of 15g CETRON® cleansing powder
- 1 BIOPLAST® insulating agent
- Retainer box



- SC3292 Bioplast Xtreme Pro kit - 4mm red
- SC3293 Bioplast Xtreme Pro kit - 4mm blue
- SC3294 Bioplast Xtreme Pro kit - 4mm black



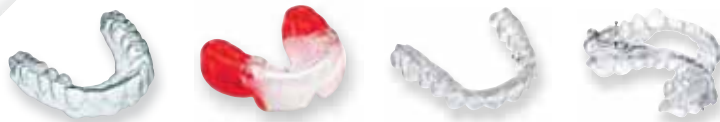

**BIOSTAR®**  
**MINISTAR S®**

## **BIOSTAR® and MINISTAR S®—**

**Top pressure moulding performance for unlimited applications in practice and laboratory.**

- // leading technology for 50 years
- // heater reaches working temperature in 1 second
- // scan technology for immediate code programming
- // great variety of pressure moulding material for all applications
- // 3 years warranty, 10 years on availability of spare parts

SCHEU-DENTAL GmbH  
[www.scheu-dental.com](http://www.scheu-dental.com)

phone +49 2374 9288-0  
fax +49 2374 9288-90



# Thermoforming Products

All Scheu thermoforming materials are 125mm round and supplied in packets of 10 unless stated otherwise

## BIOPLAST® XTREME DECO

The proven XTREME material for the fabrication of individual mouthguards is also available in many individual designs

- A new manufacturing technology enables photo-realistic, multi-colour designing
- Does not bond to acrylic
- Supplied as a packet of 5



- SC3312 Biocryl Xtreme Deco 5mm - chinese
- SC3313 Biocryl Xtreme Deco 5mm - dragon
- SC3314 Biocryl Xtreme Deco 5mm - kiss
- SC3315 Biocryl Xtreme Deco 5mm - aqua
- SC3316 Biocryl Xtreme Deco 5mm - stone
- SC3317 Biocryl Xtreme Deco 5mm - lion



## BIOPLAST® CLEAR

Model duplications, mouthguard, bruxism splints, positioner, bleaching splints, OSAMU-Retainer®

- Soft pliable rubber like material
- Does not bond to acrylic
- Clear-transparent

- SC3183 Bioplast clear - 1.5mm
- SC3185 Bioplast clear - 2mm
- SC31852 Bioplast clear - 2mm - packet of 100
- SC3187 Bioplast clear - 3mm
- SC31872 Bioplast clear - 3mm - packet of 100
- SC3188 Bioplast clear - 4mm
- SC31882 Bioplast clear - 4mm - packet of 100
- SC3374 Bioplast clear - 5mm



## BIOPLAST® BLEACH

Best suited for fabrication of bleaching splints

- Soft pliable rubber like material
- Does not bond to acrylic
- Clear-transparent

- SC3190 Bioplast Bleach - 1mm
- SC31902 Bioplast Bleach - 1mm - packet of 100



## BIOCRYL® C

For denture bases, immediate dentures, orthodontic retainers

- Break-resistant acrylic blanks made of pure PMMA material, monomer-free, without allergic reaction, bonds to acrylic



- SC3145 Biocryl C - transparent 1.5mm
- SC3147 Biocryl C - transparent 2mm
- SC3149 Biocryl C - red 2mm
- SC3150 Biocryl C - blue 2mm
- SC3151 Biocryl C - yellow 2mm
- SC3152 Biocryl C - rosa-transparent 2mm
- SC3153 Biocryl C - transparent 3mm



## BIOCRYL® M

For orthodontic plates and retainers

- Hard-elastic, monomer-free material, without allergenic irritants, bonds to acrylic



- SC3228 Biocryl M - multi colour set 2mm (two of each design)
- SC3230 Biocryl M - zebra 2mm
- SC3231 Biocryl M - rainbow 2mm
- SC3232 Biocryl M - tiger 2mm
- SC3233 Biocryl M - camouflage 2mm
- SC3229 Biocryl M - polka dots 2mm

## BRUX CHECKER

Foil with one-sided colour coating for analysis and treatment planning as well as for control of prosthetic restorations

- SC3209 Brux Checker 0.1mm



## COPYPLAST®

Model duplications, bleaching splints, bracket transfer trays, copings, moulds for temporary crowns and bridges

- Visco-elastic material
- Opaque
- Does not bond to acrylic

- SC3169 Copyplast 0.75mm
- SC3177 Copyplast 0.5mm
- SC3179 Copyplast 1mm
- SC31792 Copyplast 1mm - packet of 100
- SC3175 Copyplast 1.5mm
- SC3181 Copyplast 2mm
- SC31812 Copyplast 2mm - packet of 100



## DURAN®

Miniplast splints, occlusal splints, interim splints, fluoride splints, drilling/xray templates, anti-snoring appliances, invisible retainers, temporary crowns and bridges

- Hard-elastic transparent material, bonds to DURASPLINT® and DURASPLINT® LC acrylics
- Apply LC-Primer prior to using DURASPLINT® LC
- No pre-drying

- SC3411 Duran - 0.5mm
- SC3409 Duran - 0.625mm
- SC3413 Duran - 0.75mm
- SC34132 Duran - 0.75mm - packet of 100
- SC3415 Duran - 1mm
- SC34152 Duran - 1mm - packet of 100
- SC3417 Duran - 1.5mm
- SC34172 Duran - 1.5mm - packet of 100
- SC3419 Duran - 2mm
- SC3421 Duran - 3mm





# Thermofforming Products

## DURAN<sup>+</sup> A2

*Tooth-coloured temporaries, splints for planning and demonstration for aligner treatments*

- A2 tooth colour
- With integrated insulation foil
- Pre-dried and individually vacuum packed for instant use
- Supplied as a packet of 10

SC3422 Duran+ A2 - 0.5mm  
SC3423 Duran+ A2 - 0.75mm



## HARDCAST

*Copings, spacer foil for bleaching splints*

- Hard-elastic material
- Does not bond to acrylic
- Combustible leaving no residue
- Opaque
- Supplied as a packet of 10

SC3194 Hardcast 0.4mm  
SC3195 Hardcast 0.6mm



## DURASOFT<sup>®</sup> PRE-DRIED (PD)

*For periodontal splints, night-guards, bite splints*

- Compound foil already pre-dried and individually vacuum sealed, for instant use

Break and abrasion-resistant sandwich-material - hard on one side and soft on the other

- 0.8mm hard, 1mm soft (1.8mm)
- 1.2mm hard, 1.3mm soft (2.5mm)
- The hard side bonds to acrylic
- No need to pre-dry
- Supplied as a packet of 10

SC3342 Durasoft PD - 1.2mm x 125mm  
SC3388 Durasoft PD - 1.8mm x 125mm  
SC3387 Durasoft PD - 2.5mm x 125mm  
SC33872 Durasoft PD - 2.5mm x 125mm - packet of 100  
SC3341 Durasoft PD - 3mm x 125mm  
SC3345 Durasoft PD - 4mm x 125mm



## IMPRELON<sup>®</sup>

*Hard blanks, without elasticity, bonds to acrylic*

- IMPRELON in clear and nature for impression trays and dressing carriers
- White IMPRELON blanks for chin caps, bite splints and bite registration blocks
- Available in either 2mm or 3mm thickness
- Supplied as a packet of 10

SC3164 Imprelon clear - 2mm  
SC3168 Imprelon clear - 3mm



## IMPRELON<sup>®</sup> S

*OSAMU-Retainer, miniplast splints, occlusal and retention splints*

- Extremely break- and abrasion resistant material
- Pre-dried and individually vacuum packed for instant use
- Supplied as a packet of 10

SC3322 Imprelon S - 0.75mm  
SC3322 Imprelon S - 1mm  
SC3322 Imprelon S - 2mm



## DURASOFT<sup>®</sup> BLUE PRE-DRIED (PD)

*For simple fabrication of coloured intraoral anti-snoring appliances*

- The proven break and abrasion resistant compound material
- In blue-translucent colour
- Pre-dried and individually vacuum packed for instant use
- Supplied as a packet of 10

SC3347 Durasoft PD blue - 1.8mm x 125mm  
SC3348 Durasoft PD blue - 2.5mm x 125mm



## ISOFOLAN FOIL

*Insulation foil used for pressure moulding technique*

- Optimal insulation for plaster models against cold cure acrylics
- Can also be used as spacer foil for splints, when working with hard elastic blanks
- Size 0.1mm
- Supplied as a packet of 10

SC3207 Isofolan foil



## DURASOFT SEAL<sup>®</sup>

*Discolouration-resistant inner layer for DURASOFT PD splints, especially for long-term use splints such as intraoral anti-snoring appliances*

Pressure moulding material made of thermoplastic polyurethane for use with DURASOFT PD, forms a robust layer of hard/soft splints, providing good resistance against discolouration

- Size 0.1mm
- Supplied as a packet of 10

SC3337 Durasoft Seal - magenta  
SC3338 Durasoft Seal - clear  
SC3339 Durasoft Seal - blue



## BIOPLAST SEPARATOR

*Insulating agent for plaster models when working with BIOPLAST pressure moulding foils, especially when fabricating positioners and mouthguards*

- Provides absolute transparency and smooth inner surfaces
- Supplied as 1 x 500ml bottle

SC3189 Bioplast separator



# Thermofforming Products

## RESIN

### STEADY-RESIN S

*Cold cure resin for the "salt and pepper" technique*

This polymer meets all requirements for "salt and pepper" technique, such as high stability and wettability.

- Supplied as 1kg powder



SC8134 Steady-Resin S powder



### STEADY-RESIN S+M

*An all-purpose monomer and can be used with all Steady-Resin polymer versions*

The clear monomer can be mixed with Steady-Resin coloured monomers.

- Supplied as a 500ml bottle

SC8136 Steady-Resin S+M liquid - clear

SC8137 Steady-Resin S+M liquid - rose



### STEADY RESIN NEON POWDER

*Pre-mixed polymer in attractive neon colours*

Special colour pigments lead to uniform dispersion and streak-free, translucent material.

- Supplied as a 200g bottle

SC8125 Steady Resin Neon - yellow

SC8126 Steady Resin Neon - purple

SC8127 Steady Resin Neon - red

SC8128 Steady Resin Neon - blue

SC8129 Steady Resin Neon - green



### MICA GLITTER POWDER

*For individual mixing with STEADY-RESIN polymer*

The blends rainbow, rainbow green and rainbow violet are completely metal-free, creating iridescent gleam in pastel colours.

- Supplied as a 50g bottle

SC8150 Mica - rainbow

SC8151 Mica - rainbow green

SC8152 Mica - rainbow violet



### SPORTSGUARD/BRITEGUARD MOUTHGUARD MATERIAL

*High impact, super strong, super light mouthguard material*



120mm

127mm

- For use in vacuum forming machines

Sportsguard material combines premium strength with a comprehensive range of colour combinations. Sportsguard colours are totally organic and contain no cadmium or heavy metals. Manufactured in accordance with the standards of the ISO 9002 Quality Assurance Model and meeting the requirements of European and US regulations for food products, Sportsguard mouthguard material has also been granted CE approval rating.

#### Sportsguard Plain Colours (sold individually)

1, 1½, 2, 3 and 4mm	2mm 4mm	2mm 4mm	2mm 4mm	2mm 4mm
Clear	White	Red	Yellow	Green
2mm 4mm	2mm 4mm	4mm	4mm	4mm
Blue	Black	Dark Blue	Silver	Purple
4mm	2mm 4mm	4mm	4mm	
Burgundy	Light Blue	Aqua	Ruby Red	

SOSR\_ Sportsguard - 120mm round

SOSQ\_ Sportsguard - 127mm square



#### Sportsguard Fluorescent Colours (sold individually)

4mm	4mm	4mm	4mm	4mm
Watermelon	Signal Green	Lunar Yellow	Blaze Orange	Aurora Pink

SOSR\_ Sportsguard - 120mm round

SOSQ\_ Sportsguard - 127mm square

#### Sportsguard Designer Colour - Speed Sparks

SOSR\_ Sportsguard - 120mm round

SOSQ\_ Sportsguard - 127mm square



#### Sportsguard Easy Colours Dual - 3 stripes

- Available in 4mm thickness only (sold individually)

White Dk Blue White	Red White Red	Black White Black	Dk Blue White Dk Blue	Black Yellow Black
Brown Yellow Brown	Black Red Black	Dk Blue Red Dk Blue	Blue White Blue	Dk Blue Yellow Dk Blue

SOSR\_ Sportsguard - 120mm round

SOSQ\_ Sportsguard - 127mm square



#### Sportsguard Easy Colours Multi - 5 stripes

- Available in 4mm thickness only (sold individually)

White Dk Blue White	Red White Red	Black White Black	Dk Blue White Dk Blue	Black Yellow Black
Brown Yellow Brown	Black Red Black	Dk Blue Red Dk Blue	Blue White Blue	Dk Blue Yellow Dk Blue

SOSR\_ Sportsguard - 120mm round

SOSQ\_ Sportsguard - 127mm square

## BLEACHING SHEETS

### BLEACH (CLEAR) SHEETS

- Sold individually
- Available in round or square



SORO1CL Clear sheet 120mm x 1mm - round

SOSQ1CL Clear sheet 127mm x 1mm - square

SORO2CL Clear sheet 120mm x 2mm - round

SOSQ2CL Clear sheet 127mm x 2mm - square

120mm

127mm

# Thermofforming Products

## DENTAL SLEEP MEDICINE

### IST APPLIANCE KIT HF9

*Intra-oral anti-snoring device, fabricated in the pressure moulding technique*

Connection between upper and lower jaw is effected by HF telescopes, which can be subsequently activated up to 3 resp. 5 mm.

Lower jaw and tongue are advanced by protrusion.

*Kit comes with 2 telescopes, 4 DURAN® 2.0 mm, 4 ISOFOLAN®, DURASPLINT®, 4 fixing elements with O-ring, 4 SCHEU-Anchor, Alastik chain, silicone protection tube, security expansion key, SD box for patients, occlusion trainer, 2 bags of 15g CETRON® cleansing powder, instruction and patient information*



SC5461 Ist appliance kit HF9

### IST HERNER GUIDING TELESCOPES

*Telescopes with stop*

- Available in 3 sizes (HF5, HF9 and HF15)
- Subsequent activation is possible

Supplied as a pack of 2 (of same size)



- SC5448 Telescope HF 5 - 3mm activation/stroke 5mm
- SC5450 Telescope HF 9 - 5mm activation/stroke 9mm
- SC5452 Telescope HF 15 - 5mm activation/stroke 15mm

### GEORGE GAUGE BITE REGISTRATION KIT

*For simple and precise registration of occlusion in snoring therapy and orthodontics*

Kit includes 3 bite forks (1 fork for each size)



SC5471 George Gauge bite registration kit

#### Bite forks also sold separately

- Supplied as a packet of 10
- SC5472 Small, grey, 2mm
- SC5473 Small, white, 2mm
- SC5462 Large, white, 5mm

### TAP-T SLEEP MEDICINE KIT

Thornton Adjustable Positioner (TAP®) enables controlled and effective treatment of snoring and sleep apnoea. TAP® was developed by the American dentist and engineer Dr Keith Thornton.



Nickel-free metal components for optimum biocompatibility.

Upper protrusion adjustment device can be activated continuously up to 7mm by activation key.

SC90301 Tap-T Sleep Medicine kit

*Kit comes with TAP® case, upper protrusion adjustment device made of titanium, lower guiding device made of nickel-free stainless steel, mounting device, activation key, OCCLUSION TRAINER, 5 bags of 15g CETRON® cleansing powder, CETRON® cleansing box and patient information*



### TAP®-T REVERSE KIT

TAP®-T Reverse comes with a reduced upper protrusion adjustment device made of titanium, in particular for patients with deep bite. Adjustment of lower protrusion is done by activation key (palatal), as this reduced adjustment device can be inserted in the DURASOFT® splint behind the upper incisors.



SC90501 Tap-T Reverse Sleep Medicine kit

*Set comes with TAP® case, reduced upper adjustment protrusion device made of titanium, lower guiding device made of CoCr-alloy, mounting device, activation key, Occlusion trainer, 5 bags of 15g CETRON® Cleansing Powder, CETRON® cleansing box and patient information*



SC90502 Pre-assembled Tap-T Reverse Sleep Medicine kit

*Kit comes with upper adjustment protrusion device made of titanium and lower guiding device made of CoCr-alloy, pre-assembled with sticky wax, mounting device, activation key, Occlusion trainer, 5 bags of 15g CETRON® Cleansing Powder, CETRON® cleansing box and patient information*

### ACTIVATION KEY

Activation key for TAP®-T and TAP®-T Reverse upper protrusion adjustment device as well as for IST® hexagon socket screws



SC9035 Tap-T socket wrench/activation key

### LOWER GUIDING DEVICE

SC9032 Tap-T lower guiding device



### PROTRUSION ADJUSTMENT DEVICE

SC9033 Tap-T protrusion adjustment device



### MOUNTING DEVICE

- Supplied as a packet of 5

SC9039 Tap-T mounting device



# Thermoforming Products

## LIGHT CURING GEL AND PUTTY

### CLEAR BLOKKER® LIGHT CURING GEL

*Light-curing, high-transparent gel for adjusting pressure moulded DURAN® splints, reinforced with DURASPLINT® LC*

- Gel is best suited for removal of air inclusions and insertion of canine guidance
- Allows fixing of elements, such as IST® fixing elements on DURAN® splints
- UV LED lamp with wavelength of 360–420 nm or light-curing oven as well as LC-Primer are required for polymerisation



Supplied as 4 x 1.5g syringes,  
2 x micro cannula (0.4mm) +  
8 x mini-cannula



SC5261 Clear Blokker

### BLUE BLOKKER LIGHT CURING PUTTY

*Light curing, blue translucent blocking out and modelling material with excellent flow characteristics*

- For fabrication of space maintainers for bleaching splints and medical trays as well as for sealing sawing cuts for set-up models
- Combustible leaving no residue and therefore recommended as well in prosthodontics when fabricating fixed or removable prostheses
- Telescope constructions are stable and can be removed without tension
- Curing in the range of 380 – 470 nm



Supplied as 4 x 1.5g syringes

SC5276 Blue Blokker

## ACCESSORIES

### FOIL CUTTING SCISSORS A

*Small trimming scissors*

- Specially designed for cutting foils and splints with ease
- Ideal for trimming mouthguards and bleaching materials
- Made from German Wironit steel
- Curved blade



HMHSB63010 Foil cutting scissors A

### FOIL CUTTING SCISSORS B

*Large, robust trimming scissors*

- Durable scissors for cutting splints or inserting cuts into splints after pressure moulding



SC3461 Foil cutting scissors B

### FOAM DISCS

Space maintainer and insulation for pressure moulded impression trays, providing retention to impression material

- ø 103 mm
- Supplied as a packet of 10



SC3444 Foam discs

## IMPRESSION TRAY HANDLES

Stable, handy plastic handles which can be fixed to tray with cold cure resin and individually formed by heating

- Supplied as a packet of 10

SC3216 Impression tray handles



## STAINLESS STEEL PELLETS

*For embedding models in pressure moulding machine*

- Highly polished stainless steel pellets
- Models are securely positioned and cannot be pressed into the pellets

Supplied as 1kg pot

SC3222 Stainless steel pellets



## CETRON CLEANING POWDER

*For the hygienic and lasting care of dentures, orthodontic plates, splints and anti-snoring devices*

- Available as a set or powder

SC3235 Cetron cleaning care set (includes cleansing box, brush and 5 bags of 15g Cetron cleansing powder)

SC32391 Cetron cleaning powder - 5 x 15g powder sachets



## FINISHING SET

*For finishing of all pressure moulding materials*

- Finishing set includes 4 burs, 3 initial polishers and 1 final polisher

SC3378 Finishing set

### Finishing Set Refills

All components of the finishing set are also available separately - please also refer to page 93 for more details.



## PLASTIC BOXES

**Ideal for mouthguards or splints**

- 25mm deep
- With ventilation holes and hole for cord (not included)
- Available in blue, green, pink, white and yellow
- Sold individually

LAG45\_ Mouthguard box - specify colour



**Ideal for models and dentures**

- 42mm deep
- With ventilation holes and hole for cord (cord not included)
- Supplied in packet of 10 with assorted colours

LAORTHOB Ortho mouthguard box G3



# Wax Products

## FOR ACRYLIC WORK

### WAX BITE BLOCKS STRAIGHT

*Straight wax bite blocks*

- Easily adapted to fit normal ridge
- Grooved on underside to fit ridge of plaster model for full or partial cases
- Ensures quick and perfect registration

Supplied in box of 75 (pink sticks)

ASWAX505 Wax bite blocks - straight



### STICKY WAX, Yellow

*Model cement - for temporarily fixing teeth, clasps, crowns, etc.*

Melt the end of the stick with a gas flame and use as wax glue.  
For removal just reheat and the wax melts cleanly away without residue.

ASWAX401 Sticky wax, yellow - 70g

ASWAX402 Sticky wax, yellow - 500g



### KEMDENT #4 MODELLING WAX

*Modelling wax*

- Will not irritate oral tissues
- No unpleasant odour or flavour
- Softens without becoming flaky or crumbly
- Trims easily and cleanly
- Easy to soften and manipulate
- No residue on ceramic or synthetic polymer teeth
- Colour: Bright pink

Available in 2.5kg and 500g

ASWAX2.5 #4 modelling wax - 2.5kg (120 sheets approximately)

ASWAX500 #4 modelling wax - 500g (24 sheets)



Sheet size:  
189mm x 89mm  
x 1.5mm thick

### ANUTEX TOUGHENED WAX

*Modelling wax sheets - used to create the preliminary denture base*

- Will not irritate oral tissues
- No unpleasant odour or flavour
- Softens without becoming flaky or crumbly
- Trims easily and cleanly
- Colour: Translucent pink
- Sheet size: 187mm x 88mm x 1.5mm thick
- Supplied as 2.5kg (120 sheets approx)

ASWAXANU Anutex wax



### UTILITY WAX STRIPS - MODERN MATERIALS

- Large white strips
- Size - L279mm x ø 4.759mm
- Supplied as 500g (75 strips)

IV94191 Utility wax strips



### BITE RIMS, preformed/flavoured

- Preformed in accordance to the jaw proportions
- Very useful bite rims for the warmer seasons
- Elevated solidification point
- Available in three different hardnesses
  - soft, medium, hard
- Supplied as a packet of 96 pieces



YE6100100 Bite rims - soft - yellow/lemon flavoured  
 YE6110100 Bite rims - hard - red/strawberry flavoured  
 YE6120100 Bite rims - medium - green/apple flavoured  
 YE6130100 Bite rims - medium - orange/orange flavoured

### BITE WAX STICKS, flavoured

- These bite waxes stay stable when warm and when cooled down, giving excellent bite registration
- Size - 108 x 10 x 10 mm
- Supplied in 490g (approx 96 pieces)



YE6120490 Bite wax sticks - soft - yellow/lemon flavoured  
 YE6140490 Bite wax sticks - medium - green/apple flavoured  
 YE6130490 Bite wax sticks - hard - red/strawberry flavoured

## BLOCK-OUT MATERIALS

### CUTEX BLOCK-OUT WAX

*(Not suitable for casting technique, does not burn without residue)*

- CUTEX serves to block-out undercuts or to smooth rough surfaces on dies
- It is extremely hard and adapts easily to the contour of the die
- The higher melting point of CUTEX avoids bonding to the other YETI dipping waxes, underlining wax or cervical waxes
- Use CUTEX after application of the die spacers
- Easy to remove from the die at the end in order to hand over the unspoilt die to the dentist



YE7230000 Cutex block-out wax - 20g

## DIPPING WAX

### DUO DIP DIPPING WAX (ash-free)

- Granulated form of dipping wax
- Comfortable, clean and fast to work with

YE7410000 Duo Dip dipping wax - 80g



## ORTHODONTIC WAX

### ORTHODONTIC TRAY WAX

*For post damming of impression trays*

A soft, white plastic wax stick for orthodontic use in the extension of periphery, post-damming and stops for impression trays.

- Supplied as 48 sticks (175g)

KR9246 Orthodontic tray wax



**Kerr**

# Wax Products

## PREFORMED WAX PATTERN

### SPRUES

Fluid metal experiences a contraction upon solidification. The resulting partial vacuum can be compensated by drawing molten metal from the "reservoir". This was the idea when the sprues were created.

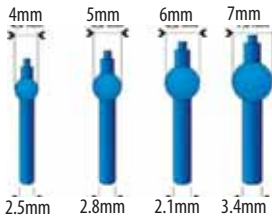

• Supplied as a packet of 250

YE7540250	Sprues blue (ball diameter) 4mm
YE7550250	Sprues blue (ball diameter) 5mm
YE7560250	Sprues blue (ball diameter) 6mm
YE7570250	Sprues blue (ball diameter) 7mm



## WAX WIRE

### DETON WAX WIRE BLUE (medium)

Tension free wax wire made using a special method and a special micro-molecular wax. The result is a wax wire of medium hardness with a great internal stability.

- Diameter:  $\varnothing$  2.5mm, 3mm, 3.5mm, 4.0mm, 5.0mm
- Supplied in a roll of 250g

YE7412500	Deton wax wire - 2.5mm
YE7423000	Deton wax wire - 3mm
YE7433500	Deton wax wire - 3.5mm
YE7444000	Deton wax wire - 4mm
YE7445500	Deton wax wire - 5mm



### DURON WAX WIRE GREEN (hard)

*Duron is an economical, hard and tension free wax wire*

- Available:  $\varnothing$  2mm, 2.5mm, 3mm, 3.5mm, 4mm and 5mm
- 250g roll

YE7461020	Duron wax wire 2mm
YE7461025	Duron wax wire 2.5mm
YE7461030	Duron wax wire 3mm
YE7461035	Duron wax wire 3.5mm
YE7461040	Duron wax wire 4mm
YE7461050	Duron wax wire 5mm



## WAXES FOR CROWNS & BRIDGES

### IQ SCULPTURING WAX

*High quality sculpturing wax suitable for any application*

- High inner stability - very hard, but not fragile
- Excellent solidification point: ash-free 62°C, opaque 63°C
- Unique rigidity makes the creation of tooth form easier
- Very good sculpturing features - exact reproduction of occlusal surfaces
- Tight fitting and low contraction thanks to the adding of micro waxes
- Easy to carve



YE7095000	IQ ash-free - blue - tin 45g
YE7105000	IQ ash-free - beige - tin 45g
YE7095100	IQ compact ash-free - blue - cylinder
YE7165100	IQ compact ash-free - white - cylinder
YE7165101	IQ compact opaque - white - cylinder



### THOWAX

*Sculpturing wax suitable for the crown and bridge inlay technique*

- Compound of natural wax
- Carvable, leaves smooth surfaces
- Burns without residue
- Melting point 53-57°C
- Available in various colours
- Supplied as a 70g tin



YE7080000	Thowax, red	YE7120000	Thowax, violet
YE7090000	Thowax, blue	YE7130000	Thowax, green
YE7100000	Thowax, beige	YE7140000	Thowax, grey

### CERVICAL WAX, red

- Smooth-flowing wax
- Tension-free for precise margins
- Adapts perfectly to the margin line
- Supplied as a 70g tin



YE7200000	Cervical wax, red
-----------	-------------------

## CAD / CAM WAXES

### CAD/CAM SCAN WAX

*Laser-opaque and light-opaque sculpturing wax for CAD/CAM technique*

- Size 98.5mm diameter
- Highly opaque wax for optimal scan data
- Excellent as block out wax
- Superb modelling qualities



YE7295000	CAD/CAM scan wax, beige 45g
-----------	-----------------------------



### CAD/CAM WAX BLANKS

- Size 98.5mm diameter
- Homogenous surfaces - mirror smooth milled surfaces
- Produced from residue-free, temperature stable and investment compatible micro-waxes



### Green, elastic (hardness 1) - model casting

- Sold individually

YE7950020	CAD/CAM wax, green 20mm disc
YE7950025	CAD/CAM wax, green 25mm disc
YE7950030	CAD/CAM wax, green 30mm disc



### CERAMILL MILLING WAX

*Milling wax that burns out without residue ensuring perfect casting results*



- Homogeneous preshaded blanks ensure shade stability
- Easy, reproducible CAD/CAM-controlled fabrication of wax patterns facilitate the casting and press techniques
- Virtually no cutter wear or clogging of the cutter by wax

AM760307	Ceramill Wax 13mm D block
AM760302	Ceramill Wax 20mm D block



# Wax Products

## MODEL CASTING WAX

### CONSEQUENT MULTIFUNCTIONAL CLASP

- The shifted ridge enables food residues to glide easily
- Fine and filigree clasp form
- Perfect anatomically shaped clasp
- High stability
- Elongated clasp arms for molars of larger dimensions
- Definitive saving of working time
- Colour - emerald green
- Supplied as 10 sheets (200 clasps in total)



YE1090000 Consequent multifunctional clasp

### WAX RETENTIONS / MESHES, red

- Tension-free
- Easy to adapt

YE1210000 Grid meshes  
- 7.1 x 7cm - 20 sheets

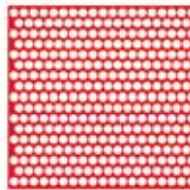

YE1270000 Oval retentions - 25 pieces



### WAX PROFILES IN BARS

- Tension free
- Length - approximately 150mm
- Colour - blue
- Hardness - hard



YE1510600 Wax wire, round,  $\varnothing$  0.60mm - 12g  
 YE1510800 Wax wire, round,  $\varnothing$  0.80mm - 25g  
 YE1511000 Wax wire, round,  $\varnothing$  1mm - 38g  
 YE1511200 Wax wire, round,  $\varnothing$  1.2mm - 50g  
 YE1511500 Wax wire, round,  $\varnothing$  1.5mm - 50g

### PREPARATION WAX, pink

- Well proven large sheet size - 17.5cm x 8cm
- Packet of 15 sheets
- Pink transparent



YE1352000 Preparation wax pink - 0.20mm  
 YE1355000 Preparation wax pink - 0.50mm  
 YE1356000 Preparation wax pink - 0.60mm

## INSULATING LIQUID

### YETI LUBE INSULATING LIQUID

*Matches perfectly with all Yeti waxes and spacers*

- Does not contain any alcohol or solvents, is water soluble and does not react with the investment material
- YETI LUBE isolates wax against plaster, metal and wax
- The separating effect last for more than 24 hours

YE5500001 Yeti Lube - 20ml  
 YE5500250 Yeti Lube - 250ml



### ISO QUICK INSULATING PEN

*A handy insulating pen filled with YETI LUBE*



- Thin and exact application without wasting material
- Easy to refill, economical and user friendly
- 2 different tips -  
1 x fine pointed, 1 x broad

YE5500000 ISO Quick insulating pen



## WAX INSTRUMENTS

### ARTLINE INSTRUMENTS

- Ergonomically designed and made in Germany
- Temperature isolated and non-slippery
- Tips are made of high-quality steel, are hand-sharpened and polished



YE8501000 Red - carving sharp + carving round



YE8502000 Silver - modelling tip medium + modelling tip large



YE8503000 Gold - modelling tip extra fine + modelling tip fine



### PK THOMAS WAX INSTRUMENT SET

Includes 5 instruments with coloured handles and brush, in a case

HMHSL02315  
 PK Thomas wax instrument set



## OTHER

### UNIVERSAL GLUE

*Glue for fixing wax retention pearls*

- For fixing of preformed parts and plate waxes in the casting technique

YE5080001 Universal glue - 20ml



### WAX BRUSH

Smooths and evens out wax surfaces gently after carving, without changing the characteristics of the tooth

YE9850000 Wax brush



# Xray Products

## XRAY FILM

### KODAK DF54

Ultra-speed, a true D-speed film. Ultra-speed film may be processed using manual or automated procedures.

- PA Size 0, 2cm x 3cm
- Supplied as a packet of 100

KODF54 Kodak DF54 xray film



### KODAK DF58

Accommodating a wide range of processing conditions, ultra-speed film is exceptionally tolerant of process variations, such as age of chemistry. And, it may be processed using manual or automated procedures.

- Bitewing, size 2, 3cm x 4cm, single
- Supplied as a packet of 150

KODF58 Kodak DF58 xray film



## XRAY CHEMICALS

### DEVELOPER

KODEV5L 5 litre (makes 25L)  
KODEV500 500ml (makes 2.5L)

### FIXER

KOFIX5L 5 litre (makes 25L)  
KOFIX500 500ml (makes 2.5L)



### RAPID ACCESS DEVELOPER & FIXER (1838374)

*Rapid Access - Ready-To-Use, Twin Pack*

Rapid Access is designed for manual processing of intraoral films to produce a wet-processed radiograph suitable for viewing in 30 seconds.

Supplied as 1 x developer and 1 x fixer (each containing 473mls)

KORAPID Rapid Access developer and fixer (1838374)



### READYMATIC DENTAL DEVELOPER, FIXER & REPLENISHER

Readymatic dental chemicals are used for the automatic processing of all Carestream intraoral and extraoral dental films. A separate starter solution is not required.

- Ready-to-use formula
- No more mixing or diluting
- Use in all automatic roller-transport dental xray film processors

Supplied as 2 bottles of developer + 2 bottles of fixer (each bottle contains 3.78 litres)

KOREADY Readymatic combo pack



## XRAY FILING PRODUCTS

### XRAY ENVELOPES

- Non-adhesive, transparent envelopes
- For bitewing xrays 3 x 4 cm
- Supplied as a roll of 1008

MG11008 Xray envelopes

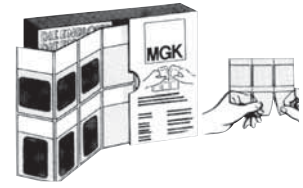

### ACETATE SHEETS

- Size 10.1cm x 16.6cm
- Supplied as a packet of 100

MGACETATE Acetate sheets

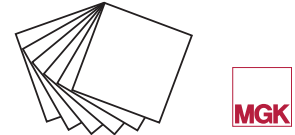

### PENCIL FOR FOIL MARKING

Durable, waterproof, special marker pencil with strong shape retaining tip and eraser, especially suited for writing on foil materials and plastics, black ink, dries instantly

MG80401 Black xray marker



## XRAY COVERS

### DIGITAL XRAY SLEEVES/COVERS

- For intra oral xray
- Size 4cm x 21cm
- Single in dispenser box
- Supplied as a packet of 500

MG70301 Digital xray sleeves/cover

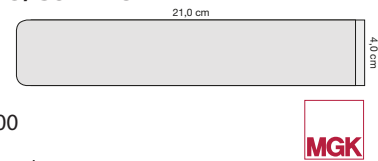

### HYGIENE OPG BITE BLOCK SLEEVES

- Size 5.1cm x 2.1cm (2.1cm-side open)
- In continuous dispenser box
- Supplied as a packet of 500

MG70302 Hygiene OPG bite block sleeves



### PHOSPHOR PLATE SLEEVES/COVERS

- Size 2
- 3cm x 4cm
- Supplied as a packet of 300

MG70602 Phosphor plate sleeves/covers



## XRAY FILM HOLDERS

### CARDBOARD BITEWING LOOPS

- Simple to use and economical
- Cardboard wraps around xray film to hold it
- Supplied as a box of 500

RA013 Bitewing loops



### ADHESIVE BITEWING TABS

- Simple to use and economical
- Tabs adhere securely to xray film
- Supplied as a box of 500

RA015 Bitewing tabs





# Xray Products

## XRAY FILM & PHOSPHOR PLATE HOLDERS

### KWIK-BITE

*Kwik-Bite® is a film and phosphor plate holder for standard horizontal bitewings*

- Autoclavable at 134° C, at least 3 minutes
- Compatible with most commonly used xray film formats (1, 2, 3)
- Compatible with all major brands of phosphor plate sensors
- Available with ring or with index

KR270 15 x Kwik-Bite with index

KR1780 5 x Kwik-Bite with ring + centring device

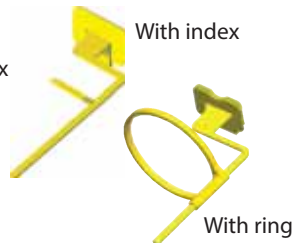

**Kerr**

### ENDO-BITE

*Endo-Bite is a film and phosphor plate holder for xrays during root canal treatment*

The system includes two types of holder (anterior/green and posterior/red) for use in all four quadrants.

- Autoclavable at 134° C, at least 3 minutes
- Compatible with all major brands of phosphor plate sensors

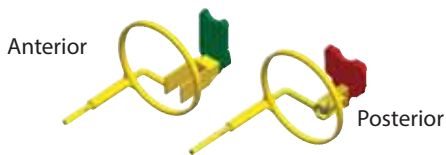

**Kerr**

KR1791 4 x Endo Bite Anterior with ring + 1 centring device

KR1792 4 x Endo Bite Posterior with ring + 1 centring device

KR1790 Endo Bite with ring assorted kit includes 2 x Endo-Bite Anterior + 2 x Endo-Bite Posterior + 1 centring device

### SUPER-BITE

*Super-Bite® is a film and phosphor plate holder indicated for periapical radiographs of anterior and posterior teeth*

The system includes two types of holder (anterior/green and posterior/red) for use in all four quadrants. The Super-Bite xray holder is useful for a wide variety of film and phosphor plates thicknesses.

- Autoclavable at 134° C, at least 3 minutes
- Compatible with all major brands of phosphor plate sensors
- Available with ring or with index

#### Super-Bite with ring

KR1021 4 x Super-Bite Anterior with ring + 1 centring device

KR1022 4 x Super-Bite Posterior with ring + 1 centring device

KR1020 Super-Bite with ring assorted kit includes 2 x Super-Bite Anterior + 2 x Super-Bite Posterior + 2 centring devices



**Kerr**

#### Super-Bite with index

KR671 8 x Super-Bite Anterior + 8 index

KR672 8 x Super-Bite Posterior + 8 index

KR670 Super-Bite with index assorted kit includes 4 x Super-Bite Anterior + 4 x Super-Bite Posterior + 8 indexes

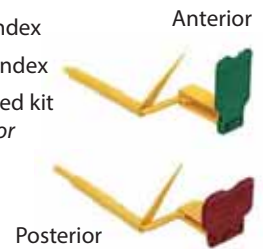

## LEAD APRONS

### LEAD XRAY APRONS

*Lead xray aprons provide protection for patients during intra-oral radiography*

- Each lead xray apron drapes comfortably over patient
- Aprons have an easy to clean vinyl front and durable, non-slip, corduroy backing
- Installed loops to assist with hanging
- Adult size measurements: W23" x L26" (length measured from neckline)



With collar

Without collar

#### Lead apron with collar

- The thyroid collar wraps comfortably around neck and fastens with velcro

KR31461 Lead apron with collar - blue

**Kerr**

#### Lead apron without collar

KR31401 Lead apron without collar - blue

*Other colours available on request*

### LEAD THYROID PROTECTOR

*Lead thyroid protectors are used during radiographs to protect the sensitive thyroid gland*

- Vinyl front and back
- Adult size measures W4" x L23"
- Available in blue or beige
- Sold individually

**Kerr**



KR41434 Thyroid protector - beige

KR31431 Thyroid protector - blue

# Index

- A**
- Acetate sheets ..... 184
  - Acrylic polishers ..... 92
  - Acrylic polishing pastes ..... 27
  - Acrylic powder and liquid ..... 23, 24
  - Adams clasps ..... 125
  - Adhesive, impression materials ..... 56
  - Admira Bond ..... 134, 140
  - Admira Fusion ..... 140, 142, 143
  - Admira Protect ..... 121
  - Aftamed ..... 121
  - Air compressors ..... 34, 132
  - Air motors ..... 51
  - Air scaler ..... 117
  - Aislar ..... 25, 101
  - Alganol ..... 135
  - Algimax ..... 54, 97
  - Alginate ..... 56
  - Alginate adhesive ..... 56
  - Alginate mixer ..... 54, 97
  - Alginate mixing bowl ..... 58
  - Alginate spatula ..... 58
  - Alginate storage containers ..... 58
  - Alginot ..... 58
  - Alloy ..... 99
  - Amalgam ..... 148
  - Amalgam carriers ..... 84
  - Amalgamator ..... 152
  - Amaris ..... 137, 143
  - Anaesthetic syringes ..... 162
  - Analgesics ..... 112, 121
  - Antifoaming disinfectant tablets ..... 69, 154
  - Anutex wax ..... 181
  - Apex articulator ..... 27, 106
  - Apex locator ..... 41
  - Applicator guns, restorative ..... 152
  - Applicator, endodontic ..... 40
  - Applicator, ligature ..... 81, 129
  - Applicator, Microbrushes ..... 150
  - Applicator, Pele Tim ..... 150
  - Applicator, Ultrabrushes ..... 150
  - Appliflex guns and syringes ..... 62, 152
  - Approxopeners ..... 130
  - Aprons, xray ..... 185
  - Arabesk ..... 138
  - Arte composite instruments ..... 79
  - Artery forceps ..... 159
  - Artex articulators ..... 105, 106, 107
  - Artex facebow ..... 106
  - Artex transfer stand and table ..... 106
  - Articulating forceps ..... 109
  - Articulating paper ..... 108
  - Articulators ..... 27, 105, 106, 107
  - Arti-fol film ..... 108
  - Arti-fof forceps ..... 109
  - Artigator ..... 107
  - Aspirator tips ..... 153, 162
  - Atlas flasks ..... 27
  - Austin retractor ..... 158
  - Autoclave indicator tape ..... 64
  - Autoclave pouches ..... 64
  - Autoclave reels ..... 64
- B**
- Ball clasps ..... 125
  - Band tweezers ..... 84
  - Band, matrix ..... 84, 149
  - Band-aids ..... 112
  - Barbed broaches ..... 38
  - Barnhart curette ..... 74
  - Barrier covers and sleeves ..... 70
  - Barrier film ..... 70
  - Base plates ..... 26
  - Base plates, Giroform ..... 104
  - Bath, denture ..... 95
  - Bausch articulating paper ..... 108
  - Bench press ..... 27
  - Berry drops ..... 118
  - Bib holders ..... 64
  - Bib, patient ..... 64
  - Bifix QM ..... 136
  - Bifix Temp ..... 135
  - Bifluorid 10 ..... 120
  - Bin, rubbish ..... 110
  - Biocryl ..... 176
  - Bioperm trimmer, laboratory ..... 93
  - Bioplast ..... 7, 174, 176
  - Bioplast Separator ..... 101, 177
  - Biostar ..... 173
  - Bird beak pliers ..... 82
  - Bite & White ExSense ..... 120
  - Bite & White whitening ..... 6
  - Bite block barrier sleeves/covers ..... 71, 184
  - Bite blocks, wax ..... 181
  - Bite blocks/mouth props ..... 83, 155
  - Bite fork, Artex ..... 106
  - Bite registration materials ..... 59, 102
  - Bite registration, George Gauge ..... 179
  - Bite wax sticks ..... 181
  - Bite wing loops and tabs ..... 184
  - Blades, scalpel ..... 156
  - Bleach tray boxes ..... 7
  - Bleach, endodontic ..... 40
  - Bleaching products ..... 6, 7, 176, 178
  - Bleaching sheets ..... 7, 176, 178
  - Block out gel ..... 101
  - Block out wax ..... 181
  - Blue Blokker ..... 101, 180
  - Bond, Admira ..... 140
  - Bond, Futurabond ..... 133
  - Bond, Optibond ..... 133
  - Bond, ormocer ..... 140
  - Bond, Palabond ..... 25
  - Bond, Signum metal ..... 91, 134
  - Bone collection trap ..... 163
  - Bottle, water dosing ..... 58
  - Bowdler Henry rake ..... 162
  - Bowls, mixing ..... 101
  - Box, disinfection ..... 68
  - Box, endodontic storage ..... 41
  - Box, model, mouthguard ..... 107, 131, 180
  - Bridge and implant floss ..... 119
  - Bright Teeth gel ..... 6, 7
  - Briteguard mouthguard material ..... 178
  - Broach, barbed ..... 38
  - Brush handle ..... 150
  - Brush tips ..... 150
  - Brush, bur ..... 21
  - Brush, ceramic ..... 89
  - Brush, denture ..... 26, 119
  - Brush, interdental ..... 120
  - Brush, lathe ..... 91
  - Brush, palate ..... 91
  - Brush, polishing ..... 45
  - Brush, prophylaxis ..... 45, 124
  - Brush, suction cleaning ..... 154
  - Brush, wax ..... 183
  - Brux Checker ..... 176
  - Buchanan endo pluggers ..... 42
  - Buff, calico ..... 91
  - Buffalo plaster knife ..... 88
  - Bulk fill composites ..... 142
  - Bunsen burner, NoFlame ..... 98
  - Bur accessories ..... 21
  - Bur block ..... 21
  - Bur brush ..... 21
  - Bur cassette ..... 21
  - Bur cleaning stone ..... 21
  - Bur disinfection box ..... 21, 68
  - Bur, carbide ..... 19, 20
  - Bur, Ceramill ..... 29
  - Bur, diamond ..... 8-18
  - Bur, laboratory ..... 92
  - Bur, osteotomy ..... 163
  - Bur, Scheu thermoforming ..... 93
  - Bur, side cutting Lindemann ..... 163
  - Bur, steel ..... 20
  - Bur, surgical ..... 163
  - Burnishers ..... 78, 79
- C**
- CAD CAM products ..... 28-32, 182
  - Calcicur ..... 39
  - Calcimol ..... 134
  - Calcium hydroxide ..... 39, 134
  - Calico buffs ..... 91
  - Camera barrier sleeves ..... 70
  - Canal probes ..... 37
  - Capsule dispensers ..... 152
  - Capsule mixer ..... 152
  - Carbide burs, clinical ..... 19-20
  - Carbide burs, laboratory ..... 92
  - Cards, record ..... 112
  - Carestream intraoral scanner ..... 30, 54
  - Carrier, amalgam ..... 84
  - Carrier, base ..... 78
  - Cartridge dispenser, impression ..... 62
  - Cartridge dispenser, restorative ..... 152
  - Carver, Hollenback ..... 80
  - Carver, laboratory ..... 88
  - Carver, LeCron ..... 88
  - Carver, Nystrom ..... 80
  - Carver, Wards Wax ..... 88
  - Case, model storage ..... 107
  - Cassette buttons ..... 85
  - Cassette, bur ..... 21
  - Cassette, Fixus ..... 165
  - Cassette, instrument ..... 87
  - Casting products ..... 99-104
  - Casting rings and liners ..... 100
  - Casting wax ..... 183
  - Cattani air compressors ..... 34
  - Cavex alginate ..... 56
  - Cavex LC tray material ..... 63
  - Cavex Silicon-A Bite ..... 59
  - Cavex Temporary Cement ..... 135
  - Cav-Hycal ..... 134
  - Cello metal strip holder ..... 46
  - Cement spatulas ..... 80
  - Cement, luting ..... 135, 136
  - Ceramic brushes ..... 89
  - Ceramic material ..... 28
  - Ceramill burs ..... 29
  - Ceramill furnace ..... 34
  - Ceramill liquid ..... 29
  - Ceramill polishing kit ..... 29
  - Ceramill products ..... 28-34
  - Cerec diamond bur set ..... 17
  - Cervical matrices ..... 85
  - Cervical wax ..... 182
  - Cetron cleaning powder ..... 180
  - CGI polishers ..... 44
  - Chain, bib ..... 64
  - Chair, portable ..... 132
  - Cheek retractors ..... 158
  - Chlorhexidine gel ..... 122
  - Chlorofluor gel ..... 122
  - Chlorofluor mouth rinse ..... 118
  - Chrome cobalt alloy ..... 99
  - Clamp, flask ..... 27
  - Clamp, rubber dam ..... 35-36
  - Clasp bending pliers ..... 82, 89
  - Clasp, Adams ..... 125
  - Clasp, ball ..... 125
  - Clasp, J (roach) ..... 125
  - Clasp, J oblique ..... 125
  - Clasp, JM ..... 125
  - Clasp, N ..... 125
  - Clasp, NK ..... 125
  - Clasp, orthodontic ..... 125
  - Clasp, roach ..... 125
  - Clasp, triangle ..... 125
  - Cleaner, denture ..... 62, 102, 180
  - Cleaner, distiller ..... 65
  - Cleaner, endodontic ..... 41
  - Cleaner, impression tray ..... 62
  - Cleaner, laboratory steam ..... 98
  - Cleaner, mirror heads ..... 83
  - Cleaner, pumice ..... 27
  - Cleaner, suction system ..... 69, 154
  - Cleaning cloths ..... 68, 110
  - Cleaning powder, splints, etc ..... 131, 180
  - Cleaning, surface wipes and spray ..... 68
  - Clearpaste flosser ..... 119
  - Cleaner, Blokker ..... 180
  - Cleoid-Discoïd instruments ..... 80
  - Clip temporary materials ..... 148
  - Cloth, cleaning ..... 68, 110
  - Coding products ..... 85
  - Cold spray ..... 40
  - College tweezers ..... 84, 160
  - ColourChange alginate ..... 56
  - Columbia curette ..... 74
  - Composite ..... 137-144
  - Composite capsule dispensers ..... 152
  - Composite inlay system ..... 144
  - Composite instruments ..... 79-81
  - Composite polishers ..... 44-46
  - Composite staining system ..... 144
  - Composite, Admira Fusion ..... 142, 143
  - Composite, Amaris ..... 137, 143
  - Composite, Arabesk ..... 138
  - Composite, bulk fill ..... 142
  - Composite, core build up ..... 146-147
  - Composite, flowable ..... 143
  - Composite, Grandio ..... 137, 143
  - Composite, GrandioSO ..... 137, 143
  - Composite, GrandTEC ..... 144
  - Composite, Harmonize ..... 138
  - Composite, Herculite ..... 138, 143
  - Composite, laboratory ..... 90
  - Composite, ormocer ..... 140
  - Composite, Quadrant Universal LC ..... 138
  - Composite, Signum ..... 90
  - Composite, SonicFill 2 ..... 142
  - Composite, temporary ..... 147-148
  - Composite, X-tra Base ..... 142
  - Composite, X-tra Fil ..... 142
  - Compound, impression ..... 55, 102
  - Compressors ..... 34, 132
  - Condenser, restorative ..... 79, 80
  - Cone formers ..... 100
  - Cone, felt ..... 91
  - Connector, Signum ..... 25, 90
  - Consequent clasp ..... 183
  - Contact formers ..... 85
  - Container, alginate ..... 58
  - Copyplast ..... 176
  - Cord packers ..... 53, 80
  - Core build up materials ..... 146-147
  - Cotton buds ..... 22
  - Cotton pellet dispensers ..... 22
  - Cotton pellets ..... 22
  - Cotton roll dispensers ..... 22
  - Cotton rolls ..... 22
  - Coupling, handpiece ..... 47
  - Cover, barrier ..... 70
  - Cover, bite block ..... 184
  - Cover, digital xray ..... 184
  - Cover, headrest ..... 70
  - Cover, phosphor plate ..... 184
  - Cover, xray sensor ..... 70

# Index

- Crane Kaplan scaler ..... 73  
 Cre-active, Pala ..... 25, 91  
 Cre-active, Signum ..... 90  
 Cream alginate ..... 56  
 Crile-Wood needle holders ..... 159  
 Crown cutting burs ..... 19  
 Crown forms ..... 151  
 Crown holding pliers ..... 89  
 Crown off instrument ..... 80  
 Crucible formers ..... 100  
 Crucible tongs ..... 89  
 Cup, plastic ..... 118  
 Cup, polishing ..... 44, 45  
 Cup, prophylaxis ..... 45, 124  
 Curette, Barnhart ..... 74  
 Curette, Columbia ..... 74  
 Curette, Goldman-Fox ..... 74  
 Curette, Gracey ..... 77-78  
 Curette, Implant ..... 76, 78  
 Curette, Langer ..... 74  
 Curette, McCall ..... 74  
 Curette, surgical ..... 162  
 Curette, titanium ..... 76, 78  
 Curette, universal ..... 74  
 Curing light barrier sleeves ..... 70  
 Curing lights ..... 152  
 Cutters, wire ..... 89
- D**  
 Dappen dishes ..... 124, 151  
 Dark Diamond instruments ..... 79  
 Deionised water ..... 58  
 Demi curing lights ..... 152  
 Dental floss ..... 119  
 Dental sleep medicine ..... 179  
 Dentotape ..... 119  
 Denture brushes ..... 26, 119  
 Denture products ..... 23-27  
 Denture reline material ..... 26  
 Dermocol Gel ..... 65  
 Dermocol Wash ..... 65  
 Desensitisers ..... 7, 120-121  
 Detex articulating paper ..... 108  
 Deton wax wire ..... 182  
 Developer, xray ..... 184  
 DF54 xray film ..... 184  
 DF58 xray film ..... 184  
 Dia Glace polishing paste ..... 27, 91  
 Diagnostic instruments ..... 72-73  
 Diamant trimmers ..... 29  
 Diamond burs, clinical ..... 8-18  
 Diamond burs, laboratory ..... 92  
 Diamond burs, sintered ..... 92  
 Diamond coated tweezers ..... 160  
 Diamond files ..... 76  
 Diamond polishers ..... 44  
 Diamond polishing paste ..... 45, 91  
 Diamond strips ..... 130, 131  
 Die hardener ..... 99  
 Die silicone ..... 101  
 Die spacer ..... 99  
 Digital dentistry ..... 28-34  
 Digital scanner, intraoral ..... 30, 54  
 Digital scanner, laboratory ..... 30  
 Digital xray sleeves ..... 71, 184  
 Dimo Pro trimming wheels ..... 93  
 Dipping wax ..... 181  
 Disclosing products ..... 122  
 Discs, foam ..... 180  
 Discs, polishing ..... 45-46  
 Dish, kidney ..... 159  
 Disinfectant tablets, suction ..... 69, 154  
 Disinfectant, hand ..... 65  
 Disinfectant, impression ..... 63, 65  
 Disinfection box, bur ..... 21  
 Disinfection soak tank ..... 66, 68, 85  
 Disinfection, surface products ..... 68  
 Dispenser, barrier film ..... 70  
 Dispenser, cartridge ..... 152  
 Dispenser, cotton pellets ..... 22  
 Dispenser, cotton roll ..... 22  
 Dispenser, impression material ..... 62  
 Dispenser, soap ..... 65, 114  
 Dosing bottle ..... 58  
 Drapes, sterile ..... 155  
 Dressing forceps ..... 159  
 Dri-aid ..... 22  
 Drill, gates glidden ..... 38  
 Drill, Giroform ..... 95  
 Drill, trephine ..... 163  
 Duo dip dipping wax ..... 181  
 Duplicating flask, Giroform ..... 104  
 Duran ..... 176-177  
 Durasoft ..... 177  
 Durasoft Seal ..... 177  
 Duron wax wire ..... 182  
 Dust extractor ..... 94
- E**  
 Easy Glaze ..... 145  
 ECO450 micro motor ..... 97  
 EDTA ..... 39  
 Eezitrays ..... 55  
 Electric motors ..... 51  
 Elements endodontic motor ..... 42  
 Elements Free gp cartridges ..... 42  
 Elements Free obturation system ..... 42  
 Elevator, periosteal ..... 160  
 Elevators ..... 165  
 Enamic, vita for Ceramill ..... 28  
 Endo cleaning sponges ..... 41  
 Endo prep bleach ..... 7, 40  
 Endo prep EDTA ..... 39  
 Endo Tim ..... 40  
 Endo-Bite Xray holders ..... 185  
 Endodontic applicators ..... 40  
 Endodontic boxes ..... 41  
 Endodontic dressings ..... 39  
 Endodontic equipment ..... 41-42  
 Endodontic excavator ..... 41, 81  
 Endodontic explorer ..... 41, 81  
 Endodontic file ..... 37-38  
 Endodontic instrument cleaner ..... 41  
 Endodontic lubricant ..... 39  
 Endodontic measurer ..... 41  
 Endodontic motor ..... 42  
 Endodontic needles ..... 40  
 Endodontic pluggers ..... 41, 81  
 Endodontic products ..... 35-42  
 Endodontic reamers ..... 38  
 Endodontic sealant ..... 40  
 Endodontic sonic syringe ..... 39  
 Endodontic sponge ..... 41  
 Endodontic spreader ..... 41, 81  
 Endodontic stopper ..... 37  
 Endodontic syringe ..... 40  
 Endo-mate TC2 ..... 42  
 Endotouch TC2 ..... 42  
 Envelope, bitewing xray ..... 184  
 Envelope, plastic for record cards ..... 112  
 Envelope, record ..... 112  
 Enzyme instrument solution ..... 66  
 Equipment portable ..... 132  
 Equipment, laboratory ..... 94-98  
 Equipment, lathe ..... 94  
 Equipment, micro motor ..... 51, 96, 97  
 Equipment, model trimmer ..... 94  
 Equipment, pressure moulding ..... 173  
 Equipment, surgical ..... 168-169  
 Equipment, thermoforming ..... 173  
 ErgoMix instruments ..... 78  
 Etching gel ..... 134  
 Ethicon sutures ..... 157  
 Excavator, endodontic ..... 41, 81  
 Excavators ..... 41, 78, 81  
 Excess scaler ..... 80  
 Expansion screws ..... 126  
 Expasyl ..... 53  
 Explorer, diagnostic ..... 72  
 Explorer, endodontic ..... 41, 81  
 Expros ..... 73  
 ExSense desensitiser ..... 7, 120  
 Extraction forceps, adult ..... 166  
 Extraction forceps, children ..... 167  
 Extractor, dust ..... 94  
 Eye shields ..... 71
- F**  
 Face shields ..... 71  
 Facebow, Artex ..... 106  
 Facial tissues ..... 110  
 Fahnstock wax knife ..... 88  
 Fastcold Plus ..... 40  
 Felt cones ..... 91  
 File, diamond perio ..... 76  
 File, endodontic ..... 37-38  
 File, surgical ..... 162  
 Filter, bone collection ..... 163  
 Final Touch staining system ..... 144  
 Finger pluggers ..... 38  
 Finger spreaders ..... 38  
 Finishing products, clinical ..... 44-46, 180  
 Finishing products, lab ..... 91-93, 180  
 Finishing set, thermoforming ..... 93, 180  
 First aid kit ..... 112  
 Fissure sealants ..... 122  
 Fit Test ..... 61  
 Fixator, Ceramill ..... 30  
 Fixer, xray ..... 184  
 Fixus cassette ..... 165  
 Flash Pearl prophylaxis powder ..... 117, 124  
 Flask clamp ..... 27  
 Flask, denture ..... 27  
 Flask, Giroform duplicating ..... 104  
 Flask, Palajet ..... 94  
 Fleximeter strips ..... 109  
 Flexitabs ..... 109  
 Flexplorer ..... 72  
 Floss ..... 119  
 Flossers, Cleanpaste ..... 119  
 Flowable composite ..... 143  
 Fluoride gel ..... 122  
 Fluoride varnish ..... 120-121  
 Flux, solder ..... 99  
 Foam discs ..... 180  
 Foam soap ..... 65  
 Fog off ..... 83  
 Foil cutting scissors ..... 180  
 Forceps, artery ..... 159  
 Forceps, articulating ..... 109  
 Forceps, dressing ..... 159  
 Forceps, extraction adult ..... 166  
 Forceps, extraction children ..... 167  
 Forceps, Halsted ..... 159  
 Forceps, Halsted-Mosquito ..... 159  
 Forceps, Mosquito ..... 159  
 Forceps, plaster ..... 89  
 Forceps, rubber dam ..... 36  
 Forceps, tissue ..... 159  
 Forceps, rubber dam ..... 36  
 Frame, rubber dam ..... 36  
 Fresh4sure mouthwash ..... 118  
 Funnel, casting ..... 100  
 Furcation probes ..... 73  
 Furcator ..... 76  
 Furnace, laboratory ..... 34, 98  
 Futar ..... 59  
 Futar D ..... 59  
 Futar D slow ..... 102
- Futurabond ..... 133
- G**  
 Gates glidden drills ..... 38  
 Gauze roll ..... 22, 155  
 Gauze squares ..... 22, 155  
 Gel Etchant ..... 134  
 Gel, light curing ..... 180  
 George gauge bite registration ..... 179  
 Gillies tweezers ..... 84, 160  
 Gingibraid ..... 53  
 Gingival retractors ..... 85  
 Gingivectomy knife, Kirkland ..... 162  
 Gingivectomy knife, Orban ..... 162  
 Giroform adaptor ..... 104  
 Giroform duplicating flask ..... 104  
 Giroform pin drill products ..... 95, 103  
 Giroform plates ..... 104  
 Giroform putty ..... 63, 102, 104  
 Giroform retention discs ..... 104  
 Glass beads ..... 100  
 Glass fibre strands ..... 144  
 Glass ionomer gun ..... 152  
 Glass ionomers ..... 135, 145  
 Glaze, glass ionomer ..... 145  
 Glitter powder ..... 128, 178  
 Gloves ..... 71  
 Glue, universal ..... 183  
 Gnatho film ..... 108  
 Goldman Fox curette ..... 74  
 Gracey curettes ..... 74, 77-78  
 Gracey curettes, sharpen-free ..... 74  
 Grandio ..... 137, 143  
 Grandio Seal ..... 122  
 GrandioSO ..... 137, 143  
 GrandioSO inlay system ..... 144  
 GrandTEC ..... 144  
 GreenClean ..... 62  
 Gritman plaster knife ..... 88  
 Guardian Seal ..... 122  
 Guiding device ..... 179  
 Gum scissors ..... 84, 160  
 Gun, cartridge ..... 62, 152  
 Gun, composite ..... 152  
 Gun, Expasyl ..... 53  
 Gun, glass ionomer ..... 152  
 Gun, impression material ..... 62  
 Gun, Rebuilda DC ..... 152  
 Gutta percha ..... 40, 42
- H**  
 H Dent needles ..... 162  
 Haemostatic sponges ..... 22, 155  
 Halsey needle holders ..... 159  
 Halsted forceps ..... 159  
 Halsted-Mosquito forceps ..... 159  
 Hand cream ..... 112  
 Hand sanitiser ..... 65  
 Handle, brush ..... 150  
 Handle, mirror ..... 72, 83  
 Handle, scalpel blades ..... 156  
 Handpiece lubricant ..... 52  
 Handpiece lubricating machine ..... 52  
 Handpiece, heads ..... 50  
 Handpiece, micro motor ..... 96-97  
 Handpiece, oscillating ..... 52, 130  
 Handpiece, prophylaxis ..... 50  
 Handpiece, shanks ..... 50  
 Handpiece, straight ..... 50  
 Handpiece, surgical ..... 169  
 Handpieces ..... 47-52  
 Handpieces, implant ..... 169  
 Hard denture liner ..... 26  
 Hardcast ..... 177  
 Harmonize ..... 138  
 Headrest covers ..... 70  
 Heat pluggers ..... 42

# Index

- Heating bath, Palamat ..... 95  
Hedstrom files ..... 37  
Heravest Press ..... 100  
Herculite Ultra Flow ..... 143  
Herculite XRV Ultra ..... 138  
HiLite Power ..... 94  
HiLite Pre ..... 95  
Hi-Shine polishing paste ..... 91  
Ho matrix bands ..... 149  
Hoe scalers ..... 76  
Holder, bib ..... 64  
Hollenback carver ..... 80
- I**  
Ibuprofen ..... 112, 121  
iCare lubricating machine ..... 52  
Idealis teeth ..... 171  
Identoflex polishers ..... 45, 92  
Implant curette ..... 76, 78  
Implant handpiece ..... 169  
Implant retractor ..... 158  
Impre disinfecting spray ..... 65  
Imprelon ..... 177  
Impresafe ..... 63, 65  
Impression compound ..... 55, 102  
Impression disinfectant ..... 63, 65  
Impression material ..... 53-63  
Impression syringe ..... 62  
Impression trays ..... 55  
Impressional materials ..... 53-63  
Impressional, alginate ..... 56  
Indicator tape, sterilisation ..... 64  
Individo Lux material ..... 63  
Infection control products ..... 64-71  
Injection unit for acrylic ..... 94  
Inlay system, composite ..... 144  
Instant stone ..... 100  
Instrument cassettes ..... 87  
Instrument cleaning solution ..... 66  
Instrument disinfectant ..... 66  
Instrument sharpener ..... 82  
Instrument tray sleeves ..... 70  
Instrument trays ..... 86  
Instrument, Arte ..... 79  
Instrument, Artline ..... 88, 183  
Instrument, burnishers ..... 78  
Instrument, carvers ..... 80  
Instrument, Cleoid-Discoid ..... 80  
Instrument, composite ..... 79-81  
Instrument, cord packers ..... 80  
Instrument, Crown Off ..... 80  
Instrument, Dark Diamond ..... 79  
Instrument, elevators ..... 165  
Instrument, endodontic ..... 37, 38, 81  
Instrument, endodontic excavator ..... 81  
Instrument, endodontic explorer ..... 81  
Instrument, ErgoAccess ..... 76  
Instrument, ErgoMix ..... 78  
Instrument, excess removal ..... 80  
Instrument, hand ..... 72-87  
Instrument, laboratory ..... 88  
Instrument, ligature ..... 81  
Instrument, luxating ..... 164  
Instrument, modelling ..... 88  
Instrument, Multiholder ..... 85  
Instrument, orthodontic ..... 81, 129  
Instrument, orthodontic stripping ..... 130  
Instrument, periodontic ..... 73-74, 77-78  
Instrument, PK Thomas ..... 88  
Instrument, plastic ..... 80  
Instrument, pluggers ..... 80  
Instrument, restorative ..... 78-81  
Instrument, root canal ..... 81  
Instrument, sharpen-free ..... 74  
Instrument, surgical ..... 162, 164-167  
Instrument, wax carving ..... 183
- Instrument, Wirofill ..... 81  
Insulating gel ..... 90  
Insulating liquid ..... 99, 183  
Insulating solution ..... 177  
Insulation foil ..... 177  
Intensiv crown cutting burs ..... 19  
Intensiv diamond burs ..... 8-17  
Intensiv polishers ..... 45  
Intensiv proxo strips ..... 46  
Interdental brushes ..... 120  
Interdental wooden wedges ..... 151  
Interfold paper towels ..... 110  
Interproximal strips ..... 46  
Intraligamentary syringe ..... 162  
Intraoral camera sleeves ..... 70  
Intraoral scanner ..... 30, 54  
Intraoral tips ..... 62  
Intraoral x-ray sleeves ..... 71  
Investment ..... 100  
Ionofil Molar AC Quick ..... 145  
Ionolux ..... 145  
Ionoseal ..... 135  
IonoStar Molar ..... 145  
Ipx II ..... 41  
IPR distance control set ..... 130  
IQ sculpturing wax ..... 182  
ISO Quick insulating pen ..... 183  
Isofolan ..... 177  
IST appliance ..... 179  
Ivory rubber dam products ..... 35, 36
- J**  
J clasp oblique ..... 125  
J clasps (roach) ..... 125  
Jet carbide burs ..... 20  
Jig, reline ..... 27  
JM Clasps ..... 125
- K**  
Kalthoff pliers ..... 82  
Kemdent No.4 wax ..... 181  
Kenda laboratory polishers ..... 92  
Kenda restorative polishers ..... 44  
K-files ..... 37  
K-Flex files ..... 37  
Kidney dishes ..... 159  
Kirkland gingivectomy knife ..... 162  
Knife, gingivectomy ..... 162  
Knife, plaster ..... 88  
Knife, wax ..... 88  
Kodak xray film ..... 184  
Kulzer acrylics ..... 23-24  
Kwik-Bite Xray holder ..... 185
- L**  
Laboratory burs ..... 92  
Laboratory equipment ..... 94  
Laboratory light curing unit ..... 95  
Laboratory polishers ..... 91, 92  
Laboratory putty ..... 63  
Langer curette ..... 74  
Laplander scaler ..... 73  
Laster retractor ..... 158  
Latex gloves ..... 71  
Lathe ..... 94  
Lathe brushes ..... 91  
Lathe splashguard ..... 94  
Lava Ultimate for Ceramill ..... 28  
LeCron carvers ..... 88  
Ledermix ..... 39  
Lessman wax knife ..... 88  
Lichen planus treatment, Aftamed ..... 121  
Life calcium hydroxide liner ..... 134  
LiftOut instruments ..... 164  
Ligature instruments ..... 81, 129  
Light cure tray material ..... 63  
Light curing gel ..... 180  
Light curing putty ..... 180
- Light curing unit, laboratory ..... 94, 95  
Light filter paddle ..... 151  
Light sleeves ..... 70  
Light, curing ..... 152  
Light, overhead portable ..... 132  
Lindemann side cutting bur ..... 163  
Liner, calcium hydroxide ..... 134  
Lingual bars ..... 125  
Lip retractor ..... 158  
Listerine mouthwashes ..... 7, 118  
LM instruments ..... 72-81  
Loop bending pliers ..... 82  
Loops, cardboard bite wing ..... 184  
Lube insulating liquid ..... 99, 183  
Lubri-Jet drops ..... 69, 154  
Lubricant, endodontic ..... 39  
Lubricant, handpiece ..... 52  
Luxating instruments ..... 164  
Luxident toothbrushes ..... 119
- M**  
Magnetic bur blocks ..... 21  
Magnets, Splitex ..... 107  
Mandrels ..... 45, 46, 92  
Masks, earloop and tie-on ..... 71  
Master platform set, Splitex ..... 107  
Matrices and retainers ..... 85, 149  
Matrix strips ..... 149  
Maxcem Elite Chroma ..... 136  
McCall curette ..... 74  
Measurer, endodontic ..... 41  
Measuring ruler ..... 89  
Measuring strips, occlusion ..... 109  
Medipack pouches ..... 64  
Meliodent ..... 24  
Memosil 2 ..... 59  
Meron Plus ..... 136  
Metal amalgam carriers ..... 84  
Metal bib holder ..... 64  
Metal bond ..... 91, 134  
Metal impression tray ..... 55  
Metal strips ..... 46, 130  
Mica glitter powder ..... 128, 178  
Micro 10 Enzyme 2 ..... 66  
Micro 10 Plus ..... 66  
Micro 10 Power Clean ..... 66  
Micro motor, clinical ..... 51  
Micro motor, laboratory ..... 96, 97  
Micro sickle ..... 73-74  
Microbrushes ..... 40, 150  
Micro-Stix ..... 150  
Mikro milling machines ..... 32  
Miller-Colburn curette ..... 162  
Milling wax ..... 28, 182  
Mini sickle scaler ..... 73-74  
Mini spatula, dark diamond ..... 79  
Mini Tork rolls ..... 110  
Ministar S ..... 173  
Minnesota retractor ..... 158  
Mint drops ..... 118  
Mirror cleaner ..... 83  
Mirror handles ..... 72, 81, 83, 129  
Mirror heads ..... 83  
Mirror, orthodontic ..... 131  
Mirror, patient ..... 151  
Mirror, photo ..... 83  
Mitchells Osteo trimmer ..... 162  
Mixer, capsule ..... 152  
Mixer, plaster ..... 97  
Mixing bowls ..... 58, 101  
Mixing machine, impression ..... 54, 97  
Mixing pads and slabs ..... 151  
Mixing tips ..... 62  
Model and casting products ..... 99-104  
Model cases ..... 107  
Model formers ..... 101
- Model saw ..... 89  
Model trimmer ..... 94  
Model, oral hygiene demonstration ..... 119  
Modelling instruments, laboratory ..... 88  
Modelling wax ..... 181  
Moisturisers ..... 112  
Moldavest investment ..... 100  
Molt 8 periosteal elevator ..... 160  
Molt 9 periosteal elevator ..... 160  
Monarch teeth ..... 172  
Mondial teeth ..... 171  
Monopren Transfer ..... 60  
Moores discs ..... 46  
Motion 2 5X mill ..... 32  
Motor, air ..... 51  
Motor, electric ..... 51  
Motor, surgical ..... 168  
Mounting device ..... 179  
Mouth props ..... 83, 155  
Mouth rinse, Chlorofluor ..... 118  
Mouthguard boxes ..... 180  
Mouthguard material ..... 174-178  
Mouthwash ..... 7, 118  
Mucopren soft ..... 26  
Multi 600 micro motor ..... 97  
Multi trays ..... 55  
Multiflex saliva ejectors ..... 153  
Multiholder system ..... 85, 86
- N**  
N Clasps ..... 125  
Nabers probes ..... 73  
Needle holder, Crile-Wood ..... 159  
Needle holder, Halsey ..... 159  
Needle holders ..... 159  
Needles ..... 162  
Needles, endodontic ..... 40  
Nerve broaches ..... 38  
Neutrogena hand cream ..... 112  
NiTi files ..... 38  
NiTin matrix products ..... 149  
NK clasps ..... 125  
NLX electric motors ..... 51  
Nobilis polishers ..... 44  
Noflame burner ..... 98  
Non woven gauze squares ..... 155  
North Bel burs ..... 18, 19  
North Carolina probes ..... 73  
NoW whitening system ..... 6  
NSK handpieces ..... 47-50  
NX3 cement ..... 136  
Nystrom carvers ..... 80
- O**  
O clasps ..... 125  
Occlusal spray ..... 101  
Occlusion products ..... 105-109  
Office products ..... 110-114  
OptiBond ..... 133, 136  
OptiDiscs ..... 45  
Optimum capsule mixer ..... 152  
OptiShine polishing brushes ..... 45  
Optostar teeth ..... 172  
Oragloves ..... 71  
Oral Care products ..... 115-124  
Oral medicine ..... 121-122  
Oramasks ..... 71  
Oramax mixing and intraoral tips ..... 62  
Orban gingivectomy knife ..... 162  
Ormocer material ..... 140  
Ortho stripping tool set ..... 129  
Orthodontic acrylic ..... 24  
Orthodontic instruments ..... 81, 129  
Orthodontic mirrors ..... 131  
Orthodontic model boxes ..... 131  
Orthodontic pliers ..... 82, 129  
Orthodontic products ..... 125-131

# Index

- Orthodontic stripping instruments ... 130  
 Orthodontic thermoforming..... 127, 128  
 Orthodontic wax..... 131, 181  
 Orthoskavident C ..... 53, 58  
 Ortho-strip system..... 17, 130, 131  
 Orthotrace alginate ..... 56  
 Osamu polisher ..... 93  
 Osseous collection trap.....163  
 Overhead light .....132  
 Overhead light barrier sleeves.....70
- P**
- Packer, cord..... 80  
 Packer-Modeller, composite.....79,80  
 Paddle, light filter .....151  
 Paddle, patient mirror..... 151  
 Pala cre-active..... 25, 91  
 Pala Lab putty.....63, 102  
 Pala teeth.....171  
 Palabond.....25  
 Paladent 20 .....23  
 Paladon 65 .....23  
 Paladur .....23  
 Palajet .....94  
 Palajet accessories.....94  
 Palamat Elite.....95  
 Palapress.....23  
 Palaseal.....25  
 Palate brush.....91  
 Palavit 55 .....24  
 PalaXpress.....24  
 Pana Spray Plus .....52  
 Panasil.....60-61  
 Panasil adhesive.....56  
 Paper points .....39  
 Paper products.....110  
 Paracetamol.....112, 121  
 Paste fillers .....38  
 Paste, laboratory polishing .....91  
 Paste, prophylaxis .....124  
 Pathfinder files.....37  
 Patient mirror .....151  
 Patient record cards.....112  
 Pearl prophylaxis powder .....117, 124  
 Peelvue sterilisation pouches .....64  
 Peeso reamers .....38  
 Pele Tims .....22, 150  
 Pellets, cotton .....22  
 Pellets, disclosing .....122  
 Pellets, stainless steel.....180  
 Pen, insulation .....183  
 Pencil, foil marking .....184  
 Periodontal instruments.....73-78  
 Periodontal probes .....73  
 Periopack Mini.....6, 122  
 Perioprox .....120  
 Periosteal elevators, Molt 8 .....160  
 Periosteal elevators, Molt 9.....160  
 Periosteal elevators, Pritchard .....160  
 Periotomes.....160  
 Perma-ret set.....25  
 Petroleum jelly .....6, 36  
 Phosphor plate barrier sleeves.....71, 184  
 Phosphor plate holders.....185  
 Photo mirrors, orthodontic.....131  
 Pikos osteotomy burs .....163  
 Pin drill, Giroform .....95, 103  
 Pins, Giroform .....95, 103  
 Pit and fissure sealants .....122  
 PK Thomas wax instruments .....88, 183  
 Plaque disclosing gel .....122  
 Plaster.....100  
 Plaster knives .....88  
 Plaster mixers.....97  
 Plaster nippers.....89  
 Plaster solvent .....27, 102  
 Plaster spatulas .....88  
 PlasterSafe.....27, 102  
 Plastic bib .....64  
 Plastic bib holder.....64  
 Plastic boxes.....7, 131  
 Plastic cups .....118  
 Plastic envelopes.....112  
 Plate set, Splitex .....107  
 Plates, Giroform.....104  
 Pliers.....82, 89, 129  
 Pliers rack .....89  
 Pliers, Adams.....89  
 Pliers, Aderer .....82, 89, 129  
 Pliers, band pinching .....129  
 Pliers, bird beak.....82, 129  
 Pliers, bracket removing .....129  
 Pliers, clasp bending .....82, 89  
 Pliers, crown holding.....89  
 Pliers, distal end cutters .....129  
 Pliers, Kalthoff.....129  
 Pliers, ligature locking.....129  
 Pliers, loop bending.....82  
 Pliers, orthodontic.....82  
 Pliers, Schwartz .....82, 129  
 Pliers, sling clasp.....129  
 Pliers, Wiengart .....129  
 Pliers, wire bending.....82, 89, 129  
 Pliers, Young .....129  
 Plugger, amalgam .....80  
 Plugger, Buchanan endo .....42  
 Plugger, endodontic.....38, 42, 81  
 Plugger, finger .....38  
 Polisher, acrylic.....92  
 Polisher, Ceramill kit.....29  
 Polisher, clinical.....44, 45  
 Polisher, laboratory.....92, 93  
 Polisher, Osamu.....93  
 Polisher, prophylaxis .....115, 117  
 Polishing brush, OptiShine .....45  
 Polishing discs .....45-46  
 Polishing paste diamond.....45  
 Polishing paste, laboratory .....27, 91  
 Polishing paste, prophylaxis.....124  
 Polyfix trimmer, laboratory .....93  
 Portable equipment .....132, 154  
 Posts, Rebilda core .....146  
 Pouches, autoclave .....64  
 Powder, prophylaxis.....124  
 Preci light.....95  
 Preci Tray material .....63  
 Preci-line retention set .....25  
 Premium teeth.....171  
 Pressure moulding equipment.....173  
 Pritchard periosteal elevators.....160  
 Probe, furcation.....73  
 Probe, periodontal .....73  
 Profluorid Varnish.....121  
 Promodel stone.....100  
 Prophylaxis brushes .....45, 124  
 Prophylaxis cups.....45, 124  
 Prophylaxis handpieces.....50  
 Prophylaxis paste .....124  
 Prophylaxis polisher.....117  
 Prophylaxis powder.....115, 124  
 Prophylaxis-Mate NEO.....117  
 ProPower ultrasonic scaler.....115  
 Protective shields .....71  
 Protective sleeves and covers.....70  
 Protesil putty.....63, 102  
 Provicol QM .....135  
 Proximal brushes.....120  
 Proxo strips .....46  
 Proxoshape set .....17  
 Puli-Jet Gentle suction cleaner.....69, 154  
 Pulp tester .....41  
 Pumice cleaner.....27, 102  
 PumiceSafe .....27, 102  
 Punch, rubber dam.....36  
 Putty, Giroform.....102, 104  
 Putty, laboratory.....63, 102, 104  
 Putty, light curing .....101, 180  
 Putty, Pala lab.....102  
 Putty, Panasil.....60
- Q**
- Quadrant Universal LC.....138  
 Quick Up .....144  
 Quickbite bite fork .....106
- R**
- Rack, pliers .....89  
 Rake, Bowdler Henry .....162  
 Rapid Access developer and fixer .....184  
 Rapid-Roll tubing covers .....155  
 Reach floss and flossers.....119  
 Reach toothbrushes .....119  
 Readymatic developer and fixer .....184  
 Reamers .....38  
 Rebilda DC .....146  
 Rebilda DC gun .....152  
 Rebilda Form.....146  
 Rebilda posts.....146  
 Record cards.....112  
 Record envelopes .....112  
 Redifix spray adhesive .....56  
 Reels, autoclave .....64  
 Reflective shields .....22  
 Registrado clear .....59  
 Registrado X-tra .....59  
 Reline jig .....27  
 Reline material, denture .....26  
 Remin Pro.....7, 121  
 Resin .....178  
 Resin cement.....136  
 Resin, orthodontic.....128  
 Restorative instruments.....79-81  
 Restorative products.....133-152  
 Retainer, matrix .....149  
 Retention disc, Giroform .....104  
 Retention disc, Splitex .....107  
 Retention set .....25  
 Retraction cord.....53  
 Retraction cord packers .....53  
 Retraction system, Expasyl.....53  
 Retractor, Austin .....158  
 Retractor, cheek .....158  
 Retractor, gingival .....85  
 Retractor, implant.....158  
 Retractor, Laster .....158  
 Retractor, lip .....158  
 Retractor, Minnesota .....158  
 Richmond cotton rolls .....22  
 Ring pots .....124  
 Rings, casting .....100  
 Rings, coding .....85  
 Riskontrol .....69  
 Roach clasp.....125  
 Roll, matrix strip .....149  
 Rondell disclosing pellets.....122  
 Rotagen Handpiece Spray.....82  
 Root canal instruments .....81  
 Root elevators.....165  
 RootOut .....164  
 RootTip Pick.....165  
 Rotagen Handpiece Spray.....52  
 Roto burs .....29  
 Rubber dam.....36  
 Rubber dam clamps .....35-36  
 Rubber dam forceps .....36  
 Rubber dam frame.....36  
 Rubber dam kit.....36  
 Rubber dam punch.....36  
 Rubbish bins.....110  
 Ruler, measuring.....89  
 Rush brush .....119
- S**
- Saliva ejectors.....153  
 Sanisleeves.....71, 155  
 Sanitiser, hand .....65  
 Saw blades .....89  
 Saw, laboratory.....89  
 Scaler, air.....117  
 Scaler, excess removal .....80  
 Scaler, hoe.....76  
 Scaler, sickle.....73-74  
 Scaler, ultrasonic.....115, 116  
 Scalpel blade handles .....156  
 Scalpel blade removers.....156  
 Scalpel blade, disposable.....156  
 Scalpel blade, sterile.....156  
 Scan wax.....28  
 Scanner, intraoral.....30  
 Schwartz pliers .....82  
 Scissors.....84, 160, 180  
 Scissors, foil cutting .....180  
 Scissors, gum.....84, 160  
 Scissors, Metzenbaum .....84, 160  
 Scissors, suture .....160  
 Screw, expansion.....126  
 Sculpturing wax.....182  
 Sealant, endodontic .....40  
 Sealant, Palaseal.....25  
 Sealapex.....40  
 Senator teeth .....172  
 Sensor covers.....70  
 Separator, acrylic .....25, 101  
 Separator, Aislar .....25, 101  
 Separator, Bioplast.....101  
 Separator, Isofolan .....177  
 Servo cassettes .....87  
 Servo Max cassettes .....87  
 Sharpen-free instruments .....74  
 Sharpening machine, instrument.....82  
 Sharpening stone, instrument.....82, 165  
 Shield, eye protective .....71  
 Shipping bag, impression .....65  
 Sickle scalers .....73-74  
 Side cutting bur, Lindemann.....163  
 Signum composite.....90  
 Signum connector .....25, 90  
 Signum cre-Active.....90  
 Signum insulating gel.....90  
 Signum Matrix.....90  
 Signum metal bond.....91, 134  
 Signinat.....58  
 Silicon impression materials.....60, 61  
 Silicon-A bite registration material .....59  
 Silicone dappen dishes .....124  
 Silicone tray adhesive .....56  
 Silicone, crown and bridge .....60-61  
 Silk sutures .....158  
 Siqveland matrix bands .....149  
 Sleep medicine products.....179  
 Sleeve, barrier.....70  
 Sleeve, bite block.....71, 184  
 Sleeve, curing light .....70  
 Sleeve, digital xray .....71, 184  
 Sleeve, intraoral camera.....70  
 Sleeve, light .....70  
 Sleeve, overhead light .....70  
 Sleeve, phosphor plate.....71, 184  
 Sleeve, syringe.....70  
 Sleeve, tray instrument.....70  
 Sleeve, tubing.....71  
 Slick gel .....39  
 SlimLift instruments .....164  
 Slip Not bib holders.....64

# Index

- Smart Rinse Berry Shield..... 118  
 Smartbox X2..... 97  
 Smartmix X2..... 97  
 S-Max air motor..... 51  
 Soak tank..... 66, 68, 85  
 Soap dispensers..... 65, 114  
 Soap, liquid..... 65, 114  
 Sodium perborate powder..... 40  
 Soft liners, denture..... 26  
 SoftClamp..... 36  
 Solvent, plaster..... 27, 102  
 SonicFill 2..... 142  
 Spacers, die..... 99  
 Spatula, alginate..... 58  
 Spatula, cement..... 80  
 Spatula, composite..... 79, 80  
 Spatula, dark diamond..... 79  
 Spatula, plaster..... 88  
 Special tray material, Imprelon..... 177  
 Special tray material, light cure..... 63  
 Splashguard, lathe..... 94  
 Splintec blocks..... 28  
 Splitex magnets..... 107  
 Splitex master platform set..... 107  
 Splitex mounting articulator..... 106  
 Splitex plates..... 107  
 Sponge, endodontic..... 41  
 Sponge, haemostatic..... 22, 155  
 Spongostan..... 22, 155  
 Sportsguard mouthguard material..... 178  
 Spray Mist absorber..... 52  
 Spray, Unisepta..... 68  
 Spreader, endodontic..... 38, 41, 81  
 Sprue, wax..... 182  
 Staining system, FinalTouch..... 144  
 StainLess..... 6  
 Stainless steel pellets..... 180  
 Steady Resin..... 128, 178  
 Steam cleaner X3..... 98  
 Steel burs..... 20  
 Sterile drapes..... 155  
 Sterile scalpel blades..... 156  
 Sterilisation pouches..... 64  
 Steripockets..... 22, 155  
 Sticky wax..... 181  
 Stone, bur cleaning..... 21  
 Stone, Instant..... 100  
 Stone, Rondo Plus..... 82  
 Stone, sharpening..... 82, 165  
 Stone, yellow..... 100  
 Stool, portable..... 132  
 Stoppers, endodontic..... 37  
 Strahlperlen beads..... 100  
 Strands, GrandTEC glass fibre..... 144  
 Strip crowns..... 151  
 Strip roll..... 149  
 Strip, finishing..... 46  
 Stripping instruments..... 130  
 Strips, diamond..... 130  
 Strips, matrix..... 149  
 Strips, metal..... 46  
 Structur 2 SC..... 148  
 Structur Premium..... 148  
 Suction cleaner, Puli-Jet Gentle..... 69, 154  
 Suction cleaner, Vacucid 2..... 69, 154  
 Suction disinfectant tablets..... 69  
 Suction system, Turbo Smart..... 154  
 Suction tips and adaptors..... 153  
 Super acrylic polishers..... 92  
 Super Seal desensitiser..... 7, 120  
 Super-Bite..... 185  
 Surface cleaning products..... 68  
 Surface disinfection products..... 68  
 Surgic Pro..... 168  
 Surgical aspirator..... 162  
 Surgical burs..... 163  
 Surgical handpieces..... 169  
 Surgical instruments..... 165-167  
 Surgical products..... 155-169  
 Surgical suction tips..... 153  
 Surgicel..... 22, 155  
 Suture scissors..... 160  
 Sutures, chromic gut..... 157  
 Sutures, chromic gut..... 157  
 Sutures, fast absorbing PGA..... 158  
 Sutures, PGA..... 158  
 Sutures, plain gut..... 158  
 Sutures, silk..... 158  
 Sutures, Vicryl..... 157  
 Sutures, Vicryl Rapide..... 157  
 Swingle handpiece..... 52, 130  
 Sympress dispenser mixing machine..... 54  
 Syntette..... 76  
 Syringe sleeve, barrier..... 70  
 Syringe, anaesthetic..... 162  
 Syringe, endodontic..... 40  
 Syringe, impression..... 62  
 Syringe, intraligamentary..... 162  
**T**  
 Tablets, disclosing..... 122  
 Tabs, adhesive bite wing..... 184  
 Take 1 Advanced VPS..... 61  
 Take 1 bite registration..... 59  
 Tank, disinfection..... 66, 68, 85  
 Tank, impression soak..... 65  
 Tape N Tell..... 85  
 Tape, autoclave indicator..... 64  
 Tape, colour coding..... 85  
 Tap-T sleep medicine kits..... 179  
 Teeth, Idealis..... 171  
 Teeth, Monarch..... 172  
 Teeth, Mondial..... 171  
 Teeth, Optostar..... 172  
 Teeth, Palaveneer..... 172  
 Teeth, Premium..... 171  
 Teeth, Senator..... 172  
 Teeth, Tribos..... 172  
 Temp-Bond cement..... 135  
 Temporary materials..... 135, 148  
 TF and TFA endodontic files..... 38  
 TF and TFA gutta percha..... 40  
 Therm S furnace..... 34, 98  
 Thermoforming accessories..... 180  
 Thermoforming equipment..... 173  
 Thermoforming products..... 173-180  
 Thinner, spacers..... 99  
 Thomas endodontic instruments..... 37  
 Thomas steel burs..... 20  
 Thowax..... 182  
 Throat pack..... 22, 155  
 Tilite alloy..... 99  
 Ti-Max air motor..... 51  
 Ti-Max handpieces..... 47-48, 50  
 Ti-Max S970..... 117  
 Tip, air scaler..... 117  
 Tip, aspirator..... 153  
 Tip, bone surgery..... 168  
 Tip, brush..... 150  
 Tip, Expasyl..... 53  
 Tip, intraoral..... 62  
 Tip, mixing..... 62  
 Tip, suction..... 153  
 Tip, ultrasonic scaling..... 115-116  
 Tissue forceps..... 159  
 Tissue management products..... 53  
 Tissues, facial..... 110  
 Titanium curette..... 77-78  
 Tofflemire matrix bands & retainers..... 149  
 Toilet rolls..... 110  
 Tongs, crucible..... 89  
 Tooth conditioner..... 7, 120  
 Toothbrush demonstrator..... 119  
 Toothbrushes..... 119  
 Torkmatic paper towels..... 110  
 Torque driver..... 163  
 Torque tip wrench..... 115  
 Trace tablets..... 122  
 Transfer stand and table..... 106  
 Transport III portable system..... 132  
 Trap, bone collection..... 163  
 Tray cleaner..... 27, 62  
 Tray sleeves, barrier..... 70  
 Tray, disinfection soak..... 66, 85  
 Tray, impression..... 55  
 Tray, instrument..... 86  
 Traypurol..... 62  
 Trephine drills..... 163  
 Triangle clasps..... 125  
 Tribos teeth..... 172  
 Tricutter bur, laboratory..... 93  
 Trimmer, Mitchells Osteo..... 162  
 Trimming wheels, Dimo Pro..... 93  
 Triplex syringe tip, disposable..... 69  
 Tubing covers, sterile..... 155  
 Turbines..... 47, 48  
 Turbo Smart suction system..... 154  
 Tweezers, band placement..... 160  
 Tweezers, College..... 84, 160  
 Tweezers, diamond coated..... 84, 160  
 Tweezers, dressing..... 160  
 Tweezers, Gillies..... 84, 160  
 TwistOut instruments..... 165  
**U**  
 Ufi Gel denture reliners..... 26  
 Ulcer treatment, Aftamed..... 121  
 Ultimate XL micro motor..... 96  
 Ultrabrushes..... 150  
 Ultrasonic cleaner..... 66  
 Ultrasonic cleaning liquid..... 66  
 Ultrasonic scaler..... 115, 116  
 Ultrasonic scaling tips..... 115, 116  
 Ultrasonic system, surgical..... 168  
 Unicus polishers..... 44  
 Unigloss paste..... 45  
 Unigloss polishers..... 45  
 Unisepta Foam 2..... 68  
 Unisepta Plus..... 68  
 Universal curettes..... 74  
 Universal glue..... 183  
 Universal implant curette..... 76  
 Utility wax..... 181  
**V**  
 Vacucid 2 suction cleaner..... 69, 154  
 Vacuum forming materials..... 178  
 Varios scalers..... 116  
 Variosurg 3..... 168  
 Varnish, fluoride..... 120-121  
 Vector expansion screws..... 126  
 Veritip suction tips..... 153  
 Vibrator, laboratory..... 94  
 Vibrate..... 39  
 Vicryl and Vicryl Rapide sutures..... 157  
 Visalys Core..... 147  
 Visalys Temp..... 147  
 Vita Enamic for Ceramill..... 28  
 Vitality scanner..... 41  
 VOCO Ionofil Molar AC Quick..... 145  
 Vococid..... 134  
 Volvere i7..... 96  
**W**  
 Wand curing light..... 152  
 Water distiller cleaner..... 65  
 Water dosing bottle..... 58  
 Water, deionised..... 58  
 Wax bars..... 183  
 Wax bite blocks..... 181  
 Wax brush..... 183  
 Wax instruments, PK Thomas..... 88, 183  
 Wax knife, Fahnstock..... 88  
 Wax knife, Lessman..... 88  
 Wax mesh..... 183  
 Wax pattern..... 182  
 Wax products..... 181-183  
 Wax profiles..... 183  
 Wax retentions..... 183  
 Wax sprue..... 182  
 Wax wire..... 182  
 Wax, Anutex..... 181  
 Wax, bite..... 181  
 Wax, block out..... 181  
 Wax, CAD CAM..... 28-29, 182  
 Wax, cervical..... 182  
 Wax, dipping..... 181  
 Wax, IQ sculpturing..... 182  
 Wax, milling..... 28, 182  
 Wax, model casting..... 183  
 Wax, modelling..... 181  
 Wax, orthodontic..... 131, 181  
 Wax, preparation..... 183  
 Wax, scan..... 28  
 Wax, sticky..... 181  
 Wax, utility..... 181  
 Wedge, wooden..... 151  
 Wheels, laboratory trimming..... 93  
 White lightening..... 7  
 Whitening pen..... 6  
 Whitening products..... 6-7  
 WHO probes..... 73  
 Williams probes..... 73  
 Wipes, cleaning..... 68, 110  
 Wipes, Unisepta Foam 2..... 68  
 Wipes, Unisepta Plus..... 68  
 Wire bending pliers..... 82, 89, 129  
 Wire cutters..... 89  
 Wire, chromium..... 125  
 Wire, Menzanium spring hard..... 125  
 Wire, wax..... 182  
 Wirofill instruments..... 81  
 Wironit alloy..... 99  
 Wrench, torque..... 163  
 Wrench, ultrasonic tip..... 115  
**X**  
 Xray aprons..... 185  
 Xray chemicals..... 184  
 Xray covers..... 184  
 Xray developer..... 184  
 Xray envelopes..... 184  
 Xray filing products..... 184  
 Xray film..... 184  
 Xray film holders..... 184-185  
 Xray fixer..... 184  
 Xray products..... 184-185  
 Xray sensor covers..... 70  
 X-ray sleeves..... 71  
 X-tra Base..... 142  
 X-tra Fil..... 142  
**Y**  
 Yeti Lube..... 99  
 Yeti spacers..... 99  
 Young pliers..... 82  
**Z**  
 Zinc oxide eugenol cement..... 135  
 Zircovis polishers..... 44  
 Zolid Ceramill blocks..... 28  
 Zonalin..... 135

# Our Business Partners

Oraltec is proud to represent the following suppliers and their quality brands and products





The koru (Maori for "loop") is an iconic sign that takes its spiral shape from an unfurling silver fern frond, symbolising new life, growth, strength and peace



Proud to be New Zealand owned and operated



Oraltec NZ Ltd

PO Box 33-087, Takapuna, Auckland, 0740  
16 Parkway Drive, Mairangi Bay, Auckland 0632  
Phone 0508 478 222 or 09 478 2229

Fax 09 478 221

[orders@oraltec.co.nz](mailto:orders@oraltec.co.nz)

[www.oraltec.co.nz](http://www.oraltec.co.nz)

 [oraltecnz](https://www.facebook.com/oraltecnz)