



ORIGINAL INSTRUCTIONS

Winch and Wireless Remote Control Installation and Operation Guide.

Every winching situation has the potential for personal injury. In order to minimize that risk, it is important to read this guide carefully. Please familiarize yourself with the operation of you winch before using it and be constantly safety oriented. In this guide we provide important safety information and instructions on how to install your winch.

SAVE THIS MANUAL and other product literature found in this kit for future reference and review frequently for continuing safe operation. Instruct all users of this product to review this manual before operating this product.

TABLE OF CONTENTS:

SAFETY:























Symbol Index	2
General Safety Precautions	3 - 6

INSTRUCTIONS:

Know Your Winch	7 - 10
Mounting	11
Free Spool Operation	11
Electrical Connections	11 - 12
Know Your Wireless Remote Control	12
Maintenance	13
Trouble Shooting/Error Conditions	14
Disposal	15
CE Declaration of Conformity	16

SYMBOL INDEX

Symbol Index for winch

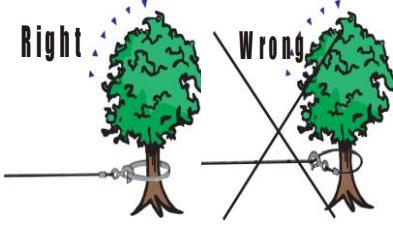
SYMBOL	EXPLANATION	SYMBOL	EXPLANATION
	Read All Product Literature		Always Wear Leather Gloves
	Always Wear Hearing and Eye Protection		Do Not Move People
	Never Use Winch as a Hoist		Always Use Supplied Hook Strap
	Properly Seat Load in Throat of Hook		Never Apply Load to Hook Tip or Latch
	Wind Rope on Bottom of Drum		Never Wind Rope Over Top Drum
	Finger/Fairlead Crushing Hazard		Fairlead Pinch Point
	Hand Piercing/Cutting Hazard		Hot Surface Hazard
	Explosion/Bursting Hazard		Fire and Burn Hazard
	Never Route Electrical Cables Across Sharp Edges		Never Route Electrical Cables through or Near Moving Parts
	Avoid Installing Electrical Cables around pinch and Wear/Abrasion Points		Exposed Wiring Hazard Insulate Exposed Wiring And Terminals
	Clutch Disengaged		Never Hook Back on Rope
 <p>Right Wrong</p> <p>Avoid side pulls</p>		 <p>Right Wrong</p> <p>Never hook the wire rope back onto itself</p>	

GENERAL SAFETY PRECAUTIONS

Warnings and Cautions



As you read these instructions, you will see **WARNINGS, CAUTIONS, NOTICES** and **NOTES**. Each message has a specific Purpose. **WARNINGS** are safety messages that indicate a potentially hazardous situation, which, if not avoided could result in serious injury or death. **CAUTIONS** are safety messages that indicate a potentially hazardous situation, which, if not avoided, could result in minor or moderate injury. A **CAUTION** may also be used to alert against unsafe practice. **CAUTIONS** and **WARNINGS** identify the hazard, indicate how to avoid the hazard, and advise of the probable consequence of not avoiding the hazard. **NOTICES** are messages to avoid property damage. **NOTES** are additional information to help you complete a procedure. **PLEASE WORK SAFELY!**

FCC Regulation

This device complies with Part 15 of the FCC Rule. Operation is subject to the following two conditions:

- This device may not cause harmful interference.
- This device must accept any interference received, including interference that may cause undesired operation.

This equipment has been tested and found to comply with the limits for a Class B digital device, pursuant to part 15 of the FCC Rules. These limits are designed to provide reasonable protection against harmful interference in a residential installation. This equipment generates, uses and can radiate radio frequency energy, and if not installed and used in accordance with the instructions, may cause harmful interference to radio communications. However, there is no guarantee that interference will not occur in a particular installation. If this equipment does cause harmful interference to radio or television reception, which can be determined by turning the equipment off and on, the user is encouraged to try to correct the interference by one or more of the following measures:

- Reorient or relocate the receiving antenna. Increase the separation between the equipment and receiver.
- Connect the equipment into an outlet on a circuit different from that to which the receiver is connected.
- Consult the dealer or an experienced radio/TV technician for help.

GENERAL SAFETY PRECAUTIONS

⚠ WARNING



MOVING PARTS ENTANGLEMENT HAZARD

Failure to observe these instructions could lead to serious injury or death.

Winching Safety:

1. **Always** Know Your Winch. Take time to fully read the Instructions in Order to understand your winch and its operations.
2. **Never** exceed winch or winch rope rated capacity. Double line using a snatch block to reduce winch load.
3. **Always** wear heavy leather gloves when handling winch rope.
4. **Never** use winch or winch rope for towing. Shock loads can damage, overload and break rope.
5. **Never** use a winch to secure a load.
6. **Never** operate this winch when under the influence of drugs, alcohol or medication
7. **Never** operate this winch if you are under 16 years of age.

Installation Safety:

1. **Always** choose a mounting location that is sufficiently strong to withstand the maximum pulling capacity of your winch.
2. **Always** use class 8.8 metric (grade 5) or better hardware.
3. **Never** weld mounting bolts.
4. **Always** use factory approved mounting hardware, components, and accessories.
5. **Never** use bolts that are too long.
6. **Always** confirm required bolt length to ensure proper thread engagement.
7. **Always** complete the winch installation and hook attachment before installing the wiring.
8. **Always** keep hands clear of winch rope, hook loop, hook and fairlead opening during installation, operation, and when spooling in or out.
9. **Always** position fairlead with warning readily visible on top.
10. **Always** pre-stretch rope and re-spool under load before use. Tightly wound rope reduces chances of "binding", which can damage the rope.

⚠ WARNING









MOVING PARTS ENTANGLEMENT HAZARD





Failure to observe these instructions could lead to serious injury or death.



General Safety:

- **Always** inspect winch rope, hook, and slings before operating winch. Frayed, kinked or damaged winch rope must be replaced immediately. Damaged components must be replaced before operation. Protect parts from damage.
- **Always** remove any element or obstacle that may interfere with safe operation of the winch.
- **Always** be certain the anchor you select will withstand the load and the strap or chain will not slip.
- **Always** use supplied hook strap whenever spooling winch rope in or out, during installation and during operation.
- **Always** require operators and bystanders to be aware of vehicle and or load.
- **Always** be aware of stability of vehicle and load during winching, keep others away. Alert all bystanders of an unstable condition.
- **Always** unspool as much winch rope as possible when rigging. Double line or pick distant anchor point.
- **Always** take time to use appropriate rigging techniques for a winch pull.
- **Never** touch winch rope or hook while someone else is at the control switch or during winching operation.
- **Never** engage or disengage clutch if winch is under load, winch rope is in tension or drum is moving.
- **Never** touch winch rope or hook while under tension or under load.
- **Always** stand clear of winch rope and load and keep others away while winching.
- **Never** use vehicle to pull load on winch rope. Combined load or shock load can damage, over load and break rope.
- **Never** wrap winch rope back onto itself. Use a choker chain or tree trunk protector on the anchor.
- **Never** use remote when vehicle is not in line of sight of operator.
- **Never** pair more than one winch and one remote together at the same time.

GENERAL SAFETY PRECAUTIONS



⚠ WARNING		
		
<p>MOVING PARTS ENTANGLEMENT HAZARD Failure to observe these instructions could lead to serious injury or death.</p> <ul style="list-style-type: none"> ▪ Always ensure hook latch is closed and not supporting load. ▪ Never apply load to hook tip or latch. Apply load only to the center of hook. ▪ Never use a hook whose throat opening has increased, or whose tip is bent or twisted. ▪ Always use a hook with a latch. ▪ Always ensure the operator and bystanders are aware of the stability of the vehicle and/or load. ▪ Never hook back on rope. 		
⚠ WARNING		
		
		
<p>CHEMICAL AND FIRE HAZARD Failure to observe these instructions could lead to serious injury or death.</p> <ul style="list-style-type: none"> ▪ Always remove jewelry and wear eye protection. ▪ Never route electrical cables across sharp edges. ▪ Never route electrical cables near parts that get hot. ▪ Never route electrical cables through or near moving parts. ▪ Always place the supplied terminal boots on wires and terminals as directed by the installation instructions. ▪ Never lean over battery while making connections. ▪ Never route electrical cables over battery terminals. ▪ Never short batter terminals with metal objects. ▪ Always consult operator's manual for proper wiring details. ▪ Always insulate and protect all exposed wiring and electrical terminals. ▪ Always connect red (+) power cable ONLY to the positive (+) terminal of the battery. ▪ Always connect black ground (-) power cable ONLY to the negative (-) terminal of the battery. ▪ Never connect red (+) power cable to the negative (-) terminal of the battery. 		

⚠ WARNING	
	
	
<p>FALLING OR CRUSHING HAZARD Failure to observe these instructions could lead to serious injury or death.</p> <ul style="list-style-type: none"> ▪ Always stand clear, keep hands clear, and keep others away. ▪ Never operate winch with less than 5wraps of wire rope/10wraps of synthetic rope around the drum. Rope could come loose from the drum, as the rope attachment to the drum is not designed to hold a load. ▪ Never use winch as a hoist or to suspend a load. ▪ Always be certain anchor will withstand load, use appropriate rigging and take time to rig correctly. ▪ Never use winch to lift or move persons. ▪ Never use excessive effort to free spool winch rope. ▪ Always use proper posture/lifting technique or get lifting assistance while handling and installing product. ▪ Always wind the winch rope on bottom (mount side) of drum. ▪ Never wind rope over top of drum. ▪ Always spool the winch rope onto the drum in the direction specified by the drum rotation labels on the winch and/or in the documentation. This is required for the automatic brake (if so equipped) to function properly. 	

⚠ WARNING	
	
<p>CUT AND BURN HAZARD Failure to observe these instructions could lead to serious injury or death.</p> <p>To avoid injury to hands and fingers:</p> <ul style="list-style-type: none"> ▪ Always wear heavy leather gloves when handling winch rope. ▪ Always be aware of possible hot surfaces at winch motor, drum or rope during or after winch use. 	

GENERAL SAFETY PRECAUTIONS

⚠ CAUTION	
	
<p>MOVING PARTS ENTANGLEMENT HAZARD Failure to observe these instructions could lead to serious injury or death.</p> <p>To avoid injury to hands and fingers:</p> <ul style="list-style-type: none"> ▪ Never leave winch remote control where it can be activated during free spooling, ringing, or when the winch is not being used. ▪ Never leave the wireless winch remote control turned on when installing, free spooling, rigging or servicing winch, or when the winch is not being used. 	

⚠ CAUTION	
	
<p>CUT AND BURN HAZARD Failure to observe these instructions could lead to minor or moderate injury.</p> <ul style="list-style-type: none"> ▪ Never let winch rope slip through your hands. 	

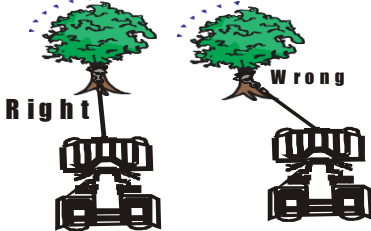
NOTICE	
	
<p>AVOID WINCH AND EQUIPMENT DAMAGE</p> <ul style="list-style-type: none"> ▪ Always avoid side pulls which can pile up winch rope at one end of the drum. This can damage winch rope or winch. ▪ Always ensure the clutch is fully engaged or disengaged. ▪ Always use care to not damage the vehicle frame when anchoring to a vehicle during a winching operation. ▪ Never submerge winch in water, if not IP68 rated. ▪ Always store the remote control in a protected, clean dry area. 	

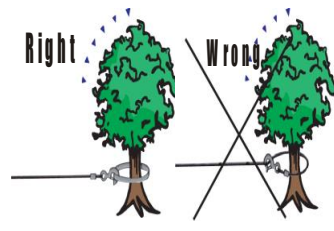
NOTICE	
	
<ul style="list-style-type: none"> ▪ Never hook the wire rope back onto itself because you could damage the wire rope. Use a strap. ▪ Avoid continuous pulls from extreme angles as this will cause the wire rope to pile up on one end of the drum. This can jam the wire rope of the winch. 	

This manual provides instructions on how to install and operate your winch and operating your Wireless Remote Control.

SAFETY

When installing your winch system, read and follow all mounting and safety instructions. Always use caution when working with electricity and remember to verify that no exposed electrical connections exist before energizing your winch circuit. For specifications and performance data, refer to the specification sheet supplied in this manual.

KNOW YOUR WINCH

Before you begin, you should familiarize yourself with your winch and each of its components;

3000lb Winch Specifications

Rated Line Pull: 3000lbs (1361kg)

Motor: 12V DC 3.0HP/2.24KW Permanent Magnet Motor

Controls: Remote Control (Handlebar) & Wireless Remote Control

Gear train: 1-Stage Planetary

Gear Ratio: 153:1

Clutch (Free Spool): Pull and Push

Drum diameter/length: 1.5" /2.83" (38mm/72mm)

Rope: Galvanized Steel Wire 3/16" x42.6' (4.76mm x 13m)

Recommended Battery: 12 Amp/hr. minimum

Fairlead: Roller

Duty Cycle: Intermittent

Mounting Bolt Pattern: 3.15" (80mm)

Winch Dimensions: 11.7 " Lx4.65 " Wx4.21 " H(297mm x 118mm x 107mm)

Shipping Weight: 19.4lbs(8.8kgs)

LINE PULL AND ROPE CAPACITY LAYER							
Layer of cable		1	2	3	4	5	
Rated line pull	Lbs	3000	2420	2027	1740	1053	
	Kgs	1361	1097	919	789	694	
Cable of layer	Ft	6.14	13.8	22.83	33.4	42.7	
	M	1.87	4.21	6.96	10.19	13	

LINE SPEED & AMP DRAW – FIRST LAYER						
Line pull	Lbs	0	1000	2000	3000	
	Kgs	0	453.6	907	1361	
Line Speed	Fpm	13.82	8.6	7.19	5.9	
	Mpm	4.21	2.62	2.19	1.8	
Amp	A	11	65	110	150	

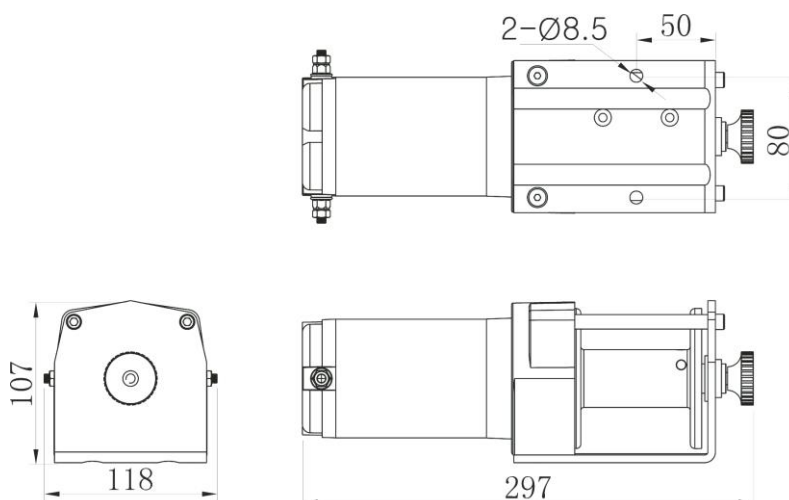

KNOW YOUR WINCH

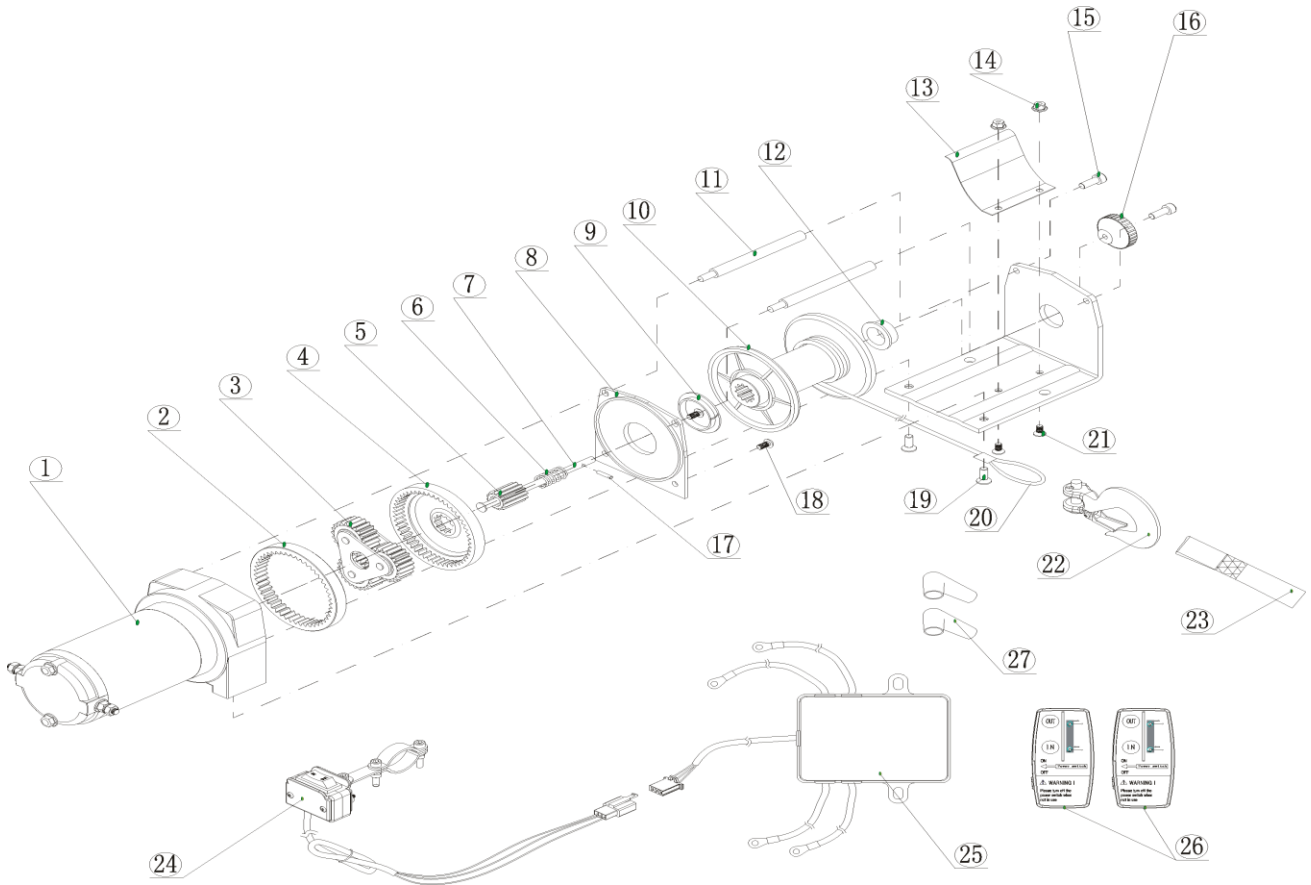

No.	Name	Qty	No.	Name	Qty
1	Motor assembly	1	15	M6*16 inside hexagonal bolt	2
2	Inner gear	1	16	Clutch handle	1
3	Planetary gear	1	17	Plug pin	1
4	Inner gear plate	1	18	M5*10 round head screw	2
5	Clutch gear	1	19	M8*16 hexagon head screw	2
6	Clutch spring	1	20	Wire rope assembly	1
7	Clutch bar	1	21	M5*12 hexagon head screw	2
8	Gear box cover	1	22	Hook	1
9	Free bearing	1	23	Hook belt	1
10	Drum	1	24	Wired remote handle	1
11	Support bar	2	25	Control box assembly	1
12	Free bearing	1	26	Wireless remote handle	2
13	Elastic steel plate	1	27	Wire cord sheath	2
14	M5 flange nut	2			

KNOW YOUR WINCH

4500lb Specifications

Rated Line Pull: 4500lbs(2041kg)

Motor: 12V DC 3.9HP/2.9KW Permanent Magnet Motor

Controls: Remote Control & Wireless Remote Control

Gear train: 2-Stage Planetary

Gear Ratio: 271:1

Clutch (Free spool): Rotate 105°

Drum diameter/length: 1.97 " /2.83 " (50mm /115mm)

Rope: Galvanized Steel Wire 0.26 " x49.2' (6.5mm x 15m)

Recommended Battery: 12 Amp/hr minimum

Fairlead: Roller

Duty Cycle: Intermittent

Mounting Bolt Pattern: 2.99 " x6.49 " (76mm x165mm)

Winch Dimensions: 13.77 " Lx4.53 " Wx4.72 " H(350mm x 115mm x 120mm)

Shipping Weight: 33lbs(15kgs)

LINE PULL AND ROPE CAPACITY LAYER							
Layer of cable		1	2	3	4		
Rated line pull	Lbs	4500	3879	3214	2812		
	Kgs	2041	1759	1457	1275		
Cable of layer	Ft	12.47	21.98	39.37	49.21		
	M	3.8	6.7	12	15		

LINE SPEED & AMP DRAW-FIRST LAYER							
Line pull	Lbs	0	1000	2000	4500		
	Kgs	0	453.6	907	2041		
Line Speed	Fpm	13.7	11.48	9.2	7.87		
	Mpm	4.2	3.5	2.81	2.4		
Amp	A	45	87	120	170		

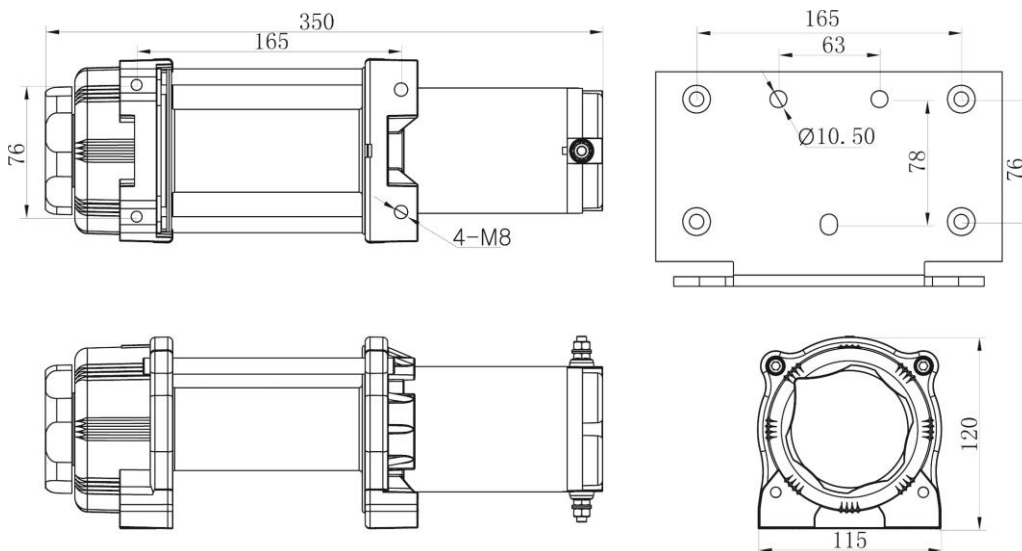

KNOW YOUR WINCH

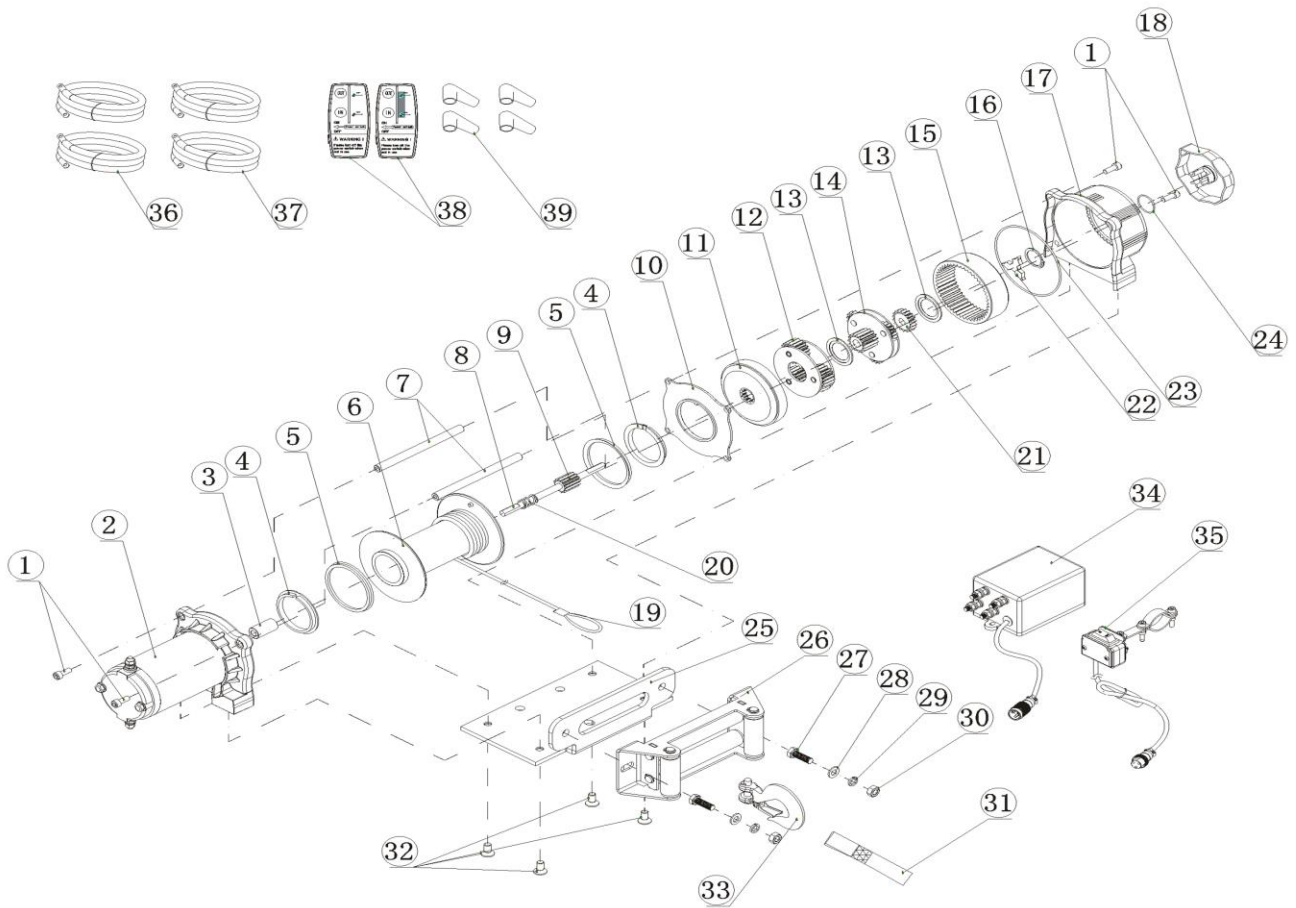

No	Name	Qty	No	Name	Qty	No	Name	Qty
1	M6*16 inside hexagonal bolt	4	14	1 st stage planetary gear	1	27	Hexagon screw M8*25	2
2	Motor assembly	1	15	Inner gear	1	28	Φ8 flat washer	2
3	Shaft coupling	1	16	Block ring 24*1.2	1	29	Φ8 spring washer	2
4	Free bearing	2	17	Gear box	1	30	M8 lock nut	2
5	O ring sealing	2	18	Clutch handle	1	31	Hook belt	1
6	Drum	1	19	Wire rope assembly	1	32	M8*20 inside hexagonal bolt	4
7	Support bar	2	20	Clutch spring	1	33	Hook 5/16"	1
8	Transmission shaft	1	21	1 st stage inner gear	1	34	Control box assembly	1
9	Clutch gear	1	22	Triangles slider	1	35	Wired remote handle	1
10	Gear box cover	1	23	O ring Φ104*1.8	1	36	Battery wire cord	2
11	Inner gear plate	1	24	O ring Φ24*1.5	1	37	Motor wire cord	2
12	2 nd stage planetary gear	1	25	Mounting plate	1	38	Wireless remote handle	2
13	Planetary gear spacer	2	26	Fairlead	1	39	Wire cord sheath	4

MOUNTING

⚠ CAUTION To prevent accidental activation of the winch and serious injury, complete the winch installation and attach the hook before installing the wiring.

⚠ WARNING Always choose a mounting location that is sufficiently strong enough to withstand the maximum pulling capacity of your winch.

⚠ WARNING Always spool the winch rope onto the drum in the direction specified by the drum rotation labels on the winch and/or in the documentation. This is required for the automatic brake (if so equipped) to function properly.

⚠ WARNING Always wind the winch rope on the bottom (mount side) of the drum.

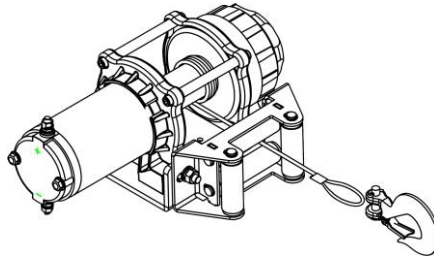

This winch should always be mounted in a horizontal orientation with the rope winding on and off the drum on the mount side (bottom) of the drum.

Correct rotation is required for the automatic brake to function properly. Horizontal mounting helps prevent the rope from piling up on one end of the drum which can damage the winch.

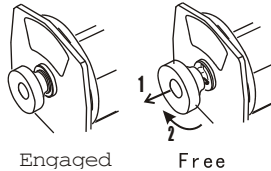

FREESPOOL OPERATION

Pull and turn the clutch knob to the “Free spool” position. Activate the winch in Cable Out to check the drum rotation direction. If the drum rotates in the wrong direction, recheck your wiring. If there is a load on the rope, the clutch knob may not pull out easily. **DO NOT FORCE THE CLUTCH KNOB.** Release tension on the clutch by jogging out some of the rope. Check that there are at least five turns of wire rope/ ten turns of synthetic rope left on the drum. Re-engaged the drum by returning the clutch knob to the “Engaged” position. Different winches with different clutches as the followed figures, you shall make sure which one fit to your winch.

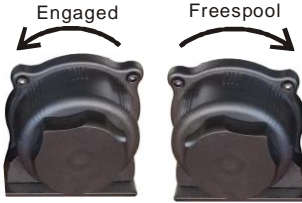
ATV winch	Clutch	Free spool Operation	⚠ Caution
	Pull and push		<p>Clutch must be fully engaged before winching.</p> <p>Never engage clutch knob while drum is turning.</p>
	Rotate		<p>If the winch motor stalls, do not continue to apply power.</p>

ELECTRICAL CONNECTIONS

Refer to the figures for wiring diagram. Different winches with different wiring diagram, you shall make sure which one fit to your winch.

Model A: For a winch with a control box

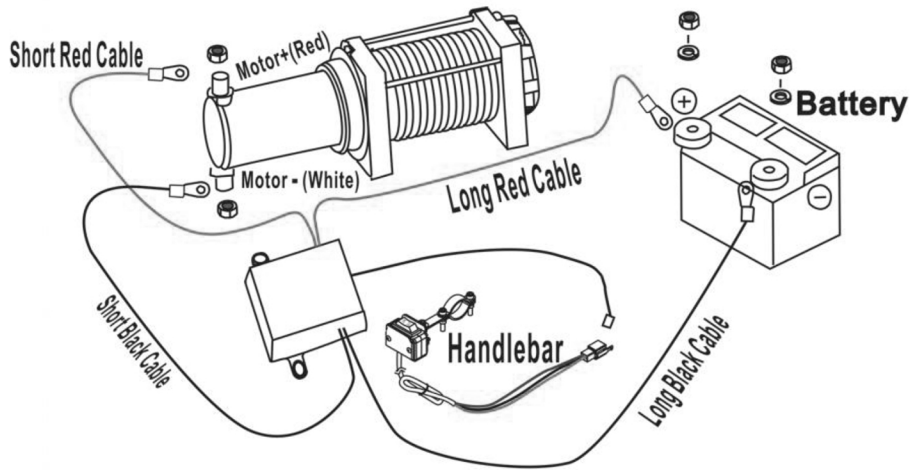

Model B: For the winch using the relay instead of the control box

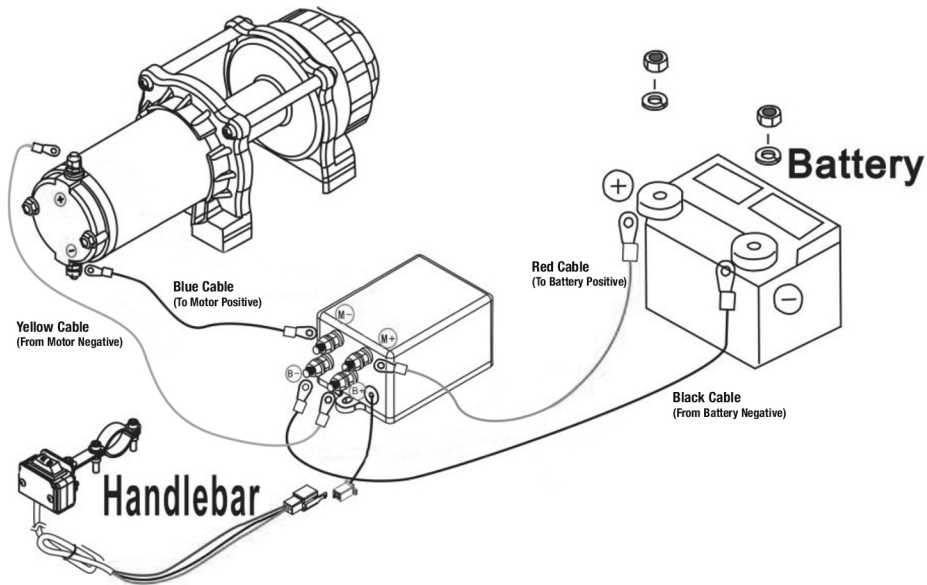

KNOW YOUR WIRELESS REMOTE

Before you begin, you should familiarize yourself with our Wireless Remote Control and each of its functions. Different remote has different operation, please find your wireless remote in below figures.

Model A: for wireless remote control with blue shell

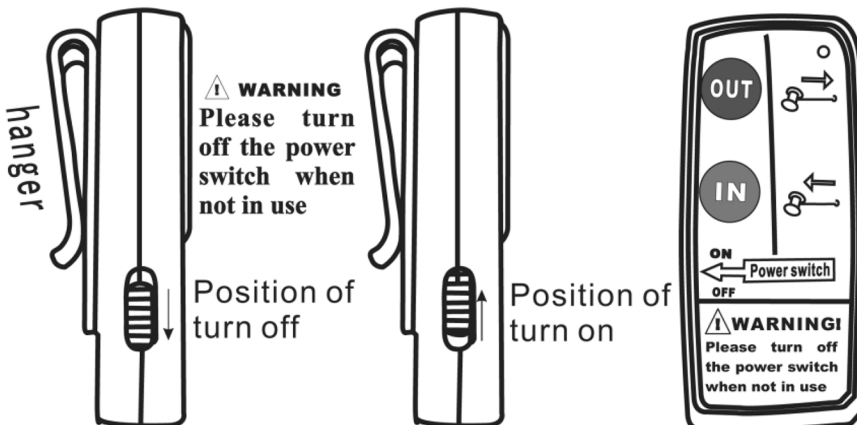

Note: battery is in back and keep away from water.

MAINTENANCE

Check	Before first operation	After each use	Every 90 days
Take time to fully read the Instructions. in order to understand your winch and its operations	√		
Check fasteners and make sure they are tight and to proper torque. Replace damaged fasteners.	√		√
Verify wiring to all components is correct and be certain that all connections are tight.	√		√
Verify there is no exposed/bare wiring. Terminals or cable insulation damage (chafing/cutting). Cover any exposures with terminal boots. Repair or replace damaged electrical cable.	√		√
Inspect rope for damage. Replace rope immediately if damaged.	√	√	√
Keep winch, rope and switch control free from contaminants. Use a clean rag or towel to remove any dirt and debris.		√	
Check and place/replace the battery of wireless remote control	√		√
Turn off the power after use	√		√

TROUBLE SHOOTING

Trouble Shooting/Error Conditions

When the winch fails to operate after several attempts, or if there is any fault operation while winching. Check followings.

Symptom	Possible cause	Remedy
Winch will not operate	Cut Circuit or loosing	Check battery cable
	The remote battery is critically low	Replace or charge battery
	Wireless signal strength is low	Decrease distance between remote control and winch.
	Damaged over load protector	Replace over load protector
	Loose connection of wirings	Checking all wirings
	Damaged or stuck solenoid	Replace solenoid
	Defective remote control	Check winch operation with an auxiliary switch
	Damaged motor or worn carbon brush	Replace motor or carbon brush
Motor runs in one direction	Winch control pack is Under water. Wireless signal will not transmit under water	Winch control pack needs to be above water to receive wireless signal.
	Broken wiring or bad connection	Reconnect or replace wiring
	Damaged or stuck solenoid	Replace solenoid
	Switch inoperative	Replace switch
Drum will not free spool	Dropt or lost wiring	Replace wiring and tighten
	Frees pool not dis-engaged	Disengaged frees pool
	Damaged brake or frees pool assembly	Replace brake or frees pool assembly
No brake	Damaged gear box	Replace gear box
	Damaged on inoperative pressed spring	Replace pressed spring
	Disengaged free spool	Engaged free spool
	Damaged inner gear plate	Replace inner gear plate
Winch runs opposite direction	Damaged inner gear	Replace inner gear
	Motor leads crossed	Reverse electric connections to motor
	Solenoid control crossed	Reverse black and red wires on solenoid
Motor runs extremely hot	Remote control or trigger switch crossed	Reverse electric connections
	Long period of operation	Stop operation and make it cool
	Over load	Reduce load
	Damaged or inoperative of brake	Replace or repair the brake

DISPOSAL

Batteries should not be disposed of in general household waste. Observe the local waste disposal regulations, details of which can be obtained from your local authority.

All electrical and electronic equipment must be disposed of separately from general household waste using the sites designated by local authorities.

If a product displays this symbol of a crossed-out wheelie bin, the product is subject to European Directive 2012/19/EC.

The appropriate disposal and separate collection of used equipment serve to prevent potential harm to the environment and health. They are a prerequisite for the re-use and recycling of used electrical and electronic equipment.

For further information on disposing of your used equipment, please contact your local authority or your refuse collection service.

CE DECLARATION OF CONFORMITY

We hereby declare that the machine described below complies with the relevant basic safety and health requirements of the EU Directives, both in its basic design and construction as well as in the version put into circulation by us. This declaration shall cease to be valid if the machine is modified without our prior approval.

The undersigned: Michael S McQuaide

as authorised by: Union Mart Ltd

Declares that

Description: 12V Electric Winch

Identification code: Rhino Winch 3000lb & 4500lb

Conforms to the following directives and standards:

- Machinery Directive 2006/42/EC
- EMC Directive 2004/108/EC
- RoHS Directive 2011/65/EU
- 2014/30/EU Electromagnetic Compatibility
- 2014/53/EU EC-RED Directive

--

- EN 61000-6-1:2007
- EN 61000-6-3:2007+A1:2011
- EN 61000-3-2:2006+A1:2009+A2:2009
- EN 61000-3-3:2008
- EN ISO 12100:2010
- EN 14492-1:2006+A1:2009

Notified body: ENTE CERTIFICAZIONE MACCHINE SRL

The technical documentation is kept by: Union Mart Ltd

Date: 01/01/17

Signed:



Michael S McQuaide

Managing Director

Name and address of the manufacturer:

Union Mart Ltd, Company No. 8384155. Registered address: Unit C3,
Deacon Trading Estate, Chicken Hall Ln, Eastleigh SO50 6RS, United Kingdom.

RHINO **WINCH Co**

ATV/UTV WINCH



Permanent Magnetic Motor
Gear train: 1-Stage Planetary
Gear Ratio: 153:1

- Winch 2000lbs
- Winch 2500lbs
- Winch 3000lbs
- Winch 3500lbs

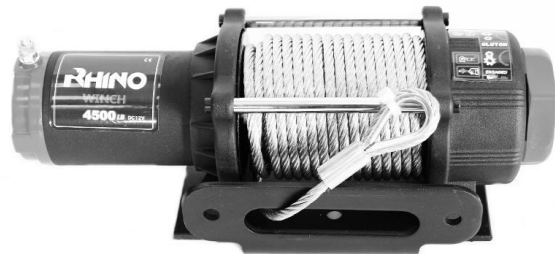

Permanent Magnetic Motor
Gear train: 2-Stage Planetary
Gear Ratio: 271:1

- Winch 3000lbs
- Winch 3500lbs
- Winch 4000lbs
- Winch 4500lbs



OPERATION MANUAL
READ IT BEFORE YOU USE IT