



BEYOND FIRE



PRODUCT SHOWN: INSPIRE 2000-1 (0802045)

Wood

Stoves, Inserts & Fireplaces.

**Premium quality
with a unique design**

WWW.OSBURN-MFG.COM





BEYOND FIRE

BEYOND... A SINGLE WORD THAT CAPTURES OUR PHILOSOPHY AND COMMITMENT AT OSBURN. THIS IS OUR SOURCE OF INSPIRATION. WHAT DOES "BEYOND" MEAN TO OSBURN?

BEYOND drives us forward when we look at products. We go beyond with what we do and with our interactions in life. It is more than building and selling products. It's no longer about just doing, but doing with a purpose, doing efficiently. It is about exceeding expectations. BEYOND... drives us to do better, to be more functional and achieve higher performance. We believe great products define a great appliance manufacturer. We are not afraid to take the lead or to stretch the boundaries. When you go BEYOND..., you simply go ahead; you look at the present and envision amazing things happening for the future.

*That's who we are, our philosophy. Our hope is to share it with you and we invite you to take the time to **discover how we go beyond.***





PRODUCT SHOWN: EVEREST II (0804016)



IMAGES IN THIS CATALOG
ARE FOR REFERENCE ONLY.



SUMMARY

WOOD STOVES

- 06 900
- 07 Soho
- 08 1700
- 09 Inspire 2000
- 10 2000
- 11 Matrix
- 12 2200
- 13 3300
- 14 3500
- 15 Features and technical data

WOOD INSERTS

- 17 1700
- 18 Inspire 2000
- 19 2000
- 20 Matrix
- 21 2200
- 22 Matrix 2700
- 23 3500
- 24 Features and technical data

ZERO CLEARANCE WOOD FIREPLACES

- 26 Stratford II
- 27 Everest II
- 28 Horizon
- 29 Features and technical data

- 32 MAXIMUM RECOMMENDED HEATING AREA

- 33 ACCESSORIES



CANADA
ONLY



DUPLEX Fireplace tool set (See page 33)

900

STOVE

OB00900

Smallest wood stove in the Osburn range, the 900 incorporates the features and technology of the largest stoves. Even with a combustion chamber of only 1.3 cubic feet, this appliance will keep you warm with a capacity of dry cordwood up to 40,000 BTU/h. The 900 accepts logs up to 17", making it an admired option in the small stove market.

OPTIONS

- > 100 CFM blower with variable speed control
- > Rigid firescreen
- > Quick connect thermdisc kit
- > 5"Ø fresh air intake kit
- > 5"Ø x 4' insulated flex pipe for fresh air intake kit
- > 5"Ø fresh air intake register with airtight damper

EMISSIONS: 4.0 g/h

RECOMMENDED HEATING AREA: 250 - 1,000 sq. ft.

MAXIMUM HEAT OUTPUT: 40,000 BTU/h

FIREBOX VOLUME: 1.3 cu. ft.

COMBUSTION TECHNOLOGY: Non-catalytic

CSA
B415.1-10

CANADA
ONLY



With creme enameled decorative side panels and two-sided pedestal.

SOHO

STOVE

OB01520

The Soho, a small stove with an ultra modern style, offers an exceptional view of the flames. It has an easy-to-operate door closure system that blends with the clean lines of the appliance. The Soho can be personalized to your taste and decor thanks to its side panels, available in different finishes. It also offers a choice of two practical and safe storage bases for your logs. This stove can be equipped with a blower and a thermodisc, in addition to being ready for connection to a fresh air inlet without any special adapter.

EMISSIONS: 4.0 g/h

RECOMMENDED HEATING AREA: 500 - 1,500 sq. ft.

MAXIMUM HEAT OUTPUT: 55,000 BTU/h

FIREBOX VOLUME: 1.7 cu. ft.

COMBUSTION TECHNOLOGY: Non-catalytic

REQUIRED ACCESSORIES

- > Black painted or creme or red enameled decorative side panels
- > Choice of regular pedestal or two-sided pedestal, with ash drawer

OPTIONS

- > 130 CFM blower with variable speed control (thermodisc included)
- > 5"Ø fresh air intake kit
- > 5"Ø fresh air intake register with airtight damper
- > 5"Ø x 4' insulated flex pipe for fresh air intake kit

Regular pedestal



Two-sided pedestal





PAPYRUS Fireplace tool set (See page 33)

1700

STOVE

OB01700

With brushed nickel cast iron straight legs and brushed nickel door overlay.

Designed to meet the needs of smaller spaces, the Osburn 1700 is a faithful copy of the recently redefined 2000 model. This firebox combines robustness and elegance to allow you to enjoy your heating experience with confidence. This unit is equipped with high-density bricks, a cast iron door, a built-in ash pan, a top heat deflector that redirects heat to the front of the unit, and side panels to reduce its clearances.

Choose your favorite version by customizing the unit to suit your style: refined door overlays, new leg designs, glass ash lip. Exceeding air quality regulations with emissions as low as 1.26 g/h, the Osburn 1700's efficiency will save you time and money.

REQUIRED ACCESSORIES

- > Black or brushed nickel door overlay
- > Choice of pedestal, black or brushed nickel cast iron legs with ash pan kit

OPTIONS

- > 130 CFM blower with variable speed control (thermodisc included)
- > 5"Ø fresh air intake kit
- > Rigid firescreen
- > Glass ash lip
- > 5"Ø fresh air intake register with airtight damper
- > 5"Ø x 4' insulated flex pipe for fresh air intake kit

EMISSIONS: 1.26 g/h

RECOMMENDED HEATING AREA: 500 - 1,800 sq. ft.

MAXIMUM HEAT OUTPUT: 65,000 BTU/h

FIREBOX VOLUME: 1.9 cu. ft.

COMBUSTION TECHNOLOGY: Non-catalytic

Choice of legs



Pedestal



See the complete technical data on pages 15 and 16.



INEO Fireplace tool set (See page 33)

With soapstone base.

**INSPIRE
2000**
STOVE

OB02042

The Inspire offers a style that will surely withstand variable trends with these pure lines of balanced proportions, allowing the brand Osburn to easily compare to European-style products. This more contemporary look is available on steel base, soapstone or even a minimalist base for those who prefer to place the unit directly on a non-combustible surface. Equipped with a 2.4 cubic feet firebox and an outside air intake, this unit will meet the requirements of domestic energy standards, not to mention that a mobile home installation is permitted. The Inspire largely meets EPA requirements with emissions as low as 1.54 g/h.

- EMISSIONS:** 1.54 g/h
- RECOMMENDED HEATING AREA:** 500 - 2,100 sq. ft.
- MAXIMUM HEAT OUTPUT:** 75,000 BTU/h
- FIREBOX VOLUME:** 2.4 cu. ft.
- COMBUSTION TECHNOLOGY:** Non-catalytic

REQUIRED ACCESSORIES

- > Decorative side panel kit
- > Minimalist, steel or soapstone base kit

OPTIONS

- > Moulded refractory panel kit
- > 130 CFM blower assembly with variable speed control
- > Quick connect thermodisc kit
- > 5"Ø fresh air intake register with airtight damper
- > 5"Ø fresh air intake kit
- > 5"Ø x 4' insulated flex pipe for fresh air intake kit

Moulded refractory panel kit (option)



Steel base kit



Minimalist steel base kit





INERO Fireplace tool set (See page 33)

2000

STOVE

OB02015

With black cast iron traditional legs and black door overlay.

The Osburn 2000 is one of the most popular unit in the Osburn family of wood stoves. Its cast-iron door, which features the distinctive lines you've come to expect from Osburn, gives it a look combining the contemporary and the traditional. With a 2.4 cubic foot firebox, the Osburn 2000 will delight the most serious of wood stove enthusiasts who want both style and heating power. Also equipped with a 130 CFM blower, the Osburn 2000 is the most sought-after model of the season!

REQUIRED ACCESSORIES

- > Black or brushed nickel door overlay
- > Choice of pedestal, black or brushed nickel cast iron legs with ash pan kit

OPTIONS

- > Rigid firescreen
- > Glass ash lip
- > Quick connect thermodisc kit
- > 5"Ø fresh air intake kit
- > 5"Ø fresh air intake register with airtight damper
- > 5"Ø x 4' insulated flex pipe for fresh air intake kit

EMISSIONS: 1.54 g/h

RECOMMENDED HEATING AREA: 500 - 2,100 sq. ft.

MAXIMUM HEAT OUTPUT: 75,000 BTU/h

FIREBOX VOLUME: 2.4 cu. ft.

COMBUSTION TECHNOLOGY: Non-catalytic

Choice of legs



Pedestal



See the complete technical data on pages 15 and 16.



GLASS HEARTH PAD
54" x 46 3/4" (See page 34)

With soapstone side panels and steel panel top.

MATRIX

STOVE

OB02032

The Matrix wood stove's clean and modern lines is sure to bring a European touch to any room. Inspired by a renowned Scandinavian look, the stove has optional soapstone panel top. These Canadian mined soapstones are also available as side panels kit that brings elegance to another level. Logs can be conveniently placed underneath the large firebox, making the Matrix not only stylish, but practical. The Matrix is equipped with a 130 CFM fan to ensure optimal heat distribution. Enjoy the comfort of winter more than ever before!

EMISSIONS: 1.54 g/h

RECOMMENDED HEATING AREA: 500 - 2,100 sq. ft.

MAXIMUM HEAT OUTPUT: 75,000 BTU/h

FIREBOX VOLUME: 2.4 cu. ft.

COMBUSTION TECHNOLOGY: Non-catalytic

REQUIRED ACCESSORIES

- > Soapstone or black painted panels kit
- > Soapstone or steel panel top

OPTIONS

- > 5"Ø air intake termination with clamps
- > Rigid firescreen
- > 5"Ø fresh air intake kit
- > 5"Ø fresh air intake register with airtight damper
- > 5"Ø x 4' insulated flex pipe for fresh air intake kit

Soapstone or steel panel top



Soapstone panels



Black painted panels



CANADA
ONLY



2200

STOVE

OB02211

With brushed nickel door overlay and brushed nickel louver and trivet.

The Osburn 2200 is a stove designed for intensive use and whose combustion chamber helps maintain uniform heat over a long period of time. It can also be fitted with a powerful premium 130 CFM blower. The large glass surface of its bay window ensures a breathtaking view of the fire from all angles. Combining business with pleasure, an expression that truly defines the Osburn 2200 stove.

REQUIRED ACCESSORIES

- > Black or brushed nickel door overlay
- > Black or brushed nickel louver and trivet

OPTIONS

- > 130 CFM blower
- > 5"Ø fresh air intake kit
- > 5"Ø fresh air intake register with airtight damper
- > 5"Ø x 4' insulated flex pipe for fresh air intake kit

EMISSIONS: 2.7 g/h

RECOMMENDED HEATING AREA: 800 - 2,000 sq. ft.

MAXIMUM HEAT OUTPUT: 70,000 BTU/h

FIREBOX VOLUME: 2.4 cu. ft.

COMBUSTION TECHNOLOGY: Non-catalytic

Black louver and trivet



Brushed nickel louver and trivet



See the complete technical data on pages 15 and 16.



INED Fireplace tool set (See page 33)

With black cast iron straight legs and brushed nickel door overlay.

The Osburn 3300 represents the essence of eco-friendly and efficient heating. With an emission rate of 0.95 g/h, this non-catalytic wood stove is among the cleanest on the market and represents an environmentally friendly source of energy. This north-south loading model will keep your family warm all night long, even in very cold weather, thanks to its power of 95,000 BTU/h. The design of the heater is flawless and enhanced by a set of high density bricks, a C-Cast baffle, a new cast iron door mold, an integrated ash drawer, a top heat deflector as well as decorative side panels.

- EMISSIONS:** 0.95 g/h
- RECOMMENDED HEATING AREA:** 900 - 2,300 sq. ft.
- MAXIMUM HEAT OUTPUT:** 90,000 BTU/h
- FIREBOX VOLUME:** 3.4 cu. ft.
- COMBUSTION TECHNOLOGY:** Non-catalytic

3300
STOVE

OB03300

REQUIRED ACCESSORIES

- > Black or brushed nickel door overlay
- > Choice of pedestal, black or brushed nickel cast iron legs with ash pan kit

OPTIONS

- > Rigid firescreen
- > Glass ash lip
- > 130 CFM blower with variable speed control (thermodisc included)
- > 5"Ø fresh air intake kit
- > 5"Ø fresh air intake register with airtight damper
- > 5"Ø x 4' insulated flex pipe for fresh air intake kit

Choice of legs



Pedestal





DUPLEX Fireplace tool set (See page 33)

3500

STOVE

OB03500

With brushed nickel door overlay.

Specifically designed to face the rigor of winter, the Osburn 3500 is an essential for any spacious home, especially if you live in a region with harsh weather conditions. Despite its emissions below 2.0 g/h, this wood stove utilizes a user-friendly, non-catalytic technology as well as a significant reduction of fuel consumption. The unit features a firebox that can hold up to 50 lb of cordwood, as well as a blower, a thermodisc and an airmate for optimal heat distribution and unparalleled comfort.

A choice of door overlay, a firescreen, a glass ash lip are available as options.

EMISSIONS: 1.32 g/h

RECOMMENDED HEATING AREA: 1,000 - 2,700 sq. ft.

MAXIMUM HEAT OUTPUT: 110,000 BTU/h

FIREBOX VOLUME: 3.5 cu. ft.

COMBUSTION TECHNOLOGY: Non-catalytic

REQUIRED ACCESSORIES

- > Black or brushed nickel door overlay

OPTIONS

- > 5"Ø fresh air intake kit for pedestal
- > Glass ash lip
- > Rigid firescreen



GENERAL FEATURES: WOOD STOVES



MODELS	900	Soho	1700	Inspire 2000	2000	Matrix	2200	3300	3500
Color	Metallic Black								
Combustion technology	Non-catalytic								
Maximum burn time (note 1)	5 hours	6 hours	6 hours	8 hours	8 hours	8 hours	8 hours	10 hours	10 hours
Recommended heating area (note 1)	250 to 1,000 sq. ft.	500 to 1,500 sq. ft.	500 to 1,800 sq. ft.	500 to 2,100 sq. ft.	500 to 2,100 sq. ft.	500 to 2,100 sq. ft.	800 to 2,000 sq. ft.	900 to 2,300 sq. ft.	1,000 to 2,700 sq. ft.
Maximum heat output - dry cordwood	40,000 BTU/h (11.7 kW)	55,000 BTU/h (16.1 kW)	65,000 BTU/h (19.0 kW)	75,000 BTU/h (22.0 kW)	75,000 BTU/h (22.0 kW)	75,000 BTU/h (22.0 kW)	70,000 BTU/h (20.5 kW)	90,000 BTU/h (26.4 kW)	110,000 BTU/h (32.2 kW)
Overall heat output rate (min. to max.)	10,800 BTU/h (3.2 kW) to 22,600 BTU/h (6.6 kW)	11,400 BTU/h (3.3 kW) to 25,400 BTU/h (7.4 kW)	15,650 BTU/h (4.6 kW) to 23,300 BTU/h (6.8 kW)	14,800 BTU/h (4.3 kW) to 28,600 BTU/h (8.38 kW)	14,800 BTU/h (4.3 kW) to 28,600 BTU/h (8.38 kW)	14,800 BTU/h (4.3 kW) to 28,600 BTU/h (8.38 kW)	11,700 BTU/h (3.4 kW) to 30,400 BTU/h (8.9 kW)	15,841 BTU/h (4.64 kW) to 57,041 BTU/h (16.72 kW)	18,200 BTU/h (5.3 kW) to 49,500 BTU/h (14.5 kW)
Door opening size (W x H)	15" x 7 5/8"	15 3/4" x 7 1/4"	17 1/4" x 8 3/4"	20" x 8 3/8"	17 1/2" x 9"	17 1/2" x 8 3/4"	19 1/8" x 8 7/8"	16" x 12"	19" x 9 7/8"
Firebox dimensions (W x H x D)	18 3/8" x 9 5/8" x 12 1/2"	18 1/8" x 12 1/4" x 13 1/2"	19 5/8" x 13 1/2" x 11 7/8"	21 1/4" x 11 15/16" x 17 11/16"	21" x 11 7/8" x 16 3/4"	21" x 11 7/8" x 16 1/2"	19 1/8" x 12 1/4" x 17 1/4"	19" x 14 1/8" x 21"	22 7/8" x 20 1/8" x 12 7/8"
Firebox volume	1.3 cu. ft.	1.7 cu. ft.	1.9 cu. ft.	2.4 cu. ft.	2.4 cu. ft.	2.4 cu. ft.	2.4 cu. ft.	3.4 cu. ft.	3.5 cu. ft.
Average particulate emissions rate	4.0 g/h	4.0 g/h	1.26 g/h	1.54 g/h	1.54 g/h	1.54 g/h	2.7 g/h	0.95 g/h	1.32 g/h
Glass viewing area (W x H)	13 3/8" x 7 3/4"	16 1/4" x 8 1/4"	15 3/4" x 9 3/8"	20 1/4" x 9 1/2"	17 1/8" x 10 1/4"	19 5/8" x 11 7/8"	26 1/4" x 10 3/8"	14 1/2" x 11 5/8"	18 7/8" x 11 3/4"
Door frame	Cast iron with logo	Steel	Cast iron	Cast iron	Cast iron	Cast iron	Steel	Cast iron	Cast iron
Maximum log length	17"	17"	18"	20"	20"	20"	18"	20"	22"
Optimum efficiency	78.2%	75.3%	78%	77%	77%	77%	75%	78%	77%
Mobile home approved (note 2)	No	Yes	Yes	Yes	Yes	Yes	Yes	Yes	Yes
Approved for an alcove installation	Yes	No	Yes	Yes	Yes	Yes	No	Yes	Yes
Flue spigot diameter	6"								
Glass type	Ceramic glass								
Adjustable handle	Yes								
Self-cleaning glass system	Yes								
Ash drawer with safety lid	No	Yes	Yes	Yes	Yes	Yes	Yes	Yes	Yes
Warranty	Lifetime, limited								
Test standard - Safety	According to ULC S627, UL 1482, UL 737, NFPA 211 and CSA B365 standards applicable in Canada and USA								
Test standard - Emissions / efficiency	CSA B415.1-10 EPA / CSA B415.1-10								

Note 1 : Recommended heating area and maximum burn time may vary subject to location in home, chimney draft, heat loss factors, climate, fuel type and other variables. The recommended heated area for a given appliance is defined by the manufacturer as its capacity to maintain a minimum acceptable temperature in the designated area in case of a power failure.

Note 2 : Refer to the install manual for mobile home installation details.

SPECIFIC FEATURES: WOOD STOVES

MODELS	900	Soho	1700	Inspire 2000	2000	Matrix	2200	3300	3500
Exterior dimensions and weight									
Height (pedestal)	N/A	32 7/8"	30 3/8"	36 9/16"	33 1/8"	36 7/8"	32 1/8"	34"	34 3/4"
Height (legs)	25 3/4"	N/A	29"	N/A	30 3/4"	N/A	N/A	32 1/4"	N/A
Width (pedestal/two-sided pedestal)	N/A	25 3/4" / 28 1/2"	24 7/8"	27 7/8"	27"	27 1/8"	26"	24 1/4"	28 7/8"
Width (legs)	22 7/8"	N/A	25 7/8"	N/A	27"	N/A	N/A	24 1/4"	N/A
Depth (pedestal)	N/A	20"	23 1/4"	24 15/16"	29"	25"	26 1/4"	30 1/2"	33 1/2"
Depth (legs)	21 7/8"	N/A	23 1/4"	N/A	29"	N/A	N/A	30 1/2"	N/A
Weight	273 lb (124 kg)	326 lb (148 kg)	331 lb (150 kg)	537 lb (244 kg)	390 lb (177 kg)	537 lb (244 kg)	399 lb (181 kg)	To come	524 lb (238 kg)
Clearances from unit to combustible materials (figures 1, 2, and 3)									
With single wall pipe (note 3)									
A— Sides (Canada / USA)	18"	16"	10"	17" / 16"	17" / 16"	17" / 16"	17"	12"	14"
B— Back (Canada / USA)	15 1/4" / 15"	15"	14 1/2" / 13"	14 1/2" / 11"	14 1/2" / 11"	14 1/2" / 11"	16"	14 1/2"	13 1/4" / 13"
C— Corner (Canada / USA)	10"	8 1/2" / 8"	12"	10"	10"	10"	10"	10"	7 1/4"
With double wall pipe									
A— Sides (Canada / USA)	18"	16"	10"	17" / 16"	17" / 16"	17" / 16"	20 1/2"	12"	14"
B— Back (Canada / USA)	10"	12"	6"	6"	6"	6"	5"	6"	6"
C— Corner (Canada / USA)	10"	6"	12"	7"	7"	7"	3"	8"	7"
D— Ceiling (Canada / USA) - (note 4)	68"	84"	84"	84"	84"	84"	84"	84"	84"
Blower	Optional	Optional	Optional	Optional	Included	Included	Optional	Optional	Included
Black door overlay	Included	Included	Optional	Included	Optional	N/A	Optional	Optional	Optional
Brushed nickel door overlay	N/A	N/A	Optional	N/A	Optional	N/A	Optional	Optional	Optional
Pedestal	N/A	Optional	Optional	Optional	Optional	Included	Included	Optional	Included
Black cast iron legs	Included	N/A	Optional	N/A	Optional	N/A	N/A	Optional	N/A
Brushed nickel cast iron legs	N/A	N/A	Optional	N/A	Optional	N/A	N/A	Optional	N/A
Black louver and trivet	N/A	N/A	N/A	N/A	N/A	N/A	N/A	N/A	N/A
Brushed nickel louver and trivet	N/A	N/A	N/A	N/A	N/A	N/A	N/A	N/A	N/A
Soapstone panel kit	N/A	N/A	N/A	N/A	N/A	N/A	Optional	N/A	N/A
Black decorative side panels	N/A	N/A	N/A	N/A	N/A	Optional	N/A	N/A	N/A
Red enameled decorative side panels	N/A	Optional	N/A	Included	N/A	Optional	N/A	N/A	N/A
Creame enameled decorative side panels	N/A	Optional	N/A	N/A	N/A	N/A	N/A	N/A	N/A
Soapstone panel top	N/A	Optional	N/A	N/A	N/A	N/A	N/A	N/A	N/A
Steel panel top	N/A	N/A	N/A	N/A	N/A	Optional	N/A	N/A	N/A

Note 3: Consult local code for minimum clearances of the single wall pipe itself to combustible materials. See also the venting manufacturer's instructions.
 Note 4: Measured from the base of the appliance. Some appliances have been tested with a low ceiling. Before setting up your unit, refer to the installation manual.

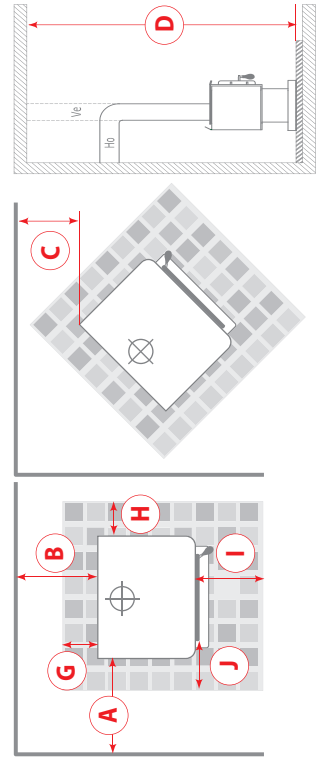

Figure 1

FLOOR PROTECTOR*		
	CANADA	USA
G	8" – Note **	N/A (Canada only)
H	8"	N/A (Canada only)
I	18" From door opening	16" From door opening
J	N/A (USA only)	8" From door opening

*Steel with a minimum thickness of 0.015" (0.38 mm) or ceramic tiles sealed together with grout. No protection is required if the unit is installed on a non-combustible floor (ex: concrete).

**The floor protection at the back of the stove is limited to the stove's required clearance if such clearance is smaller than 8 inches (203 mm).
 Technical data contained in this brochure are for reference only. Any installation must be done according to the data and drawings detailed in the owner's manual.

Figure 3

Figure 2



With brushed nickel door overlay and black faceplate trims.

1700
INSERT

OB01705

Like its larger counterpart Osburn 2000, the 1700 insert offers a revamped version of perfect size to provide ambiance and warmth. Give yourself a real haven of peace with an eco-friendly device whose average particle emission rate is remarkably low at 1.26 g/h!

Inside and out, this insert is engineered from high quality materials that put you at the center of a heating experience for many years: high-density bricks, cast iron door and quiet blower for increased durability. Discover the different options to customize the look of your appliance, available in black or brushed nickel: door overlays and faceplate trims.

A faceplate extension is included with this unit for installation in most hearths.

EMISSIONS: 1.26 g/h

RECOMMENDED HEATING AREA: 500 - 1,800 sq. ft.

MAXIMUM HEAT OUTPUT: 65,000 BTU/h

FIREBOX VOLUME: 1.9 cu. ft.

COMBUSTION TECHNOLOGY: Non-catalytic

REQUIRED ACCESSORIES

- > Black or brushed nickel cast iron door overlay
- > Faceplate kit
Regular (29" x 44") or
Large (32" x 50")
- > Black or brushed nickel
faceplate trims

OPTIONS

- > Offset liner adaptor
- > 5"Ø fresh air intake kit
- > Rigid firescreen

Black or brushed nickel faceplate trims



See the complete technical data on pages 24 and 25.



DUPLEX Fireplace tool set (See page 36)

With narrow U shape faceplate (3-sided).

INSPIRE 2000

INSERT

OB02045

REQUIRED ACCESSORIES

- > Narrow, narrow U shape or cuttable faceplate (32" x 50")

OPTIONS

- > Moulded refractory panel kit for insert
- > 5"Ø fresh air intake kit oval
- > 5"Ø fresh air intake register with airtight damper
- > Offset liner adaptor

This wood insert will bring an unmatched modernism to your decor, in addition to perfectly combining functionality and comfort. The impeccable lines display a timeless style while guaranteeing reliability and durability. The Inspire will charm you as much by its aesthetics as its 77% optimal performance. With its particle emission rate as low as 1.54 g/h and its high-performance combustion system, environmentalists have never been as happy with wood heating. The Inspire Collection celebrates our past and embraces our future as our team is committed more than ever to our industry's contribution to sustainability. A dream opportunity on the latest trends!

EMISSIONS: 1.54 g/h

RECOMMENDED HEATING AREA: 500 - 2,100 sq. ft.

MAXIMUM HEAT OUTPUT: 75,000 BTU/h

FIREBOX VOLUME: 2.4 cu. ft.

COMBUSTION TECHNOLOGY: Non-catalytic

Narrow faceplate
(4-sided)



Narrow U shaped faceplate
(3-sided)



Cuttable faceplate



See the complete technical data on pages 24 and 25.



PAPYRUS Fireplace tool set (See page 33)

With brushed nickel door overlay, regular faceplate kit and brushed nickel faceplate trims.

2000

INSERT

OB02016

With its 2.4 cubic foot firebox, the Osburn 2000 insert offers an alternative to the people who love its freestanding counterpart. The two models share the same high quality combustion properties and many of the same features. The Osburn 2000 comes with a standard high-power, heat-activated 144 CFM blower strategically positioned to redistribute the heat from the firebox into the room. The 2000 model is designed to receive an optional faceplate that can cover a masonry hearth up to 32 inches (81 cm) high and 50 inches (127 cm) wide. The door overlay is available in black or brushed nickel finishes. The faceplate trims are available in black or brushed nickel.

A faceplate extension is included with this unit for installation in most hearths.

EMISSIONS: 1.54 g/h

RECOMMENDED HEATING AREA: 500 - 2,100 sq. ft.

MAXIMUM HEAT OUTPUT: 75,000 BTU/h

FIREBOX VOLUME: 2.4 cu. ft.

COMBUSTION TECHNOLOGY: Non-catalytic

Black or brushed nickel faceplate trims



REQUIRED ACCESSORIES

- > Black or brushed nickel steel door overlay
- > Faceplate kit
Regular (29" x 44") or
Large (32" x 50")
- > Black or brushed nickel faceplate trims

OPTIONS

- > Cuttable faceplate (32" x 50")
- > Rigid firescreen
- > Heat shield for surround/shelf
- > 5"Ø fresh air intake kit oval
- > 5"Ø fresh air intake register with airtight damper
- > Offset liner adaptor

See the complete technical data on pages 24 and 25.





MATRIX

INSERT

With cast iron faceplate.

OB02028

OPTIONS

- > Bottom faceplate backing plate panels (44" x 6" / 50" x 6")
- > Faceplate backing plate (29" x 44" / 29" x 50")
- > Projection kit for insert 2" or 4"
- > Rigid firescreen
- > 5"Ø fresh air intake kit oval
- > 5"Ø fresh air intake register with airtight damper
- > Offset liner adaptor

The Matrix 2000 wood insert defines the new standards for contemporary look and performance. This appliance looks like a fireplace, but has all the advantages of an insert. Its faceplate and blower assembly were developed to allow a flush finish with the masonry fireplace. Cast iron was selected as the material of choice for this clean and modern unit. Installation into larger openings is facilitated by the use of an optional sheet metal backing plate. This insert will surely become the focal point of the room.

EMISSIONS: 1.54 g/h

RECOMMENDED HEATING AREA: 500 - 2,100 sq. ft.

MAXIMUM HEAT OUTPUT: 75,000 BTU/h

FIREBOX VOLUME: 2.4 cu. ft.

COMBUSTION TECHNOLOGY: Non-catalytic

EPA



With black cast iron door overlay, faceplate kit and trims.

2200

INSERT

OB02201

The 2200 insert, with its focus on efficiency and elegance, is an excellent example of Osburn's know-how. The bay window adds a touch of style to your fireplace and also improves its heat output. The 2200 insert is designed to offer a long Maximum burn time in low combustion mode, and can provide comfort for many hours – even overnight* – thanks among other things to its premium quality blower. The Osburn 2200 insert offers superior features in an eye-catching, high performance wood insert.

EMISSIONS: 2.7 g/h

RECOMMENDED HEATING AREA: 800 - 2,000 sq. ft.

MAXIMUM HEAT OUTPUT: 70,000 BTU/h

FIREBOX VOLUME: 2.3 cu. ft.

COMBUSTION TECHNOLOGY: Non-catalytic

REQUIRED ACCESSORIES

- > Black or brushed nickel cast iron door overlay
- > Faceplate kit
Regular (29" x 44"),
Medium (32" x 44") or
Large (32" x 50")
- > Black or brushed nickel
faceplate trims

OPTIONS

- > Offset liner adaptor

Black or brushed nickel faceplate trims



*See the complete technical data on pages 24 and 25.



INEO Fireplace tool set (See page 33)

MATRIX 2700

TAPPERED INSERT

OB02700

With brushed nickel door overlay.

Inspired by nature, the Matrix 2700 insert is a fusion of traditional style and technological innovation. Located in the heart of your living space, the generous viewing area of the Matrix 2700 will invite you to sit back, relax and take in the calm and warmth of its flames. Eco-savvy consumers will appreciate its efficient combustion, quality performance and classic beauty.

This unit comes standard with cast iron faceplate and heat activated blower. Customize the look of this non-catalytic appliance by choosing from a black or brushed nickel door overlay and firescreen.

REQUIRED ACCESSORIES

- > Black or brushed nickel cast iron door overlay

OPTIONS

- > Cuttable faceplate (32" x 50")
- > Projection kit for insert 2" or 4"
- > Firescreen door
- > 5"Ø fresh air intake kit

EMISSIONS: 1.14 g/h

RECOMMENDED HEATING AREA: 750 - 2,200 sq. ft.

MAXIMUM HEAT OUTPUT: 80,000 BTU/h

FIREBOX VOLUME: 2.5 cu. ft.

COMBUSTION TECHNOLOGY: Non-catalytic

Projection kit (option)

Tapered insert for easier installation in masonry hearth

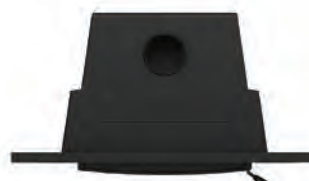

See the complete technical data on pages 24 and 25.



With brushed nickel door overlay, regular faceplate kit and brushed nickel faceplate trims.

The Osburn 3500 wood insert combines power, efficiency and safety. With its amazing features and sober lines that give way to one of the largest glass surfaces in its category, this insert will blend perfectly with the architecture of your home. Its flawless design reveals all the Canadian know-how in terms of alternative heating and will quickly become the house favorite. No harsh winter can resist it!

Because each house is unique, choose the door overlay, the faceplate and the trims that suit you!

EMISSIONS: 1.32 g/h

RECOMMENDED HEATING AREA: 1,000 - 2,700 sq. ft.

MAXIMUM HEAT OUTPUT: 110,000 BTU/h

FIREBOX VOLUME: 3.5 cu. ft.

COMBUSTION TECHNOLOGY: Non-catalytic

3500
INSERT

OB03510

REQUIRED ACCESSORIES

- > Black or brushed nickel cast iron door overlay
- > Faceplate kit
Medium (32" x 44") or
Large (32" x 50")
- > Black or brushed nickel faceplate trims

OPTIONS

- > Firescreen door

Black or brushed nickel faceplate trims



*See the complete technical data on pages 24 and 25.

GENERAL FEATURES: WOOD INSERTS



MODELS	1700 Insert	Inspire 2000 Insert	2000 Insert	Matrix Insert	2200 Insert <small>CANADA ONLY</small>	Matrix 2700 Tapered Insert	3500 Insert
Color	Metallic Black						
Combustion technology	Non-catalytic						
Maximum burn time (Note 1)	6 hours	8 hours	8 hours	8 hours	8 hours	8 hours	10 hours
Recommended heating area (Note 1)	500 to 1,800 sq. ft.	500 to 2,100 sq. ft.	500 to 2,100 sq. ft.	500 to 2,100 sq. ft.	800 to 2,000 sq. ft.	750 to 2,200 sq. ft.	1,000 to 2,700 sq. ft.
Maximum heat output - dry cordwood	65,000 BTU/h (19.0 kW)	75,000 BTU/h (22.0 kW)	75,000 BTU/h (22.0 kW)	75,000 BTU/h (22.0 kW)	70,000 BTU/h (20.5 kW)	80,000 BTU/h (23.44 kW)	110,000 BTU/h (26.4 kW)
Overall heat output rate (min. to max.)	15,650 BTU/h (4.6 kW) to 23,300 BTU/h (6.8 kW)	14,800 BTU/h (4.3 kW) to 28,600 BTU/h (8.3 kW)	14,800 BTU/h (4.34 kW) to 28,600 BTU/h (8.38 kW)	14,800 BTU/h (4.34 kW) to 28,600 BTU/h (8.38 kW)	11,700 BTU/h (3.4 kW) to 30,400 BTU/h (8.9 kW)	14,200 BTU/h (4.2 kW) to 48,200 BTU/h (14.1 kW)	18,200 BTU/h (5.3 kW) to 49,500 BTU/h (14.5 kW)
Door opening size (W x H)	17 1/4" x 8 3/4"	20" x 8 1/4"	17 1/2" x 9"	17 1/2" x 8 3/4"	19 1/8" x 9"	25 1/2" x 12 1/2"	19" x 9 7/8"
Firebox dimensions (W x H x D)	19 5/8" x 13 1/2" x 11 7/8"	21 1/4" x 11 7/8" x 16 7/8"	21" x 11 7/8" x 16 3/4"	21" x 11 7/8" x 16 3/4"	19 1/8" x 12 1/4" x 17 1/4"	20 1/2" x 12 1/8" x 12 3/4"	22 7/8" x 12 7/8" x 20 1/8"
Firebox volume	1.9 cu. ft.	2.5 cu. ft.	2.4 cu. ft.	2.4 cu. ft.	2.3 cu. ft.	2.5 cu. ft.	3.5 cu. ft.
Average particulate emissions rate	1.26 g/h	1.54 g/h	1.54 g/h	1.54 g/h	2.7 g/h	1.14 g/h	1.32 g/h
Glass viewing area (W x H)	15 3/4" x 9 3/8"	20 1/4" x 9 1/2"	17 1/8" x 10 1/4"	19 5/8" x 11 7/8"	26 1/4" x 10 3/8"	24 3/8" x 12 1/2"	18 7/8" x 11 3/4"
Door frame	Cast iron	Cast iron	Cast iron	Cast iron	Steel	Cast iron	Cast iron
Maximum log length	18"	20"	20"	20"	18"	20"	22"
Optimum efficiency	78%	77%	77%	77%	75%	73%	77%
Flue spigot diameter	6"						
Glass type	Ceramic glass						
Adjustable handle	Yes						
Self-cleaning glass system	Yes						
Warranty	Lifetime, limited						
Test standard - Safety	According to UL 1482, UL-737, ULC S628, NFPA 211 and CSA B365 applicable in Canada and the United States						
Test standard - Emissions / efficiency	EPA / CSA B415.1-10						

Note 1 : Recommended heating area and maximum burn time may vary subject to location in home, chimney draft, heat loss factors, climate, fuel type and other variables. The recommended heated area for a given appliance is defined by the manufacturer as its capacity to maintain a minimum acceptable temperature in the designated area in case of a power failure.

SPECIFIC FEATURES: WOOD INSERTS

MODELS

Exterior dimensions and weight

	1700 Insert	Inspire 2000 Insert	2000 Insert	Matrix Insert	2200 Insert	Matrix 2700 Tapered Insert	3500 Insert
Height	21 1/4"	25 1/8"	23 1/8"	25 1/8"	23 1/8"	30 1/8"	30 1/2"
Width	27 1/8"	30 1/8"	28 3/8"	36 1/8"	32 7/8"	43 5/8"	29"
Depth	22 3/8"	21 1/8"	26 3/8"	23 3/8"	28 3/8"	24 7/8"	25 3/4"
Weight	361 lb (164 kg)	484 lb (220 kg)	407 lb (185 kg)	484 lb (220 kg)	380 lb (172 kg)	535 lb (243kg)	540 lb (245 kg)

Clearances from unit to combustible materials (see figure 1)

A- Adjacent sidewall	16"	16"	16"	16"	17"	19"	19"
B- Combustible side surround	9"	9"	12"	9"	10"	9.5"	9"
C- Combustible top surround	27"	27"	20"	27"	14"	12"	27"
Reduced clearance with heat shield for combustible top surround	N/A	N/A	11"	6"-27"	N/A	N/A	N/A
D- Combustible mantle shelf dimension	6" 8" 10" 12"	6" 8" 10" 12"	8" 10" 12"	8" 10" 12"	6"-9 1/2" 10" 12"	6" 8" 10" 12"	6" 8" 10" 12"
E- Minimum clearance from a combustible mantle shelf	27" 27" 27"	27" 27" 27"	22" 24" 26"	27" 27"	22" 22 1/2" 22 1/2"	12" 12" 12"	12" 12" 12"
F, G, H- Minimum fireplace opening (Height x Width x Depth)	21 1/2" x 27 1/2" x 12 7/8"	24 5/8" x 29" x 20 3/4"	23 3/8" x 28 7/8" x 15 3/4"	23 3/8" x 28 7/8" x 19 5/8"	22 5/8" x 26 1/4" x 17 3/8"	25" x 31" x 21 1/2"	26 1/4" x 31" x 18 3/8"
I- Minimum floor protection in front of unit (CAN / USA)	18" / 16"	18" / 16"	18" / 16"	18" / 16"	22" **	18" / 16"	27"

Faceplate dimensions

Regular in cast iron (included)	N/A	N/A	N/A	25 1/8" x 36 1/8"	N/A	30 1/8" x 43 5/8"	N/A
Regular in steel	29" x 44"	N/A***	29" x 44"	N/A	29" x 44"	N/A	N/A
Medium in steel	N/A	N/A***	N/A	N/A	32" x 44"	N/A	32" x 44"
Large in steel	32" x 50"	N/A***	32" x 50"	N/A	32" x 50"	N/A	32" x 50"
Faceplate trim kit	Black or brushed nickel	N/A	Black or brushed nickel	N/A	Black or brushed nickel	Black or brushed nickel	Black or brushed nickel
Faceplate backing plate panels	N/A	N/A	N/A	29" x 44" / 29" x 50"	N/A	34" x 50"	N/A
Bottom faceplate backing plate panels	N/A	N/A	N/A	44" x 6" / 50" x 6"	N/A	N/A	N/A
Projection kit	N/A	N/A	N/A	2" or 4"	N/A	2" or 4"	N/A

Blower	Included	Included	Included	Included	Included	Included	Included
Black door overlay	Optional	N/A	Optional	N/A	Optional	Optional	Optional
Brushed nickel door overlay	Optional	N/A	Optional	N/A	Optional	Optional	Optional

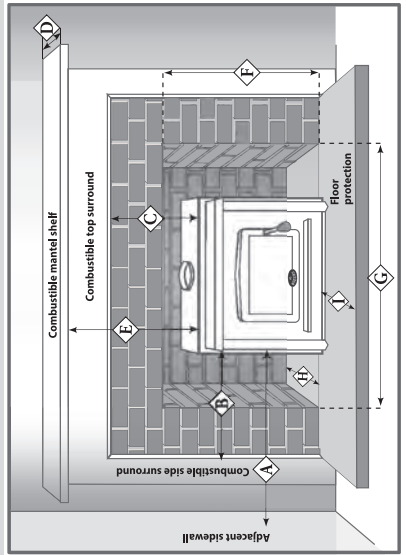

Figure 1

* The depth of the Matrix and Matrix 2700 may vary with the use of the projection kit. Consult the install manual for details.

** This model in particular must have 16" in front of the blower housing. This distance is included in the "I" measurement of the above table.

***The Inspire 2000 insert offers two choices of narrow faceplate and one cuttable faceplate.

Technical data & sizes contained in this brochure are for reference only. Any installation must be done according to the data and drawings detailed in the owner's manual.



STRATFORD II

FIREPLACE

OB04007

With brushed nickel cast iron door overlay and Prairie-style faceplate.

Let yourself be charmed by the timeless beauty of this non-catalytic wood fireplace, which performs particularly well and meets the EPA's most restrictive emissions standards.

The Stratford II offers you more, including a 2.5 cubic foot firebox that's easy to access through double-cast iron doors. This unit will impress you with its distinctive style and exceptional heating capacity. Several options are available, including a air distribution system for heating adjacent rooms (see page 31). With the Osburn Stratford II, there's a world of possibilities waiting for you!

REQUIRED ACCESSORIES

- > Black or brushed nickel cast iron door overlay
- > Traditional or Prairie style faceplate

OPTIONS

- > 4"Ø fresh air intake register with airtight damper
- > Firescreen door
- > Forced air kit
- > Hot air gravity kit

EMISSIONS: 1.14 g/h

RECOMMENDED HEATING AREA: 1,800 - 2,200 sq. ft.

MAXIMUM HEAT OUTPUT: 80,000 BTU/h

FIREBOX VOLUME: 2.5 cu. ft.

COMBUSTION TECHNOLOGY: Non-catalytic

Prairie style faceplate



Traditional style faceplate



See the complete technical data on pages 29 and 30.

EPA



With brushed nickel door overlay.

Attractive, efficient and particularly ecological, the all-new Everest II is the ultimate addition to revive any living space. The classicism of its faceplate offers straight lines that suits any decor to enhance your family reunions, moments of relaxation or romantic evenings, in addition to being your best ally during the cold winter weather.

Made with care in Quebec, this easy-to-use non-catalytic wood fireplace has retractable cast iron double doors that you can enhance with a firescreen door to fully experience the crackle of the wood fire. A black or brushed nickel overlay is available for your convenience.

EMISSIONS: 0.99 g/h

RECOMMENDED HEATING AREA: 750 - 2,500 sq. ft.

MAXIMUM HEAT OUTPUT: 85,000 BTU/h

FIREBOX VOLUME: 3.0 cu. ft.

COMBUSTION TECHNOLOGY: Non-catalytic

EVEREST II FIREPLACE

OB04015

REQUIRED ACCESSORIES

- > Black or brushed nickel cast iron door overlay

OPTIONS

- > Hot air gravity kit traditional style
- > Forced air kit
- > Firescreen door
- > 4"Ø fresh air intake register with airtight damper
- > 6"Ø x 25' insulated flex pipe for forced air kit
- > 4"Ø X 10' insulated flex pipe for fresh air intake kit

EPA



HORIZON FIREPLACE

OB04010

REQUIRED ACCESSORIES

- > Prairie-style faceplate
- > Classic moulded refractory brick panels

OPTIONS

- > Warm air circulation grille - Modern style
- > Forced air kit
- > Air diffuser kit 6" or 8"

This wood fireplace offers peace of mind due to the combination of energy efficiency and clean heating.

A simple solution; its clean design suits any type of decor.

Large fireplace. Behind its large glass door, the 4.28 cubic foot combustion chamber can hold an impressive 60 lbs of wood. **Low emissions.** This energy efficient fireplace complies with the EPA's clean-air standards (only 1.6 g/h of emissions). **High efficiency.** The Horizon fireplace is capable of heating large spaces and burns for 11 hours.

EMISSIONS: 1.6 g/h

RECOMMENDED HEATING AREA: 1,000 - 2,800 sq. ft.

MAXIMUM HEAT OUTPUT: 95,000 BTU/h

FIREBOX VOLUME: 4.28 cu. ft.

COMBUSTION TECHNOLOGY: Non-catalytic

Classic moulded refractory brick panels



See the complete technical data on pages 29 and 30.

TECHNICAL DATA: WOOD FIREPLACES

GENERAL FEATURES: WOOD FIREPLACES



MODELS	Stratford II	Everest II	Horizon
Color	Metallic black		
Combustion technology	Non-catalytic		
Maximum burn time (note 1)	8 hours	9 hours	11 hours
Recommended heating area (note 1)	1,800 to 2,200 sq. ft.*	750 to 2,500 sq. ft.*	1,000 to 2,800 sq. ft.*
Maximum heat output - dry cordwood	80,000 BTU/h (23.5 kW)	85,000 BTU/h (24.9 kW)	95,000 BTU/h (27.8 kW)
Overall heat output rate (min. to max.)	14,200 BTU/h (4.16 kW) to 48,200 BTU/h (14.1 kW)	18,057 BTU/h (5.29 kW) to 49,654 BTU/h (14.55kW)	16,610 BTU/h (4.9 kW) to 43,021 BTU/h (12.6 kW)
Door opening dimensions (W x H)	25 1/2" x 12 1/2"	20 3/4" x 10 1/4"	33" x 12 3/4"
Firebox dimensions (W x D x H)	20 1/2" x 12 3/4" x 12 1/8"	18 5/8" x 17" x 16 3/8"	25 3/8" x 17 7/8" x 17"
Firebox volume	2.5 cu. ft.	3.0 cu. ft.	4.28 cu. ft.
Average particulate emissions rate	1.14 g/h	0.99 g/h	1.6 g/h
Glass viewing area (W x H)	22 1/2" x 12 1/2"	18 3/4" x 11 3/8"	29 3/4" x 13 1/2"
Door frame	Double, glass with cast iron frame	Double, glass with cast iron frame	Double, glass with cast iron frame
Maximum log length	19"	18"	25"
Log positioning	East-west	East-west	East-west
Optimum efficiency	74 %	72 %	69.7 %
Mobile home approved	No	No	No
Flue spigot diameter	6"	6"	8"
Glass type	Ceramic glass		
Adjustable handle	Yes		
Self-cleaning glass system	Yes		
Warranty	Lifetime, limited		
Test standard - Safety	As per ULC-S610/UL 127 applicable in Canada and in the USA		
Test standard - Emissions / efficiency	EPA / CSA B415.1-10		

* With forced air distribution kit.

LISTED CHIMNEYS, MANUFACTURERS, BRANDS AND TYPES (SEE NOTE 2): WOOD FIREPLACES

MANUFACTURERS	BRANDS	TYPES	Stratford II	Everest II	Horizon
Olympia Chimney/SBI Venting Division	Ventis	1" Solid Pack	X	X	X
SBI Venting Division	Nexvent	1" Solid Pack	X	X	X
Olympia Chimney	Champion Chimney System	1" Solid Pack	X	X	X
American Metal	HSS	AC Triple Wall	X	X	X
American Metal	HS	AC Triple Wall	X	X	X
DuraVent	Dura Tech	1" Solid Pack	X	X	X
DuraVent	Dura Tech Canada DTC	1" Solid Pack	X	X	X
DuraVent	Dura Plus HTC	2" Solid Pack	X	X	X
DuraVent	Dura Plus	AC Triple Wall	X	X	X
DuraVent	Dura Tech Premium	2" Solid Pack	X	X	X
Metal Fab	Temp Guard	1" Solid Pack	X	X	X
Security Chimney	S-2100 +	2" Solid Pack	X	X	X
Selkirk	Super Vent 2100 (JM)	2" Solid Pack	X	X	X
Selkirk	CF Sentinel (CF)	2" Solid Pack	X	X	X
Selkirk	Super Pro 2100 (ALT)	2" Solid Pack	X	X	X

Note 1 : Recommended heating area and maximum burn time may vary subject to location in home, chimney draft, heat loss factors, climate, fuel type and other variables. The recommended heated area for a given appliance is defined by the manufacturer as its capacity to maintain a minimum acceptable temperature in the designated area in case of a power failure.

Note 2 : Specific components may be required depending on the chimney manufacturer.

Technical data contained in this brochure are for reference only. Any installation must be done according to the data and drawings detailed in the owner's manual.

TECHNICAL DATA: WOOD FIREPLACES

SPECIFIC FEATURES: WOOD FIREPLACES



MODELS	Stratford II	Everest II	Horizon	
Exterior dimensions (including spacers) and weight				
Height	40 5/8"	49 1/8"	43 3/8"	
Width	36 3/4"	41 3/4"	50 3/4"	
Depth	29 3/4"	29"	31 3/4"	
Weight	468 lb (212 kg)	To come	550 lb (250 kg)	
Clearances to combustible materials (see image below)				
A- Side wall	13"		21"	
B- Combustible mantle shelf dimension	6"	8"	10"	12"
Minimum clearance from a combustible mantle shelf (from the base of the fireplace)	58"	58"	58"	58"
C- Side mantle	8"		8"	
D- Minimum floor protection — front	16"		16"	
E- Minimum floor protection — width	41 3/8"		36 3/4"	
Back wall	0"		0"	
Sides	0"		0"	
Floor (under the fireplace)	0"		0"	
Ceiling (from the base of the fireplace)	80"		84"	
Black cast iron door overlay	Optional	Optional	Included	
Brushed nickel cast iron door overlay	Optional	Optional	N/A	
Traditional style faceplate	Optional	Included	N/A	
Prairie style faceplate	Optional	N/A	Optional	
Hot air gravity kit - traditional style (see page 31)	Optional	Optional	N/A	
Hot air gravity kit - modern with adjustable pipes (see page 31)	Optional	N/A	N/A	
Forced air kit (see page 31)	Optional	Optional	Optional	
Warm air circulation grille – modern style	N/A	N/A	Optional	
Rigid firescreen	Optional	Optional	N/A	

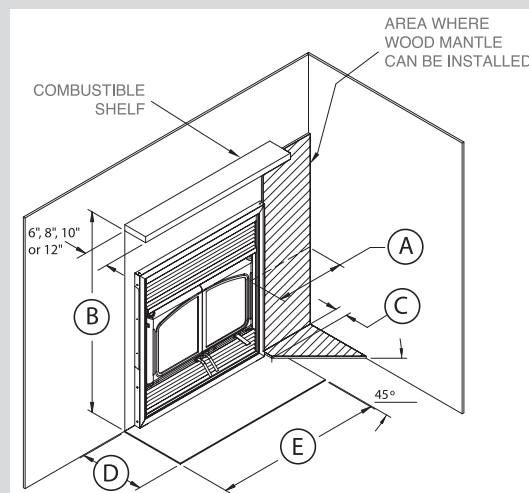

Technical data contained in this brochure are for reference only. Any installation must be done according to the data and drawings detailed in the owner's manual.

IT'S NOW TIME TO MANAGE HEAT DISTRIBUTION!

EPA certified wood fireplaces generate a lot of heat. For the most part, they generate too much for the room where they are located. Therefore, you need to manage the excess heat and send it where it is needed. To provide a solution, our research and development laboratory has designed the Heat Management System, an innovative technology that allows the recovery of the heat produced during combustion to redirect it into distribution ducts to heat other areas in your home.

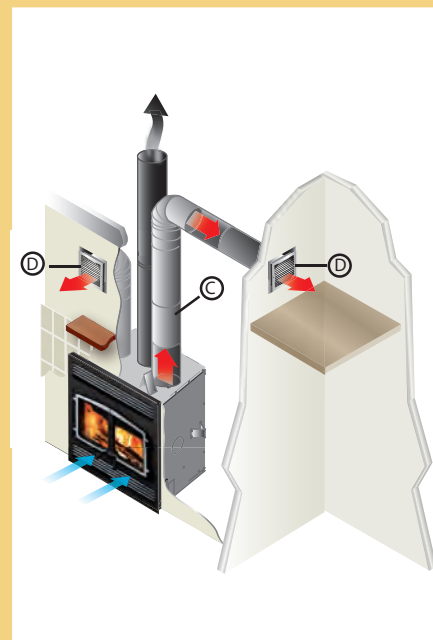
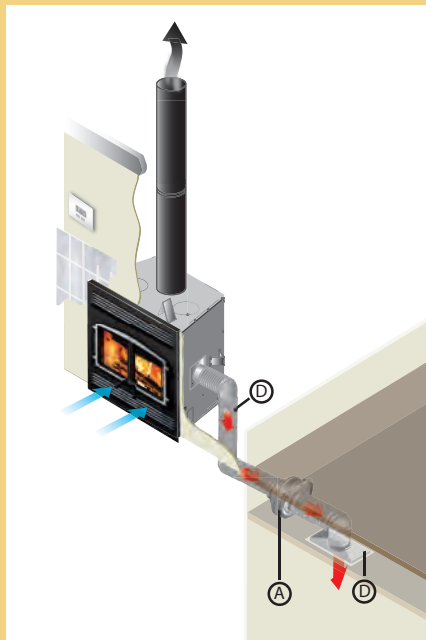
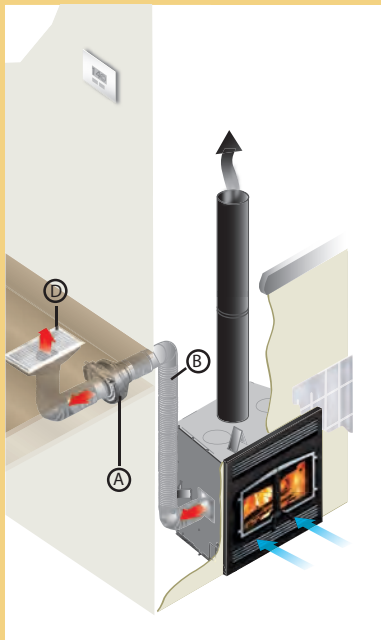

Forced air kit

This system allows you to manage the heat distribution automatically. Using a wall thermostat, you can select the temperature you want to maintain in the room where the fireplace is located. Once the thermostat is satisfied, the excess heat is redirected to another room up to 50 feet (15 m) away from the fireplace using a 300 CFM blower. That way, you can enjoy a nice fire in your living room without the discomfort of excess heat generated by your Osburn fireplace.

The system can also be used to supplement heat in a room remote from the fireplace. For this type of application, the thermostat needs to be positioned in the desired room and programmed with the temperature to be maintained. The system, now in “heat mode”, will activate the blower as long as the temperature in the remote room is not achieved and that the fireplace has enough heat to distribute.

Osburn also offers you another way to distribute excess heat into your home with the help of a hot air gravity kit.

Hot air gravity kit

The hot air gravity kit allows you to bring hot air into the same room as the fireplace, in adjacent rooms, or up-stairs at a maximum distance of 10' (3 m). The minimum height of the hot air duct must be 68" (1.7 m) measured from the base of the fireplace to the top of the hot air register.

Suggested installation : A) 300 CFM blower B) Hot air flexible pipe C) Hot air rigid pipe D) Air register.

The information contained in this page is for information purposes only. For a detailed part list of kits content, please refer to the owner's manuals.

For more details about the installation requirement of the **forced air kit** or the **hot air gravity kit**, visit:
www.osburn-mfg.com/en/service-support/heat-distribution-system

MAXIMUM RECOMMENDED HEATING AREA

IN SQUARE FEET BY CLIMATE ZONE

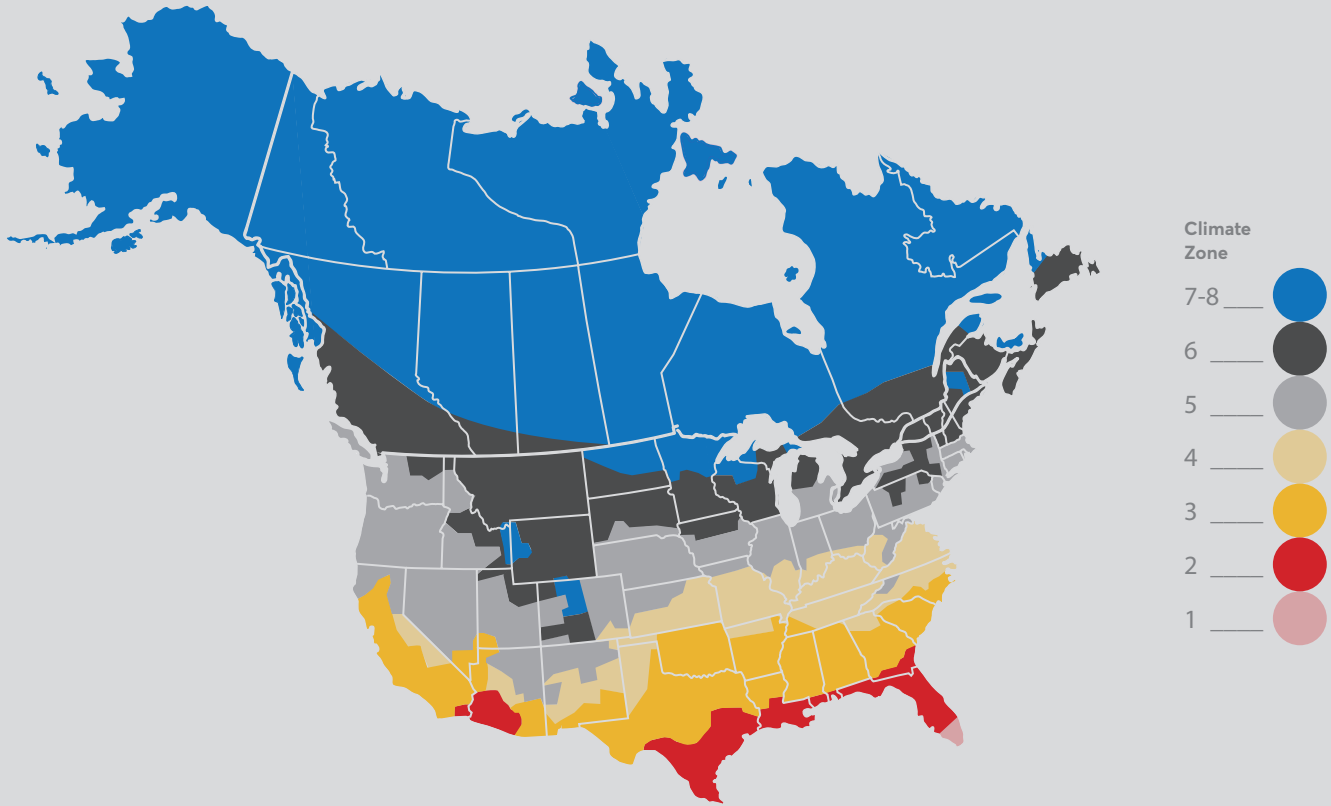

WOOD STOVE MODELS	Zone 1-2	Zone 3	Zone 4	Zone 5	Zone 6	Zone 7-8
900	1,600	1,450	1,300	1,150	1,000	700
Soho	2,100	1,950	1,800	1,650	1,500	1,200
1700	2,400	2,250	2,100	1,950	1,800	1,500
2200	2,800	2,600	2,400	2,200	2,000	1,600
2000	2,900	2,700	2,500	2,300	2,100	1,700
Inspire 2000	2,900	2,700	2,500	2,300	2,100	1,700
Matrix	2,900	2,700	2,500	2,300	2,100	1,700
3300	3,100	2,900	2,700	2,500	2,300	1,900
3500	3,500	3,300	3,100	2,900	2,700	2,300
WOOD INSERT MODELS	Zone 1-2	Zone 3	Zone 4	Zone 5	Zone 6	Zone 7-8
1700	2,400	2,250	2,100	1,950	1,800	1,500
2000	2,900	2,700	2,500	2,300	2,100	1,700
2200	2,800	2,600	2,400	2,200	2,000	1,600
Matrix	2,900	2,700	2,500	2,300	2,100	1,700
Inspire 2000	2,900	2,700	2,500	2,300	2,100	1,700
Matrix 2700	3,000	2,800	2,600	2,400	2,200	1,800
FIREPLACE MODELS	Zone 1-2	Zone 3	Zone 4	Zone 5	Zone 6	Zone 7-8
Stratford II	3,000	2,800	2,600	2,400	2,200	1,800
Everest II	3,300	3,100	2,900	2,700	2,500	2,100
Horizon	3,600	3,400	3,200	3,000	2,800	2,400

ACCESSORIES

FIREPLACE TOOL SETS



CODE: # AC02620

DUPLEX

Contains four instruments: poker, broom, shovel and scraper. The clean lines and combination of steel and wood construction make a strong contemporary design statement.

Height of accessories:
26 3/16" (66 cm)

Made in Canada.



CODE: # AC02621

INEO

Contains four instruments: poker, broom, shovel and clamp. The clean lines and simplicity make a strong contemporary design statement.

Height of accessories:
19 1/2" (50 cm)

Made in France.



CODE: # AC02622

PAPYRUS

Contains four instruments: poker, broom, shovel and clamp. The dramatic use of steel makes a strong contemporary design statement.

Height of accessories:
19 1/2" (50 cm)
Base diameter:
7 1/2" (19 cm)

Made in France.



CODE: # AC02350

EQUISS

Made of high quality steel. Its integrated handles make handling easier. Two identical parts that intersect easily. Assembly and disassembly in seconds for compact storage.

Height: 15 1/4" (38 cm)
Length: 24 1/4" (61 cm)
Depth: 13" (33 cm)
Weight: 28 1/2 lb (13 kg)

Made in Canada.



CODE: # AC02628

NORDIK

Contains four accessories: poker, broom, shovel and tongs. Its wooden base and steel structure gives it an industrial look, perfect for contemporary or rustic spaces.

Support height:
21 7/8" (53 cm)
Length:
9 1/2" (24 cm)
Depth:
4 3/4" (12 cm)

Made in France.



CODE: # AC02629

PETALE

Contains four accessories: poker, broom, shovel and tongs. A nice option for those who want to camouflage tools for a more decorative look.

Height:
20" (51 cm)
Diameter:
7 1/2" (19 cm)

Made in France.



CODE: # AC02630

FOREST

Contains four accessories: poker, broom, shovel and tongs. A beautiful addition to your rustic decor, both for the cottage and at home, thanks to its forest relief.

Height:
20" (51 cm)
Diameter:
7 1/2" (19 cm)

Made in France.



CODE: # AC02631

SPEKTRA

Contains four accessories: poker, broom, shovel and tongs. You will appreciate its futuristic look for a unique atmosphere.

Height:
20" (51 cm)
Diameter:
7 1/2" (19 cm)

Made in France.

ACCESSORIES

OPTIONS



GLASS HEARTH PAD PROTECTION

This light-colored tempered glass hearth pad is particularly resistant to shocks. This glass plate is a safe and durable choice for your fireplace and will add elegance to your decor. Its manufacture is precise and neat: polished edges and non-cutting corners.

Four sizes:

- 54" x 46 3/4" (AC02703)
- 44" x 36" (AC02704)
- 50" x 18" (AC02760)
- 70" x 20" (AC02761)

Thickness: 10 mm



NON-COMBUSTIBLE MANTELS

Incredibly realistic wood-like detailing.
Two shades: washed cedar and tavern brown.
Two lengths: 60" and 72"
Height: 8"
Depth: 8"

- 60" washed cedar (AC02780)
- 72" washed cedar (AC02781)
- 60" tavern brown (AC02782)
- 72" tavern brown (AC02783)



CERTIFIED MODULAR HEAT SHIELD

A simple, attractive, and safe solution to effectively reduce wall clearances, and ensure maximum protection of the floor. Easy assembly, the modular system will blend in with any room decor. Powder coated steel panels offering superior durability and quality.

*Check local codes for approved alternatives. Any installation must be done according to the data and drawings detailed in the owner's manual.

OSBURN LIMITED LIFETIME WARRANTY

on SCHOTT ROBAX® Ceramic Glass



**SCHOTT
ROBAX®**

SCHOTT ROBAX® glass-ceramic panels combine high quality, thermal resistance, and one-of-a-kind material properties to offer pure fireside pleasure with an unobstructed and safe view of the fire. 95% made of quartz sand and two other natural raw materials, SCHOTT ROBAX® glass-ceramic panels boast extremely low thermal expansion. These panels are especially heat resistant and can withstand blazing short-term temperatures, as well as substantial temperature fluctuations and thermal shocks. Given their high IR transmission values, SCHOTT ROBAX® glass-ceramic panels also allow for the heat produced inside the fire-box to be more efficiently transferred through the glass.

As the quality of the components of our appliances is a priority at Osburn, we have chosen the SCHOTT ROBAX® solution for our appliances and offer a limited lifetime warranty on ceramic glass.

**FOR MORE DETAILS ON OUR PRODUCT WARRANTY:
osburn-mfg.com/en/warranty**

WHY choose



C-CAST baffle

- Space shuttle **QUALITY**
- Resistant up to **2800°F**

RUGGED steel

- **5/16"** top thickness
- **EXTENDED HEAT** radiation

CERAMIC glass

- **ALL AROUND** solid glass retainer system
- **LIFETIME WARRANTY** even on accidental breakage

HIGH DENSITY firebricks

- **Impact RESISTANT**
- **Superior HEAT RELEASING** capabilities

MADE IN CANADA
NORTH AMERICAN STEEL



PUB047A



7 73388 99521 2