

## STAINLESS STEEL OUTDOOR WALL MOUNT FIREPLACE

**Models: OUT-16NG, OUT-16LP, OUT-26NG, OUT-26-LP, OUT-46NG, OUT-46LP**

### INSTALLATION AND OPERATION MANUAL



We recommend that our products be installed and serviced by professionals who are certified in the U.S. by NFI (National Fireplace Institute).

(TWENTY6 SHOWN)

Report # F19-220

Complies with

ANSI Z21.97-2014/CSA 2.41-2014 "Outdoor Decorative Gas Appliances",  
CGA 2.17-M91(R2014) "Gas Fired Appliances for Use at High Altitudes"

### DANGER

If you smell gas:

1. Shut off gas to appliance.
2. Extinguish any open flame.
3. If odor continues, keep away from the appliance and immediately call your gas supplier or fire department.

### WARNING

Improper installation, adjustment, alteration, service or maintenance can cause injury or property damage. Read the installation, operating and maintenance instructions thoroughly before installing or servicing this equipment.

### WARNING

1. Do not store or use gasoline or other flammable vapors and liquids in the vicinity of this or any other appliance.
2. An LP-cylinder not connected for use shall not be stored in the vicinity of this or any other appliance.

### DANGER



### CARBON MONOXIDE HAZARD

This appliance can produce carbon monoxide which has no odor. Using it in an enclosed space can kill you. Never use this appliance in an enclosed space as a camper, tent, car or home

## WARNING: For Outdoor Use Only

INSTALLER: Leave this manual with the appliance.  
CONSUMER: Retain this manual for future reference.

# TABLE OF CONTENTS

Local Codes .....	4
Fireplace Specifications .....	5
Clearance to Combustibles .....	7
Installation Requirements.....	9
Assembly & Installation.....	12
Gas Connection .....	16
Checking Gas Pressure.....	16
Placing Glass Panel and Media Tray.....	18
Lighting Instructions .....	21
Operating Instructions .....	22
To Turn Off Gas to Appliance .....	28
Replacement Parts List.....	29
Control Schematic .....	30
Installation Record.....	31
Warranty Information .....	Back Cover

# SAFETY INFORMATION

**⚠ WARNING:** This product contains and/or generates chemicals known to the state of California to cause cancer or birth defects or other reproductive harm.

**IMPORTANT:** Read this owner's manual carefully and completely before trying to assemble, operate or service this heater. Improper use of this heater can cause serious injury or death from burns, fire, explosion, electrical shock and carbon monoxide poisoning.

**⚠ DANGER:** Carbon monoxide poisoning may lead to death!

**Carbon Monoxide Poisoning:** Early signs of carbon monoxide poisoning resemble the flu, with headaches, dizziness or nausea. If you have these signs, the heater may not be working properly. **Get fresh air at once!** Have heater serviced. Some people are more affected by carbon monoxide than others. These include pregnant women, people with heart or lung disease or anemia, those under the influence of alcohol and those at high altitudes.

**Natural and Propane/LP Gas:** Natural and propane/LP gases are odorless. An odor-making agent is added to the gas. The odor helps you detect a gas leak. However, the odor added to the gas can fade. Gas may be present even though no odor exists.

Make certain you read and understand all warnings. Keep this manual for reference. It is your guide to safe and proper operation of this heater.

**⚠ WARNING:** Any modification to this heater or its controls can be dangerous.

**⚠ WARNING:** Do not use a blower insert, heat exchanger insert or other accessory not approved for use with this heater.

**⚠ WARNING:** Do not allow fans to blow directly into the fireplace. Avoid any drafts that alter burner flame patterns. Ceiling fans can create drafts that alter burner flame patterns. Altered burner patterns can cause sooting.

Due to high temperatures, the appliance should be located out of traffic and away from furniture and draperies.

Do not place clothing or other flammable material on or near the appliance. Never place any objects on the heater.

Fireplace front becomes very hot when the fireplace is in operation. Keep children and adults away from hot surfaces to avoid burns or clothing ignition. Fire-place will remain hot for a time after shutdown. Allow surfaces to cool before touching.

Carefully supervise young children when they are in the room with fireplace. When using the optional hand-held remote accessory, keep selector switch inside firebox in the OFF position to prevent children from turning on burners with remote.

Keep the appliance area clear and free from combustible materials, gasoline and other flammable vapors and liquids.

# SAFETY INFORMATION

1. This appliance is only for use with the type of gas indicated on the rating plate. This appliance is not convertible for use with other gases.
2. If you smell gas
  - shut off gas supply
  - do not try to light any appliance
  - do not touch any electrical switch; do not use any phone in your building
  - immediately call your gas supplier from a neighbor's phone. Follow the gas supplier's instructions
  - if you cannot reach your gas supplier, call the fire department
3. This fireplace shall not be installed in any enclosed space. Do not use this fireplace as a wood-burning fireplace.
4. Children and adults should be alerted to the hazards of high surface temperatures and should stay away to avoid burns or clothing ignition.

**Keep the appliance area clear and free from combustible materials, gasoline and other flammable vapors and liquids.**

5. To prevent the creation of soot, follow the instructions in *Cleaning and Maintenance* section.
7. Before using furniture polish, wax, carpet cleaner or similar products, turn heater off. If heated, the vapors from these products may create a white powder residue within burner box or on adjacent walls or furniture.
8. This fireplace needs fresh air ventilation to run properly.
9. Do not run fireplace
  - where flammable liquids or vapors are used or stored
  - under dusty conditions
10. Do not use this fireplace to cook food or burn paper or other objects.

11. Do not use fireplace if any part has been under water. Immediately call a qualified service technician to inspect the fireplace and to replace any part of the control system and any gas control which has been under water.



12. Turn fireplace off and let cool before servicing. Only a qualified service person should service and repair fireplace.
13. Operating fireplace above elevations of 4,500 feet could cause pilot outage.
14. Provide adequate clearances around air openings.

## LOCAL CODES

Install and use fireplace with care. When an appliance is for connection to a fixed piping system, the installation must conform with local codes, or in the absence of local codes, with *The National Fuel Gas Code ANSI Z223.1/NFPA 54\**, *International Fuel Gas Code*, *Natural Gas and Propane Installation Code*, *CSA B149.1*, or *Propane Storage and Handling Code*, *B149.2*, as applicable.

**Note: Appliance for use only with permanently mounted tanks and fixed piping.**

\*Available from:

American National Standards Institute, Inc.  
1430 Broadway  
New York, NY 10018

National Fire Protection Association, Inc.  
Batterymarch Park  
Quincy, MA 02269

**State of Massachusetts:** The installation must be made by a licensed plumber or gas fitter in the Commonwealth of Massachusetts.

Sellers of unvented propane or natural gas-fired supplemental room heaters shall provide to each purchaser a copy of 527 CMR 30 upon sale of the unit.

Vent-free gas products are prohibited for bedroom and bathroom installation in the Commonwealth of Massachusetts.

# SPECIFICATIONS

## NATURAL GAS SPECIFICATION CHART

<u>INPUT</u>	ONE <sup>6</sup> OUTDOOR	TWENTY <sup>6</sup> OUTDOOR	FORTY <sup>6</sup> OUTDOOR
Input Rating BTU/Hr.	12,150	21,500	31,500
Min. Input BTU/Hr.	7,500	14,900	22,400
Orifice Size - DMS	#49	#46	#38
<u>GAS SUPPLY</u>	NG	NG	NG
Manifold Pressure (High)	3.9”w.c. / 1.2kPa	3.9”w.c. / 1.2kPa	3.9”w.c. / 1.0kPa
Manifold Pressure (Low)	2.2”w.c. / 0.75kPa	1.25”w.c. / 0.57kPa	1.9”w.c. / 0.52kPa
Min. Supply Pressure	5.5”w.c. / 1.4kPa	5.5”w.c. / 1.4kPa	5.5”w.c. / 1.4kPa
Max. Supply Pressure	10.0”w.c. / 2.5kPa	10.0”w.c. / 2.5kPa	10.0”w.c. / 2.5kPa

## PROPANE (LP) SPECIFICATION CHART

<u>INPUT</u>	ONE <sup>6</sup> OUTDOOR	TWENTY <sup>6</sup> OUTDOOR	FORTY <sup>6</sup> OUTDOOR
Input Rating BTU/Hr.	12,600	21,300	31,900
Min. Input BTU/Hr.	7,600	13,300	21,100
Orifice Size - DMS	#60	#56	#53
<u>GAS SUPPLY</u>	LPG	LPG	LPG
Manifold Pressure (High)	10.0”w.c. / 2.5kPa	10.0”w.c. / 2.5kPa	10.0”w.c. / 2.5kPa
Manifold Pressure (Low)	3.1”w.c. / 1.0kPa	4.25”w.c. / 0.75kPa	4.7”w.c. / 1.2kPa
Min. Supply Pressure	11.0”w.c. / 2.8kPa	11.0”w.c. / 2.8kPa	11.0”w.c. / 2.8kPa
Max. Supply Pressure	13.0”w.c. / 3.3kPa	13.0”w.c. / 3.3kPa	13.0”w.c. / 3.3kPa

# SPECIFICATIONS

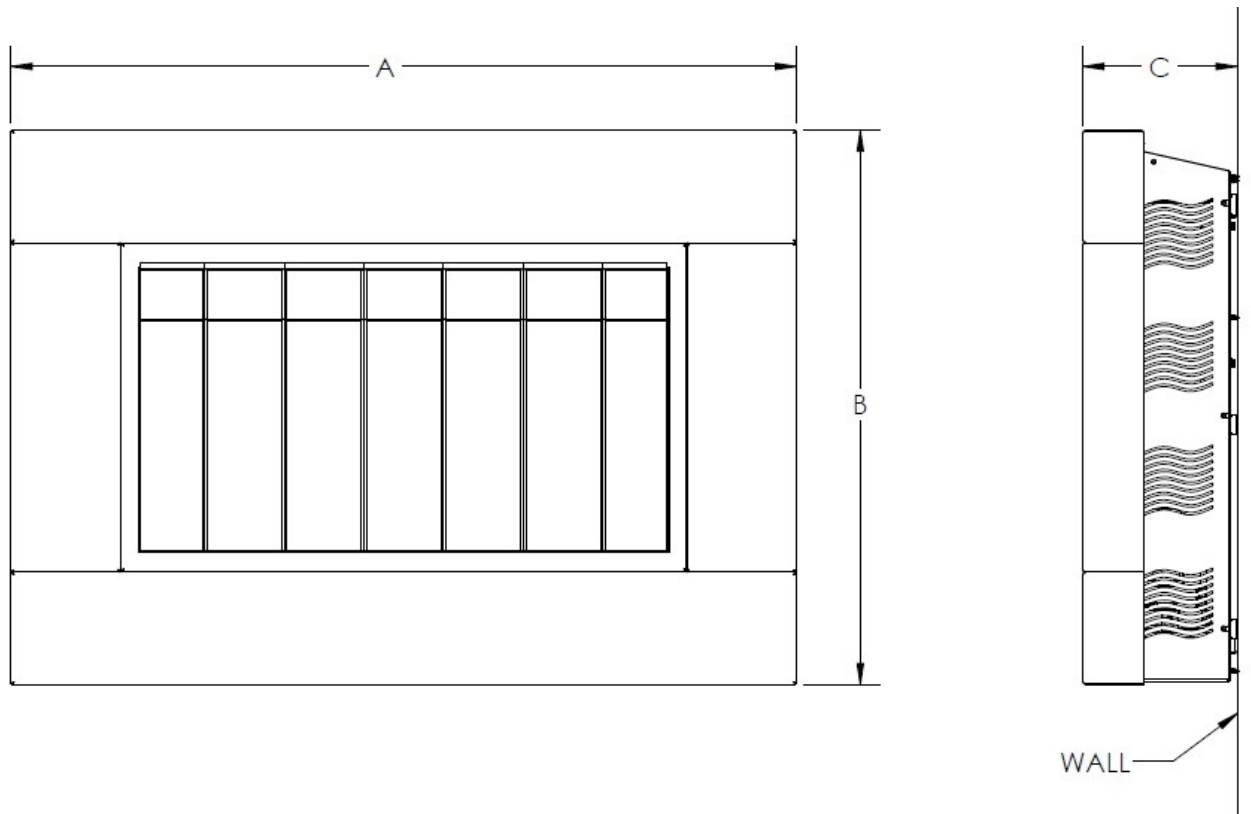

	ONE <sup>6</sup> OUTDOOR	TWENTY <sup>6</sup> OUTDOOR	FORTY <sup>6</sup> OUTDOOR
Dimension "A"	23 1/2"	38 1/4"	58 3/8"
Dimension "B"	30"	27 1/4"	25 1/4"
Dimension "C"	7 5/8"	7 5/8"	8"



**SOLID FUELS SHALL NOT BE BURNED IN THIS APPLIANCE**

# SPECIFICATIONS

<b>MINIMUM CLEARANCES TO COMBUSTIBLES</b>			
	ONE6 VF	TWENTY6 VF	FORTY6 VF
Fireplace to Left Side Wall - (Dimension "A")	6"	6"	6"
Fireplace to Right Side Wall - (Dimension "A")	6"	6"	6"
Fireplace to Corner Side Wall - (Dimension "B")	6"	6"	6" *
Above Fireplace (Dimension "C")	12"	12"	12"
Fireplace to Floor (Dimension "D")	3" **	3" **	3" **
Fireplace to Rear Wall	0" ***	0" ***	0" ***
Air Space Behind Mounting Plate (Dimension "E")	5/16"	5/16"	3/8"

\*Optional Corner Kit not available for the FORTY6 VF

\*\*The minimum required clearance to be maintained from the fireplace to combustible flooring is measured from the top surface of carpeting, tile, etc.

\*\*\*Mounting plate bosses contact the wall.

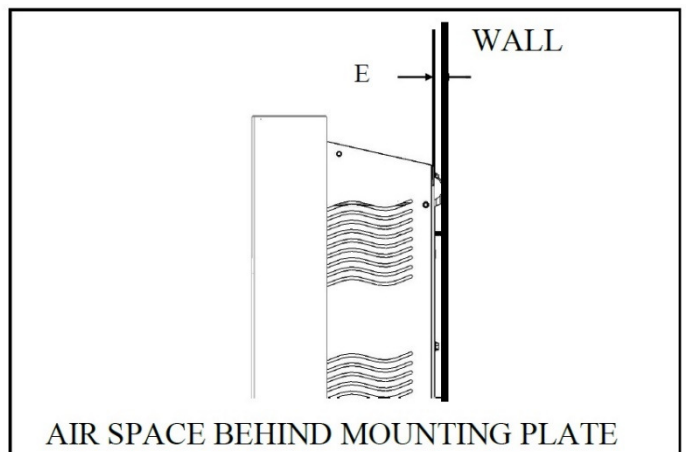
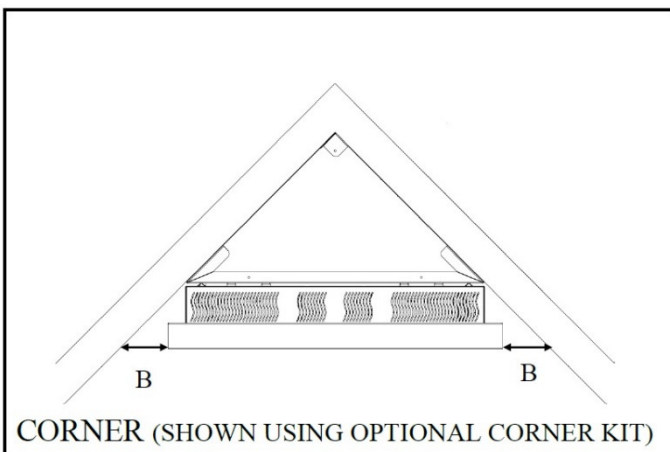
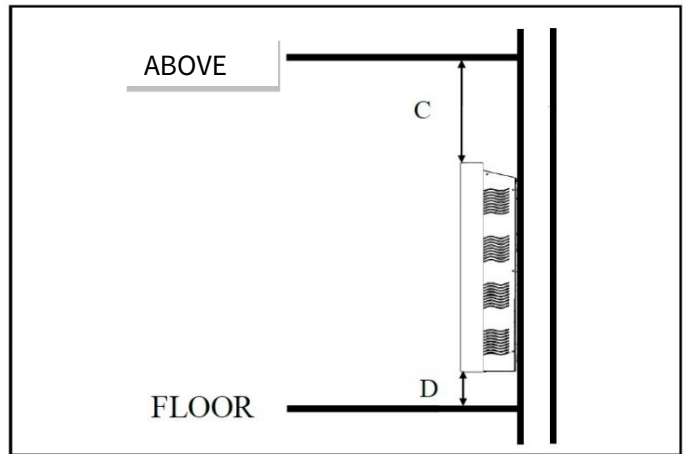
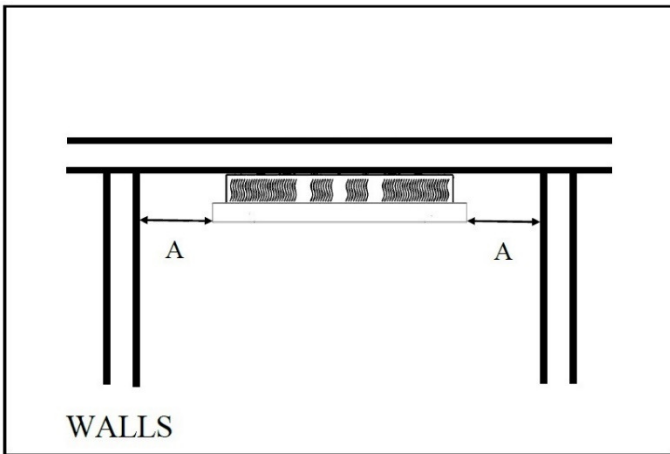

# SPECIFICATIONS

## CERTIFICATION

PFS-TECO has certified that the SÓLAS Outdoor Stainless Steel Wall Mount Gas Fireplaces meet the ANSI Z21.97-2014/CSA 2.41-2014 “Outdoor Decorative Gas Appliances standard.

These appliances are approved for installation in the Commonwealth of Massachusetts. The Board of State Examiners of Plumbers and Gas Fitters has issued approved these appliances.

SÓLAS - OUTDOOR WALL MOUNT FIREPLACE			
SERIAL NUMBER: OUT-			
<b>SÓLAS ONES OUTDOOR</b>			
THIS FIREPLACE IS EQUIPPED FOR:	<input type="checkbox"/> Natural Gas Model: OUT-16NG	<input type="checkbox"/> Propane Model: OUT-16LP	Cetle cheminée est équipée pour :
Input Rating - BTU/hr	12,150	12,600	Débit Calorifique
Min. Input Rating - BTU/hr	7,500	7,600	Puissance Minimum
Orifice - DMS	#49	#58	L'injecteur
Manifold Pressure	3.9"wc. / 0.97kPa	10.0"wc. / 2.49kPa	Press. À la tubulure
Min. Supply Pressure	5.5"wc. / 1.37kPa	11.0"wc. / 2.74kPa	Press. D'arrivée Min.
Max Supply Pressure	10.0"wc. / 2.49kPa	13.0"wc. / 3.24kPa	Press. D'arrivée Max.
<b>SÓLAS TWENTYS OUTDOOR</b>			
THIS FIREPLACE IS EQUIPPED FOR:	<input type="checkbox"/> Natural Gas Model: OUT-26NG	<input type="checkbox"/> Propane Model: OUT-26LP	Cetle cheminée est équipée pour :
Input Rating - BTU/hr	21,500	21,300	Débit Calorifique
Min. Input Rating - BTU/hr	14,900	13,300	Puissance Minimum
Orifice - DMS	#46	#56	L'injecteur
Manifold Pressure	3.9"wc. / 0.97kPa	10.0"wc. / 2.49kPa	Press. À la tubulure
Min. Supply Pressure	5.5"wc. / 1.37kPa	11.0"wc. / 2.74kPa	Press. D'arrivée Min.
Max Supply Pressure	10.0"wc. / 2.49kPa	13.0"wc. / 3.24kPa	Press. D'arrivée Max.
<b>SÓLAS FORTYS OUTDOOR</b>			
THIS FIREPLACE IS EQUIPPED FOR:	<input type="checkbox"/> Natural Gas Model: OUT-46NG	<input type="checkbox"/> Propane Model: OUT-46LP	Cetle cheminée est équipée pour :
Input Rating - BTU/hr	31,750	31,900	Débit Calorifique
Min. Input Rating - BTU/hr	22,400	21,100	Puissance Minimum
Orifice - DMS	#38	#53	L'injecteur
Manifold Pressure	3.9"wc. / 0.97kPa	10.0"wc. / 2.49kPa	Press. À la tubulure
Min. Supply Pressure	5.5"wc. / 1.37kPa	11.0"wc. / 2.74kPa	Press. D'arrivée Min.
Max Supply Pressure	10.0"wc. / 2.49kPa	13.0"wc. / 3.24kPa	Press. D'arrivée Max.
<b>MINIMUM CLEARANCES TO COMBUSTIBLE CONSTRUCTION</b>			
FIREPLACE SURROUND TO L. SIDE WALL	6"		
FIREPLACE SURROUND TO R. SIDE WALL	6"		
FIREPLACE SURROUND TO CORNER WALL	6"		
FIREPLACE SURROUND TO CEILING WALL	12"		
FIREPLACE SURROUND TO REAR WALL	0"		
FIREPLACE SURROUND TO FLOOR	3"		
*The minimum required clearance to be maintained from the fireplace to combustible flooring is measured from the top surface of carpeting, tile, etc.			
<b>DISTANCES MINIMALES PAR RAPPORT AUX MATÉRIEAUX INFLAMMABLES:</b>			
ENTOURAGE ENTRE LE FOYER ET LE MUR À GAUCHE	152mm		
ENTOURAGE ENTRE LE FOYER ET LE MUR À DROITE	152mm		
ENTOURAGE ENTRE LE FOYER ET LE MUR D'ANGLE	152mm		
ENTOURAGE ENTRE LE FOYER ET LE PLAFOND	203mm		
LE FOYER ET LE MUR AU FOND	0mm		
ENTOURAGE ENTRE LE FOYER ET LE PLANCHER	76mm*		
*On mesure l'espace minimum requis entre le foyer et le sol combustible du surface du tapis, des carreaux, etc.			
<b>SÓLASFIRES.COM</b>			

**SÓLAS - OUTDOOR WALL MOUNT FIREPLACE**

For Outdoor Use Only

**DANGER**

**CARBON MONOXIDE HAZARD**

This appliance can produce carbon monoxide which has no odor. Using it in an enclosed space can kill you. Never use this appliance in an enclosed space such as a camper, tent, car or home.

**DANGER**

**DANGER DU MONOXYDE DE CARBONE**

CET APPAREIL PEUT PRODUIRE DU MONOXYDE DE CARBONE QUI N'A AUCUNE ODEUR. L'UTILISER DANS UN ESPACE CLOS PEUT VOUS TUER. NE JAMAIS UTILISER CET APPAREIL DANS UN ESPACE CLOS COMME CAMPER, TENTE, VOITURE OU UNE MAISON.

**WARNING**  
Improper installation, adjustment, alteration, service or maintenance can cause injury or property damage. Refer to the owner's information manual provided with this appliance. For assistance, or additional information, consult a qualified installer, service agency, or the gas supplier.

**AVERTISSEMENT:**  
Une installation, un réglage, une modification, une réparation ou un entretien mal effectué peut causer des dommages matériels ou des blessures. Voir la notice de l'utilisateur qui accompagne l'appareil. Pour de l'aide ou des renseignements supplémentaires, consultez un installateur, un technicien agréé ou le fournisseur de gaz.

**WARNING**  
Do not store or use gasoline or other flammable vapors and liquids in the vicinity of this or any other appliance.  
An LP cylinder not connected for use shall not be stored in the vicinity of this or any other appliance.

**AVERTISSEMENT**  
Ne pas stocker ou utiliser d'essence ou d'autres vapeurs inflammables et à proximité de cet appareil ou tout autre appareil.  
Une bouteille de GPL non connectée pour utilisation ne doit pas être entreposée dans le voisinage de cet appareil ou tout autre appareil.

This product has been certified by PFS TECO to ANSI Z21.97-2014/CSA 2.41-2014 Outdoor Decorative Gas Appliances. This appliance must be installed in accordance with local codes, if any. If none, follow the ANSI Z223.1 standard. Installation and service must be performed by a qualified installer, service agency or the gas supplier. Test Standard CGA 2.17-M91 (R2014) - Gas-Fired Appliances for Use at High Altitudes

Ce produit a été certifié par les OMNI-Test Laboratoires ANSI Z21.97-2014/CSA 2.41-2014 Appareils à Gaz Décorative Extérieure. Cet appareil doit être installé conformément aux codes locaux, in cas échéant ; Sinon, suivez la norme ANSI Z223.1. Installation et service doivent être exécutés par un installateur qualifié, une Agence de service ou le fournisseur de gaz.

Report # F19-220

Manufactured by:  
Progressive Manufacturing Inc.  
4 Technology Drive  
West Lebanon, NH 03784  
U.S.A.

SÓLASFIRES.COM

Sample Rating Label (affixed to RH side of firebox)

8



# INSTALLATION

## FOR OUTDOOR USE ONLY

### LOCATING YOUR OUTDOOR GAS FIREPLACE

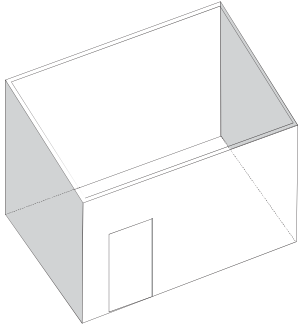

- 1) When selecting a location for your fireplace, ensure that the clearances are met.
- 2) This appliance must be installed in an open-air situation with natural ventilation, without stagnant areas, where gas leakage and products of combustion are rapidly dispersed by wind and natural convection.
- 3) Certain materials or items, when placed under or near the appliance, will be subjected to radiant heat and could become damaged.
- 4) Typically an outdoor space is not enclosed but, any enclosure in which the appliance is used shall comply with one of the following:

An enclosure with walls on all sides, but at least one permanent opening at ground level and no overhead cover.

Within a partial enclosure that includes an overhead cover and no more than two walls.

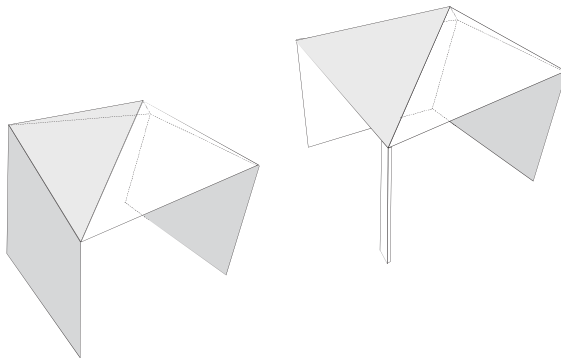

Within a partial enclosure that includes an overhead cover and more than two walls, the following shall apply:

- At least 25% of the total wall area is completely open, and
- At least 30% of the remaining wall area is open and unrestricted

30% or more in total of the remaining wall area is open and unrestricted.

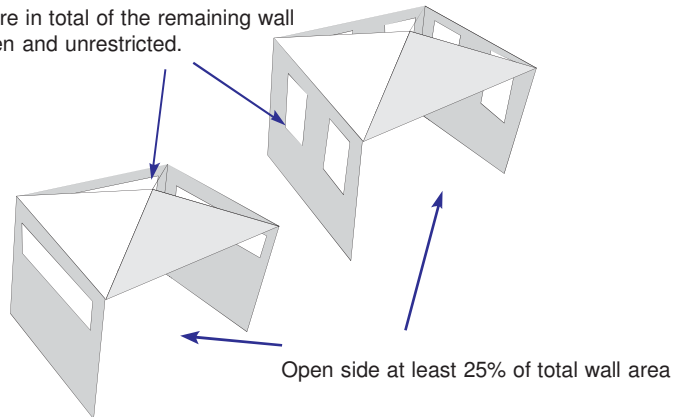

# INSTALLATION

## INSTALLATION CONSIDERATIONS:

### FOR OUTDOOR USE ONLY.

Several issues must be addressed when selecting a suitable location for your SÓLAS Wall Mount Outdoor Gas Fireplace. The minimum clearances to combustibles are listed on page 6. In addition, access to the gas supply must be considered.



**THIS UNIT CANNOT BE INSTALLED DIRECTLY ONTO VINYL SIDING.**

**\*THIS UNIT CANNOT BE RECESSED INTO A WALL\***

#### **Decommission During Off-Season**

We recommend decommissioning your outdoor fireplace during the off-season when it will not be used for an extended period. Decommission your fireplace by removing the batteries from the battery holder and turning the gas shut-off valve to the “off” position.

Upon ensuring the fireplace cannot be turned on you can then apply a weather protective cover over the front of the fireplace to help preserve the finish and further protect the appliance from weather.

**Note: Do not operate your outdoor fireplace during cold weather below freezing point (32°F, 0°C).**

#### **Exposure to outdoor UV light**

Exposure to outdoor UV light will cause some plated and painted finishes to fade over time. This fading is unavoidable and not covered under warranty.

To minimize fading, locate the fireplace away from direct sunlight. Decommissioning and covering the fireplace over the off-season will also prolong the finish.



# INSTALLATION

## INSTALLING GAS PIPING TO FIREPLACE LOCATION

**⚠ WARNING:** This appliance requires a 1/2" NPT (National Pipe Thread) inlet connection to the pressure regulator.

**⚠ WARNING:** A qualified service person must connect fireplace to gas supply. Follow all local codes.

**⚠ CAUTION:** Never connect propane/LP fireplace directly to the propane/LP supply. This fireplace requires an external regulator (not supplied). Install the external regulator between the fireplace and propane/LP supply.

**NOTICE:** Surface temperatures of adjacent walls and mantels become hot during operation. Walls and mantels above the firebox may become hot to the touch. If installed properly, these temperatures meet the requirement of the national product standard. Follow all minimum clearances shown in this manual.

The gas fireplace is shipped with a 3/8" tube OD (male) connection. A gas supply shutoff valve is supplied on the unit. The fireplace and its main control valve must be disconnected from the gas supply piping system during any pressure testing of that system at test pressures in excess of 1/2 psi (3.5 kPa). The stove must be isolated from the gas supply piping system by closing the main control valve during any pressure testing of the gas supply system at test pressures equal to or greater than 1/2 psi (3.5 kPa). After the gas supply has been connected, use a commercial gas leak detector or apply a soapy water solution to all the fittings to check for gas leaks. Never use a flame to test for leaks.

# ASSEMBLY & INSTALLATION

## UNPACKING AND INSTALLING THE SÓLAS OUTDOOR DIRECT VENT GAS FIREPLACE

The fireplace components are shipped in two cartons. By now, you will have opened the top of the first carton and removed the front face protector and this Manual. The second carton contains the fireplace surround assembly.

1. Using the adjacent illustrations as a guide, first lift and remove Tube 1 from the carton containing the firebox. Carefully unpack the contents of the tube and set aside. This should include the bag of glass burner media, the remote control handset, and a hardware bag.

2. Next, lift and remove Tube 2 from the carton. Carefully remove the contents of the tube. This includes the four decorative panels that will be attached to the fireplace during assembly.

3. Next, remove all remaining packing material from the carton.

4. Lift the firebox and the fireplace mounting plate as a unit up and out of the carton. The best place to lift is at sides. Remove the fireplace mounting template from the face of the fireplace. You should now have all the parts as shown in the illustration below.

5. Finally, unpack the fireplace surround from the third carton and set aside on a soft surface for later use.

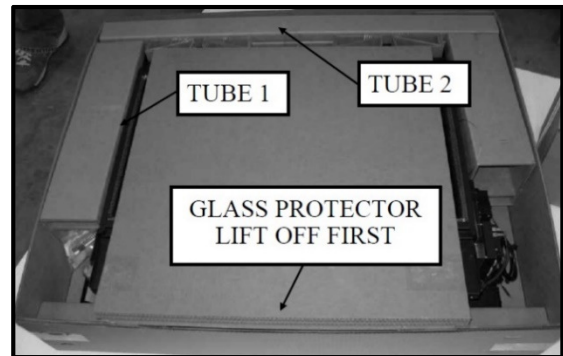

# ASSEMBLY & INSTALLATION

Before you begin the fireplace mounting process there are several important installation requirements that must be met. Careful planning will make the installation easier to accomplish and will reduce the chances of encountering problems during installation.

1. The fireplace is designed to be wall-mounted using four lag bolts to secure the fireplace mounting plate to the wall structure. The mounts are located 16" on center and 24" on center to correspond with standard building construction. If your home has non-standard construction or the location you have chosen for the fireplace does not have wall studs that correspond to location of the fireplace mounts, modifications to the wall structure will be needed. It is critical that the four lag bolts that are provided for mounting the fireplace are firmly imbedded into the wall structure at all four locations.
2. All required minimum clearances to adjacent combustible materials (including side walls, ceiling and floor) must be achieved with the location you have chosen. See the clearance information on page 8. The listed clearances are measured from the outermost front edges of the fireplace surround and not from the fireplace body or mounting plate. Again, plan the installation in advance to avoid problems.
3. The gas supply line must be located within a specific area behind the fireplace. Use the provided wall template as a guide when locating the gas supply line pass-through.

Once you are certain that the location you have chosen meets all the necessary mounting and safety requirements, you can begin the installation.

1. Tape or pin the installation template to the wall in the position where the fireplace is to be mounted. Note: It is important that the fire-place is mounted in a level position. Use a spirit level placed on the cross-hairs in the upper mounting holes on the template and adjust the template position until the mounting holes are level. Refer to the adjacent illustration.
2. Next, carefully transfer the location of the two upper and two lower mounting holes that you will use for your installation. Use a sharp nail, awl or pin to pierce the template on the mounting hole cross-hairs to insure an accurate transfer to your wall.
3. Finally, transfer the location of the gas supply line.
4. Remove the template and circle the transferred locations with a pencil or marker.

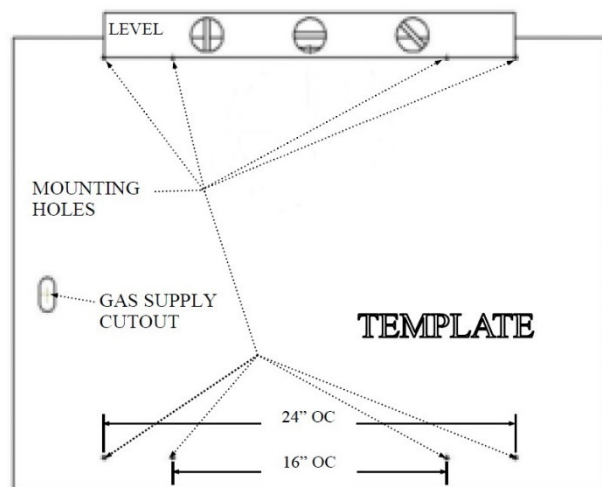



# ASSEMBLY & INSTALLATION

## GAS SUPPLY LINE

The supply line should exit the wall that the fireplace will be installed on at the location specified on the installation template. Your professional gas installer or local gas company will determine the specific requirements for the gas supply line as the requirements may vary in different locations. In every case, the installation must conform with local codes or, in the absence of local codes, with the National Fuel Gas Code, ANSI Z223.1.

## INSTALLING THE FIREPLACE MOUNTING PLATE ON THE WALL

1. The fireplace mounting plate is attached to the wall structure using four 1/4" X 1 1/2" long lag bolts and large diameter washers that are provided with the fireplace. It is important to use the included hardware as the full weight of the fireplace is supported by the mounting plate.
2. Drill a 5/32" diameter pilot hole at each of the mounting hole locations that you marked using the template. The pilot holes should be the full depth of the lag bolts. Be sure that there is solid wood at each mounting location. If not, the wall should be reconstructed to provide the needed support.
3. With a helper pick up and align the mounting plate over the gas supply line and line up with the four mounting lag bolt pilot holes. These holes are in recessed bosses. Use either the 16" or 24" on center holes depending on the construction of the wall.
4. Using the lag bolts and washers provided with the fireplace, install the top lag bolts (with washers) first, followed by the lower ones. Use a 7/16" socket wrench to tighten the lag bolts. Note: It may be helpful to put a light coating of dish or hand soap on the lag bolts to reduce resistance when tightening.
5. At this point, check to be sure that there is an air gap between the entire flat back surface of the mounting plate and the wall surface (see clearance chart on page 9 for the air gap required for your model). This gap is critical to a safe installation and if the gap is obstructed in any way, remove the obstruction before proceeding.
6. Next check that the brackets on the mounting plate that actually hold the fireplace are level, again using a spirit level. If the brackets are not perfectly level, you can adjust the right bracket by loosening the bracket fasteners and moving the bracket until it is level with the left bracket. Remember to tighten the bracket fasteners once you have achieved a level position. (refer to images on following page)

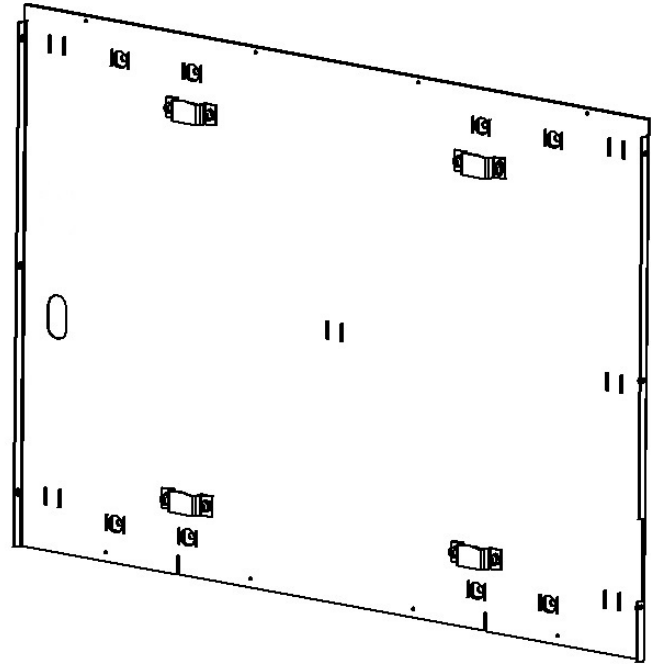





# ASSEMBLY & INSTALLATION

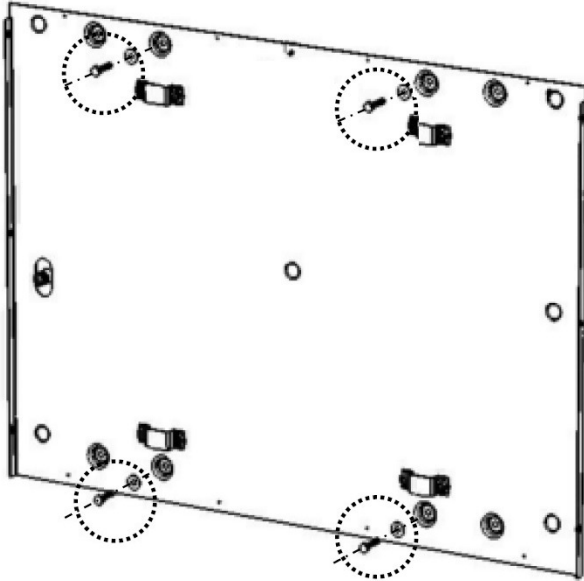

LAG BOLTS & WASHERS

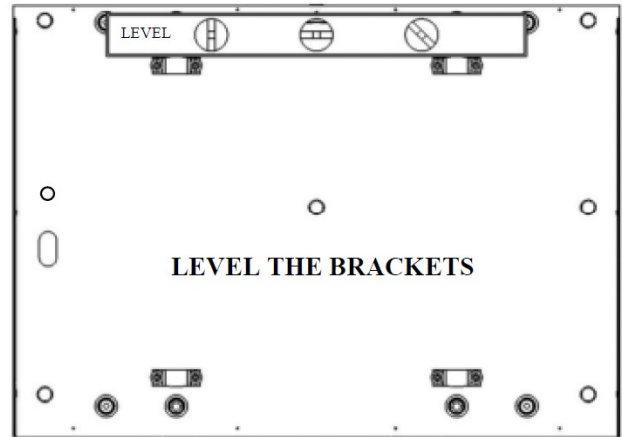

7. You are now ready to install the fireplace on the mounting plate, this will require a helper as the fireplace is quite heavy.
8. While looking in from the sides, guide the upper and lower mounting tabs on the back of the fire-place into the corresponding brackets on the mounting plate. When the tabs and brackets are aligned, push the fireplace down and in to engage the tabs in the brackets. Note: The weight of the fireplace is carried only on the top brackets. The bottom brackets function simply to keep the bot-tom of the fireplace from moving. Refer to the adjacent illustration.

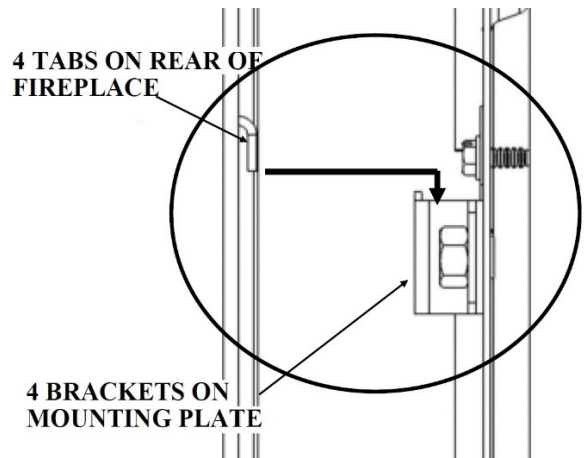

9. Once more, confirm that the fireplace is level using the spirit level used in the preceding steps. The fireplace is now ready for the gas connection to be made.

# ASSEMBLY & INSTALLATION

## GAS CONNECTION

1. Verify that the gas type is correct for the fireplace by looking at the rating plate that is attached to the right side of the fire-place, adjacent to the control battery pack. Note: The fireplace is shipped from the factory equipped to burn the fuel listed on the rating plate. Fuel conversion in the field is not allowed.
2. The gas connection should now be made from the gas supply line to the 3/8 OD Tube fitting on the fireplace. Only a qualified gas installer is to make the connection.

3. The fireplace and its main burner valve must be disconnected from the gas supply piping system during any pressure testing of that system at test pressures in excess of 1/2 psi (3.5kPa).

4. The fireplace must be isolated from the gas supply piping system by closing the gas shut-off valve during any pressure testing of the gas supply system at test pressures equal to or less than 1/2 psi (3.5kPa). After the gas supply has been connected, use a commercial gas leak detector or apply a soapy water solution to all the fittings to check for gas leaks. Never use a flame to test for leaks.

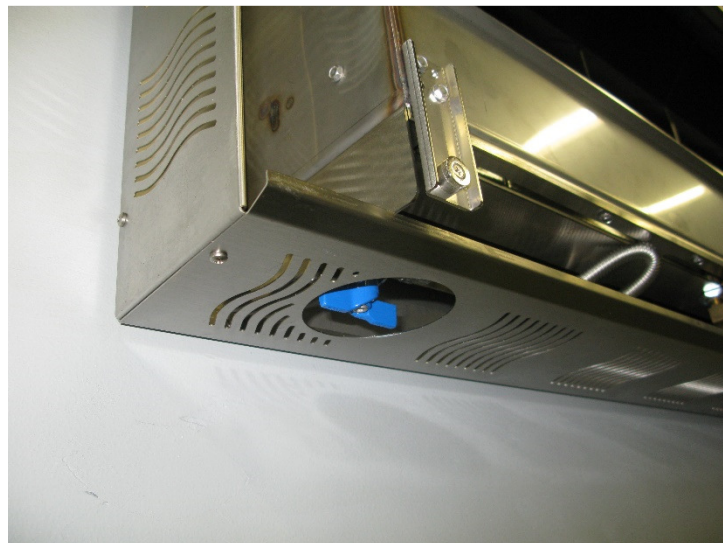
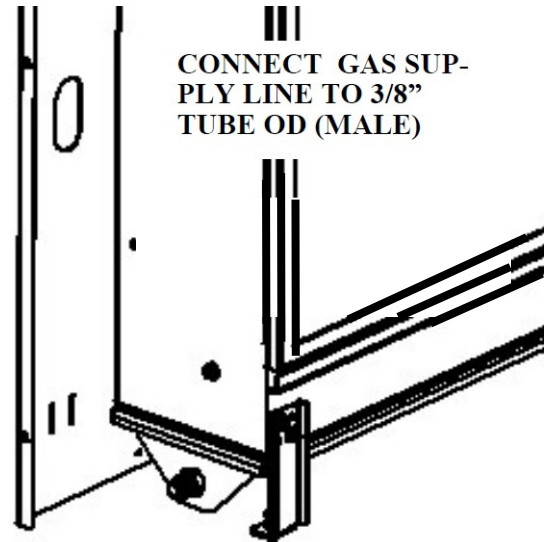



# ASSEMBLY & INSTALLATION

## INSTALLING OR REPLACING THE BATTERIES

1. The valve control module is powered by four (4) “AA” batteries. The batteries are mounted within the Valve Receiver Module located on the right side of the fireplace attached to the drop-down mounting bracket for easy accessibility. Refer to the adjacent illustration.
2. Loosen the thumb screw on the module drop-down mounting bracket by turning counter-clockwise until the threads are fully disengaged from the base bracket.
3. Rotate the Valve Receiver Module and mounting bracket toward you 90 degrees.
4. Slide off the battery compartment cover.
5. Install the four (4) “AA” batteries, supplied, using the guides inside the battery pack to show you the correct battery orientation.
6. Replace the battery compartment cover. Rotate the Valve Receiver Module and mounting bracket into its home position and tighten the thumb screw to secure.
7. The remote handset is powered by three (3) “AAA” batteries. The access panel is located on the back of the handset and simply snaps open to provide access to the battery compartment. Install the three (3) batteries as shown on the label inside the remote control battery compartment.
8. Replace the remote handset access panel.

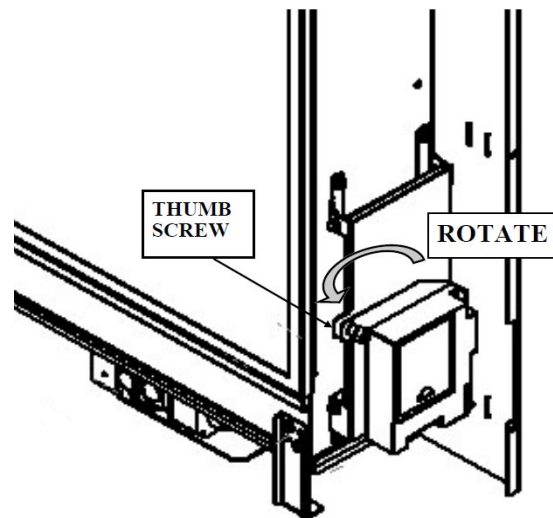

# ASSEMBLY & INSTALLATION

## PLACING THE BURNER GLASS MEDIA

The burner glass media poly-bag that you set aside when you unpacked the fireplace contains the correct amount of glass material to cover the burner. DO NOT add any additional media to the media supplied with your fireplace. The entire contents of the bag should be evenly distributed over the burner tray.

1. Locate the burner in the fireplace. Refer to the adjacent illustration.
2. Carefully clip one corner of the poly-bag to form a pouring spout. The opening should be large enough to allow the glass media to flow but not so large that you can't control the flow.
3. You will notice that the burner surface is designed with turned-up edges that form a tray to hold the glass media.
4. Starting at one end, pour the glass media onto the burner tray, keeping the pouring spout on the poly-bag toward the center of the burner to avoid spillage of glass pieces over the sides of the burner. See the adjacent illustrations.
5. Once you have poured all the glass burner media into the burner tray, carefully smooth the glass pieces out so they have a uniform depth over the entire surface of the burner. When the burner glass media is properly placed, it should look like the adjacent illustrations.

**NOTE:** If a few pieces of glass escape over the edges of the burner tray during installation, it is not a problem. They will simply land in the area below the burner and will do no harm.

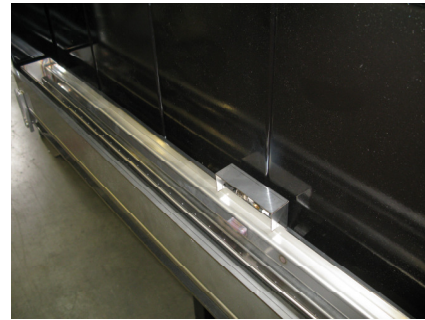



# ASSEMBLY & INSTALLATION

## INSTALLING OUTER PANELS

1. The four outer decorative panels are secured to the fire-place with Philips head screws. The top and bottom panels are secured to the fireplace mounting plate with sheet metal screws. All other screws are Philips head machine screws.
2. Install the top panel first. Align the three holes along the rear edge of the panel with pilot holes along the top edge of the fireplace mounting plate.
3. Insert and tighten the three sheet metal screws. A magnetic nut driver is helpful.
4. Install the left side panel next. Align the three holes along the rear edge of the panel with the PEM nuts along the edge of the fireplace mounting plate. Insert the three Philips head screws but do not fully tighten.
5. Locate the fastener hole at the top front edge of the left side panel and align with the PEM nut in the front of the top panel. Insert the Philips head screw.
6. Make sure the edges of the panel are aligned with the edges of the top panel and mounting plate and tighten all four Philips head screws.
7. Position the right side panel so it aligns with the three PEM nuts on the mounting plate and the front PEM nut on the top panel. Align the rear and top panel edges with the adjoining parts and insert and tighten the four Philips head screws.
8. Install the bottom panel next. Guide the rear flange on the panel upward until the mounting holes in the flange line up with the pilot holes in the mounting plate.
9. Attach the panel to the mounting plate using sheet metal screws along the back edge of the panel. Note: It may make installation of the sheet metal screws easier if you remove the two lower surround mounting brackets from the front of the fireplace, replace brackets before operating fireplace. A magnetic nut-driver will also be helpful.
10. Attach the bottom panel to the side panels by aligning the fastener holes in the bottom panel with the PEM nuts in the front corners of the bottom flanges on the side panels. Insert and tighten the two Philips head screws.

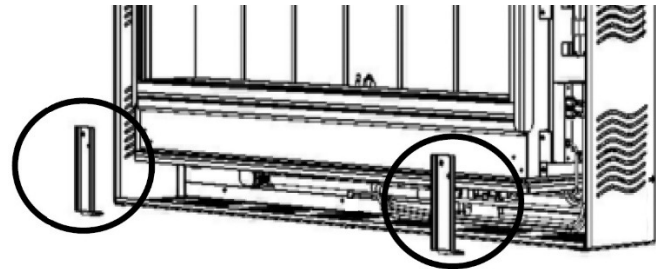
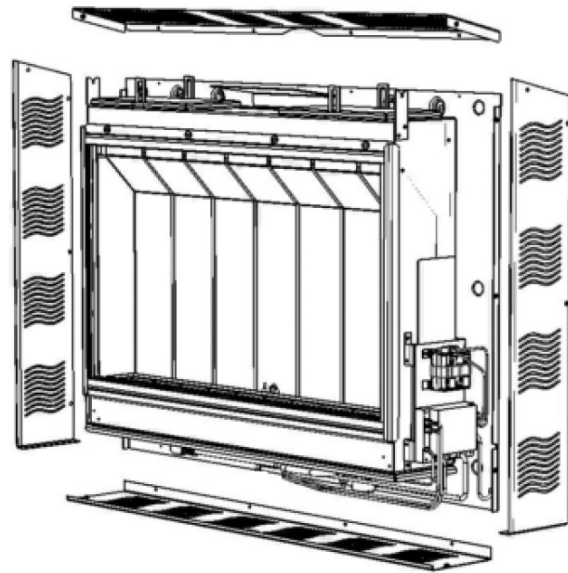

LOWER SURROUND BRACKETS

**Only trim kit(s) supplied by the manufacturer shall be used in the installation of this appliance.**





# ASSEMBLY & INSTALLATION

## INSTALLING THE FIREPLACE SURROUND WITH INTEGRATED SCREEN

The decorative surround with integrated screen for the fireplace is held in place by four brackets. Two are located on the top of the fireplace and two on the bottom. There are mating brackets and catch plates on the surround itself. Refer to the adjacent illustrations when installing the surround.

1. Unpack the surround with integrated screen from shipping box.
2. With a helper, lift the surround with integrated screen up and identify the top by looking for the vertical brackets that are visible from the rear of the surround.
3. Move the surround with integrated screen into place, generally centering the surround opening over the glass panel. Keep the bottom of the surround tipped slightly away from the fireplace.

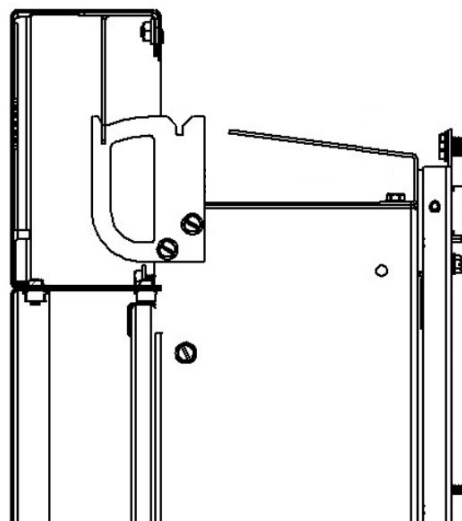

4. While looking behind the surround with integrated screen, guide the two surround brackets onto the forward detent of the mating brackets on the fireplace top. You might find it easier to engage one bracket and then the other. Lower the surround until both bracket sets are fully mated.
5. Carefully push the top of the surround with integrated screen so that the surround brackets slide into the rear detent of the mating brackets on the fireplace top. Carefully swing the bottom of the surround with integrated screen toward the base of the fireplace until the magnetic latches engage to retain the surround.
6. To remove the surround with integrated screen, pull the bottom edge of the surround outward to disengage the magnetic latches and then lift the top up and off the upper brackets.
7. To prevent damage to the surround with integrated screen, always set the surround with integrated screen in a safe place while it is removed from the fireplace.

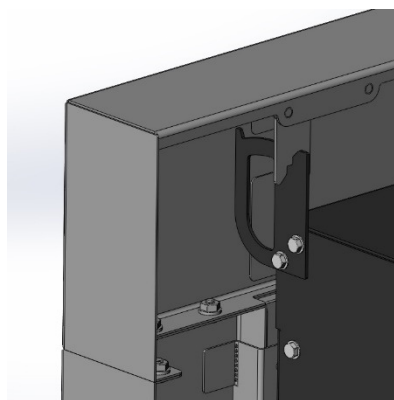
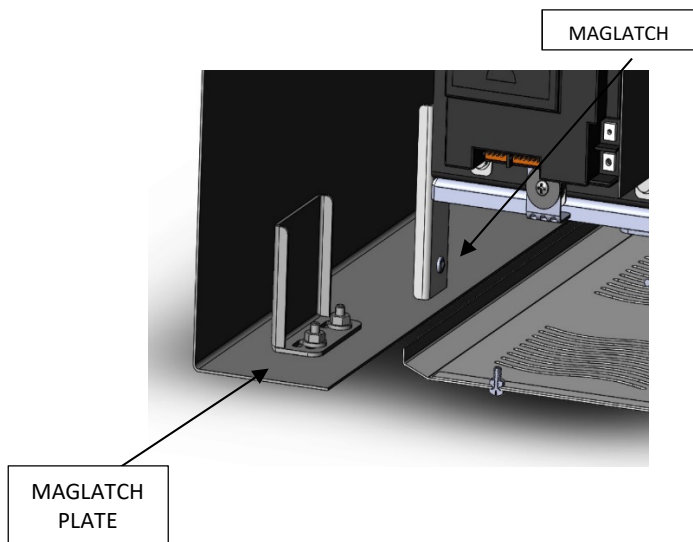

# LIGHTING & OPERATION

**WARNING: If you do not follow these instructions exactly, a fire or explosion may result causing property damage, personal injury or loss of life.**

When lighting this appliance, follow these instructions exactly.

- A. This appliance is equipped with an ignition device that automatically lights the pilot. Do not try to light the pilot by hand.  
B. BEFORE OPERATING THE BURNER SYSTEM, smell around the appliance area for gas. Be sure to smell next to the floor because some gas is heavier than air and will settle on the floor.

## WHAT TO DO IF YOU SMELL GAS

- Do not try to light the appliance.
  - Do not touch any electric switch; do not use any telephone in your building.
  - Immediately call your gas supplier from a neighbor's telephone. Follow the gas supplier's instructions
  - If you cannot reach your gas supplier, call the fire department.
- C. Use only your hand to operate the gas controls. Never use tools. If a knob will not push in or turn by hand, don't try to re-pair it, call a qualified service technician. Force or attempted repair may result in a fire or explosion.  
D. Do not use this appliance if any part has been under water. Immediately call a qualified service technician to inspect the appliance and to replace any part of the control system which has been under water.

## OPERATING INSTRUCTIONS

1. STOP! Read the safety information above on this label.
2. This appliance is equipped with an ignition device that automatically lights the pilot. Do not try to light the pilot by hand.
3. Using the Remote Handset, or the optional Wall Switch, push the "OFF" (⊖) button until you hear an audible signal to insure the appliance is off.
4. Wait five (5) minutes to clear out any gas. Then smell for gas including near the floor. If you smell gas, STOP! Follow "B" in the safety information above. If you don't smell gas, proceed to step 5.
5. Using either the Remote Handset, or the optional Wall Switch, simultaneously press the "ON" (⊕) and "High Flame" (↑) buttons. An audible signal confirms the start sequence has begun.
6. Continuing beeps confirm the ignition is in process. Once lighting the pilot flame should appear as shown in Fig.2. Once the pilot is confirmed, the main burner ignites on high.

NOTE: If the pilot does not stay lit after several tries, proceed to step 9.

7. Use the flame height adjustment buttons on either the Remote Handset or the optional Wall Switch to adjust the flame. Press the ↓ button twice to decrease the flame height to its lowest setting, press the ↑ button twice to increase flame height to the highest setting. Pressing the ↑ or ↓ button once will modulate the flame to intermediate settings. The Remote Handset can also be used to control the appliance thermostatically.
8. Press and hold the ↓ button on the Remote Handset or optional Wall Switch to set the appliance to Pilot flame only.
9. If the appliance will not operate, follow the instructions "TO TURN OFF GAS TO THE APPLIANCE" and call your gas service technician or gas supplier.

## TO TURN OFF GAS TO THE APPLIANCE:

1. To turn off gas to the Appliance, push and release the "OFF" button on either the Remote Handset or the optional Wall Switch. An audible signal will confirm.

2. Close the shut-off valve on the gas supply line to the appliance.

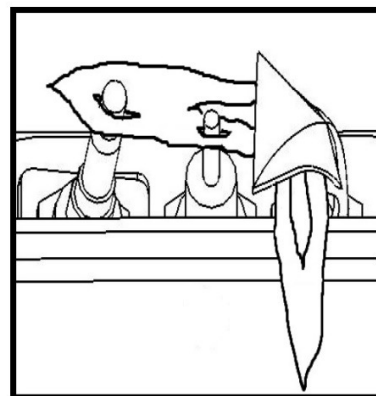
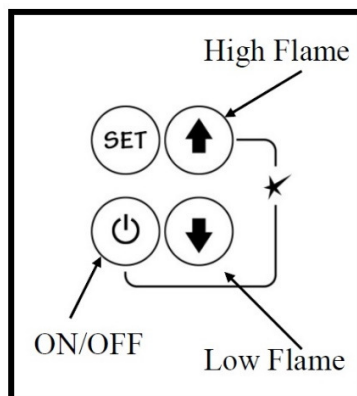

- It is recommended that the pilot flame be turned off when the appliance is not in use.
- It is recommended that the gas shut off valve be turned to the "off" position when the appliance is not in use.



# LIGHTING & OPERATION

## OPERATING YOUR FIREPLACE FOR THE FIRST TIME

When operating your new fireplace for the first time, some vapors may be released due to the curing compounds used in the manufacture of the appliance. They may cause a slight odor and could cause the flames to be the full height of the firebox, or even slightly higher, for the first few hours of operation. It is also possible that these vapors could set off and smoke detection alarms in the immediate vicinity. These vapors are quite normal on new appliances. We recommend opening a window to vent the room during the burn off period. After a few hours use, the vapors will have disappeared and the flames will be at their normal height.

## FLAME SUPERVISION DEVICE

For your safety, this appliance is fitted with a flame supervision device which will shut-off the gas supply if, for any reason, the pilot flame goes out. This device incorporates a Thermocouple, which senses the heat from the pilot flame. If the Thermocouple is cool, the device will prevent any gas flow unless manually lighting the pilot. See full lighting instructions. Periodically check the pilot and burner flames, comparing them to figure 2 on the preceding page, and the image at the bottom of this page.

## LIGHTING, OPERATION, AND RATING INFORMATION

The Lighting, Operation and Rating information is located on a plate on the RH side of the firebox.



To access the plate, remove the surround and grab the plate and slide it up to read it. There is important information on both sides of the plate.

## SERVICING

If any attention is required for your appliance, contact your dealer quoting the model number. It will be helpful if the appliance's serial number can also be quoted. This number is on the rating plate, which is located under the burner. The replacement parts are shown at the end of this manual. Please always quote the part number and description when requesting spare parts.

## FIREPLACE CONTROL DEVICES

There are two ways to control your fireplace.

1. Remote Control (O46-507)
2. Optional Wall Switch (M46-505)

The Remote Control (O46-507) can be used to turn the flame on, off, and to increase or decrease the flame height.

The Wall Switch (optional) can be used to turn the flame on, off, and to increase or decrease the flame height—see M46-505 —Wall Switch Kit.



Programmable Thermostatic Remote Control (M46-507)



Wall Switch (M46-505) (optional)





# REMOTE HANDSET OPERATION

## HOW TO TURN YOUR FIREPLACE OFF (INCLUDING PILOT)

Familiarize yourself with each of these methods before operating your fireplace.

**Handset and Wall Switch:** Press and hold the OFF button for a second (either on the handset or the wall switch).

If the flames are on, they go down and you hear the valve motor wind down. You hear a clunk and a beep indicating that the valve has received the signal from the remote control.



Standard Handset

## HOW TO ENSURE YOUR FIREPLACE CANNOT BE TURNED ON INADVERTENTLY

You can use the following method to ensure that your fireplace will not turn on when you don't want it on.

First, ensure your fireplace is turned off—including the pilot—and cold BEFORE going ahead.

- Close the shut-off valve on the gas supply line to the appliance.
- Remove all batteries from the receiver as well as the battery from the handset.

### Automatic Shut-Off (in certain conditions)

Your fireplace's remote control is equipped with an automatic shut-off mechanism which is activated in certain conditions. See page 26 in the *Remote Control Operation* section for a description of this feature.

**NOTE:** Before using the remote control system for the first time, the receiver and the handset are synchronized at the factory. See the section *Remote Control Initial Set-up* on page 24 of this manual if the receiver and handset lose synchronization.



**DO NOT LEAVE REMOTE CONTROL EXPOSED TO WEATHER**

# REMOTE HANDSET OPERATION

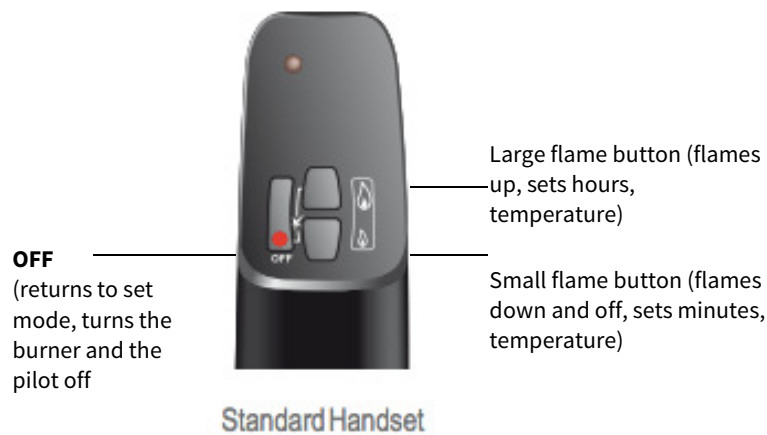

## Handset Overview

### TO TURN ON APPLIANCE

#### CAUTION

When pilot ignition is confirmed, motor turns automatically to maximum flame height.

- On the valve, turn MAN knob on the ON, full counterclockwise  position.



Standard Handset

- Simultaneously press the OFF and  (large flame) buttons until a short beep confirms the start sequence has begun; release buttons.
- Continuing beeps confirm the ignition is in process.
- Once pilot ignition is confirmed, there is main gas flow.
- After main burner ignition the handset will automatically go into manual (MAN) control mode.

### TO TURN OFF APPLIANCE



- Press OFF button.

When the pilot is off, it will take 2 minutes before it can be lit again.

### STANDBY MODE (Pilot Flame)

- Press and hold  (small flame) to set appliance at pilot flame

### FLAME HEIGHT ADJUSTMENT



Standard Handset

- In standby mode: Press and hold  (large flame) button to increase flame height.







# REMOTE HANDSET OPERATION





Standard Handset

- Press and hold  (small flame) button to decrease flame height or to set the appliance at pilot flame.
- For fine adjustment tap the  (large flame) or  (small flame) buttons.

## Express Low and High Fire



Standard Handset

- Double-click  (small flame) button. “LO” will be displayed.  
  
NOTE: Flame goes to high fire first before getting to designated low fire.
- Double-click  (large flame) button. Flame automatically goes to high fire. “HI” will be displayed.



# REMOTE HANDSET OPERATION

## AUTOMATIC TURN DOWN

- **No communication.** If there is no communication between the receiver and the handset for a period of 6 hours, the appliance goes into pilot mode.
- **No change in flame height.** If there is no change in flame height for a period of 6 hours, the appliance goes into pilot mode.

## AUTOMATIC SHUT OFF

battery power in the receiver the system shuts off completely.

**NOTE:** This does not apply when the power supply is interrupted.

**No change in pilot.** The appliance shuts off completely when it is continually in pilot position—without any change—for a period of 5 days.

- **Low batteries in the receiver.** With low

## LOW BATTERY INDICATION

### CAUTION

**DO NOT USE** a screwdriver or other metallic object to remove the batteries from the battery box or the handset! This could cause a short circuit.

**Receiver:** Three short 'beeps' will sound when the motor turns when the batteries need to be replaced. Replace with four 1.5 V **alkaline** batteries

## HANDSET / RECEIVER MATCH

The remote control handset and receiver are programmed to function together. In case of a replacement of the handset or the receiver, you will need to reset the receiver to allow them to function together. Contact your dealer for more details.



# MAINTENANCE

## ANNUAL MAINTENANCE

A qualified service agency should conduct an annual inspection and maintenance of your SÓLAS Wall Mount Outdoor Gas Fireplace including the overall installation and venting to keep it running safely. The following procedures should be performed only by a qualified service person. The gas supply should be turned off and the stove should be completely cool whenever a maintenance procedure is performed. All parts of the appliance that are removed for servicing must be replaced prior to operation.

**This appliance should be inspected before use and at least annually by a qualified service person. More frequent cleaning may be required due to excessive dust or lint from carpeting, bedding materials, pets, etc. It is imperative that control compartments and circulating air passageways of this appliance be kept clean.**

## CLEANING THE BURNER AND FIREBOX

During the annual inspection and maintenance appointment, the service person should clean the burner and firebox. To gain access to the firebox and burner, follow the instructions beginning on page 18 of this manual.

### **DO NOT USE A VACUUM CLEANER TO CLEAN THE GLASS BURNER MEDIA.**

A vacuum cleaner may be used to clean the metal parts of the firebox. Leave the glass burner media in place. Use a soft brush to clean the burner glass media. If the burner media does need to be removed, carefully scoop it off the burner and avoid dropping glass pieces in the air gaps around the burner. Follow the instructions on page 16 of this manual when replacing the burner media on the burner top.

## AIR FLOW

The SÓLAS Wall Mount Outdoor Gas Fireplace utilizes a convection air heat exchange system to maximize heat delivered from the fire-place. It is important that air flows freely through the convection air system and out the top and side air grills. Do not place objects under the fireplace that will block the convection air inlet flow or in front of any air outlet.

## CLEANING THE GLOSS BLACK ENAMEL PANELS

After allowing the Fireplace to cool, use an ammonia-free glass cleaner and a soft, clean cloth to clean the Enamel Panels at the rear and side of the firebox. It is recommended that the Enamel Panels be cleaned at least annually to avoid discoloration. More frequent cleaning may be required if contaminants are present in the gas supply or general atmosphere.

**WARNING: Never clean the Enamel Panels while they are hot. Do not use abrasive cleaners or cleaners containing ammonia.**

**NOTE:** It is recommended that a Micro-fiber cleaning cloth be used to clean the enamel panels.

**WARNING:** Failure to keep the primary air openings of the burner clean may result in sooting and property damage.

**SOLAS advises that the burner be inspected annually at the beginning of the season by a qualified service technician.**

Should your service technician feel that the condition of the burner is not suitable for operation, the burner must be replaced with the appropriate burner supplied by SOLAS. Should you have any questions or concerns about the condition of your burner contact your service technician to arrange an inspection. Please refer to the replacement parts list on page 29 for the appropriate burner part number.



# MAINTENANCE LOG

We strongly recommend that you keep a log of the regular maintenance that is performed on your fireplace. We have provided the forms below to make it easy. Simply ask your qualified service person to fill out one of the maintenance record forms below, each time the fireplace is serviced. This will help insure that all of the required maintenance procedures have been completed, at least annually. Regular maintenance will help keep the fireplace functioning in a safe and reliable manner. Additional forms are available from your installer or service person when needed.

Date of Service _____
Serviced By _____
<u>Service Performed</u>
<input type="checkbox"/> Clean Burner & Firebox
<input type="checkbox"/> Clean Control Area
<input type="checkbox"/> Clean Convection Air System
<input type="checkbox"/> Leak Test Gas Connections
<input type="checkbox"/> Other _____

Date of Service _____
Serviced By _____
<u>Service Performed</u>
<input type="checkbox"/> Clean Burner & Firebox
<input type="checkbox"/> Clean Control Area
<input type="checkbox"/> Clean Convection Air System
<input type="checkbox"/> Leak Test Gas Connections
<input type="checkbox"/> Other _____

Date of Service _____
Serviced By _____
<u>Service Performed</u>
<input type="checkbox"/> Clean Burner & Firebox
<input type="checkbox"/> Clean Control Area
<input type="checkbox"/> Clean Convection Air System
<input type="checkbox"/> Leak Test Gas Connections
<input type="checkbox"/> Other _____

Date of Service _____
Serviced By _____
<u>Service Performed</u>
<input type="checkbox"/> Clean Burner & Firebox
<input type="checkbox"/> Clean Control Area
<input type="checkbox"/> Clean Convection Air System
<input type="checkbox"/> Leak Test Gas Connections
<input type="checkbox"/> Other _____

Date of Service _____
Serviced By _____
<u>Service Performed</u>
<input type="checkbox"/> Clean Burner & Firebox
<input type="checkbox"/> Clean Control Area
<input type="checkbox"/> Clean Convection Air System
<input type="checkbox"/> Leak Test Gas Connections
<input type="checkbox"/> Other _____

Date of Service _____
Serviced By _____
<u>Service Performed</u>
<input type="checkbox"/> Clean Burner & Firebox
<input type="checkbox"/> Clean Control Area
<input type="checkbox"/> Clean Convection Air System
<input type="checkbox"/> Leak Test Gas Connections
<input type="checkbox"/> Other _____

Date of Service _____
Serviced By _____
<u>Service Performed</u>
<input type="checkbox"/> Clean Burner & Firebox
<input type="checkbox"/> Clean Control Area
<input type="checkbox"/> Clean Convection Air System
<input type="checkbox"/> Leak Test Gas Connections
<input type="checkbox"/> Other _____

Date of Service _____
Serviced By _____
<u>Service Performed</u>
<input type="checkbox"/> Clean Burner & Firebox
<input type="checkbox"/> Clean Control Area
<input type="checkbox"/> Clean Convection Air System
<input type="checkbox"/> Leak Test Gas Connections
<input type="checkbox"/> Other _____



# REPLACEMENT PARTS LIST

## GENERAL REPLACEMENT PARTS

PART NAME	P/N	PART NAME	P/N
Natural Gas (NG) Pilot Assembly	O-401	TC Line Red	M46-701
Propane (LP) Pilot Assembly	O-402	TC Line Yellow	M46-702
Receiver Module (Maxitrol)	M46-504	Thermocouple Interrupter Block	M46-703
Gas Valve (Maxitrol)	M46-515	8-Wire Connecting Cable	M46-704
Remote Handset (Maxitrol)	O46-507		

## ONE6 OUTDOOR - REPLACEMENT PARTS

PART NAME	P/N	PART NAME	P/N
Burner Orifice (NG)	NGO-16	Firebox Enamel Panel - Rear	16-201
Burner Orifice (LP)	LPO-16	Firebox Enamel Panel - Left	16-202
Burner Glass Media (Clear/Mixed)	16O-200	Firebox Enamel Panel - Right	16-203
Burner Module (NG)	16O-301	Burner Module (LP)	16O-302
Glass Shield - 16	16O-975		

## TWENTY6 OUTDOOR - REPLACEMENT PARTS

PART NAME	P/N	PART NAME	P/N
Burner Orifice (NG)	NGO-26	Firebox Enamel Panel - Rear	26O-201
Burner Orifice (LP)	LPO-26	Firebox Enamel Panel - Left	26O-202
Burner Glass Media (Clear/Mixed)	26O-200	Firebox Enamel Panel - Right	26O-203
Burner Module (NG)	26O-301	Burner Module (LP)	26O-302
Glass Shield - 26	26O-975		

## FORTY6 OUTDOOR - REPLACEMENT PARTS

PART NAME	P/N	PART NAME	P/N
Burner Orifice (NG)	NGO-46	Firebox Enamel Panel - Rear	46O-201
Burner Orifice (LP)	LPO-46	Firebox Enamel Panel - Left	46O-202
Burner Glass Media (Clear/Mixed)	46O-200	Firebox Enamel Panel - Right	46O-203
Burner Module (NG)	46O-301	Burner Module (LP)	46O-302
Glass Shield - 46	46O-975		

For replacement parts and customer service contact your SÓLAS dealer or:

**SÓLAS, LLC**  
 4 Technology Drive,  
 West Lebanon, NH 03784

(T) 603-298-5169  
 (F) 603-298-9246  
[sales@solasfires.com](mailto:sales@solasfires.com)

# CONTROL SCHEMATIC

**Caution:** Label all wires prior to disconnection when servicing the controls. Wiring errors can cause improper and dangerous operation. Verify proper operation after servicing.

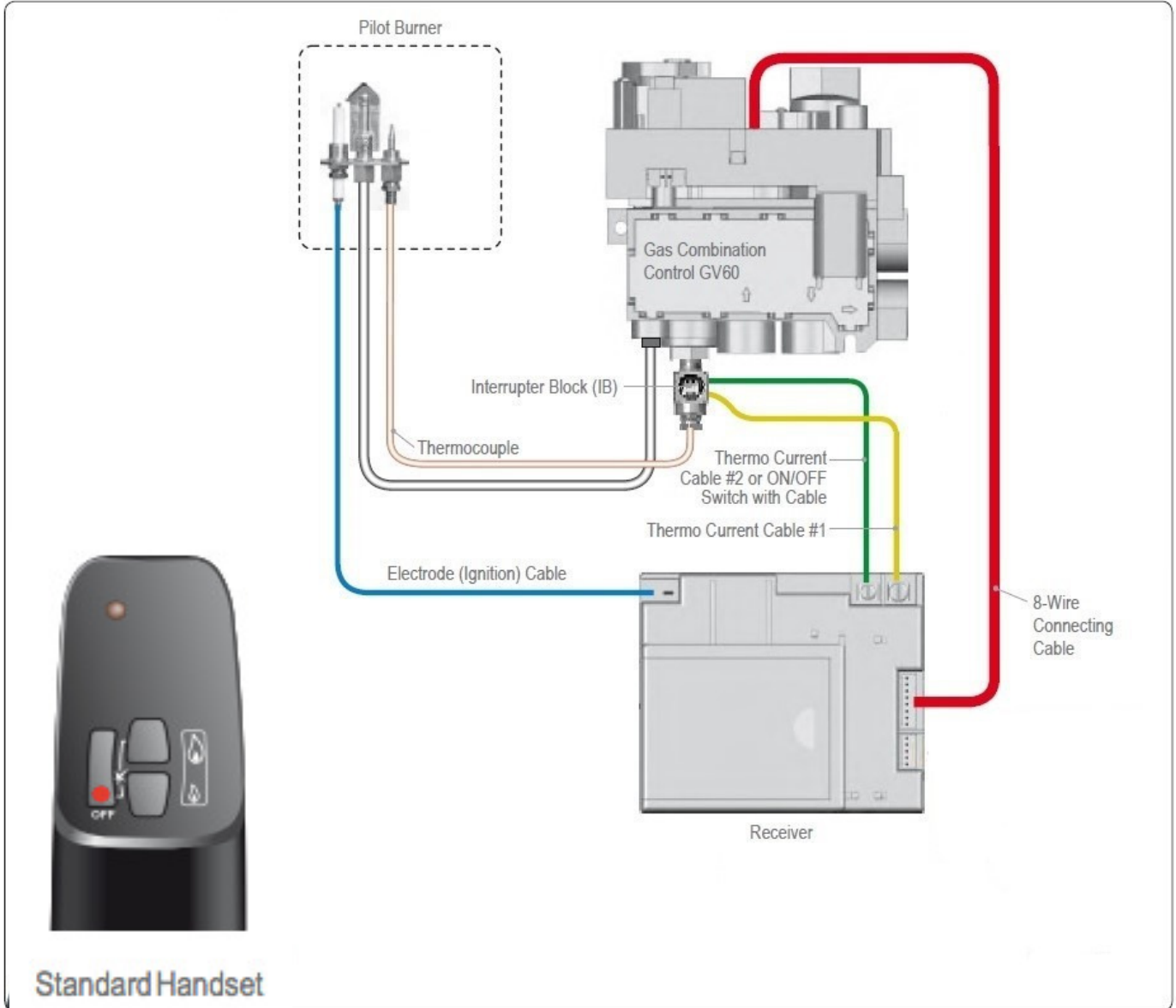

# INSTALLATION RECORD

The installer should complete the form below that describes the details of the installation. Having this written record of installation information available will greatly expedite trouble-shooting should any problem arise with your stove. The installer should keep a duplicate of this form for their records.

Date Purchased: \_\_\_\_\_

Dealer: \_\_\_\_\_

Date Installed: \_\_\_\_\_

Installer: \_\_\_\_\_

Fireplace Model: ONE<sup>6</sup> OUTDOOR TWENTY<sup>6</sup> OUTDOOR FORTY<sup>6</sup> OUTDOOR  
(circle one)

Serial Number: \_\_\_\_\_

Fuel: (circle one)  Natural Gas (NG)  Propane (LP)

Inlet Pressure (after installation): \_\_\_\_\_ in. WC

Manifold Pressure (after Installation): High Fire: \_\_\_\_\_ in. WC

Low Fire: \_\_\_\_\_ in. WC

Altitude: (feet above sea level) \_\_\_\_\_

Was the stove de-rated? (circle one)  Yes  No

If the stove was de-rated, to what orifice size? \_\_\_\_\_

Other installation notes: \_\_\_\_\_

---

---

---

---

# WARRANTY INFORMATION

## THE WARRANTY

SÓLAS, LLC, a division of Progressive Manufacturing, Inc. ("SÓLAS"), Limited Lifetime Warranty warrants your SÓLAS brand gas fireplace ("Product") to be free from defects in materials and workmanship at the time of manufacture. The Product body and firebox carry the Limited Lifetime Warranty on workmanship defects causing loss of structural integrity. Ceramic glass carries the Limited Lifetime Warranty against thermal breakage only. After installation, if covered components manufactured by SÓLAS are found to be defective in material or workmanship during the Limited Lifetime Warranty period and while the Product remains at the site of the original installation, SÓLAS will, at its option, repair or replace the covered components. If repair or replacement is not commercially practical, SÓLAS will, at its option, refund the purchase price or wholesale price of the SÓLAS product, whichever is applicable. SÓLAS will also pay their prevailing labor rates, as determined in its sole discretion, incurred in repairing or replacing such components during the warranty period. THERE ARE EXCLUSIONS AND LIMITATIONS to this Limited Lifetime Warranty as described herein.

## COVERAGE COMMENCEMENT DATE

Warranty coverage begins on the date of installation. The warranty shall commence no later than 24 months following the date of product shipment from SÓLAS, regardless of the installation date.

## EXCLUSIONS AND LIMITATIONS

This Limited Lifetime Warranty applies only if the Product is installed in the United States or Canada and only if operated and maintained in accordance with the printed instructions accompanying the Product and in compliance with all applicable installation and building codes and good trade practices. This warranty is non-transferable and extends to the original owner only. The Product must be purchased through a listed supplier of SÓLAS and proof of purchase must be provided. The Product body and firebox carry the Limited Lifetime Warranty. The following do not carry the Limited Lifetime Warranty, but are warranted as follows:

- **Burner** – Repair or replacement for three years from date of installation.
- **Gas components & electrical components** – Repair or replacement for one year from date of installation.
- **Blowers & remote controls** – Repair or replacement for one year from the date of installation.
- **Porcelain Firebox Liners** – Replacement for one year against cracking or breakage due to thermal stress from date of installation. Excludes surface and hairline cracks and scratches or slight color changes that do not affect the operation or safety of the unit.
- **Gaskets** – Repair or replacement for one year from the date of installation.
- **Surrounds** – Replacement for one year against cracking or breakage due to thermal stress. Excludes surface and hairline cracks and scratches or slight color changes that do not affect the operation or safety of the unit.
- **Labor coverage** – Prevailing SÓLAS rates apply for the warranty period of the component. SÓLAS will not be liable for travel costs for service work.

SÓLAS will not be responsible for: (a) damages caused by normal wear and tear, accident, riot, fire, flood, or acts of God; (b) damages caused by abuse, negligence, misuse, or unauthorized alteration or repair of the Product affecting its stability or performance. The Product must be subjected to normal use. The product is designed to burn either natural or propane gas only. Burning conventional fuels such as wood, coal or any other solid fuel will cause damage to the Product, will produce excessive temperatures and could result in a fire hazard. (c) Damages caused by failing to provide proper maintenance and service in accordance with the instructions provided with the Product; (d) damages, repairs or inefficiency resulting from faulty installation or application of the Product.

Discoloration and some minor expansion, contraction, or movement of certain parts and resulting noise is normal and not a defect, and, therefore, not covered under warranty. The installer must ensure the appliance is burning as per the rating tag at the time of installation. Over-firing (operation above the listed BTU rate) of this appliance can cause serious damage and will nullify this warranty.

This warranty is void if:

- The unit has been operated in atmospheres contaminated by chlorine, fluorine or other damaging chemicals.
- The unit is subject to submersion in water or prolonged periods of dampness or condensation.
- Any damage to the unit, combustion chamber, heat exchanger or other components due to water or weather damage which is the result of, but not limited to improper chimney/venting installation.

Damage to stainless steel, gold, nickel or porcelain enameled surfaces caused by fingerprints, scratches, melted items, or other external sources left on these surfaces from the use of cleaners is not covered in this warranty.

SÓLAS is not responsible for inadequate fireplace system draft caused by air conditioning and heating systems, mechanical ventilation systems, or general construction conditions which may generate negative pressure in the room in which the appliance is installed. Additionally, SÓLAS assumes no responsibility for drafting conditions caused by venting configurations, adjoining trees or buildings, adverse wind conditions or unusual environmental factors and conditions that affect the operation of the unit. This Limited Lifetime Warranty covers only parts and labor as provided herein. In no case shall SÓLAS be responsible for materials, components, or construction, which are not manufactured or supplied by SÓLAS or for the labor necessary to install, repair, or remove such materials, components, or construction. Additional utility bills incurred due to any malfunction or defect in equipment are not covered by this warranty. All replacement or repair components will be shipped F.O.B. from the nearest stocking SÓLAS facility.

## LIMITATION ON LIABILITY

It is expressly agreed and understood that SÓLAS' sole obligation and the purchaser's exclusive remedy under this warranty, under any other warranty, expressed or implied, or in contract, tort or otherwise, shall be limited to replacement, repair, or refund, as specified herein.

In no event shall SÓLAS be liable for any incidental or consequential damages caused by defects in the Product, whether such damage occurs or is discovered before or after repair or replacement, and whether such damage is caused by SÓLAS' negligence. SÓLAS has not made and does not make any representation or warranty of fitness for a particular use or purpose, and there is no implied condition of fitness for a particular purpose.

SÓLAS makes no expressed warranties except as stated in this Limited Lifetime Warranty. The duration of any implied warranty is limited to the duration of this expressed warranty.

No one is authorized to change this Limited Lifetime Warranty or to create for SÓLAS any other obligation or liability in connection with the Product. Some states and provinces do not allow the exclusion or limitation of incidental or consequential damages, so the above limitations or exclusions may not apply to you. The provisions of this Limited Lifetime Warranty are in addition to and not a modification of or subtraction from any statutory warranties and other rights and remedies provided by law.

## INVESTIGATION OF CLAIMS AGAINST WARRANTY

SÓLAS reserves the right to investigate any and all claims against this Limited Lifetime Warranty and to decide, in its sole discretion, upon the method of settlement.

To receive the benefits and advantages described in this Limited Lifetime Warranty, the appliance must be installed and repaired by a licensed contractor approved by SÓLAS.

Contact SÓLAS at the address provided herein to obtain a listing of approved dealers/distributors. **SÓLAS shall in no event be responsible for any warranty work done by a contractor that is not approved without first obtaining SÓLAS' prior written consent.**

## HOW TO REGISTER A CLAIM AGAINST WARRANTY

In order for any claim under this warranty to be valid, you must contact the SÓLAS dealer/distributor from which you purchased the product. If you cannot locate the dealer/distributor, then you must notify SÓLAS in writing. SÓLAS must be notified of the claimed defect in writing within 90 days of the date of failure. Notices should be directed to the SÓLAS Warranty Department at 4 Technology Drive, Suite 5, West Lebanon, NH 03784 or visit our website at [www.SOLASfires.com](http://www.SOLASfires.com).

## SÓLAS, LLC

4 Technology Drive,  
West Lebanon, NH 03784

(T) 603-298-5169

(F) 603-298-9246

[www.SOLASfires.com](http://www.SOLASfires.com)