

**IMPORTANT: Due to Raw Material Fluctuation, Catalog Prices Below May Not Be Accurate.
GO TO WWW.OUTWATER.COM FOR THE MOST UP-TO-DATE PRICES**



Family Owned & Operated
OUTWATER
INDUSTRIES
EST. 1972



1-800-631-8375
www.outwater.com

Perfecting motion 

IMPORTANT: Due to Raw Material Fluctuation, Catalog Prices Below May Not Be Accurate. GO TO WWW.OUTWATER.COM FOR THE MOST UP-TO-DATE PRICES

Concealed Hinges, Drawer Slides & Lift Systems



INDEX

<p>What Do You Need To Know To Choose A Hinge?</p>  <p>See Page 3</p>	<p>Plate Combinations & Mounting Options</p>  <p>See Page 4</p>	<p>Euro Hinge Stock Program</p>  <p>See Page 5</p>	<p>110° CLIP top & CLIP top BLUMOTION Hinges</p>  <p>See Page 6</p>
<p>170° CLIP top Hinges</p>  <p>See Page 6</p>	<p>95° CLIP top & CLIP top BLUMOTION Hinges For Thick Doors</p>  <p>See Page 7</p>	<p>95° CLIP top & CLIP top BLUMOTION Inset Blind Corner Hinge</p>  <p>See Page 7</p>	<p>60° CLIP top Bi-Fold Hinge</p>  <p>See Page 8</p>
<p>125°, 155° CLIP top & CLIP top BLUMOTION Zero Protrusion Hinges</p>  <p>See Pages 8-9</p>	<p>95° CLIP top Mini Hinge</p>  <p>See Page 10</p>	<p>95° CLIP top Glass Door Hinge</p>  <p>See Page 10</p>	<p>100° CLIP Hinge</p>  <p>See Page 10</p>
<p>110° CLIP top BLUMOTION for Thin Doors</p>  <p>See Page 11</p>	<p>CLIP top BLUMOTION Angled Hinges</p>  <p>See Page 12</p>	<p>Plates & Assembly Aids</p>  <p>See Pages 13-14</p>	<p>Add-On BLUMOTION Soft Close Adapter</p>  <p>See Page 15</p>
<p>COMPACT BLUMOTION Hinges for Face Frame Cabinets</p>  <p>See Pages 16-17</p>	<p>TANDEM plus BLUMOTION Concealed Drawer Slides</p>  <p>See Pages 18-21</p>	<p>Tip-On BLUMOTION for Movento</p>  <p>See Page 22</p>	<p>LEGRABOX Premium Metal Drawer System</p>  <p>See Pages 30-37</p>
		<p>AVENTOS Lift Systems</p>  <p>See Pages 23-29</p>	

IMPORTANT: Due to Raw Material Fluctuation, Catalog Prices Below May Not Be Accurate. GO TO WWW.OUTWATER.COM FOR THE MOST UP-TO-DATE PRICES

Concealed Hinges



CLIP top & CLIP top BLUMOTION

PRODUCT FEATURES:

All hinge and plate applications have 3D adjustment • Face Frame and Frameless applications • Full & partial overlay and inset applications
Integrated BLUMOTION or add on BLUMOTION • Meets ANSI/BHMA A156.9-2001 • Limited Lifetime Warranty on all Hinges

What Do You Need To Know To Choose A Hinge?



1. What Is Your Cabinet Construction?

Face Frame

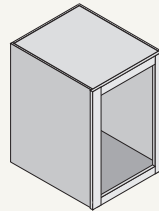

Industry Standard Frame Size:
3/4" thick x 1-1/2" wide
but the Hinge Program will work with a range of Frame Thickness' & Widths

Frameless/Panel

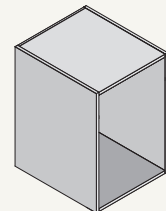

Industry Standard Side Panel Thickness:
5/8" (16mm) thick or 3/4" (19mm) thick
but each hinge will work with a range of side panel thicknesses

2. What Is Your Application?

Full Overlay

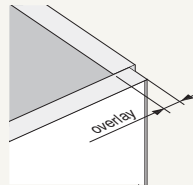

Partial/Twin Overlay

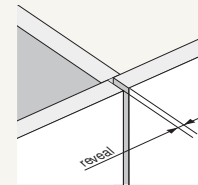

For Single or Double Doors

Inset

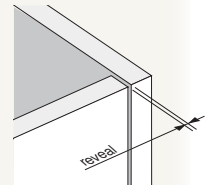

3. What Is Your Degree of Opening?

95°



- CLIP top
- CLIP top BLUMOTION
- Mini Hinge
- Glass Door Hinge
- Blind Corner

100°



- Basic Economy CLIP Hinge

110°



- CLIP top
- CLIP top BLUMOTION

125°



- Zero protrusion with specialty application options

155°



- Zero protrusion with specialty application options

170°



- CLIP top
- BLUMOTION Accessory Option

60°



- Bi-Fold door hinge with BLUMOTION accessory option

Angled Hinges

- For irregular shaped cabinets with BLUMOTION accessory option

4. What Dimensions Are Needed?

Overlay

Ranges will vary from hinge to hinge. See product charts and planning tools.

Door Thicknesses

See product charts and planning tools.
Note: Also needed, is the face frame width for face frame applications and the side panel thickness for frameless applications.

Reveal

The side-to-side adjustment feature will allow you to achieve a ± 2 mm adjustment. See product charts and planning tools for reveal ranges.

Boring Distance

The boring distance is variable, but your overlay & hinge selection will give guidance as to what the boring distance should be.

CONVERSION CHART: MM & INCHES

MM	2	3	6	8	9	13	16	17.5	19	20	22	24	25.4
INCH	3/32"	1/8"	1/4"	5/16"	11/32"	1/2"	5/8"	11/16"	3/4"	25/32"	7/8"	15/16"	1"
DECIMAL	.094"	.125"	.25"	.688"	.344"	.5"	.625"	.313"	.75"	.781"	.875"	.938"	1.00"

IMPORTANT: Due to Raw Material Fluctuation, Catalog Prices Below May Not Be Accurate. GO TO WWW.OUTWATER.COM FOR THE MOST UP-TO-DATE PRICES

Concealed Hinges



CLIP top & CLIP top BLUMOTION

Hinge Plate Combinations

Full Overlay (0mm)
1 Option



0mm- Straight Arm Hinge
0mm- Height Mounting Plate

0 + 0 = 0

Partial/Half Overlay (9mm)
2 Options



0mm- Straight Arm Hinge
9mm- Height Mounting Plate

0 + 9 = 9



9mm- Half Cranked Hinge
0mm- Height Mounting Plate

9 + 0 = 9

Inset (18mm)
3 Options



0mm- Straight Arm Hinge
18mm- Height Mounting Plate

0 + 18 = 18



9mm- Half Cranked Hinge
9mm- Height Mounting Plate

9 + 9 = 18



18mm- Full Cranked Hinge
0mm- Height Mounting Plate

18 + 0 = 18

Hinge & Plate Mounting Options

Screw On

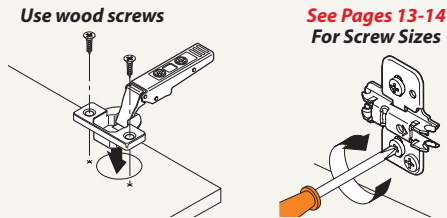

Press In

Pre-attached $\varnothing 8\text{mm}$ dowels installed with Blum knock-in tool or MINIPRESS with an insertion ram

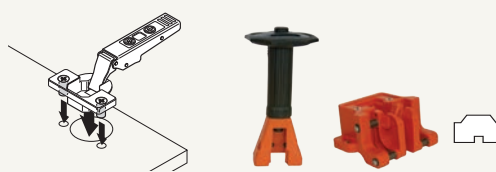

EXPANDO

Pre-attached expanding $\varnothing 5\text{mm}$ dowels

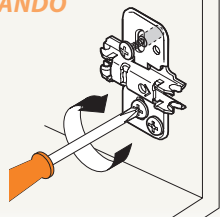

INSERTA

Tool-free attachment (cup expands into $\varnothing 35\text{mm}$ hole) CLIP top 110° hinges (lever expands into $\varnothing 8\text{mm}$ holes)

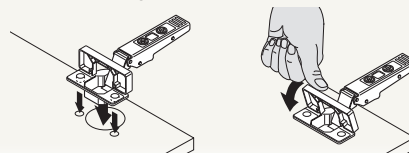

Useful Information

Hinge abbreviation key

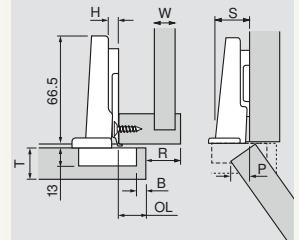

B	= Boring distance
H	= Plate height
OL	= Door overlay
P	= Door protrusion
R	= Reveal
S	= Side arm protrusion
T	= Door thickness
W	= Side panel width
FD	= Fixed distance

Hinges per door

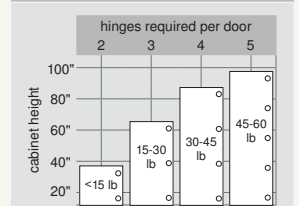

This chart can serve as a guide for determining the number of hinges per door. Note that door weight can also determine the number of hinges required.

NOTE: The distance between the top and bottom hinges must be greater than the width of the door

Cup boring information

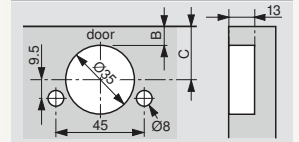

C = cup centerpoint					
20.5	21.5	22.5	23.5	24.5	25.5
13/16"	27/32"	7/8"	15/16"	31/32"	1"
3	4	5	6	7	8

B = bore distance

Three Dimensional Adjustment

Side Adjustment

Rotate front screw to increase or decrease door overlay $\pm 2\text{mm}$.

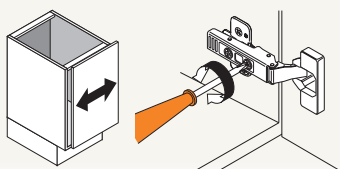

Height Adjustment

Rotate cam screw on mounting plate adjust door position ($\pm 2\text{mm}$). On non-cam mounting plates, loosen screws, adjust door and retighten screws.

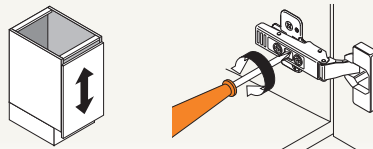

Depth Adjustment

Rotate rear Spiral Tech cam screw to adjust door position (+3mm, -2mm). For CLIP hinges, loosen rear screws, adjust door and retighten screws.



**IMPORTANT: Due to Raw Material Fluctuation, Catalog Prices Below May Not Be Accurate.
GO TO WWW.OUTWATER.COM FOR THE MOST UP-TO-DATE PRICES**

Concealed Hinges



EURO HINGE STOCK PROGRAM

Cabinet Application		Full Overlay	Partial/Twin Overlay	Partial/Twin Overlay	Inset	Inset	Inset
Mounting Plate Height		0mm and 3mm (Frameless)	9mm	0mm	0mm	9mm	18mm
Hinge Arm Configuration		Straight-Arm	Straight-Arm	Half-Cranked	Full-Cranked	Half-Cranked	Straight-Arm
<i>SC=Self Closing</i>							
	Frameless						
CLIP top BLUMOTION							
CLIP top BLUMOTION 110° (See Page 6)							
INSERTA	SC	71B3590	71B3590	71B3690	71B3790	71B3690	71B3590
Press-In	SC	71B3580	71B3580	71B3680	71B3780	71B3680	71B3580
Screw-On	SC	71B3550	71B3550	71B3650	71B3750	71B3650	71B3550
CLIP top BLUMOTION 95° (See Page 7)							
INSERTA	SC	71B9590	71B9590	71B9690	71B9790	71B9690	71B9590
CLIP top BLUMOTION 125° (See Page 8)							
Press-In	SC	71B7580D	71B7580D	-	-	-	71B7580D
CLIP top BLUMOTION 155° (See Page 9)							
INSERTA	SC	-	-	71B7690	-	71B7690	-
Press-In	SC	71B7580	71B7580	-	-	-	71B7580
Screw-On	SC	71B7590	71B7590	-	-	-	71B7590
CLIP top							
CLIP top 110° (See Page 6)							
INSERTA	SC	71T3590	71T3590	71T3690	71T3790	71T3690	71T3590
Press-In	SC	71T3580	71T3580	71T3680	71T3780	71T3680	71T3580
Screw-On	SC	71T3550	71T3550	71T3650	71T3750	71T3650	71T3550
CLIP top 170° (See Page 6)							
INSERTA	SC	71T6540B	71T6540B	71T6640B	-	71T6640B	71T6540B
Press-In	SC	71T6580	71T6580	71T6680	-	71T6680	71T6580
Screw-On	SC	71T6550	71T6550	71T6650	-	71T6650	71T6550
CLIP top 125° (See Page 8)							
Press-In	SC	71T7530D	71T7530D	-	-	-	71T7530D
CLIP top 155° (See Page 9)							
INSERTA	SC	71T7540N01	71T7540N01	71T640N01	-	71T640N01	71T7540N01
Press-In	SC	71T7530N	71T7530N	-	-	-	71T7530N
CLIP top 95° (See Page 7)							
INSERTA	SC	71T9590B	71T9590B	71T9690B	71T9790B	71T9690B	71T9590B
CLIP top 95° mini (See Page 10)							
Screw-On	SC	71T0550	71T0550	-	-	-	71T0550
CLIP top 95° glass door hinges (See Page 10)							
Screw-On	SC	75T4100	75T4100	75T4200	75T4300	75T4200	75T4100
CLIP							
CLIP 100° (See Page 10)							
Screw-On	SC	71M2550	71M2550	71M2650	71M2750	71M2650	71M2550

SPECIAL APPLICATIONS

CLIP top BLUMOTION							
CLIP top BLUMOTION 95° inset blind corner (See Page 7)							
CLIP top							
CLIP top 95° inset blind corner (See Page 7)							
CLIP top 60° bi-fold hinges (See Page 8)							

IMPORTANT: Due to Raw Material Fluctuation, Catalog Prices Below May Not Be Accurate. GO TO WWW.OUTWATER.COM FOR THE MOST UP-TO-DATE PRICES

Concealed Hinges



110° CLIP top & CLIP top BLUMOTION hinges

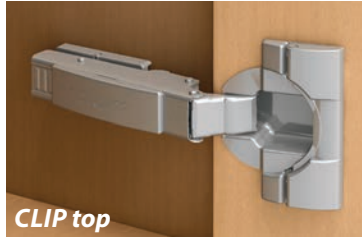

CLIP top

- 110° opening angle works in most cabinets applications
- **CLIP top** hinge is self closing
- **BLUMOTION** hinge has integrated soft close mechanism
- **Material:** All Metal Hinge, Nickel Plated

Dimension Guidelines

Door Thickness: 16mm to 26mm
Reveal: .5mm to 3.0mm
Bore Distance: 3mm to 7mm
Cup Depth: 13mm



CLIP top
BLUMOTION

Part #	Cabinet Application	Overlay / Reveal Range [^]	Cup Mounting	Works With Plate Height	Pieces Per Carton
CLIP top					
71T3550	Full Overlay with Straight Arm	8mm to 18mm (Face Frame) 5mm to 18mm (Frameless) Overlay	Screw On	0,3,4,5,6,9mm	250 pcs.
71T3580			Press In	0,3,4,5,6,9mm	250 pcs.
71T3590			INSERTA	0,3,4,5,6,9mm	250 pcs.
71T3650	Partial/Half Overlay with Half Cranked Arm	4.5mm to 8.5mm Overlay	Screw On	0mm	250 pcs.
71T3680			Press In	0mm	250 pcs.
71T3690			INSERTA	0mm	250 pcs.
71T3750	Inset with Full Cranked Arm	1mm to 4mm Reveal	Screw On	0mm	250 pcs.
71T3780			Press In	0mm	250 pcs.
71T3790			INSERTA	0mm	250 pcs.
CLIP top BLUMOTION					
71B3550	Full Overlay with Straight Arm	8mm to 18mm (Face Frame) 5mm to 18mm (Frameless) Overlay	Screw On	0,3,4,5,6,9mm	250 pcs.
71B3580			Press In	0,3,4,5,6,9mm	250 pcs.
71B3590			INSERTA	0,3,4,5,6,9mm	250 pcs.
71B3650	Partial/Half Overlay with Half Cranked Arm	4.5mm to 8.5mm Overlay	Screw On	0mm	250 pcs.
71B3680			Press In	0mm	250 pcs.
71B3690			INSERTA	0mm	250 pcs.
71B3750	Inset with Full Cranked Arm	1mm to 4mm Reveal	Screw On	0mm	250 pcs.
71B3780			Press In	0mm	250 pcs.
71B3790			INSERTA	0mm	250 pcs.

Accessories

86° Angle Restriction Clip For 110° Hinges



Function: Can be inserted or removed before or after the hinge has been installed

Material: Nylon
70T3553
Carton Quantity: 250

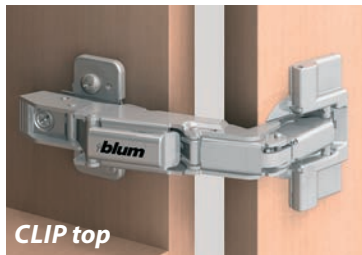

CLIP top

170° CLIP top hinges

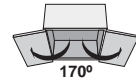

- Used when larger opening angle is required, such as last wall or base cabinet. This allows for greater access to the contents inside the cabinet.
- **CLIP top** hinge is self closing
- **Material:** All Metal Hinge, Nickel Plated

Dimension Guidelines

Door Thickness: 16mm to 24mm
Reveal: 0mm to 2.2mm
Bore Distance: 3mm to 8mm
Cup Depth: 11mm

Part #	Cabinet Application	Overlay / Reveal Range [^]	Cup Mounting	Works With Plate Height	Pieces Per Carton
CLIP top					
71T6550	Full Overlay with Straight Arm	8mm to 19mm (Face Frame) 5mm to 19mm (Frameless) Overlay	Screw On	0,3,4,5,6,9mm	125 pcs.
71T6580			Press In	0,3,4,5,6,9mm	125 pcs.
71T6540B			INSERTA	0,3,4,5,6,9mm	125 pcs.
71T6650	Partial/Half Overlay with Half Cranked Arm	4.5mm to 9.5mm Overlay	Screw On	0mm	125 pcs.
71T6680			Press In	0mm	125 pcs.
71T6640B			INSERTA	0mm	125 pcs.
71T6650	Inset Application (Frameless Only)	0.5mm to 4.5mm Reveal	Screw On	9mm	125 pcs.
71T6680			Press In	9mm	125 pcs.
71T6640B			INSERTA	9mm	125 pcs.

Accessories

130° Angle Restriction Clip For 170° Hinges

Function: Can be inserted or removed before or after the hinge has been installed

Material: Nylon

70.6103
Carton Quantity: 250



ADD ON BLUMOTION Soft Close Component

Function: Additional clearance of 41mm needed above and below for interior roll out

Material: Nylon Enclosed In a Steel Housing

973A6000
Carton Quantity: 25



[^]Above overlay & reveal ranges are based on a neutral side adjustment position

IMPORTANT: Due to Raw Material Fluctuation, Catalog Prices Below May Not Be Accurate. GO TO WWW.OUTWATER.COM FOR THE MOST UP-TO-DATE PRICES

Concealed Hinges



95° CLIP top & CLIP top BLUMOTION hinges For Thick Doors



- 95° opening angle works with doors up to 30mm thick
- **CLIP top** hinge is self closing
- **BLUMOTION** hinge has integrated soft close mechanism
- **Material:** All Metal Hinge, Nickel Plated



Dimension Guidelines

Door Thickness: 19mm to 30mm
Reveal: .4mm to 3.8mm
Bore Distance: 3mm to 7mm
Cup Depth: 13mm

Part #	Cabinet Application	Overlay / Reveal Range [^]	Cup Mounting	Works With Plate Height	Pieces Per Carton
CLIP top					
71T9590B	Full Overlay with Straight Arm	8mm to 18mm (Face Frame) 5mm to 18mm (Frameless) Overlay	INSERTA	0,3,4,5,6,9mm	250 pcs.
71T9690B	Partial/Half Overlay with Half Cranked Arm	4.5mm to 8.5mm Overlay	INSERTA	0mm	50 pcs.
71T9790B	Inset with Full Cranked Arm	1mm to 4mm Reveal	INSERTA	0mm	50 pcs.
CLIP top BLUMOTION					
71B9590	Full Overlay with Straight Arm	8mm to 18mm (Face Frame) 5mm to 18mm (Frameless) Overlay	INSERTA	0,3,4,5,6,9mm	250 pcs.
71B9690	Partial/Half Overlay with Half Cranked Arm	4.5mm to 8.5mm Overlay	INSERTA	0mm	50 pcs.
71B9790	Inset with Full Cranked Arm	1mm to 4mm Reveal	INSERTA	0mm	50 pcs.

95° CLIP top & CLIP top BLUMOTION Inset Blind Corner Hinge

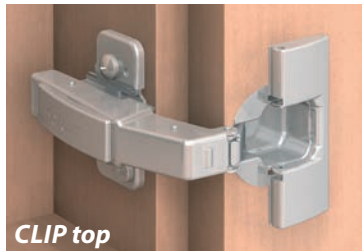

- Used in blind corner cabinets with inset doors
- The blind corner cabinet typically is the one leading up to the lazy susan cabinet
- The same hinge can be used in flush and offset door applications
- **CLIP top** hinge is self closing
- **BLUMOTION** hinge has integrated soft close mechanism
- **Material:** All Metal Hinge, Nickel Plated



Dimension Guidelines

Door Thickness: 16mm to 24mm
Reveal: .1mm to 1.3mm
Bore Distance: 3mm to 7mm
Cup Depth: 13mm

Part #	Cabinet Application	Overlay / Reveal Range [^]	Cup Mounting	Works With Plate Height	Pieces Per Carton
CLIP top					
79T9590	Inset	1mm to 5mm Reveal	INSERTA	0mm & 3mm	50 pcs.
CLIP top BLUMOTION					
79B9590	Inset	1mm to 5mm Reveal	INSERTA	0mm & 3mm	50 pcs.

Accessories

ADD-ON BLUMOTION Soft Close Component

Function: Additional clearance of 41mm needed above and below for interior roll out
Material: Nylon



970A1002
Carton Quantity: 50



[^]Above overlay & reveal ranges are based on a neutral side adjustment position

IMPORTANT: Due to Raw Material Fluctuation, Catalog Prices Below May Not Be Accurate. GO TO WWW.OUTWATER.COM FOR THE MOST UP-TO-DATE PRICES

Concealed Hinges



60° CLIP top Bi-Fold hinge

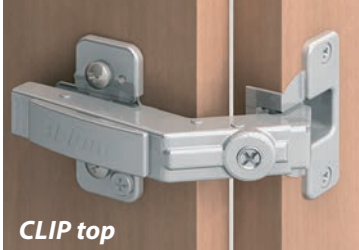

CLIP top

- Used in bi-fold doors or cabinets with pie cut lazy susans 155° or 170° hinge recommended for adjacent door.
- The spiral tech cam allows for +4/-7mm adjustment
- **CLIP top** hinge is self closing
- **Material:** All Metal Hinge, Nickel Plated

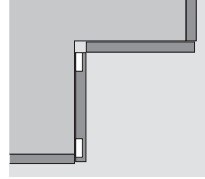

Dimension Guidelines

Door Thickness: 16mm to 21mm
Reveal: 1mm to 4mm
Bore Distance: 12.5mm center point from edge of door
Cup Depth: 11mm

Part #	Cabinet Application	Overlay / Reveal Range [^]	Cup Mounting	Works With Plate Height	Pieces Per Carton
CLIP top					
79T8530.10	Bi-Fold	Inside Corner Application	Press In	0mm	125 pcs.

125° CLIP top BLUMOTION Zero Protrusion hinge

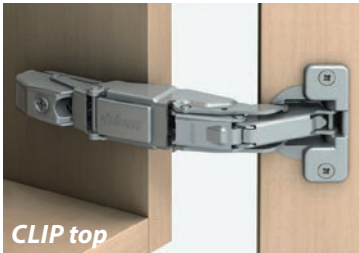
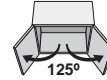

CLIP top

- Used in cabinets with interior roll outs
- For use with thicker doors
- **BLUMOTION** hinge has integrated soft close mechanism
- **Material:** All Metal Hinge, Nickel Plated

Dimension Guidelines

Door Thickness: up to 30mm**
Reveal: 0mm
Bore Distance: 3mm to 8mm
Cup Depth: 11.7mm

**** Door Thickness can be up to 34mm with use of 92° Angle Restriction Clip**

Part #	Cabinet Application	Overlay / Reveal Range [^]	Cup Mounting	Works With Plate Height	Pieces Per Carton
CLIP top BLUMOTION					
71B7580D	Full Overlay With Straight Arm	11mm to 19mm (Face Frame / Frameless)	Press In	0mm & 3mm	25 pcs.

Accessories for CLIP top BLUMOTION hinges

92° Angle Restriction Clip

Function: Ideally used when door is hitting the cabinet. Can be inserted or removed before or after the hinge has been installed.

Material: Nylon

70T7553

Carton Quantity: 250



Cover Cap

Function: Hinge arm cover cap.

Material: Steel

70.4503

Carton Quantity: 1000



^Above overlay & reveal ranges are based on a neutral side adjustment position

IMPORTANT: Due to Raw Material Fluctuation, Catalog Prices Below May Not Be Accurate. GO TO WWW.OUTWATER.COM FOR THE MOST UP-TO-DATE PRICES

Concealed Hinges



155° CLIP top & CLIP top BLUMOTION Zero Protrusion hinges

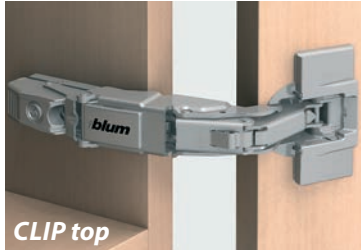
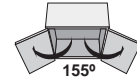

- Used with cabinet roll outs and tall pantry cabinets without having to use special blocks
- **CLIP top** hinge is self closing
- **BLUMOTION** hinge has integrated soft close mechanism
- **Material:** All Metal Hinge, Nickel Plated

Dimension Guidelines

Door Thickness: 16mm to 24mm
Reveal: 0mm
Bore Distance: 3mm to 8mm
Cup Depth: 11.7mm

Part #	Cabinet Application	Overlay / Reveal Range [^]	Cup Mounting	Works With Plate Height	Pieces Per Carton
CLIP top					
71T7590	Full Overlay with Straight Arm	11mm to 19mm (Face Frame / Frameless)	INSERTA	0mm & 3mm	25 pcs.
CLIP top BLUMOTION					
71B7690	Full Overlay/Partial Applications with Half Cranked Arm	4.5mm to 9.5mm (Face Frame / Frameless)	INSERTA	0mm	25 pcs.
71B7580	Full Overlay with Straight Arm	11mm to 19mm (Face Frame / Frameless)	Press In	0mm & 3mm	25 pcs.
71B7590	Full Overlay with Straight Arm	11mm to 19mm (Face Frame / Frameless)	INSERTA	0mm & 3mm	125 pcs.

Accessories for CLIP top & CLIP top BLUMOTION hinges

92° Angle Restriction Clip

Function: Ideally used when door is hitting the cabinet. Can be inserted or removed before or after the hinge has been installed.

Material: Nylon

70T7553.09

Carton Quantity: 250



110° Angle Restriction Clip

Function: Ideally used when door is hitting the cabinet. Can be inserted or removed before or after the hinge has been installed.

Material: Nylon

70T7553

Carton Quantity: 250

[^]Above overlay & reveal ranges are based on a neutral side adjustment position

IMPORTANT: Due to Raw Material Fluctuation, Catalog Prices Below May Not Be Accurate. GO TO WWW.OUTWATER.COM FOR THE MOST UP-TO-DATE PRICES

Concealed Hinges

blum



CLIP top

95° CLIP top Mini hinge

- Has 26mm cup for small frame doors
- Ideal for thinner frame doors that have glass insert
- **CLIP top** hinge is self closing
- **Material:** All Metal Hinge, Nickel Plated

Boring Pattern

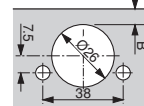

Dimension Guidelines

Door Thickness: 16mm to 26mm
Reveal: 1.1mm to 9.1mm
Bore Distance: 3mm to 5mm
Cup Depth: 12.5mm

Part #	Cabinet Application	Overlay / Reveal Range [^]	Cup Mounting	Works With Plate Height	Pieces Per Carton
CLIP top					
71T0550	Full Overlay with Straight Arm	7mm to 15mm (Face Frame) 4mm to 15mm (Frameless) Overlay	Screw On	0,3,4,5,6,9mm	50 pcs.

95° CLIP top Glass Door hinge



CLIP top

- Has 26mm cup- must use 26mm drill bit and not 1"
- Ideal for tempered glass doors
- Frameless cabinets only
- **CLIP top** hinge is self closing
- **Material:** All Metal Hinge, Nickel Plated

Boring Pattern

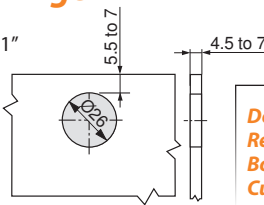

Dimension Guidelines

Door Thickness: 4.5mm to 7mm
Reveal: 0mm
Bore Distance: 5.5mm to 7mm
Cup Depth: N/A

Part #	Cabinet Application	Overlay / Reveal Range [^]	Cup Mounting	Works With Plate Height	Pieces Per Carton
CLIP top					
75T4100	Full Overlay with Straight Arm	9.5mm to 17mm (Face Frame) 6.5mm to 17mm (Frameless) Overlay	Screw On	0,3,6,9mm	50 pcs.
75T4200	Partial/Half Overlay with Half Cranked Arm	.5mm to 10mm Reveal	Screw On	0mm	50 pcs.
75T4300	Inset Application (Frameless Only)	1mm to 2.5mm Reveal	Screw On	0mm	50 pcs.

Installation screws to attach hinge cover caps: 605.1100 Included with hinges

Accessories

Cover Caps for Door Front (Required)

Round Shape

Finish: Polished Chrome

84.4140C

Carton Quantity: 50



Round Shape

Finish: Black

84.4140

Carton Quantity: 50

D Shape

Finish: Polished Chrome

84.4120

Carton Quantity: 50



100° CLIP hinges



CLIP top

- Economical Hinge
- Used in high volume commercial projects
- **CLIP hinge** is self closing
- **Material:** All Metal Hinge, Nickel Plated



Dimension Guidelines

Door Thickness: 16mm to 24mm
Reveal: .5mm to 3.6mm
Bore Distance: 3mm to 6mm
Cup Depth: 11mm

Part #	Cabinet Application	Overlay / Reveal Range [^]	Cup Mounting	Works With Plate Height	Pieces Per Carton
CLIP top					
71M2550	Full Overlay with Straight Arm	8mm to 17mm (Face Frame) 5mm to 17mm (Frameless) Overlay	Screw On	0,3,4,5,6,9mm	250 pcs.
71M2650	Partial/Half Overlay with Half Cranked Arm	4.5mm to 7.5mm Reveal	Screw On	0mm	250 pcs.
71M2750	Inset Application (Frameless Only)	1mm to 4mm Reveal	Screw On	0mm	250 pcs.

[^]Above overlay & reveal ranges are based on a neutral side adjustment position

IMPORTANT: Due to Raw Material Fluctuation, Catalog Prices Below May Not Be Accurate. GO TO WWW.OUTWATER.COM FOR THE MOST UP-TO-DATE PRICES

Concealed Hinges



110° CLIP top BLUMOTION for Thin Doors



- 110° opening angle
- Integrated **BLUMOTION** soft close mechanism
- Zero protrusion
- Compatible with clip mounting plate
- Works with particle board, MDF, HDF, HPL, mineral composites, granite stone, quartz stone, artificial stone & ceramic plates
- **Material:** Steel

Part #	Cabinet Application	Overlay / Reveal Range [^]	Cup Mounting	Works With Plate Height	Pieces Per Carton
CLIP top BLUMOTION					
71B453T	Full Overlay/ Partial/Half Overlay Inset Applications	8mm to 19mm 4.5mm to 9.5mm .5mm - 3.5mm Reveal	DOWELED	0mm 9mm 18mm	125 pcs.

Accessories for Thin Doors

85° Angle Restriction Clip

Function: Can be inserted or removed before or after the hinge has been installed

Material: Nylon
Color: Dark Gray

70T4503:
Carton Quantity: 250



92° Angle Restriction Clip

Function: Can be inserted or removed before or after the hinge has been installed

Material: Nylon
Color: Dust Gray

70T4503.09:
Carton Quantity: 250

[^]Above overlay & reveal ranges are based on a neutral side adjustment position

IMPORTANT: Due to Raw Material Fluctuation, Catalog Prices Below May Not Be Accurate. GO TO WWW.OUTWATER.COM FOR THE MOST UP-TO-DATE PRICES

Concealed Hinges



CLIP top BLUMOTION Angled Hinges



- Ideal for irregular shaped cabinets and can accommodate many different angles
- For frameless cabinets
- Need hinge, wedge spacer and plate
- The spiral tech cam allows for +/-7mm adjustment
- **BLUMOTION** hinge has integrated soft close mechanism
- **Material:** All Metal Hinge, Nickel Plated

Dimension Guidelines

Max Door Thickness: 19mm
 Reveal: N/A
 Bore Distance: 5mm to 11.5mm
 Cup Depth: 13mm

Part #	Angle	Cup Mounting	Pcs. Per Carton
CLIP top			
79B9494	Positive 15	INSERTA	50 pcs.
79B9595	Positive 20	INSERTA	50 pcs.
79B9596	Positive 30	INSERTA	50 pcs.
79B9496	Positive 30	INSERTA	50 pcs.
79B9698	Positive 45	INSERTA	50 pcs.
79B3598	Positive 45	INSERTA	50 pcs.
79B9498	Positive 45	INSERTA	50 pcs.
79B3493	Negative 15	INSERTA	50 pcs.
79B3491	Negative 30	INSERTA	50 pcs.
79B3490	Negative 45	INSERTA	50 pcs.

Wedge Spacers For Angled Hinges

Part #	Thickness	Angle	Pcs. Per Carton
CLIP top			
171A5500	2mm	-5	50 pcs.
171A5010	4mm	5	50 pcs.
171A5040	5mm	5	50 pcs.
171A5070	7mm	5	50 pcs.

See Pages 13-14 For Plates

POSITIVE ANGLES					NEGATIVE ANGLES		
	Maximum Overlay	Partial Overlay	Corner Merge	Inset Door	Mitered Corner	Maximum Overlay	Inset Door
10°	2	11	20	28		43	52
	79B9494	79B9494	79B9494	79B9494		79B3493	79B3493
	173H7100	173H7100	175H9190.22	175H9190.22		173H7100	173H7100
	171A5500	171A5500	171A5500	171A5500		171A5010	171A5010
15°						44	53
						79B3493	79B3493
						173H7100	175H9190.22
20°	4	13		31	37		54
	79B9494	79B9595		79B9595	79B9595		79B3493
	173H7100	173H7100		175H9190.22	175H9160		175H9160
	171A5070						11A5500
25°	5	14	23	31	38	46	55
	79B9496	79B9595	79B9596	79B9596	79B9596	79B3491	79B3491
	173H7100	173H7100	173H7100	175H9190.22	173H7100	173H7100	175H7190
	171A5500	171A5500	171A5500		171A5500	171A5040	171A5500
30°		15		32			
		79B9596		79B9596			
		173H7100		175H9190.22			
35°	7	16	25	33	40	48	
	79B9496	79B9596	79B9596	79B9596	79B9596	79B3491	
	173H7100	173H7100	173H7100	175H9190.22	173H7100	173H7100	
	171A5070	171A5010	171A5070	171A5010	171A5040	171A5500	
40°	8						
	79B9498						
	173H7100						
45°		18	26	35	41		
		79B3598	79B9698	79B3598	79B9698		
		173H7100	173H7100	175H9190.22	173H7100		

The chart on this page shows the hinge, plate and wedge (or spacer) needed for each angled application. The legend below shows the order of the part numbers.

NOTE: All 35mm and 8mm holes must be a minimum of 13mm deep

	Application Number
Hinge	CLIP top BLUMOTION Hinge
Plate	CLIP Mounting Plate
Wedge/Spacer	May or May Not Be Required

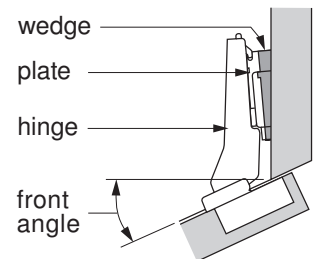

IMPORTANT: Due to Raw Material Fluctuation, Catalog Prices Below May Not Be Accurate. GO TO WWW.OUTWATER.COM FOR THE MOST UP-TO-DATE PRICES

Concealed Hinges



BLUM PLATES

Material: Nickel Plated Steel

Hinge Plate Combinations

Full Overlay: 0mm (1 Option)



0mm- Straight Arm Hinge
0mm- Height Mounting Plate

$0 + 0 = 0$

Partial/Half Overlay: 9mm (2 Option)



0mm- Straight Arm Hinge
9mm- Height Mounting Plate

$0 + 9 = 9$



9mm- Half Cranked Hinge
0mm- Height Mounting Plate

$9 + 0 = 9$

Inset: 18mm (3 Option)

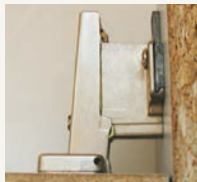

0mm- Straight Arm Hinge
18mm- Height Mounting Plate

$0 + 18 = 18$



9mm- Half Cranked Hinge
9mm- Height Mounting Plate

$9 + 9 = 18$

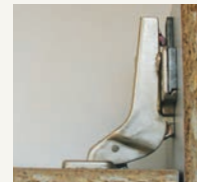

18mm- Full Cranked Hinge
0mm- Height Mounting Plate

$18 + 0 = 18$

Frameless/Panel Cabinet Mounting Plates

A. One Piece Wing

Height Adjustment: ±3mm

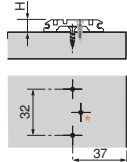

173L6100

Part #	Plate Height	Attachment	Pieces Per Carton
173L6100	0mm	Screw Size: #6 x 5/8"	500 pcs.
174E6100.01	0mm	EXPANDO Dowels Attached (5mm)	500 pcs.

Height Adjustment: ±2mm

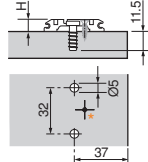

174E6100.01

B. Two Piece Wing

Height Adjustment: ±2mm

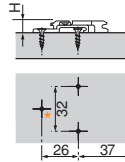

Part #	Plate Height	Attachment	Pieces Per Carton
175H7100	0mm	Screw Size: #6 x 5/8"	500 pcs.
175H7190	9mm	#6 x 5/8"	250 pcs.
175H9190.22	18mm	Screw Size: #7 x 5/8" or 5mm Euro Screw	250 pcs.

C. One Piece Wing With 5mm Screw

Height Adjustment: ±3mm

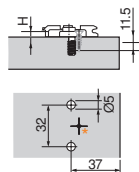

Part #	Plate Height	Attachment	Pieces Per Carton
175L8190	9mm	Pre-Mounted 5mm System Screws	250 pcs.

D. Cam Adjustable Wing

Cam Height Adjustment: ±2mm

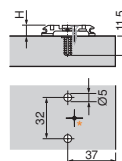
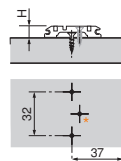

173H7100 & 173H7130

174H7100E & 174H7130E

Part #	Plate Height	Attachment	Pieces Per Carton
173H7100	0mm	Screw Size: #6 x 5/8"	500 pcs.
173H7130	3mm	#6 x 5/8"	500 pcs.
174H7100E	0mm	EXPANDO Dowels Attached (5mm)	500 pcs.
174H7130E	3mm	Attached (5mm)	500 pcs.

SCREWS SOLD SEPARATELY- SEE PAGE 20

IMPORTANT: Due to Raw Material Fluctuation, Catalog Prices Below May Not Be Accurate. GO TO WWW.OUTWATER.COM FOR THE MOST UP-TO-DATE PRICES

Concealed Hinges



BLUM PLATES

Material: Nickel Plated Steel

Face Frame Cabinet Adapter Plates

E. Cam Adjustable Center Mount

Cam Height Adjustment: $\pm 2\text{mm}$

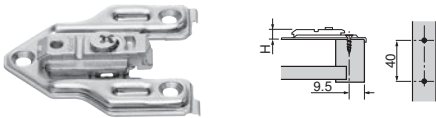

Part #	Plate Height	Attachment	Pieces Per Carton
175H6000	0mm	Screw Size: #7 x 3/4"	250 pcs.
175H6040	4.5mm		250 pcs.
175H6060	6mm		250 pcs.
175H6030	3mm		250 pcs.

F. Off-Center Plate

Cam Height Adjustment: $\pm 2\text{mm}$



Part #	Plate Height	Attachment	Pieces Per Carton
175H6600	0mm	Screw Size: #7 x 3/4"	250 pcs.

G. Inset Plate

Cam Height Adjustment: $\pm 2\text{mm}$

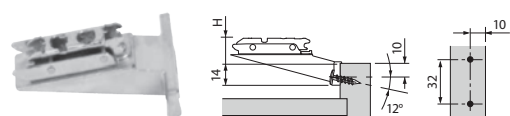

Part #	Plate Height	Attachment	Pieces Per Carton
175H5030.21	9mm	Screw Size: #8 x 3/4" Truss Head Screw	250 pcs.

SCREWS SOLD SEPARATELY- SEE PAGE 20

Use with partial overlay hinges only

ASSEMBLY AIDS

INSERTA Boring Template

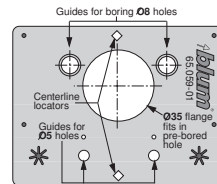
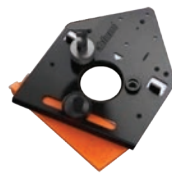

- For boring $\varnothing 8\text{mm}$ dowel holes after $\varnothing 35\text{mm}$ hole is bored
- Boring distance adjusts from 2mm to 8mm
- Also bores $\varnothing 5\text{mm}$ holes for system screw mounting plates
- Includes drill stop collar to pilot bore $\varnothing 2.5\text{mm}$ for screw-on plates

Part #	Description
65.059A	INSERTA Boring Template

PLATEMATE

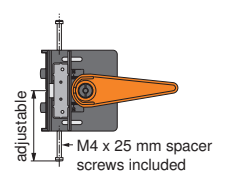

- Boring template for all blum face frame adapter plates
- Clamps to the frame with cam lever
- Adjustment knob accommodates frame thickness of 5/8" to 1"
- Spacer screws permit quick use without measuring
- Includes 2.5mm pilot bit and drill bit extension

Part #	Description
65.5030.01	PLATEMATE

ECODRILL

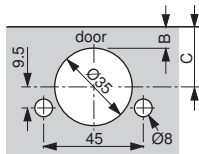

- Simple device for boring Blum hinge pattern
- Driven by electric/cordless drill (18V or higher)
- Boring distance adjusts from 2mm to 8mm
- Clamps to various door thicknesses up to 40mm
- Includes drill bits (pre-installed) and two Torx bits

Part #	Description
M31.1000	ECODRILL
M31.ZB35.02	Replacement $\varnothing 35\text{mm}$ bit
M31.ZB08.02	Replacement $\varnothing 8\text{mm}$ bit
MZW.1300	Tool Set

Mounting Plate Template

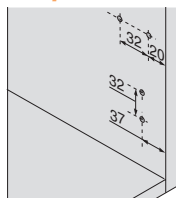
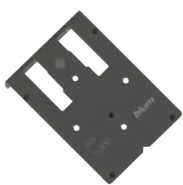

- Use with CLIP mounting plates on overlay applications on panel cabinets
- For wing mounting plates (37mm setback) and in-line mounting plates (20mm setback)
- Simple location of mounting plate screw positions
- Pilot bore $\varnothing 2.5\text{mm}$ holes for wood screws

Part #	Description
65.5300	Mounting Plate Template

ACCESSORIES

Hinge Arm Cover Caps

Works with:
100°, 110°, Bi-Fold,
Blind Corner &
Angled
Hinges

Material: Steel

70.1503:
Carton Quantity: 1000

Works with:
125° & 155°
Hinges

Material: Steel

70.7503:
Carton Quantity: 1000

Works with:
170° Hinges

Material: Steel

80.6507:
Carton Quantity: 1000

Works with:
Thin Door
Hinges

Material: Steel

70.4503:
Carton Quantity: 1000

IMPORTANT: Due to Raw Material Fluctuation, Catalog Prices Below May Not Be Accurate. GO TO WWW.OUTWATER.COM FOR THE MOST UP-TO-DATE PRICES

Concealed Hinges



TIP-ON for doors

Works with **BLUM CLIP top** Self Close Hinges



Designed for face frame or frameless cabinets applications

- Can be recess or surface mounted (with adapter plate)
- Works for both overlay & inset applications
- Adjustment range: +4 mm to -1 mm
- For doors widths greater than 10"
- **Material:** Grey Nylon



Note: For face frame applications, blocking may be required

Part #	Description	Pieces Per Carton
956A1006	TIP-ON Mechanism	50 pcs.
956A1501 [^]	Surface Mount Adapter Plate	50 pcs.

[^] Mounts w/ #6 x 5/8" wood screw (sold separately), see below

Installation Dimensions

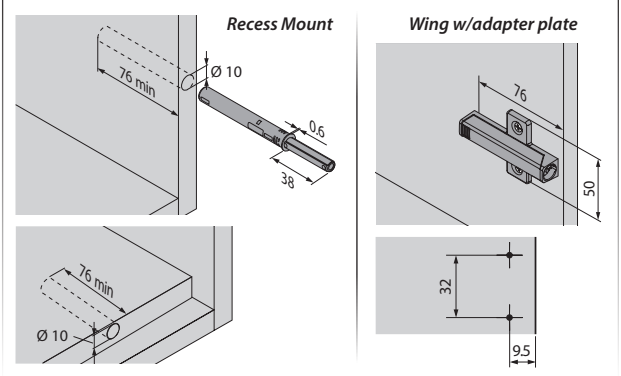

Add-On BLUMOTION Soft Close Adapter



Available for face frame or frameless cabinets applications

- Offers the same quality of motion as drawer systems with **BLUMOTION**
- Adjustment to various door sizes and weights (+3/-7 mm range)
- Installed onto hinge-side panel
- **Material:** Nickel plated steel housing w/grey nylon plunger

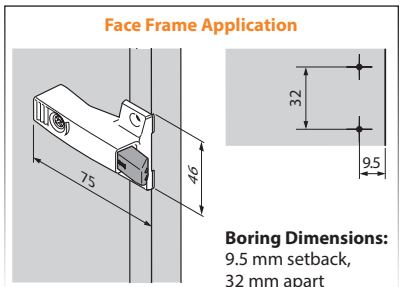
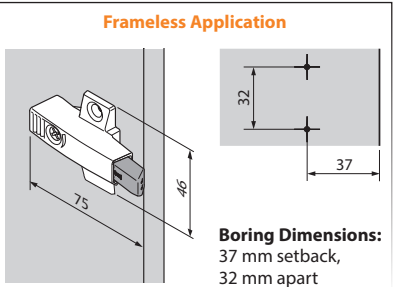

Part #	Application	Attachment	Pieces Per Carton
971A0500	Frameless	#6 x 5/8 wood screw	25 pcs.
971A0700	Face Frame	#6 x 5/8 wood screw	25 pcs.

#6 x 5/8" wood screw (sold separately), see below

#6 x 5/8" Wood Screw (sold separately)
606N-100
 Screws are packed 100 per carton. No broken boxes

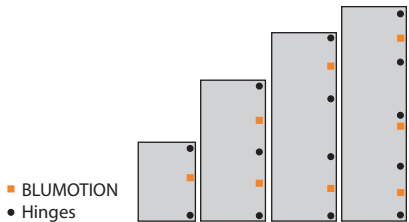

IMPORTANT: Due to Raw Material Fluctuation, Catalog Prices Below May Not Be Accurate. GO TO WWW.OUTWATER.COM FOR THE MOST UP-TO-DATE PRICES

Compact Hinges



COMPACT BLUMOTION Hinges For Face Frame Cabinets

- **BLUMOTION** integrated into the hinge cup
- Deactivation switch for small/lightweight doors
- Overload safety feature to protect from damage due to slamming
- One piece hinge

Wraparound Hinges

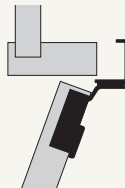

Edge Mount Hinges

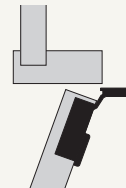

Face Mount Hinges

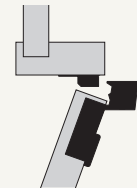

39C Series Hinge

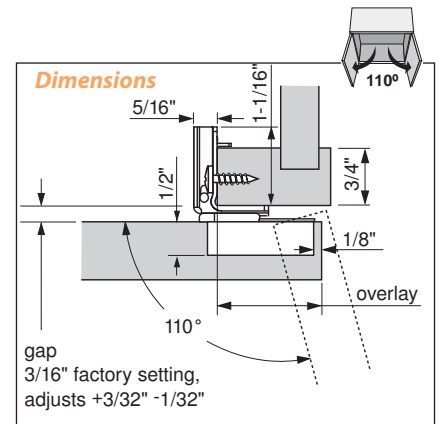
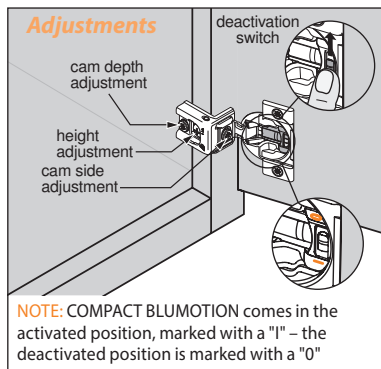

Part #	Cabinet Application	Overlay	Cup Mounting	Hinge Type	Pieces Per Carton
39C358B.16	Full Overlay	1"	Press In	Wrap Around	300 pcs.
39C358B.20		1-1/4"	Press In	Wrap Around	300 pcs.
39C358B.21		1-5/16"	Press In	Wrap Around	300 pcs.
39C358B.22		1-3/8"	Press In	Wrap Around	300 pcs.
39C358B.24		1-1/2"	Press In	Wrap Around	300 pcs.
39C358B.25		1-9/16"	Press In	Wrap Around	300 pcs.

Note: Screw on cup mount is available minimums apply- please inquire

Dimension Guidelines

Maximum Door Thickness: 3/4"
Minimum Reveil: 7/32"
(Based on 3/4" door)
Cup Depth: 1/2"
Screw Size: #6 x 5/8" Wood Screw
(#606N-100, See Page 20)

38N Series Hinge

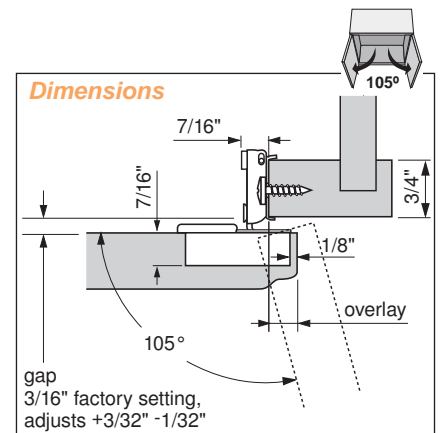
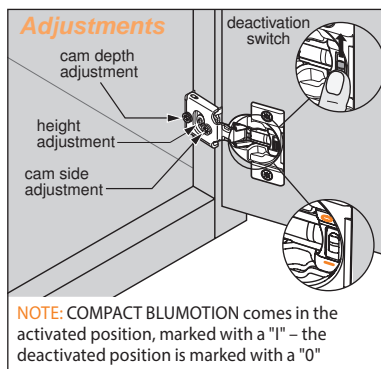
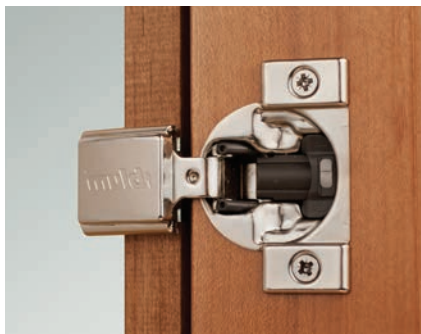

Part #	Cabinet Application	Overlay	Door Protrusion	Cup Mounting	Hinge Type	Pieces Per Carton
38N358B.05	Partial Overlay	5/16"	5/16"	Press In	Wrap Around	250 pcs.
38N358B.06		3/8"	3/8"	Press In	Wrap Around	250 pcs.
38N358B.08		1/2"	1/8"	Press In	Wrap Around	250 pcs.
38N358BE08		1/2"	1/8"	Press In	Edge Mount	250 pcs.
38N358B.10		5/8"	0	Press In	Wrap Around	250 pcs.
38N358B.12		3/4"	0	Press In	Wrap Around	250 pcs.

Note: Screw on cup mount is available minimums apply- please inquire

Dimension Guidelines

Maximum Door Thickness: 3/4"
Minimum Reveil: 9/32"
(Based on 3/4" door)
Cup Depth: 7/16"
Screw Size: #6 x 5/8" Wood Screw
(#606N-100, See Page 20)

IMPORTANT: Due to Raw Material Fluctuation, Catalog Prices Below May Not Be Accurate. GO TO WWW.OUTWATER.COM FOR THE MOST UP-TO-DATE PRICES

Compact Hinges



COMPACT BLUMOTION Hinges For Face Frame Cabinets

- **BLUMOTION** integrated into the hinge cup
- Deactivation switch for small/lightweight doors
- Overload safety feature to protect from damage due to slamming
- One piece hinge

Wraparound Hinges

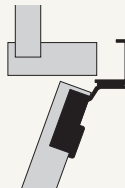

Edge Mount Hinges

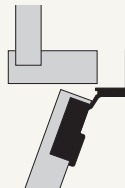

Face Mount Hinges

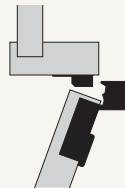

38B Series Hinge

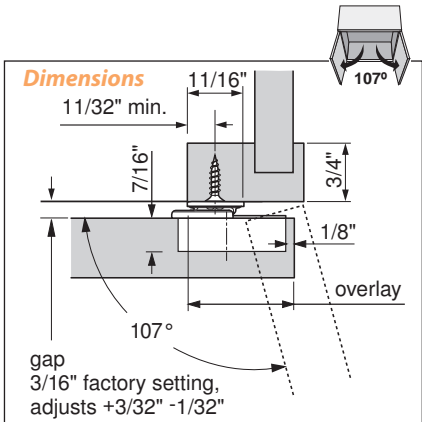
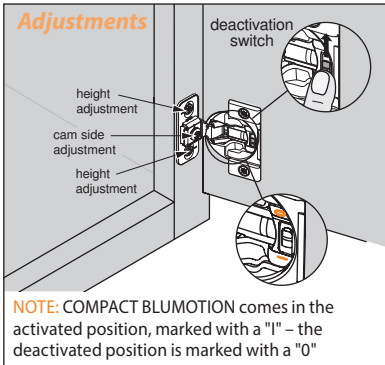
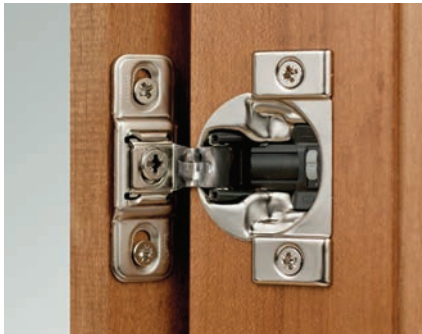

Part #	Cabinet Application	Overlay	Cup Mounting	Hinge Type	Pieces Per Carton
38B358BF22	Full Overlay	1-3/8" Or Greater	Press In	Face Mount	250 pcs.

Note: Screw on cup mount is available minimums apply- please inquire

Dimension Guidelines

- Maximum Door Thickness: 3/4"
- Minimum Reveal: 9/32" (Based on 3/4" door)
- Cup Depth: 7/16"
- Screw Size: #6 x 5/8" Wood Screw (#606N-100, See Page 20)

Accessories



Angle Restriction Clips

Function: Used to reduce the opening angle for cabinets located close to wall

Material: Nylon

Part #	Works With	Angle Reduction	Pieces Per Carton
38C315B3.1	39C, 38N & 38B Series	86°	250 pcs.

Note: Must be inserted before the hinge has been attached to the face frame



39C Series Hinge Arm Cover Caps

Function: Decorative cover cap

Material: Steel Nickel Plated

Part #	Works With	Pieces Per Carton
38C3508.BP	39C Series	1000 pcs.



38N Series Hinge Arm Cover Caps

Function: Decorative cover cap

Material: Steel Nickel Plated

Part #	Works With	Pieces Per Carton
38N3508BBP	38N Series	1000 pcs.

IMPORTANT: Due to Raw Material Fluctuation, Catalog Prices Below May Not Be Accurate. GO TO WWW.OUTWATER.COM FOR THE MOST UP-TO-DATE PRICES

Drawer Slides



TANDEM plus BLUMOTION Concealed Drawer Runners



- All Blum runners meet or exceed ANSI/BHMA 156.9 grade 1 requirements
- Full extension for no extension loss

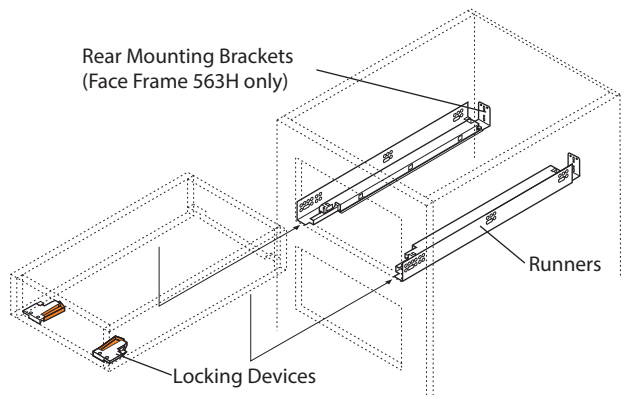

Note: Rear mounting brackets used for frame applications only

TANDEM series runners are based on the American standard 3" cabinet depth system, therefore runner lengths are in 3" increments
 TANDEM plus runners are available for drawers from 9" to 30" in length

563. Series Full Extension (90 lb. Capacity)



- Four-dimensional adjustment
- Elongated holes for depth adjustment
- Bottom mount holes
- 100 lb. static load capacity
- Full extension concealed drawer runners
- Panel or blocked out face frame cabinets
- Integrated **BLUMOTION** soft closing
- TANDEM smooth running action
- **MADE IN THE USA**

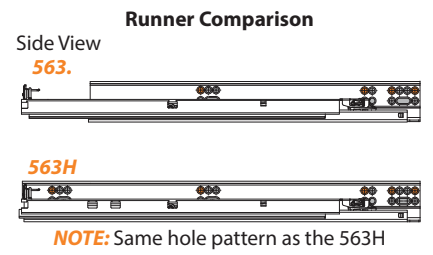

Part #	Drawer Length	Runner Length	Inside Cabinet Depth		Maximum Drawer Thickness	Dynamic Load Capacity	Pieces Per Carton
			Maximum	Minimum			
563.5330B	533 (21")	548 (21-9/16")	599 (23-19/32")	557 (21-15/16")	16mm (5/8")	90 lbs.	6 Pairs
563.4570B	457 (18")	471 (18-17/32")	522 (20-9/16")	480 (18-29/32")	16mm (5/8")	90 lbs.	6 Pairs

Note: Rear brackets cannot be used with these runners. Cabinet sides must be blocked out flush with the inside of the cabinet frame.
Note: Works with T51.1901.L & T51.1901.R front locking devices only - See page 21

IMPORTANT: Due to Raw Material Fluctuation, Catalog Prices Below May Not Be Accurate. GO TO WWW.OUTWATER.COM FOR THE MOST UP-TO-DATE PRICES

Drawer Slides



TANDEM plus BLUMOTION Concealed Drawer Runners 563H Series Full Extension (90 lb. Capacity)

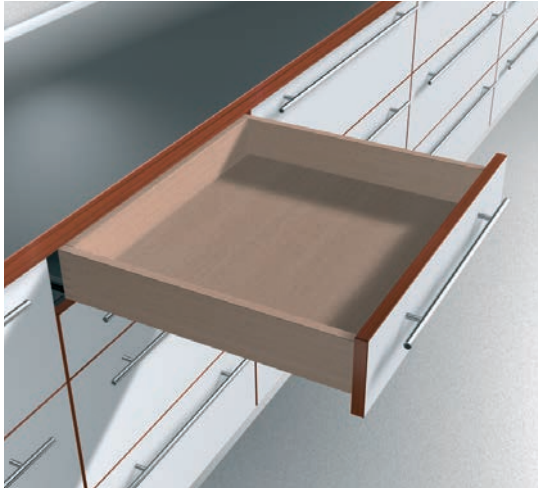

- Four-dimensional adjustment
- Elongated holes for depth adjustment
- Bottom mount holes on 15", 18" and 21"
- 100 lb. static load capacity
- Full extension concealed drawer runners
- Face frame or panel cabinets
- Integrated **BLUMOTION** soft closing
- TANDEM smooth running action
- **MADE IN THE USA**



Inside Cabinet Depth

Part #	Drawer Length	Runner Length	Maximum Inside Cabinet Depth		Maximum Drawer Thickness	Dynamic Load Capacity	Pieces Per Carton
			Maximum	Minimum			
563H5330B	533 (21")	548 (21-9/16")	599 (23-19/32")	557 (21-15/16")	16mm (5/8")	90 lbs.	6 Pairs
563H4570B	457 (18")	471 (18-17/32")	522 (20-9/16")	480 (18-29/32")	16mm (5/8")	90 lbs.	6 Pairs
563H3810B	381 (15")	395 (15-9/16")	446 (17-9/16")	404 (15-29/32")	16mm (5/8")	90 lbs.	6 Pairs
563H3050B	305 (12")	319 (12-9/16")	370 (14-9/16")	328 (12-29/32")	16mm (5/8")	90 lbs.	6 Pairs
563H2290B	229 (9")	259 (10-3/16")	299 (11-25/32")	266 (10-15/32")	16mm (5/8")	90 lbs.	6 Pairs

569/569H Series Full Extension (135 lb. Capacity)

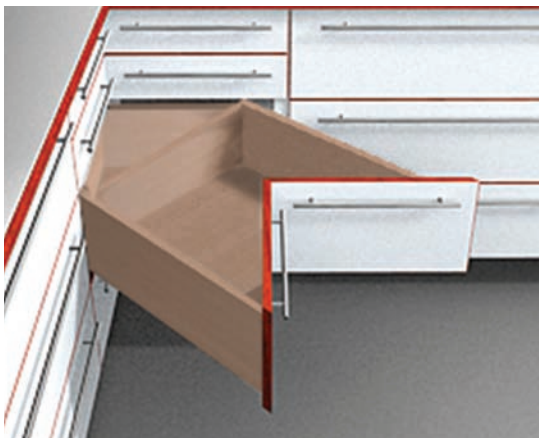

- Four-dimensional adjustment
- Elongated holes for depth adjustment
- 150 lb. static load capacity
- Full extension concealed drawer runners
- Panel or blocked-out face frame cabinets
- Integrated **BLUMOTION** soft closing
- TANDEM smooth running action



Part #	Drawer Length	Runner Length	Minimum Inside Cabinet Depth	Maximum Drawer Thickness	Dynamic Load Capacity	Pieces Per Carton
569.7620B	762 (30")	777 (30-19/32")	786 (30-15/16")	16mm (5/8")	135 lbs.	4 Pairs
569.6860B	686 (27")	700 (27-9/16")	709 (27-29/32")	16mm (5/8")	135 lbs.	4 Pairs
569.6100B	610 (24")	625 (24-19/32")	634 (24-31/32")	16mm (5/8")	135 lbs.	6 Pairs
569H5330B	533 (21")	548 (21-9/16")	557 (21-15/16")	16mm (5/8")	135 lbs.	6 Pairs
569H4570B	457 (18")	471 (18-17/32")	480 (18-29/32")	16mm (5/8")	135 lbs.	6 Pairs

Note: For heavy duty applications, rear brackets cannot be used. Cabinet sides must be blocked-out flush with the inside of the cabinet frame (See cabinet & drawer specs)

IMPORTANT: Due to Raw Material Fluctuation, Catalog Prices Below May Not Be Accurate. GO TO WWW.OUTWATER.COM FOR THE MOST UP-TO-DATE PRICES

Drawer Slides



TANDEM edge BLUMOTION Concealed Drawer Runners 554H Series 7/8 Extension (75 lb. Capacity)

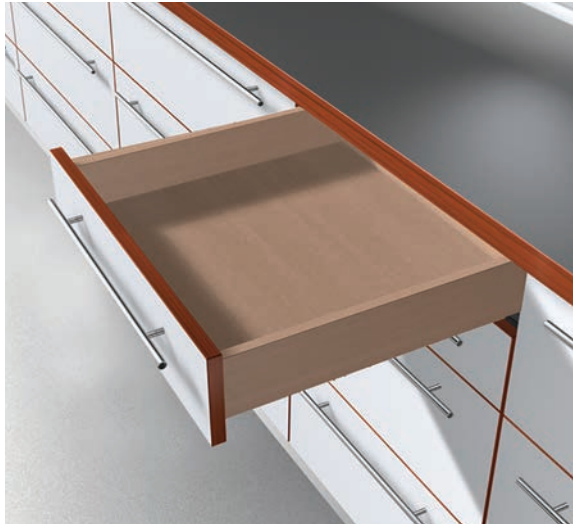

- **MATERIAL:** Steel
- 7/8 Extension concealed runners
- Face frame or frameless cabinets
- **BLUMOTION** soft closing
- TANDEM smooth running action
- Available in 9" to 21" lengths
- 13mm (1/2") to 16mm (5/8") drawer thickness
- Locking devices enable easy drawer insertion and removal
- 75 lb. dynamic load capacity
- 100 lb. static load capacity

Components



Runners

Part #	Drawer Length	Runner Length	Inside Cabinet Depth		Maximum Drawer Thickness	Dynamic Load Capacity	Pieces Per Carton
			Maximum	Minimum			
554H2290B01	229 (9")	274 (10-25/32")	299 (11-3/4")	284 (11-3/16")	16mm (5/8")	75 lbs.	8 Pairs
554H3050B01	305 (12")	331 (13-13/32")	375 (14-3/4")	341 (13-7/16")	16mm (5/8")	75 lbs.	8 Pairs
554H3810B01	381 (15")	407 (16-1/32")	451 (17-3/4")	417 (16-13/32")	16mm (5/8")	75 lbs.	8 Pairs
554H4570B01	457 (18")	484 (19-1/16")	527 (20-3/4")	494 (19-7/16")	16mm (5/8")	75 lbs.	8 Pairs
554H5330B01	533 (21")	560 (22-1/16")	604 (23-3/4")	570 (22-7/16")	16mm (5/8")	75 lbs.	8 Pairs

Mounting Screws Sold Separately *see below*

Front Locking Device

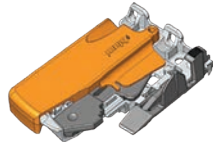

Sold as a set, 1 Left & 1 Right

Part #	Minimum Inside Drawer Width	Adjustments	Sets Per Carton
TS1.1701.23.R+L	121mm (4-3/4")	+3mm (1/8")	30

Mounting Screws Sold Separately *see below*

Basic Components

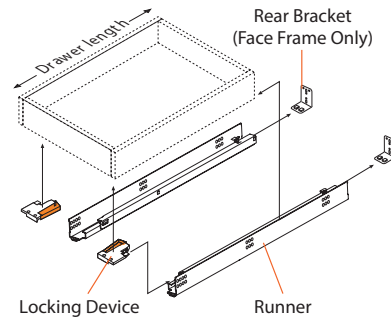

Rear Mount Brackets



- For TANDEM 563 H/F series runners & TANDEM edge
- Lateral self-alignment 3mm (1/8")
- Non-handed, one piece stamped steel design, zinc coated
- Use at least three #6 wood screws
- Not for use with 9" runners

Use for face frame cabinets only

Part #	Pieces Per Carton
295.3750.02	100 pcs.

Mounting Screws Sold Separately *see below*

Plug-In Socket



- Two required per drawer
- Lateral self-alignment
- Non-handed, two piece design

Part #	Pieces Per Carton
295.6510.21	400 pcs.

Mounting Screws Sold Separately *see below*

#6 x 5/8" Wood Screw (sold separately)

606N-100

Screws are packed 100 per carton. No broken boxes

IMPORTANT: Due to Raw Material Fluctuation, Catalog Prices Below May Not Be Accurate. GO TO WWW.OUTWATER.COM FOR THE MOST UP-TO-DATE PRICES

Drawer Slides



TANDEM plus BLUMOTION Concealed Drawer Runners

Required Accessories

Front Locking Devices

Standard with Side Adjustment



- With side-to-side adjustment
- Captive right device and self-aligning left device
- Self-adjusting drawer length tolerance
- Steel base with synthetic, spring-loaded release levers

Part #	Minimum Inside Drawer Width	Adjustments	Pieces Per Carton
T51.1901-*	170mm (6-11/16")	Height: +3 (1/8") Side: ±1.5 (1/16")	100 pcs.
606N-100	-	Screws	100 pcs.

1 Left (*L) & 1 Right (*R) Required Per Drawer

Standard without Side Adjustment



- For use with standard applications
- Captive right device and self-aligning left device
- Self-adjusting drawer length tolerance
- Zinc die-cast with synthetic, spring-loaded release levers

Part #	Minimum Inside Drawer Width	Adjustments	Pieces Per Carton
T51.1801-*	124mm (4-7/8")	Height: +3 (1/8")	100 pcs.
606N-100	-	Screws	100 pcs.

1 Left (*L) & 1 Right (*R) Required Per Drawer

Depth Adjustable with Side Adjustment



- Integrated depth adjustment and 3mm (1/8") SERVO-DRIVE distance bumper
- Captive right device and self-aligning left device
- Self-adjusting drawer length tolerance
- Steel base with synthetic, spring-loaded release levers
- Designed for 13mm (1/2") drawer bottom recess

Part #	Minimum Inside Drawer Width	Adjustments	Pieces Per Carton
T51.1901-PS-*	170mm (6-11/16")	Height: +3 (1/8") Depth: +2.5 (3/32")	100 pcs.
606N-100	-	Screws	100 pcs.

1 Left (*L) & 1 Right (*R) Required Per Drawer

Narrow Drawer without Side Adjustment



- For use with narrow drawers
- Maximum dynamic load capacity 25 lb.
- Captive right device and self-aligning left device
- Self-adjusting drawer length tolerance
- Vertical mount, two-piece nylon
- Minimum sub-front thickness 16mm (5/8")
- Designed for 13mm (1/2") drawer bottom recess

Part #	Minimum Inside Drawer Width	Adjustments	Pieces Per Carton
T51.0801.20*	124mm (4-7/8")	Height: +3 (1/8")	100 PCS
606N-100	-	Screws	100 PCS

1 Left (*L) & 1 Right (*R) Required Per Drawer

Optional Accessories

Lateral Stabilizer Set

- Increases lateral stability
- Synchronizes left and right runners to prevent drawer racking
- Ideal for wide applications using TANDEM 563/569 H/. and F/A Series
- Does not increase load capacity
- Panel and blocked-out face frame applications 229 (9") to 686 (27") length drawers
- Face frame applications with rear attachment 305 (12") to 533 (21") length drawers
- Recommended for opening widths 610 (24") and wider up to 1041 (41")

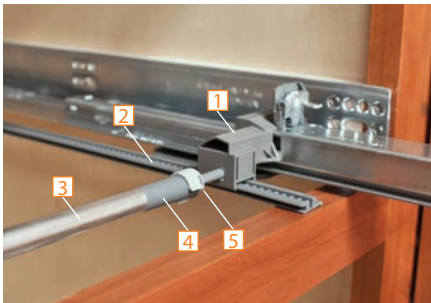

Set Includes:

- Pinion housing (Qty. 2)
 - Gear rack with location tabs (Qty. 2)
 - Linkage rod, length 1054 (41-1/2")
 - Pinion adaptor (Qty. 2)
 - Locking clip (Qty. 2)
- Installation instructions

Part #	Pieces Per Carton
ZST.686TU01	10 sets

Rear Mount Brackets



- For TANDEM 563 H/F series runners & TANDEM edge
- Lateral self-alignment 3mm (1/8")
- Non-handed, one piece stamped steel design, zinc coated
- Use at least three #6 wood screws
- Not for use with 9" runners

Part #	Pieces Per Carton
295.3750.02	100 pcs.
606N-100	100 pcs.

Use for face frame cabinets only

TANDEM Assembly Tools



- To bore the ø6mm holes for rear hook
- Pre-bore ø2.5mm hole for TANDEM locking devices at required angle

T65.9000

Set Includes:

- Allen wrenches (Qty. 2)
- ø6mm stop collar
- #2 phillips screwdriver tip
- ø2.5mm drill bit extension

T65.1600.01



SR-DREH.K-SCHL



Part #	Description
DB-2.5MM	2.5mm Drill Bit
DB-6MM	6mm Drill Bit
T65.9000	Tool Set
T65.1600.01	Tandem Boring Template
SR-DREH.K-SCHL	#2 Pozzi Screwdriver

IMPORTANT: Due to Raw Material Fluctuation, Catalog Prices Below May Not Be Accurate. GO TO WWW.OUTWATER.COM FOR THE MOST UP-TO-DATE PRICES

Drawer Slides



TIP-ON BLUMOTION for MOVENTO

TIP-ON push to open and BLUMOTION soft close all in one

Exceeds ANSI/BHMA A156.9 2010 Grade 1 specifications

Full Extension for no extension loss

- Four-dimensional adjustment
- Elongated holes for depth adjustment
- Bottom mount holes
- 125 lb. static load capacity
- Designed to be used with TIP-ON BLUMOTION touch-to-open system
- Full extension concealed runners
- Frameless or blocked-out face frame cabinets
- BLUMOTION soft closing
- MOVENTO smooth running action
- Available in 12" to 21" lengths
- 16mm (5/8") drawer thickness

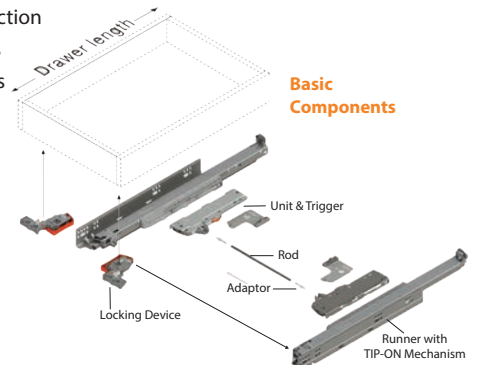

Runners



Components

Part #	Drawer Length	Runner Length	Minimum Inside Cabinet Depth	Maximum Drawer Thickness	Dynamic Load Capacity	Carton Quantity
763.5330S	533 (21")	544 (21-7/16")	553 (21-13/16")	16mm (5/8")	125 lbs.	6 Pairs
763.4570S	457 (18")	468 (18-7/16")	477 (18-13/16")	16mm (5/8")	125 lbs.	6 Pairs
763.3810S	381 (15")	392 (15-7/16")	401 (15-13/16")	16mm (5/8")	125 lbs.	6 Pairs
763.3050S	305 (12")	316 (12-7/16")	325 (12-13/16")	16mm (5/8")	125 lbs.	6 Pairs

Mounting Screws Sold Separately [see page 21](#)

Heavy Duty Runners Available, Please Inquire.

TIP-ON BLUMOTION Unit & Trigger



1 Set Required Per Drawer

- Enables MOVENTO drawers to be opened with just a light touch at the drawer front and retain BLUMOTION soft closing action
- Fully mechanical motion
- Can be used with or without pulls
- Minimum Inside Drawer Width: 281mm (11-1/16")
- Synchronization adaptors included

Part #	Drawer Length	Load Capacity	Carton Quantity
T60L7140	305mm (12")	0-44 lbs.	20 pcs.
T60L7340	381mm (15") - 533mm (21")	0-44 lbs.	20 pcs.
T60L7540	381mm (15") - 533mm (21")	44-88 lbs.	20 pcs.
T60L7570	457mm (18") - 610mm (24")	88-155 lbs.	20 pcs.

Front Locking Device

Standard with Side-to-Side Adjustment



- Captive right device and self-aligning left device
- Self-adjusting drawer length tolerance
- Steel base with synthetic, spring-loaded release levers
- For use with MOVENTO runners only

1 Left (*L) & 1 Right (*R) Required Per Drawer

Part #	Minimum Inside Drawer Width	Adjustments	Carton Quantity
T51.7601*	170mm (6-11/16")	+/- 1.5 (1/16")	100 pcs.
606N-100		#6 x 5/8" Screws	100 pcs.

Synchronization Rod & Adaptor

TIP-ON BLUMOTION synchronization

Recommended for all widths for optimal function

Synchronization Adaptors

- To be used with synchronization rod
- Two required per application



T60.000D
Carton Quantity: 80
Carton Quantity: 160

Synchronization Rod

Opening Width:

Minimum: 314mm (12-3/8")

Maximum: 1385mm (54-1/2")

Length: 1118mm (44-1/32")

Cut to size

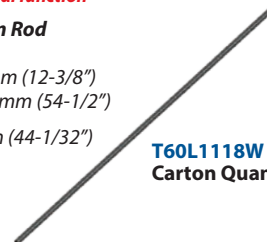

T60L118W
Carton Quantity: 40

IMPORTANT: Due to Raw Material Fluctuation, Catalog Prices Below May Not Be Accurate. GO TO WWW.OUTWATER.COM FOR THE MOST UP-TO-DATE PRICES

Lift Systems



Blum AVENTOS Lift Systems



Optimal Access
 AVENTOS lift systems for upper cabinet doors give optimal access to the contents of the cabinet and move the door completely out of the way when opened. They also ensure easy access to the handle in any position, even on tall wall cabinets.

- Effortless opening with just a light pull - even heavy doors
- TIP-ON push to open option
- Integrated **BLUMOTION** soft close for an amazingly quiet close
- Easy assembly & installation
- 3-Dimensional cam adjustments enables doors to be positioned & tensioned precisely



Smooth and Silent
 With AVENTOS, even heavy doors open with just a light pull of the handle and stay in any position, up and out of the way. BLUMOTION soft close is available with every AVENTOS lift system for an amazingly quiet close every time.



Easy Installation and Assembly
 Installation is fast and precise. Lever arms and doors snap on easily with our proven CLIP technology so there is no need for tools. 3-Dimensional cam adjustments enable doors to be positioned precisely.

Applications

Stay Lift AVENTOS HK-XS	Stay Lift AVENTOS HK-S	Stay Lift AVENTOS HK	Bi-Fold AVENTOS HF	Bi-Fold AVENTOS HL

Calculating the Power Factor

To select the correct lift mechanism for a given application, the power factor must first be calculated by using the formula below. Use the table at the bottom of the page to convert ounces into decimal form for easy calculations.

Power Factor= cabinet height (inch) x door weight* (lb.)

*Including twice the handle weight

Example:

- Cabinet height: 15 inches (within possible range)
- Door weight including twice the handle weight - 9.9 lbs.
- Power Factor= 15 x 9.9
- Power Factor= 148.5
- A power factor of 148.5 requires lift mechanism 20K1501

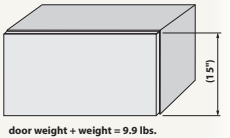

WEIGHT CONVERSION CHART															
oz.	1	2	3	4	5	6	7	8	9	10	11	12	13	14	15
lb.	.1	.1	.2	.3	.3	.4	.4	.5	.6	.6	.7	.8	.8	.9	.9

IMPORTANT: Due to Raw Material Fluctuation, Catalog Prices Below May Not Be Accurate. GO TO WWW.OUTWATER.COM FOR THE MOST UP-TO-DATE PRICES

Lift Systems



Blum AVENTOS Lift Systems

AVENTOS HK-XS with BLUMOTION



- Stay / Lift
- Used for small single door applications
- Swings upward for a complete view of cabinet interior
- 95° - 110° opening angle (depending on hinge type)

Maximum Inside Cabinet Width: 70-1/2"
 Maximum Inside Cabinet Height: 22-1/2"
 Minimum Inside Cabinet Height: 7-7/8"
 Minimum Inside Cabinet Depth: 5"

SERVO-DRIVE AVAILABLE
 See page 29

Power Factor=
 cabinet height (inch) x door weight* (lb.)

	Required	Part #	Description	Power Factor	
LIFT MECHANISM SET		20K1101	Lift Mechanism Note: depending on power factor, two lift mechanisms may be required Screws sold separately - #606N-100, see page 21	17 - 60	
		20K1301		34 - 120 (2 Units)	
		20K1501		61 - 112 121 - 224 (2 Units) 113 - 156 225 - 312 (2 Units)	
MOUNTING PLATES		20K5101	Screw Mount Frameless Cabinet Mounting Plate , Works with wood or all type aluminum frame doors Screws sold separately - #606N-100, see page 21	N/A	
		20K5501		Screw Mount Face Frame Cabinet Mounting Plate Works with Wood Doors Screws sold separately - #606N-100, see page 21	N/A
HINGES		71B3580	Screw Mount CLIP top BLUMOTION Hinge for Frameless Application, Wood or Wide Frame Aluminum Doors Screws sold separately - #606N-100, see page 21 Achieve 110° opening angle	N/A	
		71B950A		Press In Hinge for Narrow Aluminum Frame Doors Achieve 95° opening angle	N/A
		175H3100		Hinge Mounting Plate for Frameless Application, Wood or All Type Aluminum Frame Doors Screws sold separately - #606N-100, see page 21	N/A
		39C358B.20		Press In COMPACT BLUMOTION Hinge for Face Frame Application, Wood or All Type Aluminum Frame Doors 1-1/4" Overlay - Achieve 100° opening angle	N/A
DOOR MOUNTING PLATE		20K4101	Door Mounting Plate for All Wood & Wide Aluminum Frame Doors	N/A	
		20K4101A		Door Mounting Plate for Narrow Aluminum Doors	N/A

TIP-ON for AVENTOS HK-XS

Power Factor=
 cabinet height (inch) x door weight* (lb.)

	Required	Part #	Description	Power Factor	
LIFT MECHANISM SET		20K1101T	Lift Mechanism Note: depending on power factor, two lift mechanisms may be required Screws sold separately - #606N-100, see page 21	17 - 60	
		20K1301T		34 - 120 (2 Units)	
		20K1501T		61 - 112 121 - 224 (2 Units) 113 - 156 225 - 312 (2 Units)	
MOUNTING PLATES		20K5101	Screw Mount Frameless Cabinet Mounting Plate , Works with wood or all type aluminum frame doors Screws sold separately - #606N-100, see page 21	N/A	
		20K5501		Screw Mount Face Frame Cabinet Mounting Plate Works with Wood Doors Screws sold separately - #606N-100, see page 21	N/A
HINGES		70T3580.TL	Screw Mount Free Swing Hinge for Frameless Application, Wood or Wide Frame Aluminum Doors , Screws sold separately - #606N-100, see page 21 Achieve 110° opening angle	N/A	
		72T550A.TL		Press In Hinge for Narrow Aluminum Frame Doors Achieve 95° opening angle	N/A
		175H3100		Hinge Mounting Plate for Frameless Application, Wood or All Type Aluminum Frame Doors Screws sold separately - #606N-100, see page 21	N/A
		39C358B.20		Press In COMPACT BLUMOTION Hinge for Face Frame Application, Wood or All Type Aluminum Frame Doors 1-1/4" Overlay - Achieve 100° opening angle	N/A
DOOR MOUNTING PLATE		20K4101	Door Mounting Plate for All Wood & Wide Aluminum Frame Doors	N/A	
		20K4101A		Door Mounting Plate for Narrow Aluminum Doors	N/A
TIP-ON MECHANISM (Push to Open)		956.1004	TIP-ON Mechanism for Door Heights 400mm or less	N/A	
		956A1004		TIP-ON Mechanism for Door Heights Greater than 400mm	N/A

IMPORTANT: Due to Raw Material Fluctuation, Catalog Prices Below May Not Be Accurate. GO TO WWW.OUTWATER.COM FOR THE MOST UP-TO-DATE PRICES

Lift Systems



Blum AVENTOS Lift Systems



- Stay / Lift
- Used for smaller single door applications
- Swings upward for a complete view of cabinet interior
- 107° opening angle

Maximum Inside Cabinet Width:	70-1/2"
Minimum Inside Cabinet Width:	13-1/2"
Maximum Inside Cabinet Height:	22-1/2"
Minimum Inside Cabinet Height:	5-7/8"
Minimum Inside Cabinet Depth:	6-1/2"

AVENTOS HK-S with BLUMOTION



Power Factor= cabinet height (inch) x door weight* (lb.)

	Required	Part #	Description	Power Factor
LIFT MECHANISM SET		20K2B00.N6	Lift Mechanism Set Includes left & right arm, left & right cover plate & installation screws	19 - 39
		20K2C00.N6		40 - 85
		20K2E00.N6		86 - 177
MOUNTING HARDWARE Choose 1 Option Depending On Application	2 Required	175H3100	Mounting Hardware for Wood or Wide Aluminum Frame Doors Works with frameless & face frame cabinets Screws sold separately - #606N-100, see page 21	N/A
	Required			
RESTRICTION CLIP	Optional	20K7A41	100° angle restriction clip	N/A
	Optional	20K7A11	75° angle restriction clip	N/A

TIP-ON for AVENTOS HK-S



Power Factor= cabinet height (inch) x door weight* (lb.)

	Required	Part #	Description	Power Factor
LIFT MECHANISM SET		20K2B00TN6	Lift Mechanism Set Includes left & right arm, left & right cover plate & installation screws	19 - 39
		20K2C00TN6		40 - 85
		20K2E00TN6		86 - 177
MOUNTING HARDWARE Choose 1 Option Depending On Application	2 Required	175H3100	Mounting Hardware for Wood or Wide Aluminum Frame Doors Works with frameless & face frame cabinets Screws sold separately - #606N-100, see page 21	N/A
	Required			
RESTRICTION CLIP	Optional	20K7A41	100° angle restriction clip	N/A
	Optional	20K7A11	75° angle restriction clip	N/A
TIP-ON MECHANISM (Push to Open) Choose 1 Option Depending On Application	Optional	956.1004	TIP-ON Mechanism for Door Heights 400mm or less	N/A
		956A1004	TIP-ON Mechanism for Door Heights Greater than 400mm	N/A

IMPORTANT: Due to Raw Material Fluctuation, Catalog Prices Below May Not Be Accurate. GO TO WWW.OUTWATER.COM FOR THE MOST UP-TO-DATE PRICES

Lift Systems



Blum AVENTOS Lift Systems

AVENTOS HK TOP with BLUMOTION



- Stay / Lift
- Used for single door applications
- Self positioning mechanism with locating template allows for easier installation
- Opening angle adjustable between 75° & 107°
- Swings upward for a complete view of cabinet interior

Maximum Inside Cabinet Width:	72"
Minimum Inside Cabinet Width:	15"
Maximum Inside Cabinet Height:	24"
Minimum Inside Cabinet Height:	10"
Minimum Inside Cabinet Depth:	7-3/8"

SERVO-DRIVE AVAILABLE
See page 29

Note:

For wide cabinets, we recommend an additional lift mechanism be attached on the center panel to prevent the middle of the front from sagging when open. If using a third lift mechanism for wider applications (power factor increases by up to 50%), we recommend a trial application.

▲Stocked in gray.
Black or white available.
Please Inquire

		Power Factor= cabinet height (inch) x door weight* (lb.)				
		Part #	Description	Power Factor		
LIFT MECHANISM SET	<i>Required</i> 	22K2300	Lift Mechanism Set Includes left & right mechanism, & installation screws	36-139		
		22K2500		80-240		
		22K2700		150-450		
		22K2900		270-781		
COVER SET	<i>Required</i> 	22K8000.NA-* 2 Colors Available Dark Gray: *DG Light Gray: *LG	Cover Set Includes left & right mechanism cover plate, & 2 non-handed cover caps	N/A		
MOUNTING HARDWARE SET	<i>Required</i> 	20S4200	Mounting Hardware Set for Wood or Wide Aluminum Frame Doors Screws sold separately - #606N-100, see page 21	N/A		
		20S4F01		Mounting Hardware Set for Large Overlay Doors Screws sold separately - #606N-100, see page 21	N/A	
		20S4200A			Mounting Hardware Set for Narrow Aluminum Frame Doors Screws sold separately - #606N-100, see page 21	N/A
		20S42T1				Mounting Hardware for Thin Door Fronts (8-14mm) 2 Required per Aventos Kit
FACE FRAME MOUNTING BRACKET SET	<i>Optional</i> 	22K6001	Left & Right Brackets and 12 Mounting Screws Included	N/A		

TIP-ON for AVENTOS HK TOP

		Power Factor= cabinet height (inch) x door weight* (lb.)				
		Part #	Description	Power Factor		
LIFT MECHANISM SET	<i>Required</i> 	22K2300T	Lift Mechanism Set Includes left & right mechanism, & installation screws	36-139		
		22K2500T		80-240		
		22K2700T		150-450		
		22K2900T		270-781		
COVER SET	<i>Required</i> 	22K8000.NA-* 2 Colors Available Dark Gray: *DG Light Gray: *LG	Cover Set Includes left & right mechanism cover plate, & 2 non-handed cover caps	N/A		
MOUNTING HARDWARE SET	<i>Required</i> 	20S4200	Mounting Hardware Set for Wood or Wide Aluminum Frame Doors Screws sold separately - #606N-100, see page 21	N/A		
		20S4F01		Mounting Hardware Set for Large Overlay Doors Screws sold separately - #606N-100, see page 21	N/A	
		20S4200A			Mounting Hardware Set for Narrow Aluminum Frame Doors Screws sold separately - #606N-100, see page 21	N/A
		20S42T1				Mounting Hardware for Thin Door Fronts (8-14mm) 2 Required per Aventos Kit
FACE FRAME MOUNTING BRACKET SET	<i>Optional</i> 	22K6001	Left & Right Brackets and 12 Mounting Screws Included	N/A		
TIP-ON MECHANISM (Push to Open)	<i>Optional</i> 	▲956.1004	TIP-ON Mechanism for Door Heights 400mm or less	N/A		
		▲956A1004		TIP-ON Mechanism for Door Heights Greater than 400mm	N/A	

IMPORTANT: Due to Raw Material Fluctuation, Catalog Prices Below May Not Be Accurate. GO TO WWW.OUTWATER.COM FOR THE MOST UP-TO-DATE PRICES

Lift Systems



Blum AVENTOS Lift Systems

AVENTOS HF



- Bi-Fold / Lift-Up
- Used for two-part door applications
- Hardware set includes a "release" feature for finger safety
- 120° opening angle

Maximum Inside Cabinet Width: 70-1/2"
Minimum Inside Cabinet Width: 13-1/2"
Maximum Inside Cabinet Height: 40-1/2"
Minimum Inside Cabinet Height: 17-3/8"
Minimum Inside Cabinet Depth: 11"

SERVO-DRIVE AVAILABLE
See page 29

Power Factor= cabinet height (inch) x the combined weight of both doors (lb.) including the handle

		Part #	Description	Power Factor
LIFT MECHANISM SET	Required	20F2200.N5	Lift Mechanism Set Includes left & right mechanism, & installation screws	231-470
		20F2500.N5		471-880
		20F2800.N5		780-1440

		Part #	Description	Cabinet Height
TELESCOPIC ARM SET	Required	20F3200.01	Telescopic Arm Set Includes left & right arm	18-7/8"-22"
	Choose 1 Option Depending On Application	20F3500.01		22"-27"
		20F3800.01		27-35"
		20F3900.01		35"-42"

		Part #	Description
COVER SET	Required	20F8000.NA	Cover Set Includes left & right mechanism cover plate, & 2 non-handed cover caps
MOUNTING HARDWARE SET	Required	78Z5530TA8	Mounting Hardware Set for Wood or Wide Aluminum Frame Doors Includes 2 x 120° free swing hinges, 2 x 33° free swing hinges, 2 x CLIP top bottom door hinges, 2 x mounting plates, 4 x face frame adapters, 2 x arm mounting plates. Screws sold separately - #606N-100, see page 21
	Choose 1 Option Depending On Application	78Z5550TA6	Mounting Hardware Set for Narrow Aluminum Frame Doors Includes 2 x 120° free swing top door hinges, 2 x bottom door hinges, 2 x top door mounting plates, 2 x bottom door mounting plates, 4 x arm mounting plates, 8 x aluminum mounting screws (not shown).
RESTRICTION CLIP	Optional	20F7051	104° angle restriction clip
		20F7011	83° angle restriction clip

IMPORTANT: Due to Raw Material Fluctuation, Catalog Prices Below May Not Be Accurate. GO TO WWW.OUTWATER.COM FOR THE MOST UP-TO-DATE PRICES

Lift Systems



Blum AVENTOS Lift Systems

AVENTOS HL



How to Order:
 1) Choose lift mechanism according to door weight, including handle.
 2) Choose arm assembly according to cabinet height.



- Lift-Up
- Used for single door applications
- Perfect for appliance garages
- Opens parallel to cabinet

Maximum Inside Cabinet Width: 70-1/2"
Minimum Inside Cabinet Width: 13-1/2"
Maximum Inside Cabinet Height: 21-5/16"
Minimum Inside Cabinet Height: 10-5/16"
Minimum Inside Cabinet Depth: 11"

SERVO-DRIVE AVAILABLE
 See page 29

		Part #	Description	Door Weight
LIFT MECHANISM SET	<i>Required</i> 	20L2100.N5	Lift Mechanism Set Includes left & right mechanism, & installation screws	2- 8 lbs.
		20L2300.N5		2- 13 lbs.
		20L2500.N5		3- 25 lbs.
		20L2700.N5		10- 28 lbs.
		20L2900.N5		19- 44 lbs.

■ **Weight will drop to 36 lbs. if used in combination with the 20L3900 arm**

		Part #	Description	Cabinet Height	Minimum Opening
ARM ASSEMBLY SET	<i>Required</i> 	20L3200.06	Arm Assembly Set	11-13/16" - 13-3/4"	10-5/16"
		20L3500.06	Includes left & right assembly, & 2 x stabilizer rod cover	13-13/16" - 15-11/16"	12-5/16"
		20L3800.06		15-3/4" - 21-5/8"	14-1/4"
		20L3900.06		17-11/16" - 22-13/16"	16-1/4"

		Part #	Description
COVER SET	<i>Required</i> 	20L8000.N1	Cover Set Includes left & right mechanism cover plate, & 2 non-handed cover caps
STABILIZER ROD	<i>Required</i> 	20Q1061UA	41-3/4" Stabilizer Rod (to be cut to size) Rod length = interior cabinet opening less 5-1/16"
MOUNTING HARDWARE SET	<i>Required</i> 	20S4200	Mounting Hardware Set for Wood or Wide Aluminum Frame Doors Screws sold separately - #606N-100, see page 21
	<i>Required</i> 	20S4F01	Mounting Hardware Set for Large Overlay Doors Screws sold separately - #606N-100, see page 21
	<i>Required</i> 	20S4200A	Mounting Hardware Set for Narrow Aluminum Frame Doors Screws sold separately - #606N-100, see page 21
	<i>Required</i> 	20S42T1	Mounting Hardware for Thin Door Fronts (8-14mm) 2 Required per Aventos Kit
STABILIZER ROD CONNECTING SET	<i>Optional</i> 	20Q153ZA	Stabilizer Rod Connecting Set for Cabinets Greater Than 46-1/2"W Includes connector rod, 2 x top cap, mounting hook

Choose 1 Option Depending On Application

IMPORTANT: Due to Raw Material Fluctuation, Catalog Prices Below May Not Be Accurate. GO TO WWW.OUTWATER.COM FOR THE MOST UP-TO-DATE PRICES

Lift Systems



Blum SERVO-DRIVE for AVENTOS



AVENTOS lift systems can now open doors with just a light touch - and then close them again with the press of a button. An inspiring feature that is certain to impress, thanks to SERVO-DRIVE for AVENTOS, the new electric support for lift systems. Discover for yourself how easy the opening and closing of doors can be.

SERVO-DRIVE for AVENTOS HF

	Required	Part #	Description
SERVO-DRIVE SET		21FA000	Set Includes: Drive Unit, 60" Universal Cable, Cable Connector & 2 Cable End Protectors
COVER SET		21F8000.NA	Set Includes: SERVO-DRIVE Cover Plate (Left), AVENTOS HF Cover Plate (Right), 2 Non-Handed Cover Caps, 2 SERVO-DRIVE Switches, 6x5mm Distance Bumpers
POWER SUPPLY SET		Z10NE03UG10NG	Set Includes: Power Supply, Wall Mount Bracket, 3-Prong Power Cord, Cable Connector, 3 Cable End Protectors, 10 Cable Clips, 19 ft. Universal Cable, Technical Manual

SERVO-DRIVE for AVENTOS HL

	Required	Part #	Description
SERVO-DRIVE SET		21FA000	Set Includes: Drive Unit, 60" Universal Cable, Cable Connector & 2 Cable End Protectors
COVER SET		21L8000.NA	Set Includes: SERVO-DRIVE Cover Plate (Left), AVENTOS HL Cover Plate (Right), 2 Non-Handed Cover Caps, 2 SERVO-DRIVE Switches, 4x5mm Distance Bumpers
ARM ASSEMBLY SET Choose 1 Option Depending On Application		21L3200.01	300 (11-13/16") - 349 (13-3/4") Cabinet Height
		21L3500.01	350 (13-13/16") - 399 (15-13/16") Cabinet Height
		21L3800.01	400 (15-3/4") - 550 (21-5/8") Cabinet Height
		21L3900.01	450 (17-11/16") - 580 (22-13/16") Cabinet Height
POWER SUPPLY SET		Z10NE03UG10NG	Set Includes: Power Supply, Wall Mount Bracket, 3-Prong Power Cord, Cable Connector, 3 Cable End Protectors, 10 Cable Clips, 19 ft. Universal Cable, Technical Manual



- A light touch on the front using either your hand or elbow is all that is required for opening
- Comfortable and easy closing provided by the easy to reach switch on the cabinet side
- Completely safe even when the switch has been pressed for closing; the closing procedure is halted when the user reaches into the cabinet
- Cabinets with SERVO-DRIVE for AVENTOS can be easily opened manually in the event of a power outage
- Up to three drive units can be set for synchronized motion; ideal for multiple cabinets that share one wide door
- Collision avoidance feature for corner cabinets to insure that only one door opens at a time

SERVO-DRIVE for AVENTOS HK TOP

	Required	Part #	Description
SERVO-DRIVE SET		23KA000	Set Includes: Drive Unit, 60" Universal Cable, Cable Connector & 2 Cable End Protectors
COVER SET		21K8000.NA-* 2 Colors Available Dark Gray: *DG Light Gray: *LG	Set Includes: SERVO-DRIVE Cover Plate (Left), AVENTOS HK Cover Plate (Right), 2 Non-Handed Cover Caps, 2 SERVO-DRIVE Switches, 6x5mm Distance Bumpers
POWER SUPPLY SET		Z10NE03UG10NG	Set Includes: Power Supply, Wall Mount Bracket, 3-Prong Power Cord, Cable Connector, 3 Cable End Protectors, 10 Cable Clips, 19 ft. Universal Cable, Technical Manual

IMPORTANT: Due to Raw Material Fluctuation, Catalog Prices Below May Not Be Accurate. GO TO WWW.OUTWATER.COM FOR THE MOST UP-TO-DATE PRICES

LEGRABOX



**Premium Metal Drawer System
with TIP-ON BLUMOTION**



- TIP-ON opening mechanism plus BLUMOTION Soft Close
- 3 dimensional drawer front adjustment
- 88 lb. load capacity (155 lb. option available)

Available Heights:



Stock Lengths: 18", 20", 22" Other Lengths Available - Please Inquire

Available Finishes:



IMPORTANT: Due to Raw Material Fluctuation, Catalog Prices Below May Not Be Accurate. GO TO WWW.OUTWATER.COM FOR THE MOST UP-TO-DATE PRICES

LEGRABOX



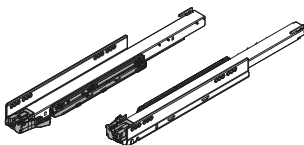
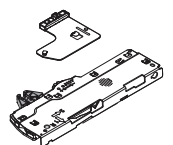
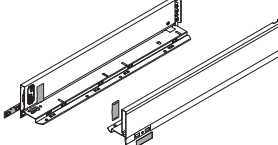
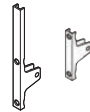
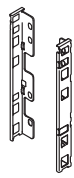

Premium Metal Drawer System with TIP-ON BLUMOTION

Required Components

<p>see below</p>  <p>Cabinet Profile mounts to cabinet with #7 x 5/8" wood screws or 5mm x 13mm system. Screws sold separately.</p>	 <p>TIP-ON Unit & Trigger Tool free assembly</p>	<p>see page 32</p>  <p>Drawer Profile mounts with #6 x 1/2" truss head. Screws sold separately.</p>	 <p>Front Fixing Bracket (2 per drawer) mounts with #6 x 1/2" truss head. Screws sold separately.</p>	 <p>Rear Fixing Bracket Set (1 per drawer) mounts with #6 x 1/2" truss head. Screws sold separately.</p>
--	---	--	--	---

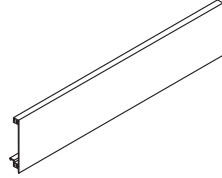
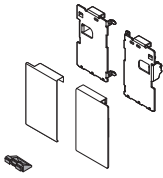
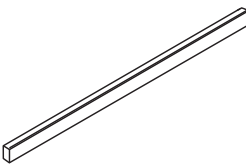
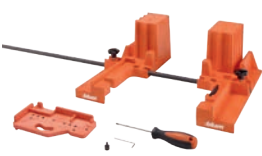
Optional Components

 <p>Interior Roll Out Front Piece for M Height - Field Cuttable</p>	 <p>Interior Front Fixing Bracket Set</p>	<p>see page 33</p>  <p>Cross Rail for Interior Front Piece for C Height - Field Cuttable</p>	 <p>Assembly Aid - LEGRABOX starter kit</p>	 <p>Synchronization Rod & Adaptor - Field Cuttable</p>
---	---	--	--	--

AMBIA-LINE Accessories Available for Added Organization [see page 37](#)

Required Components

Cabinet Profile

Works with all drawer heights

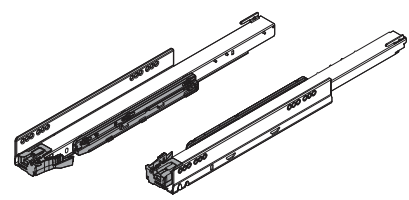

Part #	Nominal Length	Actual Length
750.4501S	18"	17-11/16"
750.5001S	20"	19-11/16"
750.5501S	22"	21-5/8"

TIP-ON BLUMOTION Unit & Trigger

Works with all drawer heights
For Drawers 44-88 lbs.

T60L7540

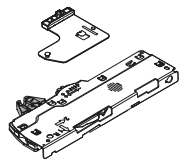

Mounting Screws Sold Separately [see page 33](#)



IMPORTANT: Due to Raw Material Fluctuation, Catalog Prices Below May Not Be Accurate. GO TO WWW.OUTWATER.COM FOR THE MOST UP-TO-DATE PRICES

LEGRABOX



**Premium Metal Drawer System
with TIP-ON BLUMOTION
Required Components**

Drawer Profiles



M Height:
3-9/16" (90.5 mm)

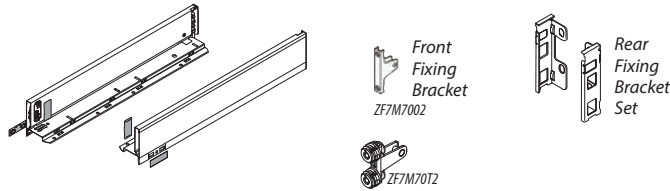

Part #	Nominal Length	Actual Length	Finish
770M4502*	18"	17-11/16"	Orion Gray (*S) Stainless Steel (*I)
770M5002*	20"	19-11/16"	
770M5502*	22"	21-5/8"	

Part #	Description
ZF7M7002	Front fixing bracket
ZF7M70T2	Front fixing Bracket for Thin Doors (2 Required)
ZB7M0005	Rear fixing bracket set

Mounting Screws Sold Separately *see page 33*

Space Requirements

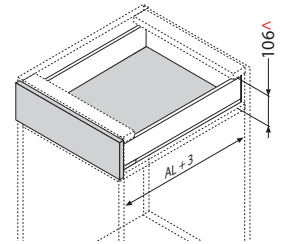

AL = actual cabinet profile length
^ minimum opening height based on 3 (1/8") clearance



K Height:
5-1/16" (128.5 mm)

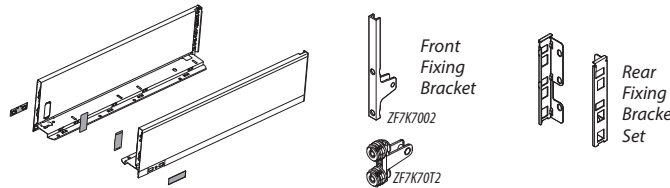

Part #	Nominal Length	Actual Length	Finish
770K4502*	18"	17-11/16"	Orion Gray (*S) Stainless Steel (*I)
770K5002*	20"	19-11/16"	
770K5502*	22"	21-5/8"	

Part #	Description
ZF7K7002	Front fixing bracket
ZF7K70T2	Front fixing Bracket for Thin Doors (2 Required)
ZB7K0005	Rear fixing bracket set

Mounting Screws Sold Separately *see page 33*

Space Requirements

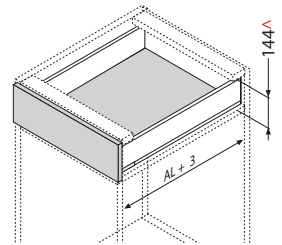

AL = actual cabinet profile length
^ minimum opening height based on 3 (1/8") clearance



C Height:
7" (177 mm)

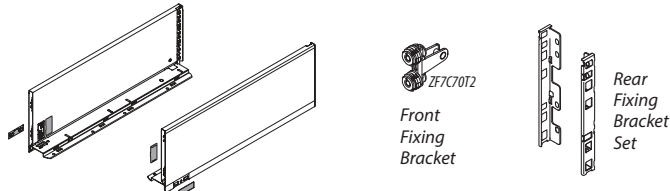

Part #	Nominal Length	Actual Length	Finish
770C4502*	18"	17-11/16"	Orion Gray (*S) Stainless Steel (*I)
770C5002*	20"	19-11/16"	
770C5502*	22"	21-5/8"	

Part #	Description
ZF7C70T2	Front fixing Bracket for Thin Doors (2 Required)
ZB7C0005	Rear fixing bracket set

Mounting Screws Sold Separately *see page 33*

Space Requirements

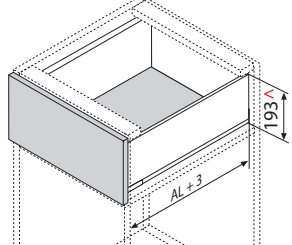

AL = actual cabinet profile length
^ minimum opening height based on 3 (1/8") clearance

IMPORTANT: Due to Raw Material Fluctuation, Catalog Prices Below May Not Be Accurate. GO TO WWW.OUTWATER.COM FOR THE MOST UP-TO-DATE PRICES

LEGRABOX



**Premium Metal Drawer System
with TIP-ON BLUMOTION
Required Components**

Drawer Profiles



F Height:
9-1/2" (241 mm)

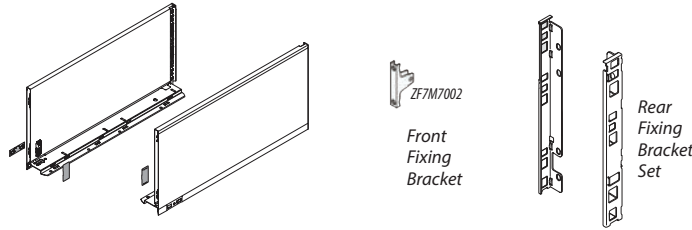

Part #	Nominal Length	Actual Length	Finish
770F4502*	18"	17-11/16"	Orion Gray (*S) Stainless Steel (*I)
770F5002*	20"	19-11/16"	
770F5502*	22"	21-5/8"	

Part #	Description
ZF7M7002	Front fixing bracket
ZB7F000S	Rear fixing bracket set

NOTE: Use 6 pcs. of ZF7M7002 required per drawer

Mounting Screws Sold Separately *see below*

Space Requirements

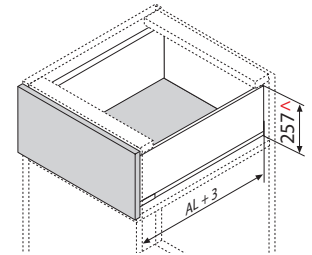

AL = actual cabinet profile length
 ▲ minimum opening height based on 3/8" clearance

Optional Components

For All LEGRABOX Models

**Interior Roll Out Front Piece
Cut To Size
Works with M & C Height**

Length: 41-1/16"

ZV7.1043C01S
(Orion Gray)
ZV7.1043C01N
(Brushed Nickel)

**Front Fixing Brackets
for Front Piece
Works with M Height**

Z17.0MS
(Orion Gray)
Z17.0MI
(Stainless Steel)

**Front Fixing Brackets
for Front Piece
Works with C Height**

Z17.3CS
(Orion Gray)
Z17.3CN
(Brushed Nickel)

For TIP-ON BLUMOTION

**Front Gap Template
Used for creating a 2.5mm (3/32")
front gap**

65.5631.US

**Cross Rail for Front Piece
Cut To Size
Works with C Height**

Length: 42-1/2"

ZR7108OUS
(Orion Gray)
ZR7108OUN
(Brushed Nickel)

**Assembly Aid
Clamp System Starter Kit**
Set includes adjustable clamp for all heights & lengths,
boring template & torx 20 screw driver

ZMM.0700.20

For TIP-ON BLUMOTION for LEGRABOX

**Synchronization Rod
Suitable for cabinet widths up to 55"
Cut To Size**

Length: 44-1/32"

T60L118W

Synchronization Adaptors
• To be used with synchronization rod
• Two required per application

T60.000D
Carton Quantity: 80
Carton Quantity: 160

Synchronization is recommended for all applications for optimal function.

Mounting Screws

Part #	Description	Work With:	Pieces Per Carton
707N-100	#7 x 5/8" Wood Screws	Cabinet Profile & Tip-On Unit	100
612TH-100	#6 x 1/2" Truss Head Screws	Drawer Profile & Mounting Brackets	100
661.1300.HG	5 x 13mm Euro Screws	Cabinet Profile	100

Packed in bags of 100 pcs. - NO BROKEN BOXES

IMPORTANT: Due to Raw Material Fluctuation, Catalog Prices Below May Not Be Accurate. GO TO WWW.OUTWATER.COM FOR THE MOST UP-TO-DATE PRICES

LEGRABOX



Premium Metal Drawer System with BLUMOTION Soft Close



- BLUMOTION Soft Close
- 3 dimensional drawer front adjustment
- 88 lb. load capacity (155 lb. option available)

Available Heights:



Stock Lengths: 18", 20", 22" Other Lengths Available - Please Inquire

Available Finishes:



IMPORTANT: Due to Raw Material Fluctuation, Catalog Prices Below May Not Be Accurate. GO TO WWW.OUTWATER.COM FOR THE MOST UP-TO-DATE PRICES

LEGRABOX



Premium Metal Drawer System with BLUMOTION Soft Close

Required Components

see below

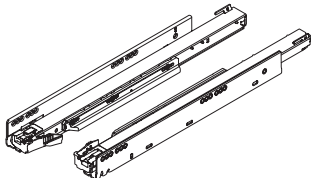
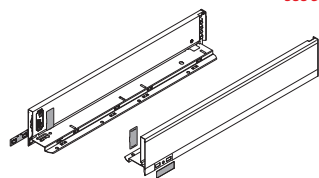
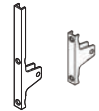
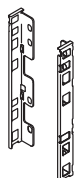
 <p>Cabinet Profile mounts to cabinet with #7 x 5/8" wood screws or 5mm x 13mm system. Screws sold separately.</p>	 <p>Drawer Profile mounts with #6 x 1/2" truss head. Screws sold separately.</p>	 <p>Front Fixing Bracket (2 per drawer) mounts with #6 x 1/2" truss head. Screws sold separately.</p>	 <p>Rear Fixing Bracket Set (1 per drawer) mounts with #6 x 1/2" truss head. Screws sold separately.</p>
--	--	--	--

Optional Components

see page 37

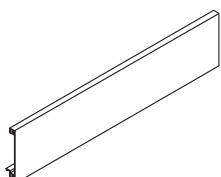
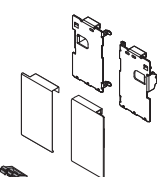
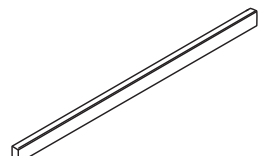
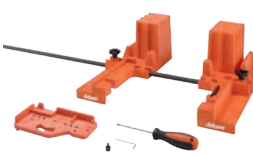
 <p>Interior Roll Out Front Piece for M Height - Field Cuttable</p>	 <p>Interior Front Fixing Bracket Set</p>	 <p>Cross Rail for Interior Front Piece - used for C height</p>	 <p>Assembly Aid - LEGRABOX starter kit</p>
--	--	---	--

AMBIA-LINE Accessories Available for Added Organization see page 37

Cabinet Profile

Works with all drawer heights

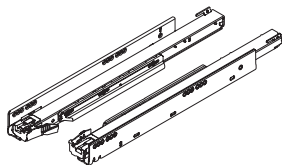

Part #	Nominal Length	Actual Length
750.4501S	18"	17-11/16"
750.5001S	20"	19-11/16"
750.5501S	22"	21-5/8"

Mounting Screws Sold Separately see page 37

Required Components



Drawer Profiles

M Height:
3-9/16" (90.5 mm)

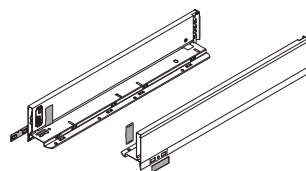

Part #	Nominal Length	Actual Length	Finish
770M4502*	18"	17-11/16"	Orion Gray (*S) Stainless Steel (*I)
770M5002*	20"	19-11/16"	
770M5502*	22"	21-5/8"	

Part #	Description
ZF7M7002	Front fixing bracket
ZB7M000S	Rear fixing bracket set

Mounting Screws Sold Separately see page 37

Space Requirements

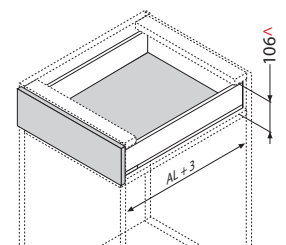

AL = actual cabinet profile length
^A minimum opening height based on 3 (1/8") clearance

IMPORTANT: Due to Raw Material Fluctuation, Catalog Prices Below May Not Be Accurate. GO TO WWW.OUTWATER.COM FOR THE MOST UP-TO-DATE PRICES

LEGRABOX



Premium Metal Drawer System with BLUMOTION Soft Close Required Components

Drawer Profiles

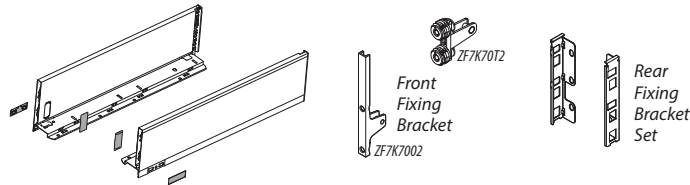

Part #	Nominal Length	Actual Length	Finish
770K4502*	18"	17-11/16"	Orion Gray (*S) Stainless Steel (*I)
770K5002*	20"	19-11/16"	
770K5502*	22"	21-5/8"	

Part #	Description
ZF7K7002	Front fixing bracket
ZF7K70T2	Front fixing Bracket for Thin Doors (2 Required)
ZB7K000S	Rear fixing bracket set

Mounting Screws Sold Separately see page 37

Space Requirements

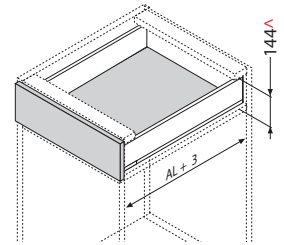

AL = actual cabinet profile length
 ^ minimum opening height based on 3 (1/8") clearance

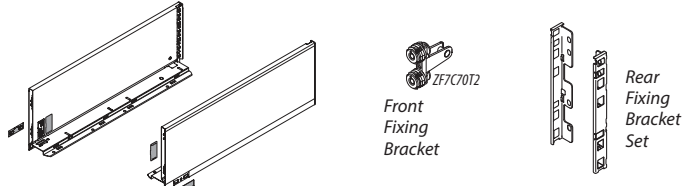

Part #	Nominal Length	Actual Length	Finish
770C4502*	18"	17-11/16"	Orion Gray (*S) Stainless Steel (*I)
770C5002*	20"	19-11/16"	
770C5502*	22"	21-5/8"	

Part #	Description
ZF7C70T2	Front fixing Bracket for Thin Doors (2 Required)
ZB7F000S	Rear fixing bracket set

Mounting Screws Sold Separately see page 37

Space Requirements

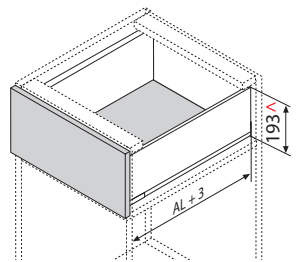

AL = actual cabinet profile length
 ^ minimum opening height based on 3 (1/8") clearance

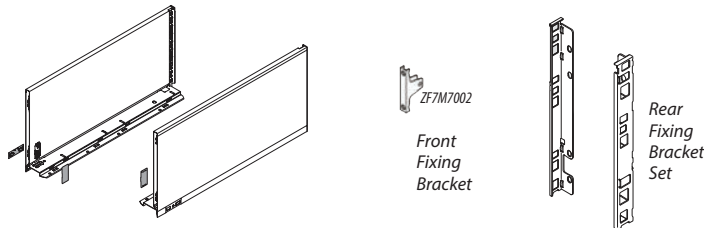

Part #	Nominal Length	Actual Length	Finish
770F4502*	18"	17-11/16"	Orion Gray (*S) Stainless Steel (*I)
770F5002*	20"	19-11/16"	
770F5502*	22"	21-5/8"	

Part #	Description
ZF7M7002	Front fixing bracket
ZB7C000S	Rear fixing bracket set

NOTE: Use 6 pcs. of ZF7M7002 required per drawer

Mounting Screws Sold Separately see page 37

Space Requirements

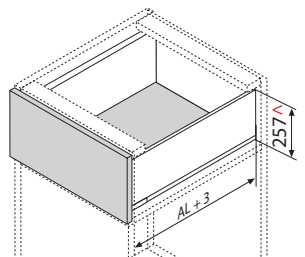

AL = actual cabinet profile length
 ^ minimum opening height based on 3 (1/8") clearance



IMPORTANT: Due to Raw Material Fluctuation, Catalog Prices Below May Not Be Accurate. GO TO WWW.OUTWATER.COM FOR THE MOST UP-TO-DATE PRICES

LEGRABOX

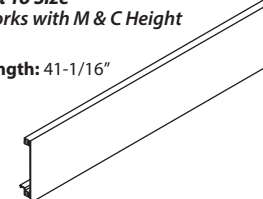
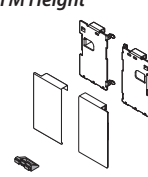
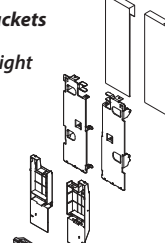

**Premium Metal Drawer System
with BLUMOTION Soft Close
Optional Components**

For All LEGRABOX Models

<p>Interior Roll Out Front Piece Cut To Size Works with M & C Height</p> <p>Length: 41-1/16"</p>  <p>ZV7.1043C01S (Orion Gray) ZV7.1043C01N (Brushed Nickel)</p>	<p>Front Fixing Brackets for Front Piece Works with M Height</p>  <p>Z17.0MS (Orion Gray) Z17.0MI (Stainless Steel)</p>	<p>Front Fixing Brackets for Front Piece Works with C Height</p>  <p>Z17.3CS (Orion Gray) Z17.3CN (Brushed Nickel)</p>	<p>Cross Rail for Front Piece Cut To Size Works with C Height</p> <p>Length: 42-1/2"</p>  <p>ZR7108OUS (Orion Gray) ZR7108OUN (Brushed Nickel)</p>
--	---	---	--

**Assembly Aid
Clamp System Starter Kit**
Set includes adjustable clamp for all heights & lengths,
boring template & torx 20 screw driver

ZMM.0700.20



Mounting Screws

Part #	Description	Work With	Pieces Per Carton
707N-100	#7 x 5/8" Wood Screws	Cabinet Profile	100
612TH-100	#6 x 1/2" Truss Head Screws	Drawer Profile & Mounting Brackets	100
661.1300.HG	5 x 13mm Euro Screws	Cabinet Profile	100

Packed in bags of 100 pcs. - NO BROKEN BOXES

AMBIA-LINE

Designed to work exclusively with all LEGRABOX systems.
Comes assembled & simply needs to be inserted in your drawer!

A Flatware Insert

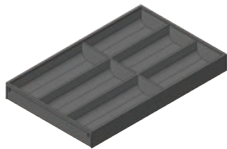

B Flatware Insert

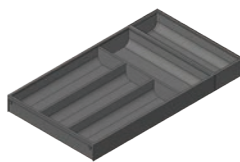

C Narrow Utensil Insert



D Wide Utensil Insert



E Deep Drawer Insert

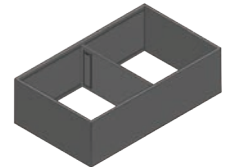

F Adjustable Width Plate holder



G Knife holder (Holds 9 Knives)



H Spice tray



Part #	Size	Drawer Height	Finish/Material
A ZC7S500BS3	20"L x 12"W x 2"H	M	Orion Gray Nylon w/Soft Touch Coating
B ZC7S550BS3	22"L x 12"W x 2"H	M	Orion Gray Nylon w/Soft Touch Coating
C ZC7S500RS1	20"L x 4"W x 2"H	M	Orion Gray Steel
C ZC7S550RS1	22"L x 4"W x 2"H	M	Orion Gray Steel
D ZC7S500RS2	20"L x 8"W x 2"H	M	Orion Gray Steel
D ZC7S550RS2	22"L x 8"W x 2"H	M	Orion Gray Steel
E ZC7F400RSP	16"L x 16"W x 4-3/8"H	C & F	Orion Gray Steel w/Magnetic Back
F ZC7T0350	7-5/16"-12-11/16"W x 6-11/16"H	C & F	Orion Gray Nylon & Stainless Steel w/Non-Slip Bottom
G ZCM0200	16-1/8"L x 7-3/8"W x 1-11/16"H	M	Orion Gray Nylon & Stainless Steel w/Non-Slip Bottom
H ZC7G0P01	14"L x 7-7/8"W x 3-5/16"H	C & F	Orion Gray Nylon & Stainless Steel w/Non-Slip Bottom

IMPORTANT: Due to Raw Material Fluctuation, Catalog Prices Below May Not Be Accurate. GO TO WWW.OUTWATER.COM FOR THE MOST UP-TO-DATE PRICES



IMPORTANT: Due to Raw Material Fluctuation, Catalog Prices Below May Not Be Accurate. GO TO WWW.OUTWATER.COM FOR THE MOST UP-TO-DATE PRICES

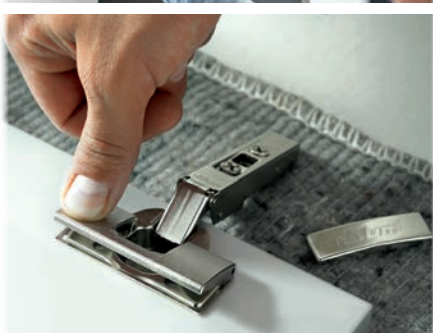

**IMPORTANT: Due to Raw Material Fluctuation, Catalog Prices Below May Not Be Accurate.
GO TO WWW.OUTWATER.COM FOR THE MOST UP-TO-DATE PRICES**



Innovative technology
concentrated into a small space



24 River Road
Bogota, NJ 07603

Outwater
Plastics Industries, Inc.

