



TKI NIEUW GAS
Topsector Energie

Overview of Hydrogen Projects in the Netherlands

Peter de Laat for TKI Nieuw Gas

Spring 2020



Introduction

All around the world hydrogen activities are developing fast and new projects are announced on a weekly basis. Dutch industry, research institutions, consultants, NGO's and governments also take part in these developments and are jointly working on a large range of projects, aimed at realizing the potential role that hydrogen can play in the energy transition to a carbon neutral energy system in 2050. These projects not only focus on the Netherlands, but also seek to connect to our neighboring countries and the North Sea region.

In this slide deck we present an overview of Dutch pilot and demonstration projects on hydrogen which were found in the public domain. We hope that this overview inspires to continue to work on the realization of these projects and to start new ones. Of course this overview is not complete, it is just a picture of what is happening at the moment. If your project is not listed in this overview, or if the information we used is not accurate, please let us know so we can keep this overview up-to-date. Comments can be sent to office@tki-gas.nl.



Explanation of the information box

- Category What is the main subject of the project in the hydrogen chain?
- Capacity What is the size of the project in MW, tons H₂/hour or trucks build?
- Process phase In which phase is the project:

concept	(idea development)
feasibility study	(first design)
FEED-study	(business case)
FID	(investment decision)
execution	(implementation, building)
commissioning	(test run)
- Project costs The amount of subsidy or investment involved.
- Contact Here, more information on the project or initiative is given.



Overview

TKI NIEUW GAS
Topsector Energie

Overview of Hydrogen Projects in the Netherlands
Peter de Laat for TKI Nieuw Gas

Spring 2020

Introduction

All around the world hydrogen activities are developing fast and new projects are announced on a weekly basis. Dutch industry, research institutions, consultants, NGO's and governments also take part in these developments and are jointly working on a large range of projects, aimed at realizing the potential role that hydrogen can play in the energy transition to a carbon neutral energy system in 2050. These projects not only focus on the Netherlands, but also seek to connect to our neighboring countries and the North Sea region.

In this slide deck we present an overview of Dutch pilot and demonstration projects on hydrogen which were found in the public domain. We hope that this overview inspires to continue to work on the realization of these projects and to start new ones. Of course this overview is not complete, it is just a picture of what is happening at the moment. If your project is not listed in this overview, or if the information we used is not accurate, please let us know so we can keep this overview up-to-date. Comments can be sent to office@tki-gas.nl.

Explanation of the information box

- Category: What is the main subject of the project in the hydrogen chain?
- Capacity: What is the size of the project in MW, tons H₂/hour or trucks build?
- Process phase: In which phase is the project:
 - concept (idea development)
 - feasibility study (first design)
 - FEED-study (business case)
 - FID (investment decision)
 - execution (implementation, building)
 - commissioning (test run)
- Project costs: The amount of subsidy or investment involved.
- Contact: Here, more information on the project or initiative is given.

Production

Storage

Transportation

Distribution

Deployment: Energy Supply

Deployment: Industrial

Deployment: Mobility

Deployment: Built Environment

Knowledge



Production

Overview

Thumbnail images for the 'Overview' presentation, arranged in a 3x4 grid. The thumbnails show various slides with text, diagrams, and logos related to hydrogen production and distribution.



Production I

Thumbnail images for the 'Production I' presentation, arranged in a 4x3 grid. The thumbnails show various slides with text, diagrams, and logos related to hydrogen production, including sections like H2M1 through H2M20.



Production II

Thumbnail images for the 'Production II' presentation, arranged in a 2x3 grid. The thumbnails show various slides with text, diagrams, and logos related to hydrogen production, including sections like H2M2 through H2M5.



Production I

<h3>Overview</h3>	<h3>Production II</h3>	<h3>DJewels</h3> <p>Realisation of a 20 MW Electrolyser in Delfzijl Operated by Nouryon and Gasunie, it will produce 3,000 tons of green hydrogen per year, reducing CO2 emissions by up to 27,000 tons per year in combined activities with BioMGN.</p> <p>Category: production of hydrogen Capacity: 20 MW + 60 MW Process phase: FID in 2020 Project period: 2020 - Project costs: 16 M subsidy Contact: info@h2isics.com</p> <p>Partners: Nouryon, Gasunie, BioMGN</p>	<h3>Hydrogen Delta</h3> <p>Designing a Gigawatt Electrolysis Plant for Zeeland Aims to design a GW hydrogen factory at 3 times lower costs than the current design. It should consider the capturing and delivery of hydrogen, heat and oxygen in a way that goes hand in hand with the operational strategy of the large-scale facility.</p> <p>Category: production of H₂ Capacity: 1 GW Process phase: FEED-study Project period: 2019 - Project costs: TNO subsidy Contact: yvonne.vandert@tno.nl</p> <p>Partners: Institute for Sustainable Process Technology (ISPT), Nouryon, Shell, Vies, CO2 Nitrogen, Gasunie, CO2W, Chemical, Shell, France, E.ON part of TNO, Utrecht University and Imperial College London</p>	<h3>H2.50</h3> <p>Building a 250 MW Electrolysis Plant in Port of Rotterdam The new factory will be able to produce 45,000 tons of green hydrogen annually. Because the hydrogen is produced from water with sustainable electricity, CO₂ emissions can decrease by 350,000 tons annually. BP will use the green hydrogen to desulphurise products.</p> <p>Category: production of H₂ Capacity: 250 MW Process phase: FEED-study Project period: 2019 - 2022 (FID) Project costs: 225 - 300 M Contact: hg.regner@portofrotterdam.com</p> <p>Partners: Port of Rotterdam, Nouryon</p>
<h3>Porthos</h3> <p>Rotterdam CCUS</p> <p>CCUS Infrastructure for Blue Hydrogen in Port of Rotterdam Transfer of grey hydrogen production in the Port of Rotterdam into blue with CCUS into the North Sea bottom, Shell, ExxonMobil, Air Liquide and Air Products committed to this phase for creating a CO₂ infrastructure.</p> <p>Category: production of blue H₂ Capacity: 2.5 million ton CO₂ per year Process phase: FEED-study Project period: 2020 - 2023 Project costs: >20 M Contact: r.m.de.vries@gasunie.nl</p> <p>Partners: Port of Rotterdam, Gasunie, Air Liquide, Air Products</p>	<h3>Westereems</h3> <p>Building a 100 MW Hydrogen Plant for Westereems Wind Farm The 100-megawatt capacity plant would be located on the site of the RWE-Eemshaven power plant and will be supplied with power from the adjacent wind farm Westereems owned by Inogy.</p> <p>Category: production of green H₂ Capacity: 100 MW Process phase: feasibility-study Project period: 2019 - Project costs: unknown Contact: sarah.knauber@inogy.com</p> <p>Partners: Inogy</p>	<h3>Hemweg hub Amsterdam</h3> <p>Building a 100 MW Green Hydrogen Plant as part of a Hub Building a 100 MW hydrogen powerplant on the Hemweg site as part of a fossil free hub (production, storage and distribution) for providing green electricity, heating and fuels for Amsterdam Metropolitan Region.</p> <p>Category: production of green H₂ Capacity: 100 MW Process phase: feasibility-study Project period: 2019 - Project costs: unknown Contact: https://group.valtenfall.com/nl</p> <p>Partners: VATTENFALL, metropoli region amsterdam, Port of Amsterdam</p>	<h3>H-vision</h3> <p>The Production of Blue Industrial Hydrogen in Rotterdam The production of hydrogen based on natural gas and through the reuse of refinery gases. The CO₂ released during production is captured and stored in empty gas fields below the North Sea or can be reused in the industrial area.</p> <p>Category: production of H₂ Capacity: several installations Process phase: FEED-study Project period: 2020 - 2026 Project costs: 2 B investment Contact: hg.regner@portofrotterdam.com</p> <p>Partners: Air Liquide, BP, Dethlefs, Gasunie, Heerenlootjens, Power Plant Rotterdam, Shell, Uniper en Vopak</p>	<h3>GreenH2UB</h3> <p>Creating a Green Hydrogen Ecosystem in Noord-Brabant Aims to develop a green hydrogen ecosystem. It will contain 3-10 MW. GreenH2UB plants (transformers) balancing the grid with hydrogen production for application and Deployment in industry, heavy mobility and built environment.</p> <p>Category: production of green H₂ Capacity: 10 - 30 MW (200-500 kg/y) Process phase: feasibility-study Project period: 2019 - 2030 Project costs: unknown Contact: www.green2ub.nl</p> <p>Partners: BOM, FORCE</p>
<h3>HEAVENN</h3> <p>H₂ Energy Applications in Valley Environments for Northern NL The projects support focus on sectoral integration: the large-scale production of green hydrogen as a raw material for industry, the storage, transport and distribution of hydrogen and its application for energy supply for both industry and the built environment and in mobility.</p> <p>Category: production H₂ in Energy Valley Capacity: 30 subprojects Process phase: assessment Project period: 2020 - 2025 Project costs: 90 M Contact: New Energy Coalition</p> <p>Partners: various stakeholders</p>	<h3>Hydrogen Delta</h3> <p>Aiming for a Gigawatt Factory in the Delta Region Realisation of a large pilot (on a ~ 100 MW scale) and a large-scale green hydrogen factory (on a ~ GW scale) by 2025. Blue hydrogen is used in the transition to green. In addition, realisation of a hydrogen network in the port area, which is connected to the national network.</p> <p>Category: production, distribution Capacity: 1 GW Process phase: concept Project period: 2020 - 2030 Project costs: >100 M Contact: www.smartdeltaresources.com</p> <p>Partners: various stakeholders</p>	<h3>GZI NEXT</h3> <p>A Second Life for the GZI Site in Emmen, with Hydrogen Together they look at the possibilities of using the existing infrastructure for the generation of green gas through fermentation or gasification and for the generation of hydrogen. Wind, sun and renewable gas are seen as important components in the sustainable energy picture of 2050.</p> <p>Category: production, distribution Capacity: - Process phase: feasibility-study Project period: 2018 - Project costs: unknown Contact: www.gzinext.nl</p> <p>Partners: Gasunie, various stakeholders</p>	<h3>Bio Energy Netherlands</h3> <p>Wood Gasification with Production of Hydrogen and CO₂ The wood gasification plant in Amsterdam will extract hydrogen and CO₂ from the syngas, which can be used for transport fuels and in the chemical industry, amongst others. Developing and testing a gas upgrading system linked to a gasifier for production of green hydrogen.</p> <p>Category: production Capacity: - Process phase: FEED-study Project period: 2019 - 2021 Project costs: TSE 500 k Contact: info@bioenergy.nl</p> <p>Partners: Bio Energy Netherlands, HYGEAR</p>	<h3>Hydrogen Gas Turbine Retrofit</h3> <p>Hydrogen Gas Turbine Retrofit to Eliminate Carbon Emissions To develop a cost effective ultra-low emissions (sub 50ppm NOx and CO) combustion system retrofit for existing installed gas turbines in the output range of 1 MW to 300 MW Fuel. Fuel flexibility and stable operation is required from 100% natural gas to 100% hydrogen.</p> <p>Category: production Capacity: - Process phase: FEED-study Project period: 2019 - 2020 Project costs: TSE 500 k Contact: Huub Koeman, Ansaldo Energia</p> <p>Partners: ANSALDO ENERGIA, EPR, AkzoNobel, EMATEC, TU/e, VATTENFALL, Nouryon</p>
<h3>Hydrogen Mill</h3> <p>Building a Windmill that Produces Hydrogen The goal is to build a 4.8 MW Lagerweij windmill and a 2 MW electrolyser to demonstrate the production of hydrogen by windmills on the EON test location in the Weeringmeer. This is part of the DUWAL project that focuses on the hydrogen region of north-western Netherlands.</p> <p>Category: production Capacity: 2 MW Process phase: FEED-study Project period: 2020 - Project costs: unknown Contact: j.waanders@hy-gro.nl</p> <p>Partners: HYGRO</p>	<h3>PosHydon</h3> <p>Hydrogen Production from North Sea Water on an Offshore Platform A 1 MW electrolyser in a sea container on the platform, the Q13a, is very suitable for this. It is a fully electrified offshore platform. This electrification with green electricity saves 19.5 kt of CO₂ per year.</p> <p>Category: production Capacity: 1 MW Process phase: FEED-study Project period: 2019 - 2021 Project costs: unknown Contact: Bas Rijkse / nephenenergy.com</p> <p>Partners: TNO, nexstep</p>	<h3>H2ermes</h3> <p>Building a 100 MW Hydrogen Plant in Amsterdam for TaTa Steel Deployment of hydrogen delivered by a 100 MW electrolysis plant to produce fuels and / or basic chemicals with the carbon monoxide (CO) and carbon dioxide (CO₂) in the residual gases from the steel production at TaTa Steel.</p> <p>Category: production Capacity: 100 MW Process phase: FEED-study Project period: 2019 - Project costs: 150 M Contact: jan.ligman@portofrotterdam.com</p> <p>Partners: Port of Amsterdam, TATA STEEL, Nouryon</p>	<h3>Molten Metal Methane Pyrolysis</h3> <p>Producing 'Turquoise' Hydrogen from Natural Gas Methane pyrolysis produces hydrogen from natural gas with carbon (and not CO₂) as a valuable by-product. Affordable and commercially applicable within a few years. The applications are diverse. Think of additive for steel, filler in car tires, graphite, dye and soil conditioner.</p> <p>Category: production, knowledge Capacity: - Process phase: concept Project period: 2019 - Project costs: unknown Contact: william.frens@tno.nl</p> <p>Partners: TNO, VOLTA CHEM</p>	<h3>Hydrogen from Organic Waste</h3> <p>Producing Hydrogen by Gasification of Biomass in 'het Groene Hart' The pilot plant, the size of four parking spaces, is placed at a civil engineering company. Roadside grass and other organic waste is used for testing. The hydrogen obtained is initially used by Vermulder Group, who wants to make their business more sustainable.</p> <p>Category: production of H₂ Capacity: 7 Process phase: FEED-study Project period: 2019 - 2021 Project costs: unknown Contact: info@netenergy.com</p> <p>Partners: NETTEnergy, VERMULDER</p>



Production II

Overview



Production I



NorthH2

The Production of Green Hydrogen from a GW Windfarm in the North Sea
 The objective is to generate 3 to 4 GW of wind energy for hydrogen production by 2030, and possibly 10 GW in 2040. Green hydrogen production of 800,000 tons, prevents around 7 megatons of CO₂ emissions per year.



Category:	production of H ₂
Capacity:	3 - 4 GW wind – 0,8 Mt H ₂ /y
Process phase:	feasibility-study
Project period:	2020 - 2040
Project costs:	unknown
Contact:	info@gasunie.nl

Partners:

H2GO

Towards Hydrogen Island Goeree Overflakkee

A 2.5 MW electrolyser will be producing renewable hydrogen and connecting the hydrogen production unit at the Greenpoint hydrogen refuelling station to Stad aan 't Haringvliet via Energy Park Oude-Tonge. Next will be the upgrade to a 26 MW electrolyser from wind energy.



Category:	production, storage, distribution
Capacity:	2.5 MW to 26 MW
Process phase:	feasibility-study
Project period:	2017 - 2030
Project costs:	unknown
Contact:	info@goree-overflakkee.nl

Partners: 30+ parties

HyNetherlands

Building a 100 MW Electrolyser in the Eemshaven

The factory will also have an important function for the balance in the electricity system. If the wind farms supply more electricity than is currently needed, it can be converted into hydrogen and stored. If necessary, the hydrogen can be converted back into electricity.



Category:	production
Capacity:	100 MW to 1 GW
Process phase:	feasibility-study
Project period:	FID 2021-2022
Project costs:	50 - 100 M
Contact:	info@gasunie.nl

Partners:

Blue Hydrogen Den Helder

Empty Gas Fields Play a Role for Blue Hydrogen Production

The hydrogen gas can be produced with green energy from the (large) offshore wind farms that will be built in the coming decades. But even now hydrogen can be produced from natural gas. The released CO₂ can be captured and stored in the empty gas fields below the North Sea.



Category:	production
Capacity:	large factory
Process phase:	feasibility-study
Project period:	2020 - 2022
Project costs:	unknown
Contact:	Thijs Pennink, info@rhn

Partners:

GldH2

A Hydrogen Cooperative in Zutphen Aiming for a 1 MW Electrolyser

A hydrogen factory is to be built on the industrial area 'De Mars' and various pilot projects are being set up. The GldH2 cooperative works together with the local energy cooperative Zutphen Energie and with thirteen partners in the region.



Category:	production
Capacity:	1 MW electrolyser
Process phase:	feasibility-study
Project period:	2020 -
Project costs:	unknown
Contact:	https://gldh2.nl/

Partners o.a.:

Hydrogen Mill Sint Philipsland

To Use Profits to Benefit the Livability of the Community

The initiators of the windmill look for an alternative for the full electricity grid. The use of the national natural gas network for storage, distribution and deployment of their own production of hydrogen. Therefore they hope to make the peninsula Sint Philipsland a hydrogen village.



Category:	production
Capacity:	1 windmill
Process phase:	feasibility-study
Project period:	2020 - 2022
Project costs:	126 k subsidy
Contact:	pers@stedin.net

Partners o.a.:



DJewels

Realisation of a 20 MW Electrolyser in Delfzijl

Operated by Nouryon and Gasunie, it will provide 3,000 tons of green hydrogen per year, reducing CO2 emissions by up to 27,000 tons per year in combined activities with BioMCN.



Category:	production of hydrogen
Capacity:	20 MW > 60 MW
Process phase:	FID in 2020
Project period:	2020 -
Project costs:	16 M subsidy
Contact:	info@hinicio.com

Partners:



Hydrogen Delta

Designing a Gigawatt Electrolysis Plant for Zeeland

Aims to design a GW hydrogen factory at 3 times lower costs than the current design. It should consider the capturing and delivery of hydrogen, heat and oxygen in a way that goes hand in hand with the operational strategy of the large-scale facility.



Category:	production of H ₂
Capacity:	1 GW
Process phase:	FEED-study
Project period:	2019 -
Project costs:	TKI subsidy
Contact:	yvonne.vandelft@tno.nl

Partners: Institute for Sustainable Process Technology (ISPT), Nouryon, Shell, Yara, OCI Nitrogen, Gasunie, DOW Chemical, Ørsted, Frames, ECN part of TNO, Utrecht University and Imperial College London.



H2.50

Building a 250 MW Electrolysis Plant in Port of Rotterdam

The new factory will be able to produce 45,000 tons of green hydrogen annually. Because the hydrogen is produced from water with sustainable electricity, CO₂ emissions can decrease by 350,000 tons annually. BP will use the green hydrogen to desulphurise products.



Category:	production of H ₂
Capacity:	250 MW
Process phase:	FEED-study
Project period:	2019 – 2022 (FID)
Project costs:	225 - 300 M
Contact:	hgj.regeer@portofrotterdam.com

Partners:



CCUS Infrastructure for Blue Hydrogen in Port of Rotterdam

Transfer of grey hydrogen production in the Port of Rotterdam into blue with CCUS into the North Sea bottom. Shell, ExxonMobil, Air Liquide and Air Products committed to this phase for creating a CO₂ infrastructure.

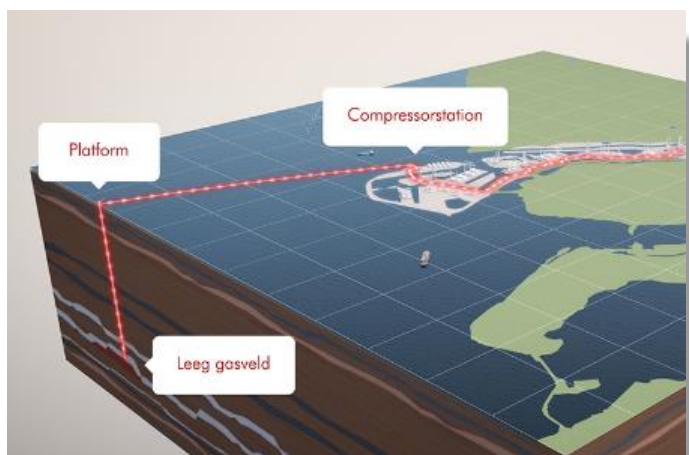

Category:	production of blue H ₂
Capacity:	2,5 million ton CO ₂ per year
Process phase:	FEED-study
Project period:	2020 – 2023
Project costs:	>20 M
Contact:	r.m.de.vries@gasunie.nl

Partners:



ebn



Westereems

Building a 100 MW Hydrogen Plant for Westereems Wind Farm

The 100-megawatt capacity plant would be located on the site of the RWE-Eemshaven power plant and will be supplied with power from the adjacent wind farm Westereems owned by innogy.

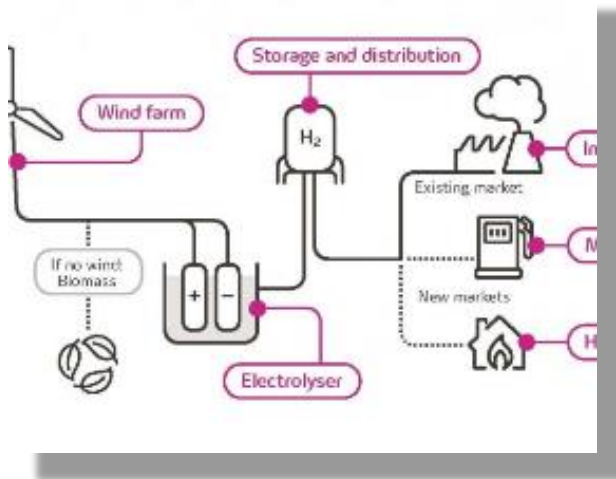

Category:	production of green H ₂
Capacity:	100 MW
Process phase:	feasibility-study
Project period:	2019 -
Project costs:	unknown
Contact:	sarah.knauber@innogy.com

Partners:



Hemweg hub Amsterdam

Building a 100 MW Green Hydrogen Plant as part of a Hub

Building a 100 MW hydrogen powerplant on the Hemwegsite as part of a fossil free hub (production, storage and distribution) for providing green electricity, heating and fuels for Amsterdam Metropool Region.



Category:	production of green H ₂
Capacity:	100 MW
Process phase:	feasibility-study
Project period:	2019 -
Project costs:	unknown
Contact:	https://group.vattenfall.com/nl

Partners:

VATTENFALL 

**metropool
regioamsterdam**

 **Port of Amsterdam**



The Production of Blue Industrial Hydrogen in Rotterdam

The production of hydrogen based on natural gas and through the reuse of refinery gases. The CO₂ released during production is captured and stored in empty gas fields below the North Sea or can be reused in the industrial area.

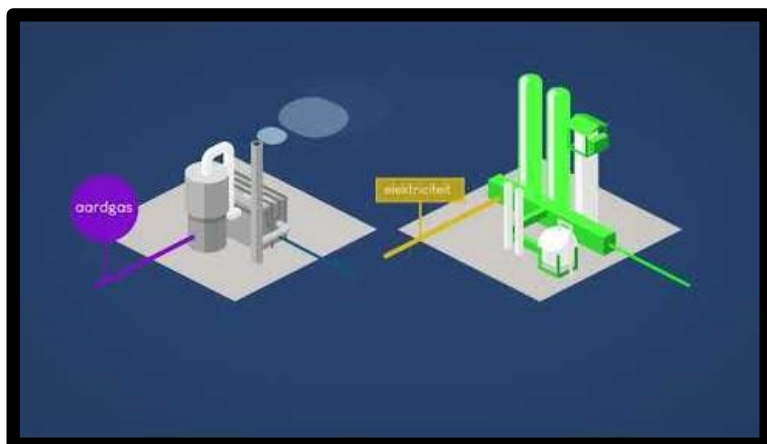

Category:	production of H ₂
Capacity:	several installations
Process phase:	FEED-study
Project period:	2020 - 2026
Project costs:	2 B investment
Contact:	hgj.regeer@portofrotterdam.com

Partners: Air Liquide, BP, Deltalinqs, Gasunie, Havenbedrijf Rotterdam, Power Plant Rotterdam, Shell, Uniper en Vopak



GreenH2UB

Creating a Green Hydrogen Ecosystem in Noord-Brabant

Aims to develop a green hydrogen ecosystem. It will contain 3-10 MWA GreenH2UB plants (transformers) balancing the grid with hydrogen production for application and Deployment in industry, heavy mobility and built environment.



Category:	production of green H ₂
Capacity:	10 x 3-10MW(330k-1m kg/y)
Process phase:	feasibility-study
Project period:	2019 - 2030
Project costs:	unknown
Contact:	www.greenh2ub.nl

Partners:

Brabantse Ontwikkelings Maatschappij



HEAVENN

H₂ Energy Applications in Valley Environments for Northern NL

The projects support focus on sectoral integration: the large-scale production of green hydrogen as a raw material for industry, the storage, transport and distribution of hydrogen and its application for energy supply for both industry and the built environment and in mobility.



Category:	production H ₂ in Energy Valley
Capacity:	30 subprojects
Process phase:	execution
Project period:	2020 - 2025
Project costs:	90 M
Contact:	New Energy Coalition

Partners:



Hydrogen Delta

Aiming for a Gigawatt Factory in the Delta Region

Realisation of a large pilot (on a ~ 100 MW scale) and a large-scale green hydrogen factory (on a ~ GW scale) by 2025. Blue hydrogen is used in the transition to green. In addition, realisation of a hydrogen network in the port area, which is connected to the national network.



Category:	production, distribution
Capacity:	1 GW
Process phase:	concept
Project period:	2020 - 2030
Project costs:	>100 M
Contact:	www.smartdeltaresources.com

Partners:



GZI NEXT

A Second Life for the GZI Site in Emmen, with Hydrogen

Together they look at the possibilities of using the existing infrastructure for the generation of green gas through fermentation or gasification and for the generation of hydrogen. Wind, sun and renewable gas are seen as important components in the sustainable energy picture of 2050.



Category:	production, distribution
Capacity:	-
Process phase:	feasibility-study
Project period:	2018 -
Project costs:	unknown
Contact:	www.gzinext.nl

Partners:



gasunie



ebn



Gemeente Emmen

provincie Drenthe



EMMTEC
A GETEC GROUP COMPANY



Bio Energy Netherlands

Wood Gasification with Production of Hydrogen and CO₂

The wood gasification plant in Amsterdam will extract hydrogen and CO₂ from the syngas, which can be used for transport fuels and in the chemical industry, amongst others. Developing and testing a gas upgrading system linked to a gasifier for production of green hydrogen.



Category:	production
Capacity:	-
Process phase:	FEED-study
Project period:	2019 - 2021
Project costs:	TSE 500 k
Contact:	info@bioenergynetherlands.nl

Partners:



Bio Energy Netherlands



Hydrogen Gas Turbine Retrofit

Hydrogen Gas Turbine Retrofit to Eliminate Carbon Emissions

To develop a cost effective ultralow emissions (sub 9ppm NOx and CO) combustion system retrofit for existing installed gas turbines in the output range of 1 MW to 300 MW. Fuel flexibility and stable operation is required from 100% natural gas to 100% hydrogen.

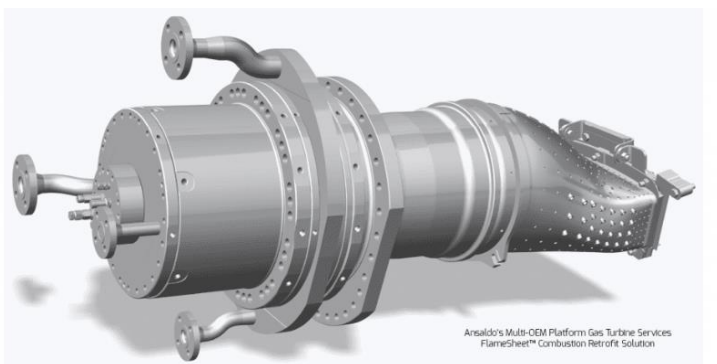

Category:	production
Capacity:	-
Process phase:	FEED-study
Project period:	2019 - 2020
Project costs:	TSE 500 k
Contact:	Huub Koeman, Ansaldo Energia

Partners:



AkzoNobel



Hydrogen Mill

Building a Windmill that Produces Hydrogen

The goal is to build a 4.8 MW Lagerweij windmill and a 2 MW electrolyser to demonstrate the production of hydrogen by windmills on the ECN test location in the Wieringermeer. This is part of the DUWAAL project that focusses on the hydrogen region of north-western Netherlands.



Category:	production
Capacity:	2 MW
Process phase:	FEED-study
Project period:	2020 -
Project costs:	unknown
Contact:	jwlangeraar@hy-gro.nl

Partners:



PosHYdon

Hydrogen Production from North Sea Water on an Offshore Platform

A 1 MW electrolyser in a sea container on the platform, the Q13a, is very suitable for this. It is a fully electrified offshore platform. This electrification with green electricity saves 16.5 kt of CO₂ per year.



Category:	production
Capacity:	1 MW
Process phase:	FEED-study
Project period:	2019 - 2021
Project costs:	unknown
Contact:	Bas Rijke / neptuneenergy.com

Partners:

NEPTUNE
ENERGY

nexstep

TNO innovation
for life



H2ermes

Building a 100 MW Hydrogen Plant in Amsterdam for TaTa Steel

Deployment of hydrogen delivered by a 100 MW electrolysis plant to produce fuels and / or basic chemicals with the carbon monoxide (CO) and carbon dioxide (CO₂) in the residual gases from the steel production at TaTa Steel.

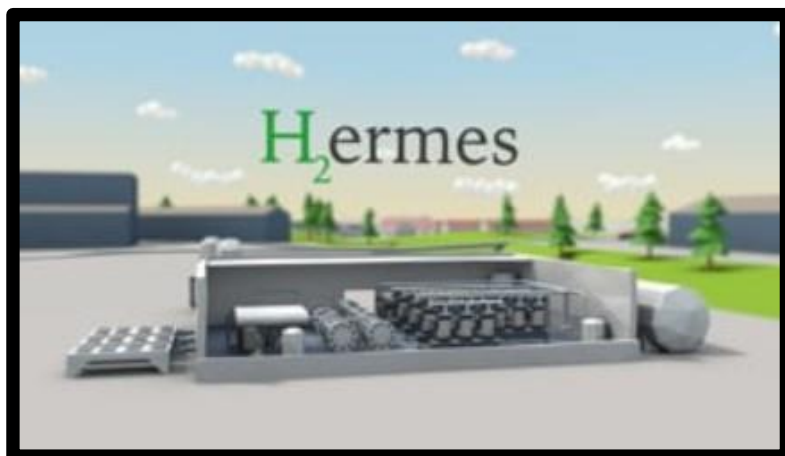

Category:	production
Capacity:	100 MW
Process phase:	FEED-study
Project period:	2019 -
Project costs:	150 M
Contact:	Jan.Egbertsen@portofamsterdam.com

Partners:



TATA STEEL

Nouryon



Molten Metal Methane Pyrolysis

Producing 'Turquoise' Hydrogen from Natural Gas

Methane pyrolysis produces hydrogen from natural gas with carbon (and not CO₂) as a valuable by-product. Affordable and commercially applicable within a few years. The applications are diverse. Think of additive for steel, filler in car tires, graphite, dye and soil conditioner.



Category:	production, knowledge
Capacity:	-
Process phase:	concept
Project period:	2019 -
Project costs:	unknown
Contact:	willem.frens@tno.nl

Partners:



Hydrogen from Organic Waste

Producing Hydrogen by Gasification of Biomass in 'het Groene Hart'

The pilot plant, the size of four parking spaces, is placed at a civil engineering company. Roadside grass and other organic waste is used for testing. The hydrogen obtained is initially used by Vermeulen Groep, who wants to make their business more sustainable.



Category:	production of H ₂
Capacity:	?
Process phase:	FEED-study
Project period:	2019 - 2021
Project costs:	unknown
Contact:	info@nettenergy.com

Partners:



NorthH2

The Production of Green Hydrogen from a GW Windfarm in the North Sea

The objective is to generate 3 to 4 GW of wind energy for hydrogen production by 2030, and possibly 10 GW in 2040. Green hydrogen production of 800,000 tons, prevents around 7 megatons of CO₂ emissions per year.



Category:	production of H ₂
Capacity:	3 - 4 GW wind – 0,8 Mt H ₂ /y
Process phase:	feasibility-study
Project period:	2020 - 2040
Project costs:	unknown
Contact:	info@gasunie.nl

Partners:

gasunie



H2GO

Towards Hydrogen Island Goeree Overflakkee

A 2.5 MW electrolyser will be producing renewable hydrogen and connecting the hydrogen production unit at the Greenpoint hydrogen refuelling station to Stad aan 't Haringvliet via Energy Park Oude-Tonge. Next will be the upgrade to a 26 MW electrolyser from wind energy.



Category:	production, storage, distribution
Capacity:	2.5 MW to 26 MW
Process phase:	feasibility-study
Project period:	2017 - 2030
Project costs:	unknown
Contact:	info@goeree-overflakkee.nl

Partners: 30+ parties



gemeente
Goeree-Overflakkee



HyNetherlands

Building a 100 MW Electrolyser in the Eemshaven

The factory will also have an important function for the balance in the electricity system. If the wind farms supply more electricity than is currently needed, it can be converted into hydrogen and stored. If necessary, the hydrogen can be converted back into electricity.



Category:	production
Capacity:	100 MW to 1 GW
Process phase:	feasibility-study
Project period:	FID 2021-2022
Project costs:	50 – 100 M
Contact:	info@gasunie.nl

Partners:



Blue Hydrogen Den Helder

Empty Gas Fields Play a Role for Blue Hydrogen Production

The hydrogen gas can be produced with green energy from the (large) offshore wind farms that will be built in the coming decades. But even now hydrogen can be produced from natural gas. The released CO₂ can be captured and stored in the empty gas fields below the North Sea.

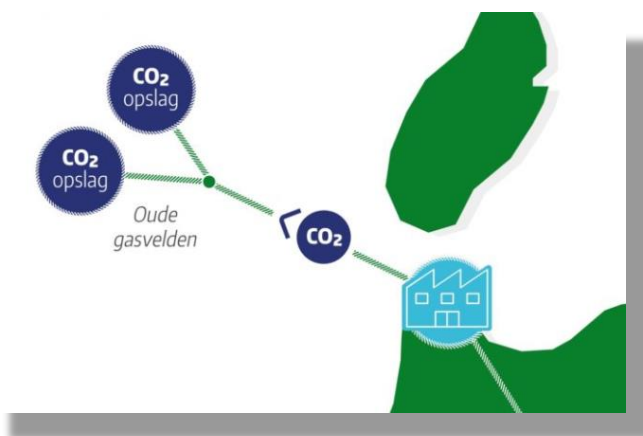

Category:	production
Capacity:	large factory
Process phase:	feasibility-study
Project period:	2020 - 2022
Project costs:	unknown
Contact:	Thijs Pennink, info@nhn

Partners:



GldH2

A Hydrogen Cooperative in Zutphen Aiming for a 1 MW Electrolyser

A hydrogen factory is to be built on the industrial area 'De Mars' and various pilot projects are being set up. The GldH2 cooperative works together with the local energy cooperative Zutphen Energie and with thirteen partners in the region.



Category:	production
Capacity:	1 MW electrolyser
Process phase:	feasibility-study
Project period:	2020 -
Project costs:	unknown
Contact:	https://gldh2.nl/

Partners o.a.:



PRIMAGAZ



Provincie Gelderland



Hydrogen Mill Sint Philipsland

To Use Profits to Benefit the Livability of the Community

The initiators of the windmill look for an alternative for the full electricity grid. The use of the national natural gas network for storage, distribution and deployment of their own production of hydrogen. Therefore they hope to make the peninsula Sint Philipsland a hydrogen village.



Category:	production
Capacity:	1 windmill
Process phase:	feasibility-study
Project period:	2020 - 2022
Project costs:	126 k subsidy
Contact:	pers@stedin.net

Partners o.a.:



Storage

Overview



Hydrogenpilot Oosterwolde

An 1-2 MW Electrolyser Placed at a Solarpark for Netbalancing

Instead of reducing the generation at peak times, an electrolyser is used to convert electricity and water into hydrogen. In this way a peak load in the grid becomes prevented. The hydrogen can then be used in hydrogen vehicles.



Category: storage, knowledge
 Capacity: 1-2 MW
 Process phase: execution
 Project period: 2019 - 2021
 Project costs: unknown
 Contact: ben.tubben@qirion.nl

Partners:



H2Fuel

A Technique for the Production, Storage and Release of H₂

The storage takes place under atmospheric conditions in a powder and the release takes place without added energy with very clean water. Hereby not only 100% of the hydrogen stored in the powder is released, but also the same amount of hydrogen from the water is harvested.



Category: storage
 Capacity: scale up
 Process phase: FEED-study/proof of concept
 Project period: 2019 -
 Project costs: unknown
 Contact: https://h2-fuel.nl

Partners:



Cyrus SMith

Creating a Mobile 20 KW Electrolyser for Local Energy Storage

The fluctuating nature of renewable energy sources necessitates flexibility in our energy infrastructure. This is a feasibility study for a mobile unit that provides grid support at medium and low voltage level by converting green electricity into hydrogen.



Picture: iMHy.com

Category: storage, knowledge
 Capacity: 20 KW
 Process phase: concept
 Project period: 2019 - 2020
 Project costs: TSE 50 k
 Contact: J.F. Janssen, Hymatters

Partners:



HyStock

A 1 MW P2G Installation with Large-scale Energy Storage

Converting sustainable electricity into hydrogen for transport and industry at the site of EnergyStock storage facility. The EnergyStock facility is ideally situated for this project thanks to buffer capacity and connection with the main gas and electricity infrastructure.



Category: storage, production
 Capacity: 1 MW
 Process phase: commissioning
 Project period: 2018 - 2020
 Project costs: EU subsidy
 Contact: info@energystock.com

Partners:



P2P IPKW

Power-to-Power Installation Makes IPKW Energy Neutral

The P2P installation converts the peak current on location into hydrogen and stores it temporarily. The electricity can later be used for electricity, hot water or (hydrogen) gas. In this way we prevent large fluctuations in the electricity grid and is green energy available 24 hours a day.

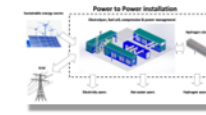

Category: storage, knowledge
 Capacity: 1 MW
 Process phase: feasibility-study
 Project period: 2019 -
 Project costs: unknown
 Contact: info@hygear.nl

Partners:



Hydrogenpilot Oosterwolde

An 1-2 MW Electrolyser Placed at a Solarpark for Netbalancing

Instead of reducing the generation at peak times, an electrolyser is used to convert electricity and water into hydrogen. In this way a peak load in the grid becomes is prevented. The hydrogen can then be used in hydrogen vehicles.



Category:	storage, knowledge
Capacity:	1-2 MW
Process phase:	execution
Project period:	2019 - 2021
Project costs:	unknown
Contact:	ben.tubben@qirion.nl

Partners:



H2Fuel

A Technique for the Production, Storage and Release of H₂

The storage takes place under atmospheric conditions in a powder and the release takes place without added energy with very clean water. Hereby not only 100% of the hydrogen stored in the powder is released, but also the same amount of hydrogen from the water is harvested.



Category:	storage
Capacity:	scale up
Process phase:	FEED-study/proof of concept
Project period:	2019 -
Project costs:	unknown
Contact:	https://h2-fuel.nl

Partners:



Cyrus SMith

Creating a Mobile 20 KW Electrolyser for Local Energy Storage

The fluctuating nature of renewable energy sources necessitates flexibility in our energy infrastructure. This is a feasibility study for a mobile unit that provides grid support at medium and low voltage level by converting green electricity into hydrogen.



Picture: McPhy.com

Category:	storage, knowledge
Capacity:	20 KW
Process phase:	concept
Project period:	2019 - 2020
Project costs:	TSE 50 k
Contact:	J.F. Janssen, Hymatters

Partners:



HyMatters

H2Consultancy

Making Fuelcell Systems



HyStock

A 1 MW P2G Installation with Large-scale Energy Storage

Converting sustainable electricity into hydrogen for transport and industry at the site of EnergyStock storage facility. The EnergyStock facility is ideally situated for this project thanks to buffer capacity and connection with the main gas and electricity infrastructure.



Category:	storage, production
Capacity:	1 MW
Process phase:	commissioning
Project period:	2018 - 2020
Project costs:	EU subsidy
Contact:	info@energystock.com

Partners:



ebn

Nouryon



ECN

TNO

innovation
for life



P2P IPKW

Power-to-Power Installation Makes IPKW Energy Neutral

The P2P installation converts the peak current on location into hydrogen and stores it temporarily. The electricity can later be used for electricity, hot water or (hydrogen) gas. In this way we prevent large fluctuations in the electricity grid and is green energy available 24 hours a day.

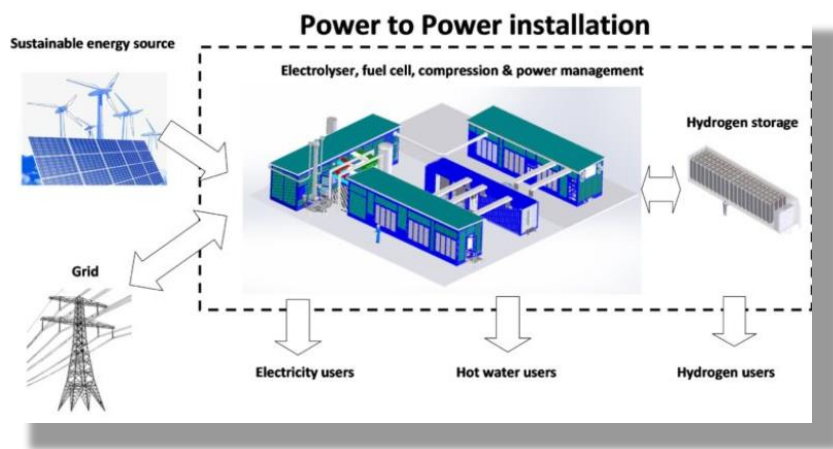

Category:	storage, knowledge
Capacity:	1 MW
Process phase:	feasibility-study
Project period:	2019 -
Project costs:	unknown
Contact:	info@hygear.nl

Partners:



Transportation

Overview



Hydrogen Sensor Technology

Developing Better Sensors for Natural Gas / Hydrogen Mixtures

The project aims to develop a technology that allows the cost-effective and sufficiently accurate measurement of the composition of natural gas / hydrogen mixtures, wherein high concentrations of hydrogen are mixed (typically up to 90%).



Category:	transportation
Capacity:	-
Process phase:	concept
Project period:	2018 – 2020
Project costs:	TKI 225 k
Contact:	Huib Blokland, TNO

Partners:



Natural Gas Pipeline to H₂

YARA Receives 4,000 tons of Green H₂ / Year from DOW Chemical

The hydrogen released by Dow crackers is used as a raw material for high-quality Yara products. This will result in an initial decrease in energy consumption of 0.15 PJ per year. In addition, it would reduce CO₂ emissions by 10,000 tons.



Category:	transportation
Capacity:	4,000 tons H ₂ /year
Process phase:	commissioning
Project period:	2017 - 2020
Project costs:	unknown
Contact:	evanoosten@dow.com

Partners:



Hydrogen Sensor Technology

Developing Better Sensors for Natural Gas / Hydrogen Mixtures

The project aims to develop a technology that allows the cost-effective and sufficiently accurate measurement of the composition of natural gas / hydrogen mixtures, wherein high concentrations of hydrogen are mixed (typically up to 90%).



Category: transportation

Capacity: -

Process phase: concept

Project period: 2018 – 2020

Project costs: TKI 225 k

Contact: Huib Blokland, TNO

Partners:



Natural Gas Pipeline to H₂

YARA Receives 4,000 tons of Green H₂ / Year from DOW Chemical

The hydrogen released by Dow crackers is used as a raw material for high-quality Yara products. This will result in an initial decrease in energy consumption of 0.15 PJ per year. In addition, it would reduce CO₂ emissions by 10,000 tons.



Category:	transportation
Capacity:	4,000 tons H ₂ /year
Process phase:	commissioning
Project period:	2017 - 2020
Project costs:	unknown
Contact:	evanoosten@dow.com

Partners:



Knowledge grows



Distribution

Overview

Hydrogen Street

Research into Possibilities for Reusing the Natural Gas Grid

The grid operators in the Green Village investigate the behavior of gas stations and their meters. They also research the necessary safety measures, such as new working methods and tools. This gas grid is therefore available as a testing site for other parties to do research.

Category:	distribution
Capacity:	-
Process phase:	commissioning
Project period:	2020 - 2025
Project costs:	unknown
Contact:	Elbert Huijzer, Alliander

Partners:

NSWPH

North Sea Wind Power Hub; a Chain in Future Energy Supply

The Hub-and-Spoke concept consists of modular hubs in the North Sea connecting offshore wind farms with interconnectors to bordering North Sea countries and facilitates sector coupling through power-to-Hydrogen conversion.

Category:	distribution
Capacity:	10 > 30 GW
Process phase:	FEED-studies
Project period:	2020 -
Project costs:	unknown
Contact:	info@northseawindpowerhub.eu

Partners:



Hydrogen Street

Research into Possibilities for Reusing the Natural Gas Grid

The grid operators in the Green Village investigate the behavior of gas stations and their meters. They also research the necessary safety measures, such as new working methods and tools. This gas grid is therefore available as a testing site for other parties to do research.



Category:	distribution
Capacity:	-
Process phase:	commissioning
Project period:	2020 - 2025
Project costs:	unknown
Contact:	Elbert Huijzer, Alliander

Partners:



North Sea Wind Power Hub; a Chain in Future Energy Supply

The Hub-and-Spoke concept consists of modular hubs in the North Sea connecting offshore wind farms with interconnectors to bordering North Sea countries and facilitates sector coupling through power-to-Hydrogen conversion.

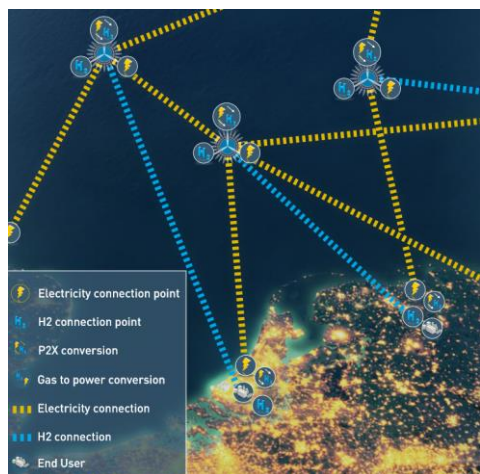

Category:	distribution
Capacity:	10 > 30 GW
Process phase:	FEED-studies
Project period:	2020 -
Project costs:	unknown
Contact:	info@northseawindpowerhub.eu

Partners:



Deployment: Energy Supply

Overview



Hydrogen-to-Magnum

Conversion of the 1,320 MW Magnum E-Plant into Fueled by Hydrogen

The natural gas plant will first use blue hydrogen after the conversion, where the CO₂ is captured and stored underground in Norway. In time, the plant will only use green hydrogen (obtained by electrolysis). Gasunie is investigating the possibility of storage of hydrogen in caverns.



Category:	deployment in energy supply
Capacity:	3 x 440 MW
Process phase:	FEED-study / execution
Project period:	2020 - 2030
Project costs:	unknown
Contact:	k.g.wiersma@gasunie.nl

Partners:



H₂ Air Base Leeuwarden

Air Base Leeuwarden Focuses on Hydrogen and Biofuel

It is investigated whether the base itself can produce and store hydrogen, also for use in the vehicles and in the built environment. There are also plans to produce hydrogen with the 10 ha large solar park that has been developed. The hydrogen should also serve as emergency power.



Category:	deployment in energy supply
Capacity:	5 MW solar power
Process phase:	feasibility-study
Project period:	2019 - 2022
Project costs:	unknown
Contact:	www.defensie.nl

Partners:



Hysolar

The Production and Supply of Green Hydrogen in Nieuwegein

The organization is installing a 2 MW electrolyser, which is linked to a large solar park. Eventually, the project will produce 250 tons of hydrogen per year. Approximately 750 cars or 25 buses will be able to run on this every day for an entire year. 11 Hyundai Nexos have already been delivered.



Category:	deployment in energy supply
Capacity:	250 ton H ₂ / year
Process phase:	execution
Project period:	2020
Project costs:	unknown
Contact:	www.hysolar.nl

Partners:



Hydrogen-to-Magnum

Conversion of the 1,320 MW Magnum E-Plant into Fueled by Hydrogen

The natural gas plant will first use blue hydrogen after the conversion, where the CO₂ is captured and stored underground in Norway. In time, the plant will only use green hydrogen (obtained by electrolysis). Gasunie is investigating the possibility of storage of hydrogen in caverns.



Category:	deployment in energy supply
Capacity:	3 x 440 MW
Process phase:	FEED-study / execution
Project period:	2020 - 2030
Project costs:	unknown
Contact:	k.g.wiersma@gasunie.nl

Partners:



H₂ Air Base Leeuwarden

Air Base Leeuwarden Focuses on Hydrogen and Biofuel

It is investigated whether the base itself can produce and store hydrogen, also for use in the vehicles and in the built environment. There are also plans to produce hydrogen with the 10 ha large solar park that has been developed. The hydrogen should also serve as emergency power.



Category:	deployment in energy supply
Capacity:	5 MW solar power
Process phase:	feasibility-study
Project period:	2019 - 2022
Project costs:	unknown
Contact:	www.defensie.nl

Partners:



Koninklijke Luchtmacht



Hysolar

The Production and Supply of Green Hydrogen in Nieuwegein

The organization is installing a 2 MW electrolyser, which is linked to a large solar park. Eventually, the project will produce 250 tons of hydrogen per year. Approximately 750 cars or 25 buses will be able to run on this every day for an entire year¹¹ Hyundai Nexo's have already been delivered.



Category:	deployment in energy supply
Capacity:	250 ton H ₂ / year
Process phase:	execution
Project period:	2020
Project costs:	unknown
Contact:	www.hysolar.nl

Partners:



Aannemingsbedrijf Jos Scholman



Deployment: Industrial

Overview

The overview grid contains 12 thumbnails, each with a red arrow pointing to the right. The thumbnails are arranged in a 3x4 grid. The first thumbnail is titled 'Overview of Hydrogen Prospects in the Netherlands' and features the 'THE NEW GAS' logo. The other thumbnails represent various sections of the report, including 'Introduction', 'Expansion of the information base', 'Production', 'Storage', 'Transportation', 'Distribution', 'Deployment - Energy Supply', 'Deployment - Industrial', 'Deployment - Mobility', 'Deployment - Built Environment', and 'Knowledge'.

E-THOR

Realisation of a 5 MW Electrolyser in the Botlek Area

Investigation of the technical and economic feasibility of a 5 MW electrolyser at AVR and Tronox in the Botlek. This considers the possibilities for processing CO / CO₂ from residual gas, and possibly also fluid gas, into chemical compounds such as methanol.



Category:	industrial deployment of H ₂
Capacity:	5 MW > 100 MW
Process phase:	feasibility-study until may 2020
Project period:	2020
Project costs:	unknown
Contact:	rijk@deltainqs.nl

Partners:



E-THOR

Realisation of a 5 MW Electrolyser in the Botlek Area

Investigation of the technical and economic feasibility of a 5 MW electrolyser at AVR and Tronox in the Botlek. This considers the possibilities for processing CO / CO₂ from residual gas, and possibly also fluid gas, into chemical compounds such as methanol.



Category:	industrial deployment of H ₂
Capacity:	5 MW > 100 MW
Process phase:	feasibility-study until may 2020
Project period:	2020
Project costs:	unknown
Contact:	rijk@deltalinqs.nl

Partners:



Deltalinqs

AVR.



TRONOX



Deployment: Mobility

Overview

THE NEW GAS Deployment of Hydrogen Projects in the Netherlands	Introduction Introduction text describing the project goals and objectives.	Explanation of the information box Detailed explanation of the data presented in the information box.	Production Information regarding the production processes and facilities.
Storage Information about storage methods and capacities.	Transportation Details on transport routes and infrastructure.	Distribution Information on distribution networks and logistics.	Deployment - Energy Supply Details on energy supply sources and requirements.
Deployment - Industrial Information on industrial applications and use cases.	Deployment - Mobility Details on mobility applications and vehicle integration.	Deployment - Built Environment Information on building and infrastructure integration.	Knowledge Summary of key findings and knowledge gained.

Deployment: Mobility I

Overview	Hydrogen Mobility I	Hydrogen Mobility II	Hydrogen Mobility III	Hydrogen Mobility IV
Hydrogen Mobility V	Hydrogen Mobility VI	Hydrogen Mobility VII	Hydrogen Mobility VIII	Hydrogen Mobility IX
Hydrogen Mobility X	Hydrogen Mobility XI	Hydrogen Mobility XII	Hydrogen Mobility XIII	Hydrogen Mobility XIV
Hydrogen Mobility XV	Hydrogen Mobility XVI	Hydrogen Mobility XVII	Hydrogen Mobility XVIII	Hydrogen Mobility XIX
Hydrogen Mobility XX	Hydrogen Mobility XXI	Hydrogen Mobility XXII	Hydrogen Mobility XXIII	Hydrogen Mobility XXIV

Deployment: Mobility II

Overview	Deployment - Mobility I	5 H₂ Filling Stations by Greenpoint Fuels To Develop and Construct 5 Hydrogen Filling Stations in NL Greenpoint Fuels is developing and constructing 5 hydrogen filling stations in the Netherlands. The stations will be located in Amsterdam, Rotterdam, The Hague, Utrecht and Groningen.
45 Hydrogen Trucks Use of 45 Hydrogen Trucks for Special Cars (NHSS) Transportation NHSS is developing and constructing 45 hydrogen trucks for special cars transportation in the Netherlands. The trucks will be used for the transport of special cars from the production sites to the ports.	Hydrogen Ships Luxembourg Investigating the Possibility of Ships Sailing on Green Hydrogen Luxembourg is investigating the possibility of ships sailing on green hydrogen. The project aims to develop a hydrogen-powered ship that can sail between Luxembourg and other ports in the region.	Sparkless Water-based Island Mobility (SWIM) Hydrogen Watercraft Sparkless Water-based Island Mobility (SWIM) is developing and constructing hydrogen watercraft for island mobility. The watercraft will be used for the transport of passengers and goods between islands in the region.



Deployment: Mobility I

<h3>Overview</h3>	<h3>Deployment: Mobility II</h3>	<h3>H2RenT</h3> <h4>Building 6 Hydrogen-powered Garbage Trucks</h4> <p>The trucks will be operating in different locations, so that municipalities and collection companies can become acquainted with hydrogen technology. A unique aspect is that service companies are also involved in the demonstration project.</p> <p>Category: deployment in mobility Capacity: 6 trucks Process phase: feasibility study Project period: 2020 - Project costs: unknown Contact: stefan.reis@waterstofnet.nl</p> <p>Partners: </p>	<h3>RH2RINE</h3> <h4>Rhine Hydrogen Integration Network of Excellence</h4> <p>Aiming for 10 ships running on hydrogen in 2030 on the Rhine between Rotterdam - Genoa, fueled by (at least) three hydrogen filling stations and three consortia of private parties.</p> <p>Category: deployment in mobility Capacity: 10 ships and 3 filling stations Process phase: feasibility study Project period: 2020 - 2030 Project costs: unknown Contact: hg.meynen@conihofrotterdam.com</p> <p>Partners: </p>	<h3>DUWAAL</h3> <h4>Development of a Green Hydrogen Economy in the Northwestern NL</h4> <p>The realization of a first hydrogen gas station in Alkmaar, two hydrogen trucks, a hydrogen sweeper, the development of an integrated storage, transport and distribution system for hydrogen. It will be combined with a 4.8 MW hydrogen mill.</p> <p>Category: deployment in mobility Capacity: 2 MW Process phase: FEED-study Project period: 2020 - Project costs: DKTI 2 M Contact: j.walgenaar@hygr.nl</p> <p>Partners: </p>
<h3>H2SHIPS</h3> <h4>System-Based Solutions for H₂-Fueled Water Transport in NW Europe</h4> <p>Development of a hydrogen supply chain for shipping (interco) inland vessels. A new hydrogen powered port vessel will be built in Amsterdam. In Belgium, a H₂ refueling system suitable for open sea operation, will be developed and tested.</p> <p>Category: deployment in mobility Capacity: 1 port vessel Process phase: FEED-study Project period: 2016 - 2022 Project costs: 7.2 M total EU project Contact: jan.fijgenwer@waterstofnet.nl</p> <p>Partners: </p>	<h3>REVIVE</h3> <h4>Refuse Vehicle Innovation and Validation in Europe</h4> <p>Integrating fuel cell powertrains into 15 vehicles and deploying them in 8 sites across Europe. An additional task will explore the potential for 'Waste-to-Wheel' business models where the fuel cell trucks are combined with more affordable green hydrogen sourced from waste plants.</p> <p>Category: deployment in mobility Capacity: 15 waste trucks Process phase: execution Project period: 2016 - 2021 Project costs: 8.7 M total EU project Contact: stefan.reis@waterstofnet.nl</p> <p>Partners: </p>	<h3>5-10 H₂ Filling Stations by OrangeGas</h3> <h4>Designing and building a Hydrogen Filling Point at Existing Gas Stations</h4> <p>Designing and building 5-10 hydrogen filling stations in Amsterdam, Utrecht, Zeewijk and Lissewoude. At the locations it will be possible to refuel hydrogen with both 700 bar (passenger cars) and 350 bar (larger vehicles such as buses).</p> <p>Category: deployment in mobility Capacity: 350/700 bar filling stations Process phase: FEED-study Project period: 2016 - Project costs: DKTI + BENEFC subsidy Contact: info@orangegas.nl</p> <p>Partners: </p>	<h3>H₂ Fuel Station in The Hague</h3> <h4>Designing and building a Hydrogen Filling Point at Existing Gas Stations</h4> <p>After a long preparation, we can finally report that the installation of our 350/700 bar hydrogen filling point is ready. At this point, anyone can help with testing by refueling.</p> <p>Category: deployment in mobility Capacity: 350/700 bar filling point Process phase: commissioning (in operation) Project period: 2016 - 2020 Project costs: unknown Contact: willem.hrens@tho.nl</p> <p>Partners: </p>	<h3>SkyNRG</h3> <h4>Green Hydrogen for Producing Sustainable Aviation Fuel (SAF)</h4> <p>Use of hydrogen from to refine kerosene and hydrogen in the SkyNRG initiative in Delft. From 2022, the plant will annually produce 100,000 tons of SAF, as well as 15,000 tons of bio-PDF, as a byproduct. CO₂ reduction would be 270,000 tons a year.</p> <p>Category: deployment in mobility Capacity: 40 MW electrolyser capacity Process phase: execution Project period: plant open in 2022 Project costs: unknown Contact: info@skynrg.com</p> <p>Partners: </p>
<h3>50 Fuel Cell Electric Buses</h3> <h4>Towards Clean Public Transport with Hydrogen in the Netherlands</h4> <p>Demonstration of 50 hydrogen buses on Dutch public transportation. This is part of JIVE 2 subsidies and part of a greater European project. The hydrogen buses will run in the provinces of South-Holland, Groningen and Drenthe.</p> <p>Category: deployment in mobility Capacity: 50 buses Process phase: execution Project period: 2016 - 2020 Project costs: 25 M total EU project Contact: ryan.vandenberg@orangeip.com</p> <p>Partners: </p>	<h3>H2-SHARE</h3> <h4>Hydrogen Solutions for Heavy-duty (27 tons) Transport in NW Europe.</h4> <p>For large heavy-duty vehicles which travel longer distances, electric trucks with a hydrogen fuel cell range extender are possible zero-emission solutions. In the EU, such vehicles are not yet commercially available but have enormous potential. 'H2-Share' aims to unlock this potential.</p> <p>Category: deployment in mobility Capacity: 1 truck, 1 mobile filling station Process phase: commissioning Project period: 2016 - 2021 Project costs: 1.7 M Interreg subsidy Contact: stefan.reis@waterstofnet.nl</p> <p>Partners: </p>	<h3>Hydrogen Train</h3> <h4>Hydrogen Trains as a Sustainable Alternative for Diesel Trains</h4> <p>In March 2023 train rides are made with a Coradia iLint-hydrogen train, to test whether this type of train can run in the timetable. The province wants to make rail transport in the north of the Netherlands more sustainable, which is currently still largely carried out by diesel trains.</p> <p>Category: deployment in mobility Capacity: 1,000 km per filling Process phase: commissioning Project period: 2020 Project costs: unknown Contact: info@proRail.nl</p> <p>Partners: </p>	<h3>Diesel to PFCEV</h3> <h4>Building a Retrofit for a 30 kW Plug-in Fuel Cell Electric Vehicle</h4> <p>The project includes R&D towards an experimental 30kW fuel cell range extender system, which will be tested in a PFCEV city truck. After success, a production line is designed for retrofit conversion kits and a more generic application than vehicles.</p> <p>Category: deployment in mobility Capacity: 30 kW Process phase: feasibility study Project period: 2016 - 2020 Project costs: TSE 480 k Contact: walem@walelectrics.nl</p> <p>Partners: </p>	<h3>H2-Drive</h3> <h4>Incentive package for 90 Additional Hydrogen Cars in the Arnhem Region</h4> <p>With a 50% discount on refueling and much more benefits, like hydrogen car introductory training, pick-up service and replacement transport. This promotion is intended for people who live and/or work a maximum of 50 kilometers from the center of Arnhem.</p> <p>Category: deployment in mobility Capacity: 90 cars Process phase: commissioning Project period: 2020 - Project costs: 1 M Contact: www.h2-drive.nl</p> <p>Partners: </p>
<h3>Energy Points</h3> <h4>Refueling Stations with Hydrogen From and for the Future</h4> <p>Energy Points are modern hydrogen fueling stations with groundbreaking design. H2Huisen is currently working on the realization of 2 hydrogen filling stations in Groningen and Amsterdam. These 2 projects are being worked out and realized in collaboration with the municipalities.</p> <p>Category: deployment in mobility Capacity: 2 refilling stations Process phase: FEED-study Project period: 2020-2020 Project costs: DKTI-subsidy + 2000 t Alkmaar Contact: heag@h2huisen.nl</p> <p>Partners: </p>	<h3>Hydrogen Region 2.0</h3> <h4>The Development of a Hydrogen Filling Station in Breda</h4> <p>This filling station will supply green hydrogen to both passenger vehicles (700 bar) and heavy-duty vehicles (350 bar). H2Point is in discussion with the waste service Breda considering its garbage trucks, which is an important potential customer.</p> <p>Category: deployment in mobility Capacity: 1 refilling station Process phase: FEED-study Project period: 2020 - 2022 Project costs: Interreg and DKTI-subsidy Contact: info@h2point.nl</p> <p>Partners: </p>	<h3>High VLO City</h3> <h4>Accelerating Integration of Public Hydrogen Bus Transport in Cities</h4> <p>High VLO City does this by supporting the deployment of hydrogen buses in public transportation and the construction of hydrogen filling stations at the strategic locations Delft and Antwerp by H2Point.</p> <p>Category: deployment in mobility Capacity: 2 refilling stations Process phase: execution Project period: 2012 - 2022 Project costs: FCH-ready Contact: info@h2point.nl</p> <p>Partners: </p>	<h3>H2point</h3> <h4>Developing a Hydrogen Filling Station in Roosendaal.</h4> <p>This project is localised near the Rotterdam-Antwerp hydrogen pipeline adjacent to the A17 highway. The next project of H2Point will be a hydrogen refilling station in Oosterhout. The project is subsidised by TNO and BENEFC.</p> <p>Category: deployment in mobility Capacity: 2 refilling stations Process phase: execution Project period: 2020 Roosendaal ready Project costs: 1.5 M per station Contact: www.h2point.nl</p> <p>Partners: </p>	<h3>H₂ Filling Stations Den Helder</h3> <h4>To Develop a Hydrogen Filling Station for Maritime and Road Transport</h4> <p>As part of the project, Camen Shipyards will develop a hydrogen ship that will be offered to a pool of potential users. To supply the electrolyser, ENGIE is going to realize a 2.6 MWp solar park locally. The expected maximum capacity will be around 400 kg of green hydrogen.</p> <p>Category: deployment in mobility Capacity: 2 refilling stations 400 kg H₂ Process phase: FEED-study Project period: 2019 - 2021 Project costs: 1.4 M DKTI Contact: info@both.eu</p> <p>Partners: </p>



Deployment:

Mobility II

Overview

Deployment: Mobility I

5 H₂ Filling Stations by Greenpoint Fuels

To Develop and Construct 5 Hydrogen Filling Stations in NL

Greenpoint Fuels currently has pending permit applications for 5 hydrogen filling stations. Creating a network of tapping points; the filling stations will be located in Zeewolde, Ede, Bleiswijk, Oude-Tonge and Sliedrecht.

Category:	deployment in mobility
Capacity:	5 H ₂ filling stations
Process phase:	FEED-study / execution
Project period:	2019 - 2023
Project costs:	unknown
Contact:	info@greenpointfuels.nl

Partners:

45 Hydrogen Taxi's

Use of 45 Hydrogen Taxi's for Special Care (WMO) Transportation.

This is the first hydrogen taxi fleet in the Netherlands. 35 Toyota Mirai's are driving in The Hague and 10 in Ede. *"The client requires us to be available 24/7 with our fleet. Due to the large range of the hydrogen car and the fast refueling, Noot Personenvervoer can offer this."*

Category:	deployment in mobility
Capacity:	45 H ₂ taxi's
Process phase:	commissioning
Project period:	2019 - 2020
Project costs:	unknown
Contact:	info@noot.nl

Partners:

Hydrogen Ships Lauwersoog

Investigating the Possibility of Ships Sailing on Green Hydrogen

The coalition wants to start with the test ship 'Ecolution' of Wubbo Ockels. After a first test ship, the sustainable port coalition in the province of Groningen wants to expand to fishing vessels, tour boats, the brown fleet and agricultural vehicles in the future.

Category:	deployment in mobility
Capacity:	scale up
Process phase:	FEED-study
Project period:	2020 - 2030
Project costs:	1.2 M
Contact:	www.wadduurzaam.nl

Partners:

Speckless Water-based Inland Mobility (SWIM)

Hydrogen Watertaxi

Development of a water taxi running entirely on hydrogen. In 2021, it will be first time on this scale that a commercial boat comes into operation running entirely on this zero-emission fuel. This project developed within the zero-emission shipping program called THRUST.

Category:	deployment in mobility
Capacity:	1 taxi boat
Process phase:	FEED-study/ execution
Project period:	2020 - 2023
Project costs:	confidential
Contact:	https://thrust.enviu.org/

Partners o.a.:



Building 6 Hydrogen-powered Garbage Trucks

The trucks will be operating in different locations, so that municipalities and collection companies can become acquainted with hydrogen technology. A unique aspect is that service companies are also involved in the demonstration project.



Category:	deployment in mobility
Capacity:	6 trucks
Process phase:	execution
Project period:	2020 -
Project costs:	unknown
Contact:	stefan.neis@waterstofnet.eu

Partners:



RH2RINE

Rhine Hydrogen Integration Network of Excellence

Aiming for 10 ships running on hydrogen in 2030 on the Rhine between Rotterdam - Genoa , fueled by (at least) three hydrogen filling stations and three consortia of private parties.



Category:	deployment in mobility
Capacity:	10 ships and 3 filling stations
Process phase:	feasibility-study
Project period:	2020 – 2030
Project costs:	unknown
Contact:	hgj.regeer@portofrotterdam.com

Partners: the Province of South Holland, the State of North Rhine-Westphalia, Ministry of Infrastructure and Water Management, Province of Gelderland, Port of Rotterdam Authority, Duisburg Port Authority RhineCargo, BCTN, EICB, Nouryon, Covestro, Air Products, Future Proof Shipping, HTS Group, NPRC, AirLiquide and Koedood.



DUWAAL

Development of a Green Hydrogen Economy in the Northwestern NL

The realization of a first hydrogen gas station in Alkmaar, two hydrogen trucks, a hydrogen sweeper, the development of an integrated storage, transport and distribution system for hydrogen. It will be combined with a 4.8 MW hydrogen mill.

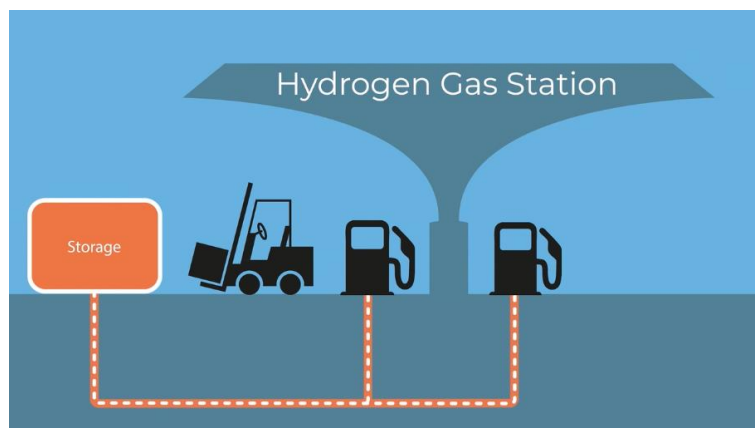

Category:	deployment in mobility
Capacity:	2 MW
Process phase:	FEED-study
Project period:	2020 -
Project costs:	DKTI 2 M
Contact:	jwlangeraar@hy-gro.nl

Partners:



H2SHIPS

System-Based Solutions for H₂-Fueled Water Transport in NW Europe

Development of a hydrogen supply chain for shipping (retrofit) inland vessels. A new hydrogen powered port vessel will be built in Amsterdam. In Belgium, a H₂ refueling system suitable for open sea operation, will be developed and tested.



Category:	deployment in mobility
Capacity:	1 port vessel
Process phase:	FEED-study
Project period:	2019 - 2022
Project costs:	7.2 M total EU project
Contact:	Jan.Egbertsen@portofamsterdam.com

Partners:



REVIVE



Refuse Vehicle Innovation and Validation in Europe

Integrating fuel cell powertrains into 15 vehicles and deploying them in 8 sites across Europe. An additional task will explore the potential for 'Waste-to-Wheel' business models where the fuel cell trucks are combined with more affordable green hydrogen sourced from waste plants.



Category:	deployment in mobility
Capacity:	15 waste trucks
Process phase:	execution
Project period:	2019 - 2021
Project costs:	8.7 M total EU project
Contact:	stefan.neis@waterstofnet.eu

Partners:



5-10 H₂ Filling Stations by OrangeGas



Designing and Building a Hydrogen Filling Point at Existing Gas Stations

Designing and building 5-10 hydrogen fueling stations in Amsterdam, Utrecht, Zwolle and Leeuwarden. At the locations it will be possible to refuel hydrogen with both 700 bar (passenger cars) and 350 bar (larger vehicles such as buses).



Category:	deployment in mobility
Capacity:	350/700 Bar filling stations
Process phase:	FEED-study
Project period:	2019 -
Project costs:	DKTI + BENEFIC subsidy
Contact:	info@orangegas.nl

Partners:



H₂ Fuel Station in The Hague



Designing and building a Hydrogen Filling Point at Existing Gas Stations

After a long preparation, we can finally report that the installation of our 350/700 Bar hydrogen filling point is ready. At this point, anyone can help with testing by refueling.



Category:	deployment in mobility
Capacity:	350/700 Bar filling point
Process phase:	commissioning [in operation]
Project period:	2019 - 2020
Project costs:	unknown
Contact:	willem.frens@tno.nl

Partners:



SkyNRG

Green Hydrogen for Producing Sustainable Aviation Fuel (SAF).

Use of hydrogen from to refine frying fat into sustainable kerosene and biopropane in the SkyNRG initiative in Delfzijl. From 2022, the plant will annually produce 100,000 tons of SAF, as well as 15,000 tons of bioLPG, as a byproduct. CO₂ reduction would be 270,000 tons a year.



Category:	deployment in mobility
Capacity:	40 MW electrolyser capacity
Process phase:	execution
Project period:	plant open in 2022
Project costs:	unknown
Contact:	info@skynrg.com

Partners:



50 Fuel Cell Electric Buses



Towards Clean Public Transport with Hydrogen in the Netherlands

Demonstration of 50 hydrogen buses on Dutch public transportation. This is part of JIVE 2 subsidies and part of a greater European project. The hydrogen buses will run in the provinces of South Holland, Groningen and Drenthe.



Category:	deployment in mobility
Capacity:	50 buses
Process phase:	execution
Project period:	2018 - 2020
Project costs:	25 M total EU project
Contact:	marc.vandersteen@rebelgroup.com

Partners o.a. :



H2-SHARE

Hydrogen Solutions for Heavy-duty (27 tons) Transport in NW Europe.

For large heavy-duty vehicles which travel longer distances, electric trucks with a hydrogen fuel cell range extender are possible zero-emission solutions. In the EU, such vehicles are not yet commercially available but have enormous potential. 'H2-Share' aims to unlock this potential.



Category:	deployment in mobility
Capacity:	1 truck, 1 mobile filling station
Process phase:	commissioning
Project period:	2020 - 2023
Project costs:	1.7 M Interreg subsidy
Contact:	stefan.neis@waterstofnet.eu

Partners:

VDL, Wystrach GmbH, Rai Automotive NL, BREYTNER, Colruyt Group, Cure, DHL, e-mobil BW, Hydrogen Europe, Dutch Ministry of Infrastructure and Water Management, TNO, WaterstofNet. The city of Helmond and VIL



Hydrogen Train

Hydrogen Trains as a Sustainable Alternative for Diesel Trains

In March 2020 train rides are made with a Coradia iLint-hydrogen train, to test whether this type of train can run in the timetable. The province wants to make rail transport in the north of the Netherlands more sustainable, which is currently still largely carried out by diesel trains.



Category:	deployment in mobility
Capacity:	1,000 km per filling
Process phase:	commissioning
Project period:	2020
Project costs:	unknown
Contact:	info@prorail.nl

Partners:

ProRail

 **arriva**
a  company

ALSTOM
• mobility by nature •

 **DEKRA**
On the safe side.



Diesel to PFCEV

Building a Retrofit for a 30 kW Plug-in Fuel Cell Electric Vehicle

The project includes R&D towards an experimental 30kW fuel cell range extender system, which will be tested in a PFCEV city truck. After success, a production line is designed for retrofit conversion kits and a more generic application than vehicles.



Category:	deployment in mobility
Capacity:	30 kW
Process phase:	feasibility-study
Project period:	2018 - 2020
Project costs:	TSE 460 k
Contact:	sales@newelectric.nl

Partners:



H2-Drive

Incentive package for 90 Additional Hydrogen Cars in the Arnhem Region

With a 50% discount on refueling and much more benefits, like hydrogen car introductory training, pick-up service and replacement transport. This promotion is intended for people who live and/or work a maximum of 30 kilometers from the center of Arnhem.



Category:	deployment in mobility
Capacity:	90 cars
Process phase:	commissioning
Project period:	2020 -
Project costs:	1 M
Contact:	www.h2-drive.nl



Energy Points

Refueling Stations with Hydrogen From and For the Future

Energy Points are modern hydrogen fueling stations with groundbreaking design. Holthausen is currently working on the realisation of 2 hydrogen filling stations in Groningen and Amsterdam. These 2 projects are being worked out and realised in collaboration with the municipalities.



Category:	deployment in mobility
Capacity:	2 refilling stations
Process phase:	execution
Project period:	2020-2020
Project costs:	DKTI-subsidy + 500 k A'dam
Contact:	lead@holthausen.nl

Partners:



Hydrogen Region 2.0

The Development of a Hydrogen Filling Station in Breda

This filling station will supply green hydrogen to both passenger vehicles (700 bar) and heavy-duty vehicles (350 bar). PitPoint is in discussion with the waste service Breda considering its garbage trucks, which is an important potential customer.



Category:	deployment in mobility
Capacity:	1 refilling station
Process phase:	FEED-study
Project period:	2020 - 2022
Project costs:	Interreg and DKTI-subsidy
Contact:	info@pitpoint.nl

Partners:



High V.LO City



Accelerating Integration of Public Hydrogen Bus Transport in Cities

High V.LO City does this by supporting the deployment of hydrogen buses in public transportation and the construction of hydrogen filling stations at the strategic locations Delfzijl and Antwerp by PitPoint.



Category:	deployment in mobility
Capacity:	2 refilling stations
Process phase:	execution
Project period:	2012 - 2022
Project costs:	FCH-subsidy
Contact:	info@pitpoint.nl

Partners:



Developing a Hydrogen Filling Station in Roosendaal.

This project is localised near the Rotterdam-Antwerp hydrogen pipeline adjacent to the A17 highway. The next project of H2Point will be a hydrogen refilling station in Oosterhout. The project is subsidised by TDKI and BENEFIC.



Category:	deployment in mobility
Capacity:	2 refilling stations
Process phase:	execution
Project period:	2020 Roosendaal ready
Project costs:	1.5 M per station
Contact:	www.h2point.nl

Partners:



H₂ Filling Stations Den Helder

To Develop a Hydrogen Filling Station for Maritime and Road Transport

As part of the project, Damen Shipyards will develop a hydrogen ship that will be offered to a pool of potential users. To supply the electrolyser, ENGIE is going to realize a 2.6 MWp solar park locally. The expected maximum capacity will be around 400 kg of green hydrogen.



Category:	deployment in mobility
Capacity:	2 refilling stations/ 400 kg H ₂
Process phase:	FEED-study
Project period:	2019 - 2021
Project costs:	1.4 M DKTI
Contact:	info@podh.eu

Partners:



5 H₂ Filling Stations by Greenpoint Fuels

To Develop and Construct 5 Hydrogen Filling Stations in NL

Greenpoint Fuels currently has pending permit applications for 5 hydrogen filling stations. Creating a network of tapping points; the filling stations will be located in Zeewolde, Ede, Bleiswijk, Oude-Tonge and Sliedrecht.



Category:	deployment in mobility
Capacity:	5 H ₂ filling stations
Process phase:	FEED-study / execution
Project period:	2019 - 2023
Project costs:	unknown
Contact:	info@greenpointfuels.nl

Partners:



MEIJER & VAN EERDEN



45 Hydrogen Taxi's

Use of 45 Hydrogen Taxi's for Special Care (WMO) Transportation.

This is the first hydrogen taxi fleet in the Netherlands. 35 Toyota Mirai's are driving in The Hague and 10 in Ede. *“The client requires us to be available 24/7 with our fleet. Due to the large range of the hydrogen car and the fast refueling, Noot Personenvervoer can offer this.”*



Category:	deployment in mobility
Capacity:	45 H ₂ taxi's
Process phase:	commissioning
Project period:	2019 - 2020
Project costs:	unknown
Contact:	info@noot.nl

Partners:

NOOT
voor het hele koor



Den Haag

LOUWMAN
DEALERBEDRIJVEN



Hydrogen Ships Lauwersoog

Investigating the Possibility of Ships Sailing on Green Hydrogen

The coalition wants to start with the test ship 'Ecolution' of Wubbo Ockels. After a first test ship, the sustainable port coalition in the province of Groningen wants to expand to fishing vessels, tour boats, the brown fleet and agricultural vehicles in the future.



Category:	deployment in mobility
Capacity:	scale up
Process phase:	FEED-study
Project period:	2020 - 2030
Project costs:	1.2 M
Contact:	www.wadduurzaam.nl

Partners:



Speckless Water-based Inland Mobility (SWIM)



Hydrogen Watertaxi

Development of a water taxi running entirely on hydrogen. In 2021, It will be first time on this scale that a commercial boat comes into operation running entirely on this zero-emission fuel. This project developed within the zero-emission shipping program called THRUST.



Category:	deployment in mobility
Capacity:	1 taxi boat
Process phase:	FEED-study/ execution
Project period:	2020 - 2023
Project costs:	confidential
Contact:	https://thrust.enviu.org/



Deployment: Built Environment

Overview

H2 Ready Central Heating Burner

Developing a H₂ Burner System as a Retrofit.
The goal is to develop a burner system that can replace the current natural gas burner. This means that future boilers for hydrogen can be produced. However, already installed boilers can also be converted with a retrofit.

Partners: **ATAG** (JAAN COMFORT ZONE) and **HYGEAR**

Category:	deployment in built environment
Capacity:	-
Process phase:	FEED-study
Project period:	2018 - 2020
Project costs:	TSE 250 k
Contact:	Ellari de Wit, Hygear

Hydrogen Neighbourhood Hoogeveen

100 Newly Built Houses and 430 Existing Houses Connected to Hydrogen
The newly built Nijstad-Oost residential area has been designated as a demonstration project for the application of hydrogen in newly-built houses. The destination plan will soon be brought into execution. Construction is expected to start in 2021. Other houses will be connected later.

Partners: Stork Nederland BV, Nederlandse Gasunie NV, GasTerra BV, Nederlandse Aardolie Maatschappij N.V., Bakkert Combustion Technology BV, N-TSA BV (bedrijfsvaardigheden) RANDOL, Invalua Energie-Verlichting (P.V.), Cogas Innovatie & Opleiding B.V., Nettek B., JH EnergieSystemen B.V., Heuco University of Applied Sciences, Hydrate Opleiding, Stadsnet Heat Energy, Stroom & Stort, Invalua Opleiding B.V., Green Power Group B.V., 200-GE, Netbeheerders B.V., Arcadis Nederland B.V., D4M Infra Energie & Water B.V., Hoekwoning BV, D4M Nederland BV, Snelis Nederland B.V. en Lander N.V. en gemeente Hoogeveen.

Category:	deployment in built environment
Capacity:	530 houses
Process phase:	FID
Project period:	2020 - 2022
Project costs:	TSE 400 k
Contact:	Kees Boer, gem. Hoogeveen

Power-To-Gas (P2G) Phase II

Power to Hydrogen for Residential Heating of Apartments in Rozenburg
Decentralized integration of wind and solar energy via hydrogen from electrolysis for the heat supply of the built environment. The hydrogen is delivered by the regular natural gas pipelines to the boiler house of the apartment complex where the first hydrogen boilers are tested.

Partners: **STEDIN**, **Waternet**, **OV&M**, **DNV-GL**, **BEKAERT**, and **remeha**

Category:	deployment in built environment
Capacity:	500 residential houses
Process phase:	execution
Project period:	2018 - 2023
Project costs:	unknown
Contact:	albert.vandermolen@stedin.net

Hydrogen City

City on 't Haringvliet Switching to Green Hydrogen.
The hydrogen is to be used to heat the 600 houses in the village. The existing gas network can be used for the purpose, so no new network needs to be laid. The four "gas district stations" that still operate on natural gas are being converted and a different gas meter must be installed.

Partners: **Greenes-Overlaken**, **STEDIN**, and **kiwa**

Category:	deployment in built environment
Capacity:	600 residential houses
Process phase:	FEED-study
Project period:	2018 - 2030
Project costs:	unknown
Contact:	stadaardgasvrij@gmail.com

Hydrogen Neighbourhood

Pilot Heating with Hydrogen in Neighbourhood Berkeloord, Lochem
At Berkeloord there are relatively old, sometimes even monumental buildings. Residents are looking for sustainable alternatives for natural gas. Since cooking cannot be done with hydrogen, induction would be the most obvious option. In winter 2020/2021 the pilot will be carried out.

Partners: **LOCHEM ENERGIE**, **altlander**, and **remeha**

Category:	deployment in built environment
Capacity:	10 - 15 residential houses
Process phase:	FEED-study
Project period:	2020 - 2021
Project costs:	unknown
Contact:	info@lochemenergie.net



H2 Ready Central Heating Burner

Developing a H₂ Burner System as a Retrofit.

The goal is to develop a burner system that can replace the current natural gas burner. This means that future boilers for hydrogen can be produced. However, already installed boilers can also be converted with a retrofit.



3 pilot hydrogen central heaters

Category:	deployment in built environment
Capacity:	-
Process phase:	FEED-study
Project period:	2018 - 2020
Project costs:	TSE 250 k
Contact:	Ellart de Wit, Hygear

Partners:

ATAG
JOUW COMFORT ZONE

HYGEAR



Hydrogen Neighbourhood Hoogeveen

100 Newly Built Houses and 430 Existing Houses Connected to Hydrogen

The newly built Nijstad-Oost residential area has been designated as a demonstration project for the application of hydrogen in newly-built houses. The destination plan will soon be brought into execution. Construction is expected to start in 2021. Other houses will be connected later.



Category:	deployment in built environment
Capacity:	530 houses
Process phase:	FID
Project period:	2020 - 2022
Project costs:	TSE 400 k
Contact:	Kees Boer, gem. Hoogeveen

Partners:

Stork Nederland BV, Nederlandse Gasunie NV, GasTerra BV, Nederlandse Aardolie Maatschappij N.V., Bekaert Combustion Technology BV, N-TRA BV (onderdeel netwerkbedrijf RENDO), Instituut Fysieke Veiligheid (IFV), Cogas Innovatie & Ontwikkeling B.V, Nedstack B., JP-Energiesystemen B.V, Hanze University of Applied Sciences, Provincie Drenthe, Stichting New Energy, Visser & Smit Hanab Distributie B.V, Green Planet Pesse B.V, DNV-GL Netherlands B.V., Arcadis Nederland B.V, BAM Infra Energie & Water B.V, Haskoning BV, DHV Nederland B.V, Enexis Netbeheer B.V en Liander N.V en gemeente Hoogeveen.



Power-To-Gas (P2G) Phase II

Power to Hydrogen for Residential Heating of Apartments in Rozenburg

Decentralized integration of wind and solar energy via hydrogen from electrolysis for the heat supply of the built environment. The hydrogen is delivered by the regular natural gas pipelines to the boiler house of the apartment complex where the first hydrogen boilers are tested.



Category:	deployment in built environment
Capacity:	500 residential houses
Process phase:	execution
Project period:	2018 - 2023
Project costs:	unknown
Contact:	albert.vandermolen@stedin.net

Partners:



Hydrogen City



City on 't Haringvliet Switching to Green Hydrogen.

The hydrogen is to be used to heat the 600 houses in the village. The existing gas network can be used for the purpose, so no new network needs to be laid. The four "gas district stations" that still operate on natural gas are being converted and a different gas meter must be installed.



Category:	deployment in built environment
Capacity:	600 residential houses
Process phase:	FEED-study
Project period:	2018 - 2030
Project costs:	unknown
Contact:	stadaardgasvrij@gmail.com

Partners:



gemeente
Goeree-Overflakkee



Hydrogen Neighbourhood

Pilot Heating with Hydrogen in Neighbourhood Berkeloord, Lochem

At Berkeloord there are relatively old, sometimes even monumental buildings. Residents are looking for sustainable alternatives for natural gas. Since cooking cannot be done with hydrogen; induction would be the most obvious option. In winter 2020/2021 the pilot will be carried out.



Category:	deployment in built environment
Capacity:	10 - 15 residential houses
Process phase:	FEED-study
Project period:	2020 - 2021
Project costs:	unknown
Contact:	info@lochemenergie.net

Partners:



Knowledge

Overview

Hydrogen Coalition

A Sustainable Hydrogen Economy in 2030 in the Netherlands

At least 27 public and private organizations in the Netherlands are building on an infrastructure for green hydrogen. In a guide to the Dutch government, they formulated four concrete pillars for the rapid and effective development of the hydrogen economy in the Netherlands.

Category:	knowledge
Capacity:	-
Process phase:	execution
Project period:	2018 -
Project costs:	unknown
Contact:	Joris Thijssen, Greenpeace

Partners o.a.:

HydroHub

Building a Hydrohub Megawatt Test Centre in Groningen

Developing a test center for testing innovations in electrolysis systems (PEM and alkaline) of 250 kW as a steppingstone towards future gigawatt scale production of sustainable hydrogen by the process industry.

Category:	knowledge
Capacity:	250 kW
Process phase:	execution
Project period:	2018 - 2022
Project costs:	TNO subsidy
Contact:	carol.vlaes@tno.nl

Partners o.a.:

Ampère

Advanced Materials for PEM Electrolyzers

The goal is to establish a structural collaboration between the electrolyser knowledge parties. I.e. the manufacturers of electrolyzers and the knowledge institutes, as well as Dutch component suppliers. They aim to take a concrete step in the cost-efficiency of electrolyser technology.

Category:	knowledge
Capacity:	-
Process phase:	execution
Project period:	2017 - 2020
Project costs:	ISE 200 k
Contact:	info@tno.nl

Partners:

Alkaliboost

Developing Better Alkaline Electrolyser Stacks

The power of alkaline technology is that the electrochemical stacks are relatively cheap, because no expensive or noble metals are used. The committed parties are developing and testing new alkaline stack designs that make it possible to operate at a much higher current density.

Category:	production, knowledge
Capacity:	-
Process phase:	concept
Project period:	2016 - 2023
Project costs:	TSE 500 k
Contact:	Gerhard Remmen, Nouryon

Partners:

HYDROGREENN

HYDROgen Regional Energy Economy Network Northern NL

Promoting business development of hydrogen applications in or from the northern Netherlands. The hydrogen applications are used to contribute to the green innovation of energy management, mobility, industry and chemistry. There are now 80+ partners involved.

Category:	knowledge, networking
Capacity:	-
Process phase:	execution
Project period:	2019 -
Project costs:	unknown
Contact:	sp@ama@enonce-nrdnoord.nl

Partners o.a.:

HyDelta

Research on Obstacles on Hydrogen Deployment

HyDelta is a national cooperation program that removes barriers that delay or halt hydrogen projects. The project that are stalled struggle for example with gaining permits, infrastructural challenges and a lack of clarity about safety regulations.

Category:	knowledge, networking
Capacity:	-
Process phase:	execution
Project period:	2020 -
Project costs:	unknown
Contact:	www.hydelta.nl

Partners o.a.:

Hydrogen House Apeldoorn

Demonstration and Learning Model House for Training Employees

The aim is to initially train approximately fifteen technicians and teach them how to use hydrogen and water networks. They will soon have to be able to apply this in practice, first of all in project Lochem. The house is also intended for the installer of Remeha hydrogen boilers.

Category:	knowledge
Capacity:	1 house
Process phase:	execution
Project period:	2020 - 2021
Project costs:	unknown
Contact:	info@alllander.com

Partners:

Fieldlab

Experimenting with Small-scale Generation of Hydrogen on Farms

TNO and WUR are starting a hydrogen pilot project in the Fieldlab in Loystad. Here experiments are being conducted with small-scale generation of hydrogen on farms, using solar and wind energy produced at the same location.

Category:	knowledge
Capacity:	small-scale
Process phase:	execution
Project period:	2020 - 2026
Project costs:	unknown
Contact:	peter.ecoon@tno.nl

Partners:



Hydrogen Coalition

A Sustainable Hydrogen Economy in 2030 in the Netherlands

At least 27 public and private organizations in the Netherlands are building on an infrastructure for green hydrogen. In a guide to the Dutch government, they formulated four concrete pillars for the rapid and effective development of the hydrogen economy in the Netherlands.



Category:	knowledge
Capacity:	-
Process phase:	execution
Project period:	2018 -
Project costs:	unknown
Contact:	Joris Thijssen, Greenpeace

Partners o.a.:

GREENPEACE

de natuur en
milieufederaties

TU Delft

Tennet

OCI
NITROGEN

STEDIN
GROEP

ENEXIS
GROEP

YARA

innogy

NUON

gasunie

ENGIE

V N O
N C W

NATUUR
& MILIEU

AkzoNobel
SPECIALTY CHEMICALS

sp

TATA STEEL



HydroHub

Building a Hydrohub Megawatt Test Centre in Groningen

Developing a test center for testing innovations in electrolysis systems (PEM and alkaline) of 250 KW as a steppingstone towards future gigawatt scale production of sustainable hydrogen by the process industry.



Category:	knowledge
Capacity:	250 KW
Process phase:	execution
Project period:	2018 - 2022
Project costs:	TKI subsidy
Contact:	carol.xiao@ispt.eu

Partners o.a.:



Ampère

Advanced Materials for PEM Electrolyzers

The goal is to establish a structural collaboration between the electrolyser knowledge parties. I.e. the manufacturers of electrolysers and the knowledge institutes, as well as Dutch component suppliers. They aim to take a concrete step in the cost-efficiency of electrolyser technology.

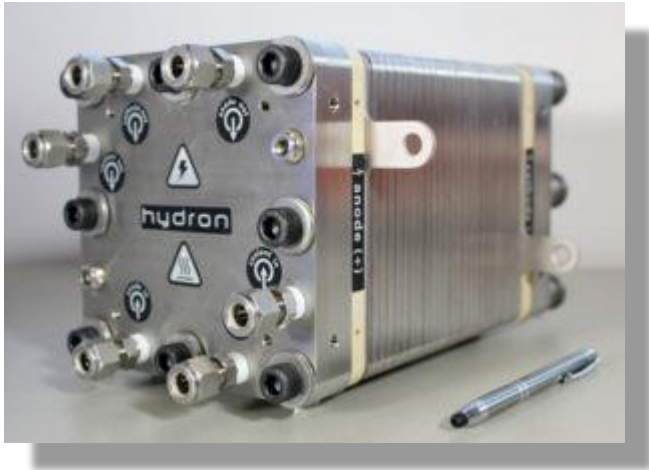

Category:	knowledge
Capacity:	-
Process phase:	execution
Project period:	2017 - 2020
Project costs:	FSE 250 k
Contact:	Info@tno.nl

Partners:



Alkaliboost

Developing Better Alkaline Electrolyser Stacks

The power of alkaline technology is that the electrochemical stacks are relatively cheap, because no expensive or noble metals are used. The committed parties are developing and testing new alkaline stack designs that make it possible to operate at a much higher current density.



Category:	production, knowledge
Capacity:	-
Process phase:	concept
Project period:	2018 - 2023
Project costs:	TSE 500 k
Contact:	Gerhard Remmers, Nouryon

Partners:

Nouryon

AkzoNobel

TU/e EINDHOVEN
UNIVERSITY OF
TECHNOLOGY



HYDROGREENN

HYDROGen Regional Energy Economy Network Northern NL

Promoting business development of hydrogen applications in or from the northern Netherlands. The hydrogen applications are used to contribute to the green innovation of energy management, mobility, industry and chemistry. There are now 80+ partners involved.



Category:	knowledge, networking
Capacity:	-
Process phase:	execution
Project period:	2019 -
Project costs:	unknown
Contact:	spijksma@vnoncw-mkbnoord.nl

Partners o.a.: AkzoNobel, Arcadis, Holthausen, Gasunie, ChemPort, New Energy Coalition, Nuon, Shell, Gasterra, Entrance, TNO, Stork, Provincie Groningen, SBE, Rosato, Siemens en Ministerie van Infrastructuur en Milieu



HyDelta

Research on Obstacles on Hydrogen Deployment

HyDelta is a national cooperation program that removes barriers that delay or halt hydrogen projects. The project that are stranded struggle for example with gaining permits, infrastructural challenges and a lack of clarity about safety regulations.



Category:	knowledge, networking
Capacity:	-
Process phase:	execution
Project period:	2020 -
Project costs:	unknown
Contact:	www.hydelta.nl

Partners o.a.:



Hydrogen House Apeldoorn

Demonstration and Learning Model House for Training Employees

The aim is to initially train approximately fifteen technicians and teach them how to use hydrogen and water networks. They will soon have to be able to apply this in practice, first of all in project Lochem. The house is also intended for the installer of Remeha hydrogen boilers.

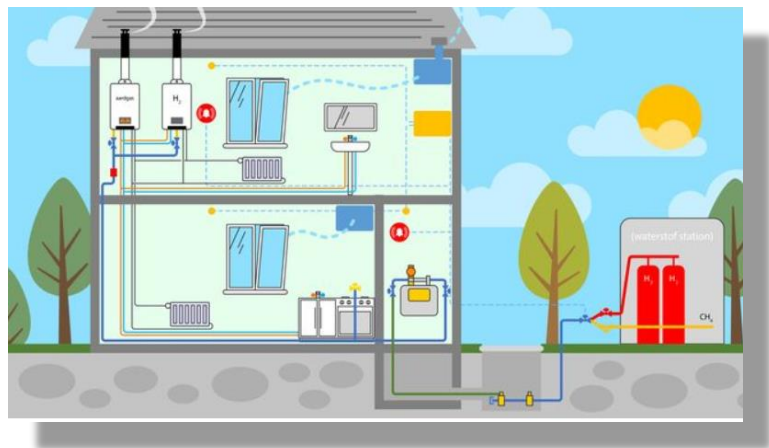

Category:	knowledge
Capacity:	1 house
Process phase:	execution
Project period:	2020 - 2021
Project costs:	unknown
Contact:	info@alliander.com

Partners:



Fieldlab

Experimenting with Small-scale Generation of Hydrogen on Farms

TNO and WUR are starting a hydrogen pilot project in the Fieldlab in Lelystad. Here experiments are being conducted with small-scale generation of hydrogen on farms, using solar and wind energy produced at the same location.



Category:	knowledge
Capacity:	small-scale
Process phase:	execution
Project period:	2020 - 2025
Project costs:	unknown
Contact:	peter.eecen@tno.nl

Partners:

