

# Overview of Spectrum sensing technologies for Satellite and Space Communications based on Cognitive Radio Networks

M.Mourad Mabrook

*Faculty of Navigation Science and Space Technology, Beni-Suef University,  
Beni-Suef, Egypt*

*Email: [mohamed.mourad@nsst.bsu.edu.eg](mailto:mohamed.mourad@nsst.bsu.edu.eg), [mohamedmourad2008@gmail.com](mailto:mohamedmourad2008@gmail.com)*

Received 27 March 2016, Revised 29 May 2016, Accepted 11 July 2016

---

The limited available spectrum of satellite and space communications result in new techniques to reuse the free spectrum. Cognitive Radio (CR) is one of the most promising techniques for such reusing processes. Spectrum sensing (SS) is the core process of cognitive radio which is used to sense the available temporary free bands, holes, of the sensed spectrum.

Many technologies are proposed to achieve both narrow-band and wide-band spectrum sensing. Three paradigms of spectrum sensing applications such as the interweaving approach, the underlay approach and the overlay approach are explained. Many scenarios are proposed to utilize cognitive radio architecture at both standalone and cooperative approaches in satellite communications .

The proposed scenario is based on cooperative Sub-Nyquist wideband sensing basis. Nano-computing process is highly required to achieve real-time communication for spectrum sensing in cognitive radio due to the intensive required computations. The Simulation of the proposed scenario showed that it efficiently saves frequency resources, overcomes spectrum underutilization problem, noise and interference problems with an accurate reconstruction.

---

## **Keywords:**

*PACS: Cognitive Radio; Spectrum Sensing; Space Communication; Wideband Sensing; Compressive sensing; Sub-Nyquist Sampling; cooperative satellite communication*

## **1. INTRODUCTION**

The unused spectrum represents a one of the most important non-renewable resources required for wireless and satellite communications. The demand for the wireless

services is increasing continuously due to rapid increase of wireless subscribers and huge demand of multimedia applications. However, due to current static spectrum policy, the available usable spectrum becomes scarce while a significant amount of spectrum remains underutilized [1]. Therefore, cognitive radio which is also defined as Dynamic Spectrum Access Networks (DSANs) or NeXt Generation networks (xG) can be considered as a promising technology to enhance spectrum usage efficiency by allowing the coexistence of heterogeneous networks within the same spectrum by means of sensing and sharing spectrum processes.

To establish the cognitive radio network, the functions of cognitive cycle which is presented in Figure (1) should be integrated. These processes are summarized as follows:

**Spectrum sensing:** is an active spectrum awareness process during which, cognitive radio monitors its radio surroundings, determines the statistics of spectrum utilization among other Primary Users (PUs) and Secondary Users (SUs) then, it detects the possible unused space or free channels. Spectrum sensing process can be executed using a single CR device itself or by exchanging information between multiple CR terminals in a cooperative way to improve sensing accuracy.[2]

**Spectrum management:** cognitive radio subscriber has to select the starting time of sensing operations, operating frequencies and their corresponding major parameters based on spectrum sensing information .

**Spectrum sharing:** Since there are many secondary users seeking to access the available free spectrum, CR process has to achieve a balance between efficiently transferring its self-information and sharing the common resources with other CR and non-CR subscribers. This can be achieved using some policy rules that determine cognitive radio behavior in radio environment.

**Spectrum mobility:** If the primary user starts to initiate communication links at a specific band, cognitive radio utilizing this band has to stop its operation or to free the currently used radio channel and change its operating radio frequency to avoid the harmful interference to primary licensed users in a real time. Therefore, cognitive radio process has to continuously investigate possible alternative spectrum holes.

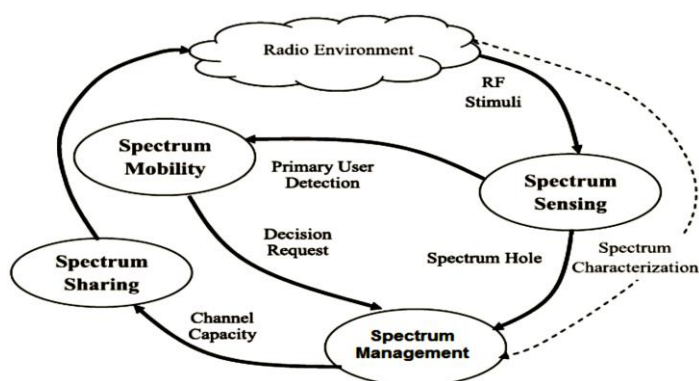

**Figure (1)** Cognitive Cycle in Cognitive Radio System

There are three main paradigms dedicated for cognitive radio spectrum sensing process. In “interweaving” approach, the secondary, unlicensed, users are able to occupy available holes by the primary, licensed, users. In the “underlay” approach, the secondary transmitters are permitted to overlap the active frequency bands with the primary users causing an interference level below a given permitted threshold. Whereas, the “overlay” approach uses the secondary user’s knowledge of the primary users’ transmission and channel scheme to select the suitable

transmission scheme that causes an acceptable level of interference. This paper focuses on interweave paradigm which mainly depends on detecting the free bands, holes, in the spectrum and reuse it with secondary users to overcome underutilization problem .

Shadowing, fading, interference and aliasing of signals are badly affecting the performance and accuracy of spectrum sensing process. Therefore, cooperative sensing techniques are effectively used to relieve the effects of these problems. In cooperative sensing, sharing information among cognitive radios and combining results from various measurements are challenging tasks. The shared information results in soft or hard decisions are based on each cognitive device.[3]

Satellite communication is mainly using artificial satellites to create communication links between different points on the Earth. It plays an important role in the global telecommunication system. Approximately 2,000 artificial satellites orbiting the Earth including analog and digital signals carrying data, audio and video between many different locations on the Earth [5]. Satellite communication consists of two main parts; the ground segment; that based on fixed or mobile transmission or reception and the space segment; which basically is the satellite itself. The satellite communication link includes transmitting the signal from the ground station to the satellite that receives, amplifies the received signal “ up-linking process” then satellite retransmits the signal back to fixed or mobile ground stations, “downlinking process[5] .

Many researches are developed to enhance both Fixed Satellite Services (FSS) and Mobile Satellite Services (MSS) which have been utilized to provide communication services to both fixed and mobile users at many fields such mobile networks, aerospace, transports, military sectors and emergency cases where terrestrial networks can't be deployed [6]

## **2. Sub-Nyquist Wideband Spectrum Sensing**

Many algorithms and techniques are proposed and developed to sense the wideband spectrum such as wavelet detection, multi-band joint detection algorithm, filter-bank detection and sweep-tune detection [11], [12]. The major disadvantage of these methods is the requirement of Nyquist sampling rate that results in implementing Analog to Digital Converters (ADCs) with higher sampling rates, higher consumption of energy and more design complexity. Therefore, many algorithms are proposed based on sub-Nyquist sampling rates.

According to the current progress in Compressed Sampling or Compressed Sensing (CS) theories and sub-Nyquist sampling for sparse signal which don't occupy the whole spectrum, the number of calculations and measurements are reduced by using the non-uniform sampling techniques with lower sampling rates than Nyquist rate while maintaining high recovery accuracy [13], [14]. Analog to Information Converter (AIC) based compressive sensing technique is presented in Figure (2-a). From another hand, multi-channel techniques based compressive sensing are developed such as:

a) Modulated Wideband Converter (MWC): the block diagram of this model is presented in Figure (2-b). One of the most significant advantage of introducing parallel channel structure in this technique is to provide robustness against the noise and model mismatches. In addition, the dimension of the measurement matrix is reduced, making the spectral reconstruction more computationally efficient.

b) Multi-Coset Sampling (MCS): which is equivalent to choose some samples from a uniform grid. The major advantage of this approach is that; the sampling rate of each channel is (m) times lower than the Nyquist rate [ $f' = \frac{f_s}{m}$ ]. Moreover, the number of measurements is only v/m'th of that in the Nyquist sampling case where, v is the number of branches as presented in Figure (2-c).

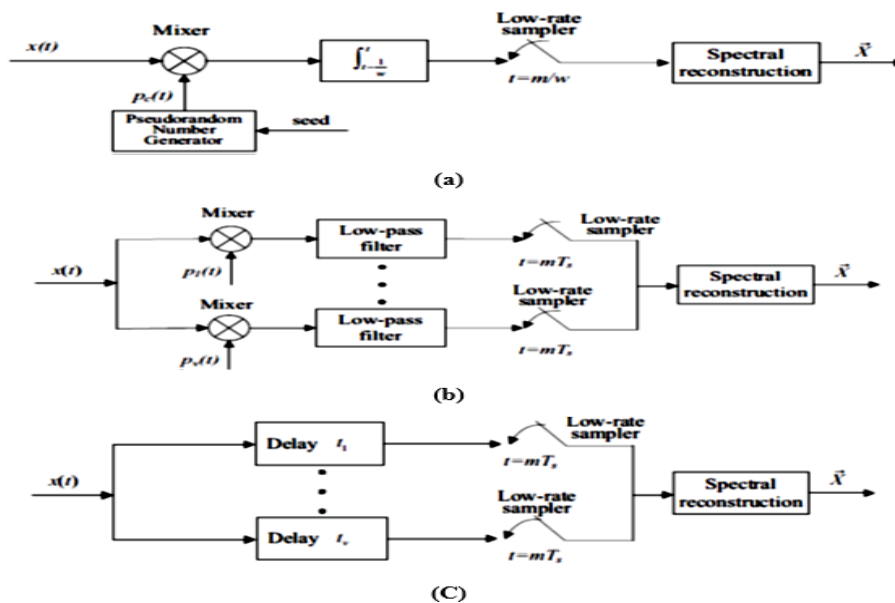

**Figure.2** Block diagrams of sub-Nyquist wideband sensing algorithms: (a) Analog-to-information converter-based wideband sensing, (b) Modulated wideband converter-based wideband sensing, (c) Multi-coset sampling-based wideband sensing [15].

In this paper, a blind adaptive Multi -Coset Sampling technique which is presented in [16] is used as a sub-Nyquist wideband spectrum sensing technique. The proposed method can sense the totally blind input channels and the average sub-Nyquist frequency is less than other approaches with high reconstruction accuracy which results in low system complexity and less power consumption. The proposed system is sensitive and adaptive for any changes in the number of active channels of the input signal [16].

### 3-Cognitive Satellite Communications

Satellite communications has an essential role in the field of wireless communication as it covers a wide area of the earth, transmits in a higher speed and able to provide new services than those of terrestrial networks [1]. Moreover, satellite technology has made it economically available to cover sparsely populated remote regions by broadband communications which improves the access to medical services, e-government, education and other related services that are expensively provided by other technologies. Many effective communication applications such as land mobile, maritime, aeronautical, transports, military, rescue and disaster relief are mainly based on satellite communications [1]. Furthermore, satellite communication plays major roles in developing hybrid satellite/wired or satellite/wireless infrastructures. Hybrid networks may exist at various styles in the same spectrum as, terrestrial-terrestrial networks, satellite -satellite networks or satellite-terrestrial networks [1].

The available unused spectrum related to satellite communications including application types are presented in Table I. Frequency for MSS is assigned at the World Radio communication Conferences (WRC) periodically organized by the International Telecommunication Union-

Radio communication (ITU-R) sector. Fixed services use high C and K frequency band whereas, mobile services are better suited for L and S frequency band allocated at the World Administrative Radio Conference (WARC) [7].

The limitation of the resources of L/S band besides the growing demand for wide-band services result in pushing toward the utilization of Ku/Ka band for MSS. ITU-R has assigned portions of Ka band to MSS and FSS on a primary basis in all regions. However, it is clear now that almost all the operational MSS prefer L/S band of frequency resource to essentially support mobile subscribers [9].

Depending on the last documentation in [9], the allocation of L/S band for using in mobile satellite services assigned by ITU Radio Regulation (ITU-RR) that listed in Table 2 [9].

Table (1) Assigned satellite communications frequency bands

Band	Frequency Range / GHz	Total Bandwidth	General Application
L	1-2	1	Mobile Satellite Services (MSS)
S	2-4	2	MSS, NASA, Deep Space Search
C	4-8	4	Fixed Satellite Service (FSS)
X	8-12.5	4.5	Military FSS, Terrestrial Earth Exploration, Meteorological Satellite
Ku	12.5-18	5.5	FSS, Broadcast Satellite Service (BSS)
K	18-26.5	8.5	BSS, FSS
Ka	26.5-40	13.5	FSS

In Cognitive Radio Networks (CRNs), Secondary Users (SUs) need to sense the wideband spectrum simultaneously and accurately to utilize the free channels in addition to avoid harmful interference with PUs. Recently, wideband sensing is an operative solution due to the ability of simultaneously sensing the occupancy of active signals in the sensed spectrum over [10].

However, in wireless networks including satellite networks, the current available technology of analog to digital converters face tremendous challenges appeared by a conventional way of spectral estimation technique that operates with higher sampling rate than Nyquist rate. In addition, time-varying sensing techniques only assembles a small number of measurements for detection which results in low-resolution of the signal reconstruction reliably [9].

Table (2) Characteristics of L/S Band allocation for MSS by ITU-R [9]

L/S band	Uplink frequency (MHz)	Downlink frequency (MHz)	Bandwidth (MHz)	Area compartmentalized	Operational systems
L band	1610.0-1626.5	2483.5-2500.0	16.5	Global	Iridium, Globalstar
	1626.5-1660.5	1525.0-1559.0	34.0	Global	Inmarsat, MSAT, SkyTerra, ACeS, Thuraya
	1668.0-1675.0	1518.0-1525.0	7.0	Global	AlphaSat I-XL
S band	1980-2010	2170-2200	30	Global	TerreStar, ICO
	2670-2690	2500-2520	20	Region III	Insat, N-STAR
	2655-2670	2520-2535	15	Region III	N-STAR

### 3.1 Scenarios of Hybrid Cognitive Satellite-Terrestrial Communications

The International Telecommunication Union (ITU) defines a “hybrid satellite terrestrial system” as the one that employs satellite and terrestrial components that are interconnected, but operate independently of each other [17]. There are many scenarios that connects the satellite and terrestrial networks in a cognitive manner which can be presented as the hybrid satellite-terrestrial network. These hybrid networks can work with different modes of operations [1] such as: forward normal mode (primary and secondary users operating in forward mode), ii) return normal mode (PUs and SUs operating in return mode), iii) forward reverse mode (PUs operating in forward mode whereas, SU in return mode), or iv) return reverse mode (Pus work in return mode whereas, SUs are in forward mode) as illustrated in Figure 3.

The hybrid scenario consists of a multi-user or single-user link existence as shown in Figure (4a), (4-b) respectively. In the multiuser link coexistence scenario, S band (1980: 2010 MHz downlink, 2170: 2200MHz uplink) /C band (3.4: 3.8 GHz downlink, 5.85: 6.725 GHz uplink) multiband satellite systems can coexist with terrestrial cellular systems such as WiMax, 3GPP and LTE using suitable CR techniques. These techniques allow the reuse of the terrestrial licensed primary spectrum in the secondary cognitive satellite systems or vice versa without interfering the operation of the licensed primary systems.

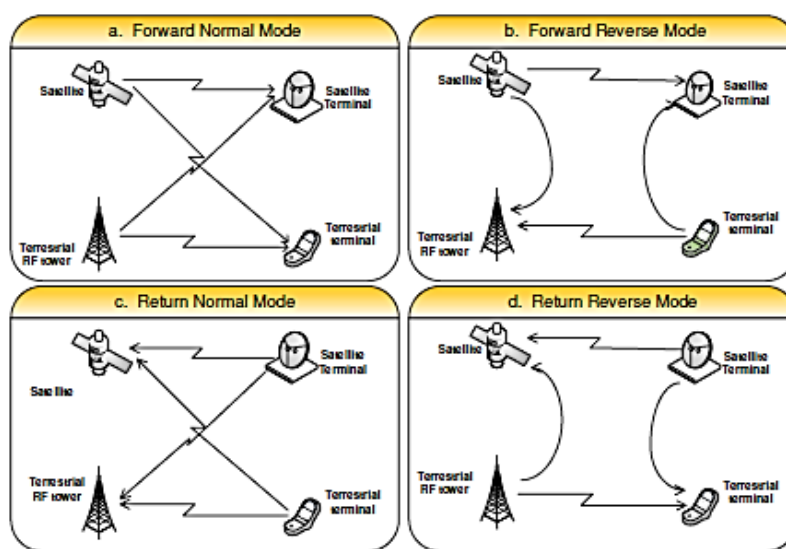

**Figure. 3** Different modes of operation for Hybrid Satellite-Terrestrial Communications [1]

### 4-Cooperative Cognitive satellite Communication

Due to the appearance of the problem of signal uncertainty, multipath fading and shadowing that affect the accuracy of the process of spectrum sensing, cooperative techniques are developed to overcome such drawbacks. In cooperative sensing, cognitive radio users are able to share their sensing parameters to make the final decision of detecting and utilizing the free channels in wideband spectrum [18].

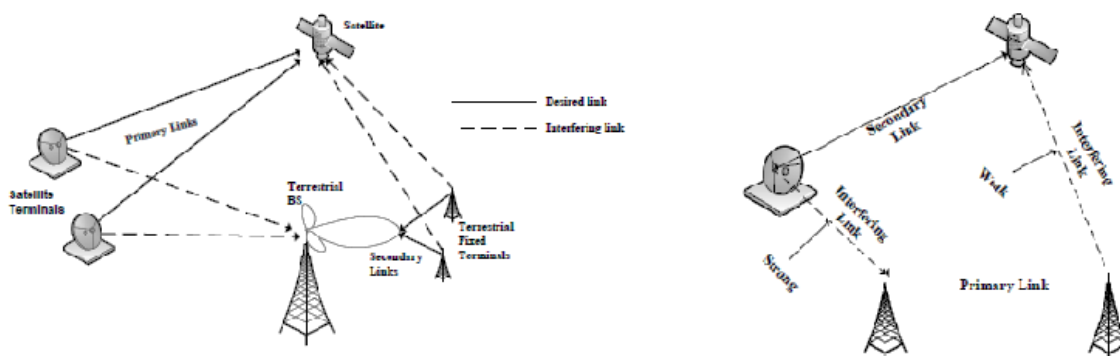

Figure.4 Hybrid satellite cognitive scenario for a) Multi-user coexistence, b) Single user coexistence [1]

In [9], a new proposed approach of wideband compressive spectrum sensing based on Discrete Sine Transform (DST) for frequency availability in Low Earth Orbiting (LEO) mobile satellite systems. This proposed scenario considers the cognitive network composed of space segment LEO satellites as a secondary system and terrestrial segment as primary users. This method is based on three steps to detect the unused frequency, first in which individual LEO satellite implements compressed sensing to make local decision on the state of PU via cognitive satellite link based on energy detection, second in which LEO choose vacant frequency to communicate with terminals according to sensing decision and third in which selection process to activate cooperative sensing process via Inter Satellite Link (ISL) in the areas of overlapped coverage. The architecture of that system is shown in Figure (5).

From another hand, Cognitive Radio for Satellite Communications (CoRaSat) project which is proposed in [19], Focusing on the preliminary identification of the scenarios that are suitable to be applied over Satellite Communications (SatCom) [19] based on Cognitive Radio technology. The CoRaSat model aims to maximize resource utilization to create new business approaches and decrease transmission costs. Many challenges are outlined by CoRaSat project associated to market, standardization, regulatory and technical challenges. Unfortunately, cooperative between secondary satellites aren't executed at CoRaSat project. Therefore, some drawbacks related to multipath fading and shadowing aren't completely eliminated.

### 5- The Proposed Cooperative CR-Satellite Communication System

In this paper, a proposed system based on cooperative wideband Spectrum Sensing over adaptive blind non-uniform sub-nyquist sampling technique as presented in [18] is introduced. This technique based on cooperative manner as shown in Figure (6), where one of the satellites is considered as primary element and the other two satellites are using the proposed technique to work on cognitive basis. The cognitive satellites SU1, SU2 sense the free channels at the wideband of the PU satellite. Then, using inter satellite links between SU1, SU2 to share their results and take the final decision based on the majority rule [18]. Finally, cognitive link is initiated between the SUs and Puss or MSS users without interfering the primary links.

Many rules such as AND, OR and Majority methods are used for combining information from different SUs [4]. In AND-rule, all sensing results should be  $(H_1)$  for deciding  $H_1$ , where  $H_1$  is the alternate hypothesis that a primary user occupies the observed band. In OR-rule, a secondary user decides  $(H_1)$  if any of the received decisions plus its own are  $H_1$ . Majority rule outputs  $(H_1)$  when the number of  $(H_1)$  decisions are equal to or greater than another  $(H_0)$ . In

this paper Majority rules are used in the proposed model to achieve the better performance as proved in [4].

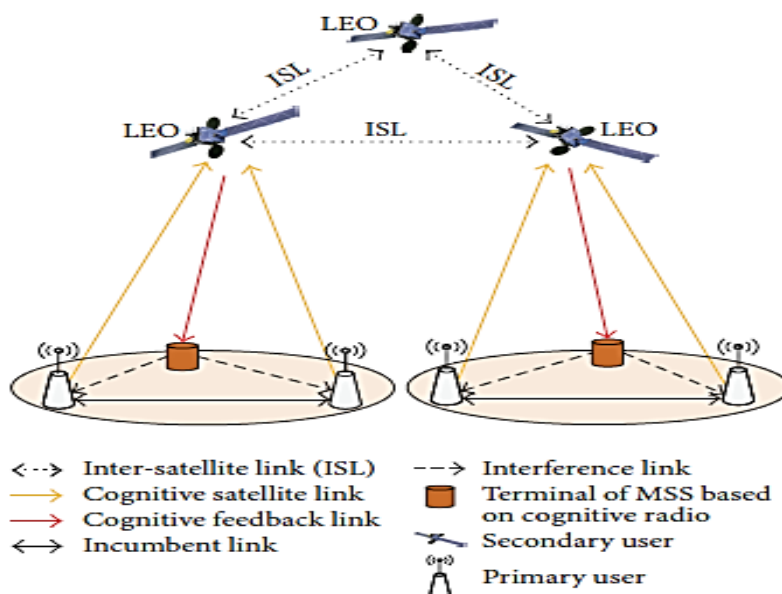

Figure. 5 System architecture of implementation of compressed sensing for LEO-based MSS [9].

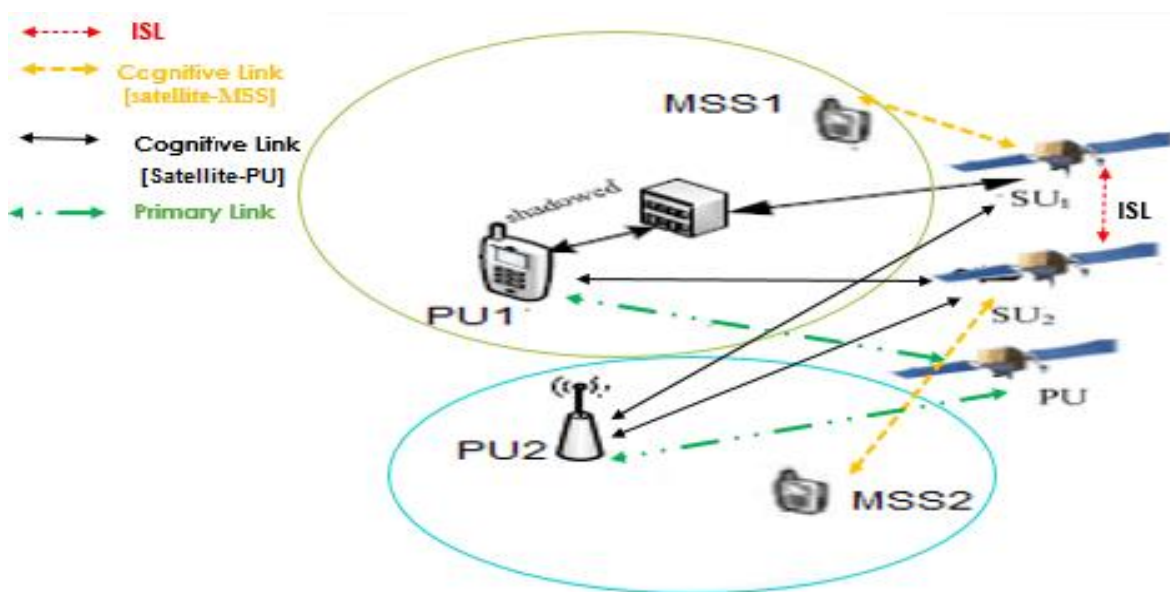

Figure.6 Proposed CR-Cooperative Satellite Communication System

### 6-Simulation Results

For a given wideband input signal within frequency range [0:2000] MHz, by dividing this wideband into channels where, ( $L=80$ ) segments with maximum channel bandwidth ( $B_w = 25\text{MHz}$ ). Then, by using proposed technique with number of branches ( $p= 20$ ) containing 6



active channels as presented in Figure (7) that shows the input and reconstructed signals in both time and frequency domains.

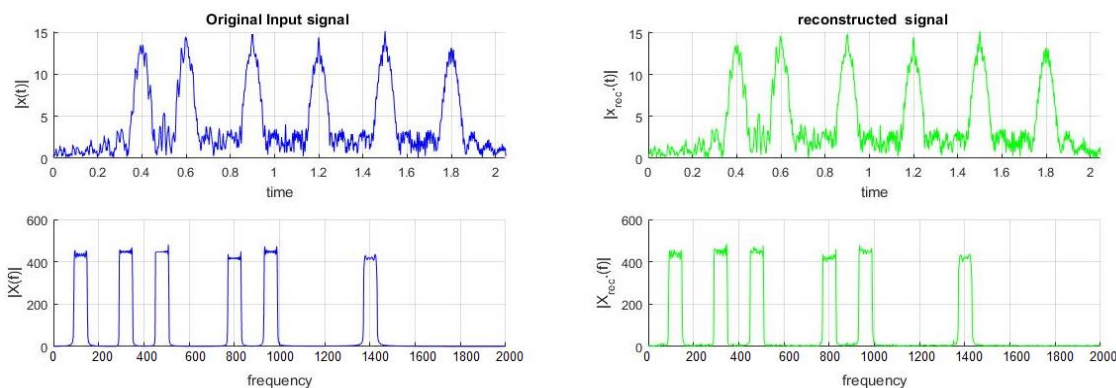

Figure.7 Input ( $X(t)$ ) and reconstructed ( $X_{rec}(t)$ ) sparse wideband signal a) in time domain b) in frequency domain

Assuming three cognitive satellites as secondary users working on the same frequency bands with primary satellite (PU) and Terrestrial primary network, each SU satellite has its own results based on individual Adaptive Multi-Coset Sampling (CWS\_AMCS) technique. Assuming SU1 is the ideal case and SU2,3 exposed to different values of Additive White Gaussian Noise (AWGN). The result obtained by using the cooperative approach using majority rule is shown in Table (3) which is identical to the ideal case. Therefore, SU2, 3 will have the optimum sensing results regardless of the AWGN and interferences.

Table (3).Active channels for 3 Secondary Satellites based CRN.

Channel No.	1	2	3	4	5	6	7	8	9	10	11	12	13	14	15	16	17	18	19	20
SU1	■	■		■	■			■			■		■		■	■				
SU2	■		■		■			■			■				■				■	
SU3	■	■		■	■						■		■		■	■				
Cooperative	■	■		■	■			■			■		■		■	■				

### 7. Conclusions

In this paper, an overview of cognitive radio technology, wideband spectrum sensing techniques is introduced. Different types of sub-Nyquist samplers are discussed including blind adaptive Multi-Coset Sampling technique. The usage of cognitive radio technologies in satellite Communication is presented. Many scenarios related to cooperative cognitive satellite communication techniques are studied. Cooperative Wideband Sensing based on Adaptive Multi-Coset Sampling (CWS\_AMCS) technique is used in the proposed scenario with majority decision rule in cooperative approach. The proposed scenario is efficiently saving frequency resources, solving spectrum underutilization problem and overcoming the most of fading and interference problems.

### References

[1] S. K. Sharma, S. Chatzinotas, and B. Ottersten, *Satellite cognitive communications and spectrum regulation, in International Regulations of Space Communications, Current Issues*, M. Hofmann, Ed. Larcier, 2013, ch. 11, pp. 2014.

- [2] Željko Tabaković, *A Survey of Cognitive Radio Systems*, Post and Electronic Communications Agency, Jurišićeva, vol. 13, 2010.
- [3] E. Visotsky, S. Kuffner, and R. Peterson, *On collaborative detection of TV transmissions in support of dynamic spectrum sharing*, in Proc. IEEE Int. Symposium on New Frontiers in Dynamic Spectrum Access Networks, Baltimore, Maryland, USA, pp. 338–345, Nov. 2005.
- [4] E. Peh and Y.-C. Liang, *Optimization for cooperative sensing in cognitive radio networks*, in Proc. IEEE Wireless Comm. and Networking Conf., Hong Kong, pp. 27–32, March 2007.
- [5] <https://www.britannica.com/technology/satellite-communication> (14/10/2017)
- [6] F. Alagöz and G. Gür, *Energy efficiency and satellite networking: a holistic overview*, Proceedings of the IEEE, vol. 99, no. 11, pp. 1954–1979, 2011.
- [7] J. Albuquerque, *Key note speech-what is going on in commercial satellite communications*, in Proceedings of the Keynote of the International Workshop on Satellite and Space Communications (IWSSC '07), Salzburg, Austria, Sept.2007.
- [8] A. Arcidiacono, D. Finocchiaro, and S. Grazzini, *Broadband mobile satellite services: the Ku-band revolution*, in Proceedings of the Tyrrhenian International Workshop on Digital Communications (TIWDC '06), Island of Ponza, Italy, September 2006.
- [9] Feilong Li, Guangxia Li, et al., *A Novel Approach to Wideband Spectrum Compressive Sensing Based on DST for Frequency Availability in LEO Mobile Satellite Systems*, Mathematical Problems in Engineering, Hindawi Publishing Corporation, Article ID 8397201, 2016.
- [10] S. Haykin, *Cognitive radio: brain-empowered wireless communications*, IEEE Journal on Selected Areas in Communications, vol. 23, no. 2, pp. 201–220, 2005.
- [11] M. Mourad Mabrook, Aziza I. Hussein, *Major spectrum sensing techniques for cognitive radio networks: A survey*, IJEIT, Volume 5, Issue 3, September 2015.
- [12] H. Sun, A. Nallanathan, C. X. Wang, and Y. Chen, *Wideband spectrum sensing for cognitive radio networks: a survey*, IEEE Wireless Communications, vol. 20, no. 2, pp. 74–81, 2013.
- [13] D. L. Donoho, *Compressed sensing*, IEEE Transactions on Information Theory, vol. 52, no. 4, pp. 1289–1306, 2006.
- [14] J.-A. Bazerque and G. B. Giannakis, *Distributed spectrum sensing for cognitive radio networks by exploiting sparsity*, IEEE Transactions on Signal Processing, vol. 58, no. 3, pp. 1847–1862, 2010.
- [15] H. Sun, A. Nallanathan, C. X. Wang, and Y. Chen, *Wideband spectrum sensing for cognitive radio networks: a survey*, IEEE Wireless Communications, vol. 20, no. 2, pp. 74–81, 2013..
- [16] M. Mourad Mabrook, Ghazal A. Fahmy, Aziza I. Hussein, M. A.abdelghany, *Adaptive blind wideband spectrum sensing for cognitive radio based on Sub-Nyquist sampling*

*Technique*, 28'th international conference in Microelectronics ICM Conference, Cairo, Egypt, December 17-20, 2016.

- [17] K. Sooyoung, K. Heewook, A. Do Seob.: *A Cooperative Transmit Diversity Scheme for Mobile Satellite Broadcasting Systems*, Advanced Satellite Mobile Systems, ASMS, pp.72-75, Aug. 2008.
- [18] M. Mourad Mabrook, Ghazal A. Fahmy, Aziza I. Hussein, M. A.abdelghany, *Novel Adaptive non-uniform Sub-Nyquist Sampling Technique for Cooperative Wideband Spectrum Sensing*, 12th IEEE International Computer Engineering Conference (ICENCO), Dec. 28-29, 2016.
- [19] Konstantinos LIOLIS, et al, *Cognitive Radio Scenarios for Satellite Communications: The CoRaSat Approach*, Future Network & Mobile Summit Conference Proceedings, 2013.

