

SAMSUNG

SAMSUNG **PLASMA DISPLAY**

Owner's Instructions

HP-S4253

HP-S5053

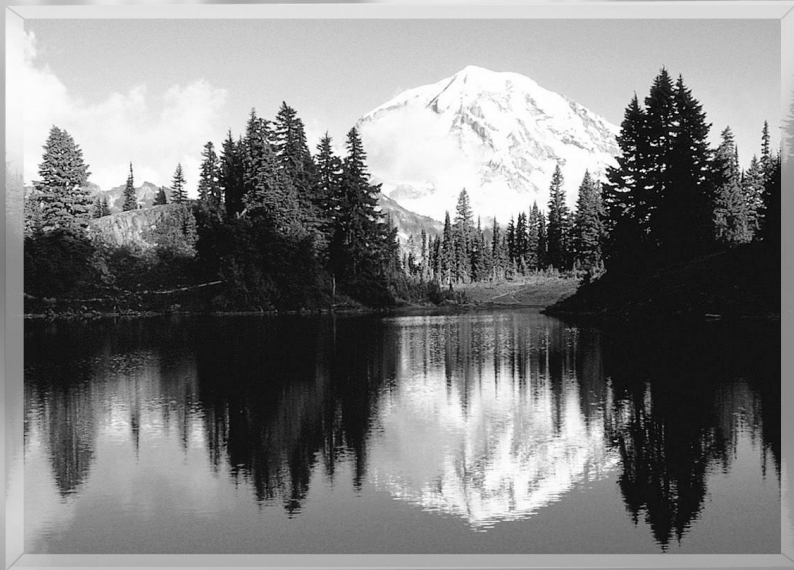

This device is a Class B digital apparatus.

Register your product at www.samsung.com/global/register

Important Warranty Information Regarding Television Format Viewing

Wide screen format PDP Displays (16:9, the aspect ratio of the screen width to height) are primarily designed to view wide screen format full-motion video. The images displayed on them should primarily be in the wide screen 16:9 ratio format, or expanded to fill the screen if your model offers this feature and the images are constantly moving. Displaying stationary graphics and images on screen, such as the dark side-bars on nonexpanded standard format television video and programming, should be limited to no more than 5% of the total television viewing per week.

Additionally, viewing other stationary images and text such as stock market reports, video game displays, station logos, web sites or computer graphics and patterns, should be limited as described above for all televisions. **Displaying stationary images that exceed the above guidelines can cause uneven aging of PDP Displays that leave subtle, but permanent burned-in ghost images in the PDP picture. To avoid this, vary the programming and images, and primarily display full screen moving images, not stationary patterns or dark bars.**

On PDP models that offer picture sizing features, use these controls to view different formats as a full screen picture.

Be careful in the selection and duration of television formats used for viewing. Uneven PDP aging as a result of format selection and use, as well as burned-in images, are not covered by your Samsung limited warranty.

U.S.A Only

The product unit accompanying this user manual is licensed under certain intellectual property rights of certain third parties. In particular, this product is licensed under the following US patents: 5,991,715, 5,740,317, 4,972,484, 5,214,678, 5,323,396, 5,539,829, 5,606,618, 5,530,655, 5,777,992, 6,289,308, 5,610,985, 5,481,643, 5,544,247, 5,960,037, 6,023,490, 5,878,080, and under US Published Patent Application No. 2001-44713-A1.

This license is limited to private non-commercial use by end-user consumers for licensed contents. No rights are granted for commercial use. The license does not cover any product unit other than this product unit and the license does not extend to any unlicensed product unit or process conforming to ISO/IEC 11172-3 or ISO/IEC 13818-3 used or sold in combination with this product unit. The license only covers the use of this product unit to encode and/or decode audio files conforming to the ISO/IEC 11172-3 or ISO/IEC 13818-3. No rights are granted under this license for product features or functions that do not conform to the ISO/IEC 11172-3 or ISO/IEC 13818-3.

Other countries

The product unit accompanying this user manual is licensed under certain intellectual property rights of certain third parties. This license is limited to private non-commercial use by end-user consumers for licensed contents. No rights are granted for commercial use. The license does not cover any product unit other than this product unit and the license does not extend to any unlicensed product unit or process conforming to ISO/IEC 11172-3 or ISO/IEC 13818-3 used or sold in combination with this product unit. The license only covers the use of this product unit to encode and/or decode audio files conforming to the ISO/IEC 11172-3 or ISO/IEC 13818-3. No rights are granted under this license for product features or functions that do not conform to the ISO/IEC 11172-3 or ISO/IEC 13818-3.

User Instructions

● **Screen Image retention**

Do not display a still image (such as on a video game) on the plasma display panel for more than several minutes as it can cause screen image retention. This image retention is also known as "screen burn". To avoid such image retention, refer to page 53 of this manual to reduce the degree of brightness and contrast of the screen when displaying a still image.

● **Altitude**

The PDP can only operate normally at heights under 6500ft.

● **Heat on the top of the PDP TV**

The top side of the product may be hot after long periods of use as heat dissipates from the panel through the vent hole in the upper part of the product.

This is normal and does not indicate any defect or operation failure of the product.

However, children should be prevented from touching the upper part of the product.

● **The product is making a 'cracking' noise.**

A 'cracking' noise may occur when the product contracts or expands due to a change of surrounding environment such as temperature or humidity. This is normal and not a defect of the unit.

● **Cell Defects**

The PDP uses a panel consisting of 1,230,000(SD-level) to 3,150,000(HD-level) pixels which require sophisticated technology to produce. However, there may be a few bright or dark pixels on the screen. These pixels will have no impact on the performance of the product.

● **Avoid operating the TV at temperatures below 5°C (41°F)**

● **A still image displayed too long may cause permanent damage to the PDP Panel.**



Watching the PDP TV in 4:3 format for a long period of time may leave traces of borders displayed on the left, right and center of the screen caused by the difference of light emission on the screen.

Playing a DVD or a game console may cause similar effect to the screen.

Damages caused by the above effect are not covered by the Warranty.

● **Afterimage on the Screen.**

Displaying still images from Video games and PC for longer than a certain period of time may produce partial after-images.

To prevent this effect, reduce the 'brightness' and 'contrast' when displaying still images for a long time.

● **Warranty**

Warranty does not cover any damage caused by image retention.

Burn-in is not covered by the warranty.

Table of Contents

General Information

Your New Plasma Display Panel.....	8
Remote Control Buttons	11
Wall Installation Instructions	13
How to assemble the Stand-Base	17

Connections

Connecting VHF and UHF Antennas	20
Connecting Cable TV	21
Connecting a VCR	23
Connecting a Camcorder	24
Connecting a DVD Player (480i, 480p)	25
Connecting a DTV Receiver (480p, 720p, 1080i)	26
Connecting to HDMI (High Definition Multimedia Interface) (480p, 720p, 1080i) ..	27
Connecting a Digital TV Set-Top Box (480p, 720p, 1080i)	28
Connecting a Digital Audio System	29
Connecting to an Analog Amplifier	30

Operation

Turning the TV On and Off	32
Viewing the Menus and Displays	36
Memorizing the Channels	37
Setting Up Your Remote Control	41
Viewing an External Signal Source.....	48

Picture Control

Changing the Picture Standard	52
Customizing the Picture Settings	53
DNle (Digital Natural Image engine)	55
Changing the Screen Size.....	56
Viewing the Picture-in-Picture.....	58
Selecting the Sound Source	64

Sound Control

Customizing the Sound	66
Using Automatic Sound Settings	67
Setting the TruSurround XT.....	68
Choosing a Multi-Channel Sound (MTS) track - Digital	69
Choosing a Multi-Channel Sound (MTS) track - Analog	70
Using the Auto Volume	71
Setting the On/Off Melody	72
Selecting the Internal Mute	73
Sound Reset.....	74

Channel Control

Selecting the Antenna	76
Selecting Your Favorite Channels	77
Viewing the Channel Lists	79
Editing the Channel Lists	80
Default List mode	82
Labeling the Channels.....	83
Fine Tuning Analog Channels	84
Checking the Digital-Signal Strength	85
LNA (Low Noise Amplifier)	86

Connecting a PC and Operation

Connecting a PC	88
Changing the Position of the Image	92
Picture Quality Adjustment.....	93
Image Reset	95

Time Setting

Setting the Clock	98
Setting the On/Off Timer.....	100
Setting the Sleep Timer	101

Function Description

Selecting a Menu Language	104
Digital Noise Reduction.....	105
Selecting the Film Mode	106
Setting the Blue Screen	107
Using Game Mode.....	108
Viewing Closed Captions (On-Screen Text Messages) - Analog	109
Viewing Closed Captions (On-Screen Text Messages) - Digital.....	110
Menu Transparency Level	112
Using the Energy Saving Feature	113
Preventing Screen Burn-in	114
Reducing the Effects of Screen Burn	115
Setting the Function Help.....	116
Setting the Blue Eye	117
Using the V-Chip (for USA)	118
Using the V-Chip (for Canada)	124

Appendix

Troubleshooting	134
Care and Maintenance	135
Specifications.....	136
Dimensions (HP-S4253).....	137
Dimensions (HP-S5053).....	139

Note

- The information contained in these Owner's Instructions is subject to change without prior notice for improvement, and may vary depending on the version of the TV's software and the regional conditions.

S
A
M
S
U
N
G

P L A S M A D I S P L A Y P A N E L

General Information



Your New Plasma Display Panel	8
Remote Control Buttons	11
Wall Installation Instructions	13
How to assemble the Stand-Base.....	17



Your New Plasma Display Panel

Front Panel

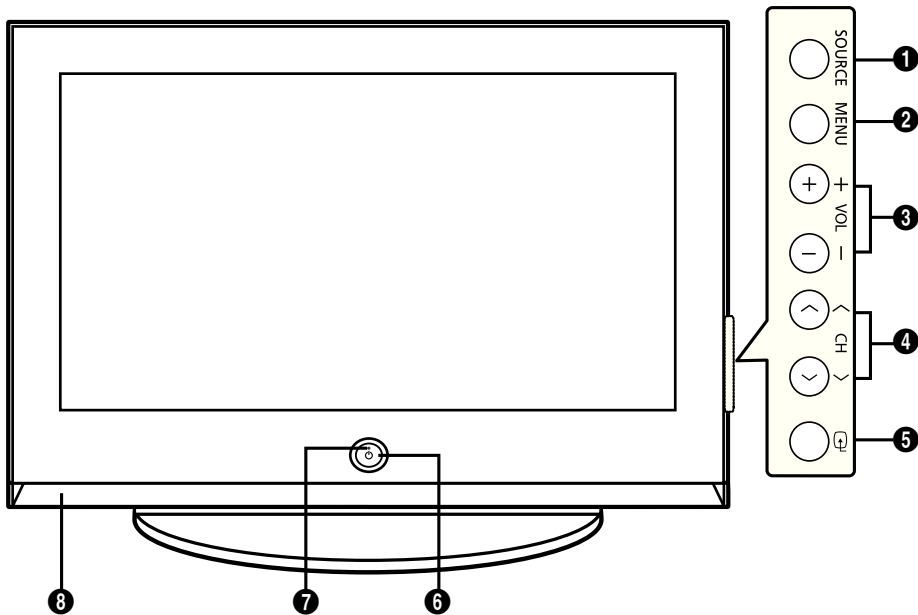

1 SOURCE button

Press to display all of the available video sources (TV, AV1, AV2, S-Video1, S-Video2, Component1, Component2, PC, HDMI1, and HDMI2).

2 MENU button

Displays the main on-screen menu.

3 VOL +, - buttons

Press to increase or decrease the volume. Also used to select or adjust items on the on-screen menu.

4 CH(^, v) buttons

Press CH^ or CHv to change channels. Also used to move up or down in the on-screen menu.

5 (Enter) button

Press to confirm a selection.

6 Power button

Press to turn the TV on and off.

Power indicator
- Power Off : Blue
- Power On : Off

7 Remote Control Sensor

Aim the remote control towards this spot on the TV.

8 Speakers

Plasma Display

Checking Accessories

Once you have unpacked your TV, check to make sure that you have all the parts shown here. If any piece is missing or broken, call your dealer.



Owner's Instructions
(BN68-00991B) /
Quick Setup Guide
(BN68-00766N)



Warranty Card
(BN68-00872A, 6801-001011) /
Registration Card
(AA68-40065B) /
Safety Guide Manual
(AA68-03242F)
(Not available in all locations)
C/WARR (AA68-01561A)

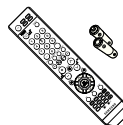

Remote Control (BN59-00511A) /
AAA Batteries (4301-000103)



Power Cord
(3903-000144)

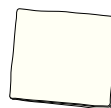

Cloth-Clean

The following parts are sold separately and are available at most electronics stores.



S-VIDEO Cable
(BN39-00149A)



HDMI Cable
(BN39-00641A)



HDMI/DVI cable
(BN39-00643A)



Component Cables (RCA)
(BN39-00279A)



PC Cable
(BN39-00115A)



PC Audio Cable
(BN39-00061B)



Optical Cable



Coaxial Cable
(BN39-00110A)



Antenna Cable
(BN39-00333A)

Side of the TV

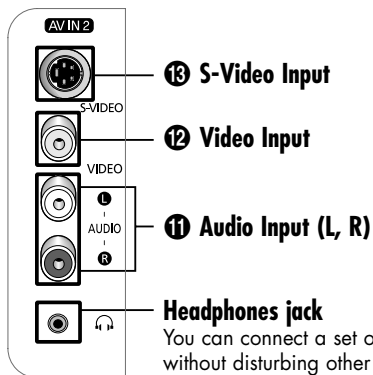

You can connect a set of headphones to your television if you wish to watch a television program without disturbing other people in the room.

Note

- Prolonged use of headphones at a high volume may damage your hearing.

Rear Panel

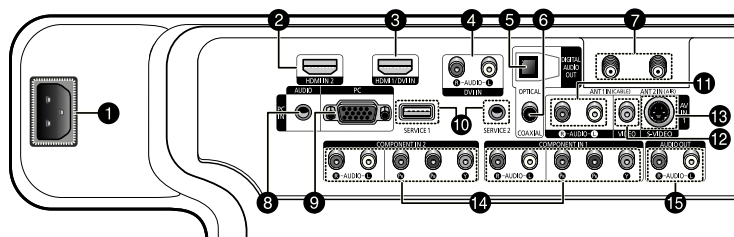

1 POWER IN

Connect the supplied power cord.

2 HDMI IN 2

Connect to the HDMI jack of a device with HDMI output.

3 HDMI 1/DVI IN

Connect to the HDMI jack of a device with HDMI output. These inputs can also be used as a DVI connection with separate analog audio inputs. An optional HDMI/DVI cable will be necessary to make this connection. When using the optional HDMI/DVI adapter, the DVI analog audio inputs on your TV allow you to receive left and right audio from your DVI device. (Not compatible with PC)

4 DVI IN (AUDIO-L/R)

Connect to the DVI audio output jack of an external device.

5 OPTICAL DIGITAL AUDIO OUT

Connect to a Digital Audio component.

6 COAXIAL DIGITAL AUDIO OUT

Connect to a Digital Audio component.

7 ANT 1 IN (CABLE)/ANT 2 IN (AIR)

75Ω Coaxial connector for Antenna/Cable Network.

8 PC AUDIO IN

Connect to the audio output jack on your PC.

9 PC IN

Connect to the video output jack on your PC.

10 SERVICE 1/SERVICE 2

This jack is for software upgrades.

11 AUDIO-L/R (AV IN 1, 2)

Audio inputs for external devices, such as a camcorder or VCR.

12 VIDEO (AV IN 1, 2)

Video input for external devices, such as a camcorder or VCR.

13 S-VIDEO (AV IN 1, 2)

Video input for external devices with an S-Video output, such as a camcorder or VCR.

14 COMPONENT IN 1, 2

Video (Y/Pb/Pr) and audio (L-AUDIO-R) component inputs.

15 AUDIO OUT

Audio outputs for external devices.

Note

- Please be sure to match the color coded input terminals and cable jacks.



Remote Control Buttons

Remote Control

- 1 POWER button**
Turns the TV on and off.
- 2 Number buttons**
- 3 - button**
Press to select additional channels (digital and analog) being broadcast by the same station. For example, to select channel "54-3", press "54", then press "-" and "3".
- 4 ANTENNA button**
Press to select "Air" or "Cable".
- 5 CH MGR button**
Used to displays Channel Lists on the screen.
- 6 VCR, DVD control buttons**
Controls VCR tape or DVD disc functions: Rewind, Stop, Play/Pause, and Fast Forward.
- 7 VOL (Volume) buttons**
Use it to adjust volume.
- 8 MUTE button**
Press to mute the TV sound.
- 9 MENU button**
Displays the main on-screen menu.
- 10 ENTER button**
Confirms a selection.
- 11 PIP button**
Activates picture in picture. (Refer to page 58)
- 12 INFO button**
Press to display information on the TV screen.
- 13 Mode (TV/DVD/STB/CABLE/VCR) button**
Selects a target device to be controlled by the Samsung remote control (i.e., TV, DVD, STB, CABLE, or VCR).
- 14 SOURCE button**
Press to display all of the available video sources (TV, AV1, AV2, S-Video1, S-Video2, Component1, Component2, PC, HDMI1, and HDMI2).
- 15 PRE-CH button**
Tunes to the previous channel.
- 16 E.SAVING button**
Press to adjust screen brightness according to surrounding environment. (Refer to page 113)
- 17 FAV.CH button**
Press to switch between your favorite channels.
- 18 CH (Channel) buttons**
Use it to switch channels.
- 19 EXIT button**
Press to exit the menu.
- 20 Up/Down/Left/Right buttons**
Control the cursor in the menu.
- 21 SLEEP button**
Press to select a preset time interval for automatic shut off. (Refer to page 101)

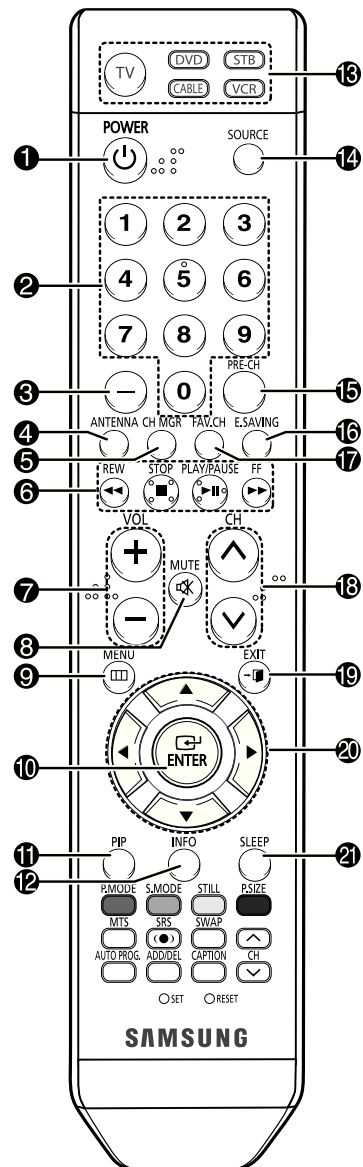

22 P.MODE button

Adjust the TV picture by selecting one of the preset factory settings (or select your personal, customized picture settings). (Refer to page 53)

23 S.MODE button

Select Sound effect. (Refer to page 67)

24 MTS button

Press to choose stereo, mono or Separate Audio Program (SAP broadcast).

25 SRS button

Activates TruSurround. (Refer to page 68)

26 AUTO PROG. button

Press to display the memorized channels menu. (Refer to page 37)

27 ADD/DEL button

Press to add or erase channels in the TV's memory. (Refer to page 81)

28 STILL button

Press to pause the current screen.

29 P.SIZE button

Select Picture size. (Refer to page 56)

30 PIP control buttons

SWAP: Interchange the main and sub picture.
CH (▲, ▼): Displays the available channels in sequence.
(These buttons change channels in the PIP window only.)

31 CAPTION button

Controls the caption decoder.

32 RESET button

If your remote control is not functioning properly, take out the batteries and press the reset button for about 2~3 seconds.
Re-insert the batteries and try using the remote control again.

33 SET button

Used during set up of this Samsung remote control, so that it will work compatibly with other devices (VCR, Cable Box and DVD).

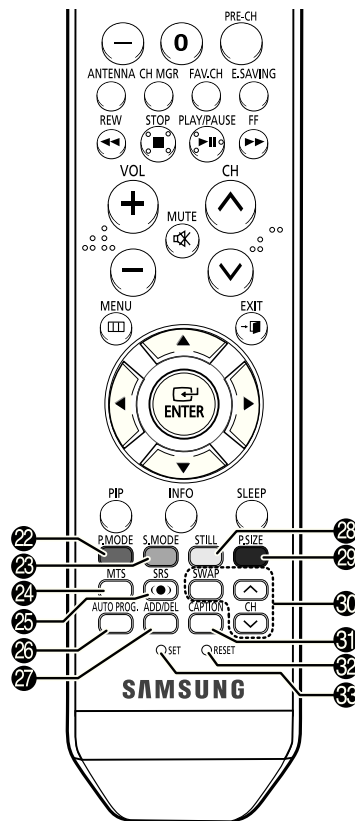

Note

- This is a special remote control for the visually impaired, and has Braille points on the Power, Channel and Volume buttons.

Installing the Batteries in Your Remote Control

1 Lift the cover at the back of the remote control upward as shown in the figure.

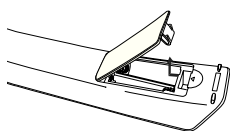

2 Install two AAA size batteries. Make sure to match the "+" and "-" ends of the batteries with the diagram inside the compartment.
• Do not mix battery types, i.e. alkaline and manganese.

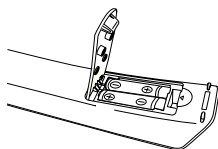

3 Close the cover as shown in the figure.

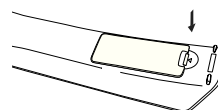

Remote Control Operation Range

You can use your remote control within a distance of 23 feet and an angle of 30 degrees from the left and right sides of the TV's remote control receiver.



Wall Installation Instructions

Refer to the installation guide supplied with your wall bracket.

● Installation Notes

- 1 Contact a professional installation service to install the wall bracket.
- 2 Samsung Electronics is not responsible for any damages to the product or harm to customers when the installation is done by the customer.
- 3 This product is for installing on cement walls. The product may not stay in place when installed on plaster or wood.
- 4 Connect all external devices prior to installing the wall bracket.
- 5 The package contents and parts supplied for the wall mount are subject to change without prior notice.

● Parts (Wall attachment panel is sold separately. Check with your dealer.)

Please use only the parts and components provided for wall mount installation.

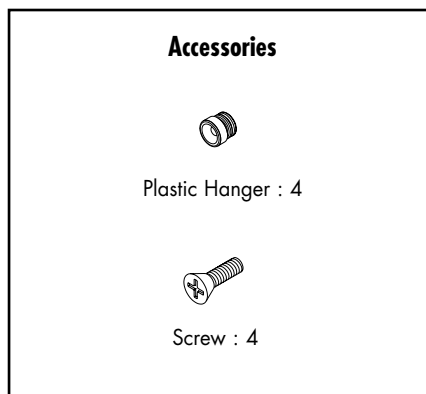
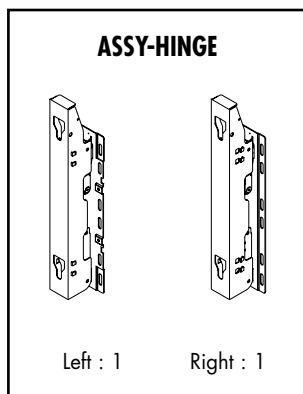
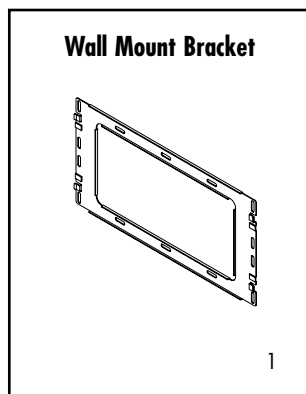

● How to assemble the Wall Mount Bracket

- 1 The wall mount bracket is delivered separately. Please tighten the captive screw in the direction of the arrow after assembling the bracket.
Install the Wall Mount Bracket after the screws are securely inserted into the wall.

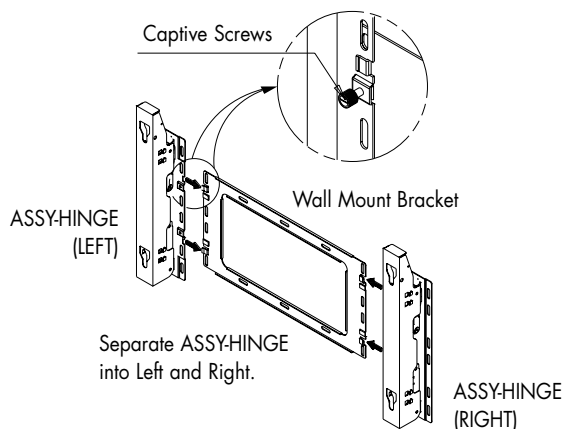

● Fixing the TV panel to the wall attachment panel bracket

The shape of the product may vary depending on the model. (The assemblies of the plastic hanger and the screw are the same)

- 1 Remove the screws from the back of the PDP.

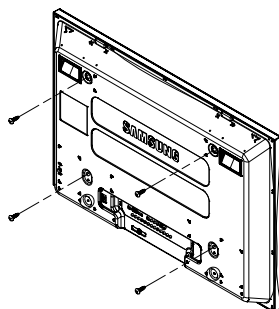

- 2 Use the screw and assemble the plastic hanger. (Please refer to the following picture.)



- Please ask the installers to install the wall mount bracket.
- Please be sure to check if the plastic hanger is completely secured on both the left and right side after hanging the SET on the wall mount bracket.
- Please avoid catching your fingers while installing and adjusting the angle.
- Please tightly secure the wall mount bracket to the wall to avoid injury from a falling SET.

- 3** Tighten the screws of the plastic hanger (shown in picture 2) to the back side of the PDP.

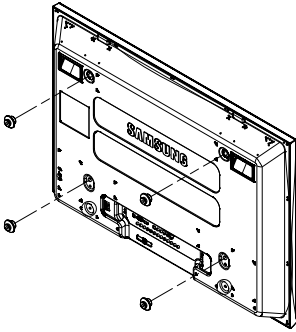

- 4** Remove the Safety Pins. Fasten the 4 plastic latches assembled at step (3) on the back side of the PDP using the guide holes of the wall mount, push (1) and hook (2) down to secure the PDP on the wall mount as illustrated. Secure the PDP by inserting the Safety Pins, not to fall from the wall mount.

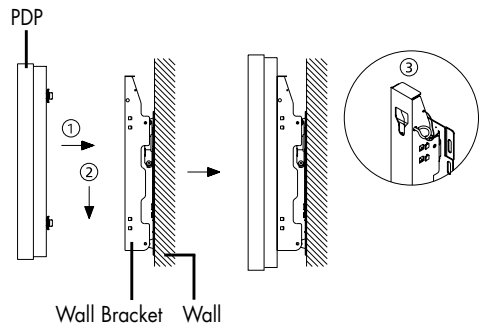

● How to Adjust Mounting Angle

Note : Please secure the mounting bracket on the wall surface after setting its angle at 0°

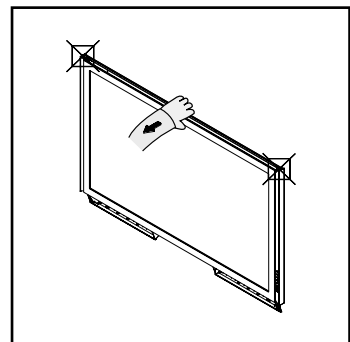
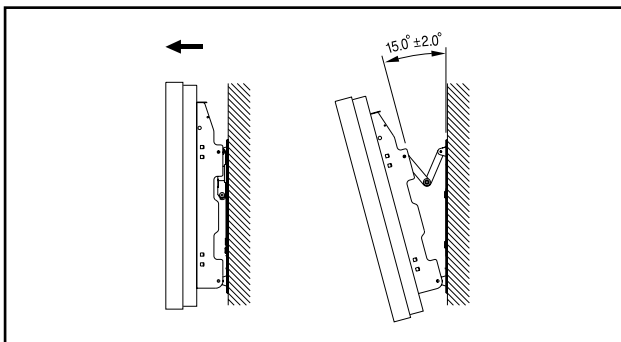

1. Secure the SET to the wall mount bracket. (Please refer to the following instructions.)
2. Set the angle by pulling the upper end of the SET attached to bracket in the direction of the arrow. (Refer to the illustration on the right.)
3. The angle can be adjusted from 0° to 15° by $\pm 2^\circ$.

Hold onto the middle of the PDP to adjust the angle (not the sides of the PDP).

● Connecting External Devices to the PDP

Note : To connect external devices such as a DVD or a Home Theater System to the PDP, please refer to following instructions:

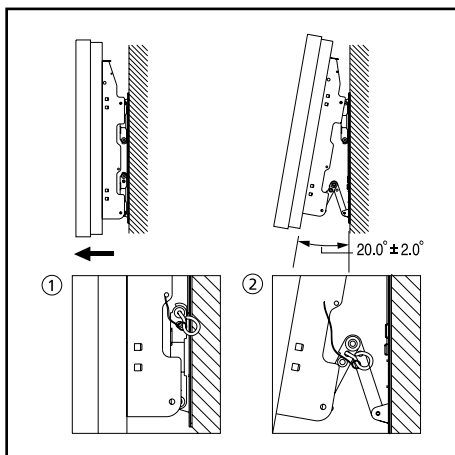

1. Be sure to remove the safety pins underneath the PDP.

Note : If the safety pins are not removed, the angle cannot be adjusted. Any attempt to do so may cause damage to the PDP.

2. Hold onto the bottom of the PDP and pull forward fully as directed by the arrow as illustrated) to adjust the angle. ($0^\circ \sim 20^\circ$ by 2°) Insert the Safety Pins to the front guide holes on both sides as illustrated in figure ②.

Note : Viewing the PDP after connecting the external devices Remove the Safety Pins to adjust the angle to 0° , and then secure the Safety Pins again.

- For safety, be sure to secure the PDP using the safety pins. If the safety pins are not used, the PDP may fall, causing serious injury.



How to assemble the Stand-Base

- 1 Using the 4 screws for securing the stand pegs and the monitor, firmly attach the monitor to the stand pegs. (The exterior of the set may be different than the picture.)

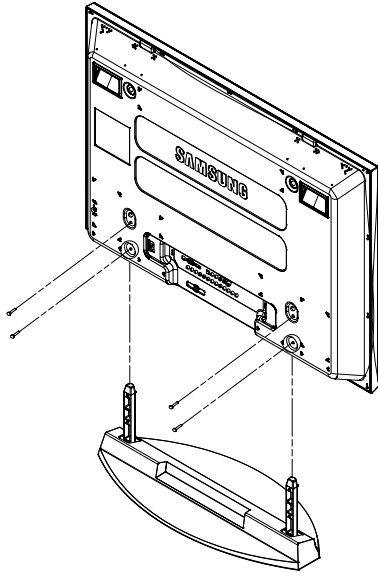

Warning

Firmly secure the stand to the TV before moving it, as the stand may fall and could cause serious injury.

- Two or more people should carry the TV. Never lay the TV on the floor because of possible damage to the screen. Always store the TV upright.

P L A S M A D I S P L A Y P A N E L

Connections



Connecting VHF and UHF Antennas	20
Connecting Cable TV.....	21
Connecting a VCR.....	23
Connecting a Camcorder	24
Connecting a DVD Player (480i, 480p).....	25
Connecting a DTV Receiver (480p, 720p, 1080i)	26
Connecting to HDMI (High Definition Multimedia Interface) (480p, 720p, 1080i)	27
Connecting a Digital TV Set-Top Box (480p, 720p, 1080i)	28
Connecting a Digital Audio System	29
Connecting to an Analog Amplifier	30



Connecting VHF and UHF Antennas

Antennas with 75-ohm Round Leads

If your antenna looks like this:  it has 75-ohm round leads.

- 1 Plug the antenna lead into the ANT 2 IN (AIR) on the TV.
Use an antenna cable. (Sold Separately)

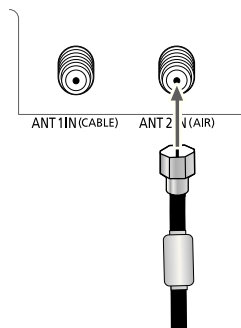



Connecting Cable TV

You can connect different cable systems to your TV, including cable without a Cable box, and cable with a Cable box that descrambles some or all channels.

Cable without a Cable Box

- 1 Plug the incoming cable into the ANT 1 IN (CABLE) on the TV.
Use an antenna cable. (Sold Separately)

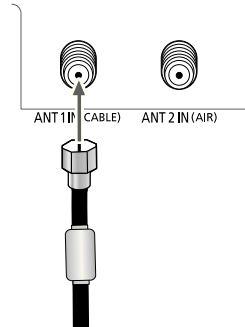

Cable with a Cable Box that Descrambles All Channels

- 1 Find the cable connected to the ANTENNA OUT terminal on your Cable box. This terminal might be labeled "ANT OUT", "VHF OUT" or simply "OUT".

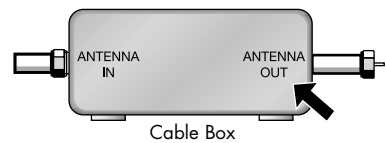

- 2 Connect the cable to the ANT 1 IN (CABLE) on the TV.
Use an antenna cable. (Sold Separately)

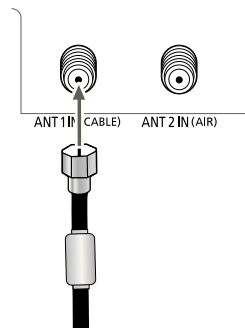

Cable with a Cable Box that Descrambles Some (But Not All) Channels

To complete this connection you will need a two-way splitter, an RF (A/B) switch, and four coaxial cables (which you can buy from your Samsung dealer or any electronics store).

- 1 Find and disconnect the cable that is connected to the ANTENNA IN terminal of your Splitter. This terminal might be labeled "ANT IN", "VHF IN" or simply, "IN". Connect this cable to a two-way splitter.

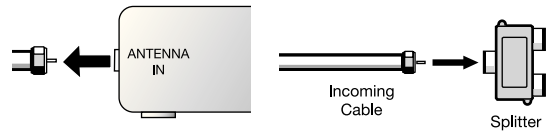

- 2 Connect a coaxial cable between an OUT terminal of the splitter and the IN terminal of the Cable box.

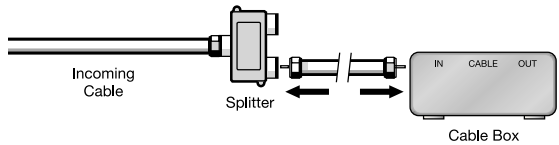

- 3 Connect a coaxial cable between the ANTENNA OUT terminal of the Cable box and the B-IN terminal of the RF (A/B) switch.

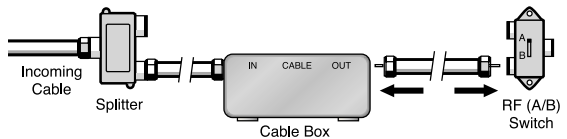

- 4 Connect a coaxial cable between the other OUT terminal of the Splitter and the A-IN terminal of the RF (A/B) switch.

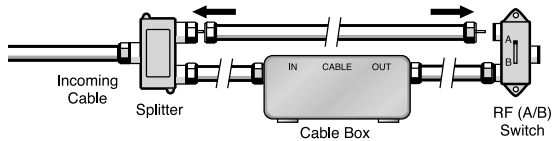

- 5 Connect the last coaxial cable between the OUT terminal of the RF (A/B) switch and the ANT 1 IN (CABLE) on the TV.

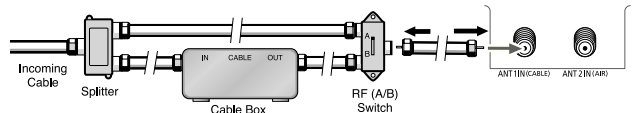

After you've made this connection, set the A/B switch to the "A" position for normal viewing. Set the A/B switch to the "B" position to view scrambled channels. (When you set the A/B switch to "B", you will need to tune your Set-Top Box to the Cable box's output channel, which is usually channel 3 or 4.)



Connecting a VCR

Connecting a VCR to the Video or S-Video/Audio jack

TV Rear Panel

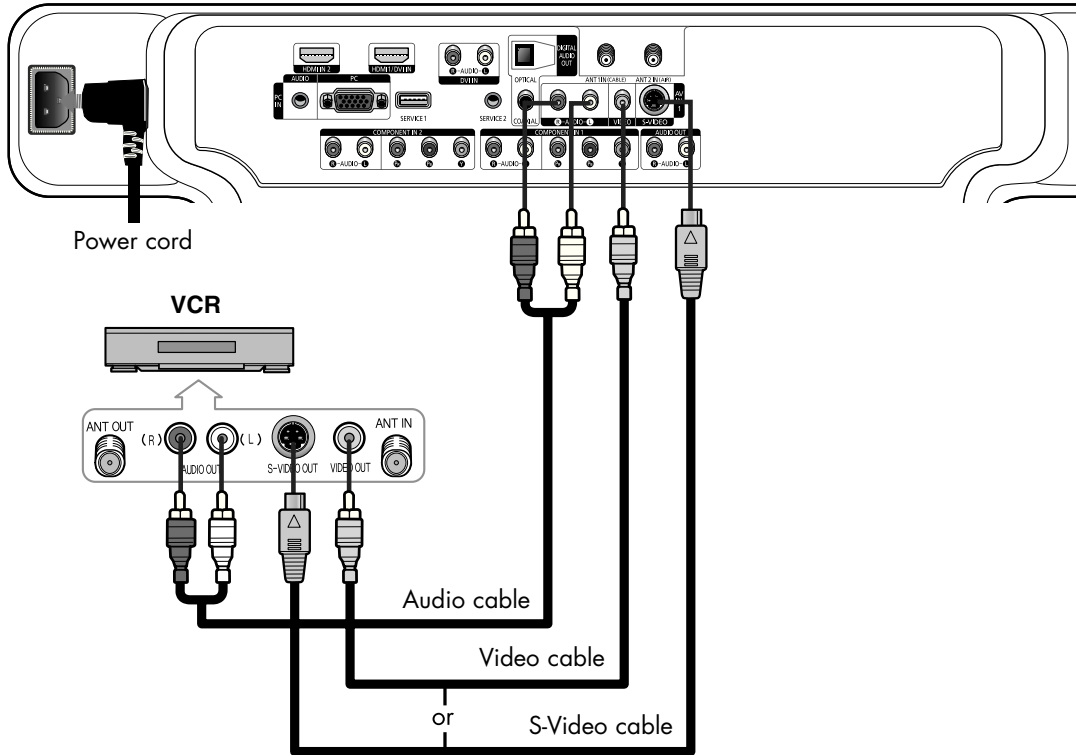

How to Connect

Connect the Video/Audio cables between the VIDEO or S-VIDEO/AUDIO input jacks on the TV and VIDEO or S-VIDEO/AUDIO output jacks on the VCR.
(Note: For better video, use an S-Video cable.)

Note

- Please be sure to match the color coded input terminals and cable jacks.

Videotape Playback:

1. Turn on your TV.
2. Turn on your VCR, insert a videotape and press the Play button.
3. Press the SOURCE button to select "Video (AV1 or AV2)" or "S-Video (S-Video1 or S-Video2)".



Connecting a Camcorder

Viewing camcorder playback

Side of the TV

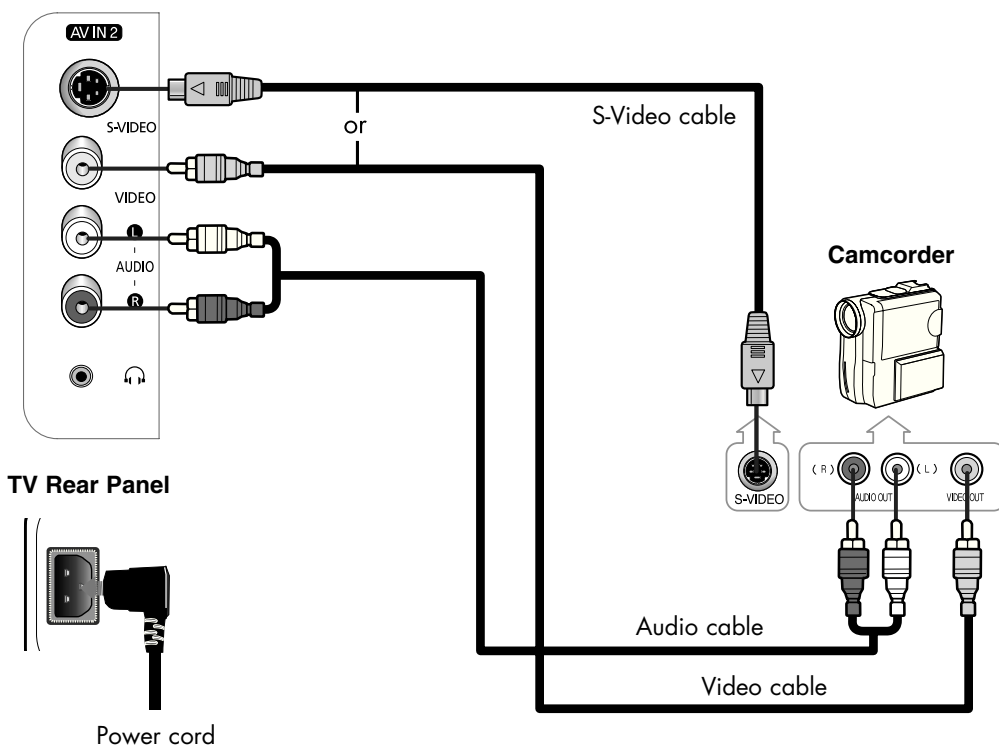

How to Connect

Connect a Video/Audio cable between the VIDEO or S-VIDEO/AUDIO input jacks on the TV and the VIDEO or S-VIDEO/AUDIO output jacks on the camcorder.
(Note: For better video, use an S-VIDEO cable.)

Note

- Please be sure to match the color coded input terminals and cable jacks.

Viewing Tapes

1. Turn on your TV.
2. Turn on your camcorder and set it to video mode. (For details, refer to your camcorder owner's instructions.)
3. Press the SOURCE button to select "Video (AV1 or AV2)" or "S-Video (S-Video1 or S-Video2)".
4. Set the IN/OUT switch on your camcorder to OUT.
5. Insert the tape into the camcorder and press the Play button.



Connecting a DVD Player (480i, 480p)

Playing DVD

TV Rear Panel

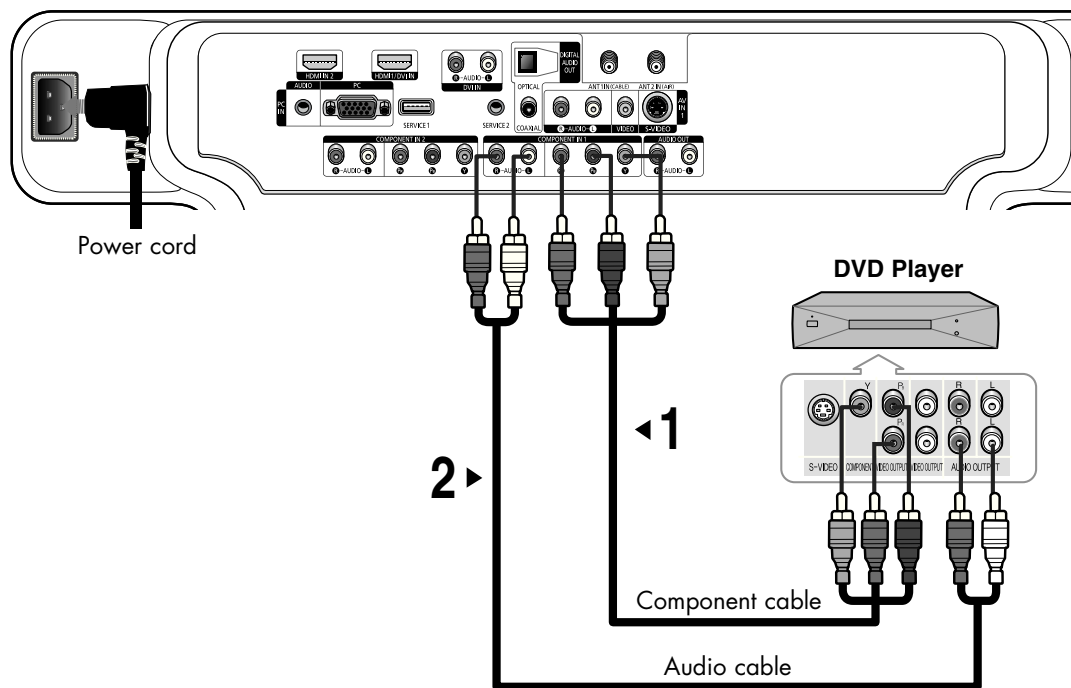

How to Connect

- 1 Connect the Y, P_B, P_R (COMPONENT1, 2) input jacks on the TV to the Y, P_B, P_R output jacks on the DVD player using a component cable.
- 2 Connect the AUDIO L/R (COMPONENT1, 2) input jacks on the TV to the AUDIO output jacks on the DVD player using an audio cable.

Note

- Please be sure to match the color coded input terminals and cable jacks.

To Play DVD:

1. Turn on your TV.
2. Turn on your DVD player, insert a DVD disc and press the Play button.
 - Component Video separates the video into Y (Luminance (Brightness)), P_B (Blue) and P_R (Red) for enhanced video quality.
3. Press the SOURCE button to select "Component 1" or "Component 2".



Connecting a DTV Receiver (480p, 720p, 1080i)

This TV displays the optimum picture in 720p mode.

Watching DTV

TV Rear Panel

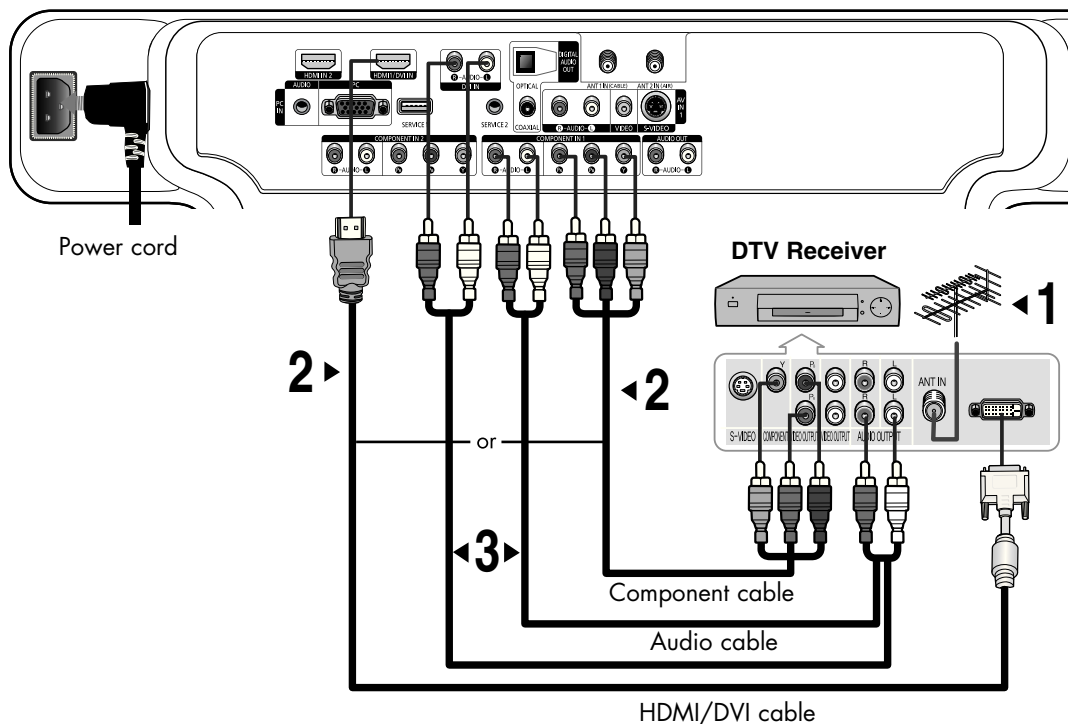

How to Connect

- 1 Connect the cable or antenna to the antenna input jack on the DTV.
- 2 Connect the Y, P_B, P_R (COMPONENT1, 2) or HDMI/DVI input jack on the TV to the Y, P_B, P_R or DVI output jacks on the DTV receiver using a component or HDMI/DVI cable.
- 3 Connect the AUDIO L/R (COMPONENT1, 2 or DVI AUDIO IN) input jacks on the TV with the AUDIO output jacks on the DTV receiver using an audio cable.

Note

- Please be sure to match the color coded input terminals and cable jacks.

To Watch DTV:

1. Turn on your TV.
2. Turn on your DTV receiver.
 - For an explanation of component video, see your DTV receiver owner's instructions.
3. Press the SOURCE button to select "Component1", "Component2" or "HDMI 1/DVI".



Connecting to HDMI (High Definition Multimedia Interface) (480p, 720p, 1080i)

Watching DTV

TV Rear Panel

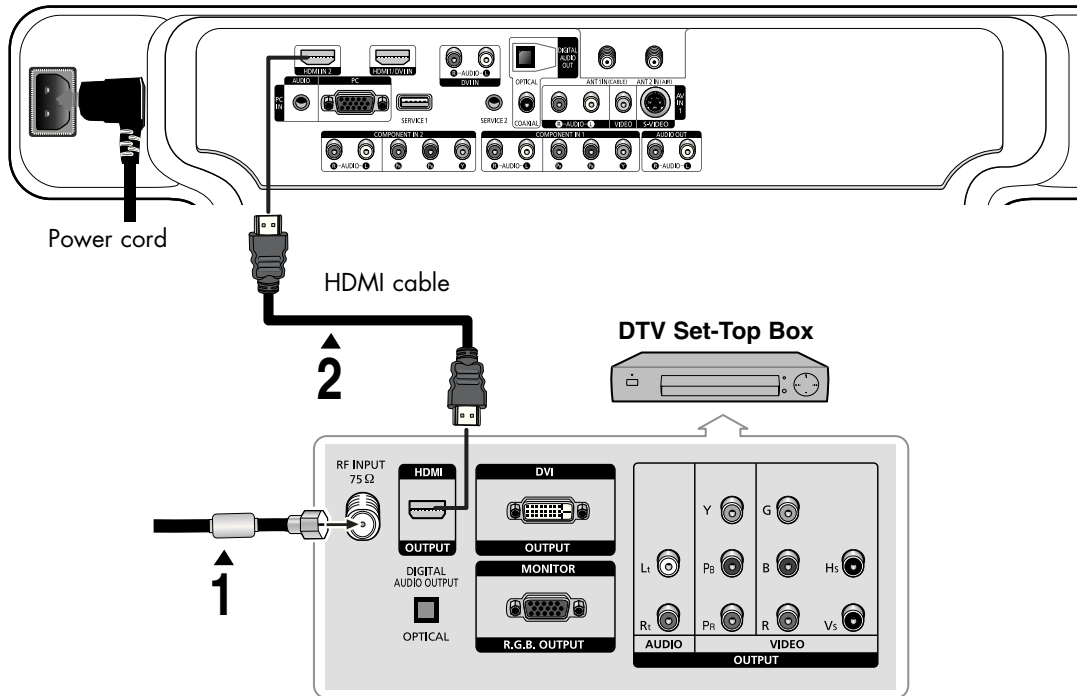

How to Connect

- 1 Connect the cable or antenna to the antenna input jack on the DTV.
- 2 Connect the HDMI input jack on the TV with the HDMI output jack on the DTV Set-Top Box using an HDMI cable.

Note

- Please make sure the HDMI source's (Set-Top Box) power is on before selecting HDMI from the "Source List" on the TV.

To Watch DTV:

1. Turn on your TV.
2. Turn on your DTV receiver.
 - For an explanation of HDMI video, see your DTV receiver owner's instructions.
3. Press the SOURCE button to select "HDMI 1 or HDMI 2".



Connecting a Digital TV Set-Top Box (480p, 720p, 1080i)

By inputting a high-bandwidth digital content protection High-Definition picture source to the HDMI input jack on the TV, High-Definition pictures can be displayed on the screen in their digital form.

Connecting to HDMI (High Definition Multimedia Interface)/DVI Compatible

TV Rear Panel

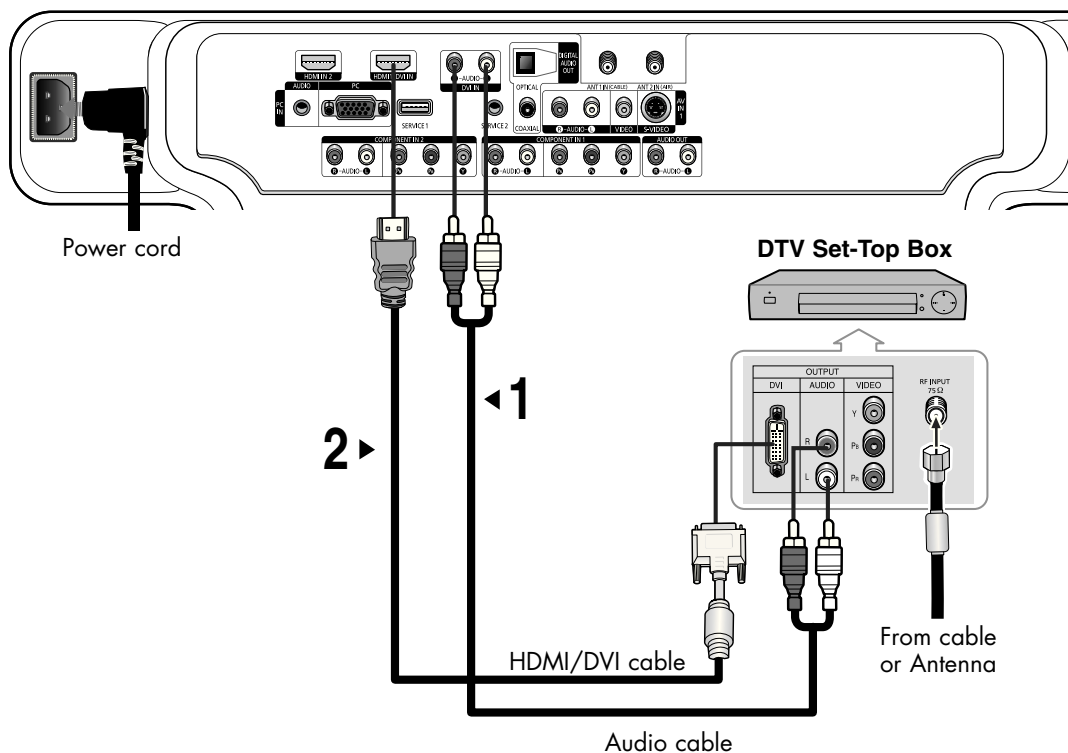

How to Connect

- 1 Connect the DVI AUDIO (L, R) input jacks on the TV with the AUDIO output jacks on the Set-Top Box using an audio cable.

Note

- Use analog stereo audio inputs when using the HDMI input with a device that outputs DVI instead of HDMI.

- 2 Connect the HDMI input jack on the TV and the DVI output jack on the Set-Top Box using an HDMI/DVI cable.

Note

- The HDMI/DVI IN jack is not compatible with PC.



Connecting a Digital Audio System

There are many types of digital audio systems on the market today.

A simplified illustration of an audio system is shown below. For more information, see your audio system owner's manual.

TV Rear Panel

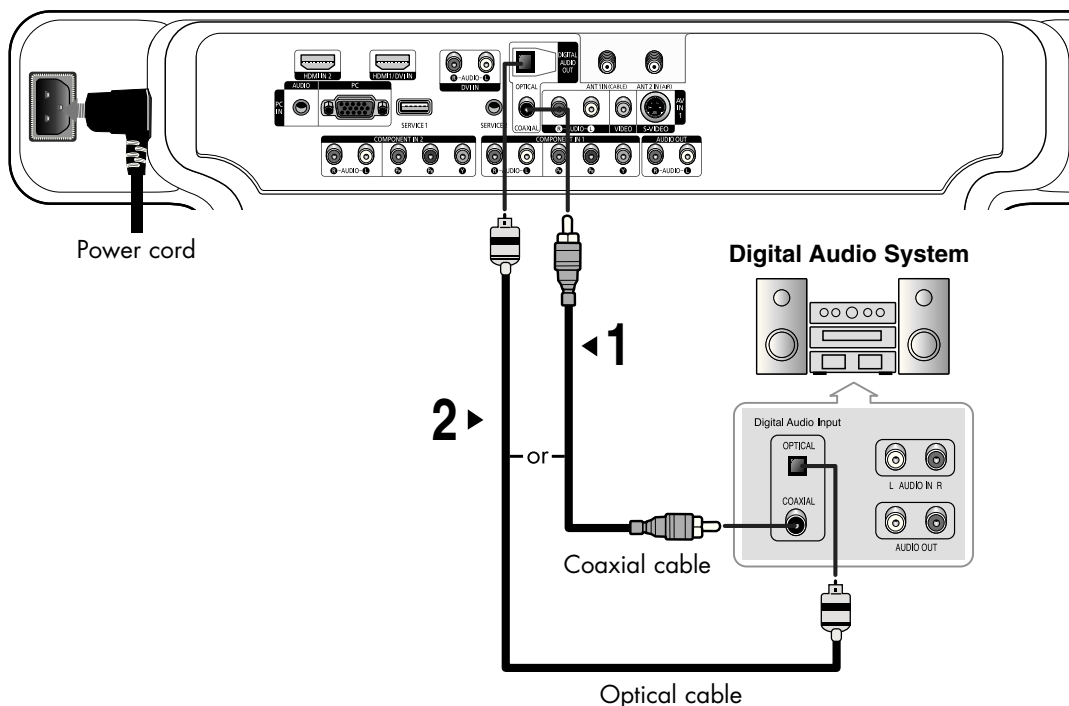

How to Connect

- 1 If your audio system has a coaxial digital audio input, connect to the "COAXIAL" output jack on the TV.
- 2 If your audio system has an optical digital audio input, connect to the "OPTICAL" output jack on the TV.
Be certain to remove the black cover from the optical output before inserting the cable.
- 3 If your system has both coaxial and optical digital audio inputs, SAMSUNG recommends you use the optical digital output on the TV.
Do not connect both optical and coaxial cables. This may damage your audio system.
 - OPTICAL: converts the electric signal into an optical light signal, and transmits it through glass fibers.
 - COAXIAL: The digital audio signal is received through a coaxial copper cable.

When a Digital Audio System is connected to the "DIGITAL AUDIO OUT (Optical or Coaxial)" terminals: Decrease the gain (volume) of the TV, and adjust the volume level with the System's volume control.



Connecting to an Analog Amplifier

TV Rear Panel

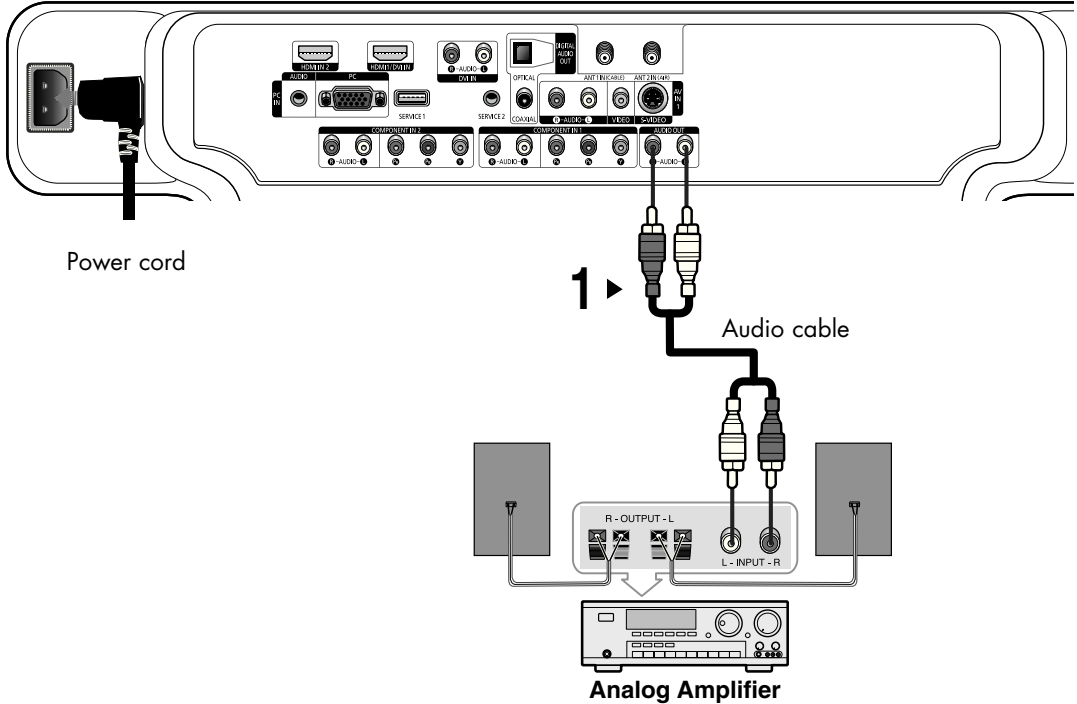

How to Connect

- 1 The "AUDIO OUT (AUDIO L/R)" terminals cannot be used for external speakers. You must hook them up to an amplifier.

When an audio amplifier is connected to the "AUDIO OUT (AUDIO L/R)" terminals: Decrease the gain (volume) of the TV, and adjust the volume level with the Amplifier's volume control.

Optical Output & Audio Monitor Output

	Optical	L & R Out
Tuner NTSC	Yes	Yes
Tuner HD	Yes	Yes
Tuner SD	Yes	Yes
HDMI 1080i	Yes	Yes
HDMI 720p	Yes	Yes
HDMI 480i	Yes	Yes
Component 480i	Yes	Yes
Component 480p	Yes	Yes
Component 720p	Yes	Yes
Component 1080i	Yes	Yes
S-Video	Yes	Yes
Composite	Yes	Yes
PC	Yes	Yes

S
A
M
S
U
N
G

P L A S M A D I S P L A Y P A N E L

Operation

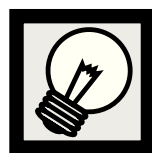

Turning the TV On and Off.....	32
Viewing the Menus and Displays	36
Memorizing the Channels	37
Setting Up Your Remote Control	41
Viewing an External Signal Source	48



Turning the TV On and Off

Turning the TV On and Off

Press the POWER (⏻) button on the remote control.
The TV will be turned on and you will be able to use its features.
You can also use the Power button on the front of the TV.

Note

- If your TV isn't turned on when the POWER button is pressed:
Check if the TV mode has been chosen.

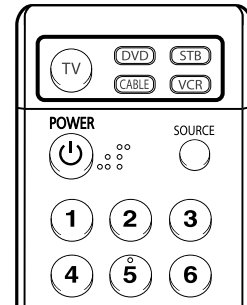

Plug & Play Feature

When the TV is initially powered On, basic customer settings proceed automatically and subsequently: Setting the language, checking the antenna input, memorizing the channels, and setting the time.

Note

- The Plug & Play function operates after plugging in the TV for the first time.

- 1 Press the POWER button on the remote control.
The message "Menu language, Channels and Time will be set." is displayed.
Press the ENTER button, then "Select the language of the OSD." menu is automatically displayed.

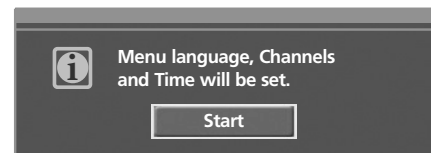

- 2 Press the ENTER button to enter the language.
Press the ▲ or ▼ button to select language, then the ENTER button. "Select the antennas to memorize." menu is automatically displayed.

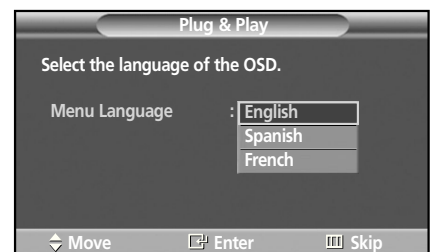

Continued...

Option 1: Setting the Clock Automatically

If you set "Clock Mode" to "Auto" in step 6, follow the instructions below.

- 7 Press the ENTER button to select "DST" (Daylight Savings Time). Press the ▲ or ▼ button to select "No" or "Yes", then press the ENTER button. "Select the time zone in which you live" menu is automatically displayed.

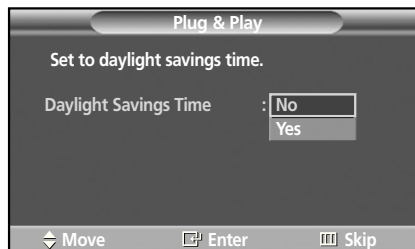

- 8 Press the ▲ or ▼ button to highlight the time zone for your local area (and to move the highlight to the appropriate time zone on the map of the United States). Press the ENTER button.

If you have received a digital signal, the time will be set automatically. If not, see page 99 to set the clock.



- 9 The message "Enjoy your watching." is displayed. When you have finished, press the ENTER button.

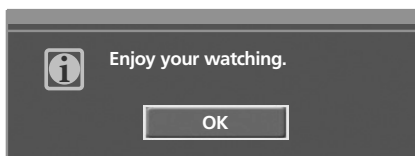

Option 2: Setting the Clock Manually

If you set "Clock Mode" to "Manual" in step 6, follow the instructions below.

- 7 Press the ◀ or ▶ button to move to "Month", "Day", "Year", "Hour", "Minute", or "am/pm". Set the clock you want by pressing the ▲ or ▼ button, then press the ENTER button.
- You can set the month, day, year, hour and minute directly by pressing the number buttons on the remote control.



- 8 The message "Enjoy your watching." is displayed. When you have finished, press the ENTER button.

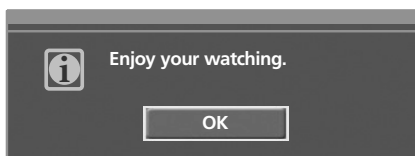

To reset this feature...

- 1 Press the MENU button. Press the ▲ or ▼ button to select "Setup", then press the ENTER button.



- 2 Press the ENTER button to select "Plug & Play".

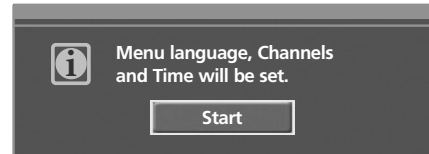

- 3 For further details on setting up options, refer to the previous page.

Note

- Plug and Play can only be accessed in the TV mode.



Viewing the Menus and Displays

Your TV has a simple, easy-to-use menu system that appears on the TV screen. This system makes it convenient and fast to use features on the TV. Your TV also lets you display the status of many of your TV's features.

Viewing the Menus

- 1 With the power on, press the MENU button on the remote control. The main menu appears on the screen. The Input menu is selected.



- 2 Press the ▲ or ▼ button to move to items in the menu. Press the ◀/▶/ENTER buttons to display, change, or use the selected items.

Press the ENTER button to enter items in the menu. On screen menus disappear from the screen automatically after about one minute or you can press the EXIT button on your remote control to exit the menu.

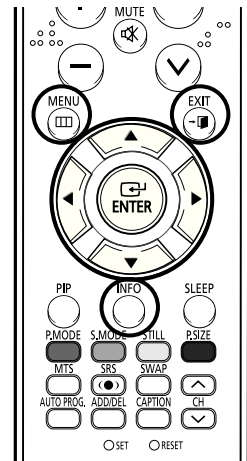

Displaying Status Information

Press the INFO button on the remote control. The TV will display the Picture Mode, Sound Mode, MTS, and Current Time.

Note

- The INFO window automatically disappears after a few seconds. Press the INFO button once to manually close the window.

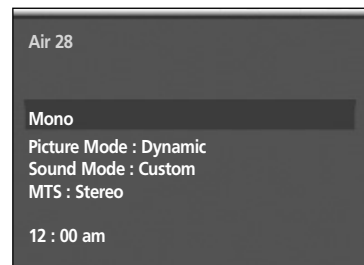



Memorizing the Channels

Your TV can memorize and store all of the available channels for both “off-air” (antenna) and cable channels. After the available channels are memorized, use the CH \wedge and CH \vee buttons to scan through the channels. This eliminates the need to change channels by entering the channel digits. There are three steps for memorizing channels: selecting a broadcast source, memorizing the channels (automatic) and adding and deleting channels (manual).

Selecting a broadcast source

Before your television can begin memorizing the available channels, you must specify the type of signal source that is connected to the TV (i.e., an antenna or a cable system).

- 1 Press the MENU button. Press the \blacktriangle or \blacktriangledown button to select “Channel”, then press the ENTER button.

➤ Quick way to select Auto Program: Just press “AUTO PROG.” button on the remote control.

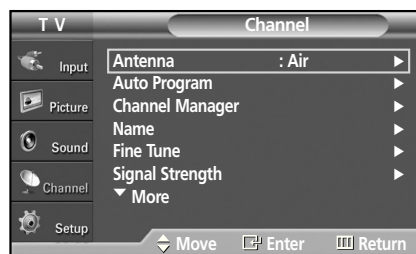

- 2 Press the \blacktriangle or \blacktriangledown button to select “Auto Program”, then press the ENTER button.



- 3 Press the \blacktriangle or \blacktriangledown button to select the antenna connection, then press the ENTER button.

Notes

- Air : “Air” antenna signal.
- Cable : “Cable” antenna signal.
- Air + Cable : “Air” and “Cable” antenna signals.
- If the antenna is connected to ANT 1 IN (CABLE), select “Cable” and if it is connected to ANT 2 IN (AIR), select “Air”.
- If both ANT 1 IN and ANT 2 IN are connected, select the “Air + Cable”.

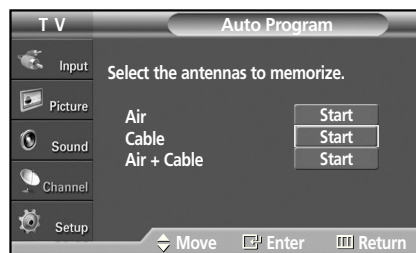
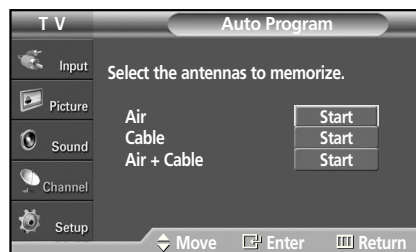

Storing Channels in Memory

- 4 Select the correct signal source (STD, HRC, and IRC) by pressing the ▲ or ▼ button, then press the ENTER button.

Note

- STD, HRC, and IRC identify various types of cable TV systems. Contact your local cable company to identify the type of cable system that exists in your particular area. At this point the signal source has been selected.

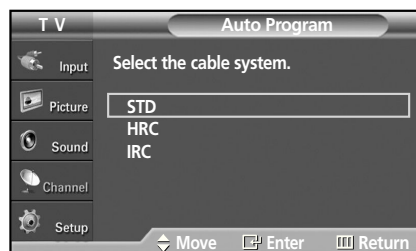

- 5 The TV begins memorizing all available stations. Press the ENTER button at any time to interrupt the memorization process. Press the EXIT button to exit.

Note

- The TV must be connected to an antenna in order to receive digital TV signals. Even if a particular channel is deleted from the memory, you can always tune to that channel directly by using the number buttons on the remote control.

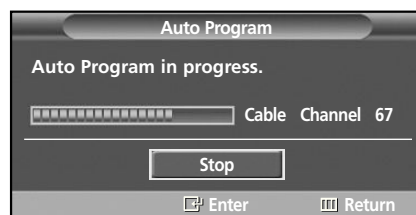

Notes

- All available DTV and analog channels are automatically stored in memory.
- It takes approximately 3 to 10 minutes to memorize channels.

Changing Channels

Using the Channel Buttons

Press the CH \wedge or CH \vee button to change channels.

When you press the CH \wedge or CH \vee button, the TV changes channels in sequence. You will see all the channels that the TV has memorized. (The TV must have memorized at least three channels.) You will not see channels that were either erased or not memorized.

Directly Accessing Channels

Press the number buttons to go directly to a channel. For example, to select channel 27, press "2" then "7".

When you use the number buttons, you can directly select channels that were either erased or not memorized. To change to single-digit channels (0~9) faster, press "0" before the single digit. (For channel "4" press "0", then "4".)

Note

- For quick channel change, press the number buttons and, then press ENTER button.

Using the PRE-CH button to select the previous channel

Press the PRE-CH button. The TV will switch to the last channel viewed.

To quickly switch between two channels that are far apart, tune to one channel, then use the number button to select the second channel. Then, use the PRE-CH button to quickly alternate between them.

Adjusting the Volume

Using the Volume Buttons

Press the VOL + or VOL - button to increase or decrease the volume.

Using Mute

Using the MUTE Button

At any time, you can temporarily cut off the sound using the MUTE button.

- 1 Press the MUTE button and the sound cuts off. The word "Mute" will appear in the lower-left corner of the screen.
- 2 To turn mute off, press the MUTE button again, or simply press the VOL + or VOL - button.

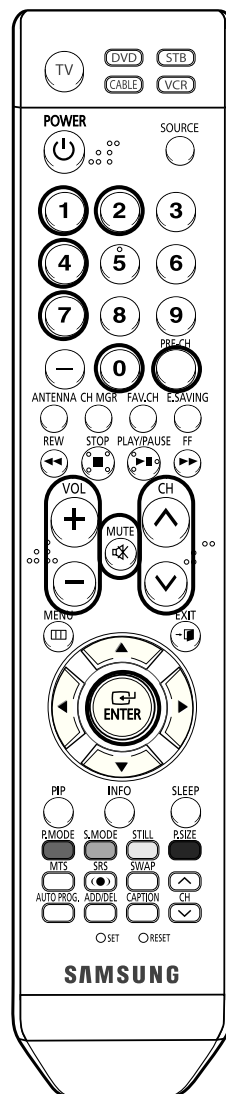

Using the “-” Button

The “-” button is used to select stations that broadcast both a digital and analog signal.

For example, for Channel 7-1 (digital), press “7”, then “-”, then “1”.



For channel 7-2 (analog), press “7”, then “-”, then “2”.

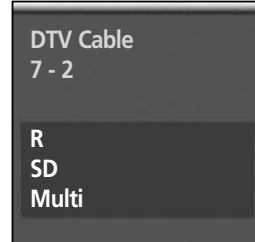

Notes

- HD indicates the TV is receiving a Digital High Definition signal.
- SD indicates the TV is receiving a Standard Definition signal.
- For quick channel change, press the number buttons, then press the ENTER button.

Freezing the Current Picture

Using the STILL Button

You can freeze the picture when watching a television program simply by pressing the STILL button. To return to normal viewing, press it again.

Note

- This function will automatically cancel five minutes later.

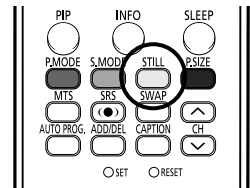



Setting Up Your Remote Control

After it has been set up properly, your remote control can operate in five different modes: TV, VCR, Cable, DVD, or Set-Top Box.

Pressing the corresponding button on the remote control allows you to switch between these modes, and control whichever piece of equipment you choose.

Note : • The remote control might not be compatible with all DVD Players, VCRs, Cable boxes, and Set-Top Boxes.

Setting Up the Remote to Operate Your VCR

- 1 Turn off your VCR.
- 2 Press the VCR button on your TV's remote control.
- 3 Press the SET button on your TV's remote control.
- 4 Using the number buttons on your remote control, enter three digits of the VCR code listed on page 45 of this manual for your brand of VCR. Make sure you enter three digits of the code, even if the first digit is a "0". (If more than one code is listed, try the first one.)
- 5 Press the POWER (⏻) button on the remote control. Your VCR should turn on if your remote is set up correctly.

If your VCR does not turn on after set-up, repeat steps 2, 3 and 4, but try one of the other codes listed for your brand of VCR. If no other codes are listed, try each VCR code, 000 through 080.

Note on Using Remote Control Modes: VCR

When your remote control is in "VCR" mode, the volume buttons still control your TV's volume.

Note

- When your remote control is in "VCR", "CABLE", or "DVD" mode, the VCR control buttons (REW, STOP, PLAY/PAUSE, and FF) still operate your VCR.

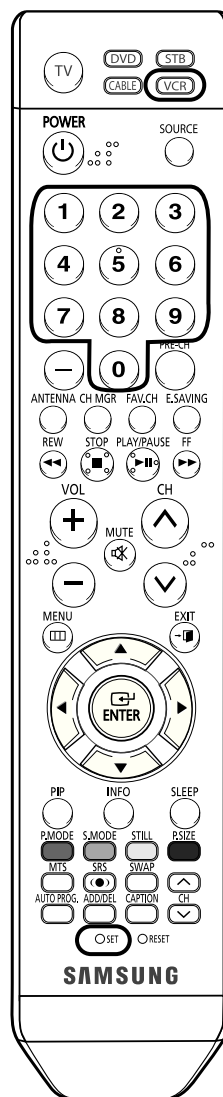

Setting Up the Remote to Operate Your Cable Box

- 1 Turn off your cable box.
- 2 Press the CABLE button on your TV's remote control.
- 3 Press the SET button on your TV's remote control.
- 4 Using the number buttons on your remote control, enter three digits of the cable box code listed on page 46 of this manual for your brand of cable box. Make sure you enter three digits of the code, even if the first digit is a "0". (If more than one code is listed, try the first one.)
- 5 Press the POWER (⏻) button on the remote control. Your cable box should turn on if your remote is set up correctly.

If your cable box does not turn on after set-up, repeat steps 2, 3 and 4, but try one of the other codes listed for your brand of cable box. If no other codes are listed, try each code, 000 through 046.

Note on Using Remote Control Modes: Cable Box

When your remote control is in "Cable" mode, the volume buttons still control your TV's volume.

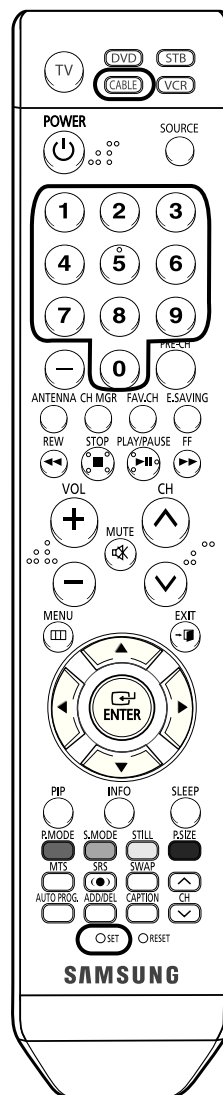

Setting Up the Remote to Operate Your DVD

- 1 Turn off your DVD.
 - 2 Press the DVD button on your TV's remote control.
 - 3 Press the SET button on your TV's remote control.
 - 4 Using the number buttons on your remote control, enter three digits of the DVD code listed on page 47 of this manual for your brand of DVD. Make sure you enter three digits of the code, even if the first digit is a "0". (If more than one code is listed, try the first one.)
 - 5 Press the POWER (⏻) button on the remote control. Your DVD should turn on if your remote is set up correctly.
- If your DVD does not turn on after set-up, repeat steps 2, 3 and 4, but try one of the other codes listed for your brand of DVD. If no other codes are listed, try each code, 000 through 141.

Note on Using Remote Control Modes: DVD

When your remote control is in "DVD" mode, the volume buttons still control your TV's volume.

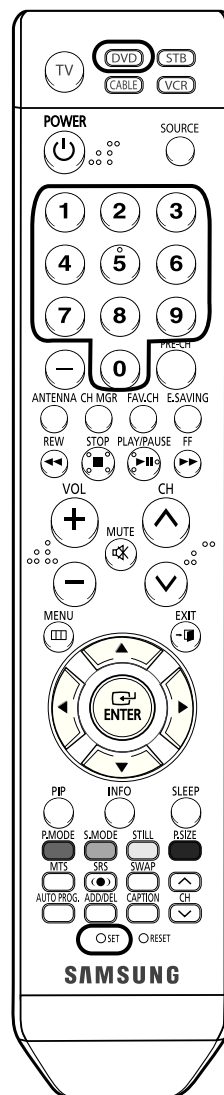

Setting Up the Remote to Operate Your Set Top Box

- 1 Turn off your STB.
- 2 Press the STB button on your TV's remote control.
- 3 Press the SET button on your TV's remote control.
- 4 Using the number buttons on your remote control, enter three digits of the STB code listed on page 46 of this manual for your brand of STB. Make sure you enter three digits of the code, even if the first digit is a "0". (If more than one code is listed, try the first one.)
- 5 Press the POWER (⏻) button on the remote control. Your STB should turn on if your remote is set up correctly.

If your STB does not turn on after set-up, repeat steps 2, 3 and 4, but try one of the other codes listed for your brand of STB. If no other codes are listed, try each code, 000 through 074.

Note on Using Remote Control Modes: STB

When your remote control is in "STB" mode, the volume buttons still control your TV's volume.

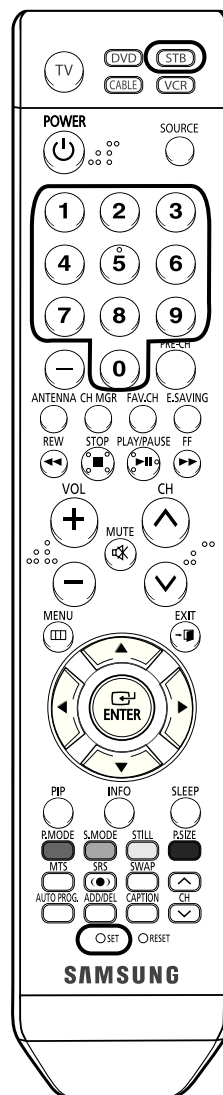

Remote Control Codes

VCR

Brand	Code
SAMSUNG	000 001 002 003 004 005 077 078 079
ADMIRAL	020
AIWA	025
AKAI	004 027 032
AUDIO DYNAMICS	007 026
BELL&HOWELL	018
BROKSONIC	022
CANDLE	002 003 006 008 015 055
CANON	021 056
CITIZEN	002 003 006 008 015 055
COLORTYME	007
CRAIG	002 024
CURTIS MATHES	002 007 008 017 021 025 056 064 066
DAEWOO	003 010 011 012 013 014 015 016
DB	007 026
DIMENSIA	017
DYNATECH	025
ELECTROHOME	034
EMERSON	001 003 006 021 022 025 030 032 034 040 047 050 052 060 063 065 066 067 069 073
FISHER	018 024 028 029 048 051 061
FUNAI	025
GENERAL ELECTRIC	002 005 017 021 056
GO VIDEO	002
LG(Goldstar)	006 007 008 009 010
HARMAN KARDON	007
HITACHI	019 025 041 042 074
INSTANT REPLAY	021
JC PENNEY	002 007 018 019 021 026 037 041 054 056
JCL	007 008 018 021 026 037
KENWOOD	007 008 018 026 037
KLH	070
LLOYD	025
LOGIK	038
LXI	025
JVC	081 082 083
MAGNAVOX	021 056 059
MARANTZ	007 008 018 021 026 037 062
MARTA	006
KONIA	036
ORION	073 074 075 076
MEI	021
MEMOREX	006 021 024 025
MGA	034
MIDLAND	005
MINOLTA	019 041 075

Brand	Code
mitsubishi	019 034 041 046
MONTGOMERY WARD	020
MTC	002 025
MULTITECH	002 005 025 038
NEC	007 008 018 026 037 062 064
OPTIMUS	020
PANASONIC	021 056 071 072
PENTAX	019 041 075
PENTEX RESEARCH+	008
PHILCO	021 056 059
PHILIPS	021 080
PIONEER	019 026 039 053
PORTLAND	015 049 055
PROSCAN	017
QUARTZ	018
QUASAR	021 056
RADIO SHACK/REALISTIC	006 018 020 021 024 025 029 034 048 056
RCA	002 017 019 021 035 041 043 057 068 076
SANSUI	026
SANYO	018 024
SCOTT	003 047 052 067
SEARS	006 018 019 024 028 029 041 048 051
SHARP	020 034 045 015
SHIMTOM	027 033 038 058
SIGNATURE	025
SONY	027 033 044
SYLVANIA	021 025 056 059
SYMPHONIC	025
TANDY	018 025
TASHIKA	006
TATUNG	037
TEAC	025 037 068
TECHNICS	021
TEKNIKA	006 021 025 031
TMK	066
TOSHIBA	003 019 029 051 052
TOTEVISION	002 006
UNITECH	002
VECTOR RESEARCH	007 026
VICTOR	026
VIDEO CONCEPTS	007 026
VIDEOSONIC	002
WARDS	002 003 006 019 020 021 024 025 034 038 041
YAMAHA	007 008 018 026 037
ZENITH	023 027 033

CABLE BOX

Brand	Code
SAMSUNG	000 001 002 003 004 005 006 007
GI	041
HAMLIN	003 024 031
HITACHI	025 030
JERROLD	038 039
MACOM	025 030
MAGNAVOX	019 023 028
OAK	026
PANASONIC	003 022 027 037 044
PHILIPS	019 021 023 028
PIONEER	004 018 020 044
RCA	014 022 040
REGAL	003

Brand	Code
REGENCY	015 023
SA	042 043
SCIENTIFIC ATLAN	042 043
SPRUCER	022
STARGATE 2000	036
SYLVANIA	016
TEXSCAN	016
TOCOM	032
UNIVERSAL	033 034
VIEWSTAR	019 021 023 028
WAMER AMEX	046
ZENITH	017 029 035 037 045

SAMSUNG SET-TOP BOX

Product	Code
Ground wave STB	001 002
Satellite STB	003
CABLE STB	004
STB DVD COMBO	008
Satellite STB HDD COMBO Standard	009

Product	Code
Satellite STB HDD COMBO Premium	010
CABLE STB HDD COMBO Standard	011
CABLE STB HDD COMBO Premium	012
Ground wave STB HDD COMBO Standard	013
Ground wave STB HDD COMBO Premium	014

SET-TOP BOX

Brand	Code
ALPHASTAR	023
ANAM	043
CHANNEL MASTER	018 034
CROSSDIGITAL	019
CHAPARRAL	035
DIRECT TV	015 016 017 019 022 045 060 061 062 065 066 067 068
DAEWOO	074
DISH NETWORK SYSTEM	069 070
DISHPRO	069
DRAKE	018 024 032
DX ANTENNA	027
ECHOSTAR	025 069 070 071
EXPRESSVU	069
GOI	069
GE	065
GENERAL INSTRUMENT	046 047 048 063 064
HTS	069
HOME CABLE	056
HITACHI	022
HUGHES NETWORK	015 017
IQ	020
IQ PRISM	020
JANEIL	059
JERROID	063
JVC	069 070

Brand	Code
LG(Goldstar)	044 073
MAGNAVOX	016 021 036 038 039 040 041 042
MEMOREX	016
MOTOROLA	064
MACOM	018
MITSUBISHI	015
NEXT LEVEL	047 048 064
PHILIPS	015 016 017 021 033 036 038 039 040 041 042 067
PRIMESTAR	046 049 050 063
PANASONIC	058 059 061 062
PAYSAT	016
PROSCAN	065 066
RCA	051 052 053 065 066
RADIOSHACK	064
REALISTIC	057
STS	020 027
STAR TRAK	026
SKY	031
SKY LIFE	005 006 007
SHACK	064
STAR CHOICE	064
SONY	054 060
TOSHIBA	015 017 028 029 030 072
ULTIMATE TV	060 066
UNIDEN	016 021 037 055 056 057
ZENITH	024 031 068

SAMSUNG DVD

Product	Code
DVD	000 001 002
DVDR	003 004
BD Record	005 006
VCR COMBO	007 008 009 010 011
VCR Record	012
DHR COMBO	013

Product	Code
Home Theater VCR COMBO	014 015 016
HDD Record COMBO	017
TWIN TRAY COMBO	018
STB DVD COMBO	019
DVD Receiver	020
AV Receiver	021

DVD

Brand	Code
ANAM	030
AUDIOVOX	075
AUDIOLOGIC	085
ANABA	072
APEX DIGITAL	070 071 074 086 083 084 088 111 112
AIWA	114
BROKSONIC	062
BLAUPUNKT	074
B&K	122 123
CURTIS MATHES	027
CYBER HOME	065 077 078 079 082
CLARION	080 125
CIRRUS	081
CINEVISION	095
DAEWOO	066
DENON	146
FARENHEIT	067 068
FISHER	090
GPX	060
GO VIDEO	061 089 133 135
GE	069 074
GREENHILL	074
HITACHI	064 113
HITEKER	071
HOYO	073
HARMAN / KARDON	091 110
IRT	089
INTEGRA	092
JBL	091
JVC	022 033 115 116
JATON	073
KENWOOD	051 108 109
KISS	073
KONKA	059 100 106 107
KLH	074 075
LG(Goldstar)	025 031
LOEWE	057
LASONIC	058
MOBILE AUTHORITY	054
MEMOREX	055
MALATA	056
MAGNAVOX	076 093
MINTEK	074 094
MONYKA	073

Brand	Code
NORCENT	048 049 050
NEXT BASE	052
NEC	053
NANTAU	144
NESA	074
OPTOMEDIA ELECTRONICS	105
OPTIVIEW	072
ONKYO	076 092 119
PHILCO	044 045
PRINCETON	046 047
PROSCAN	023
PANASONIC	024 034 124 134 136 137 138
PHILIPS	036 076
ROTEL	117 118
RIO	120
RCA	023 035 074 075 131 132
RAITE	073
ROWA	038
SAMPO	104
SONY	026 029 126 127 128 129 130 141
SHERWOOD	039 041
SVA	042
SYLVANIA	043 093
SHARP	140
SANSUI	062
SANYO	062
SHINSONIC	094
SANYO	090
THOMSON	145
TOSHIBA	028 062 076
TECHNICS	139
TVIEW	072
TOKAI	073
TEAC	096
TECHWOOD	097
TREDEX	098 099 101
URBAN CONCEPTS	076
VENTURER	075
VOCOPRO	102
YAMAHA	032 063
YAMAKAWA	040 073
XWAVE	103
ZENITH	076 121



Viewing an External Signal Source

Use the remote control to switch between viewing signals from connected equipment, such as VCR, DVD, Samsung Set-Top Box, and the TV source (broadcast or cable).

Setting the Signal Source

- 1 Press the MENU button.
Press the ENTER button to select "Input".
 - Quick way to access viewing an external signal source :
Just press "SOURCE" button on the remote control.



- 2 Press the ENTER button to select "Source List".

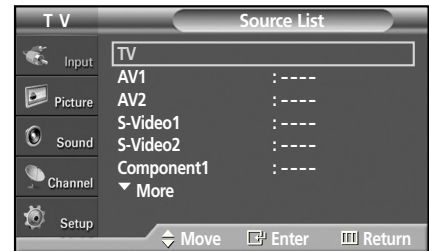

- 3 Press the ▲ or ▼ button to select signal source, then press the ENTER button.

Note

- Only connected devices can be selected.

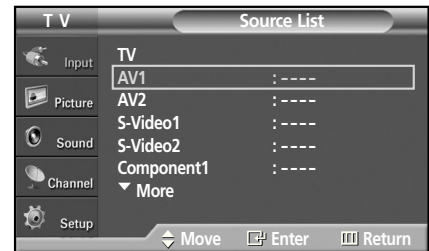

- 4 Press the EXIT button to exit.

Notes

- When you connect equipment to the TV, you can choose between the following sets of jacks: AV1, S-VIDEO1, COMPONENT1, COMPONENT2, PC, HDMI1, or HDMI2 on the TV's rear panel and AV2 or S-VIDEO2 on the TV's side panel.
- Before selecting an input source, connect an external device first.
- HDMI input can only be selected when the external device is turned on and connected via HDMI.

Assigning Names to External input mode

- 1 Press the MENU button.
Press the ENTER button to select "Input".



- 2 Press the ▲ or ▼ button to select "Edit Name", then press the ENTER button.



- 3 Press the ENTER button.
Press the ▲ or ▼ button to select external device, then press the ENTER button.
 - You can select the VCR, DVD, D-VHS, Cable STB, HD STB, Satellite STB, PVR STB, AV Receiver, DVD Receiver, Game, Camcorder, DVD Combo, PC, VOD STB, or TV.
 - Set other signal sources (AV2, S-Video1, S-Video2, Component1, Component2, PC, HDMI1, or HDMI2) using the same method as listed above.

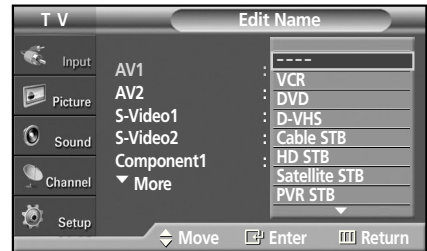

- 4 Press the EXIT button to exit.

S
A
M
S
U
N
G

P L A S M A D I S P L A Y P A N E L

Picture Control

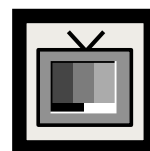

Changing the Picture Standard	52
Customizing the Picture Settings	53
DNLe (Digital Natural Image engine)	55
Changing the Screen Size	56
Viewing the Picture-in-Picture.....	58
Selecting the Sound Source	64

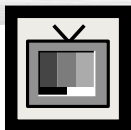

Changing the Picture Standard

You can select the type of picture which best corresponds to your viewing requirements.

- 1 Press the MENU button. Press the ▲ or ▼ button to select "Picture", then press the ENTER button.

➤ Quick way to access the picture setting: Just press "P.MODE" button on the remote control.

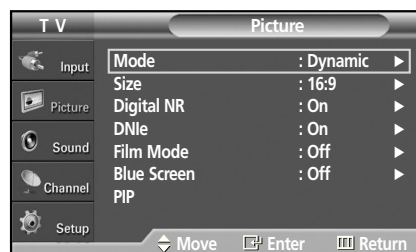

- 2 Press the ENTER button again to select "Mode".

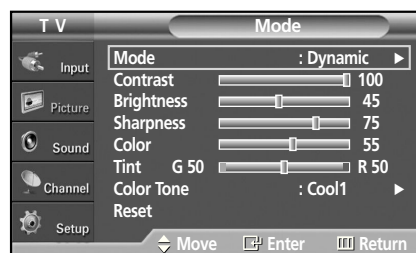

- 3 Press the ENTER button. Press the ▲ or ▼ button to select the desired picture mode (Dynamic, Standard, Movie, Custom), then press the ENTER button.



- 4 Press the EXIT button to exit.

- Choose Dynamic for viewing the TV during the day or when there is bright light in the room.
- Choose Standard for the standard factory settings.
- Choose Movie when viewing the movie.
- Choose Custom if you want to adjust the settings according to personal preference (see "Customizing the Picture Settings", page 53).

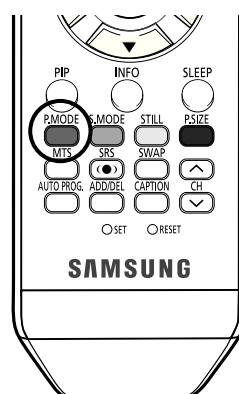

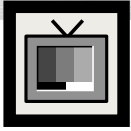

Customizing the Picture Settings

You can use the on-screen menus to change the "Contrast", "Brightness", "Sharpness", "Color", "Tint", and "Color Tone" according to personal preference. You can select "Standard" which automatically recalls your personalized picture settings.

- 1 Press the MENU button. Press the ▲ or ▼ button to select "Picture", then press the ENTER button.

➤ Quick way to access the picture setting: Just press "P.MODE" button on the remote control.

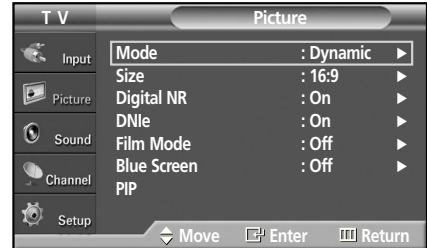

- 2 Press the ENTER button to select "Mode".



- 3 Press the ENTER button. Press the ▲ or ▼ button to select the desired picture mode (Dynamic, Standard, Movie, Custom), then press the ENTER button.

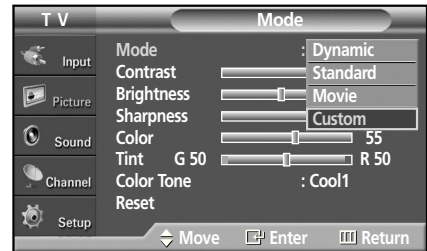

- 4 Press the ▲ or ▼ button to select a particular option (Contrast, Brightness, Sharpness, Color, or Tint), then press the ENTER button.

Press the ◀ or ▶ button to decrease or increase the value of a particular item.

- You can also select these options (Contrast, Brightness, Sharpness, Color, or Tint) by pressing the ▲ or ▼ button.

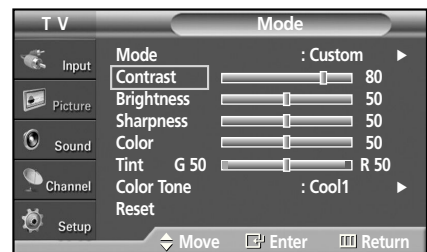

Continued...

Notes

- "Tint" doesn't operate in PC, HDMI or any Component mode.
- The Tint cannot be adjusted while watching Digital TV.
- In PC mode, only the Contrast and Brightness can be selected.

- 5 Press the ENTER button to return to "Mode".
Press the ▲ or ▼ button to select "Color Tone", then press the ENTER button.

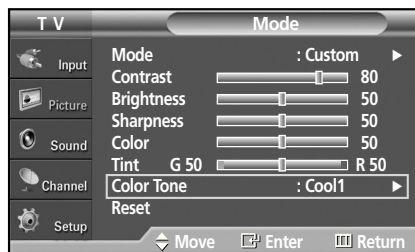

- 6 Press the ▲ or ▼ button to select a particular option (Cool2, Cool1, Normal, Warm1, or Warm2), then press the ENTER button.



Resetting the Picture Settings to the Factory Defaults

- 7 To return the factory defaults, select "Reset" by pressing the ▲ or ▼ button.
Press the ENTER button.

- The previously adjusted settings will be reset to the factory defaults.

Press the EXIT button to exit.

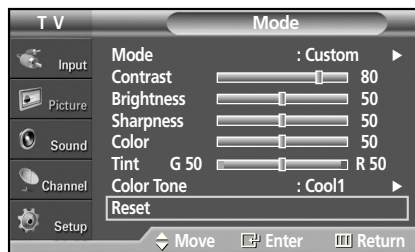

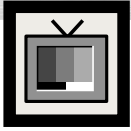

DNle (Digital Natural Image engine)

This TV includes the DNle function so as to provide a high visual quality.

If you set DNle to On, you can view the applied DNle and normal pictures on the screen,

for demonstration purposes. Using this function, you can view the difference in the visual quality.

- 1 Press the MENU button. Press the ▲ or ▼ button to select "Picture", then press the ENTER button.

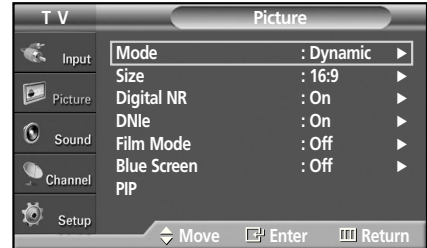

- 2 Press the ▲ or ▼ button to select "DNle", then press the ENTER button.

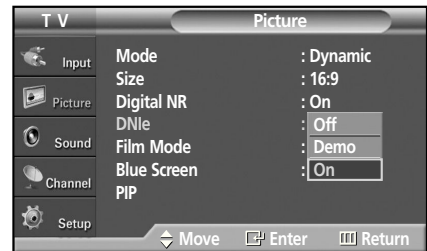

- 3 Press the ▲ or ▼ button to select "Off", "Demo" or "On", then press the ENTER button.

- Off : Switches off the DNle mode.
- Demo : The screen before applying DNle appears on the left and the screen after applying DNle appears on the right.
- On : Switches on the DNle mode.

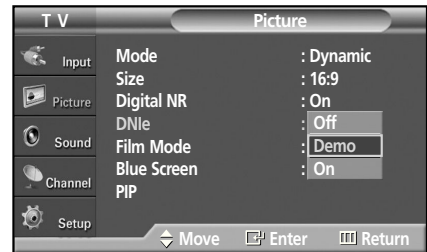

- 4 Press the EXIT button to exit.

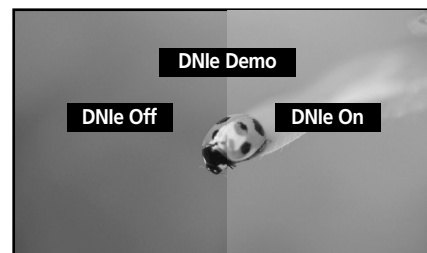

Notes

- DNle™ (Digital Natural Image engine) **DNle™**
This feature brings you a more detailed image with 3D noise reduction and detail, contrast and white enhancement.
- The DNle function is not supported in the Movie mode. (It is inactivated.)

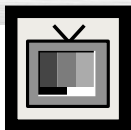

Changing the Screen Size

Screen size selection depends on the type of video input.

- 1 Press the MENU button. Press the ▲ or ▼ button to select "Picture", then press the ENTER button.

➤ Quick way to change the Screen size: Just press P.SIZE button on the remote control.

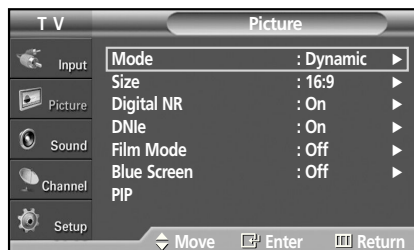

- 2 Press the ▲ or ▼ button to select "Size", then press the ENTER button.

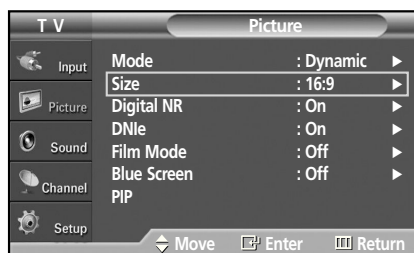

- 3 Press the ▲ or ▼ button to select the screen size you want, then press the ENTER button.

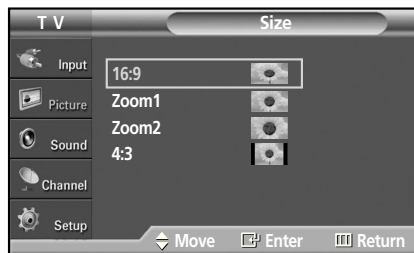

- 4 Press the EXIT button to exit.

Notes

- If you watch a still image or the 4:3 (Normal) mode for a long time (over 2 hours), an image may be burned onto the screen.
- View the TV in 16:9 (Wide) mode as much as possible.
- 16:9 : Sets the picture to 16:9 wide mode.
- Zoom1 : Magnifies the size of the picture on the screen.
- Zoom2 : Expands the Zoom1 format picture.
- 4:3 : Sets the picture to 4:3 normal mode.

Plasma Display

When you press the P.SIZE button on the remote control, the TV's screen mode should appear in sequence. The screen displays in this order: 16:9, Zoom1, Zoom2, 4:3.

Note

- If you watch a still image or the 4:3 mode for a long time (over 2 hours), an image may be burned onto the screen. View the TV in 16:9 mode as much as possible.

16:9

Sets the picture to 16:9 wide mode.

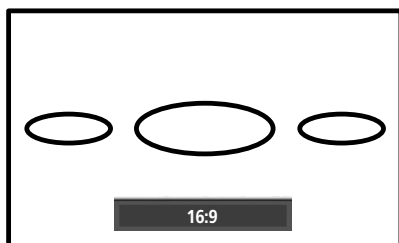

Zoom1

The screen size when Wide screen is vertically enlarged.

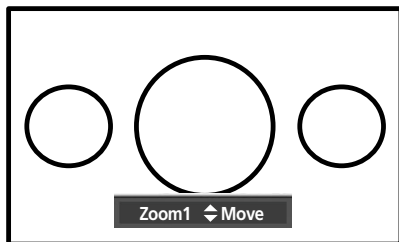

Zoom2

The screen size when the Zoom1 screen is vertically enlarged.

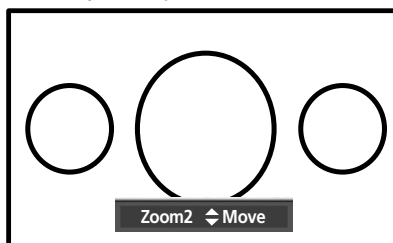

4:3

Sets the picture to 4:3 normal mode.

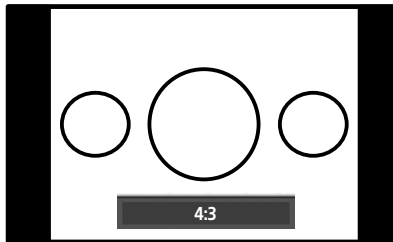

Notes

- In TV, VIDEO, S-VIDEO, and COMPONENT(480i, 480p) modes, all screen modes can be selected. (16:9 → Zoom1 → Zoom2 → 4:3).
- In TV(DTV), COMPONENT(720p, 1080i), PC, HDMI modes, only 16:9 & 4:3 modes can be selected.
- In Zoom1 and Zoom2 modes, you can move the picture on screen by pressing the ▲ or ▼ button.

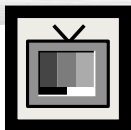

Viewing the Picture-in-Picture

Selecting the PIP Screen

1 Press the MENU button. Press the ▲ or ▼ button to select "Picture", then press the ENTER button.

- Quick way to access the PIP mode: Just press "PIP" button on the remote control.

2 Press the ▲ or ▼ button to select "PIP", then press the ENTER button.

3 Press the ENTER button, then press the ▲ or ▼ button to select "On". The PIP image will appear in the corner of the screen.

- Pressing the ▲ or ▼ button will alternate between "On" and "Off".

Note

- If the PIP On/Off does not function, check if the V-Chip Lock (refer to page 125) is On. PIP does not function when the V-Chip Lock is set to On. Change the setting to Off and try it again.

4 Press the EXIT button to exit.

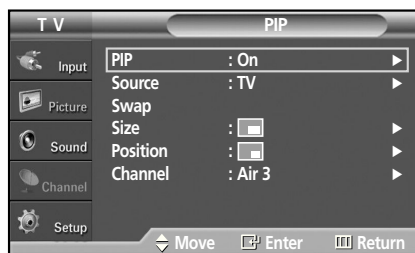
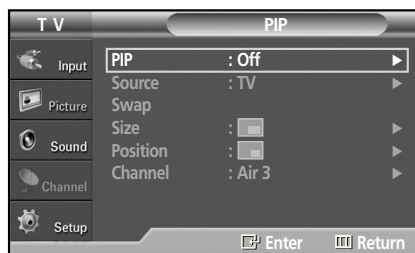
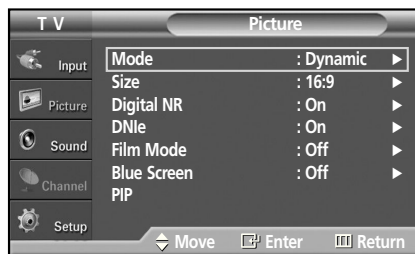

PIP Settings

A : Analog O : PIP and swap operate
D : Digital X : PIP doesn't operate

PIP screen Main screen		TV		AV1(A)	S-Video(A)	Component(A)	PC	HDMI(D)
		Analog	Digital (ATSC)					
TV	Analog	X		X	X	X	X	O
	Digital (ATSC)			O	O	O	X	X
AV1(A)		X	O	X	X	X	X	O
S-Video(A)		X	O	X	X	X	X	O
Component(A)		X	O	X	X	X	X	O
PC		O	X	O	X	X	X	X
HDMI(D)		O	X	O	O	O	X	X

Notes

- This TV has only one tuner and does not allow you to watch one TV channel in the main screen and another channel in the PIP screen.
- An external component must be connected for PIP to operate.

Selecting an External Signal

You can use PIP to view a signal from an external source, such as a VCR.

- 1 Press the MENU button. Press the ▲ or ▼ button to select "Picture", then press the ENTER button.

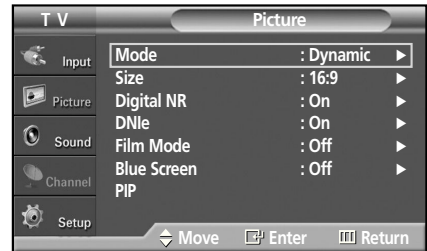

- 2 Press the ▲ or ▼ button to select "PIP", then press the ENTER button.

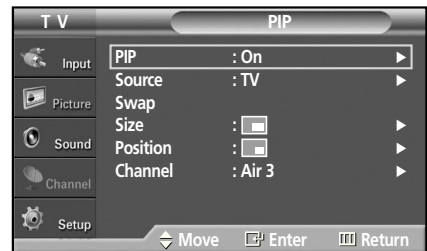

- 3 Press the ▲ or ▼ button to select "Source", then press the ENTER button.

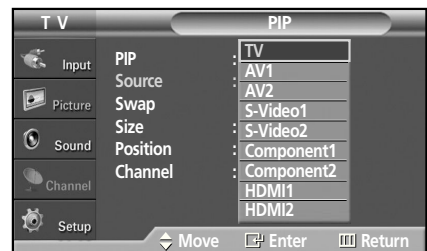

- 4 Press the ▲ or ▼ button to cycle through all of the available signal sources:
"TV", "AV1", "AV2", "S-Video1", "S-Video2",
"Component1", "Component2", "HDMI1", or "HDMI2".

The signal from these inputs will not appear if you have not connected any equipment to the TV's respective input jacks.

- 5 Press the EXIT button to exit.

Notes

- The same source cannot be selected on both the main and sub screens. However, the same source can be selected on both the main and sub screens for TV.
- PC is not available in PIP picture.

Swapping the Contents of the PIP and Main Image

1 Press the MENU button. Press the ▲ or ▼ button to select "Picture", then press the ENTER button.

- Quick way to access the Swap mode: Just press "SWAP" button on the remote control.

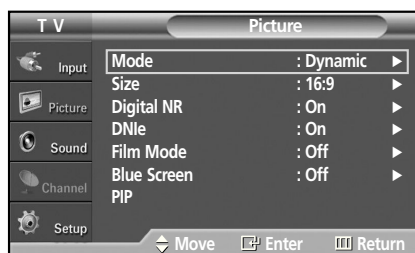

2 Press the ▲ or ▼ button to select "PIP", then press the ENTER button.

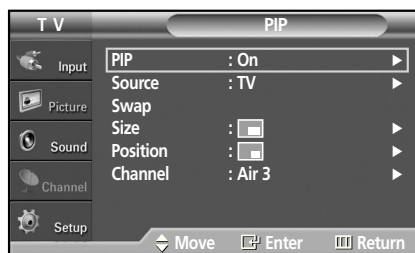

3 Press the ▲ or ▼ button to select "Swap", then press the ENTER button.

- The image in the PIP window will appear on the main screen, and vice versa. (Refer to page 58)

Note

- If main picture is in PC mode, Swap is not available.

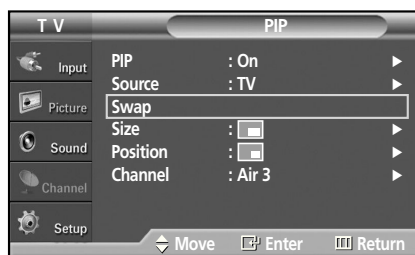

4 Press the EXIT button to exit.

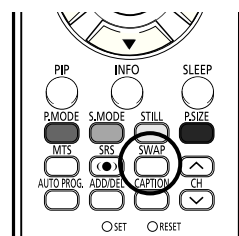

Changing the Size of the PIP Window

1 Press the MENU button. Press the ▲ or ▼ button to select "Picture", then press the ENTER button.

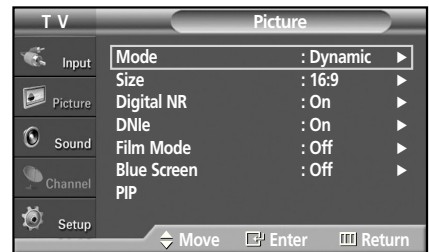

2 Press the ▲ or ▼ button to select "PIP", then press the ENTER button.

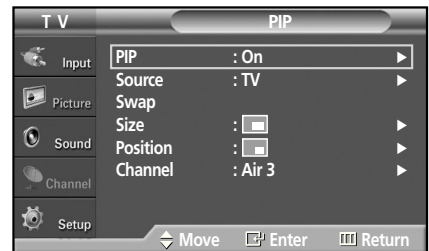

3 Press the ▲ or ▼ button to select "Size", then press the ENTER button.

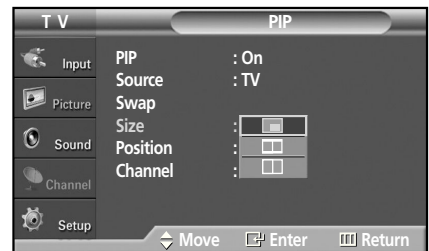

4 Press the ▲ or ▼ button to select option you want, then press the ENTER button.

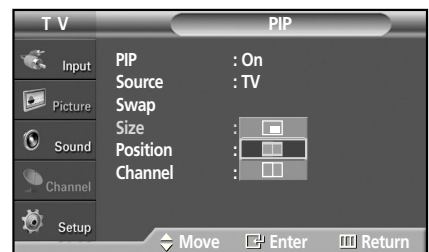

5 Press the EXIT button to exit.

Note

- If main picture is in PC mode, Size is not available.

Changing the Location of the PIP Image

1 Press the MENU button. Press the ▲ or ▼ button to select "Picture", then press the ENTER button.

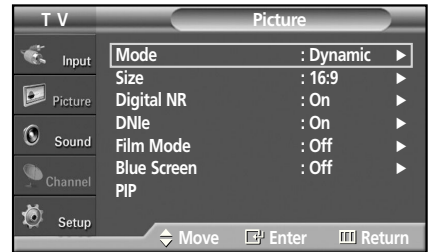

2 Press the ▲ or ▼ button to select "PIP", then press the ENTER button.

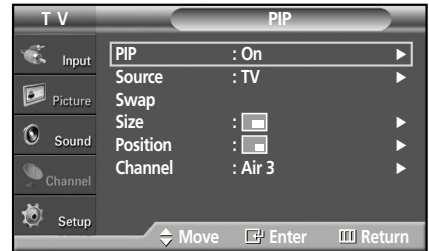

3 Press the ▲ or ▼ button to select "Position", then press the ENTER button.

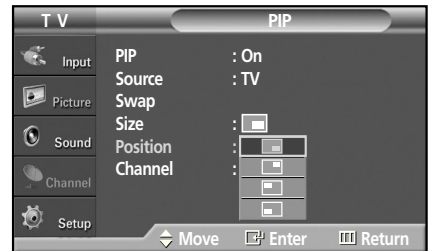

4 Press the ▲ or ▼ button to select the PIP position you want, then press the ENTER button.

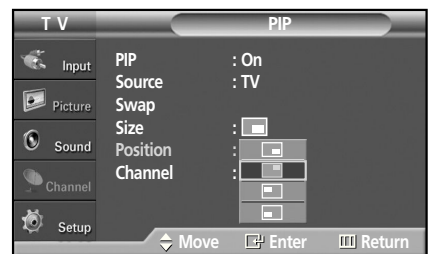

5 Press the EXIT button to exit.

Note

- In Double Window ([]) and Double Wide ([]) modes, Position cannot be selected.

Changing the PIP Channel

1 Press the MENU button. Press the ▲ or ▼ button to select "Picture", then press the ENTER button.

➤ Quick way to change the PIP channel: Just press the PIP "CH ▲" or "CH ▼" button at the bottom of the remote control.

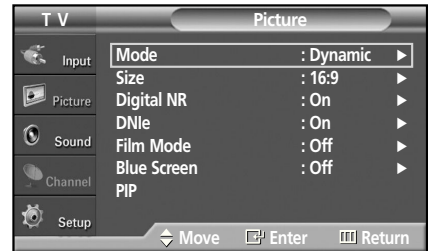

2 Press the ▲ or ▼ button to select "PIP", then press the ENTER button.

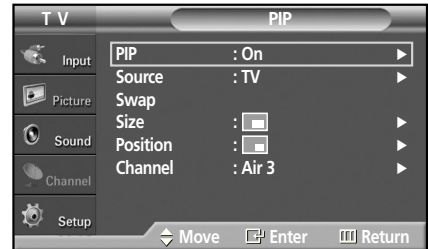

3 Press the ▲ or ▼ button to select "Channel", then press the ENTER button.

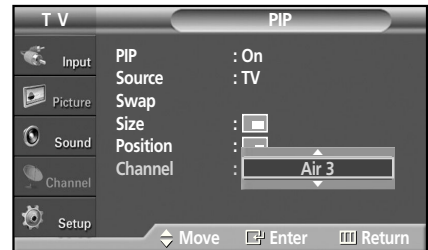

4 Press the ▲ or ▼ button to change the channel that appears in the PIP window.

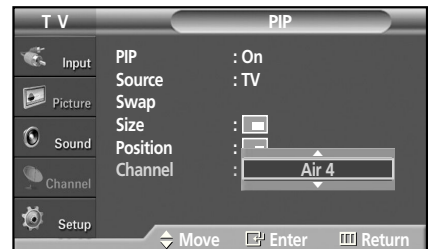

5 Press the EXIT button to exit.

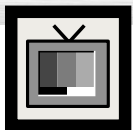

Selecting the Sound Source

You can use this feature to hear sound from the main or sub (PIP) picture.

- 1 Press the MENU button. Press the ▲ or ▼ button to select "Sound", then press the ENTER button.

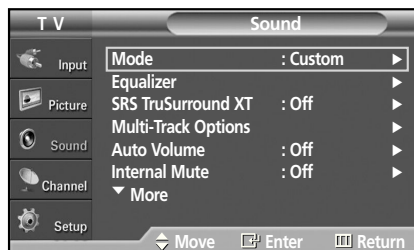

- 2 Press the ▲ or ▼ button to select "Sound Select", then press the ENTER button.

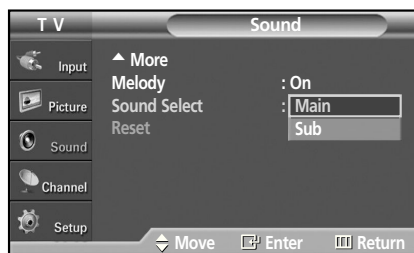

- 3 Press the ▲ or ▼ button to select "Main" or "Sub", then press the ENTER button.

- 4 Press the EXIT button to exit.

P L A S M A D I S P L A Y P A N E L

Sound Control



Customizing the Sound	66
Using Automatic Sound Settings	67
Setting the TruSurround XT	68
Choosing a Multi-Channel Sound (MTS) track - Digital.....	69
Choosing a Multi-Channel Sound (MTS) track - Analog	70
Using the Auto Volume.....	71
Setting the On/Off Melody	72
Selecting the Internal Mute	73
Sound Reset	74



Customizing the Sound

The sound settings can be adjusted to suit your personal preference.
(Alternatively, you can use one of the "automatic" settings. See next page.)

- 1 Press the MENU button. Press the ▲ or ▼ button to select "Sound", then press the ENTER button.

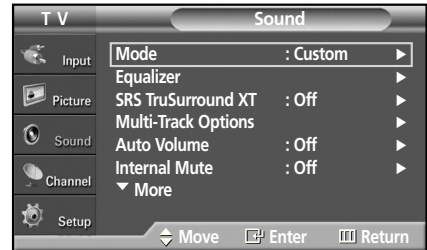

- 2 Press the ▲ or ▼ button to select "Equalizer", then press the ENTER button.

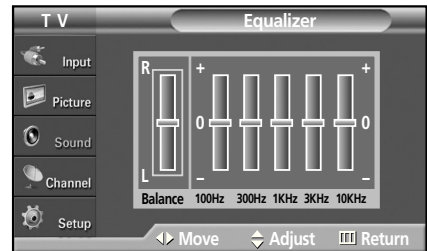

- 3 Press the ◀ or ▶ button to select a particular frequency to adjust. Press the ▲ or ▼ button to increase or decrease the level of the particular frequency.

- 4 Press the EXIT button to exit.

Notes

- If you make any changes to the equalizer settings, the sound mode is automatically switched to the custom mode.
- L/R Sound Balance Adjustment
To adjust the sound balance of the L/R speakers.
- Bandwidth Adjustment (100Hz, 300Hz, 1KHz, 3KHz, 10KHz)
To adjust the level of different bandwidth frequencies.



Using Automatic Sound Settings

Your TV has automatic sound settings ("Standard", "Music", "Movie", and "Speech") that are preset at the factory. Or, you can select "Custom," which automatically recalls your personalized sound settings.

1 Press the MENU button. Press the ▲ or ▼ button to select "Sound", then press the ENTER button.

➤ Quick way to access the sound setting: Just press "S.MODE" button on the remote control.

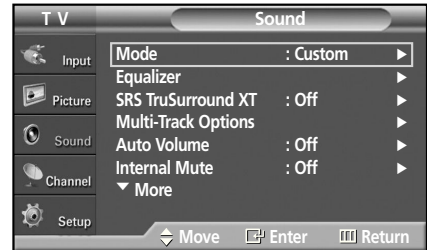

2 Press the ENTER button to select "Mode".

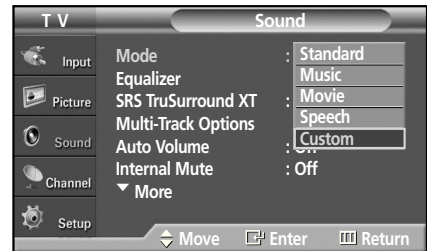

3 Press the ▲ or ▼ button to select "Standard", "Music", "Movie", "Speech", or "Custom" sound setting, then press the ENTER button.

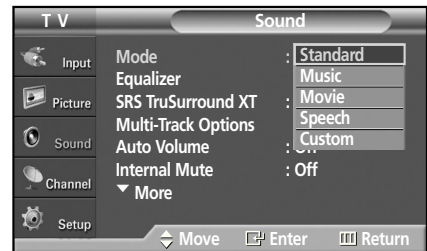

4 Press the EXIT button to exit.

- Choose Standard for the standard factory settings.
- Choose Music when watching music videos or concerts.
- Choose Movie when watching movies.
- Choose Speech when watching a show that is mostly dialog (i.e., news).
- Choose Custom to recall your personalized settings (see "Customizing the Sound", page 66).



Setting the TruSurround XT

TruSurround XT is a patented SRS technology that solves the problem of playing 5.1 multichannel content over two speakers. TruSurround delivers a compelling, virtual surround sound experience through any two-speaker playback system, including internal television speakers. It is fully compatible with all multichannel formats.

- 1 Press the MENU button. Press the ▲ or ▼ button to select "Sound", then press the ENTER button.

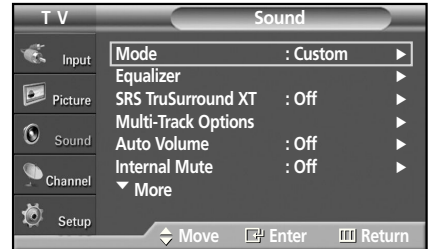

- 2 Press the ▲ or ▼ button to select "SRS TruSurround XT", then press the ENTER button.

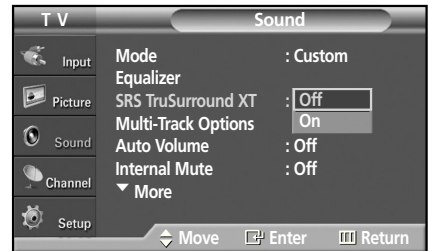

- 3 Press the ▲ or ▼ button to change the setting (Off or On), then press the ENTER button.

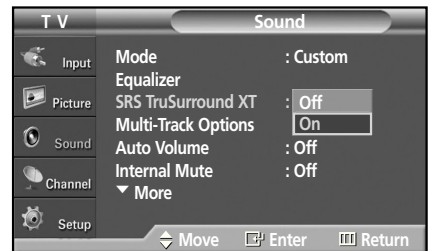

- 4 Press the EXIT button to exit.

Alternate method:

Press the SRS button on the remote control repeatedly to select "Off" or "On".





Choosing a Multi-Channel Sound (MTS) track - Digital

The digital-TV transmission system is capable of simultaneous transmission of many audio tracks (for example, simultaneous translations of the program into foreign languages). The availability of these additional "multitracks" depends upon the program.

1 Press the MENU button. Press the ▲ or ▼ button to select "Sound", then press the ENTER button.

➤ Quick way to access the MTS menu: Just press "MTS" button on the remote control. You can listen in a language other than the favorite language by pressing the MTS button.

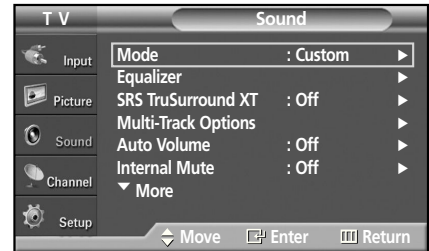

2 Press the ▲ or ▼ button to select "Multi-Track Options", then press the ENTER button.



3 Press the ENTER button to select "Preferred Language". Press the ▲ or ▼ button to choose the language (English, Spanish, or French) you want, then press the ENTER button.



4 Press the EXIT button to exit.

Note

- You can only select the language from among the actual languages broadcast by the broadcasting station.



Choosing a Multi-Channel Sound (MTS) track - Analog

Depending on the particular program being broadcast, you can listen to Mono, Stereo or SAP.

1 Press the MENU button. Press the ▲ or ▼ button to select “Sound”, then press the ENTER button.

➤ Quick way to access the MTS menu: Just press “MTS” button on the remote control repeatedly to select one of the settings.

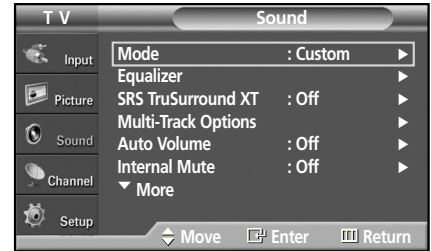

2 Press the ▲ or ▼ button to select “Multi-Track Options”, then press the ENTER button.



3 Press the ENTER button to select “Multi-Track Sound”. Press the ▲ or ▼ button to select a setting you want, then press the ENTER button.



4 Press the EXIT button to exit.

- Choose “Mono” for channels that are broadcasting in mono, or if you are having difficulty receiving a stereo signal.
- Choose “Stereo” for channels that are broadcasting in stereo.
- Choose “SAP” to listen to the Separate Audio Program, which is usually a foreign-language translation.



Using the Auto Volume

Each broadcasting station has its own signal conditions, which can make it necessary to adjust the volume every time the channel is changed. "Auto Volume" lets you automatically adjust the volume of the desired channel by lowering the sound output when the modulation signal is high or by raising the sound output when the modulation signal is low.

- 1 Press the MENU button. Press the ▲ or ▼ button to select "Sound", then press the ENTER button.

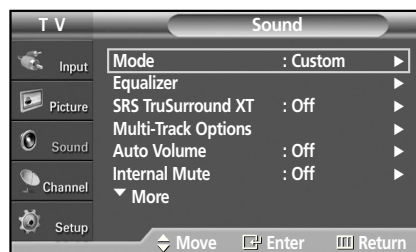

- 2 Press the ▲ or ▼ button to select "Auto Volume", then press the ENTER button.

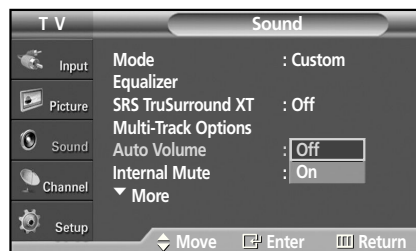

- 3 Press the ▲ or ▼ button to select "On", then press the ENTER button.

- Pressing the ▲ or ▼ button will alternate between "On" and "Off".

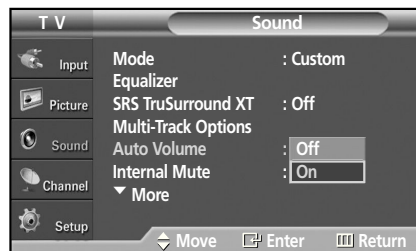

- 4 Press the EXIT button to exit.



Setting the On/Off Melody

A melody sound can be set to come on when the TV is powered On or Off.

- 1 Press the MENU button. Press the ▲ or ▼ button to select "Sound", then press the ENTER button.

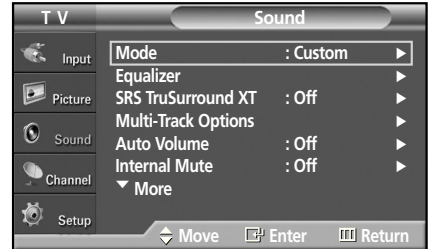

- 2 Press the ▲ or ▼ button to select "Melody", then press the ENTER button. Press the ▲ or ▼ button to select "On" or "Off", then press the ENTER button.



- 3 Press the EXIT button to exit.



Selecting the Internal Mute

Sound output from the TV speakers is muted.

- 1 Press the MENU button. Press the ▲ or ▼ button to select "Sound", then press the ENTER button.

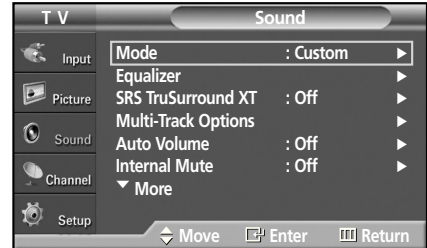

- 2 Press the ▲ or ▼ button to select "Internal Mute", then press the ENTER button.



- 3 Press the ▲ or ▼ button to select "On", then press the ENTER button.

- Pressing the ▲ or ▼ button will alternate between "On" and "Off".

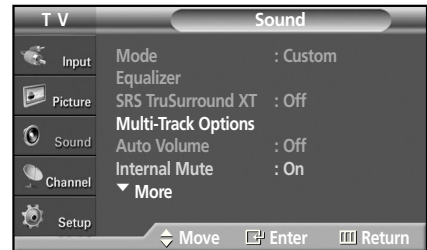

- 4 Press the EXIT button to exit.

Notes

- When Internal Mute is set to "On", Sound menus except Multi-track Options cannot be adjusted.
- The left/right audio outputs and digital audio outputs (Optical, Coaxial) remain enabled.
- The VOL +, VOL - and Mute buttons do not operate when the Internal Mute is set to On.
- When Internal Mute is On, only MTS is selectable for the Sound.



Sound Reset

If Game Mode is On (Refer to page 108), the Reset Sound function is activated. Selecting the Reset function after setting the equalizer resets the equalizer to the factory defaults.

- 1 Press the MENU button. Press the ▲ or ▼ button to select "Sound", then press the ENTER button.

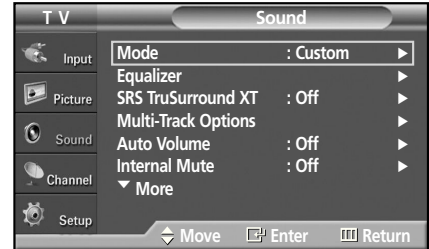

- 2 Press the ▲ or ▼ button to select "Reset", then press the ENTER button.

- The equalizer resets the equalizer setting to the factory defaults.

< If Game Mode is On >



- 3 Press the EXIT button to exit.

P L A S M A D I S P L A Y P A N E L

Channel Control



Selecting the Antenna	76
Selecting Your Favorite Channels	77
Viewing the Channel Lists	79
Editing the Channel Lists	80
Default List mode	82
Labeling the Channels	83
Fine Tuning Analog Channels	84
Checking the Digital-Signal Strength	85
LNA (Low Noise Amplifier)	86



Selecting the Antenna

1 Press the MENU button. Press the ▲ or ▼ button to select "Channel", then press the ENTER button.

➤ Quick way to select Antenna: Just press "ANTENNA" button on the remote control.

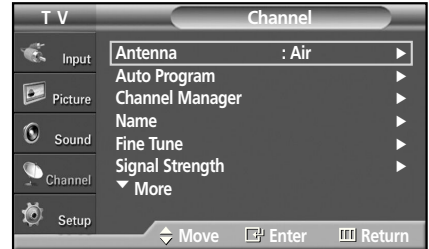

2 Press the ENTER button to select "Antenna". Press the ▲ or ▼ button to select "Air" or "Cable", then press the ENTER button.

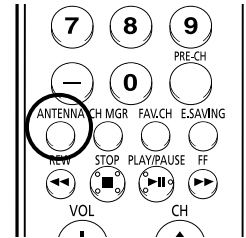
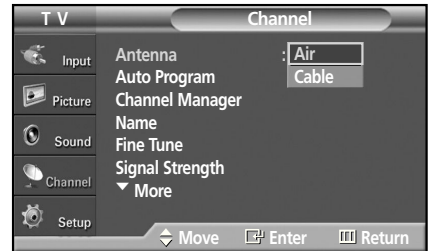

Notes

- If the antenna is connected to ANT 1 IN (CABLE), select "CABLE" and if it is connected to ANT 2 IN (AIR), select "Air".

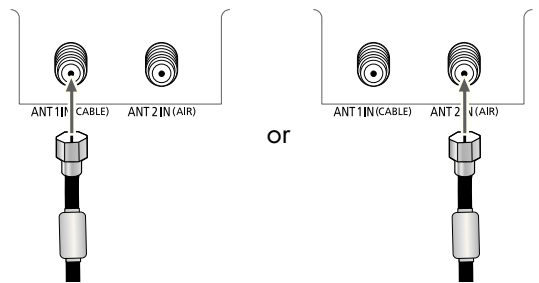

- If both ANT 1 IN and ANT 2 IN are connected, select the antenna input you want. If the antenna input is not selected properly, noise may appear on the screen.

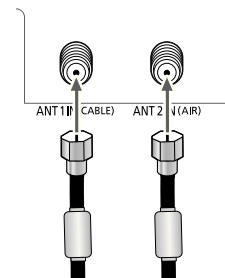



Selecting Your Favorite Channels

You can store your favorite channels for each available input source (such as TV and Cable box). Then, when you press the FAV.CH button on the remote control, the TV displays only the favorite channels you previously stored, allowing you to quickly and easily find frequently watched channels.

Preset:

- To use the Channel Manager function, first run Auto program (see page 37).

To Store Your Favorite Channels:

- Press the MENU button.
Press the ▲ or ▼ button to select "Channel", then press the ENTER button.
- Press the ▲ or ▼ button to select "Channel Manager", then press the ENTER button.
- Press the ▲ or ▼ button to select "All" or "Added", then press the ENTER button.
Press the ▲/▼/◀/▶ button to select a channel, then press the ENTER button and an option window will appear.

- All: All of the memorized channels
- Added : Added channels

- Press the ▲ or ▼ button to select "Favorite", then press the ENTER button and a ♥ mark is activated.
Press the ENTER button again to deselect the selected channel and the ♥ mark is deactivated.

- Red button (List Mode) : If you press the Red button repeatedly, the All Channel List, the Added Channel List or the Favorite Channel List is selected sequentially.
- Yellow button : Press to delete all channels memorized.

- Press the EXIT button to exit.

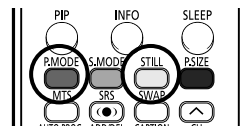
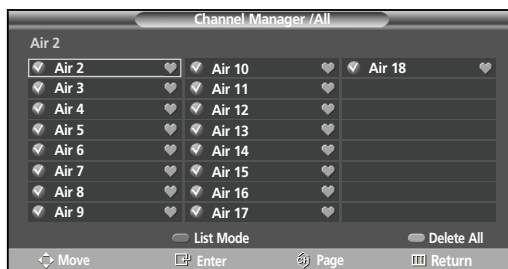
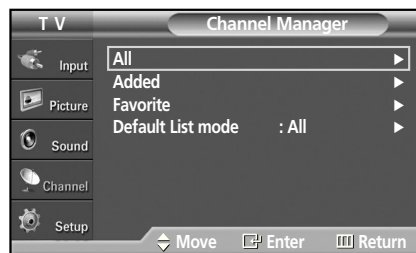
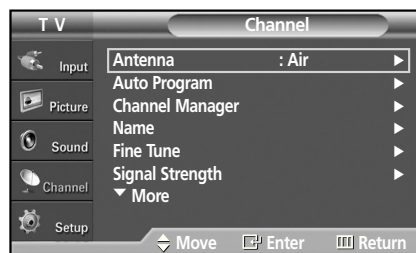

Note

- Only memorized channels can be set as favorite channels.

To View Your Favorite Channels list:

- 1 Press the MENU button.
Press the ▲ or ▼ button to select "Channel", then press the ENTER button.

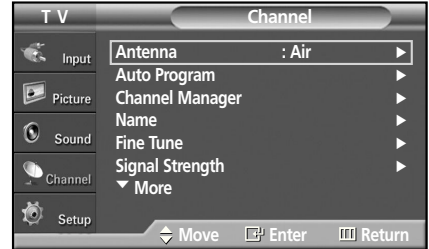

- 2 Press the ▲ or ▼ button to select "Channel Manager", then press the ENTER button.

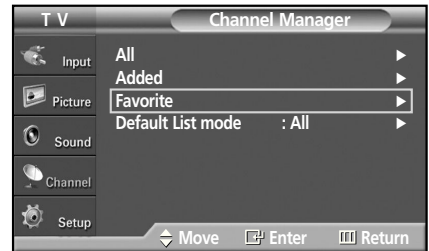

- 3 Press the ▲ or ▼ button to select "Favorite", then press the ENTER button.

- The favorite channel list will appear.

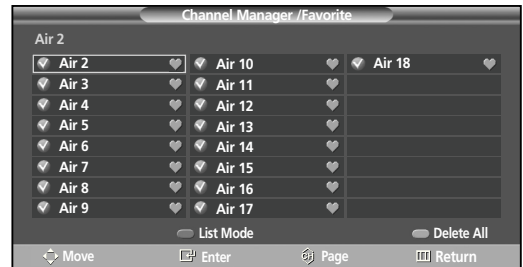

- 4 Press the EXIT button to exit.

Note

- Watch, Add, Delete, or Favorite setting on the channel is available in the Favorite channel list.

To watch Favorite channels :

Press the FAV.CH button repeatedly to jump from one favorite channel to another.

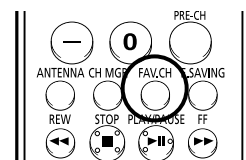



Viewing the Channel Lists

You can display a list of all channels or your favorite channels.

Preset:

- To use the Channel Manager function, first run Auto Program (see page 37).

- Press the MENU button.
Press the ▲ or ▼ button to select "Channel", then press the ENTER button.

► Quick way to view the Channel Lists: Just press "CH MGR" button on the remote control.

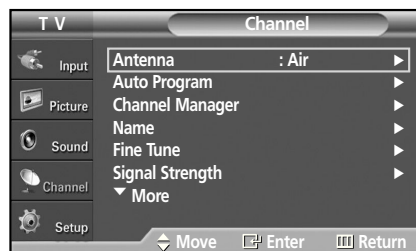

- Press the ▲ or ▼ button to select "Channel Manager", then press the ENTER button.

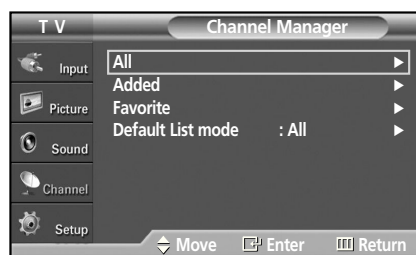

- Press the ENTER button to select "All".
If you want to watch the channel, press the ▲/▼/◀/▶ buttons to select a channel, then press the ENTER button and the option window will appear.

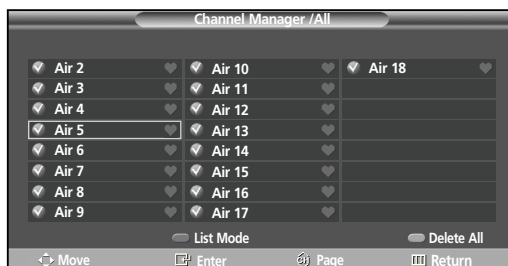

- Press the ENTER button to select "Watch".
The selected channel broadcasting window will appear.

- Red button (List Mode) : If you press the Red button repeatedly, the All Channel List, the Added Channel List or the Favorite Channel List is selected sequentially.
- Yellow button : Press to delete all channels memorized.

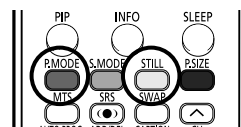

Alternate method :

Press the CH MGR button on the remote control to display a list of channels.

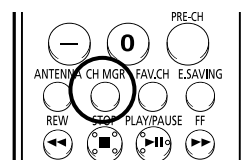



Editing the Channel Lists

You can edit channels to be added or deleted.

Preset:

- To use the Channel Manager function, first run Auto Program (see page 37).

- 1 Press the MENU button.
Press the ▲ or ▼ button to select "Channel", then press the ENTER button.

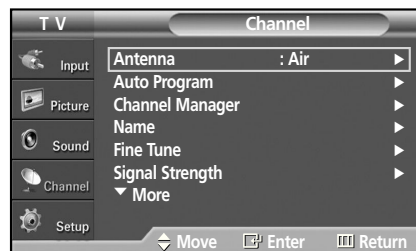

- 2 Press the ▲ or ▼ button to select "Channel Manager", then press the ENTER button.

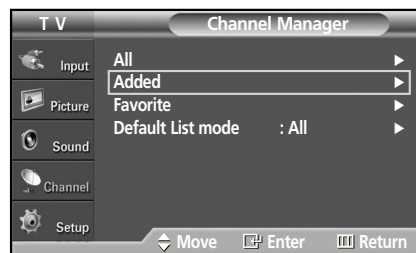

- 3 Press the ▲ or ▼ button to select "Added", then press the ENTER button.
 - All channels on the Channel Manager are added and displayed.

Press the ▲/▼/◀/▶ button to select a channel, then press the ENTER button and an option window will appear.

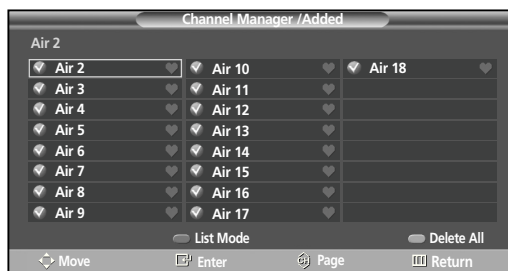

Continued...

4 Press the ▲ or ▼ button to select “Delete” if you want to delete a channel, then press the ENTER button; the ✓ mark will disappear. To select the deselected channel, select “Add” to add a channel by pressing the ▲ or ▼ button. The ✓ mark will appear.

- Red button (Channel Mode) : If you press the Red button repeatedly, the All Channel List, the Added Channel List or the Favorite Channel List is selected sequentially.
- Yellow button : Press to delete all channels memorized.

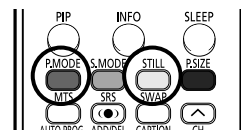

5 Press the EXIT button to exit.

Alternate method :

Press the ADD/DEL button on the remote control. Press the CH ▲ and CH ▼ button to select the channel to be added or deleted, then press the ENTER button.

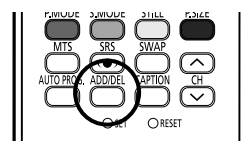
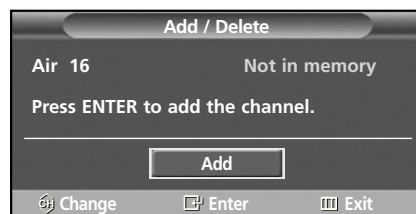



Default List mode

Press the CH MGR button on the remote control and set the channel list format for the default channels.

Select the mode you want among ALL, Added, and Favorite in Default List and press CH MGR button on the remote control. The channel you set from Default List mode displays on the screen. (Ex. if you select Favorite in Default List mode and press CH MGR button, Favorite Channel Manager displays on the screen.)

- 1 Press the MENU button.
Press the ▲ or ▼ button to select "Channel", then press the ENTER button.

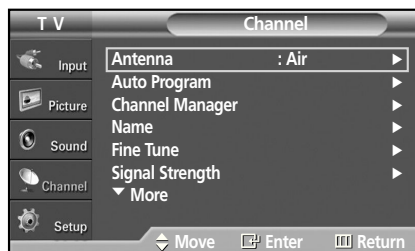

- 2 Press the ▲ or ▼ button to select "Channel Manager", then press the ENTER button.

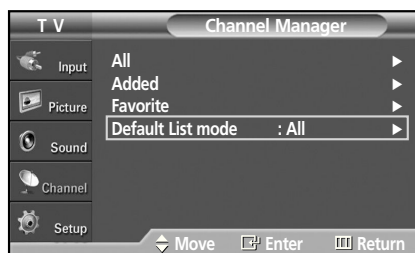

- 3 Press the ▲ or ▼ button to select "Default List mode", then press the ENTER button.
Press the ▲ or ▼ button to select "All", "Added", or "Favorite", then press the ENTER button.

- All: All of the memorized channels
- Added : Added channels
- Favorite : Favorite channels

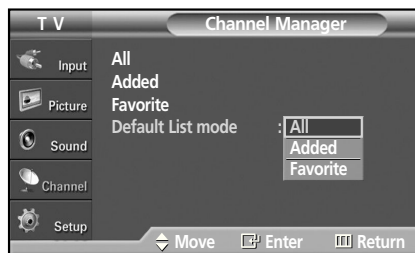

- 4 Press the CH MGR button on the remote control, then Default List mode will be displayed.

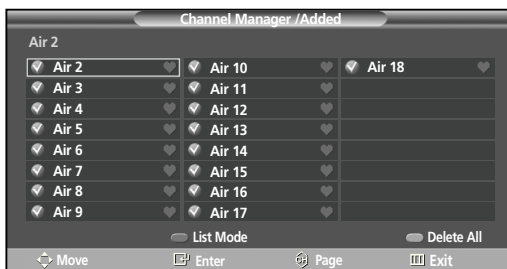

- 5 Press the EXIT button to exit.

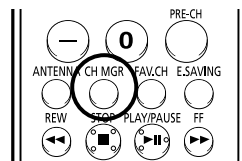

CH

Labeling the Channels

Use this feature to assign an easy-to-remember label to any channel (i.e., "CBS", "ESPN", "PBS2", "CNN1", etc.) A label consists of five fields, where each field is a letter, a number or a blank. When the INFO button is pressed, the channel label will appear next to the channel number.

- 1 Press the MENU button.
Press the ▲ or ▼ button to select "Channel", then press the ENTER button.

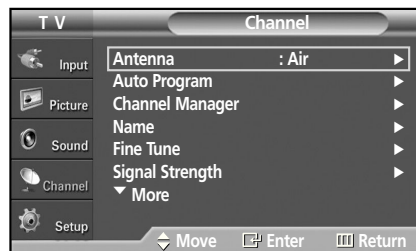

- 2 Press the ▲ or ▼ button to select "Name", then press the ENTER button.

Press the ▲ or ▼ button to select the channel to be assigned a new name, then press the ENTER button.

Press the ▲ or ▼ button to select a letter, a number or a blank (Results in this sequence: A...Z, 0...9, +, -, *, /, blank).

Press the ► button to switch to the next field, which will be selected.

Select a second letter or digit by pressing the ▲ or ▼ button, as above.

Repeat the process to select the last three digits.

When you have finished, press the ENTER button to assign the new name.

- To clear the entered channel name, move to "Clear" by using the ◀/▶ button and press ENTER.

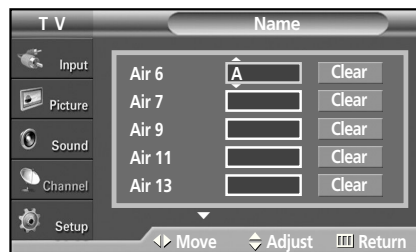

- 3 Press the EXIT button to exit.

Note

- The names of digital broadcasting channels are automatically assigned and thus cannot be assigned by users.



Fine Tuning Analog Channels

Use fine tuning to manually adjust a particular channel for optimal reception.

- 1 Press the MENU button. Press the ▲ or ▼ button to select "Channel", then press the ENTER button.

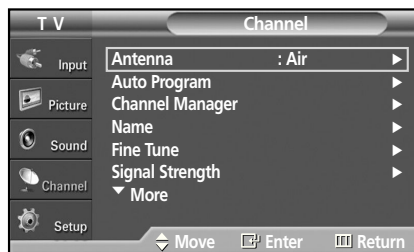

- 2 Press the ▲ or ▼ button to select "Fine Tune", then press the ENTER button.



- 3 Press the ◀ or ▶ button to adjust the fine tuning. To store the fine tuning setting in the TV's memory, press the ENTER button.



- 4 To reset the fine tuning setting, press the ▼ button to select "Reset", then press the ENTER button.

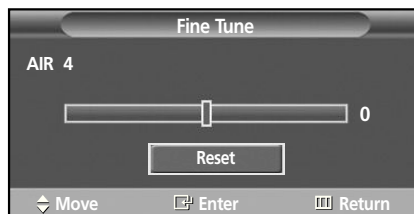

- 5 Press the EXIT button to exit.

Notes

- Only analog TV channels can be fine tuned.
- "*" will appear next to the name of fine-tuned channels.



Checking the Digital-Signal Strength

Unlike analog channels, which can vary in reception quality from “snowy” to clear, digital (HDTV) channels have either perfect reception quality or you will not receive them at all. So, unlike analog channels, you cannot fine tune a digital channel. You can, however, adjust your antenna to improve the reception of available digital channels.

- 1 Press the MENU button.
Press the ▲ or ▼ button to select “Channel”, then press the ENTER button.

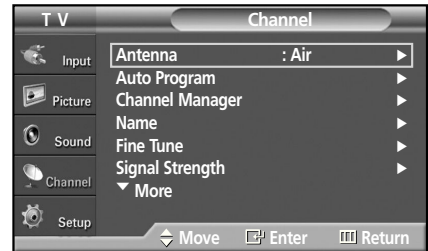

- 2 Press the ▲ or ▼ button to select “Signal Strength”, then press the ENTER button.

If the signal strength meter indicates that the signal is weak, physically adjust your antenna to increase the signal strength.

Continue to adjust the antenna until you find the best position with the strongest signal.

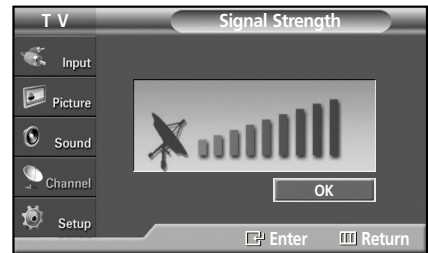

- 3 Press the EXIT button to exit.



LNA (Low Noise Amplifier)

If the TV is operating in a weak-signal area, sometimes the LNA function can improve the reception (a low-noise preamplifier boosts the incoming signal).

- 1 Press the MENU button. Press the ▲ or ▼ button to select "Channel", then press the ENTER button.



- 2 Press the ▲ or ▼ button to select "LNA", then press the ENTER button.



- 3 Press the ▲ or ▼ button to select "On" or "Off", then press the ENTER button.



- 4 Press the EXIT button to exit.

Notes

- LNA functions only when antenna is set to AIR or CABLE. (See "Selecting the Antenna" on page 76.)
- If the picture is noisy with the LNA set to On, select Off.
- The LNA setting must be made separately for each channel.

S
V
W
S
U
N
G

P L A S M A D I S P L A Y P A N E L

Connecting a PC and Operation



Connecting a PC.....	88
Changing the Position of the Image.....	92
Picture Quality Adjustment	93
Image Reset	95



Connecting a PC

Connection to a Macintosh computer may require an adapter.

TV Rear Panel

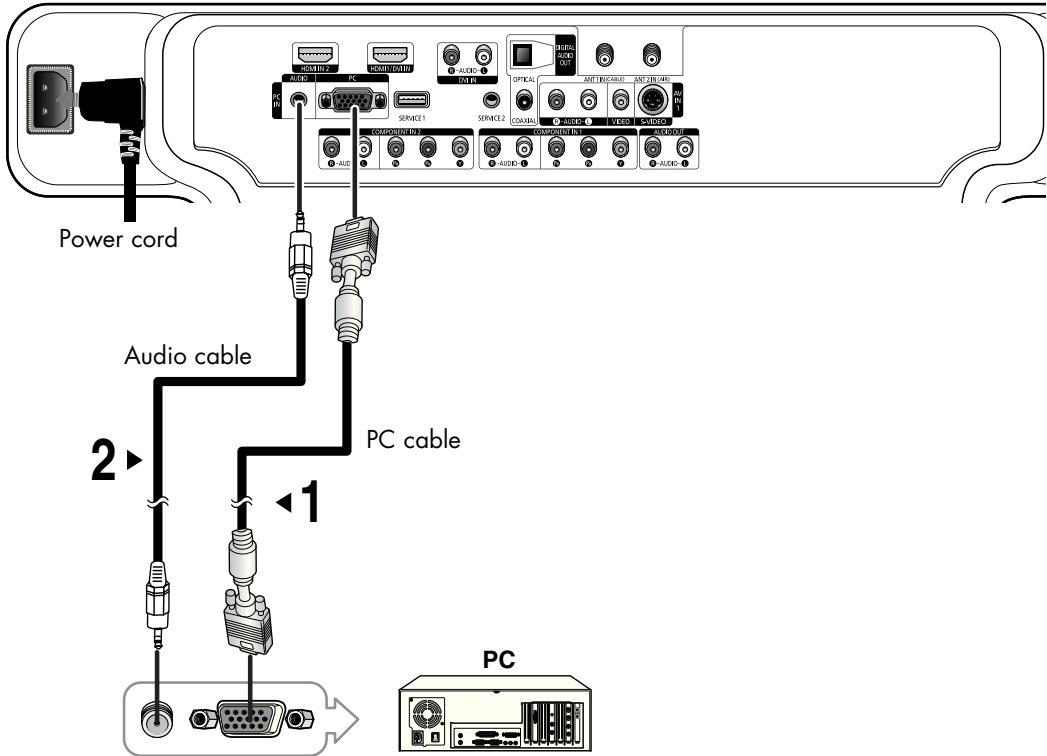

Connecting a PC (15p D-SUB) to the TV

- 1 Connect a PC cable between the PC Output jack on the PC and the RGB input jack (PC IN) on the TV.
- 2 Connect a Audio cable between the Audio jack on the PC and the Audio input jacks (PC AUDIO IN) on the TV.

Notes

- Please be sure to match the color coded input terminals and cable jacks.
- A PC will not operate when connected to the TV with a HDMI/DVI cable.

To watch the PC screen:

1. Turn on your TV.
2. Press the SOURCE button on the remote control or SOURCE button on the side panel to select "PC".
3. Turn on your PC and check for PC system requirements. (Refer to pages 90 and 91 for PC system requirements.)
4. Adjust the PC screen. (Refer to pages 92 to 94.)

Setting up Your TV (Plug and Play)

Our adoption of the new VESA® Plug and Play solution eliminates complicated and time consuming setup. It allows you to install your monitor in a Plug and Play compatible system, without the usual setup hassles and confusion. Your PC system can easily identify and configure itself for use with your TV. This TV automatically tells the PC system its Extended Display Identification data (EDID) using Display Data Channel (DDC) protocols.

How to Set up Your PC Software (Windows only)

The Windows display-settings for a typical computer are shown below. But the actual screens on your PC will probably be different, depending upon your particular version of Windows and your particular video card. But even if your actual screens look different, the same, basic set-up information will apply in almost all cases. (If not, contact your computer manufacturer or Samsung Dealer.)

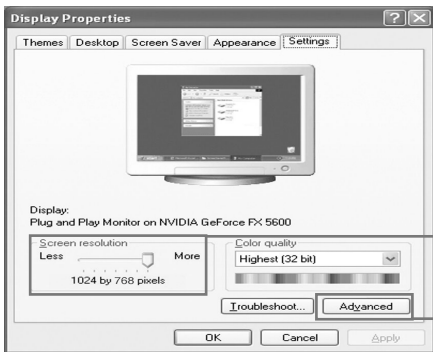

2

3



4

5

1. Right click the mouse on the Windows Desktop, then click on Properties. The Display Dialog-Box will be displayed.
2. Click on Settings, then set the Display Mode by referencing the Display Modes Table. You do not need to change the Colors settings.
3. Click on Advanced. A new settings dialog box will be displayed.
4. Click on the Monitor tab, then set the Screen Refresh Rate with reference to the Display Modes Table (see page 91). Set the Vertical Frequency and Horizontal Frequency individually if you can do so instead of setting the Screen Refresh Rate.
5. Press the OK button, close the window, then press the OK button on the Display Registration Information window. Automatic re-booting may commence at this moment.
6. Shutdown the PC, and connect it to your TV. (See page 88)

- The actual screens on your PC may look different, depending on your particular version of Windows and the type of your PC.
- When you use your TV as a PC monitor, it supports Colors up to 32 bits.
- The display on the TV may look different depending on your particular version of Windows or the PC manufacturer.
- When connecting a PC you must set it to the display settings that are supported by the TV. Otherwise, the message "Out of input range" will be displayed.

Continued...

Plasma Display

Note

Both screen position and size will vary, depending on the type of PC monitor and its resolution. The table below shows all of the display modes that are supported:

Video Signal	Resolution (Dot X Line)	Vertical Frequency (Hz)	Horizontal Frequency (KHz)	Vertical Polarity	Horizontal Polarity	HP-S4253	HP-S5053
IBM PC / AT Compatible	640 X 350	70.086	31.469	N	P	✓	✓
	720 X 400	70.087	31.469	P	N	✓	✓
	640 X 480	59.940	31.469	N	N	✓	✓
		70.000	35.000	N/P	N/P	✓	✓
		72.809	37.861	N	N	✓	✓
		75.000	37.500	N	N	✓	✓
	800 X 600	56.250	35.156	N/P	N/P	✓	✓
		60.317	37.879	P	P	✓	✓
		70.000	43.750	N/P	N/P	✓	✓
		72.188	48.077	P	P	✓	✓
		75.000	46.875	P	P	✓	✓
	1024 X 768	60.004	48.363	N	N	✓	✓
		70.069	56.476	N	N	✓	✓
		72.000	57.672	N/P	N/P	✓	✓
		75.029	60.023	P	P	✓	✓
	1280 X 720	59.855	44.772	P	N		✓
	1360 X 768	60.015	47.712	P	P		✓

- The interlace mode is not supported.
- The TV operates abnormally if a non-standard video format is selected.
- The table above conforms to IBM/VESA regulations and is based on using the Analog Input.
- A "✓" mark means that this mode can be supported.

Notes

- The PC text quality of HP-S4253 is optimum in XGA mode (1024 x 768@60Hz).
- The PC text quality of HP-S5053 is optimum in WXGA mode (1360 x 768@60Hz).
- When this TV is used as a PC display, 32-bit color is supported.
- Depending on the manufacturer, your PC display screen might appear different. (and depending on your particular version of Windows.)
Check your PC instruction book for information about connecting your PC to a TV.
- If a vertical and horizontal frequency-select mode exists, select 60Hz (vertical) and 48.4KHz (horizontal).
- In some cases, abnormal signals (such as stripes) might appear on the TV screen when the PC power is turned off (or if the PC is disconnected). If so, press the SOURCE button on the remote control or SOURCE button on the side panel to enter a VIDEO mode. Also, make sure that the PC is connected.



Changing the Position of the Image

After connecting the TV to your PC, adjust the position of the screen if it is not well-aligned.

Preset:

- Press the SOURCE button to select "PC."

1 Press the MENU button. Press the ▲ or ▼ button to select "Setup", then press the ENTER button.

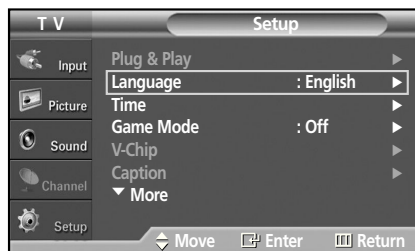

2 Press the ▲ or ▼ button to select "PC", then press the ENTER button.

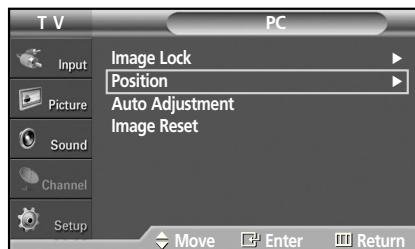

3 Press the ▲ or ▼ button to select "Position", then press the ENTER button.

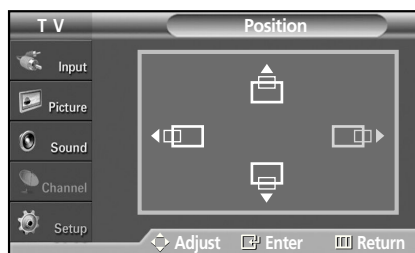

4 Adjust the position of screen by pressing the ▲/▼/◀/▶ button.

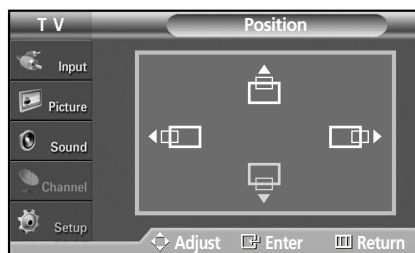

5 Press the EXIT button to exit.



Picture Quality Adjustment

Picture Automatic Adjustment

Preset:

- Press the SOURCE button to select "PC".

1 Press the MENU button. Press the ▲ or ▼ button to select "Setup", then press the ENTER button.



2 Press the ▲ or ▼ button to select "PC", then press the ENTER button.

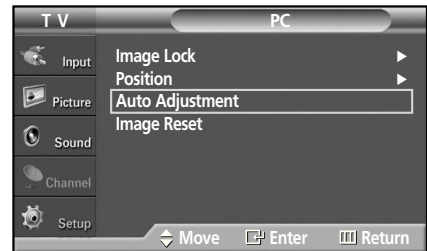

3 Press the ▲ or ▼ button to select "Auto Adjustment", then press the ENTER button. The message "Auto Adjustment in progress. Please wait." appears on the screen and the picture adjustments are automatically activated.

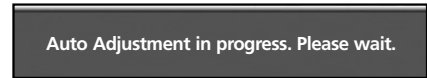

Press the EXIT button to exit.

Coarse and Fine Tuning (Fine) Adjustment

The purpose of picture quality adjustment is to remove or reduce picture noise. If the noise is not removed by fine tuning alone, then do the frequency adjustments to the utmost and fine tune again. After the noise has been reduced, re-adjust the picture so that it is aligned on the center of screen.

Preset:

- Press the SOURCE button to select "PC".

1 Press the MENU button. Press the ▲ or ▼ button to select "Setup", then press the ENTER button.

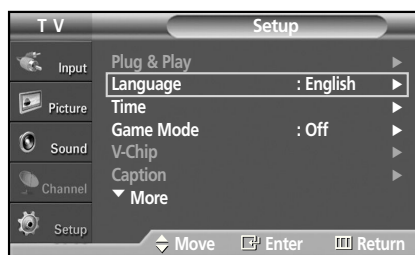

2 Press the ▲ or ▼ button to select "PC", then press the ENTER button.

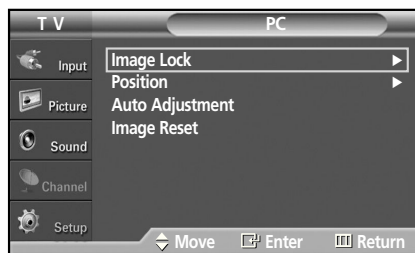

3 Press the ENTER button to select "Image Lock".

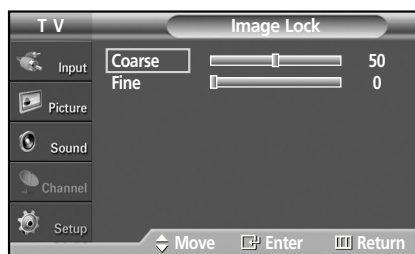

4 Press the ▲ or ▼ button to select "Coarse" or "Fine", then press the ENTER button. Press the ◀ or ▶ button to remove the picture noise.

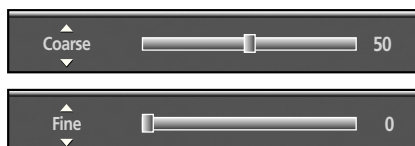

5 Press the EXIT button to exit.

Note

- This feature may change the width of the image. If necessary, adjust the position to center.



Image Reset

The Image Reset feature resets all settings to the factory defaults.

Preset:

- Press the SOURCE button to select "PC".

1 Press the MENU button. Press the ▲ or ▼ button to select "Setup", then press the ENTER button.



2 Press the ▲ or ▼ button to select "PC", then press the ENTER button.

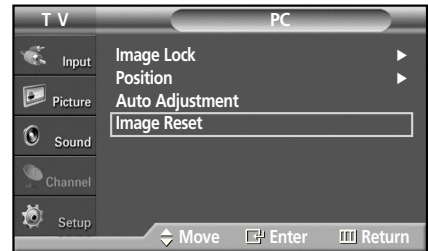

3 Press the ▲ or ▼ button to select "Image Reset", then press the ENTER button. The message "Image Reset is completed." appears on the screen.

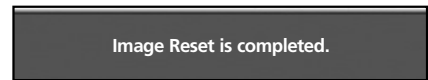

- The previously adjusted settings will be reset to the factory defaults.

Press the EXIT button to exit.

P L A S M A D I S P L A Y P A N E L

Time Setting



Setting the Clock.....	98
Setting the On/Off Timer	100
Setting the Sleep Timer	101



Setting the Clock

Setting the clock is necessary in order to use the various timer features of the TV. Also, you can check the time while watching the TV. (Just press the INFO button.)

Option 1: Setting the Clock Manually

1 Press the MENU button. Press the ▲ or ▼ button to select "Setup", then press the ENTER button.

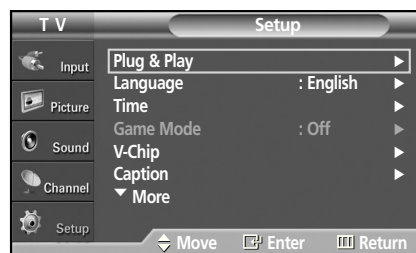

2 Press the ▲ or ▼ button to select "Time", then press the ENTER button. Press the ENTER button to select "Clock".

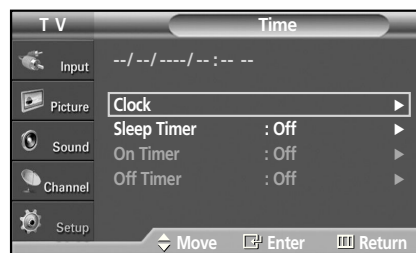

3 Press the ENTER button to select "Clock Mode". Press the ▲ or ▼ button to select "Manual", then press the ENTER button.

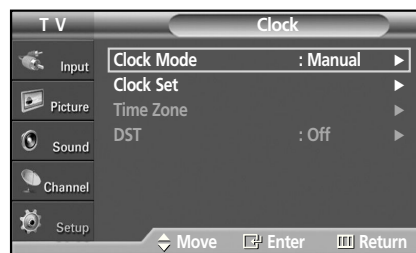

4 Press the ▲ or ▼ button to select "Clock Set", then press the ENTER button.

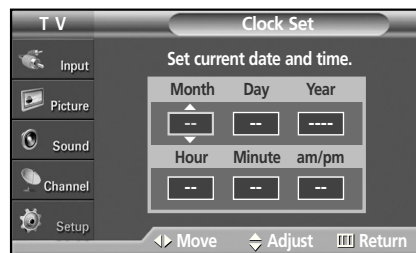

5 Press the ◀ or ▶ button to move to "Month", "Day", "Year", "Hour", "Minute", or "am/pm". Set the clock you want by pressing the ▲ or ▼ button, then press the ENTER button.

6 Press the EXIT button to exit.

Notes

- The current time will appear every time you press the INFO button.
- You can set the Month, Day, Year, Hour and Minute directly by pressing the number buttons on the remote control.

Option 2: Setting the Clock Automatically

The Clock can be set automatically if you are receiving a digital signal.

1 Press the MENU button.
Press the ▲ or ▼ button to select "Setup", then press the ENTER button.

2 Press the ▲ or ▼ button to select "Time", then press the ENTER button.
Press the ENTER button to select "Clock".

3 Press the ENTER button to select "Clock Mode".
Press the ▲ or ▼ button to select "Auto", then press the ENTER button.

4 Press the ▲ or ▼ button to select "Time Zone", then press the ENTER button.

Press the ▲ or ▼ button to highlight the time zone for your local area (and to move the highlight to the appropriate time zone on the map of the United States), then press the enter button.

5 Press the ▲ or ▼ button to select "DST" (Daylight Saving Time), then press the ENTER button.
Press the ▲ or ▼ button to select "On" or "Off", then press the ENTER button.

6 Press the EXIT button to exit.

Note

- Depending on the broadcast station and signal, the auto time may not be set correctly. If this occurs, set the time manually.

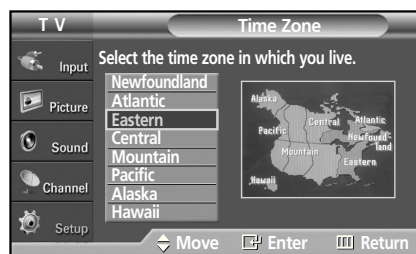
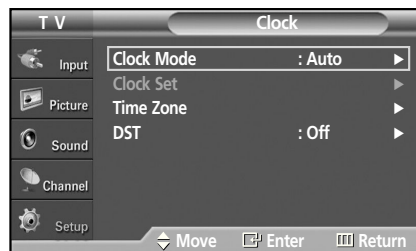
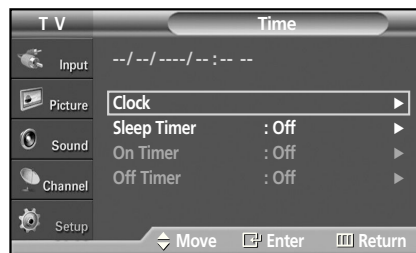
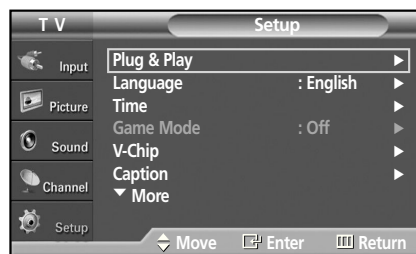



Setting the On/Off Timer

You can preset a time to turn the TV On or Off.

1 Press the MENU button.
Press the ▲ or ▼ button to select "Setup", then press the ENTER button.

2 Press the ▲ or ▼ button to select "Time", then press the ENTER button.

Press the ▲ or ▼ button to select "On Timer", then press the ENTER button.
Press the ▲ or ▼ button to adjust "Hour", then press the ► button to move to the next step.
Set other items using the same method as above.

To activate "On Timer" with the setting entered, set Activation to "Yes" by pressing ▲ or ▼ button.

When finished, press the MENU button to return.

- You can set the hour, minute and channel directly by pressing the number buttons on the remote control.

3 Press the ▲ or ▼ button to select "Off Timer", then press the ENTER button.
Press the ▲ or ▼ button to adjust "Hour", then press the ► button to move to the next step.
Set other items using the same method as above.

To activate "Off Timer" with the setting entered, set Activation to "Yes" by pressing ▲ or ▼ button.

When finished, press the ENTER button.

- You can set the hour and minute directly by pressing the number buttons on the remote control.

4 Press the EXIT button to exit.

Note

• Auto Power Off

When you set the timer "On", the television will eventually turn off, if no controls are operated for 3 hours after the TV was turned on by the timer.
This function is only available in timer "On" mode and prevents overheating or leakage, which may occur if a TV is on for too long (when you are on vacation, for example).

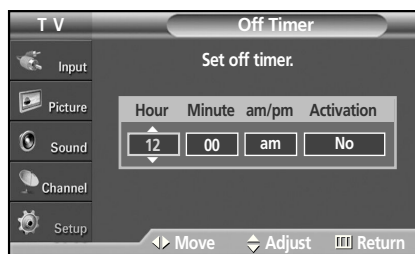
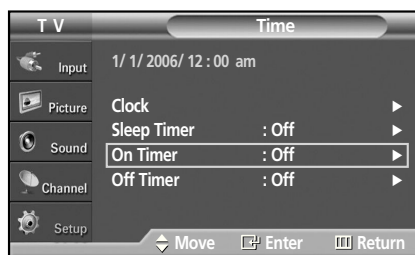



Setting the Sleep Timer

The sleep timer automatically shuts off the TV after a preset time (from 30 to 180 minutes).

- 1 Press the MENU button. Press the ▲ or ▼ button to select "Setup", then press the ENTER button.



- 2 Press the ▲ or ▼ button to select "Time", then press the ENTER button.

Press the ▲ or ▼ button to select "Sleep Timer", then press the ENTER button.

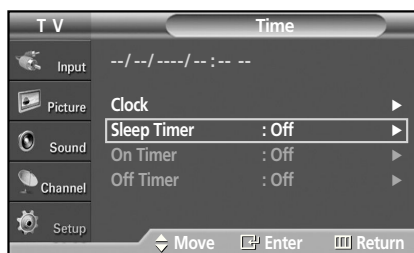

- 3 Press the ▲ or ▼ button to adjust "Minute".

- Setting the Timer sets the Activation to "On" automatically.

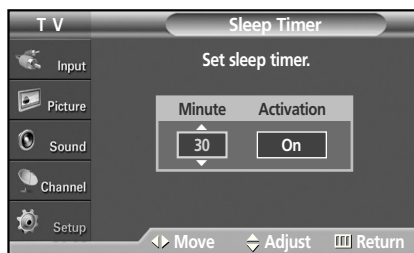

- 4 To cancel the set sleep timer:
Press the ► button to select "Activation".
Press the ▲ or ▼ button to select "Off", then press the ENTER button.

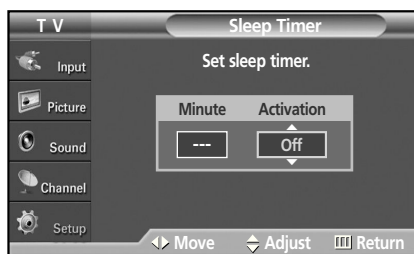

- 5 Press the EXIT button to exit.

Alternate method :

Press the SLEEP button on the remote control repeatedly until the appropriate time interval appears (any of the preset values from "30 min" to "180 min").

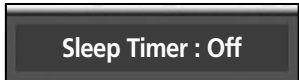

S
V
W
S
U
N
G

P L A S M A D I S P L A Y P A N E L

Function Description

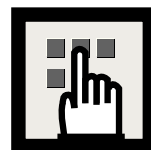

Selecting a Menu Language	104
Digital Noise Reduction	105
Selecting the Film Mode.....	106
Setting the Blue Screen	107
Using Game Mode.....	108
Viewing Closed Captions (On-Screen Text Messages) - Analog...	109
Viewing Closed Captions (On-Screen Text Messages) - Digital....	110
Menu Transparency Level	112
Using the Energy Saving feature	113
Preventing Screen Burn-in	114
Reducing the Effects of Screen Burn.....	115
Setting the Function Help	116
Setting the Blue Eye.....	117
Using the V-Chip (for USA)	118
Using the V-Chip (for Canada).....	124



Selecting a Menu Language

- 1 Press the MENU button. Press the ▲ or ▼ button to select "Setup", then press the ENTER button.



- 2 Press the ▲ or ▼ button to select "Language", then press the ENTER button.



- 3 Press the ▲ or ▼ button to select the appropriate language: "English", "Spanish", or "French". Press the ENTER button.

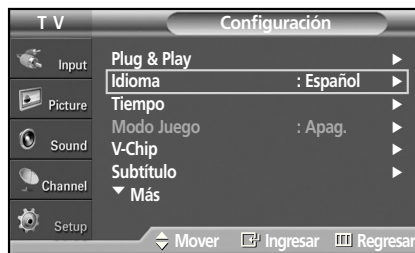

- 4 Press the EXIT button to exit.



Digital Noise Reduction

If the broadcast signal received by your TV is weak, you can activate the Digital Noise Reduction feature to help reduce any static and ghosting that may appear on the screen.

- 1 Press the MENU button. Press the ▲ or ▼ button to select "Picture", then press the ENTER button.

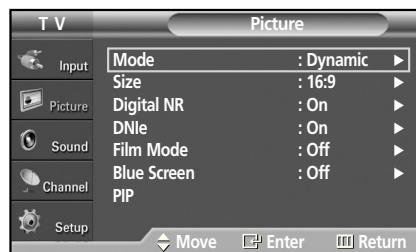

- 2 Press the ▲ or ▼ button to select "Digital NR", then press the ENTER button.

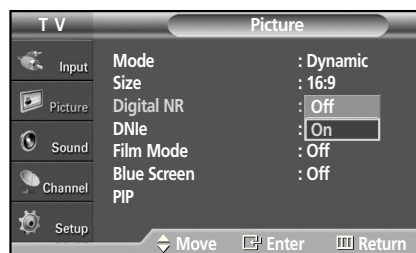

- 3 Press the ▲ or ▼ button to select "On" or "Off", then press the ENTER button.

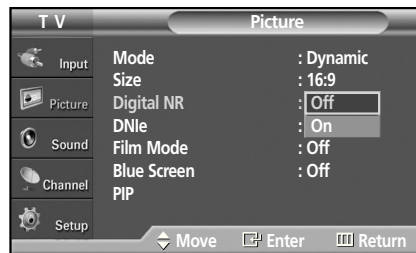

- 4 Press the EXIT button to exit.

Note

- The Digital NR function is available in all modes except PC.



Selecting the Film Mode

Automatically senses and processes film signals from all sources and adjusts the picture for optimum quality.

- 1 Press the MENU button. Press the ▲ or ▼ button to select "Picture", then press the ENTER button.

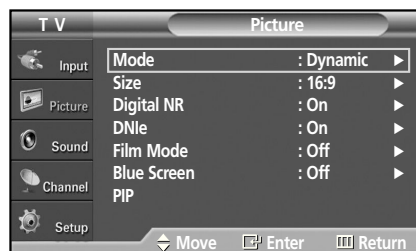

- 2 Press the ▲ or ▼ button to select "Film Mode", then press the ENTER button.

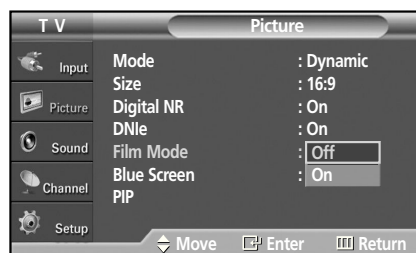

- 3 Press the ▲ or ▼ button to select "Off" or "On", then press the ENTER button.

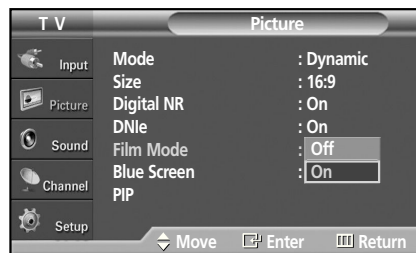

- 4 Press the EXIT button to exit.

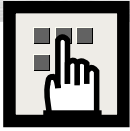

Setting the Blue Screen

If no signal is being received or the signal is very weak, a blue screen automatically replaces the noisy picture background. If you wish to continue viewing the poor picture, you must set the "Blue Screen" mode to "Off".

- 1 Press the MENU button. Press the ▲ or ▼ button to select "Picture", then press the ENTER button.

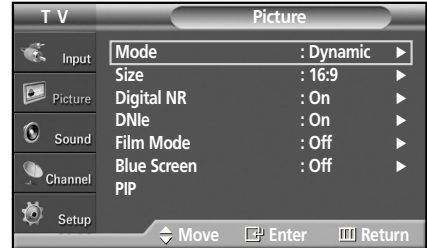

- 2 Press the ▲ or ▼ button to select "Blue Screen", then press the ENTER button.

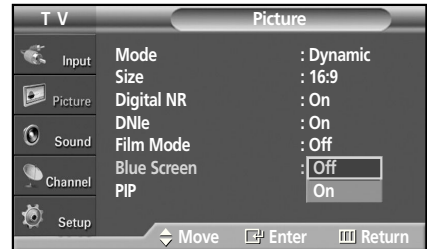

- 3 Press the ▲ or ▼ button to select "Off" or "On", then press the ENTER button.

- Blue Screen is displayed when there is no signal from an external device, regardless of the Blue Screen Setting.

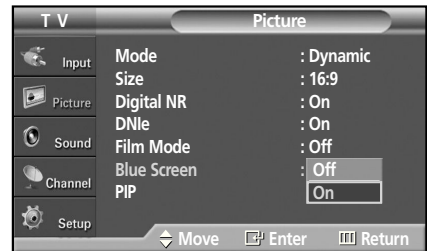

- 4 Press the EXIT button to exit.



Using Game Mode

When connecting to a game console such as PlayStation™ or Xbox™, you can enjoy a more realistic gaming experience by selecting the Game Menu.

- 1 Press the MENU button.
Press the ▲ or ▼ button to select "Setup", then press the ENTER button.



- 2 Press the ▲ or ▼ button to select "Game Mode", then press the ENTER button.

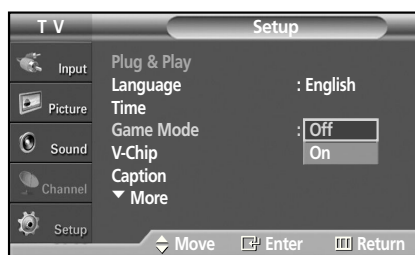

- 3 Press the ▲ or ▼ button to select "Off" or "On", then press the ENTER button.



- 4 Press the EXIT button to exit.

Restrictions on Game mode (Caution)

- To disconnect the game console and connect another external device, set Game to Off in the setup menu.
- If you display the TV menu in Game mode, the screen shakes slightly.
- The mark () appears on the screen which means that Game Mode is on with the selected source.



If Game Mode is On

- Picture Mode is automatically changed to Custom and users cannot change the mode.
- Sound Mode in the Sound menu is deactivated. Adjust the sound using the equalizer.
- The Reset Sound function is activated. Selecting the Reset function after setting the equalizer resets the equalizer setting to the factory defaults.

Notes

- Game Mode is not available in TV mode.
- If the picture is poor when external device is connected to TV, check if Game Mode is On. Set Game Mode to Off and connect external devices.



Viewing Closed Captions (On-Screen Text Messages) - Analog

The Analog Caption function operates in either analog RF channel mode or external signal mode.

1 Press the Menu button. Press the ▲ or ▼ button to select "Setup", then press the ENTER button.

- Quick way to select Caption: Just press "CAPTION" button on the remote control.

2 Press the ▲ or ▼ button to select "Caption", then press the ENTER button.

3 Press the ENTER button to select "Caption". Press the ▲ or ▼ button to select "On", then press the ENTER button.

4 Press the ▲ or ▼ button to select "Caption Mode", then press the ENTER button. Press the ▲ or ▼ button to select submenu (CC1~CC4 or Text1~Text4) you want, then press the ENTER button.

- The default is "CC1".
- CC1 : The Primary Synchronous Caption Service. These are captions in the primary language that must be in sync with the sound, preferably matched to a specific frame.
- CC2 : The Special Non-Synchronous Use Captions. This channel carries data that is intended to augment information carried in the program.
- CC3 : Secondary Synchronous Caption Service. Alternate program-related caption data, typically second language captions.
- CC4 : Special Non-Synchronous Use Captions. Similar to CC2.
- Text1 : First Text Service. This may be various non-program related data.
- Text2 : Second Text Service. Additional data, usually not program related.
- Text3/Text4 : Third and Fourth Text Services. These data channels should be used only if Text1 and Text2 data bandwidth is not sufficient.

5 Press the EXIT button to exit.

Notes

- The Caption feature doesn't work in COMPONENT, PC, HDMI(DVI) modes.
- The availability of captions depends on the program being broadcast.

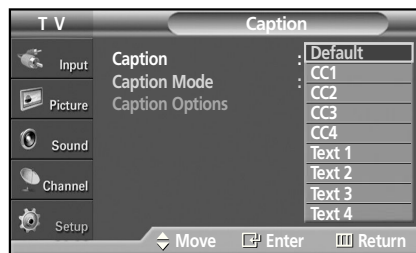
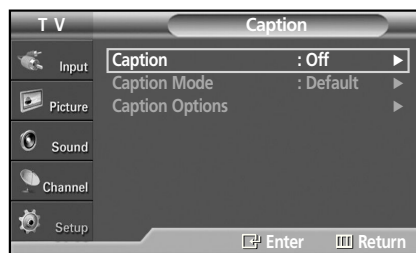
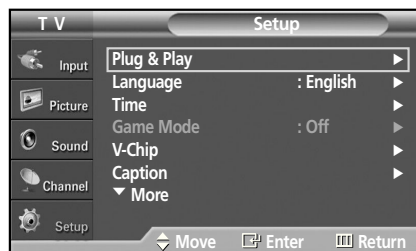



Viewing Closed Captions (On-Screen Text Messages) - Digital

The Digital Captions function operates on digital channels.

- 1 Press the MENU button.
Press the ▲ or ▼ button to select "Setup", then press the ENTER button.

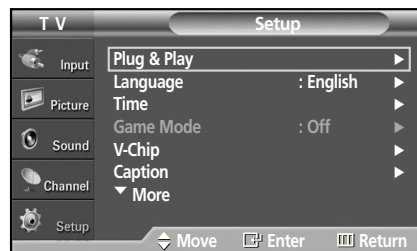

- 2 Press the ▲ or ▼ button to select "Caption", then press the ENTER button.

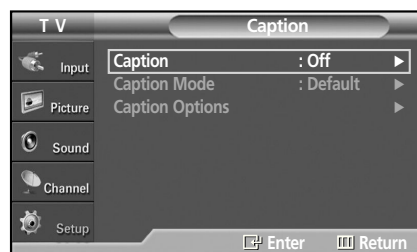

- 3 Press the ENTER button to select "Caption".
Press the ▲ or ▼ button to select "On", then press the ENTER button.

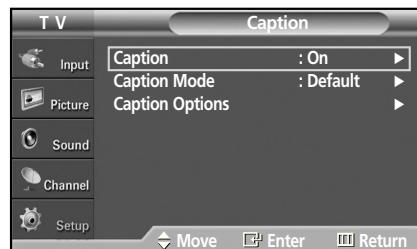

- 4 Press the ▲ or ▼ button to select "Caption Mode", then press the ENTER button.
Press the ▲ or ▼ button to select submenu (Service1~Service6, CC1~CC4 or Text1~Text4) you want, then press the ENTER button.



- 5 Press the ▲ or ▼ button to select "Caption Options", then press the ENTER button.

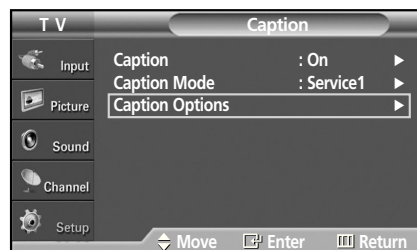

Notes

- "Caption Options" are available only when "Service1~Service6" can be selected in "Caption Mode".
- Service1~6 in digital caption mode may not be available according to the broadcasting type.

6 Press the ▲ or ▼ button to select "Size", then press the ENTER button.

Press the ▲ or ▼ button to select the desired Caption option, then press the ENTER button.

Press the ▲ or ▼ button to select the desired sub-menu options(see options below), then press ENTER.

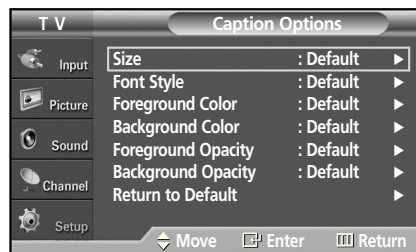

Notes

- The availability of captions depends on the program being broadcast.
- "Default" means to return to the original caption options set by the broadcaster.

7 Press the EXIT button to exit.

- **Size**
This option consists of "Default", "Small", "Standard", and "Large". The default is "Standard".
- **Font Style**
This option consists of "Default", "Style 0 ~ Style 7". You can change the font you want. The default is "Style 0".
- **Foreground Color**
This option consists of "Default", "White", "Black", "Red", "Green", "Blue", "Yellow", "Magenta", and "Cyan". You can change the color of the letter. The default is "White".
- **Background Color**
This option consists of "Default", "White", "Black", "Red", "Green", "Blue", "Yellow", "Magenta", and "Cyan". You can change the background color of the caption. The default is "Black".
- **Foreground Opacity**
This option consists of "Default", "Transparent", "Translucent", "Solid", and "Flashing". You can change the opacity of the letter.
- **Background Opacity**
This option consists of "Default", "Transparent", "Translucent", "Solid", and "Flashing". You can change the background opacity of the caption.
- **Return to Default**
This option sets each of "Size", "Font Style", "Foreground Color", "Background color", "Foreground Opacity", and "Background Opacity" to its default.

Alternate method:

Press the CAPTION button on the remote control repeatedly to select "On" or "Off".

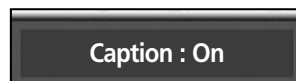



Menu Transparency Level

Adjusts the transparency of the menu screen.

- 1 Press the MENU button.
Press the ▲ or ▼ button to select "Setup", then press the ENTER button.



- 2 Press the ▲ or ▼ button to select "Menu Transparency", then press the ENTER button.
Press the ▲ or ▼ button to select level, then press the ENTER button.

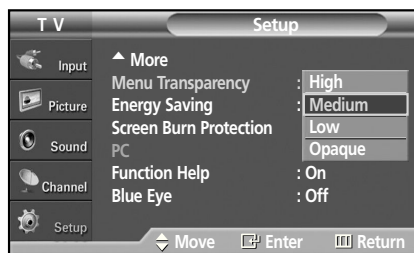

- 3 Press the EXIT button to exit.

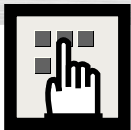

Using the Energy Saving Feature

This feature adjusts the screen brightness automatically depending on the surrounding lighting conditions.

1 Press the MENU button. Press the ▲ or ▼ button to select "Setup", then press the ENTER button.

➤ Quick way to select Energy Saving: Just press "E.SAVING" button on the remote control.

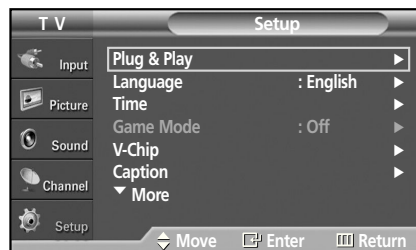

2 Press the ▲ or ▼ button to select "Energy Saving", then press the ENTER button.

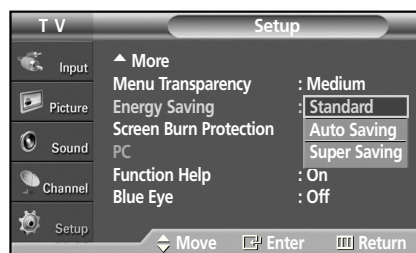

3 Press the ▲ or ▼ button to select submenu (Standard, Auto Saving or Super Saving) you want, then press the ENTER button.

- Standard : Operates in standard mode regardless of the surrounding illumination.
- Auto Saving : Automatically adjusts to the surrounding illumination.
- Super Saving : Enters maximum power saving mode regardless of the surrounding illumination.

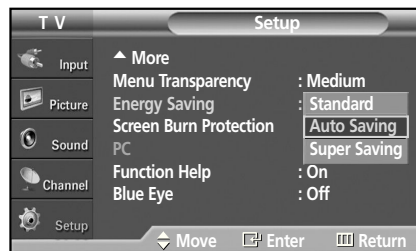

4 Press the EXIT button to exit.



Preventing Screen Burn-in

To reduce the possibility of screen burn, this unit is equipped with screen burn prevention technology. This technology enables you to set picture movement up/down (Vertical Line) and side to side (Horizontal Dot). The Time setting allows you to program the time between movement of the picture in minutes.

- 1 Press the MENU button.
Press the ▲ or ▼ button to select "Setup", then press the ENTER button.

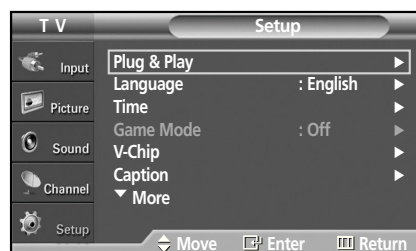

- 2 Press the ▲ or ▼ button to select "Screen Burn Protection", then press the ENTER button.

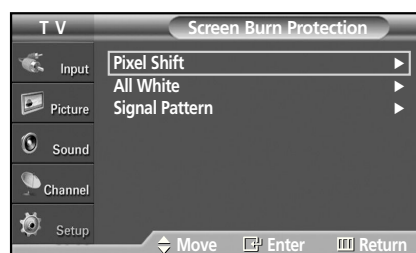

- 3 Press the ENTER button to select "Pixel Shift", then press the ENTER button.

- Pressing the ▲ or ▼ button will alternate between "On" and "Off".
You will also see the items "Horizontal Dot", "Vertical Line" and "Time".
- Pixel Shift: Using this function, you can minutely move pixels on the PDP in horizontal or vertical direction to prevent after-images on the screen.

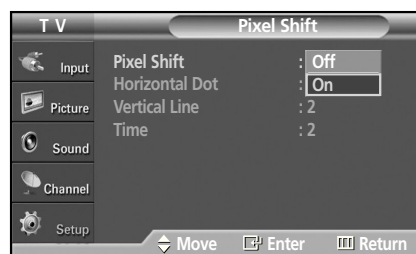

- 4 Press the ▲ or ▼ button to select the item you wish to change, then press the ENTER button.
Press the ▲ or ▼ button to change the value of the item, then press the ENTER button.

- Optimum condition for pixel shift;

Horizontal Dot	2
Vertical Line	2
Time(min)	2

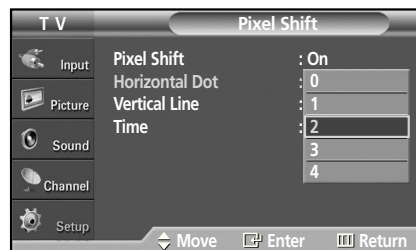

- 5 Press the EXIT button to exit.

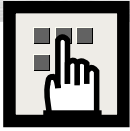

Reducing the Effects of Screen Burn

If screen burn has occurred, you can select a white screen or signal pattern (rolling screen) to help remove screen burn artifacts.

- 1 Press the MENU button.
Press the ▲ or ▼ button to select "Setup", then press the ENTER button.



- 2 Press the ▲ or ▼ button to select "Screen Burn Protection", then press the ENTER button.

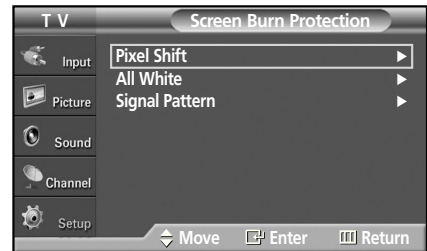

- 3 Press the ▲ or ▼ button to select "All White" or "Signal Pattern", then press the ENTER button.

- All White: This function removes after-images on the screen by changing the color of pixels to white. Use this function when there are remaining after-images or symbols on the screen especially when you displayed a still image on the screen for a long time.
- Signal Pattern: This function removes after-images on the screen by moving all the pixels on the PDP according to a pattern. Use this function when there are remaining after-images or symbols on the screen especially when you displayed a still image on the screen for a long time.

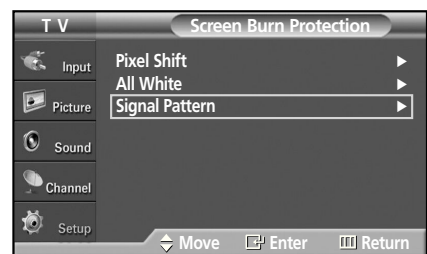
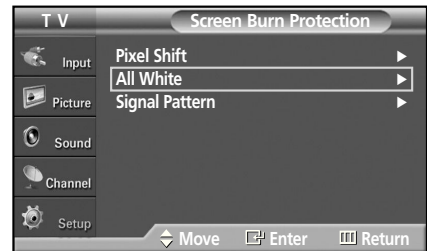

- 4 Press the EXIT button to exit.

Notes

- To remove after-images on the screen, use either the "All White" or "Signal Pattern" function. Although both functions remove after-images on the screen, "Signal Pattern" is more effective.
- The after-image removal function has to be executed for a long time (approximately 1 hour) to effectively remove after-images on the screen. If the after-image is not removed after performing the function, repeat the function again.
- Press any key on the remote control to cancel this feature.

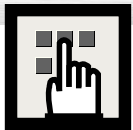

Setting the Function Help

Displays help on the menu functions.

- 1 Press the MENU button.
Press the ▲ or ▼ button to select "Setup", then press the ENTER button.



- 2 Press the ▲ or ▼ button to select "Function Help", then press the ENTER button.

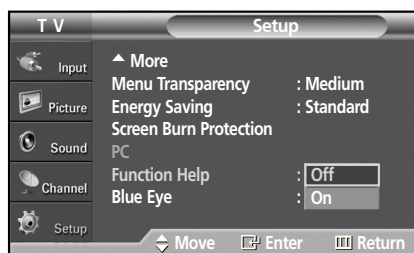

- 3 Press the ▲ or ▼ button to select "Off" or "On", then press the ENTER button.

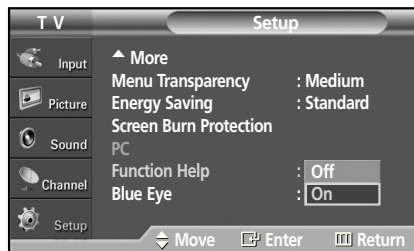

- 4 Press the EXIT button to exit.

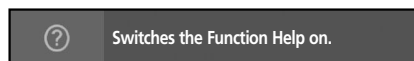

Note

- The Function Help default setting is On.

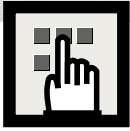

Setting the Blue Eye

You can set the power of Blue LED to be on. If the power is off when Blue Eye is off, the Blue LED goes off after 5 seconds. This will save power and reduce eye fatigue.

- 1 Press the MENU button.
Press the ▲ or ▼ button to select "Setup", then press the ENTER button.



- 2 Press the ▲ or ▼ button to select "Blue Eye", then press the ENTER button.



- 3 Press the ▲ or ▼ button to select "Off" or "On", then press the ENTER button.
 - Off : LED(Blue) will not come on when you turn the TV on and off.
 - On : LED(Blue) will come on when you turn the TV on and off.

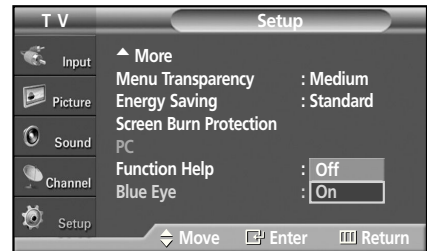

- 4 Press the EXIT button to exit.



Using the V-Chip (for USA)

The V-Chip feature automatically locks out programs that are deemed inappropriate for children. The user must enter a PIN (personal ID number) before any of the V-Chip restrictions are set up or changed.

- Notes :
- When the V-chip feature is activated, the PIP features do not function.
 - The V-Chip does not work if the input is DTV (HD or SD).
 - V-Chip function is not available in HDMI or component mode.

Setting Up Your Personal ID Number (PIN)

- 1 Press the MENU button. Press the ▲ or ▼ button to select "Setup", then press the ENTER button.

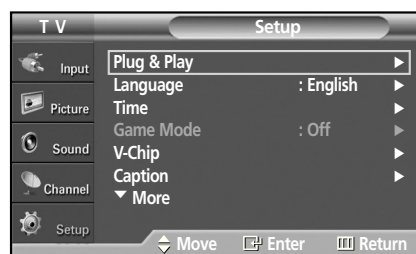

- 2 Press the ▲ or ▼ button to select "V-Chip", then press the ENTER button. The message "Enter PIN" will appear. Enter your 4 digit PIN.

Note

- The default PIN of a new TV set is "0-0-0-0".

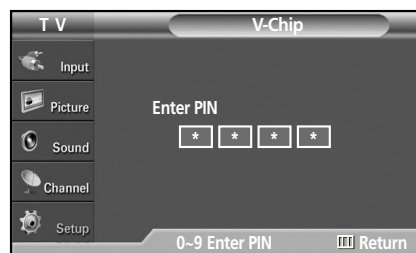

- 3 The V-Chip screen will appear. Press the ▲ or ▼ button to select "Change PIN", then press the ENTER button.

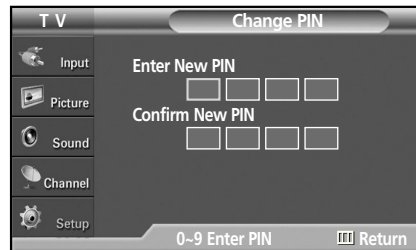

- 4 The Change PIN screen will appear. Choose any 4 digits for your PIN and enter them. As soon as the 4 digits are entered, "Confirm new PIN" screen appears. Re-enter the same 4 digits. When the Confirm screen disappears, your PIN has been memorized.

- 5 Press the EXIT button to exit.

Note

- If you forget the PIN, press the remote-control buttons in the following sequence, which resets the pin to 0-0-0-0 : Power Off. → Mute → 8 → 2 → 4 → Power On.

How to Enable/Disable the V-Chip

- 1 Press the MENU button. Press the ▲ or ▼ button to select "Setup", then press the ENTER button.



- 2 Press the ▲ or ▼ button to select "V-Chip", then press the ENTER button. The message "Enter PIN" will appear. Enter your 4 digit PIN.

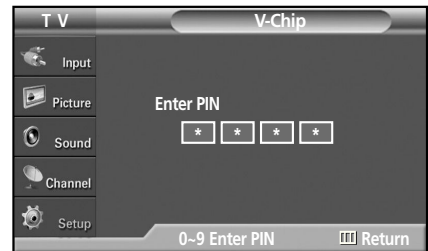

- 3 The V-Chip screen will appear. To enable the V-Chip feature, press the ENTER button so that "V-Chip Lock" field is "On". (Pressing the ▲ or ▼ button will alternate between "On" and "Off".) Press the ENTER button.

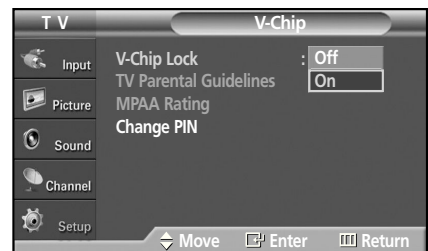

- 4 Press the EXIT button to exit.

How to Set up Restrictions using the “TV Parental Guidelines”

First, set up a personal identification number (PIN), and enable the V-Chip. (See previous section.) Parental restrictions can be set up using either of two methods: The TV guidelines or the MPAA rating.

- 1 Press the MENU button. Press the ▲ or ▼ button to select “Setup”, then press the ENTER button.

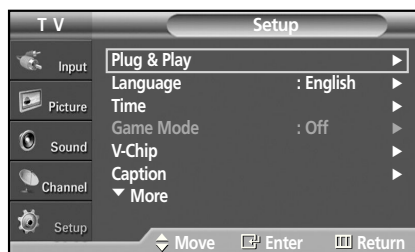

- 2 Press the ▲ or ▼ button to select “V-Chip”, then press the ENTER button. The message “Enter PIN” will appear. Enter your 4 digit PIN.

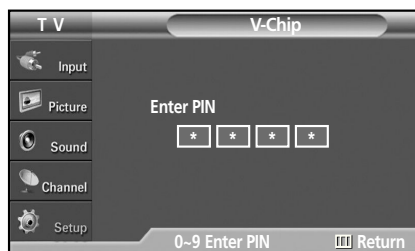

- 3 The V-Chip screen will appear. Press the ▲ or ▼ button to select “TV Parental Guidelines”, then press the ENTER button.

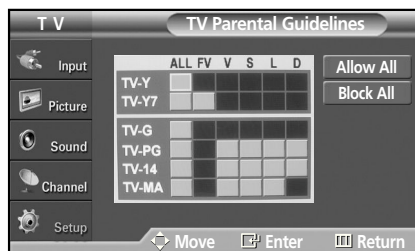



- 4 The TV Parental Guidelines screen will appear. Press the ▲ or ▼ button to select one of the six ages based categories:

TV-Y	Young children
TV-Y7	Children 7 and over

TV-G	General audience
TV-PG	Parental guidance
TV-14	Viewers 14 and over
TV-MA	Mature audience

Notes

- Allow All : Press to unlock all TV ratings.
- Block All : Press to lock all TV ratings.

- 5** At this point, one of the TV-Ratings is selected. Press the ENTER button. Depending on your existing setup, a  symbol will be selected. (Blank = Unblocked,  = Blocked)

While "" is selected, press the ENTER button to block or unblock the category. To select a different TV-Rating, press the ▲ or ▼ button and then repeat the process.

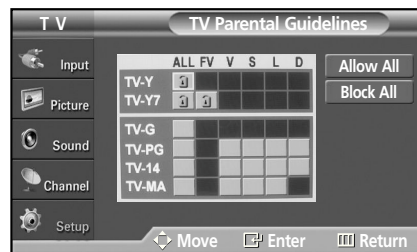



Note 1: The TV-Y, TV-Y7, TV-G, TV-PG, TV-14 and TV-MA have additional options. See the next step to change any of the following sub-ratings:

- FV: Fantasy violence
- D: Sexually Suggestive Dialog
- L: Adult Language
- S: Sexual situation
- V: Violence

Note 2: The V-Chip will automatically block certain categories that are "more restrictive". For example, if you block "TV-Y" category, then TV-Y7 will automatically be blocked. Similarly, if you block the TV-G category, then all the categories in the "young adult" group will be blocked (TV-G, TV-PG, TV-14, and TV-MA). The sub-ratings (D, L, S, V) work together similarly. (See next section.)

- 6** How to set the FV, D, L, S and V sub-ratings. First, select one of these TV-Ratings: TV-Y, TV-Y7, TV-G, TV-PG, TV-14, or TV-MA (See Step 4, on previous page), and press the ► button.

A "" symbol will be displayed for each sub-rating. While "" is selected, press the ENTER button to go to a sub rating. Press ENTER to block the sub rating. To select a different TV-Rating, press the ▲ or ▼ button and then repeat the process.

Note: The V-chip will automatically block certain categories that are "More restrictive". For example, if you block "L" sub-rating in TV-PG, then the "L" sub-ratings in TV-14 and TV-MA will automatically be blocked.

- 7** Press the EXIT button to clear all the screens. (Or proceed to the next section, and set up additional restrictions based on the MPAA codes.)

Notes

- These categories consist of two separate groups: TV-Y and TV-Y7 (young children through age 7), and TV-G through TV-MA (everybody else). The restrictions for these two groups work independently: If a household includes very young children as well as young adults, the TV guidelines must be set up separately for each age group. (See next step.)
- Allow All : Press to unlock all TV ratings.
- Block All : Press to lock all TV ratings.

How to Set up Restrictions using the MPAA Ratings: G, PG, PG-13, R, NC-17, X, NR

The MPAA rating system uses the Motion Picture Association of America (MPAA) system, and its main application is for movies. When the V-Chip lock is on, the TV will automatically block any programs that are coded with objectionable ratings (either MPAA or TV-Ratings).

1 Press the MENU button. Press the ▲ or ▼ button to select “Setup”, then press the ENTER button.

2 Press the ▲ or ▼ button to select “V-Chip”, then press the ENTER button.
The message “Enter PIN” will appear.
Enter your 4 digit PIN.

3 The V-Chip screen will appear.
Press the ▲ or ▼ button to select “MPAA Rating”, then press the ENTER button.

4 The MPAA Rating screen will appear.
Repeatedly press the ▲ or ▼ button to select a particular MPAA category.
Pressing the ▲ or ▼ button will cycle through the MPAA categories:

G General audience (no restrictions).

PG Parental guidance suggested.

PG-13 Parents strongly cautioned.

R Restricted. Children under 17 should be accompanied by an adult.

NC-17 No children under age 17.

X Adults only.

NR Not rated.

While a particular category is selected, press the ENTER button to activate it.

The selected “” symbol will be displayed.

Press the ENTER button to block or unblock the category.

Press the EXIT button to exit.

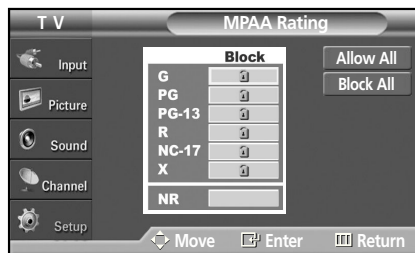
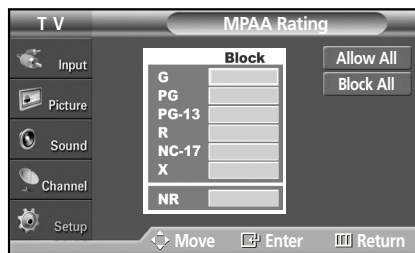
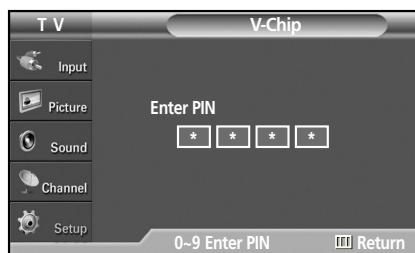
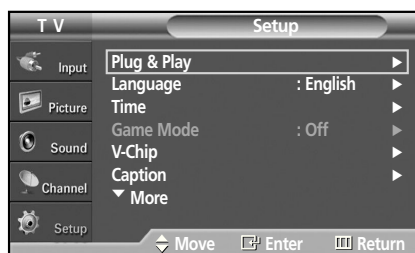

Notes

- The V-Chip will automatically block any category that is “more restrictive”. For example, if you block “PG-13” category, then “R”, “NC-17” and “X” will automatically be blocked also.
- Allow All : Press to unlock all TV ratings.
- Block All : Press to lock all TV ratings.

How to Reset the TV after the V-Chip Blocks a Channel ("Emergency Escape")

If the TV is tuned to a restricted channel, the V-Chip will block it. The screen will go blank and the following message will appear:

1 Enter your PIN.

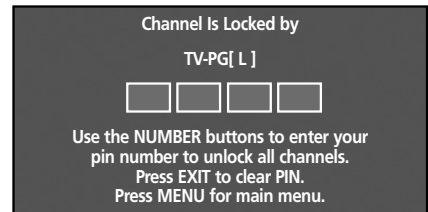
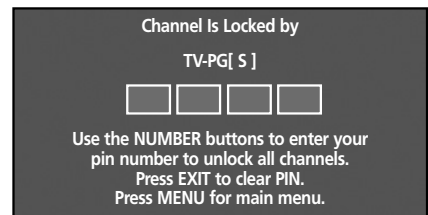

To resume normal viewing, tune to a different channel using CH \wedge or CH \vee button. Under certain conditions (depending on the rating of the local TV programs) the V-Chip might lock out all the channels. In this case, use the V-Chip function for an "emergency escape":

1 Press the MENU button. Press the \blacktriangle or \blacktriangledown button to select "Setup", then press the ENTER button.

2 Press the \blacktriangle or \blacktriangledown button to select "V-Chip", then press the ENTER button.

3 Enter your PIN then press the ENTER, and press the \blacktriangle or \blacktriangledown button to temporarily disable the V-Chip Lock.

Note

- If you forget the PIN, press the remote-control buttons in the following sequence, which resets the pin to 0-0-0-0 : Power Off. \rightarrow Mute \rightarrow 8 \rightarrow 2 \rightarrow 4 \rightarrow Power On.



Using the V-Chip (for Canada)

The V-Chip feature automatically locks out programs that are deemed inappropriate for children. The user must enter a PIN (personal ID number) before any of the V-Chip restrictions are set up or changed.

- Notes :
- When the V-chip feature is activated, the PIP features do not function.
 - The V-Chip does not work if the input is DTV (HD or SD).
 - V-Chip function is not available in HDMI or Component mode.

Setting Up Your Personal ID Number (PIN)

- 1 Press the MENU button. Press the ▲ or ▼ button to select "Setup", then press the ENTER button.



- 2 Press the ▲ or ▼ button to select "V-Chip", then press the ENTER button. The message "Enter PIN" will appear. Enter your 4 digit PIN.

Note

- The default PIN of a new TV set is "0-0-0-0".

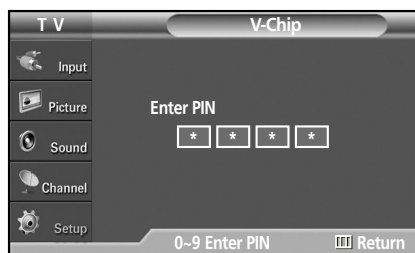

- 3 The V-Chip screen will appear. Press the ▲ or ▼ button to select "Change PIN", then press the ENTER button.

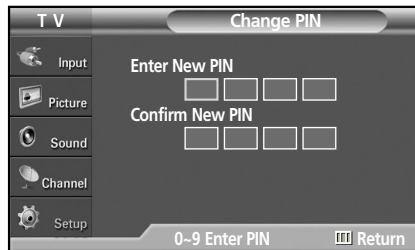

- 4 The Change PIN screen will appear. Choose any 4 digits for your PIN and enter them. As soon as the 4 digits are entered, "Confirm new PIN" screen appears. Re-enter the same 4 digits. When the Confirm screen disappears, your PIN has been memorized.

- 5 Press the EXIT button to exit.

Note

- If you forget the PIN, press the remote-control buttons in the following sequence, which resets the pin to 0-0-0-0 : Power Off. → Mute → 8 → 2 → 4 → Power On.

How to Enable/Disable the V-Chip

- 1 Press the MENU button. Press the ▲ or ▼ button to select "Setup", then press the ENTER button.



- 2 Press the ▲ or ▼ button to select "V-Chip", then press the ENTER button. The message "Enter PIN" will appear. Enter your 4 digit PIN.

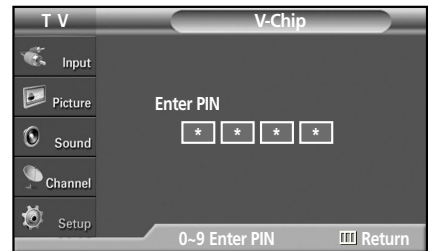

- 3 The V-Chip screen will appear. To enable the V-Chip feature, press the ENTER button so that "V-Chip Lock" field is "On". (Pressing the ▲ or ▼ button will alternate between "On" and "Off".) Press the ENTER button.



- 4 Press the EXIT button to exit.

How to Set up Restrictions using "TV Parental Guidelines"

First, set up a personal identification number (PIN), and enable the V-Chip. (See previous section.) Parental restrictions can be set up using either of two methods: The TV guidelines or the MPAA rating.

- 1 Press the MENU button. Press the ▲ or ▼ button to select "Setup", then press the ENTER button.



- 2 Press the ▲ or ▼ button to select "V-Chip", then press the ENTER button. The message "Enter PIN" will appear. Enter your 4 digit PIN.

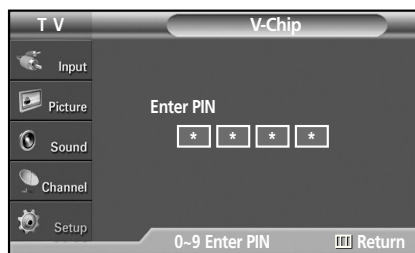

- 3 The V-Chip screen will appear. Press the ▲ or ▼ button to select "TV Parental Guidelines", then press the ENTER button.

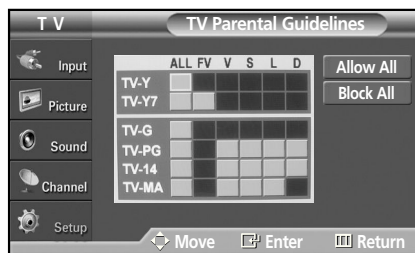



- 4 The TV Parental Guidelines screen will appear. Press the ▲ or ▼ button to select one of the six ages based categories:

TV-Y	Young children
TV-Y7	Children 7 and over

TV-G	General audience
TV-PG	Parental guidance
TV-14	Viewers 14 and over
TV-MA	Mature audience

Notes

- Allow All : Press to unlock all TV ratings.
- Block All : Press to lock all TV ratings.

- 5** At this point, one of the TV-Ratings is selected. Press the ENTER button. Depending on your existing setup, a  symbol will be selected. (Blank = Unblocked,  = Blocked)

While "" is selected, press the ENTER button to block or unblock the category. To select a different TV-Rating, press the ▲ or ▼ button and then repeat the process.

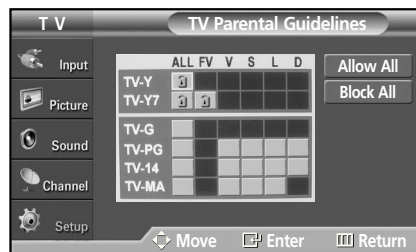



Note 1: The TV-Y, TV-Y7, TV-G, TV-PG, TV-14 and TV-MA have additional options. See the next step to change any of the following sub-ratings:

- FV: Fantasy violence
- D: Sexually Suggestive Dialog
- L: Adult Language
- S: Sexual situation
- V: Violence

Note 2: The V-Chip will automatically block certain categories that are "more restrictive". For example, if you block "TV-Y" category, then TV-Y7 will automatically be blocked. Similarly, if you block the TV-G category, then all the categories in the "young adult" group will be blocked (TV-G, TV-PG, TV-14, and TV-MA). The sub-ratings (D, L, S, V) work together similarly. (See next section.)

- 6** How to set the FV, D, L, S and V sub-ratings. First, select one of these TV-Ratings: TV-Y, TV-Y7, TV-G, TV-PG, TV-14, or TV-MA (See Step 4, on previous page), and press the ► button.

A "" symbol will be displayed for each sub-rating. While "" is selected, press the ENTER button to go to a sub rating. Press ENTER to block the sub rating. To select a different TV-Rating, press the ▲ or ▼ button and then repeat the process.

Note: The V-chip will automatically block certain categories that are "More restrictive". For example, if you block "L" sub-rating in TV-PG, then the "L" sub-ratings in TV-14 and TV-MA will automatically be blocked.

- 7** Press the EXIT button to clear all the screens. (Or proceed to the next section, and set up additional restrictions based on the MPAA codes.)

Notes

- These categories consist of two separate groups: TV-Y and TV-Y7 (young children through age 7), and TV-G through TV-MA (everybody else). The restrictions for these two groups work independently: If a household includes very young children as well as young adults, the TV guidelines must be set up separately for each age group. (See next step.)
- Allow All : Press to unlock all TV ratings.
- Block All : Press to lock all TV ratings.

How to Set up Restrictions using the MPAA Ratings: G, PG, PG-13, R, NC-17, X, NR

The MPAA rating system uses the Motion Picture Association of America (MPAA) system, and its main application is for movies. When the V-Chip lock is on, the TV will automatically block any programs that are coded with objectionable ratings (either MPAA or TV-Ratings).

1 Press the MENU button. Press the ▲ or ▼ button to select "Setup", then press the ENTER button.

2 Press the ▲ or ▼ button to select "V-Chip", then press the ENTER button.
The message "Enter PIN" will appear.
Enter your 4 digit PIN.

3 The V-Chip screen will appear.
Press the ▲ or ▼ button to select "MPAA Rating", then press the ENTER button.

4 The MPAA Rating screen will appear.
Repeatedly press the ▲ or ▼ button to select a particular MPAA category.
Pressing the ▲ or ▼ button will cycle through the MPAA categories:

- G** General audience (no restrictions).
- PG** Parental guidance suggested.
- PG-13** Parents strongly cautioned.
- R** Restricted. Children under 17 should be accompanied by an adult.
- NC-17** No children under age 17.
- X** Adults only.
- NR** Not rated.

While a particular category is selected, press the ENTER button to activate it.
The selected "🔒" symbol will be displayed.
Press the ENTER button to block or unblock the category.
Press the EXIT button to exit.

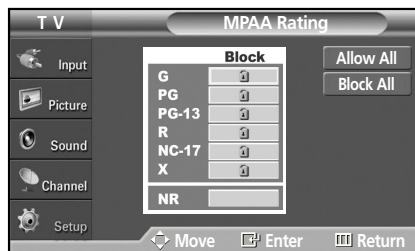
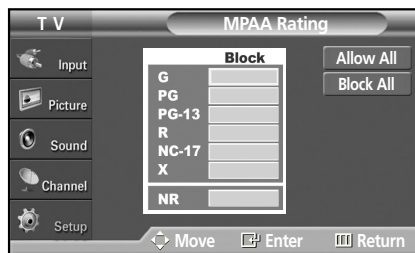
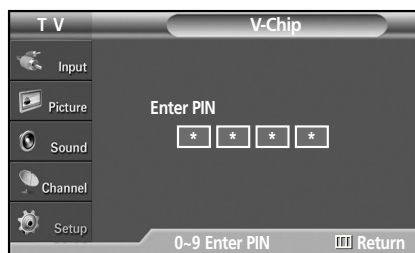
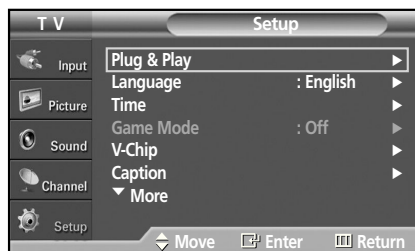

Notes

- The V-Chip will automatically block any category that is "more restrictive". For example, if you block "PG-13" category, then "R", "NC-17" and "X" will automatically be blocked also.
- Allow All : Press to unlock all TV ratings.
- Block All : Press to lock all TV ratings.

How to Set up Restrictions using "Canadian English": E, C, C8+, G, PG, 14+, 18+

First, set up a personal identification number (PIN), and enable the V-Chip. (refer to page 125)

1 Press the MENU button. Press the ▲ or ▼ button to select "Setup", then press the ENTER button.



2 Press the ▲ or ▼ button to select "V-Chip", then press the ENTER button. The message "Enter PIN" will appear. Enter your 4 digit PIN.

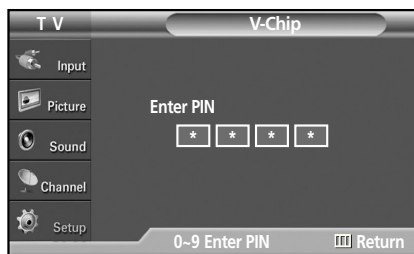

3 The V-Chip screen will appear. Press the ▲ or ▼ button to select "Canadian English", then press the ENTER button.

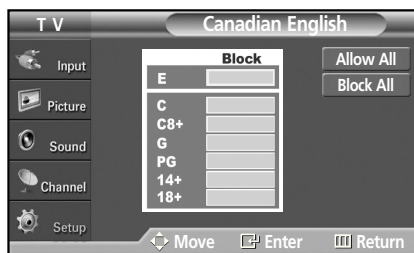

4 The Canadian English screen will appear. Repeatedly press the ▲ or ▼ button to select a particular Canadian English category. Pressing the ▲ or ▼ button will cycle through the Canadian English categories:

- | | |
|------------|---|
| E | Exempt programming includes...news, sports, documentaries and other information programming, talk shows, music videos, and variety programming. |
| C | Programming intended for children under age 8 |
| C8+ | Programming generally considered acceptable for children 8 years and over to watch on their own |
| G | General programming, suitable for all audiences |
| PG | Parental Guidance |
| 14+ | Programming contains themes or content which may not be suitable for viewers under the age of 14 |
| 18+ | Adult Programming |

While a particular category is selected, press the ENTER button to activate it.

A selected symbol "🔒" will be displayed.

Press the ▲ or ▼ button to select other items.

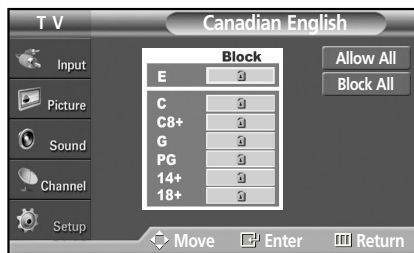

5 Press the EXIT button to save the settings and to clear all screens.

Notes

- The V-Chip will automatically block any category that is "more restrictive". For example, if you block "G" category, then "PG", "14+" and "18+" will automatically be blocked also.
- Allow All : Press to unlock all TV ratings.
- Block All : Press to lock all TV ratings.

How to Set up Restrictions using "Canadian French": E, G, 8 ans +, 13 ans +, 16 ans +, 18 ans +

First, set up a personal identification number (PIN), and enable the V-Chip. (refer to page 125)

- 1 Press the MENU button. Press the ▲ or ▼ button to select "Setup", then press the ENTER button.



- 2 Press the ▲ or ▼ button to select "V-Chip", then press the ENTER button. The message "Enter PIN" will appear. Enter your 4 digit PIN.

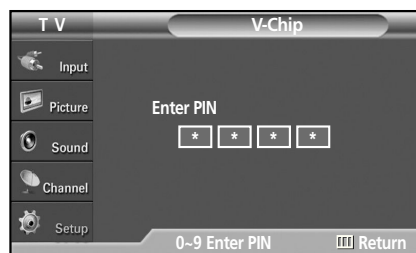

- 3 The V-Chip screen will appear. Press the ▲ or ▼ button to select "Canadian French", then press the ENTER button.

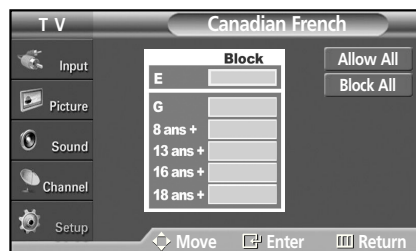

- 4 The Canadian French screen will appear. Repeatedly press the ▲ or ▼ button to select a particular Canadian French category. Pressing the ▲ or ▼ button will cycle through the Canadian French categories:

E Exempt programming includes...news, sports, documentaries and other information programming, talk shows, music videos, and variety programming.

G General

8 ans + Not recommended for young children

13 ans + Programming may not be suitable for children under the age of 13

16 ans + Programming is not suitable for children under the age of 16

18 ans + Programming restricted to adults

While a particular category is selected, press the ENTER button to activate it.

A selected symbol "🔒" will be displayed.

Press the ▲ or ▼ button to select other items.

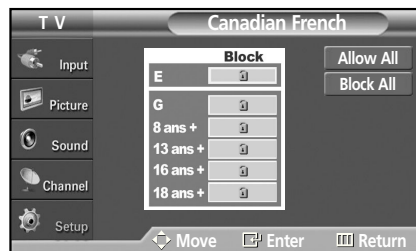

- 5 Press the EXIT button to save the settings and to clear all screens.

Notes

- The V-Chip will automatically block any category that is "more restrictive". For example, if you block "8 ans+" category, then "13 ans+", "16 ans+" and "18 ans+" will automatically be blocked also.
- Allow All : Press to unlock all TV ratings.
- Block All : Press to lock all TV ratings.

How to Reset the TV after the V-Chip Blocks a Channel ("Emergency Escape")

If the TV is tuned to a restricted channel, the V-Chip will block it. The screen will go blank and the following message will appear:

1 Enter your PIN.

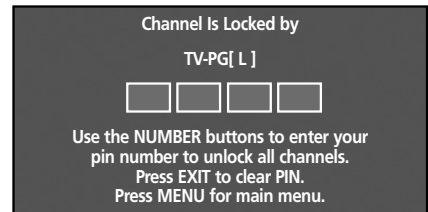
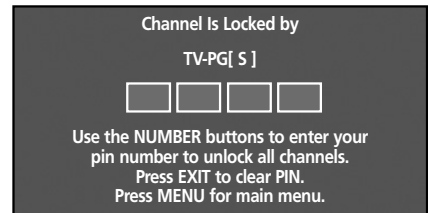

To resume normal viewing, tune to a different channel using CH \wedge or CH \vee button. Under certain conditions (depending on the rating of the local TV programs) the V-Chip might lock out all the channels. In this case, use the V-Chip function for an "emergency escape":

1 Press the MENU button. Press the \blacktriangle or \blacktriangledown button to select "Setup", then press the ENTER button.

2 Press the \blacktriangle or \blacktriangledown button to select "V-Chip", then press the ENTER button.

3 Enter your PIN then press the ENTER, and press the \blacktriangle or \blacktriangledown button to temporarily disable the V-Chip Lock.

Note

- If you forget the PIN, press the remote-control buttons in the following sequence, which resets the pin to 0-0-0-0 : Power Off. \rightarrow Mute \rightarrow 8 \rightarrow 2 \rightarrow 4 \rightarrow Power On.

S
A
M
S
U
N
G

P L A S M A D I S P L A Y P A N E L

Appendix 

Troubleshooting.....	134
Care and Maintenance	135
Specifications	136
Dimensions (HP-S4253)	137
Dimensions (HP-S5053)	139



Troubleshooting

If the TV seems to have a problem, first try this list of possible problems and solutions. If none of these troubleshooting tips apply, then call your nearest service center.

Problem	Possible Solution
Poor picture.	Check all wire connections.
No picture or sound.	Try another channel. Press the SOURCE button. Make sure the TV is plugged in. Check the antenna connections. Check that the Mute feature is Off. Check if Internal Mute is set to On.
Poor sound quality.	Try another channel. Adjust the volume.
Your remote control does not operate the TV.	Press the "TV" button to put your remote control in the "TV" mode. Check the battery charge of the remote control.
The TV won't turn on.	Check if the power plug is connected.
There is no screen image.	Check to see that both the TV and the source are plugged in and turned on.
The image is too light or too dark.	Adjust the Brightness or Contrast settings.
The image is too large or too small.	Adjust the Size settings.
Digital broadcasting screen problem.	Please check the digital signal strength and input antenna.
Screen is black and power indicator light blinks steadily.	On your computer check; Power, Signal Cable. The TV is using its power management system. Move the computer's mouse or press any key on the keyboard.
	On your equipment check (STB, DVD, etc) ; Power, Signal Cable. The TV is using its power management system. Press the Source button on the panel or remote control. Turn the TV off and on.
The visual qualities of digital channels vary.	The visual qualities of digital channels may vary depending on the original production method (analog or digital). → If the original production method is digital: High visual quality program. → If the original production method is analog: The digital program displayed on the screen is originally an analog program which has been converted. The visual quality is of an SD grade.
Although the TV caption shows HD, the visual quality is not satisfactory.	The HD caption that appears when switching channels or when pressing the Information button on the remote control means the selected channel is simply a digital channel. If the broadcasting station converts an analog signal into digital and transmits the signal, the visual quality may not be perfect. (Applied to Set Top Box built-in model only.)



Care and Maintenance

Please follow these guidelines to get the maximum performance from your TV.

Identifying Problems

- Do not put the TV near extremely hot, cold, humid or dusty places.
- Do not put the TV near appliances that create magnetic fields.
- Keep the ventilation openings clear.
- Do not place the TV on a rough and slanted surface, such as cloth or paper.

Liquids

- Do not place liquids near or on the TV.

Cabinet

- Never open the cabinet or touch the parts inside.
- Wipe your TV with a clean, dry cloth. Never use water, cleaning fluids, wax, or chemicals.
- Do not put heavy objects on top of the cabinet.

Temperature

- If your TV is suddenly moved from a cold to a warm place, unplug the power cord for at least two hours so that moisture that may have formed inside the unit can dry completely.



Specifications

Exterior design and product specifications are subject to change without prior notice to improve the performance of this product.

Model		HP-S4253	HP-S5053
Dimensions	Display	41.5 (W) x 28 (H) x 3.8 (D) inches (Without Stand)	48.3 (W) x 31.6 (H) x 3.8 (D) inches (Without Stand)
		41.5 (W) x 29.8 (H) x 13.4 (D) inches (With Stand)	48.3 (W) x 33.3 (H) x 13.4 (D) inches (With Stand)
Weight	Display	34.2 kg / 75.4 lbs (Without Stand)	42.6 kg / 93.9 lbs (Without Stand)
		40 kg / 88.2 lbs (With Stand)	48.3 kg / 106.5 lbs (With Stand)
Voltage		AC 110-120V±10%, 60Hz	AC 110-230V±10%, 60Hz
Power Consumption		380 W	480 W
Number of Pixels		1024 (H) x 768 (V)	1366 (H) x 768 (V)
Screen Size		42 inches	50 inches
ANTENNA input		ANT 1 - CABLE IN ANT 2 - AIR IN ※ 75Ω unbalanced	
VIDEO input		AV1, AV2 S-VIDEO1, S-VIDEO2 COMPONENT1 - 480i/480p/720p/1080i COMPONENT2 - 480i/480p/720p/1080i PC HDMI1 (DVI Compatible) HDMI2	
AUDIO input		AV1, AV2 S-VIDEO1, S-VIDEO2 COMPONENT1 - 480i/480p/720p/1080i COMPONENT2 - 480i/480p/720p/1080i PC DVI	
Sound Output		AUDIO (L/R)	
Audio Output		OPTICAL (DIGITAL OUT) COAXIAL (DIGITAL OUT)	



Dimensions (HP-S4253)

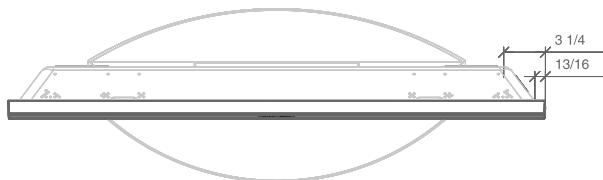

TOP VIEW

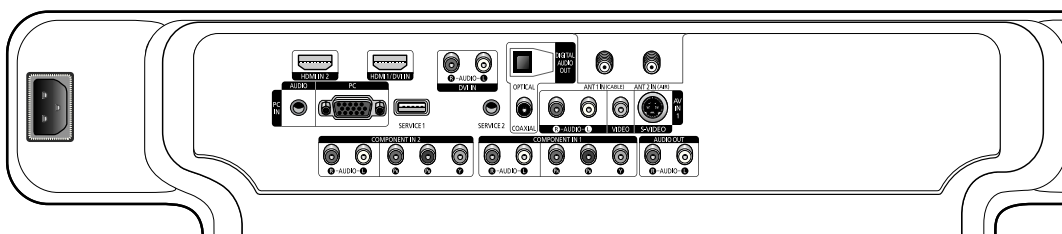

JACK PANEL DETAIL 2 1/4"H x 18 3/4"W @ 5 3/4" UP FROM BOTTOM

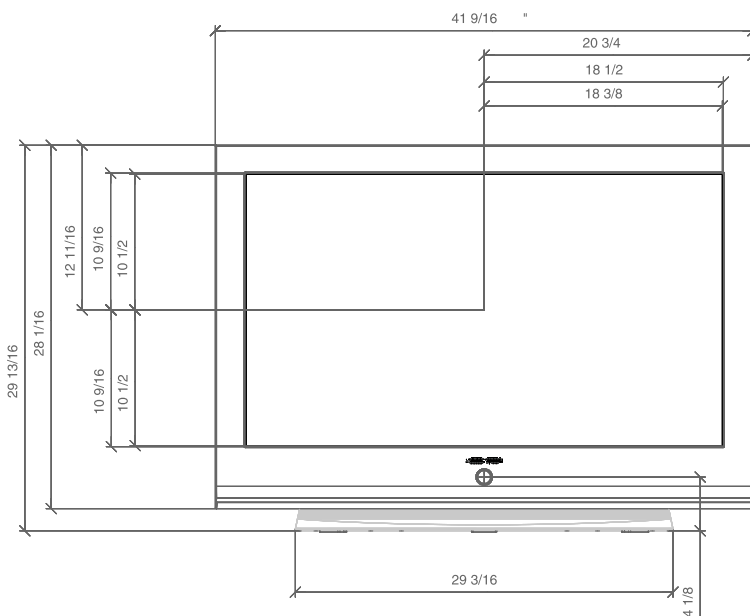

FRONT VIEW

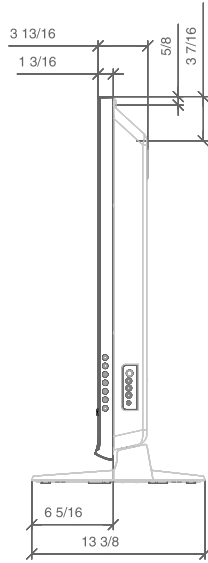

SIDE VIEW

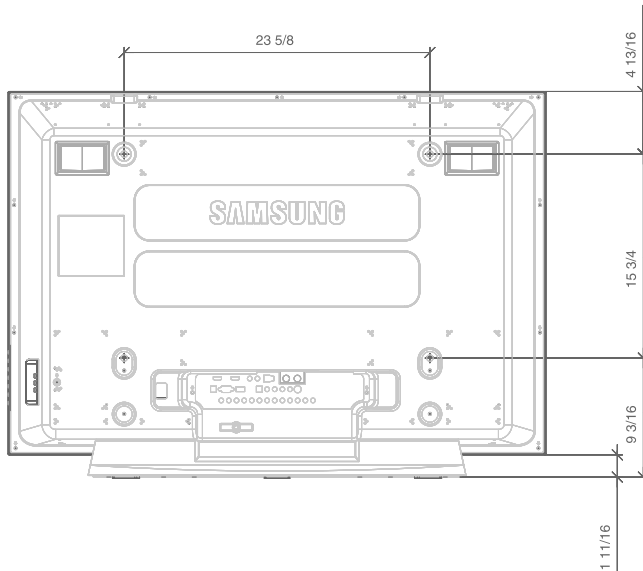

REAR VIEW

NOTE: All drawings not necessarily to scale. Some dimensions are subject to change without prior notice. Refer to dimensions on each unit prior to performing any carpentry. Not responsible for typographical or printed errors.
 © 2006 Samsung Electronics America, Inc.



Dimensions (HP-S5053)

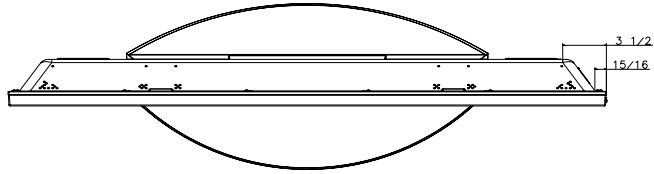

TOP VIEW

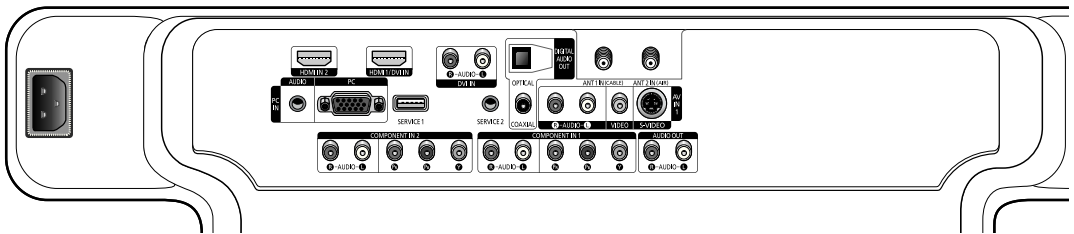

JACK PANEL DETAIL 2 1/4"H x 18 3/4"W @ 5 3/4" UP FROM BOTTOM

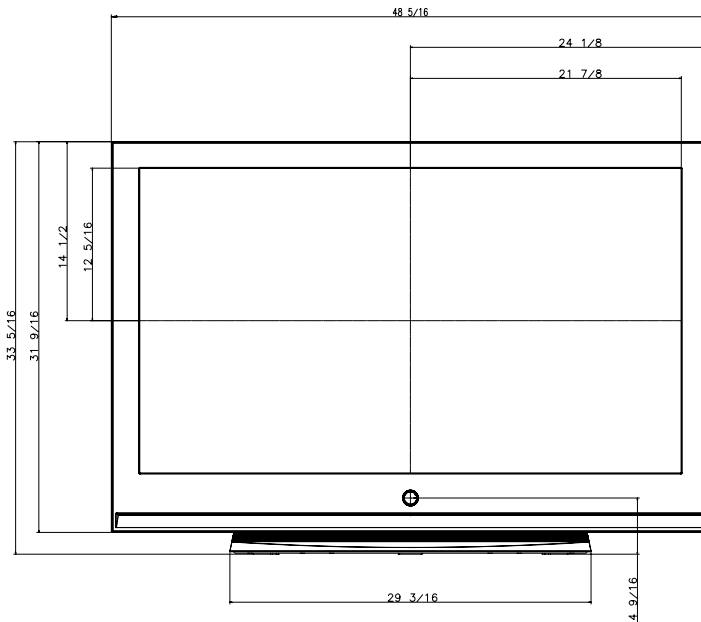

FRONT VIEW

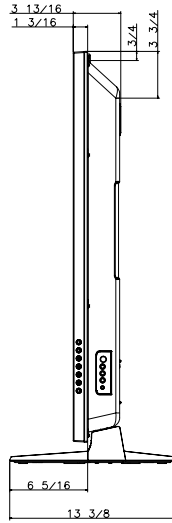

SIDE VIEW

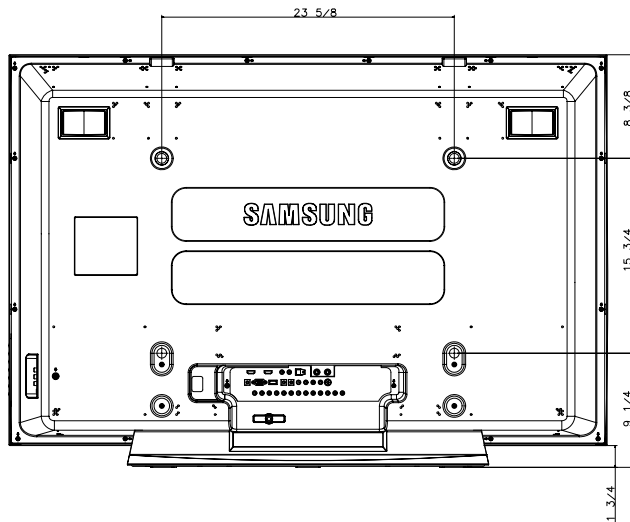

REAR VIEW

NOTE: All drawings not necessarily to scale. Some dimensions are subject to change without prior notice. Refer to dimensions on each unit prior to performing any carpentry. Not responsible for typographical or printed errors.
 © 2006 Samsung Electronics America, Inc.

***This page is intentionally
left blank.***

***This page is intentionally
left blank.***

***This page is intentionally
left blank.***



Contact SAMSUNG WORLD-WIDE

If you have any questions or comments relating to Samsung products, please contact the SAMSUNG customer care center.

Country	Customer Care Center ☎	Web Site	Address
CANADA	1-800-SAMSUNG (7267864)	www.samsung.com/ca	Samsung Electronics Canada Inc., Customer Service 55 Standish Court Mississauga, Ontario L5R 4B2 Canada
			Samsung Electronique Canada Inc., Service à la Clientèle 55 Standish Court Mississauga, Ontario L5R 4B2 Canada
U.S.A	1-800-SAMSUNG (7267864)	www.samsung.com	Samsung Electronics America, Inc. 105 Challenger Road Ridgefield Park, NJ 07660-0511