

Ranger™

BARACUDA®

The World's Simplest Automatic Pool Cleaners

Owner's Manual and Quick Assembly Instructions

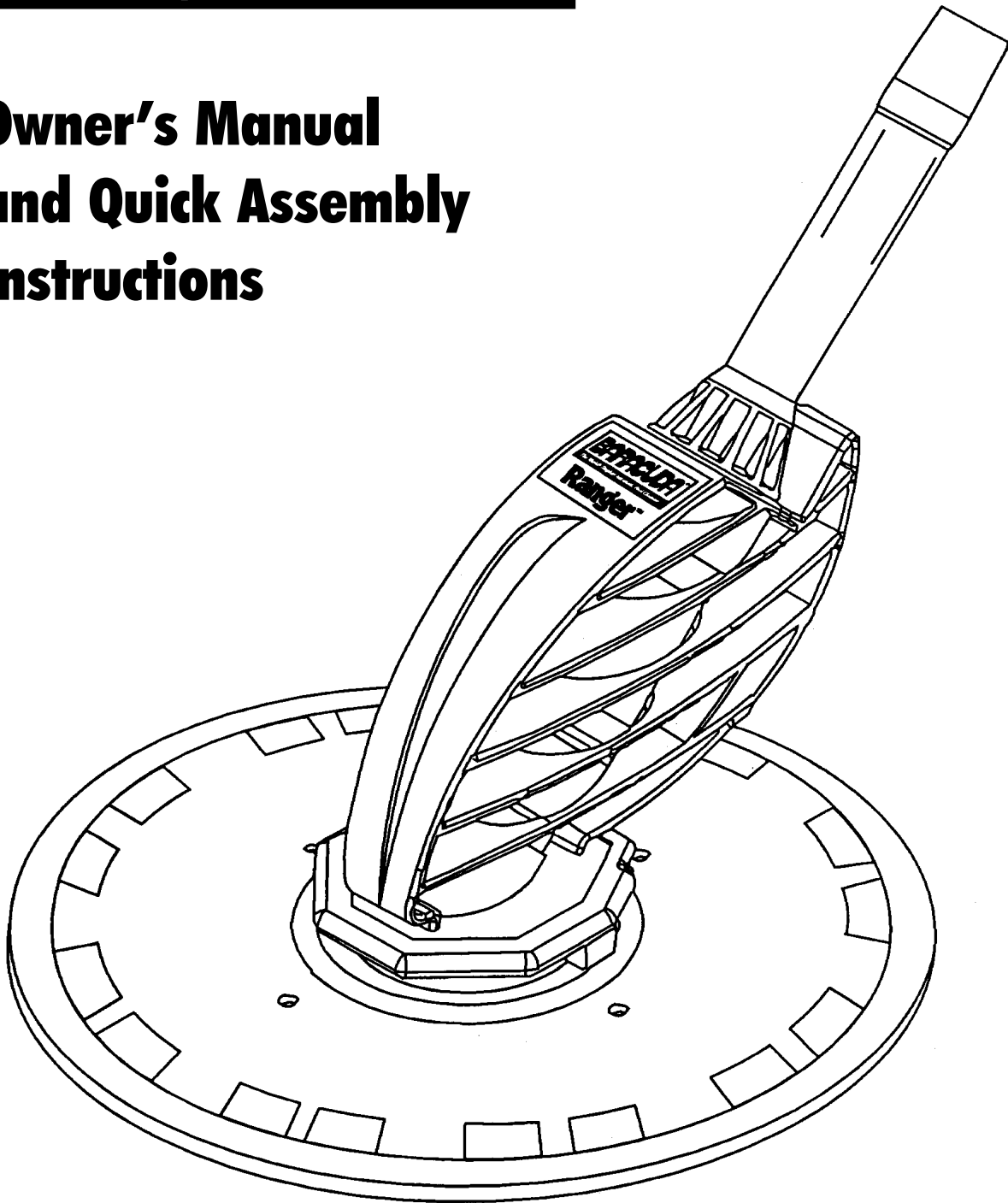

Ranger™

AUTOMATIC ABOVEGROUND POOL CLEANER

**THANK YOU FOR PURCHASING THE BARACUDA® RANGER™.
YOUR RANGER™ HAS BEEN DESIGNED AND MANUFACTURED
TO BE EASILY INSTALLED AND TO PROVIDE YEARS OF
LOW MAINTENANCE OPERATION.**

PRIOR TO INSTALLING YOUR NEW RANGER™, PLEASE DO THE FOLLOWING:

- 1) Complete and return the warranty card.
- 2) Record your purchase information on the spaces provided below.
- 3) Attach your invoice (or a copy) to this page.

These actions will insure prompt warranty service, should it be required. Simply present your owner's manual, along with the invoice at any of our authorized warranty centers nationwide.

RECORD YOUR BARACUDA RANGER POOL CLEANER DATA HERE:

Date of Purchase _____

Purchased From _____

City _____ State/Province _____ Zip/Postal Code _____

Serial No.(located on underside of machine head) _____

BARACUDA RANGER LIMITED WARRANTY

This BARACUDA RANGER was carefully inspected before shipment from our warehouse. Upon unpacking, if any part proves defective or missing, please notify your dealer immediately. Please consult owner's manual for complete instructions on the installation and operation of your BARACUDA RANGER.

ZODIAC POOL CARE, INC. WARRANTS THE RANGER POOL CLEANER AGAINST ALL MANUFACTURING DEFECTS AND ALL WEAR AND TEAR FOR (1) YEAR. ALL WARRANTIES ARE EFFECTIVE FROM THE DATE OF PURCHASE.

Should this product prove defective in workmanship, materials or wear during the applicable warranty period, the consumer's sole and exclusive remedy shall be such repair or replacement of the product as provided below.

THIS LIMITED WARRANTY EXCLUDES THE FOLLOWING:

1. Discoloration of the BARACUDA® RANGER™ pool cleaner. This is caused by reaction to ultraviolet rays and the chemicals used in the pool water. Discoloration does not affect the operating ability of the BARACUDA RANGER. Therefore, this Limited Warranty does not cover the replacement of discolored parts.
2. Damage to or malfunction of the unit resulting from excess chlorination or improper water chemistry balance.
3. Replacement of parts which fail or become defective as a result of improper installation, negligence, misuse, abuse or tampering by unauthorized repair personnel.
4. Age, pool water imbalance, and improper installation can cause vinyl pool liners to become brittle or unduly wrinkled. Corrosion of the supporting walls and/or irregularities in the pool base may also cause liner failure. The use of this product in such an environment is at the pool owner's risk. Therefore, the pool owner hereby releases the manufacturer from any and all claims for damage where these conditions exist.
5. The RANGER is designed for use in aboveground pools only. If unit is used in any other application, the pool owner hereby releases the manufacturer from any and all claims. This misuse will void all warranty on the unit.

THE LIMITED WARRANTY PROVIDED HEREIN IS THE SOLE AND EXCLUSIVE WRITTEN WARRANTY WITH RESPECT TO THE BARACUDA RANGER POOL CLEANER. ALL IMPLIED WARRANTIES IMPOSED BY APPLICABLE LAW, INCLUDING ANY IMPLIED WARRANTY OF MERCHANTABILITY OR FITNESS FOR A PARTICULAR PURPOSE, WITH RESPECT TO EACH COMPONENT OF THE BARACUDA RANGER ARE LIMITED TO THE DURATION OF THE EXPRESS LIMITED WARRANTY WITH RESPECT TO SUCH COMPONENT. SOME STATES DO NOT ALLOW LIMITATIONS ON HOW LONG AN IMPLIED WARRANTY LASTS, SO THE ABOVE LIMITATION MAY NOT APPLY TO YOU.

In no event shall Zodiac Pool Care, Inc. be liable in contract or in tort, or under any other legal theory, for lost profits or revenues, loss of use or similar economic loss, or for indirect, special, incidental, consequential or similar damages, even if it has been advised of the possibility of such claim. Some states do not allow the exclusion or limitation of incidental or consequential damages, so the above limitation or exclusion may not apply to you.

No claim under this Limited Warranty will be recognized unless the registration card, included in your box, is completed and returned within fifteen (15) days of the purchase date. Only the original purchaser may submit a claim under this Limited Warranty. Purchaser's claims against Zodiac Pool Care, Inc., shall be limited to those claims which may be asserted under the Limited Warranty relating to any defect, malfunction or wear of the RANGER.

To obtain warranty replacements or repair, the unit should be returned, **freight prepaid**, to an authorized warranty center or directly to: Zodiac Pool Care, Inc., 2028 NW 25th Avenue, Pompano Beach, FL 33069. Call for authorization at (800) 937-7873, in Canada (888) 647-4004. When submitting a claim, always supply serial number, evidence of purchase date, retailer and a brief description of the problems/defects encountered. Zodiac Pool Care, Inc. reserves the right to repair or replace all defective or worn parts covered by this Limited Warranty and return same to purchaser, freight collect.

Zodiac Pool Care, Inc. assumes no responsibility for any warranties or representations made by other individuals or businesses beyond the express terms contained in this Limited Warranty.

This warranty gives you specific legal rights, and you may also have other rights which vary from state to state

For sale and use in the United States, Canada and Mexico only. This pool cleaner is not warranted or guaranteed outside of the United States, Canada or Mexico.

This pool cleaner is covered by one or more of the following Canadian and U.S. patents and Canadian registered design:

U.S. patent nos. 4642 833, 4742 593, 5450 645, 5418 995 and 4982 754.

Canadian patent nos. 1254 105, and 1256 262

Other Patents Pending.

SWIMMING POOL INSPECTION

Important

Vinyl liners are subject to deterioration or damage due to age, the effect of chemicals, corrosion or failure of the supporting walls; as well as improper installation, maintenance or cleaning of the supporting walls or base.

Before installing the RANGER™, examine the interior of your pool carefully. If your vinyl liner is brittle or has stones, wrinkles, roots or metal corrosion in contact with the underside of the liner, or has damage to the base material or supporting walls, do not install the RANGER before having a qualified professional perform the necessary repairs.

TABLE OF CONTENTS

Swimming Pool Inspection.....	3
Prepare the Pool and Filtration System.....	4
Cleaner head and hose assembly.....	4
Installation.....	6
Water Flow Adjustment.....	9
Maintenance and Care.....	10
Troubleshooting Guide.....	11
Accessories.....	11
Quick Access Cassette System.....	12
Parts Diagram.....	14
Let Us Help.....	15

Check that the following parts are included:

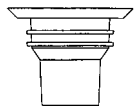

(1) Above-ground Cuff

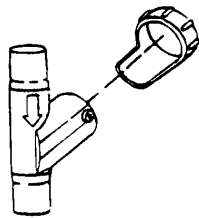

(1) Regulator Valve

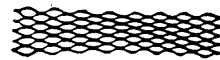

(1) Hose Protector

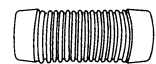

(1) Hose Connector



(1) Pool Pulse™



(2) 45-degree Installation Adapter Elbows

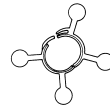

(3) Hose Deflectors

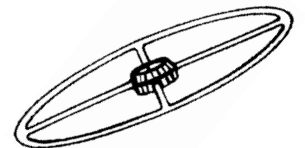

(1) Wheel Deflector

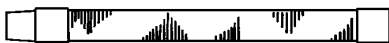

(10) Hose Lengths



(1) Cleaner Head

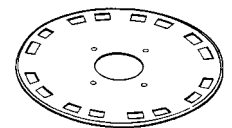

(1) Slotted Disc

If assistance is required, call 1-888-786-7797. In Canada, please call 1-888-647-4004.

PREPARE THE POOL AND FILTER SYSTEM

- Step 1:** Manually vacuum your pool.
- Step 2:** Backwash or clean your filter according to the manufacturer's instructions.
- Step 3:** Empty debris from the skimmer basket and the pump strainer basket.
- Step 4:** **Divert the return flow directional fitting toward the bottom of the pool.** (This prevents the pressure of the return water flow from influencing the natural movement of the cleaner hose.)

Note: If your pool is equipped with a main drain, turn it off.

ASSEMBLY

RANGER™ Head Unit

Slide the disc over the base of the footpad. Be sure it fits properly in the grooves provided.

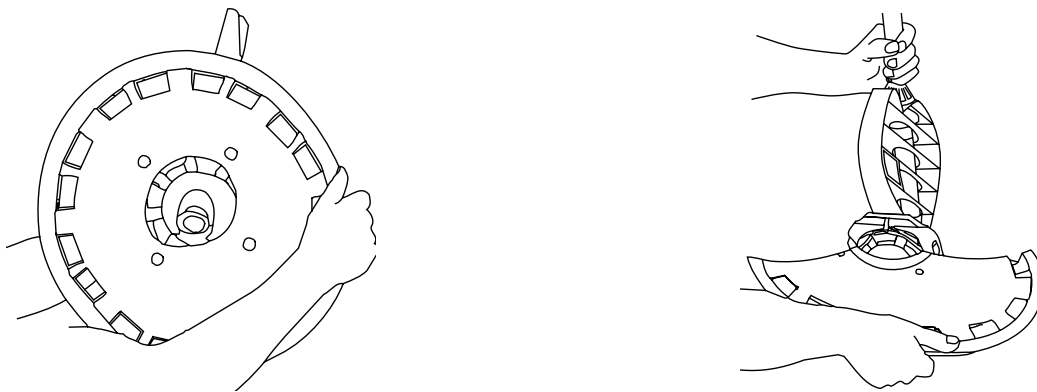

Slide the wheel deflector on to the female end of the hose that will attach to the cleaner head.

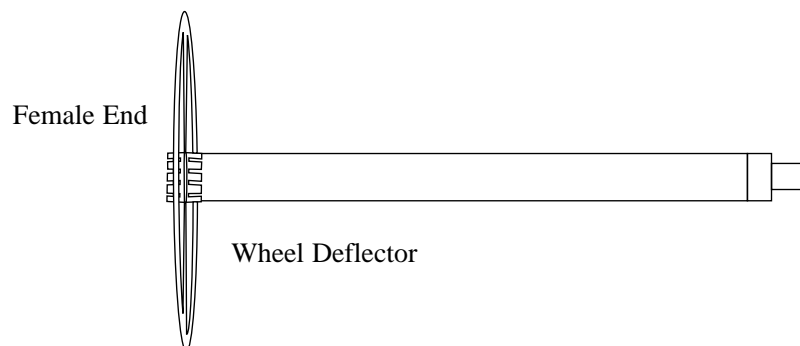

HOSE ASSEMBLY

For Oval Pools: Use enough hose sections to reach the farthest point in the pool from the skimmer, **plus** two to three hose sections. Position the hose deflectors as shown below.

For Larger Pools: For pools larger than 27 feet in diameter, purchase extra hose sections and hose deflectors from your dealer.

For Round Pools: Follow the guide shown below. Connect the hose sections, placing the hose deflectors as indicated in the illustrations below.

21'-27' Diameter (may require one extra hose section)

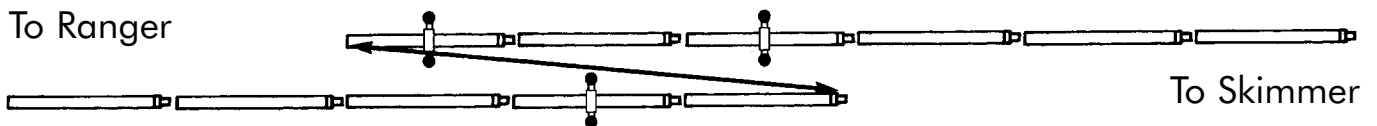

15'-18' Diameter

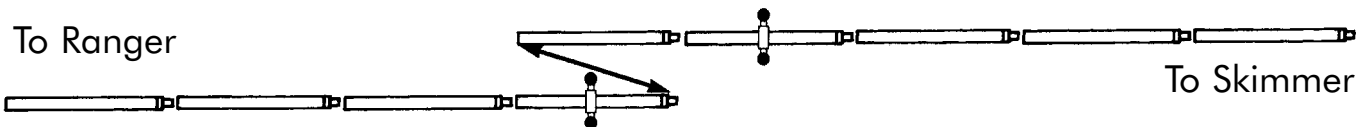

12' Diameter

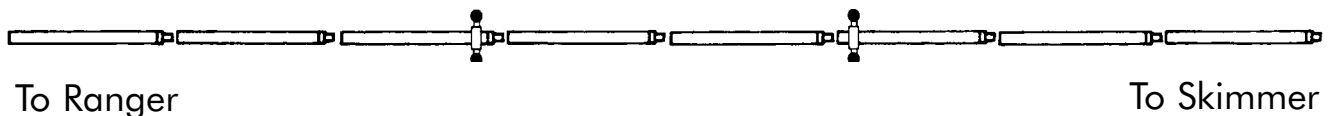

Place the hose connector on the male end of the hose.

The connector end of the hose will attach to the regulator valve. (Skimmer end)

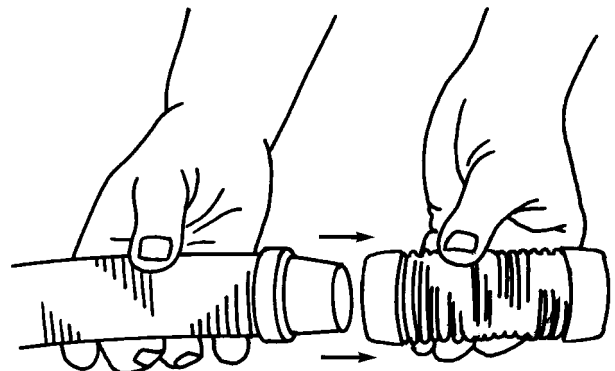

INSTALLATION

Step 1: Turn the filter system off. (Be sure you have turned off the main drain, if your pool has one.)

GENERAL POOL SCHEMATIC

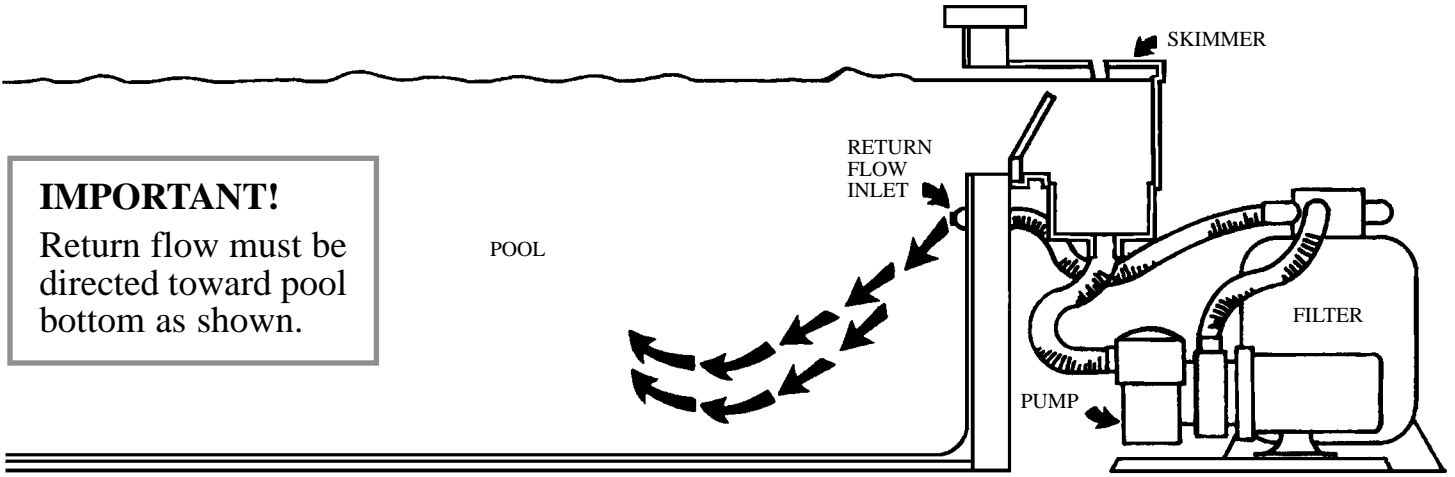

Step 2: Select the fitting combination best suited to your skimmer from figures A, B, C.

FIGURE A

Direct Method
Remove Skimmer
Basket

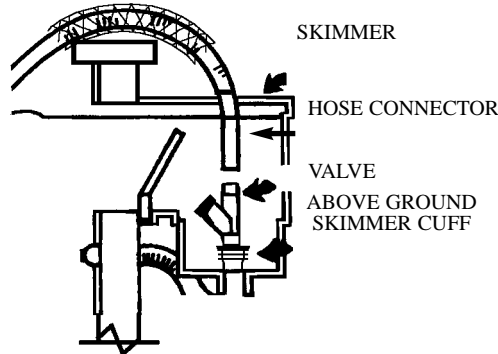

CAUTION:
The regulator valve
MUST be used on
all installations

FIGURE B

With Skimmer Basket and Skim Vac Plate
(supplied with pool)

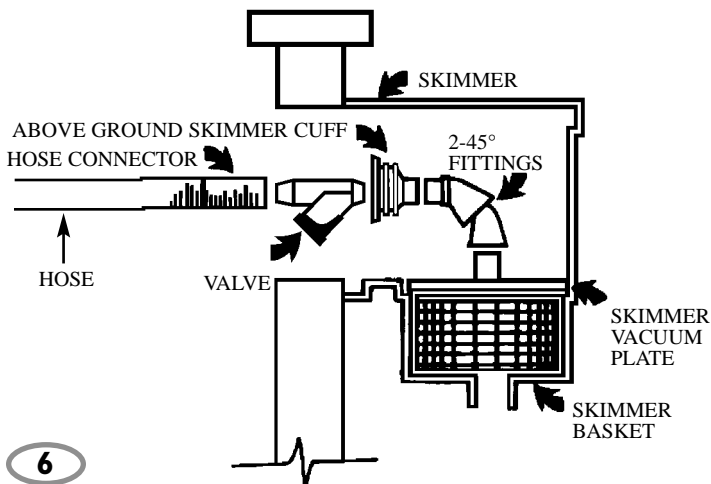
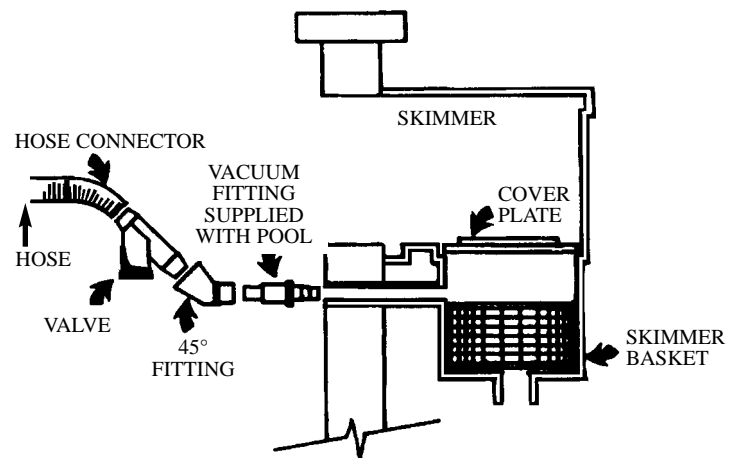

FIGURE C

Vacuum Line Installation



Step 3:

To prevent losing prime to your pool pump, all air must be removed from the hose and the RANGER™ head before connecting them to your system.

Turn the filter system on.

Hold one end of the hose over the return inlet until a full stream of water flows from the other end.

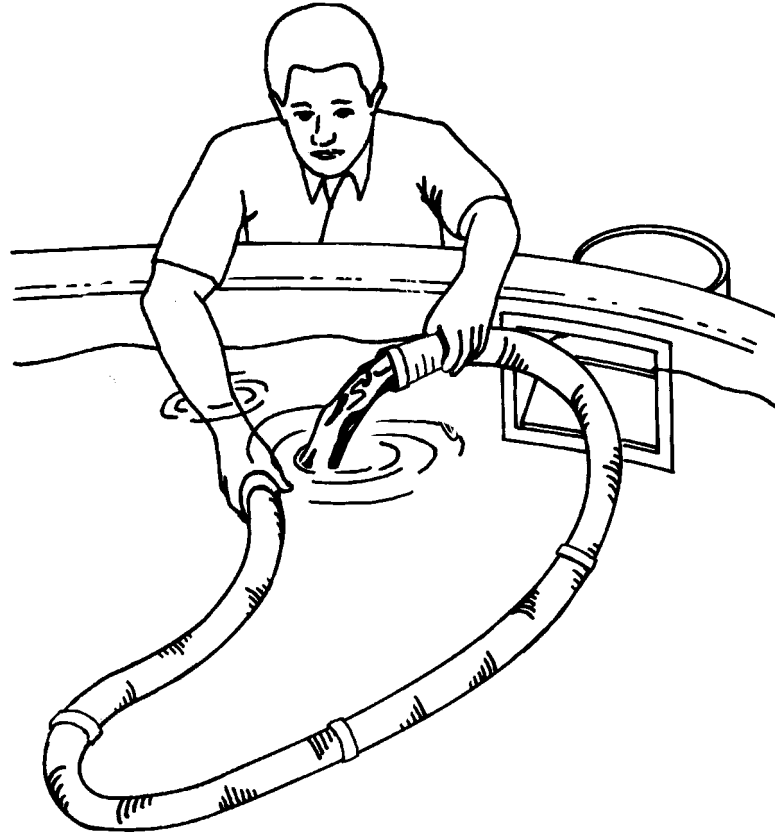
**Step 4:**

Keep both hose ends underwater and completely submerge the RANGER head. When the bubbles have stopped flowing from the head, connect the female end of the hose to the RANGER.

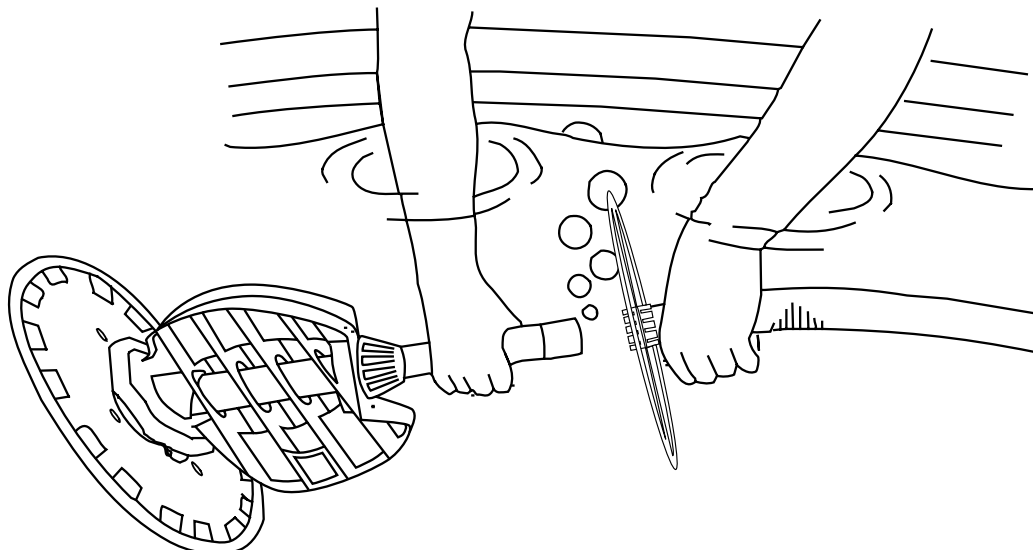

Step 5:

Cover the end of the 4 1/2" hose connector tightly with your hand.

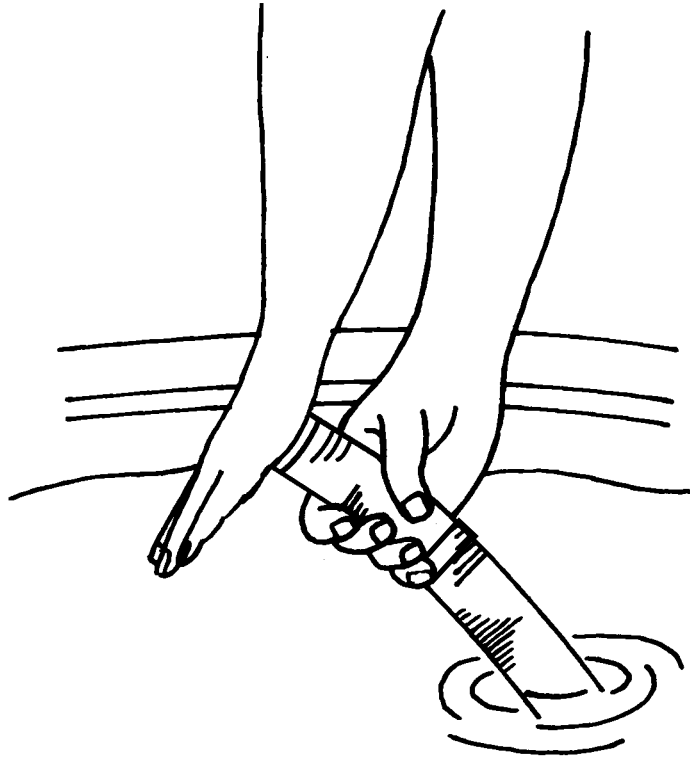

Move to the skimmer and connect the hose end to the fitting combination selected in Step 2. Now insert the end of the assembly into the suction port of the skimmer.

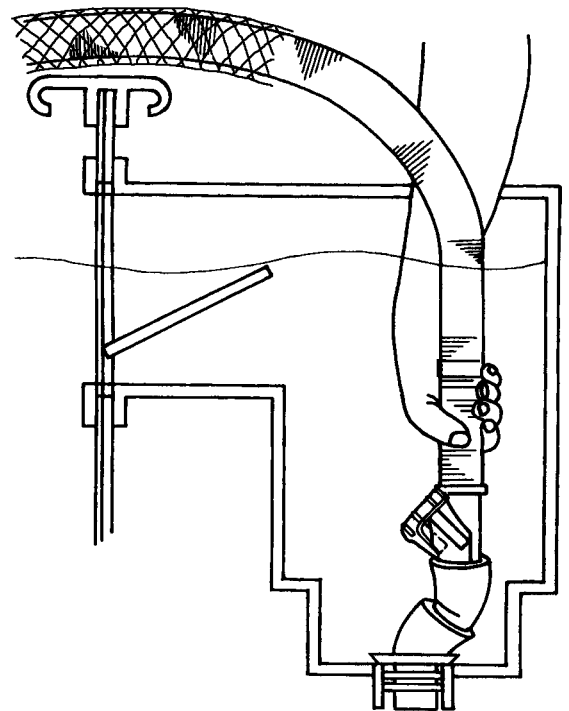
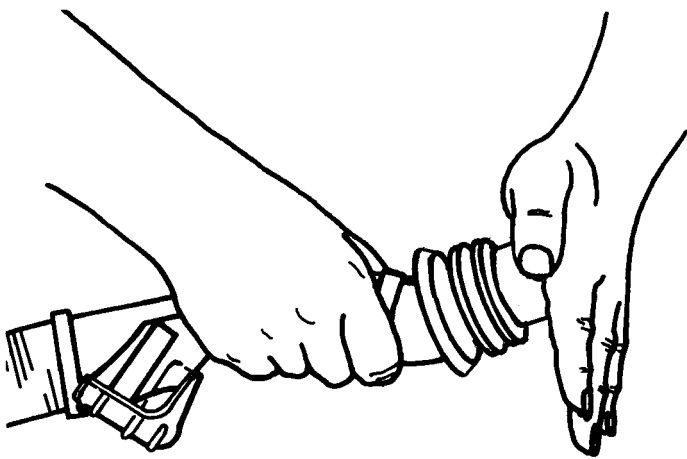

Water Flow Adjustment

For proper performance, the water flow through the RANGER™ **MUST** be regulated.

Step 6: Remove the RANGER™ head from the hose and attach the Pool Pulse™ (Part No. 44805) to the hose underwater. Adjust regulator valve as shown.

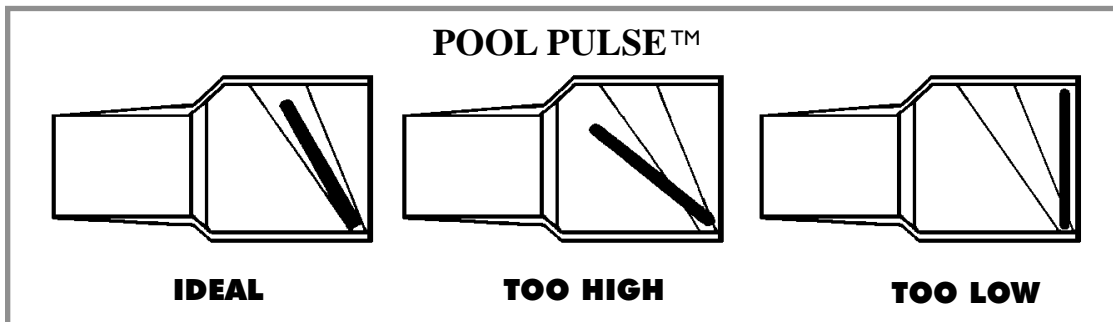
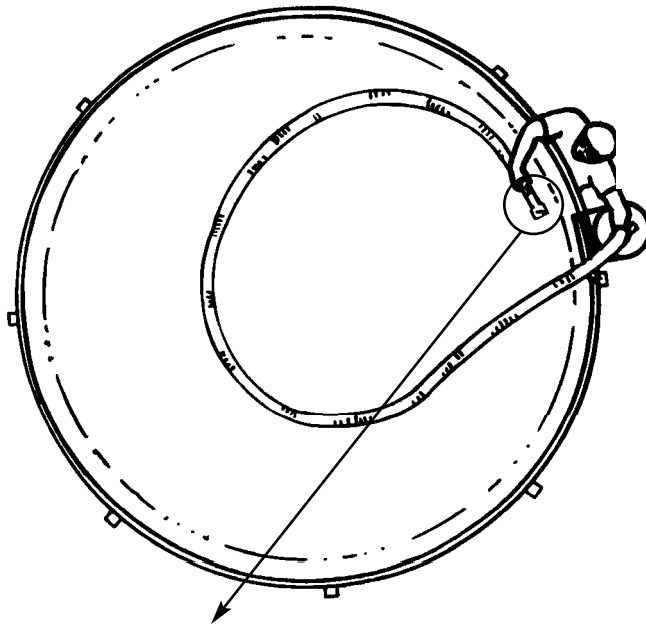
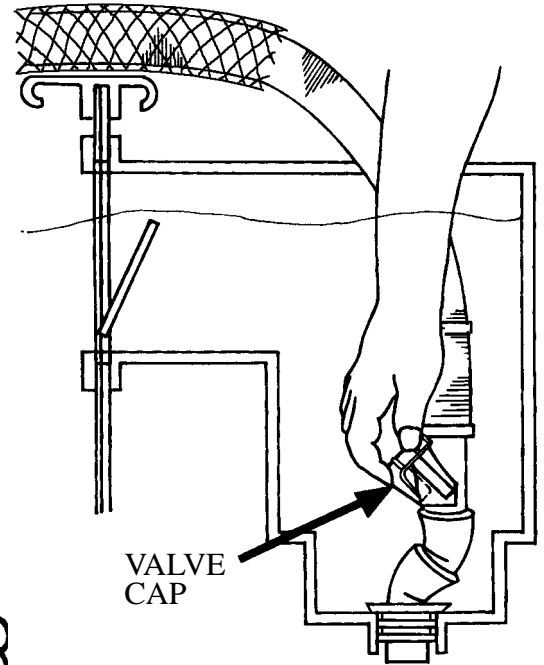
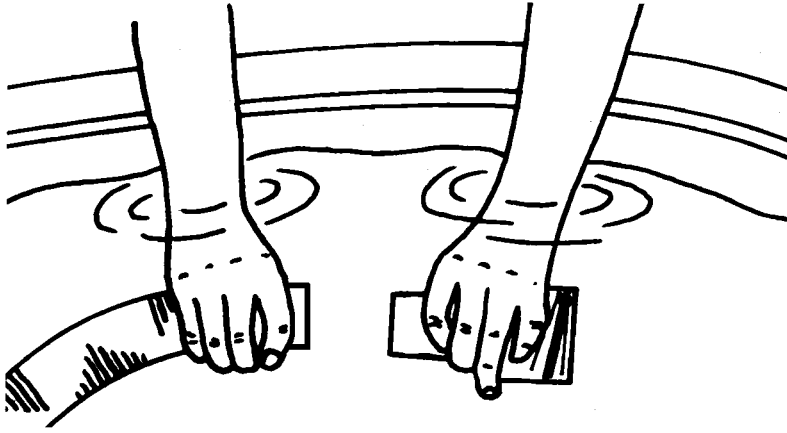

Adjust the regulator valve until the blue indicator of the Pool Pulse™ falls into the clear range (when it is viewed from the side). Turn the valve cap clockwise to increase flow; turn the cap counter-clockwise to decrease flow through the cleaner.

Step 7:

Remove the Pool Pulse™ from the hose end underwater and again submerge the RANGER™ head. When the bubbles have stopped flowing from the head, reconnect the head to the female hose end.

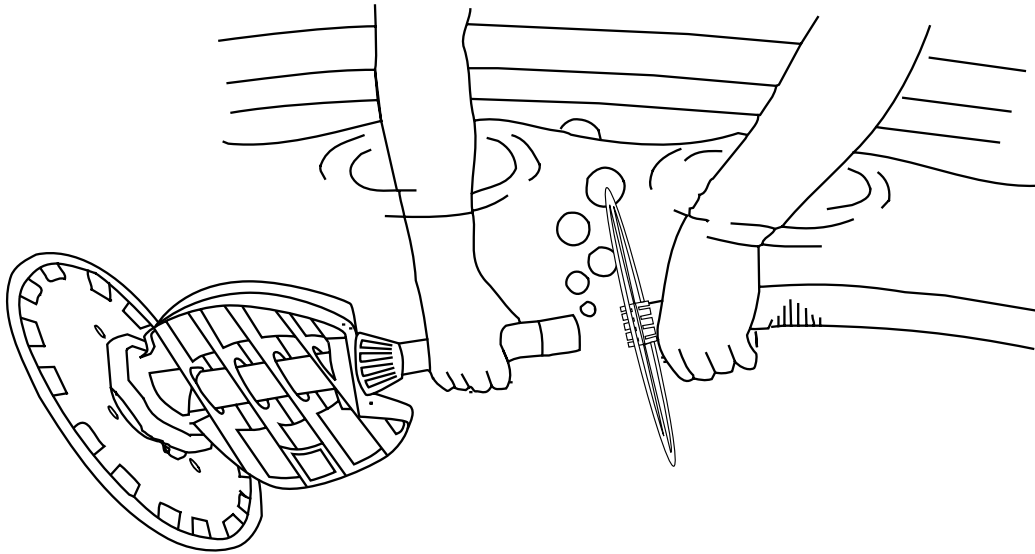

MAINTENANCE AND CARE

1. Remove the RANGER™ from the pool before super chlorinating or other chemical balancing and re-install a minimum of four hours later.
2. Always disconnect the hose from the skimmer before backwashing your filter.
3. Off season storage: remove the disk and store it flat. Store the head in a warm dry place.
4. Always store the hoses straight (in the original box if possible). Never coil the hose. (Coiled hose may be straightened with hot water or by laying in the sun on a warm deck for several hours).

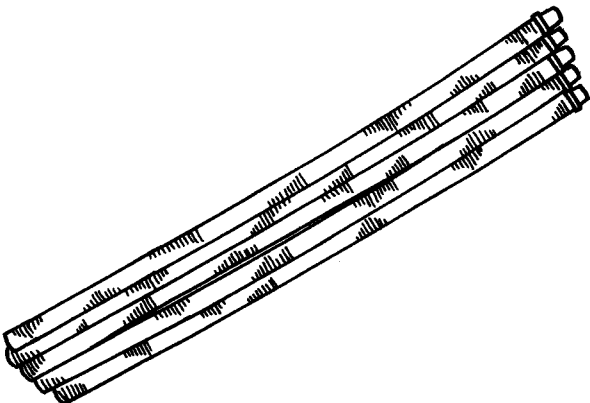

CORRECT

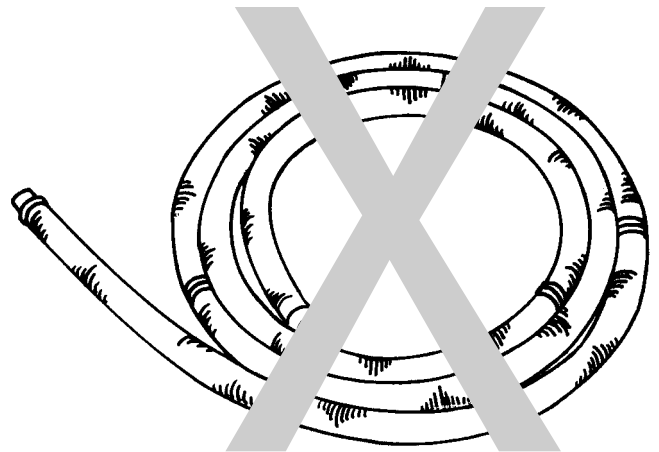

INCORRECT

TROUBLESHOOTING

If you experience a problem with your Baracuda Ranger, please review the installation section and ensure all steps have been followed correctly.

PROBLEM

SOLUTION

1. Machine does not move, or moves sluggishly.

- Ensure ideal flow is being attained using pool pulse. Note: In water 60° F or less, it may be necessary to increase flow to compensate for the reduced flexibility of the hose and diaphragm.
- Check diaphragm for damage or wear (see Care and Maintenance).
- Backwash filter and empty pump basket.
- Check for air in system. If water level in pump basket drops, check hose connections, tighten all fittings at pump, check gasket in pump basket for wear.

2. Machine does not cover entire pool.

- Ensure ideal flow is being attained using pool pulse.
- Point return jets as far down as possible.
- Make sure hose does not have memory from being coiled (see Care and Maintenance).
- Confirm proper hose length
- Confirm proper positioning of hose deflectors.

3. Machine sticks on ladder.

- Ensure ideal flow is being attained using pool pulse.
- Remove ladder if possible
- Install large wheel deflector

4. Machine sticks in steps.

- Ensure correct amount of hose is being used (see Assembly). Shorten if necessary.
- Reduce flow to low side of ideal range.
- Install large wheel deflector

5. Machine stays on walls or edge of pool.

- Reduce flow to low side of ideal range.
- Confirm proper positioning of hose deflectors.

If further assistance is required, please call 1-888-786-7797.
In Canada, call 1-888-647-4004

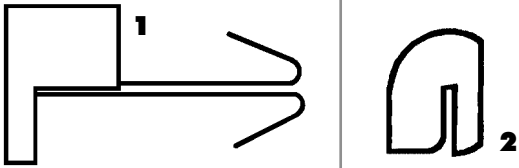
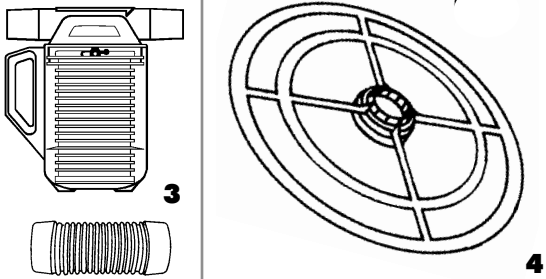

ACCESSORIES

PART ILLUSTRATION	PART NO.	DESCRIPTION
	<p>1. 24100</p>	<p>Return Line Diverter Use when no other return inlet directional fittings exist.</p>
	<p>2. 90155 (for 2" return inlet) 90153 (for 1½" return inle)</p>	<p>Eyeball Return Line Diverter Use to replace standard directional inlet eyeballs</p>
	<p>3. 26705</p>	<p>Leaf Catcher w/ 4½" Connector Use when heavy debris or leaf situations exist.</p>
	<p>4. 46155</p>	<p>Large Wheel Deflector Use when extra clearance needed at steps or other obstacles.</p>

QUICK ACCESS CASSETTE SYSTEM

Unlike other competitive automatic pool cleaners, the RANGER™ has the Quick Access Cassette System. This unique feature allows almost instantaneous access to the one moving part – the diaphragm.

Large foreign objects, such as children's toys, tree branches and rocks, should be removed manually from your pool prior to operating an automatic pool cleaner. In the event a foreign object does not get manually removed and a blockage occurs, the Quick Access Cassette System allows you the opportunity to remove the blockage or check the diaphragm for damage in minutes at poolside.

STEP 1. REMOVAL OF DIAPHRAGM

Holding the frame assembly in one hand, grasp the cassette handnut firmly and turn it counter-clockwise (Figure 1). Pull the complete cassette out of the frame (Figure 2). Holding the cassette at each end, unscrew the cassette pipe from the diaphragm chamber two full turns (Figure 3). Grasp the lip of the diaphragm and pull the diaphragm out. (The inner pipe will be attached and will make a loud noise Figure 4). Pull the diaphragm off of the inner pipe, leaving the retaining ring on the diaphragm (Figure 5).

STEP 2. EXAMINATION

Inspect the diaphragm for the blockage or damage. If damage is evident, i.e., a cut or hole on the sides of the diaphragm, return it, along with head of the unit (excluding hoses), to your authorized Baracuda warranty station for replacement.

If a blockage is apparent, grasp it and remove it. If this can't be done, a garden hose may be used to flush the obstacle through. **Do not use any sharp objects to probe or push an obstruction as this may damage the diaphragm.**

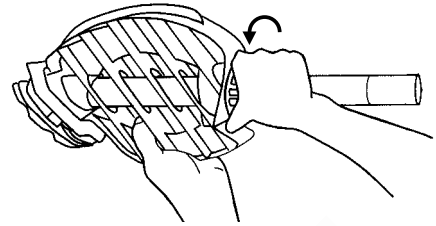

FIGURE 1

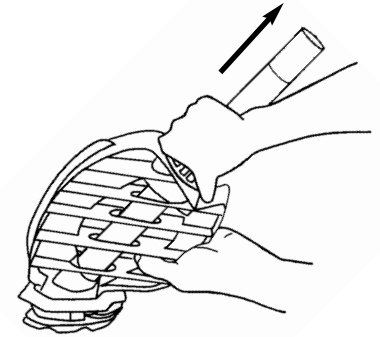

FIGURE 2

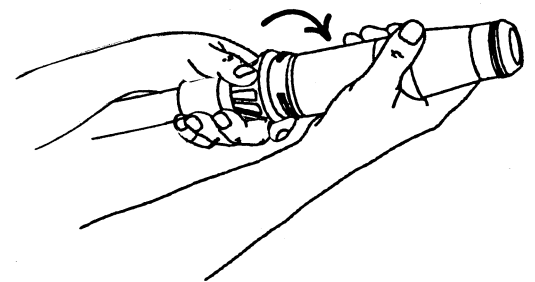

FIGURE 3

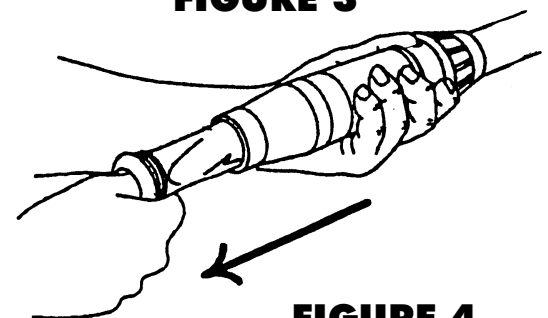

FIGURE 4

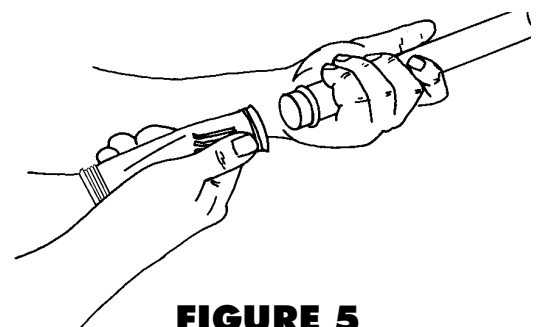

FIGURE 5

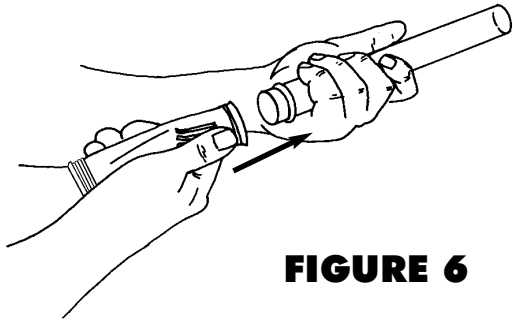

FIGURE 6

STEP 3. DIAPHRAGM ASSEMBLY

Prior to reinstalling the diaphragm, rinse the diaphragm and the inner extension pipe thoroughly to remove any grit or algae. Attach the diaphragm to the inner extension pipe using the retaining ring (Figure 6).

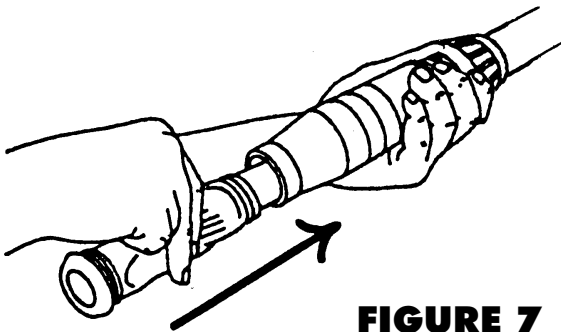

FIGURE 7

Slide the inner extension pipe into the diaphragm chamber.

Pressing on the underside of the diaphragm's ridges, push the diaphragm into the chamber (Figure 7).

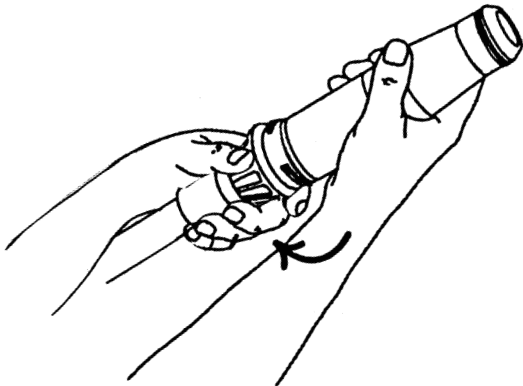

FIGURE 8

Holding the cassette at each end, tighten the cassette pipe until snug. Do not overtighten. (Figure 8).

Insert the cassette into the frame assembly and twist the handnut clockwise until it locks into place (Figure 9).

NOTE: The indicator line on the handnut will line up with the center ridge on the frame assembly.

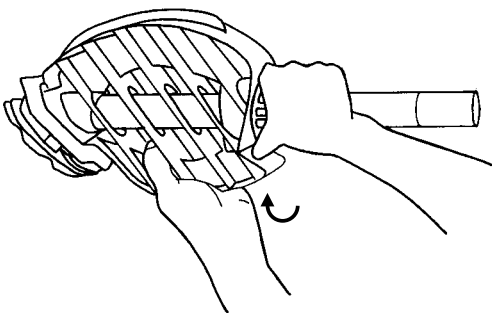
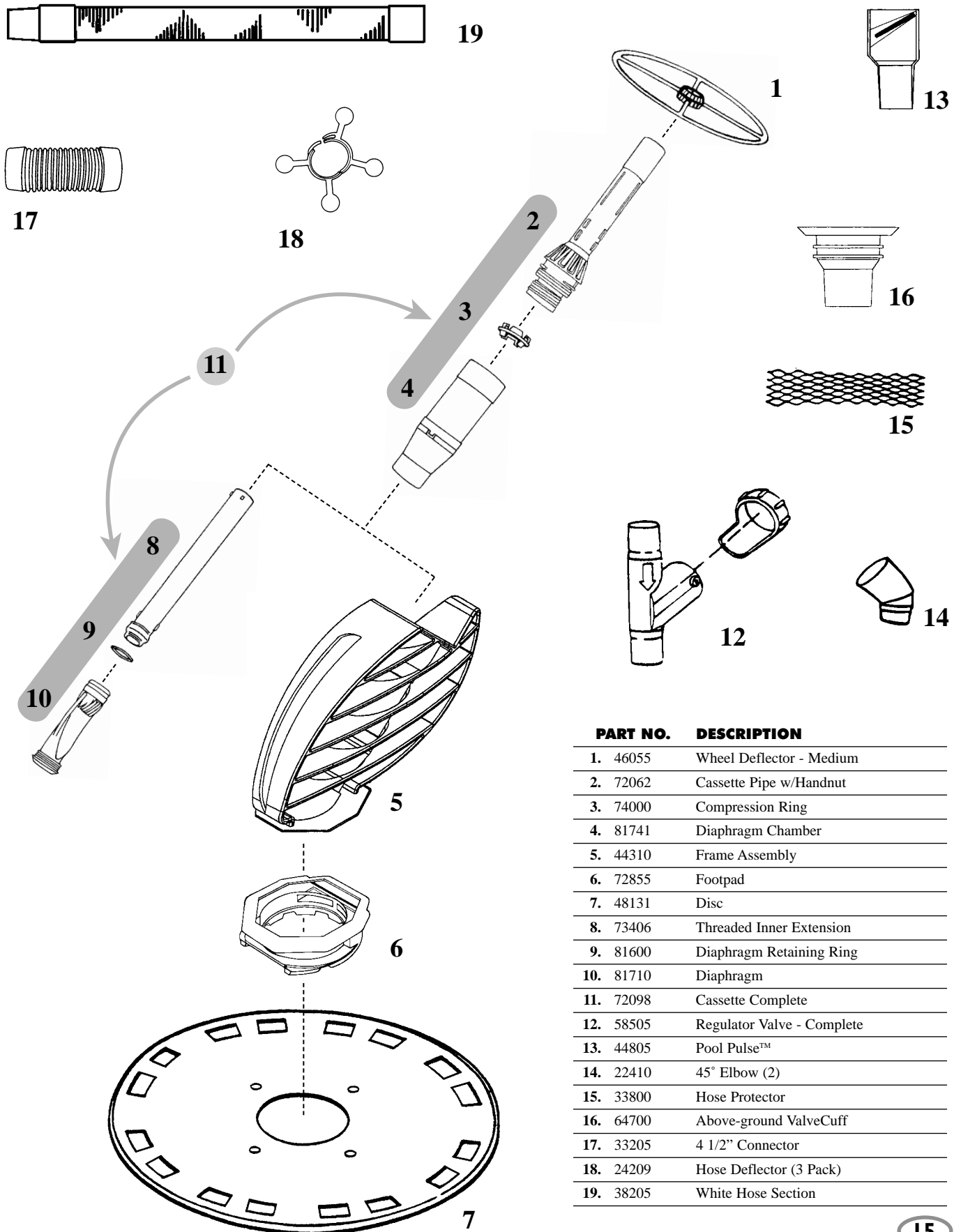

FIGURE 9

RANGER™ PARTS DIAGRAM



PART NO.	DESCRIPTION
1.	46055 Wheel Deflector - Medium
2.	72062 Cassette Pipe w/Handnut
3.	74000 Compression Ring
4.	81741 Diaphragm Chamber
5.	44310 Frame Assembly
6.	72855 Footpad
7.	48131 Disc
8.	73406 Threaded Inner Extension
9.	81600 Diaphragm Retaining Ring
10.	81710 Diaphragm
11.	72098 Cassette Complete
12.	58505 Regulator Valve - Complete
13.	44805 Pool Pulse™
14.	22410 45° Elbow (2)
15.	33800 Hose Protector
16.	64700 Above-ground ValveCuff
17.	33205 4 1/2" Connector
18.	24209 Hose Deflector (3 Pack)
19.	38205 White Hose Section

