

OWNER'S MANUAL

X-COUNTRY SERIES:

Cheetah 1, Cheetah 2, Cougar 1, Cougar 2, CX 1, CX 2

Keep this Owner's Manual for future reference.



www.chariotcarriers.com

WARNING

You should not use the Chariot child carrier before you have read and understood the contents of this Owner's Manual. Failure to comply with the instructions contained herein may lead to an otherwise avoidable accident in which you and/or your passenger(s) could suffer serious injury or death.

Chariot Carriers Inc.
Bay F - 6810 6th ST SE
Calgary AB T2H 2K4
CANADA

Telephone Numbers:
1-403-640-0822 ext 10
1-403-640-0759 (fax)

Chariot Carriers Inc. retains all rights to this Owner's Manual. No text, details, or illustrations from this manual may be either reproduced, distributed, or become the subject of unauthorized use for commercial purposes, nor may they be made available to others.

Additional Manuals for using this carrier may be downloaded from www.chariotcarriers.com.

Great care has been taken in assembling this manual. Nevertheless, should you discover any errors, we would be grateful if you could bring them to our attention.

Table of Contents

1.General Items.....	3
2.Overview of Components.....	4
3.Safety.....	4
3.1 Explanation of symbols and instructions.....	4
3.2 General safety instructions.....	5
3.3 Safety information for all travelling situations.....	5
3.4 Safety instructions for carrying infants.....	6
3.5 Safety instructions for maintenance and repairs.....	6
3.6 Warning against unauthorised modifications.....	6
4.Description of the Ready Chassis.....	6
4.1 Supplied as standard.....	6
4.2 Erecting and folding the carrier.....	7
4.3 Wheel assembly.....	8
4.4 Installing the handlebar.....	9
4.5 Seat and Seatbelts.....	10
4.6 Climate control.....	13
4.7 Storage bags.....	15
4.8 Adjusting the suspension (Cougar and CX).....	16
4.9 Operating the parking brake (Cheetah and Cougar).....	17
4.10 CX brake system owner's manual.....	17
5. Parts lists and exploded views.....	24
6.The Cycling Kit.....	27
• Safety instructions for use as a Bicycle Trailer.....	27
7.The Jogging Kit.....	37
• Safety instructions for use as a Jogging Stroller.....	37
8.The Strolling Kit.....	41
• Safety instructions for use as a Stroller.....	41
9.The Hiking Kit.....	43
• Safety instructions for use as a Hiking Carrier.....	43
10.The XC Skiing Kit.....	45
• Safety instructions for use as an XC Skiing Carrier.....	45
11.Accessories.....	49
12.Service, Care and Storage.....	49
13.Specifications.....	50
14.Wear and Tear.....	50
15.Warranty.....	52

1. General Items

Congratulations and thank you for purchasing a Chariot Carrier!

Congratulations on choosing a X-Country CTS Ready Chassis, the key component of the world's premiere Child Transport System (CTS).

Your new CTS carrier offers superior quality, safety features and comfort. In addition, Chariot CTS Conversion Kits can provide you with the versatility to meet all of your child transportation needs.

The CTS Conversion Kits available from your Chariot dealer are the following:

- Cycling CTS Kit
- Hiking CTS Kit
- Jogging CTS Kit
- Strolling CTS Kit (wheels only)
- X-Country Skiing CTS Kit

Who is this Manual intended for?

This Manual is intended for the purchaser and user of the carrier, who is also responsible for keeping it in proper condition, carrying out maintenance as prescribed and performing repairs.

When using this carrier, please also follow the owner's manual of the bicycle used for towing and the specifications given there regarding the maximum allowable full load for the bicycle.

Performance characteristics of the Ready Chassis, valid for all CTS Conversion Kits

Cargo load of the Cheetah 1, Cougar 1, and CX 1	34 kg/75 lb, 1 child
Cargo load of the Cheetah 2, Cougar 2, and CX 2	45 kg/100 lb, maximum of 2 children
Maximum body height of the children	111 cm (43.7") (head or helmet must not protrude above the carrier frame)

Intended Use

Use as intended

The carrier is intended for use within the performance ranges specified for the carrying of children in daylight hours, on sidewalks, light traffic public roads, and smooth paths. Luggage may also be carried in the storage bags intended for that purpose, provided the children in the carrier are not put at risk.

If the child carrier is used in conditions of poor visibility, at dusk or in the hours of darkness, it is highly recommended to be fitted with a safety approved working light set.

As part of the recommended use, you should also follow this Owner's Manual and comply with the prescribed maintenance requirements.

Use not recommended

Any use that goes beyond the above is not recommended.

Use not recommended is primarily the conveying of people together with animals, use of this carrier on rough off-road terrain, use for commercial purposes, overloading, excessive speed and improper repair of defects or modifications.

The manufacturer is not liable for damages arising from use that is not recommended – this is at the risk of the user.

2. Overview of Components

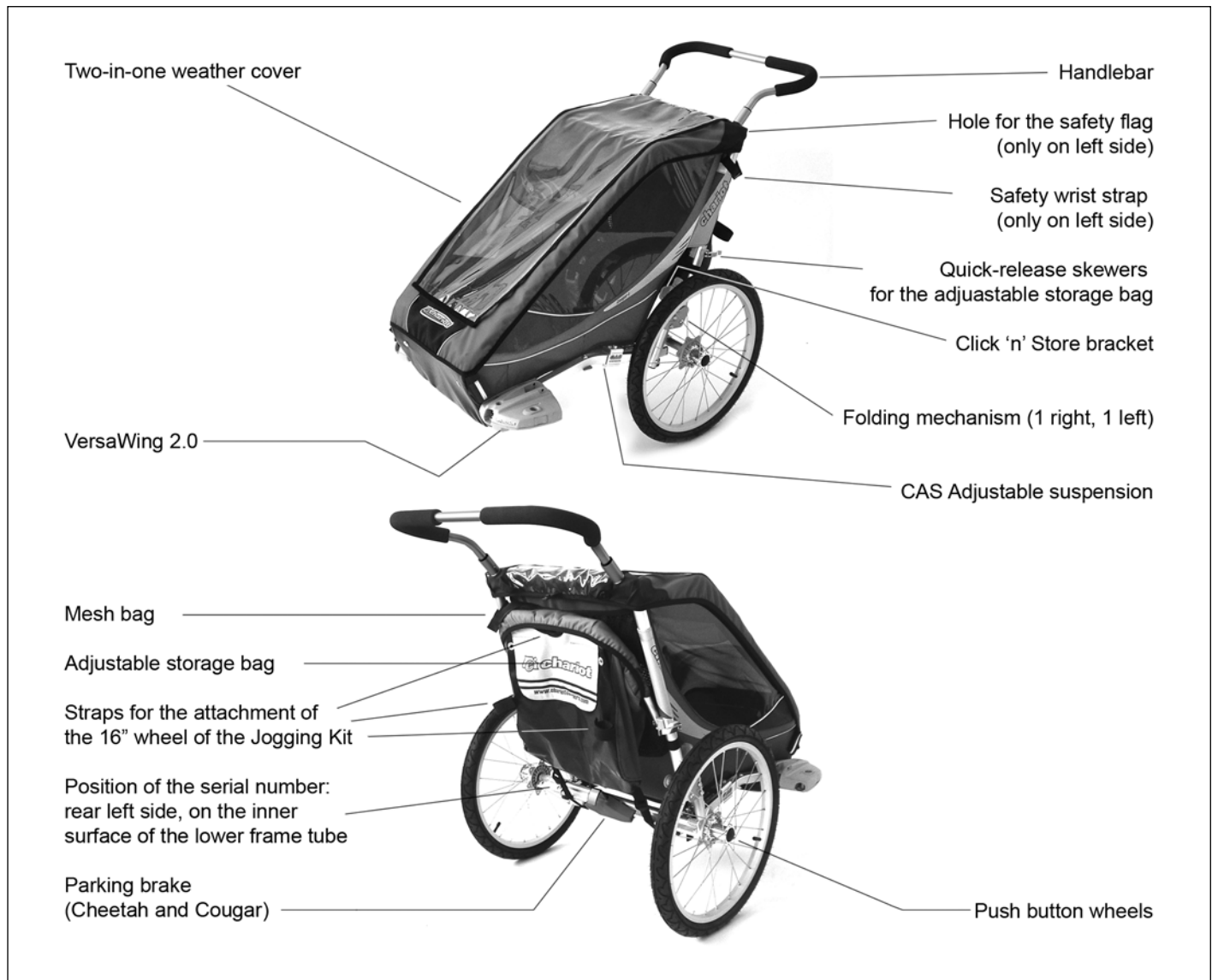

3. Safety

The purpose of this section is to acquaint you with the symbols and safety instructions and make you aware of general dangers that might arise in using the carrier. In addition, here you will get to know about the particular dangers when using the carrier in road traffic, as well as being warned against unauthorised rebuilds or modifications.

This section, which is entitled »Safety«, is the most important section in this Owner's Manual. For this reason you need to read through it with particular care and take note of all instructions.

3.1 Explanation of symbols and instructions

In this Owner's Manual all items relating to safety are provided with a warning. In the designation of the possible hazards, distinctions are drawn based on the severity of the possible harm that may arise.

⚠ WARNING

Here you will find instructions where failure to comply may result in injury or even death to the user and/or the carrier's passenger(s).

NOTE

Instructions introduced with this symbol indicate possible risk of material damage. Failure to heed this warning may result in material damage.

TIP

Here you will find instructions that will make using the product easier for you.

3.2 General safety instructions

Basics

- Before using the carrier, please read through the Owner's Manual carefully. Failure to comply with the safety instructions may result in serious personal injury or death, to both the user and/or the occupants of the carrier.
- When using the carrier, always comply with local safety and accident prevention regulations, as well as the local Road Traffic Act, all of which may restrict use in some way.
- Safe and appropriate use of the carrier is your responsibility. Before using the carrier for the first time, acquaint yourself with its handling characteristics away from public roads and without carrying children. An empty carrier will tip over more easily when going over obstacles with one wheel only than one carrying a load. A fully loaded carrier makes greater demands on the deceleration devices.
- Negotiate inclines and corners with the utmost caution and reduce speed when doing so.

With regards to transporting children

- Never leave your child unsupervised in the carrier.
- Regularly check that your children are appropriately clothed and that they feel comfortable especially in hot and cold temperatures.
- Only children who are over 1 year old and who can sit up without support may be carried.
- The maximum height of children who may be carried is 111 cm (43.7").
- In carriers designated as single-seaters only one child may be carried; in two-seater carriers the maximum is two children.
- Make sure that the limbs, clothing or toys of the child do not come into contact with the carrier wheels or the rear wheel of the towing bicycle.

With regards to the carrier

- Never carry any heavy or sharp protruding items in the storage space of the carrier if you are also carrying children at the same time (risk of injury on braking).
- Items of luggage should be well secured so that they cannot move around during the journey. Unsecured items of luggage and overloading reduce riding stability and make the carrier more difficult to handle.
- The carriers are bicycle carriers and must never be towed behind motorised vehicles.
- The carriers must not be carried on the roof of a vehicle, even when folded, as they will get damaged.
- At various points on the carrier, self-locking nuts are used. If these have been loosened they must not be reused. Once they have been loosened they lose their original function, and this can lead to unexpected loosening of the screw connection with potentially serious consequences.
- Do not use the carrier at temperatures below -20°C / -4°F and do not store it at these temperatures. The windows may break.
- When folding up or opening the carrier, there is a risk of pinching your hand or fingers.

With regards to the children in the carrier

- When converting with other CTS Conversion Kits, no child should be sitting in the carrier, nor when carrying out maintenance or repair work.
- The permitted total cargo load of the carrier is limited to 34 kg / 75 lb on the single-seater and 45 kg / 100 lb on the two-seater. This must never be exceeded. The cargo load is the weight of the children together with any luggage there might be.
- Please explain to your child that he/she must not bounce, fidget or lean out of the carrier.

3.3 Safety information for all travelling situations

With regards to the children in the carrier

- Never carry items of luggage on the seat next to your child.
- Never carry animals together with your children.
- Always make sure the seatbelts are correctly fastened around your child and are correctly adjusted to the height of your child. If this is not the case, your passenger(s) could suffer serious injury or death in the event of an accident.
- When travelling faster than walking pace, always use at the very least the mesh component of the two-in-one weather cover.
- As the children get in and out, the parking brake must be on to prevent the carrier from accidentally rolling away.

With regards to the carrier

- Take care when travelling over uneven surfaces. The carrier can overturn if driven with one wheel only across uneven ground, even at very low speed.
- Before each journey check the tire pressure. The minimum recommended pressure is 30 psi (2.1 bar) and the maximum is 35 psi (2.5 bar). Even if a higher pressure is permitted for the tires fitted, the Manufacturer recommends that 35 psi (2.5 bar) not be exceeded. Air pressure that is too high considerably reduces the comfort of the children, especially on carriers without suspension. Air pressure that is too high can also cause the plastic wheels on the Cheetah model to fail.
- Do not use compressed air lines (e.g. at service stations). The tyres may burst due to the small volume of the tubes.
- Never go up or down steps with the carrier.
- Before each journey check that the wheels are fully engaged.
- Before each journey check that the folding auto-lock disk is fully engaged.
- Before each journey check that the spring buttons of the handlebar are fully engaged.

3.4 Safety instructions for carrying infants

- Children who cannot as yet sit up without support may only be carried using the Chariot infant Sling (accessory).
- The Manufacturer accepts no liability for use of other sitting aids or baby seats.
- Please make sure you follow the safety instructions in the Chariot Infant Sling Owner's Manual

3.5 Safety instructions for maintenance and repairs

- The maintenance work specified (see Section 12) is absolutely essential for the long-term safe operation of the carrier.
- Only use original spare parts. When replacing safety-related parts, such as the frame, wheels, hitcharm and fabric, only have this carried out by an Authorized Chariot Retailer.
- Regularly check all safety-related parts, such as the frame, wheels, hitcharm and fabric, for damage or tearing. At the first sign of damage have the relevant part replaced by your Authorized Chariot Retailer.
- Tears in the fabric actually represent a high safety risk. Due to tears in the fabric your child could come into contact with the wheels or the road surface.
- If you find a tear in the fabric, stop using and contact your Authorized Chariot Retailer immediately: the fabric can either be repaired or replaced.
- Never try to straighten out bent safety-related parts such as the frame, wheels or hitcharm. Have the relevant part replaced by your Authorized Chariot Retailer. There is a risk of it cracking and subsequently breaking.
- We recommend annual maintenance of the wheels by your Authorized Chariot Retailer.

3.6 Warning against unauthorised modifications and additions

- Unauthorized rebuilds or modifications of the carrier are not permitted for reasons of safety and render the warranty invalid.
- Installation of a car safety seats, other seats, or seat supports that do not carry the approval of the manufacturer is not permitted.
- Do not fit any additional parts, such as a luggage rack, that do not carry the express of the manufacturer.
- The carrying of pedal cars, which are attached to the handlebar or some other part of the carrier, is not permitted.

NOTE: All references to orientation (i.e. left or right) is from the passengers point of view while sitting in the carrier.

4. Description of the Ready Chassis

4.1 Supplied as standard

Cheetah 1, Cheetah 2, Cougar 1, Cougar 2

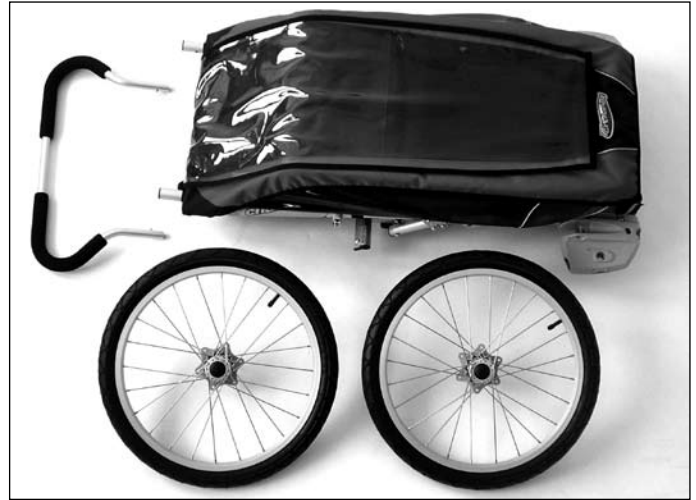

Carrier with two-in-one weather cover, two 20" wheels, and handlebar

CX 1, CX 2

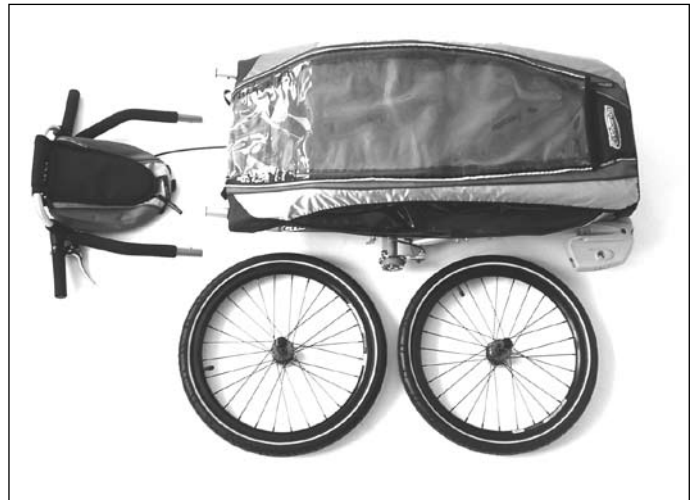

Carrier with two-in-one weather cover, two 20"/51cm wheels with drum brakes; handlebar with brake lever, connected to the passenger compartment by brake cable (**Note: Do not bend!**); handlebar bag on handlebar; 2 plastic caps on the brake drums (**keep in a safe place!**)

NOTE

Take care not to bend the brake cable which connects the handlebar with the passenger compartment on the CX. This might reduce the braking effect, or the brake may not continue to function.

4.2 Erecting and folding the carrier

Erecting the Ready Chassis

Push down the axle socket with your left hand, and at the same time push up the left frame tube using your right hand. Then pull the short lower side tube backwards with your left hand, pressing against it from above with your right hand. Repeat this procedure on the right-hand side.

When pulling the short lower side tube backwards, the auto-lock disk must audibly engage in each case.



The assembly of the CX requires particular attention. Care needs to be taken here that the brake cable (see Section 4.10) is not bent or damaged in some other way. It must run along the frame tubes as illustrated.

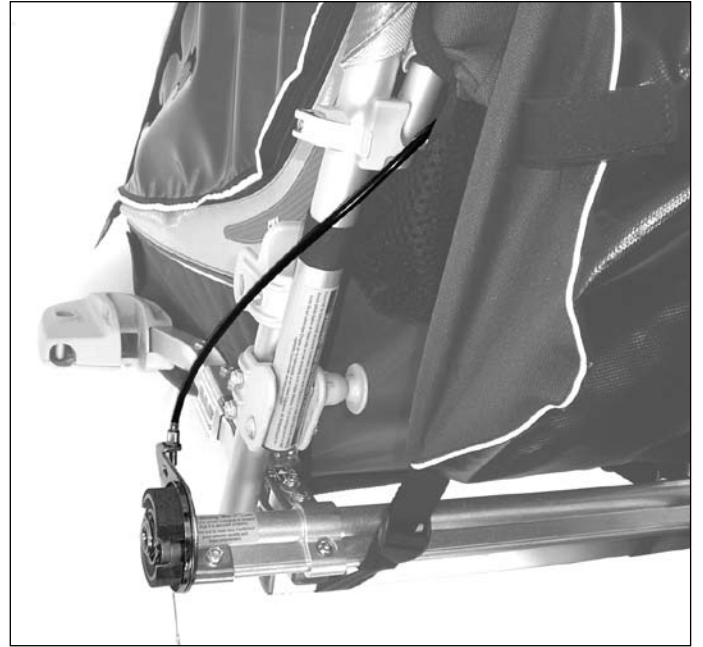

NOTE

Take care not to bend the brake cable which connects the handlebar with the passenger compartment on the CX. This might reduce the braking effect, or the brake may not continue to function.

⚠ WARNING

Before each journey make sure that **both** auto-lock disks are engaged. If this does not happen, the passenger compartment may collapse unintentionally in which your passenger(s) could suffer serious injury or death.



Auto-lock disk

Folding the Ready Chassis

When folding the CTS Ready Chassis, the procedure is the reverse of the above: First pull or release the auto-lock disk on one side and push the short lower side tube slightly forwards. Repeat this procedure on the other side. Push the short lower side tube fully forwards.

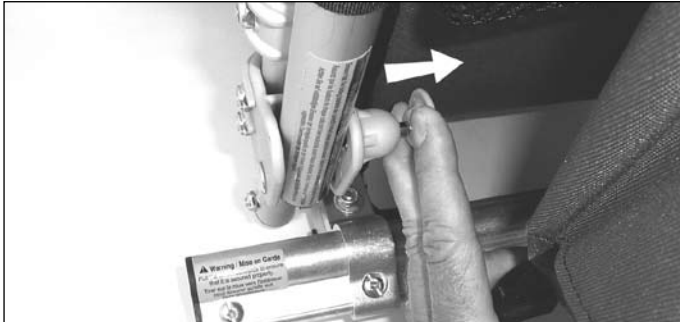

NOTE

Do not attempt to fold up the passenger compartment without disengaging the auto-lock disk.

NOTE

When folding up the CX the handlebar cannot be completely removed because of the brake cable. You can pull it out of the upper frame tube ends and then store it on the folded carrier to save space.

TIP

The passenger compartment can only be completely folded up if the rear storage bag is folded up (see Section 4.7), except on the Cheetah, where the storage bag is fixed in position.

TIP

The passenger compartment can only be folded up if the hit-charm is removed from the out-of-use storage position in the Click 'n' Store bracket (located at the top of the short lower side tube at the rear); see Sections 6 and 7.

4.3 Wheel assembly

The wheels of the Chariot models described are fitted with so-called push-button axles. Pressing on the rubber cap in the wheel centre will loosen the retaining balls which lock the axle in the axle socket. The wheels can only be fitted and removed with the plastic cap pushed in.

TIP

The easiest way to fit the wheel is to lay the carrier on its side.

TIP

On the CX, first remove the plastic protective caps from the brake drums. Keep the plastic caps safe, so that you can refit them when you next remove the wheels.

To fit the wheel, press in the rubber cap and insert the wheel axle into the axle socket until it can go no further. Release the rubber cap. By moving the wheel from side to side, check that it is locked in the axle socket and cannot be pulled off.



⚠ WARNING

Before each journey make sure that the wheels are securely locked in the axle socket. Failure to do so could result in the loss of the wheels causing an accident in which you and/or your passenger(s) could suffer serious injury or death.

TIP

If the wheels on the CX cannot be inserted, this may be due to the adjustment or the cables on the brake system. In this case, please see Section 4.10.

4.4 Installing the handlebar

Cougar and Cheetah

Push the handlebar into the upper frame open tube ends. Depress both spring buttons simultaneously and push both ends of the handlebar at the same time into the tube ends until the spring buttons engage.



The handlebar's height can be adjusted for two different positions: remove by depressing the spring buttons together, pull out the handlebar, rotate it 180° and re-insert the handlebar into the tube ends.



⚠ WARNING

Before each journey make sure that the spring buttons of the handlebar are fully engaged. Failure to properly install the handlebars could cause the carrier to become separated from you resulting in an accident in which your passenger(s) could suffer serious injury or death.

CX

The handlebar of the CX is installed in the same manner as described in the section above. Only one position is possible however, as the ergonomic five-position CX handlebar allows it to be gripped in various height positions, depending on use.



NOTE

Always make sure that you do not bend the brake cable of the CX. This might reduce the braking effect, or the brake may not continue to function.

⚠ WARNING

Before each journey make sure that the spring buttons of the handlebar are fully engaged. Failure to properly install the handlebars could cause the carrier to become separated from you resulting in an accident in which your passenger(s) could suffer serious injury or death.

Handlebar bag (CX)

The Chariot CX is equipped as standard with a handlebar bag, which can also be used as a child backpack. For the other models the handlebar bag can be purchased as an accessory.

The handlebar bag is attached to a specially designed buckle at the upper rear end of the passenger compartment, as well as to the handlebar itself by means of two straps with buckles.



⚠ WARNING

For the handlebar bag, the maximum cargo load is 1 kg / 2.2 lb. When loading the handlebar bag, care must also be taken to ensure that there is not too much weight loaded into the rear storage bags, otherwise the carrier could tip backwards resulting in an accident in which your passenger(s) could suffer serious injury. In this regard, please make sure you follow the specifications and descriptions given in Sections 7 and 8.

Safety wrist strap

On the rear left upper side frame tube, there is the safety wrist strap, which is required to secure the carrier to your wrist when using it as a Jogging Stroller or Stroller. In all other travelling situations this safety wrist strap should be stored safely in the rear mesh pocket (see Section 4.7).



WARNING

Failure to use the wrist strap could cause the carrier to become separated from you resulting in an accident in which your passenger(s) could suffer serious injury or death.

NOTE

Always make sure the safety wrist strap is safely stored in the mesh pocket when it is not in use. If this is not done it could get caught in the wheel spokes, and this may result in an accident.

4.5 Seat and Seatbelts



To fasten the child into the carrier, proceed as follows:

1. The shoulder harness should always stay fastened to the crotch belt by their shared lower buckle.
2. Undo both of the top buckles of the padded shoulder harness on the back rest. Take off the shoulder harness towards the front.
3. Open the waist belt.
4. Place the child on the seat.
5. Make sure that the crotch belt is between the child's legs.
6. The shoulder harness's upper two buckles are attached to vertical straps. Now move both upper buckles until they are directly above the shoulders of the child.
7. Draw the shoulder harness upwards over the child's shoulders and click both of the upper buckles into their respective buckles on the vertical straps. Make sure that you do not pinch the child's neck with the buckles.
8. Once again make sure that the crotch belt is between the child's legs.
9. All belts can be adjusted. The shoulder harness can be adjusted to fit correctly by pulling tight or loosening the loose ends of the upper securing straps to equal degrees. The loose end of the crotch belt can be pulled tight or loosened like this as well.

10. Adjust the shoulder harness and crotch belt to fit so that all belts are tight and the lower end of the padded shoulder harness with the “Chariot” logo is level with the child’s lower chest region.
11. Fasten the waist belt. The waist belt must be on the outside of the crotch belt.
12. On each side of the buckle, the waist belt has a loose belt end for adjusting to fit correctly on the child. Adjust the waist belt until it is tight and the buckle is in the centre in front of the crotch belt.
13. Finally check that all belts are tight. However, avoid putting too much pressure on the child’s body.
14. Make sure that the padded shoulder harness’s belt position is correctly adjusted, as described below.



M: Sleeve through both webbing loops. This is the default setting.

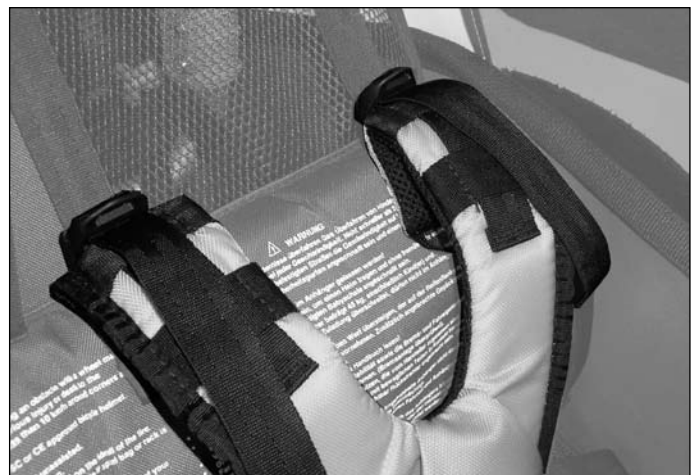
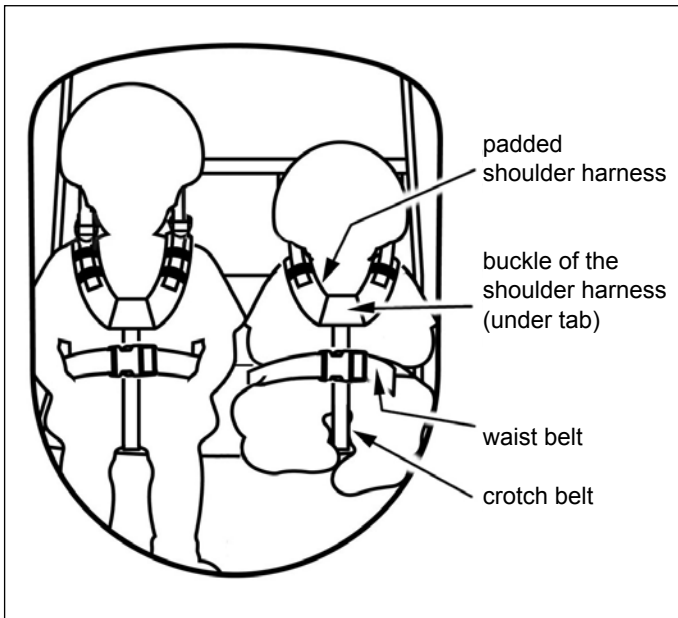

L: Sleeve through both webbing loops and the top cord loop.

Adjusting the padded shoulder harness

To achieve the correct size of the padded shoulder harness, sleeve through or remove the shoulder belts with the plastic buckle through these adjustment loops, as indicated below:

XS: Do not sleeve through any adjustment loops; thus unsleeve the shoulder belts from all loops.

S: Only sleeve through the lowest webbing loop. When sized for XS and S, the un-used, upper sections of the shoulder harness go loose over the children’s shoulders. Smooth them down their back for comfort.



TIP

Always sleeve or unsleeve the shoulder belts as described above equally on **both** sides of the padded shoulder harness, otherwise the shoulder harness will not sit properly, and correct fit of the seatbelts is not possible.



Comparison of different adjustments of the padded shoulder harness for children of different heights.

TIP

Depending on manufacturing tolerance, the above mentioned loops may turn out to be too narrow to pull the buckles through them. To make unthreading easier in this situation, you can unthread the buckles and then rethread them as in the illustration below.

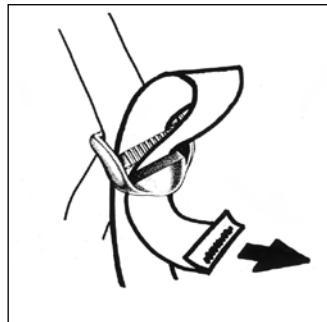
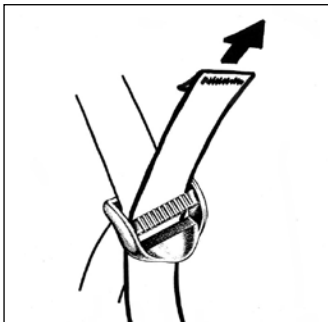

⚠ WARNING

Always make sure you thread the belt through correctly (see illustration above). If this is not the case, the belt could slip out of the buckle resulting in the seatbelt failing in which your passenger(s) could suffer serious injury or death.

Whenever you thread the belt through again, always give it a good pull to check that it cannot be pulled out of the buckle.

⚠ WARNING

Always make sure the seatbelts are correctly fastened around your child and are correctly adjusted to the height of your child. If this is not the case, your passenger(s) could suffer serious injury or death in the event of an accident.

⚠ WARNING

belt system may fail resulting in an accident in which your passenger(s) could suffer serious injury or death.

If only one child is being carried in a two-seater carrier, then he/she must sit in the centre of the seat.

To fasten the child into the carrier, proceed as follows:

1. Fasten one of the shoulder harnesses to the middle two vertical straps buckles on the backrest.
2. Use the two middle waist belts.
3. Use the additional crotch belt located in the middle of the seat.
4. The second shoulder harness, the two outer crotch belts, and the outer two waist belts are not used.
5. Adjust the belts as previously described.

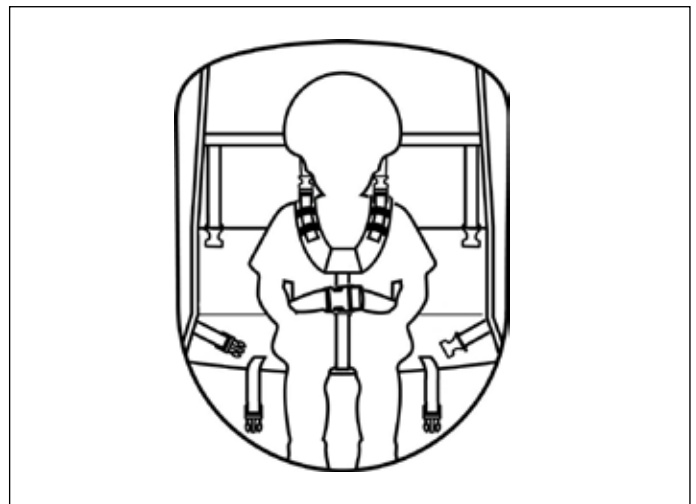

⚠ WARNING

Always make sure you thread the belt through correctly (see illustration above). If this is not the case, the belt could slip out of the buckle resulting in the seatbelt failing in which your passenger(s) could suffer serious injury or death.

Whenever you thread the belt through again, always give it a good pull to check that it cannot be pulled out of the buckle.

⚠ WARNING

Always make sure the seatbelts are correctly fastened around your child and are correctly adjusted to the height of your child. If this is not the case, your passenger(s) could suffer serious injury or death in the event of an accident.

⚠ WARNING

Before each journey check **all** buckles. If this is not done, the belt system may fail resulting in an accident in which your passenger(s) could suffer serious injury or death.

4.6 Climate control

The two-in-one weather cover

All models are equipped with the Chariot two-in-one weather cover, which consists of a plastic window that can be rolled up with mesh beneath it.



The two-in-one weather cover is secured at the bottom by a double velcro fastener. First the velcro tag of the two-in-one weather cover is pressed onto the velcro surface on the carrier. Then the velcro on the carrier is pressed from the outside against the velcro tab of the two-in-one weather cover.



NOTE

Always make sure that the velcro fastener is properly fastened.

Opening the two-in-one weather cover:

First undo the outer tabs of the assembly at **both** velcro fasteners. Then lift the two-in-one weather cover upwards, pulling equally on **both of its** tabs.

TIP

On the Cougar and CX, make sure the upper corners rubber seal of the two-in-one weather cover is properly seated. If this is not the case, the seal will not effectively prevent water penetration.



Sunscreen

A sunscreen is located under the upper rear of the two-in-one weather cover.



If it is not being used, it can be rolled up and secured with the loops located at the top corners. The two-in-one weather cover is then placed over it and fastened.

Sunscreen on the CX (all covers can be rolled up and secured with the loops except the CX has an extended length flap)

On the CX the front extended length tinted flap can be rolled up and secured with two loops.

At low temperatures the sunscreen can be unrolled, flipped back, and inserted in the mesh pocket behind the seat (see Section 4.7). This reduces penetration of cold air through the mesh parts of the seat backrest.



WARNING

On the CX, the front tinted flap must be rolled up or folded inwards to insert the sunscreen in the mesh pocket behind the seat. If this is not done, the sunscreen will be too long and it may get damaged.

Front side air vent on the Cougar

For additional ventilation of the interior, the Cougar is equipped with a side air vent to the front of each side window. It can be opened either fully or partly from the inside by means of a fabric flap.



Side window on the CX

For additional ventilation of the interior, the CX is equipped with removable side windows. These are each attached by 2 zippers and may be removed and stored in the rear storage bag.

There is a tab on the assembly to make it easier to reattach the lower zipper. The end of the zipper can be pulled outwards using this tab.



TIP

For additional climate control, the CX's side windows can be partially opened, similar to the vents on the Cougars. To do this both zippers can be partially undone from the front, and then the forward portion of the side window can be folded back and tucked under the rear portion. Make sure that the front portion cannot slip out as you are travelling.



NOTE

If the un-zipped portion of the window cannot be securely inserted under the zipped portion, it may flap – especially when used as a Bicycle Trailer – and could get damaged. It could even get caught in the wheel spokes and this may result in an accident.

The Cougar and CX have removable seat padding so that the children do not come into direct contact with the floor of the carrier.



In the case of the seat padding on the CX, the upper area can be folded over rearwards for small children and can be secured in the folded position with the Velcro.



4.7 Storage bags

The Cheetah is equipped with a rear lower storage bag and an upper mesh bag.



The Cougar and CX are equipped with an adjustable rear lower storage bag, an upper mesh bag, and a small hidden pocket inside the mesh bag.



The storage bag may also be used in a turned up position.



The bracket of the adjustable storage bag support bar has two settings, an upper and a lower one. Make sure that the storage bag engages properly in both positions. Before you change the position of the storage bag, you must release the quick-release skewers on each of the side brackets. Once you have changed the position, you must once again tighten the quick-release skewers.

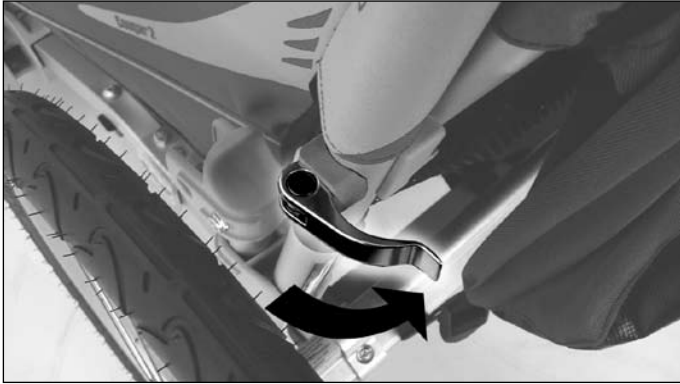

NOTE

Make sure that you always close the quick-release skewers of the storage bag. Particularly in the case of models with suspension, this can come into contact with the tires during travel and cause damage.

TIP

When folding up the storage bag, make sure that the lower two straps under the bag are not tensioned too tightly.

⚠ WARNING

Never carry any heavy or protruding items in the storage bags of the carrier if you are also carrying children at the same time. **This applies particularly to the upper mesh bag!** If this is not the case, your passenger(s) could suffer serious injury or death in the event of an accident.

⚠ WARNING

Items of luggage should be well secured so that they cannot move around during the journey. Unsecured items of luggage and overloading reduce riding stability and make the carrier more difficult to handle. If this is not the case, your passenger(s) could suffer serious injury or death in the event of an accident.

⚠ WARNING

Depending on the type of use, the storage bags may only be loaded to a certain weight. The load of the storage bag is limited by the manufacturer to 4 kg/8.8lb and that of the handlebar bag to 1 kg/2.2lb. Please also refer to the instructions relating to load in Sections 6 to 10. Overloading the carrier reduces the carrier's stability and may lead to an avoidable accident in which your passenger(s) could suffer serious injury or death.

4.8 Adjusting the suspension (Cougar and CX)

The Cougar and CX are equipped with adjustable suspension.



After loosening the knob, it is possible to move the clamp that surrounds both leaf springs. The more this clamp is moved in the direction of the wheel axle, the stiffer the suspension becomes (see the weight scale on the top spring).

75lbs. +	→	50-75lbs	→	25-50lbs.	→	0-25lbs.	→
34kg +	→	22.5-34kg	→	11-22.5kg	→	0-11kg	→

The weight indications on the scale are calculated from the weight of the child(ren) and cargo (ie. You do not need to add the weight of the carrier).

The weight indications on the scale relate first and foremost to use as a Bicycle Trailer. For other uses it may be a good idea to set the suspension softer. If you discover that when riding over bumps the suspension can be felt and likely heard, then the suspension is set too soft and you need to move the knob rearwards.

NOTE

Make sure that you retighten the knobs once you have adjusted the them.

4.9 Operating the parking brake (Cheetah and Cougar)

The parking brake of the Cheetah and Cougar is in the centre of the long cross axle under the rear lower storage bag.

Lock the brake by depressing the brake lever with your foot.

Release the brake by pulling the lever upwards with your foot.



NOTE

If the lever cannot be pushed down smoothly and easily, move the carrier backwards or forwards slightly or lift it slightly by the handlebar. Do not forcibly kick the lever downwards, as the brake components may get bent or damaged.

NOTE

The parking brake on the Cheetah and Cougar is not suitable for deceleration of a moving carrier.

⚠ WARNING

Never leave the carrier unattended, otherwise the carrier could become separated from you resulting in an accident in which your passenger(s) could suffer serious injury or death.

4.10 CX brake system owner's manual

The brake system is in the form of a cable-operated drum brake working on both rear wheels.

The brake system consists of: brake lever (A), top brake cable (B), brake force distributor (C), two bottom brake cables (D) and the drum brakes (E).

The brake force distributor is surrounded by a protective cover.

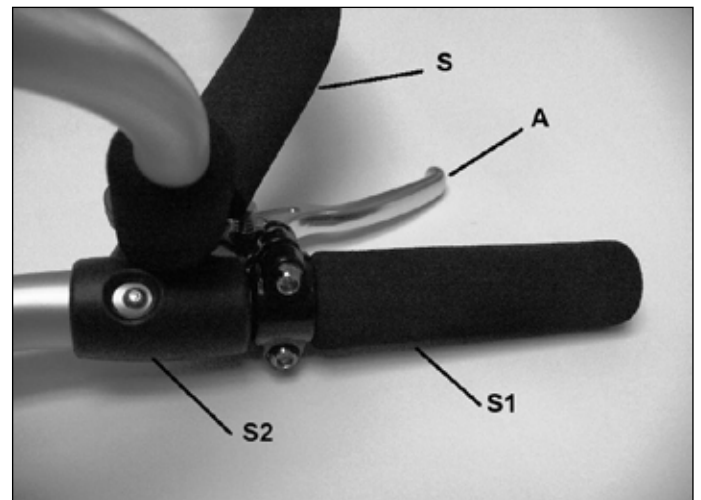
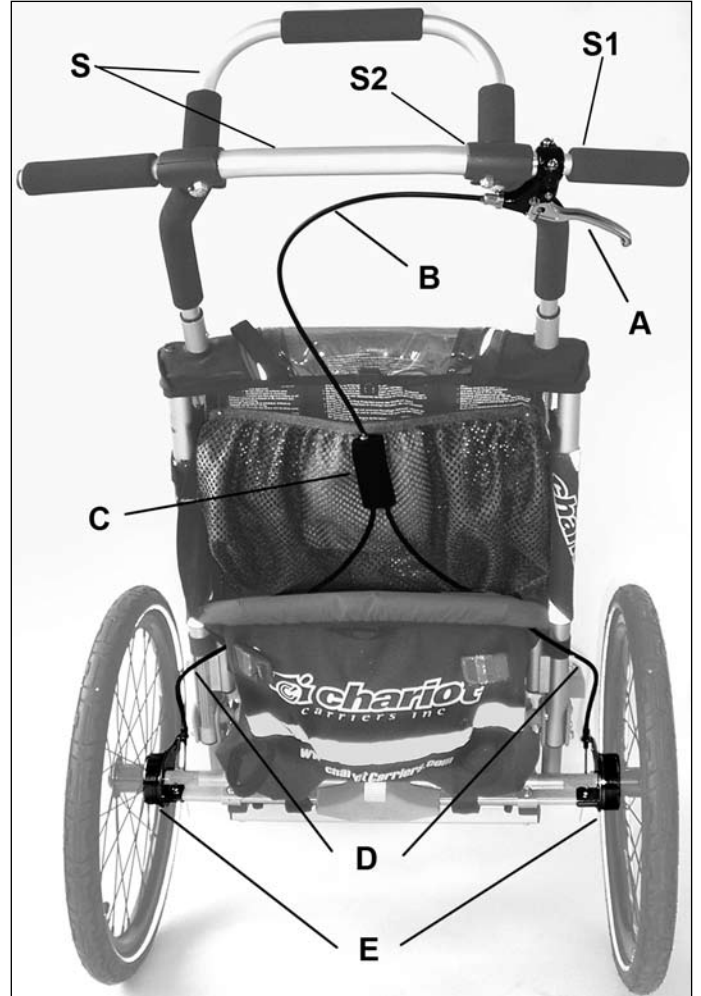

To completely detach the handlebar (S) from the carrier, the entire brake lever and right handlebar grip assembly (S1) with brake lever (A) can be removed by depressing a spring button located in the right plastic bracket (S2) and pulling outward. The handlebar grip and brake lever assembly (S1) can then be stored in the upper mesh pocket, allowing the rest of the handlebar to be stored separate from the carrier. To re-install, simply push the handlebar grip/brake lever assembly (S1) back into place, making sure the spring button fully engages. Check by pulling outwards to ensure that the grip is securely attached.

WARNING

Always ensure that the handlebar grip/ brake lever assembly (S1) is securely fastened to the handlebar (S). Failure to do so could result in an accident in which you and/or your passenger(s) could suffer serious injury or death.

Use as intended

The brake system of the Chariot CX is intended to be used as follows:

- a) As a parking brake for parking the carrier
- b) As a deceleration device for the carrier for the following motive states:
 - Walking
 - Speed walking
 - Jogging

On inclines a maximum speed of 5 km/h / 3 mph is prescribed, otherwise there is a risk of the brakes overheating leading to possible brake failure.

The maximum permissible speed for using the brake system with the carrier on level stretches is 15 km/h / 9 mph.

As part of the use as intended, you should also follow this Owner's Manual and comply with the prescribed maintenance requirements.

Use not recommended

Any use that goes beyond the above is not recommended.

Use not recommended arises from overloading the carrier, excessive speed and improper repair of defects or modifications.

The manufacturer is not liable for damages arising from use that is not as intended – this is at the risk of the user.

Safety Instructions

General safety instructions

- **Before use, please read the safety instructions in Sections 7 and 8.**

Warning against unauthorised modifications

- For reasons of safety, unauthorised rebuilds of and/or modifications to the brake system are not permitted.
- The brake system is only to be used as supplied by the manufacturer, permanently attached to the Chariot CX.
- Conversion of the brake system to other carriers is not permitted.
- Retrofitting of the brake system to an older Chariot CX model or other carrier is not permitted.
- Unauthorised rebuilds and modifications render the warranty invalid.

Use as a wheel brake

During travel the carrier can be decelerated and brought to a stop by operating the brake from the brake lever. The brake allows you to counteract unintended acceleration on inclines.

Before using the brake system for the first time, acquaint yourself with its braking effect in a safe place and away from road traffic.

Brakes transform kinetic energy into heat and for this reason heat up.

WARNING

Do not touch the brake drum at the wheel centre after a long period of use, as the brake drums can become hot and there is a risk of getting burnt.

In the event of use not as intended the brake may overheat. This may lead to reduction in braking force or even brake failure.

WARNING

On inclines a maximum speed of 5 km/h / 3 mph is highly recommended, otherwise there is a risk of the brakes overheating, leading to possible brake failure resulting in an accident in which your passenger(s) could suffer serious injury or death.

Please note that the brake system is only designed to decelerate the carrier with its permissible maximum weight.

Use as a parking brake

The brake system can also be used to secure the carrier against running away when it is parked. For this, the brake lever has to be operated and blocked with the locking pushbutton (F).



Squeeze the brake lever hard in the direction of the handlebar grip until the locking pushbutton can be pushed in without encountering any appreciable resistance. Push it in until it locks.

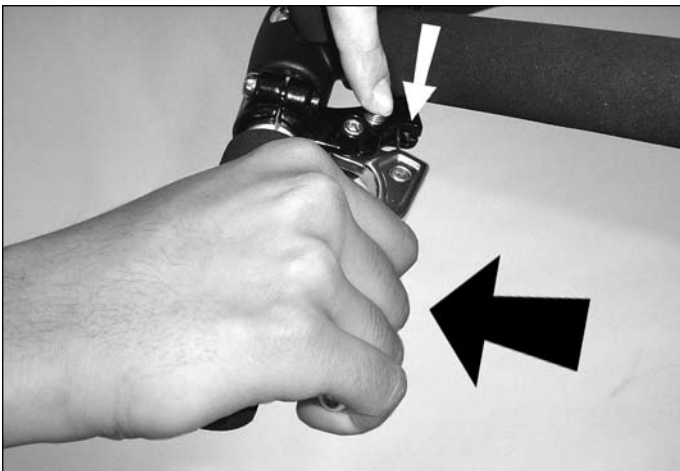

Brake lever in the parked position



⚠ WARNING

Please ensure that the locking pushbutton is fully pushed down. If this is not done, the brake lever could be released and the parked carrier could roll away resulting in an accident in which your passenger(s) could suffer serious injury or death.

To release the brake lever, squeeze the brake hard in the direction of the handlebar grip: a spring mechanism will make the locking pushbutton pop out and the brake lever will spring back into its released position.

⚠ WARNING

When parking the carrier, make sure it cannot tip over. Always check that the carrier cannot run away. If the carrier is given a push, it must immediately come to a stop once it has been released. When parking on an incline, always be ready to hold the carrier in position if need be. Wear a wrist strap at all times. If this is not done, the parked carrier could roll away resulting in an accident in which your passenger(s) could suffer serious injury or death.

Adjusting the brake system

Your Authorized Chariot Carriers will hand the carrier over to you with a fully adjusted brake system.

Inevitable wear on the brake pads eventually leads to the brake lever having to be pulled closer and closer to the hand grip so as to obtain the braking force required. At the same time the braking force that can be obtained via the parking brake is reduced.

Once there has been a noticeable increase in the amount of play when operating the brake lever, the brake system has to be re-adjusted.

Unequal wear of the brake pads, or other factors, can also lead to the brakes not operating with equal force making the carrier pull to one side on braking. Here too it would be a good idea to re-adjust the brake system.

We recommend that, where possible, brake adjustment be left to your Authorized Chariot Retailer.

However the description that follows will allow you to adjust the brake system yourself if no Authorized Chariot Retailer can be reached. When adjusting, proceed with care, as safe braking depends on correct brake adjustment.

TIP

We recommend that you always take the Owner's Manual with you on your first journeys in case brake adjustments need to be made.

The brake system involves the use of 3 adjusting screws:

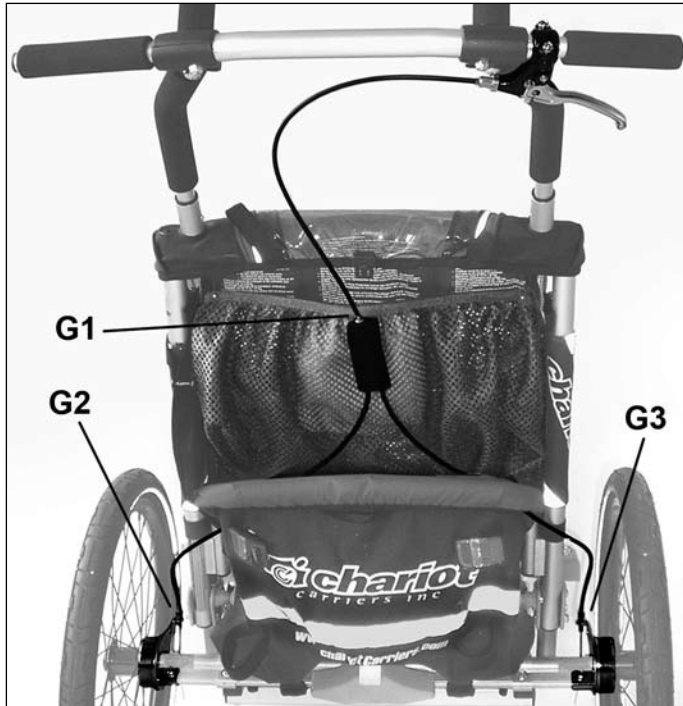

One on the brake force distributor (G1), and one on each of the drum brakes (G2, G3). By unscrewing G1, the inner cable in the top brake cable is tightened. By unscrewing G2 or G3, the inner cable in the bottom brake cable is tightened.

⚠ WARNING

Do not use any adjusting screw that might be present on the brake lever. Unscrewing it would result in inadmissible limitation of the free room needed for the brake cable nipple in the brake force distributor, and this may result in an accident in which you/and your passenger(s) could suffer serious injury or death.

There are lock nuts on all adjusting screws to stop them from changing their position.

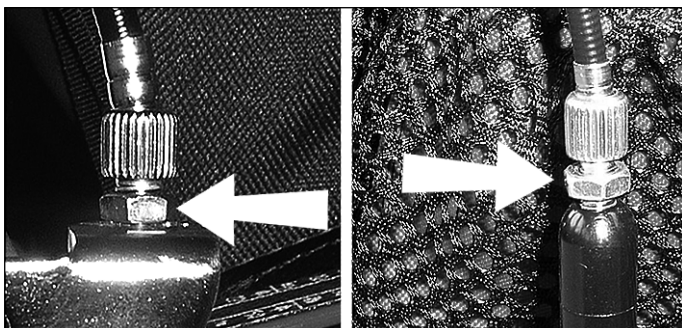

Case 1: Too much increase in brake lever play:

First check that all brake cables with their end caps are properly located in the relevant hole of the adjusting screws. If necessary do the same for the adjusting screw on the brake lever (the one that you are not to adjust).

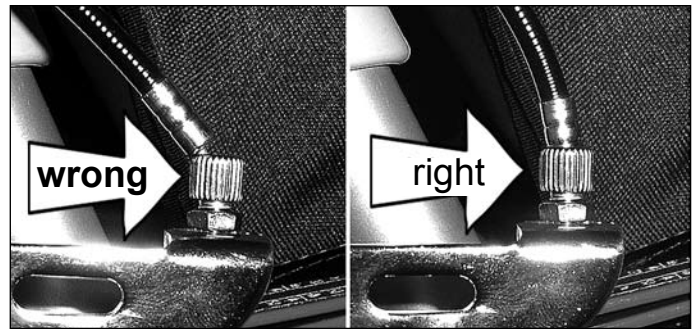

1. Prop up the carrier so that the wheels turn freely.
2. Use a 8 mm (5/16") wrench to loosen the lock nut of the adjusting screw G1 on the brake force distributor.
3. Set both wheels turning very slowly.
4. Unscrew the adjusting screw G1 (anti clockwise) until there is light braking of at least one of the wheels without having to operate the brake lever.
5. Screw the adjusting screw G1 back in for one full turn (clockwise).
6. Using a 8mm (5/16") wrench, tighten the lock nut, but without moving the adjusting screw.

⚠ WARNING

As you do this, please note that the adjusting screw G1 may only be unscrewed to a maximum of 3 mm (1/8"), measured between the tightened lock nut and screw head. If this is not the case, there is the risk that the screw will shear with potential loss of braking force resulting in an accident in which your passenger(s) could suffer serious injury or death.

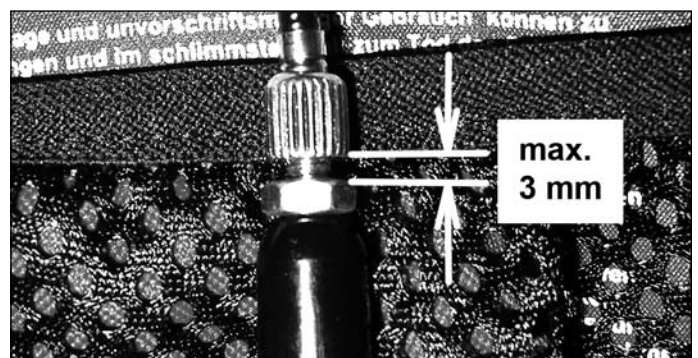

If the possible extent of adjustment of the adjusting screw G1 is insufficient, the adjusting screws G2 and G3 can be adjusted as described in the following section.

NOTE

Always make sure that the lock nuts are tightly fastened.

Case 2: Brakes pull unequally

Basic adjustment

First check that all brake cables with their end caps are properly located in the relevant hole of the adjusting screws. If necessary do the same for the adjusting screw on the brake lever (the one that you are not to adjust). (See illustration in the preceding section).

1. Prop up the carrier so that the wheels turn freely.
2. **Start by adjusting one of the wheels.**
3. Use a 8 mm (5/16") wrench to loosen the lock nut of the adjusting screw G2 on the brake backplate of the drum brake.
4. Set the wheel turning very slowly.
5. Unscrew the adjusting screw G2 (anti-clockwise) until there is light braking of the wheel without having to operate the brake lever.
6. Screw the adjusting screw G2 back in for one full turn (clockwise).
7. Using a 8 mm (5/16") wrench, tighten the lock nut, but without moving the adjusting screw.

WARNING

Please note: Adjusting screws G2 and G3 must not be fully unscrewed from the brake backplate. Make sure that they extend through the brake backplate with at least 2 mm / 5/64" protruding on the opposite side.
If this is not the case, there is a risk that the screw will shear with potential sudden loss of braking force resulting in an accident in which your passenger(s) could suffer serious injury or death.

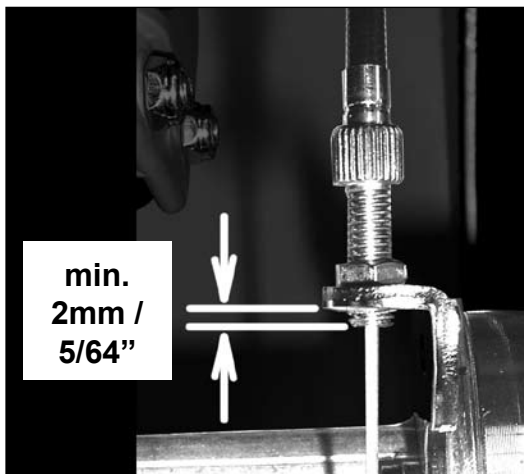

Front view

Proceed in exactly the same way for the wheel on the other side.

Fine adjusting

With a loaded carrier, check that the breaks now work with equal force and the carrier does not pull to one side on braking.

If the brakes still pull to one side, readjust **on the side that the carrier pulls to when the brake is applied**:

1. Use a 8 mm (5/16") wrench to loosen the lock nut of the adjusting screw G2/G3 on the brake backplate of the drum brake.
2. Screw the adjusting screw in one half turn (clockwise).
3. Check again to see if braking force is equal.
4. Repeat the procedure until equal braking has been achieved.
5. Using a 8 mm (5/16") wrench, tighten the lock nut, but without moving the adjusting screw.
6. Check that the parking brake works properly. With the locking pushbutton pushed in, check that the carrier does not roll away and that it comes to a stop again immediately it is released.

NOTE

Always make sure that the lock nuts are tightly fastened.

If you cannot obtain satisfactory adjustment, please consult your Authorized Chariot Retailer.

Wear limit of the brake pads in the drum brake

The brake pads on your Chariot CX are designed to have a long life, but will wear over time. With frequent use their wear limit can eventually be reached. This requires replacement of the brake pads, which is something that your Authorized Chariot Retailer will carry out.

The wear limit is reached when

- No further adjustment are possible because the adjusting screws are unscrewed to their maximum as described above.
- On release of the brake lever, the springs longer spring back to its released position
- Sfter releasing the brake lever, the wheels do not move freely, in spite of the basic adjustment being correct.

Wheel removal

TIP

When removing the wheels, the parking brake must be off. Ensure too that all brake cables with their end caps are properly located in the relevant hole of the adjusting screws. If necessary do the same for the adjusting screw on the brake lever (the one that you are not to adjust).

To remove the wheel press the unlocking button in the centre of the wheel and pull the wheel off to the side.



The brake mechanism that is now exposed is sensitive to dirt.

To protect it from dirt, Chariot supplies two protective caps. We recommend that each time the wheels are removed these caps be inserted on the brake callipers.

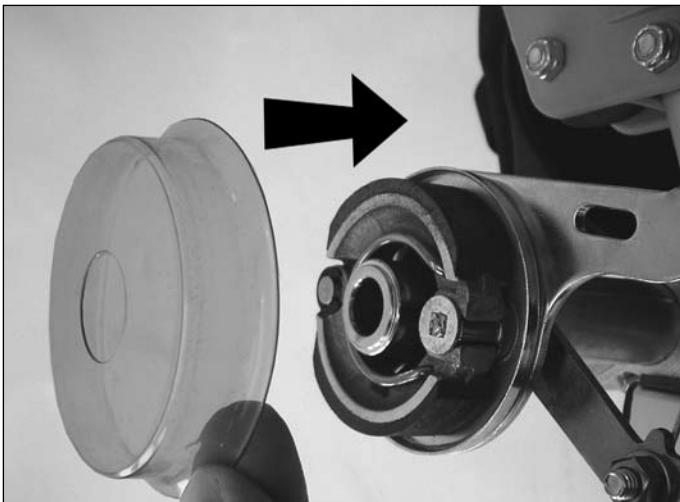

Fitting this cap is particularly important when you are using the XC skiing kit.



Wheel fitting

TIP

When fitting the wheels, the parking brake must be off. Ensure too that all brake cables with their end caps are properly located in the relevant hole of the adjusting screws. If necessary do the same for the adjusting screw on the brake lever (the one that you are not to adjust).

To fit the wheel, press the unlocking button in the centre of the wheel and push the axle into the wheel mount socket until it can go no further. Release the unlocking button. The axle will now click in.



⚠ WARNING

Make sure that you check that **both wheels** are properly seated by pulling the wheel hard to one side **without pressing the unlocking button**. To do this lift the carrier slightly and hold it firm with one hand. Check a number of times that the wheel cannot be pulled off, and give it a good shake. Failure to do so could result in the lose of the wheels causing an accident in which you and/or your passenger(s) could suffer serious injury or death.

Care and maintenance

Cleaning

The brake internal areas must be dry and free of dirt. If the wheels are removed, the protective cap prevents dirt entering from outside.

Wear of the brake callipers, however, also gives rise to dust that clogs the inside.

If necessary, please clean using a dry and grease-free brush.

If you want to wash your Chariot with water, please leave the wheels in place, so that as little water as possible gets into the drum brakes. Nevertheless, after washing with water you should carry out a brake test, since contact with water cannot always be prevented and moisture reduces braking efficiency.

Brake cables

Before each journey check that there are no kinks in or other damage to the brake cables.

Screw connections

- After the first 100 km (63 miles), check that all screws and nuts are tight. If necessary, retighten.
- After this, carry out a check that the screws and nuts are tight at regular intervals.

5. Parts lists and exploded views

Parts list Cheetah 1

	Part #	Part	Quantity
A/B	40100148	Upper Frame	1
C	41100228	Lower Frame	2
D	41101297	Axle Hangar Bracket	2
E	40100425	Back Frame – Left	1
F	40100426	Back Frame – Right	1
G	40100722	Back Tube	2
H	40100626	Seat Frame	1
I	40101516	Versa Wing 2.0 - Left	1
J	40101517	Versa Wing 2.0 - Right	1
K	40101282	Autolock Back Bracket – Left	1 Set
L	40101281	Autolock Back Bracket – Right	1 Set
M	50203031	Shoulder Harness	1
N	50101733	Plastic Wheel	2
O	50101305	Clevis Axle	2
P		Weather Cover	1
Q		Fabric Body	1
R	41103032	Axle Adapter	2
T	40101311	Handlebar	1
U	40202011	Wrist Safety Strap	1
V	40101745	Parking Brake Assembly with Axle	1
W		Cargo Bag (not shown)	1
X	41101929	Parking Brake Hub (not shown)	2

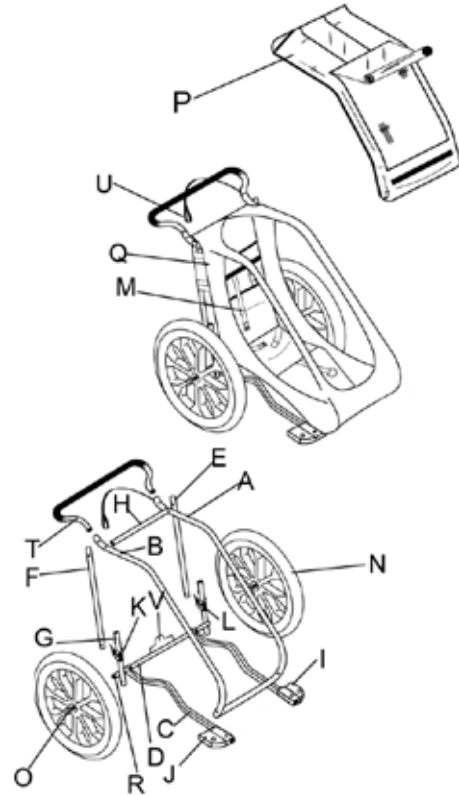

Parts list Cheetah 2

	Part #	Part	Quantity
A/B	40100149	Upper Frame	1
C	41100226	Lower Frame	2
D	41101297	Axle Hangar Bracket	2
E	40100425	Back Frame – Left	1
F	40100426	Back Frame – Right	1
G	40100722	Back Tube	2
H	40100624	Seat Frame	1
I	40101516	Versa Wing 2.0 – Left	1
J	40101517	Versa Wing 2.0– Right	1
K	40101282	Autolock Back Bracket – Left	1 Set
L	40101281	Autolock Back Bracket – Right	1 Set
M	50203031	Shoulder Harness	2
N	50101733	Plastic Wheel	2
O	50101305	Clevis Axle	2
P		Weather Cover	1
Q		Fabric Body	1
R	41103032	Axle Adapter	2
S	40100627	Lower Seat Bar	1
T	40101338	Handlebar	1
U	40202011	Wrist Safety Strap	1
V	40101746	Parking Brake Assembly with Axle	1
W		Cargo Bag (not shown)	1
X	41101929	Parking Brake Hub (not shown)	2

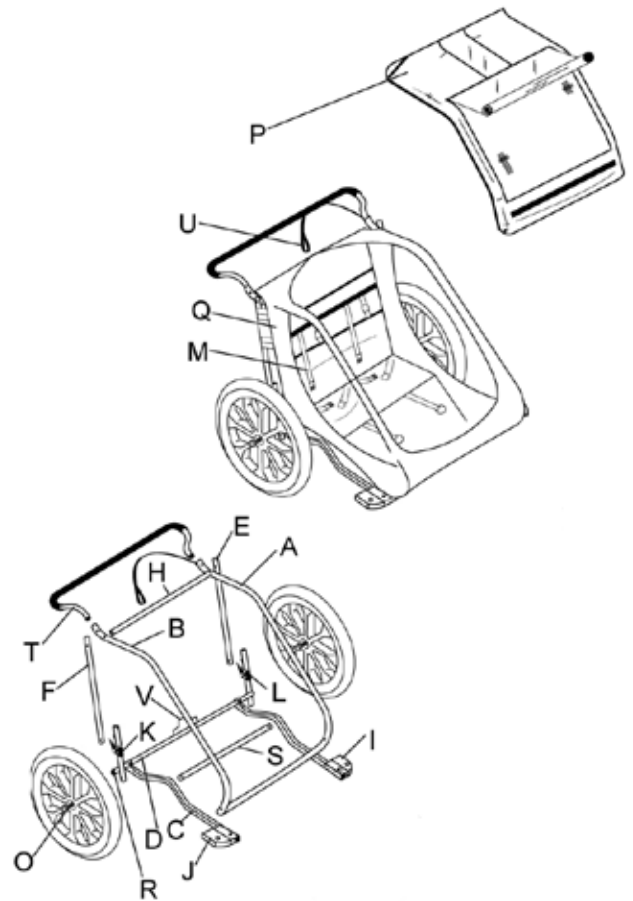

Parts list Cougar 1

	Part #	Part	Quantity
A	40100148	Upper Frame	1
B	41100227	Lower Frame	2
C	41101296	Axle Hangar Bracket	2
D	40100406	Back Frame – Left	1
E	40100407	Back Frame – Right	1
F	40100704	Back Tube	2
G	40100626	Seat Frame	1
H	40100449	Cargo Bag Frame	1
I	40101516	Versa Wing 2.0 – Left	1
J	40101517	Versa Wing 2.0 – Right	1
K	40101282	Autolock Back Bracket – Left	1 Set
L	40101281	Autolock Back Bracket – Right	1 Set
M	50203031	Shoulder Harness	1
N	50101729	Spoked Wheel	2
O	50101305	Clevis Axle	2
P	31100506/7	Weather Cover	1
Q	30100509/10	Fabric Body	1
R	41103032	Axle Adapter	2
S	40101311	Handlebar	1
T	40202011	Wrist Safety Strap	1
U	40101745	Parking Brake Assembly with Axle	1
V	33100507/8	Cargo Bag (not shown)	1
W	41101929	Parking Brake Hub (not shown)	2
X	41101272/4	Click n' Store Left	1
Y	41101273/5	Click n' Store Right	1
Z	41101276/8	Cargo Bag Brackets Left	1
AA	41101278/9	Cargo Bag Brackets Right	1
BB	50103070	Quick release Skewers	2

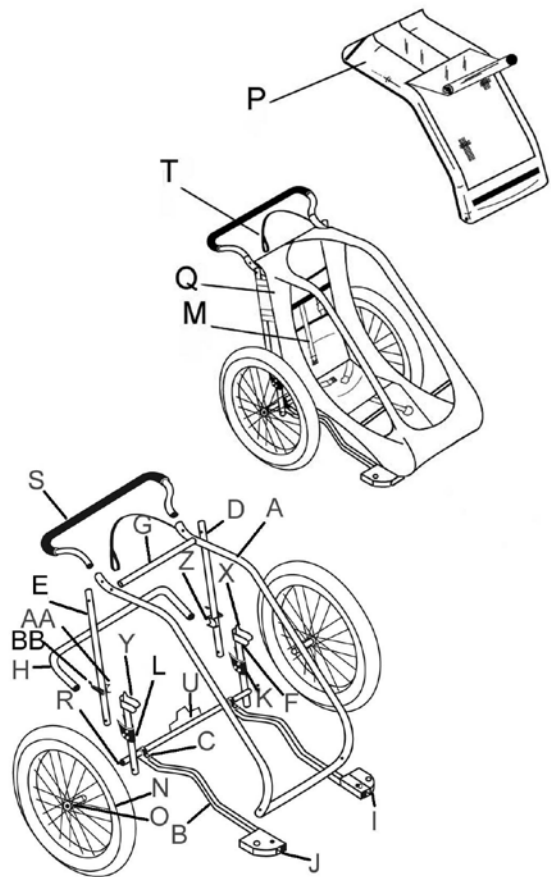

Parts list Cougar 2

	Part #	Part	Quantity
A	40100149	Upper Frame	1
B	41100227	Lower Frame	2
C	41101296	Axle Hangar Bracket	2
D	40100406	Back Frame – Left	1
E	40100407	Back Frame – Right	1
F	40100704	Back Tube	2
G	40100624	Seat Frame	1
H	40100451	Cargo Frame Bag	1
I	40101516	Versa Wing 2.0 – Left	1
J	40101517	Versa Wing 2.0 – Right	1
K	40101282	Autolock Back Bracket – Left	1 Set
L	40101281	Autolock Back Bracket – Right	1 Set
M	50203031	Shoulder Harness	2
N	50101729	Spoked Wheel	2
O	50101305	Clevis Axle	2
P	31100903/4	Weather Cover	1
Q	30100907/8	Fabric Body	1
R	41103032	Axle Adapter	2
S	40100627	Lower Seat Bar	1
T	40101338	Handlebar	1
U	40202011	Wrist Safety Strap	1
V	40101746	Parking Brake Assembly with Axle	1
W	33100906/7	Cargo Bag (not shown)	1
X	41101929	Parking Brake Hub (not shown)	2
Y	41101272/4	Click n' Store Left	1
Z	41101273/5	Click n' Store Right	1
AA	41101276/8	Cargo Bag Brackets Left	1
BB	41101277/9	Cargo Bag Brackets Right	1
CC	50103070	Quick Release Skewers	2

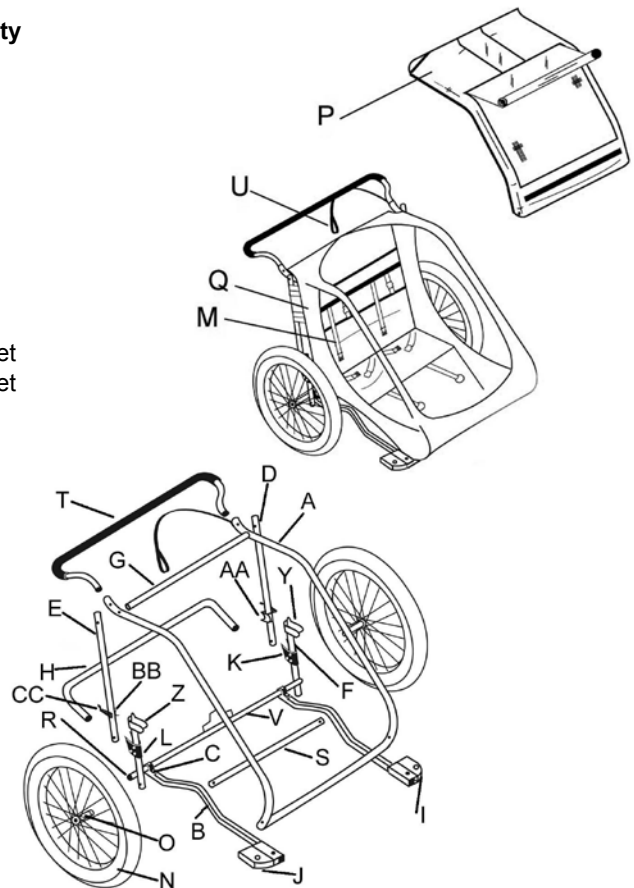

Parts list CX 1

Part #	Part	Quantity	
A	40100151	Upper Frame	1
B	41100227	Lower Frame	2
C	41101296	Axle Hangar Bracket	2
D	40100406	Back Frame – Left	1
E	40100407	Back Frame – Right	1
F	40100704	Back Tube	2
G	40100626	Seat Frame	1
H	40100449	Cargo Bag Frame	1
I	40101516	Versa Wing 2.0 – Left	1
J	40101517	Versa Wing 2.0 – Right	1
K	40101282	Autolock Back Bracket – Left	1 Set
L	40101281	Autolock Back Bracket – Right	1 Set
M	50203045	Shoulder Harness	1
N	50101703	Spoked Wheel	2
O	50101309	Clevis Axle	2
P	31101003	Weather Cover	1
Q	30101005	Fabric Body	1
R	50102002	Axle Adapter	2
S	40101337	Handlebar	1
T	40202011	Wrist Safety Strap	1
U	50102001	Left Brake	1
V	50102003	Right Brake	1
W	33101004	Cargo Bag (not shown)	1
X	41101272/4	Click n' Store Left	1
Y	41101273/5	Click n' Store Right	1
Z	41101276/8	Cargo Bag Brackets Left	1
AA	41101278/9	Cargo Bag Brackets Right	1
BB	50103070	Quick release Skewers	2

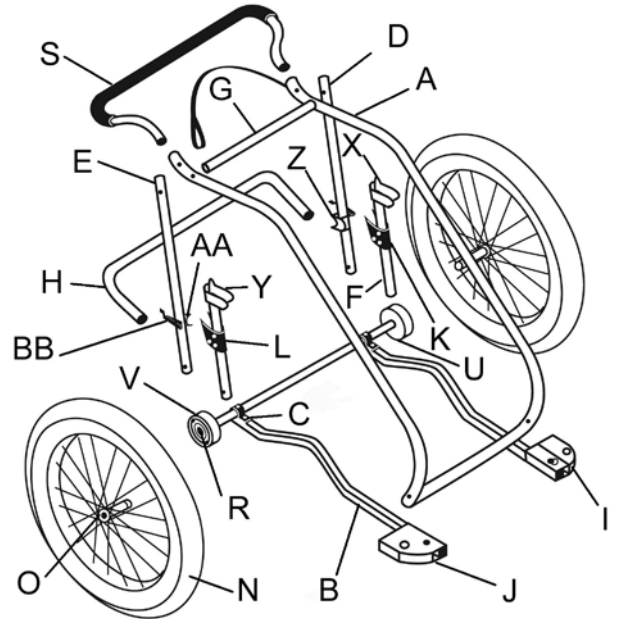

Parts list CX 2

Part #	Part	Quantity	
A	40100152	Upper Frame	1
B	41100227	Lower Frame	2
C	41101296	Axle Hangar Bracket	2
D	40100406	Back Frame – Left	1
E	40100407	Back Frame – Right	1
F	40100704	Back Tube	2
G	40100624	Seat Frame	1
H	40100451	Cargo Frame Bag	1
I	40101516	Versa Wing 2.0 – Left	1
J	40101517	Versa Wing 2.0 – Right	1
K	40101282	Autolock Back Bracket – Left	1 Set
L	40101281	Autolock Back Bracket – Right	1 Set
M	50203045	Shoulder Harness	2
N	50101703	Spoked Wheel	2
O	50101309	Clevis Axle	2
P	31101004	Weather Cover	1
Q	30101006	Fabric Body	1
R	50102002	Axle Adapter	2
S	40100627	Lower Seat Bar	1
T	40101339	Handlebar	1
U	40202011	Wrist Safety Strap	1
V	50102001	Left Brake	1
W	50102003	Right Brake	1
X	33101005	Cargo Bag (not shown)	1
Y	41101272/4	Click n' Store Left	1
Z	41101273/5	Click n' Store Right	1
AA	41101276/8	Cargo Bag Brackets Left	1
BB	41101277/9	Cargo Bag Brackets Right	1
CC	50103070	Quick Release Skewers	2

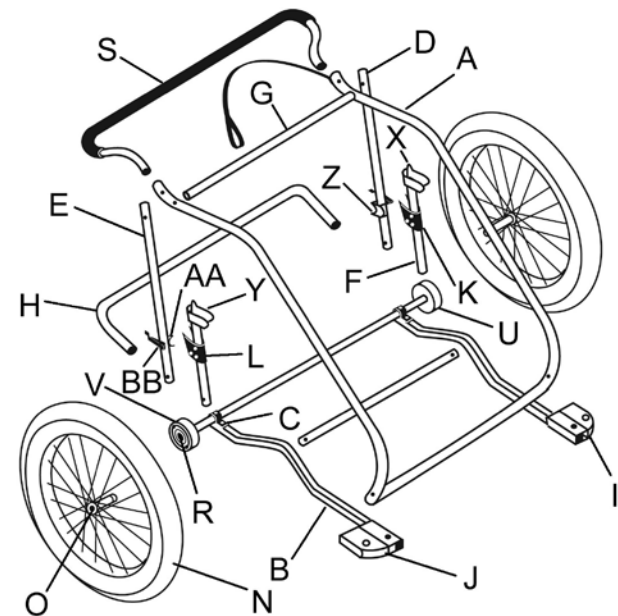

6. The Cycling Kit



The assembled bicycle trailer (CTS Ready Chassis + Cycling Kit)

Supplied as standard



Cycling Kit

Chariot hitcharm with Axle-Mount ezHitch (including quick-release skewer), rear reflector, spoke reflectors and safety flag

Safety instructions for use as a Bicycle Trailer

General safety instructions for operation as a bicycle trailer:

Basics

- Please make sure you read the safety instructions in the “Safety” section at the beginning of this Owner’s Manual.
- Only cyclists who are experienced and strong enough may tow bicycle trailers. If you wish to carry children in the bicycle trailer, you must be 16 years old or over.
- Make sure that your bicycle is in good and safe condition. We recommend you have your bicycle regularly serviced by a bicycle retailer.
- If you are not sure whether your bicycle is suitable for towing a trailer, please ask your bicycle retailer.
- General warning: Travelling by bicycle with a child is an activity that is potentially hazardous
- We recommend that especially long rear wheel mudguards and rear-view mirrors be fitted to the bicycle.
- When using this trailer, please also follow the Owner’s Manual of the bicycle used for towing. Find out whether your bicycle is permitted for use in towing bicycle trailers and the permitted overall weight of the bicycle/trailer vehicle.
- Do not use a kickstand or other parking device to support the bicycle with a trailer attached. Attaching a trailer can change the balance of the bicycle making kickstands ineffective. The bicycle can fall over, damaging it and the trailer.

With regards to transporting children

- Children carried in the bicycle trailer must be at least 1 year old and be able to sit up without support.
- The rider and the children being carried must wear suitable CPSC or CE approved helmets.
- If only one child is being carried in a two-seater trailer, then, in the interests of safety, the central sitting position must be used. The trailer might otherwise tip over, with serious consequences for the child.
- Please remember that the trailer should only be connected or unconnected provided there is no child in the trailer.
- Never cycle without closing the two-in-one weather cover otherwise your child may be injured by insects, dirt or grit thrown up from the road.

With regards to the trailer

- When the trailer is towed behind a bicycle, the stroller wheels must never be fixed in their use position (wheels down). They may only be carried in their out-of-use position (wheels up).
- Remember that on right-hand turns the radius of the turn is restricted. If the rear wheel of the bicycle comes into contact with the hitcharm, there is a risk of the cyclist falling and injury.
- Please ensure that when manoeuvring, the trailer is not set at an angle of more than 90° to the bicycle, otherwise the hitch may be damaged.
- Reflectors that comply with CPSC regulations shall be visible on the rear of the trailer and on the side of the wheels.

Please ensure the following before each journey:

- Make sure that the hitcharm is correctly fitted and secured to the trailer: see pages 30 and 31.
- Make sure the hitch is firmly attached on the bicycle. A hitch that is not securely attached may work loose from the rear axle and result in losing the trailer: see pages 31 and 32.
- Make sure that the hitcharm is correctly coupled up and secured to the bicycle: see pages 32 and 33.
- Before each journey, check the full function of the warning devices: spoke reflectors, rear reflector, safety flag, and lights if necessary.
- Avoid riding at night. Your ability to see and be seen is greatly reduced. If you must ride at night, use proper lighting and reflectors on your bicycle and wear bright and reflective clothing.
- Before each journey make sure that the maximum trailer cargo load is not being exceeded and the specified permissible hitcharm load (nose weight) is maintained.

Pay attention to the following when travelling:

- Always cycle with care and look well ahead. Avoid applying emergency braking. When applying emergency braking, there is the risk that the rear wheel of the bicycle may pull to one side and you lose control of the bicycle/trailer vehicle.
- Always obey all traffic regulations and use proper hand signals.
- Do not assume that you have the right of way. Do not cycle with the trailer in heavy traffic areas such as busy streets, on highways or anywhere it may be unsafe to ride with children.
- The maximum permissible speed for towing this trailer is 25 km/h / 15 mph. Take corners/turns at walking pace, as there is a risk of tipping over.
- Remember that the steering and braking characteristics of your bicycle are different when towing a trailer.
- Always avoid going over obstacles with one wheel of the trailer only, especially on corners – the trailer might tip over, even at walking pace!

Performance characteristics when used as a Bicycle Trailer

Top speed	25 km/h / 15 mph
Top speed on corners or rough roads	walking pace (10 km/h / 6 mph)
Permitted hitcharm load (tongue or nose weight, to be ensured by good load distribution, see pages 34 and 35)	1 - 6 kg/2.2-13.2lb
Permissible rear wheel size on the towing bicycle	26 or 28 inches/700cc

Legal requirements

The rider and the children being carried must wear suitable CPSC or CE approved helmets

Remember that at dusk and in the dark, the bicycle and carrier must be equipped with regulation working lighting. Rear battery-powered lights for instance are suitable as working lighting.

These can, for instance, be installed on the top of the rear side frame tubes or clipped onto the fabric sleeve in the same location.



Ask your authorized Chariot retailer for suitable lights and the correct method to attach the lights.

Assembly

Assembling the reflectors and safety flag

If you want to use your Chariot as a Bicycle Trailer, all reflectors and safety flags must be installed.

Position a spoke reflector between two outer spokes and an inner spoke in such a way that the inner spoke lies in the guide slot of the reflector.



Guide the plastic clip with its slot over the inner spoke and into the hole of the reflector. Secure it by tightening it a quarter turn using a screwdriver.

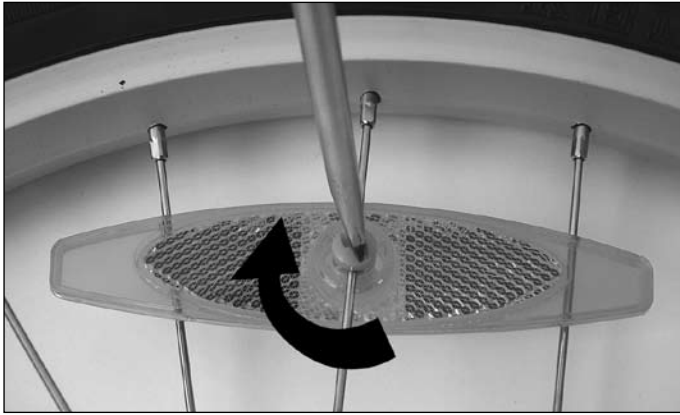

Spoked wheels on the Cougar and the CX.

Attach a reflector on each wheel.

For the plastic wheels used on the Cheetah.

Screw a reflector onto each wheel on one of the brackets provided.



For fastening the rear reflector you need a Philips screwdriver.



Screw the red reflector into the left grommet on the storage bag.



Push the two safety flag rods together and guide the bottom end into the hole located in the plastic end cap in the upper left rear frame tube. Push the rod in until it stops.



Attaching the hitcharm to the CTS Ready Chassis

The hitcharm is attached to the CTS Ready Chassis into the left "VersaWing 2.0" bracket.

The hitcharm must always be attached into the left-hand side of the carrier (as seen in the direction of travel). The hitcharm must always be attached with both spring buttons pointing upwards.

Press down the small button and slide the hitcharm into the VersaWing 2.0 until the large button engages in the VersaWing 2.0 (Figures 1 to 3).



The hitcharm should now protrude about 2 cm / 3/4 inch out of the rear side of the VersaWing 2.0, and the rear vertical holes in the VersaWing 2.0 and hitcharm must align with each other.

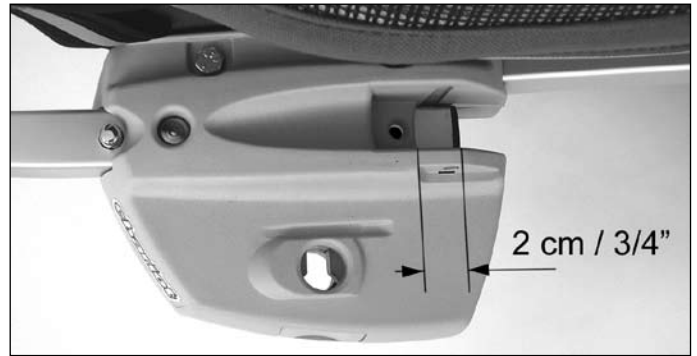

Insert the security pin into the rear vertical hole of the VersaWing 2.0 and push it down completely through the hitcharm until the retaining ring is touching the top of the VersaWing 2.0.



⚠ WARNING

The security pin must always be inserted, in addition to the large spring button in the bicycle hitcharm! A hitcharm that has not been secured properly may come loose during travel resulting in an accident in which you and/or your passenger(s) could suffer serious injury or death.



Correctly installed hitcharm.

⚠ WARNING

Make sure that the hitcharm is correctly attached and secured to the carrier. Any kind of incorrect assembly may lead to loss of the carrier during travel resulting in an accident in which you and/or your passenger(s) could suffer serious injury or death.

**Attaching the hitcharm to the bicycle
(Chariot Axle-Mount ezHitch)**

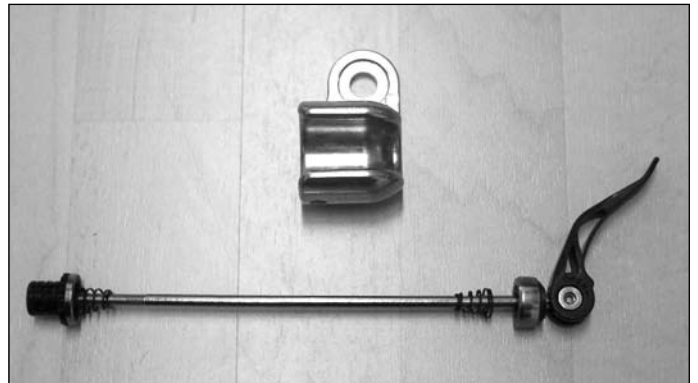

Axle-Mount ezHitch and accompanying quick-release skewer.

Attaching the Axle-Mount ezHitch

The Axle-Mount ezHitch must always be attached to the left-hand side of the bicycle.

Bicycle with quick-release axle

Remove the existing quick-release. Loosen the nut of the Chariot quick-release.
Push the quick-release axle through the hitch and then through the axle of the wheel.

The opening for the hitch ball and the vertical hole for the security pin must point forward.



Fit the quick-release nut on the right-hand side. Both skewer springs must be located in such a way that the narrow side of each spring points towards the centre of the hub.

⚠ WARNING

The quick-release nut must be tightened on the axle thread by at least 5 full turns, so that adequate clamping force is ensured. A thread which is too short can lead to accidental loosening of the rear wheel which may lead to an otherwise avoidable accident in which you and/or your passenger(s) could suffer serious injury or death

Close the quick-release lever with the end of the lever pointing upwards. In this position there is enough space to insert the security pin.



In order to ensure that the hub is clamped sufficiently in the dropouts, the quick-release lever must begin gripping as it moves from the open to the middle position, and approaching the closed position you should clearly feel resistance as you tighten. If it is too easy or too difficult to move the quick-release, tighten or loosen the lock nut on the other side of the hub to adjust.

If you don't feel confident operating the quick-release, please ask your specialized retailer for assistance.

⚠ WARNING

Always make sure that the quick-release is correctly attached. An incorrectly tensioned quick-release may lead to an otherwise avoidable accident in which you and/or your passenger(s) could suffer serious injury or death.

Bicycle with solid axle

Unscrew the rear wheels left-hand axle nut and the spacer or plane washer. Install the Axle-Mount ezHitch on the axle. **The opening for the hitch ball and the vertical hole for the security pin must point forward.**



Screw the wheels axle nut and the spacer or plain washer back on and tighten them securely.

⚠ WARNING

Depending on the hub type, the existing torque support washer for the hub must stay on the frame. Please follow the assembly instructions for the hub and the manufacturer's torque specifications when fastening the axle nut. Failure to do so may lead to an otherwise avoidable accident in which you and/or your passenger(s) could suffer serious injury or death.

⚠ WARNING

The rear wheels axle nut must be tightened on the axle thread by at least 5 full turns, so that adequate clamping force is ensured. A thread which is too short can lead to accidental loosening of the rear wheel which may lead to an otherwise avoidable accident in which you and/or your passenger(s) could suffer serious injury or death.

Attaching the carrier

From the front, insert the elastomer ball, which is attached to the hitcharm, into the Axle-Mount ezHitch. Pull the hitch ball rearward to the end of the socket in the axle mounted hitch cup.

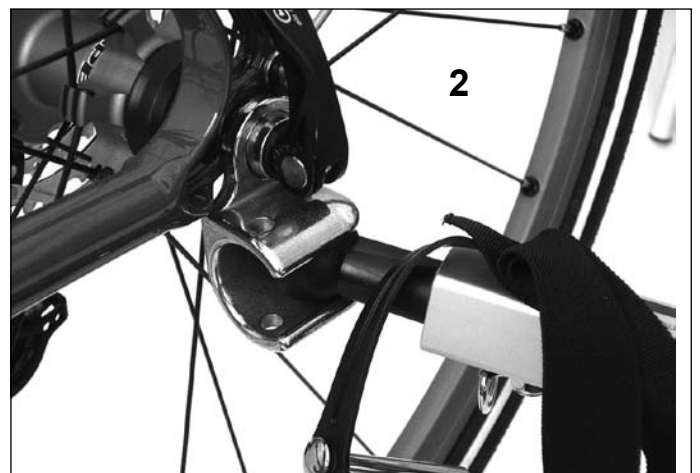
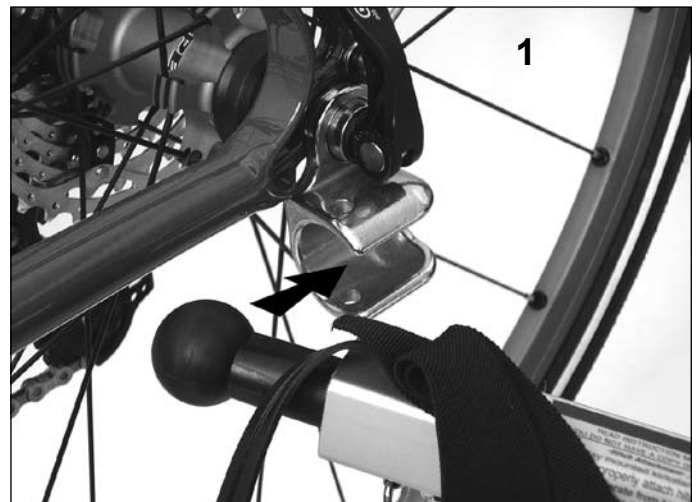

Push the security pin from the top through both holes of the Axle-Mount ezHitch.

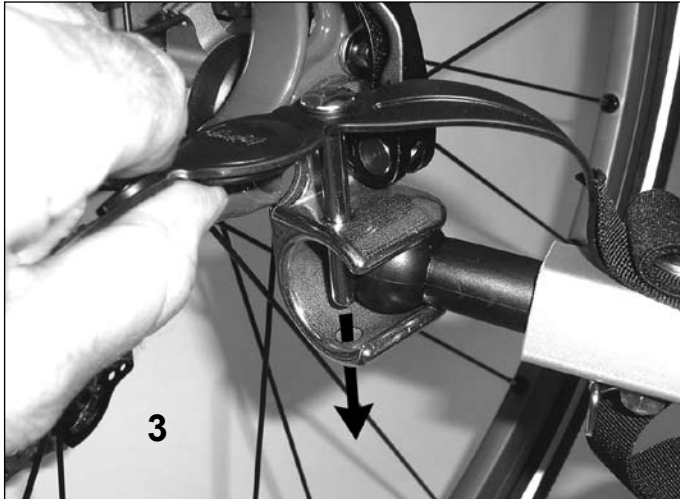

Secure the pin by pulling the rubber tab over the protruding end of the pin.

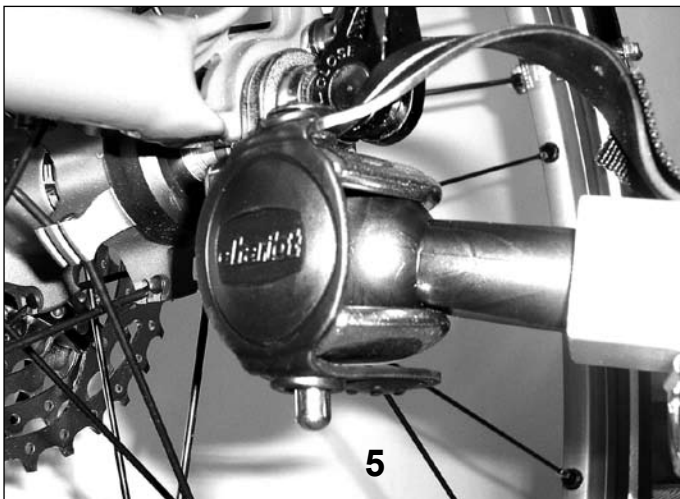
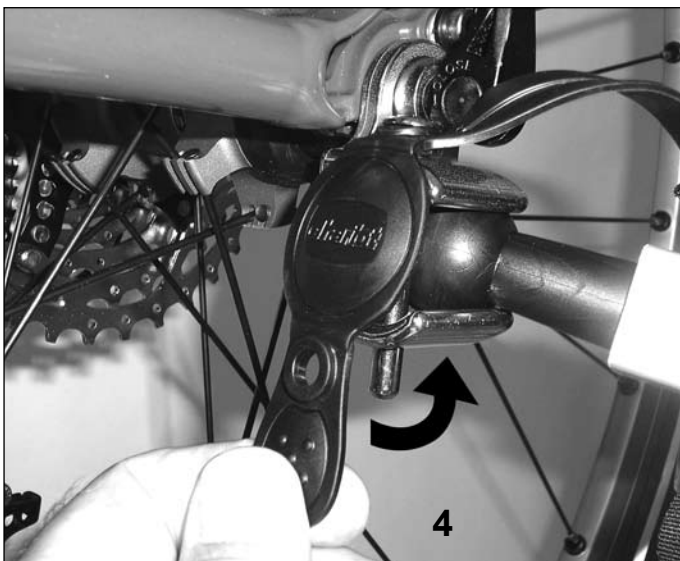

Finally, always attach the hitch's back-up safety strap around the bicycle frame. To do this, from above, put the hitch back-up safety strap around the chain stay, and attach the hook of the hitch back-up safety strap to the hitcharm D-ring located on the underside of the hitcharm.

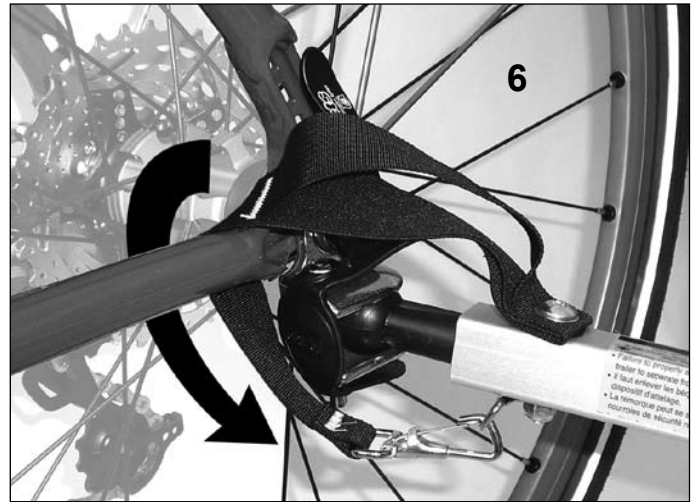

⚠ WARNING

Always attach the hitch's back-up safety strap in the manner described above. It serves as additional protection against losing the carrier during operation. Do not use the Bicycle Trailer if you cannot attach the hitch's back-up safety strap around your bicycle frame for any reason!

Failure to install the hitch's back up safety strap may lead to an otherwise avoidable accident in which you and/or your passenger(s) could suffer serious injury or death.

Special features of the VersaWing 2.0

If you want to convert the carrier from a Bicycle Trailer to another CTS Conversion Kit, or if you want to store the carrier, the hitcharm on the Cougar and CX can be stored to the side of the carrier.

For this, the carrier must be upright or erected.

Insert the front end of the hitcharm in the groove provided for it in the Click 'n' Store bracket located on the rear side of the carrier. The rear end of the hitcharm will point forward. Push the hitcharm in the Click 'n' Store bracket down until the end of the hitcharm catches in the recess of the VersaWing 2.0, and the horizontal holes of the hitcharm and VersaWing 2.0 are aligned with each other.



TIP

Always store the hitcharm on the left-hand side of the carrier.

Use the security pin at the end of the hitcharm for attaching the hitcharm to the VersaWing 2.0. For this, insert the pin through the horizontal hole in the VersaWing 2.0 and hitcharm until it will go no further.



NOTE

Always secure the stored hitcharm to the VersaWing 2.0. If you do not do this, it could work loose, get caught in the wheel spokes and cause an accident.

NOTE

Always attach the snap hook of the hitch back-up safety strap to its accompanying D-ring on the hitcharm end that now points upwards. If you do not do this, it could get caught in the wheel spokes and cause an accident.



Use

The exact position of the seat in the Chariot has been specially chosen so as to give optimum weight distribution if there are only children sitting in the carrier.

The only other factor in weight distribution is the weight of luggage items. The storage bags described in Section 4.7 are intended for the carrying of luggage items. The carrying of luggage items next to the child on the seat is prohibited. We would also urge against carrying luggage items in the foot space.

Checking of the hitcharm load (tongue or nose weight) is important if you want to carry a heavy load in the storage bags along with a light child, or if you are using your Chariot as a Bicycle Trailer.

The hitcharm load (tongue or nose weight) on the carrier hitch needs to be 1 - 6 kg / 2.2 - 13.2 lb for safe road handling. The hitcharm load (tongue or nose weight) is the weight that you lift on the hitch when the carrier is loaded up.

If you are not confident about estimating the hitcharm load (tongue or nose weight), use a bathroom scale to help you:

1. Put the bathroom scales next to the hitcharm of the loaded carrier.
2. Stand on the scales and note your own weight.
3. Lift up the hitcharm at the hitch to around 30 cm/12 inches above the ground.

The weight as displayed should now be 1 - 6 kg/2.2 - 13.2 lb above your own weight.

Suitability of the bicycle used for towing

Always make sure you follow the manufacturer's specifications in the owner's manual of the bicycle used for towing, where the suitability specifications of the bicycle are to be found.

Example 1: If the manufacturer states, this bicycle is suitable for pulling an unbraked trailer of overall weight 40 kg, then you may add a maximum load of 30 kg since the carrier itself weighs approximately 10 kg/22 lb (e.g. Cheetah 1).

Example 2: If the manufacturer states, the permissible bicycle full load of 120 kg/ 265 lb may not be exceeded, then please note that the permissible full load may also not be exceeded if you attach a trailer. In order to determine the cargo load, you need to subtract the weight of the bicycle, your own weight and the carrier unloaded weight from the permissible full load. For instance, if the bicycle weighs 15 kg/ 33 lb and the cyclist weighs 72 kg/ 159 lb, then a maximum of 22 kg/ 49 lb additional cargo load may be carried $(120 - 15 - 72 - 11 = 22)/(265 - 33 - 159 - 24 = 49)$.

You will find the weight specifications for your carrier in Section 13 "Specifications".

⚠ WARNING

If there is nothing specified in the owner's manual of your bicycle regarding towing a trailer, this does not mean that there are no limitations. In such a case, always ask your specialist retailer.

Travelling

Please ensure the following before each journey:

Follow all safety instructions at the beginning of this section and the general safety instructions at the beginning of the Owner's Manual.

⚠ WARNING

When used as a Bicycle Trailer, the stroller wheels must never be installed in their use position (wheels down). They may only be carried in their out-of-use position (wheels up). For a description of the positions of the stroller wheels, see Section 7. Failure to do so may lead to an otherwise avoidable accident in which you and/or your passenger(s) could suffer serious injury or death .

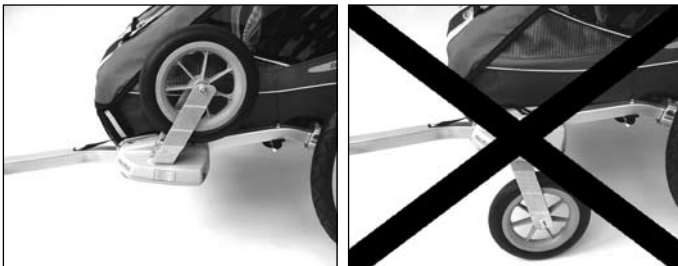

Correct assembly of the stroller wheels for carrying them out-of-use when used as a Bicycle Trailer.

Wrong!!!

Pay attention to the following when travelling:

Follow all safety instructions at the beginning of this section and the general safety instructions at the beginning of the Owner's Manual.

⚠ WARNING

When turning round or manoeuvring the vehicle, the angle between the towing bicycle and the carrier must not exceed 90°. The hitch ball may get damaged (overstretched) and lose its stiffness which may lead to an otherwise avoidable accident in which you and/or your passengers could suffer serious injury or death.

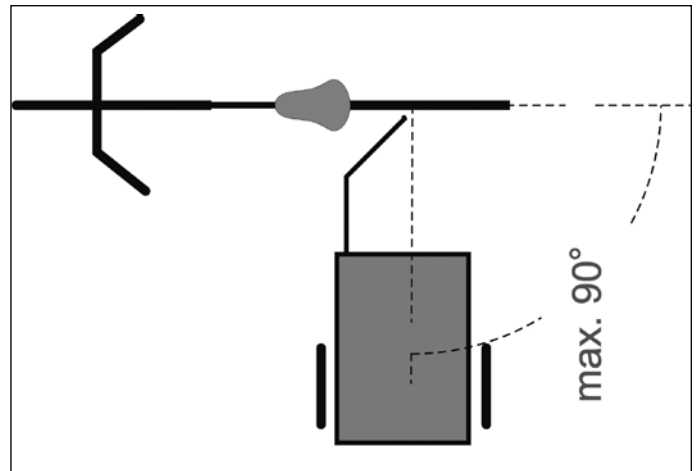

Use as a pull wagon

On short stretches and level surfaces, the carrier may be used as a pull wagon.

For this, insert the hitcharm rotated at 90° counterclockwise in the left-hand (in direction of travel) VersaWing 2.0 (the same wing as the hitcharm is used for trailering). The front end of the hitcharm must point upwards.

Push the hitcharm in until the spring buttons, which is now on the outside side, come up against the VersaWing 2.0.

Then press the smaller button in and slide the hitcharm into the VersaWing 2.0 until the large spring button audibly engages.

On this type of assembly, engagement of the spring button is not visible, however you should be able to see the small spring button returned to its normal “out” position.

Insert the security pin through the horizontal hole at the back of the VersaWing 2.0.



⚠ WARNING

Make sure the spring button engages correctly. Before use, ensure that the hitcharm is securely locked by giving it a good forward pull. If this is not the case, the hitcharm might work loose during travel resulting in an accident in which your passenger(s) could suffer serious injury or death.

⚠ WARNING

Only park the carrier on flat surfaces and secure it with the parking brake, otherwise the carrier could roll away in which your passenger(s) could suffer serious injury or death.

⚠ WARNING

Any assembly of the hitcharm other than the one described is not permitted. Any kind of incorrect assembly may lead to loss of the carrier during travel resulting in an accident in which you and/or your passenger(s) could suffer serious injury or death.

7. The Jogging Kit



The assembled Jogging Stroller
(CTS Ready Chassis + Jogging Kit)

Supplied as standard



Jogging Kit: 16"

Wheel with quick-release skewer, and 2 wheel arms with ezClick attachment

Safety instructions for use as a Jogging Stroller

- Please make sure you read the safety instructions in the "Safety" section at the beginning of this Owner's Manual.
- Before each journey check that all components are properly fitted, particularly the front quick-release wheel, the rear wheels, and the handlebar.
- Do not park the carrier on roads or other places which are on an incline.
- If you leave the jogging stroller standing, always secure it with the parking brake.
- When parking the carrier, make sure it cannot tip over.
- When pushing the jogging stroller, always put the wrist safety strap around your wrist.
- Inline skating with the jogging stroller is not permitted.
- To get used to the specific handling characteristics, first carry out a practice run without children, but with maximum load, and away from road traffic.

- The parking brake on the Cheetah 1, Cheetah 2, Cougar 1 and Cougar 2 models is not suitable for deceleration of a moving carrier.
- So as to prevent it from tipping backwards, the storage bags at the rear of the carrier may not be loaded with excessive weight. Carry out the following check: Depress the handlebar by about 6"/15 cm. The carrier should return to its original standing position and should not tip backwards. Manufacturer's recommendation: Maximum load in the storage bags together if no handlebar bag is being used. The maximum load of the handlebar bag is 1 kg/2.2lb. The maximum load of the other storage bags is reduced to 2 kg/4.4lb if the handlebar bag is loaded with 1 kg/2.2lb.

Safety instructions for using the brake system on the CX 1 and CX 2 models:

- Before using the brake system for the first time, acquaint yourself with its braking effect away from road traffic.
- On your first journeys always take the Owner's Manual with you in case adjustments need to be made to the brake system.
- Check the braking effect before each journey.
- Before each journey check that both brakes operate with the same force.
- Before each journey check that the lock nuts are tight on the adjusting screws.
- Before each journey check that there are no kinks in or other damage to the brake cables.
- Always ensure that when the parking brake is applied the spring button is fully pressed in. If this is not done, the brake lever could be released and the parked carrier could roll away.
- Only park the carrier on flat surfaces.
- Check that the parking brake is working properly. Always check that the carrier cannot roll away. If the carrier is given a push, it should immediately come to a halt once it has been released.
- If the carrier is not held securely by the parking brake, the brake must be readjusted.
- Remember that the brake drums heat up when used, so there is a risk of burning yourself if you touch them.
- Before each journey make sure that the brake system adjusting screws are secured and not unscrewed too far.
- If you need to replace brake system components due to wear or for other reasons, only have replacement carried out by an Authorized Chariot Retailer.
- Keep the insides of the drum brake dry and free of dirt.

Performance characteristics when used as a Jogging Stroller

Top speed on straight aways	15 km/h / 9 mph
Top speed on corners	walking pace (10km/h / 6 mph)
Top speed on hills/inclines	walking pace (10km/h / 6 mph)

Assembly

Push the wheel arms, with the bend toward the centre of the carrier and wheel dropouts pointing downwards, into each VersaWing 2.0.



Press the small button in for each and push the wheel arms into the VersaWing 2.0 until the large button engages (Figures 1 to 3).



The wheel arm should now protrude about 2 cm / 3/4 inch out of the rear side of the VersaWing 2.0.

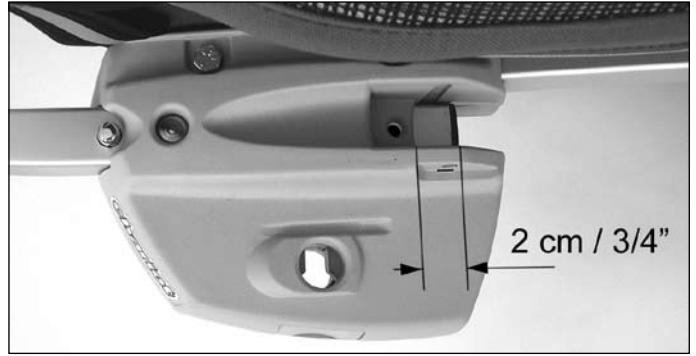

WARNING

Make sure that the wheel arms are correctly attached to the carrier. Incorrect attachment may lead to loss of the front wheel resulting in an otherwise avoidable accident in which you and/or your passenger(s) could suffer serious injury or death.

Guide the quick-release axle through the wheel axle and screw on the nut. Both skewer springs must be located on each side so that the narrow side points towards the centre of the hub.

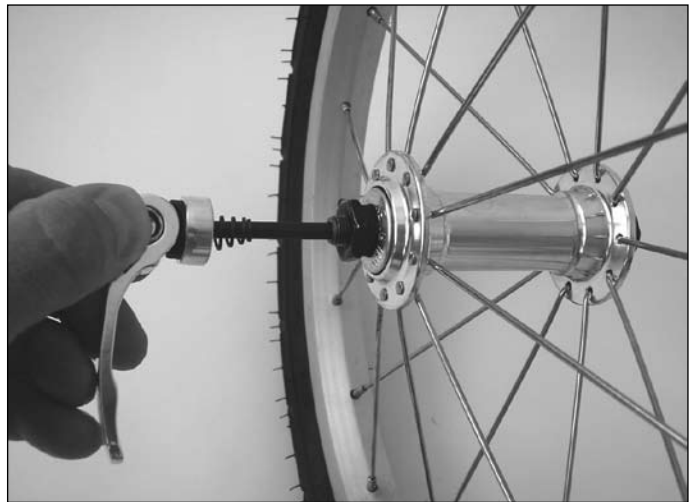

Tip the carrier backwards and put it down on the handlebar. Insert the wheel in the axle dropouts.



Close the quick-release lever.

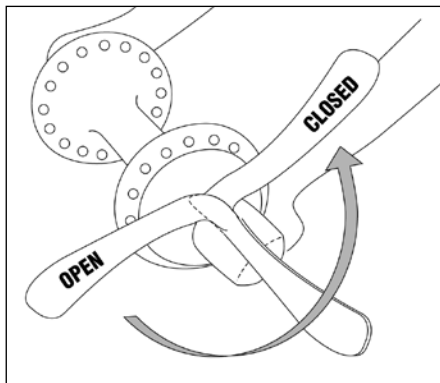

In order to ensure that the hub is clamped sufficiently in the axle dropouts, the quick-release lever must begin gripping as it moves from the open to the middle position, and approaching the closed position you should clearly feel resistance as you tighten.

If it is too easy or too difficult to move the quick-release, tighten or loosen the lock nut on the other side of the hub to adjust.

If you don't feel confident operating the quick-release skewer, please ask your specialist retailer for assistance.

⚠ WARNING

Always make sure that the quick-release is correctly installed. An incorrectly tensioned quick-release may lead to the front wheel coming loose, resulting in an otherwise avoidable accident in which you and/or your passenger(s) could suffer serious injury or death.

To correct directional trueness (ie. The carrier not rolling straight):

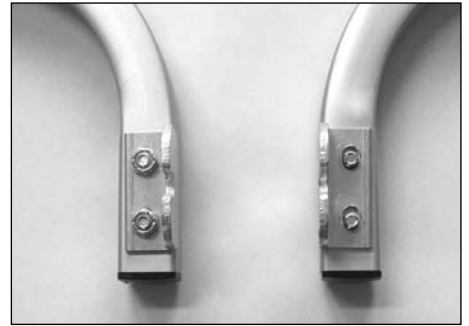

The dropouts of the wheel arms are bolted on and their holes are slotted. After loosening both bolts, the dropout can be moved. This is possible on both the right-hand and the left-hand side dropout. If the Jogging Stroller is pulling to the right, the dropout on the right-hand side must be moved forwards, and the one on the left-hand side backwards (or vice versa).

NOTE

Please ensure that your child does not stand on the wheel arms when entering or leaving the carrier. If at any time you stop, do not allow anyone to sit on the wheel arms.

Storing the wheels arms and 16" wheel

3 straps are provided at the rear on the storage bag for attaching the 16"/40cm wheel. First of all thread correctly and then pull the top webbing strap tight. Then secure the wheel using the right and left-hand Velcro straps.



NOTE

Always make sure, that the 16" wheel is attached securely.

If you want to convert the carrier from Jogging Stroller to another CTS Conversion Kit, or if you want to store the carrier, the wheel arms can be attached to the rear side of the carrier. The 16"/40cm wheel can be attached at the back of the rear storage bag.

For this, the carrier must upright or erected.

The wheel arm can be attached to a Click 'n' Store bracket on the rear side of the carrier. Press the small spring button in and insert the wheel arm in the groove provided for it in the Click 'n' Store bracket. Position the wheel arms so that the large spring button engages in the hole of the Click 'n' Store bracket. Always attach the right-hand wheel arm (as seen in the direction of travel) to the right-hand side of the carrier (as seen in the direction of travel) and the left-hand one to the left-hand side. The axle dropouts will then protrude inwards below the carrier.



NOTE

Always make sure that the large spring button of each wheel arm engages in the hole of the relevant Click 'n' Store bracket. If this is not done, the wheel arm might work loose and get caught in the wheel spokes. You run the risk of an accident!

Travelling

Always make sure you follow the Owner's Manual for the brake system on the CX – please see Section 4.10.

Weight distribution

⚠ WARNING

So as to prevent it from tipping backwards, the storage bags at the rear of the carrier may not be loaded with excessive weight. Carry out the following check while the carrier is standing on a flat surface:

Push downwards on the handlebar by about 15cm / 6". The carrier should return to its original standing position and should not tip backwards. Manufacturer's recommendation: There should be a maximum load of 4 kg in all the rear storage bags together if no handlebar bag is being used.

The maximum load of the handlebar bag is 1 kg/2.2lb. The maximum load of the other rear storage bags is reduced to 2 kg/4.4lb if the handlebar bag is loaded with 1 kg/2.2lb.



⚠ WARNING

When using the carrier as a Jogging Stroller, always put the safety wrist strap, which is fastened securely on the left rear upper frame tube, around your wrist. Failure to use the wrist strap could cause the carrier to become separated from you resulting in an accident in which your passenger(s) could suffer serious injury or death.

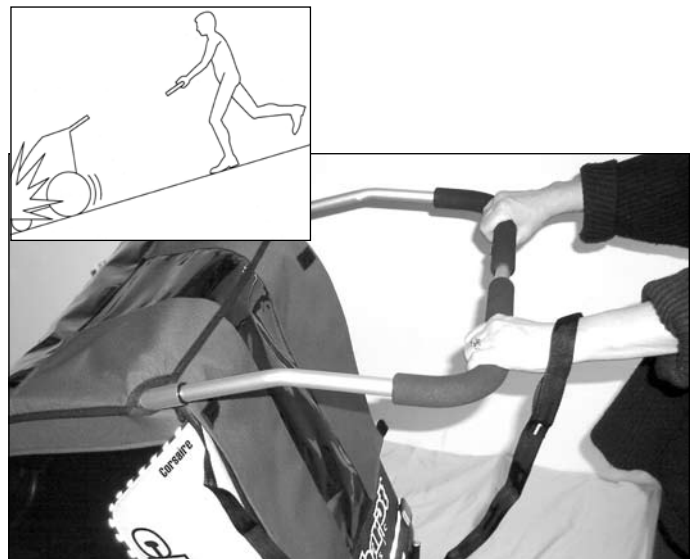

8. The Strolling Kit



The assembled Stroller (CTS Ready Chassis + Strolling Kit)

Supplied as standard

Strolling Kit:
2 x 8" stroller wheels

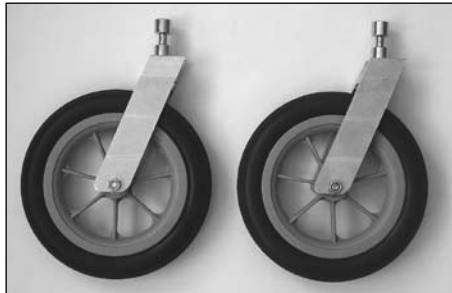

Safety instructions for using the brake system on the CX 1 and CX 2 models:

- Before using the brake system for the first time, acquaint yourself with its braking effect.
- On your first journeys always take the Owner's Manual with you in case adjustments need to be made to the brake system.
- Check the braking effect before each journey.
- Before each journey check that both brakes operate with the same force.
- Before each journey check that the lock nuts are tight on the adjusting screws.
- Before each journey check that there are no kinks in or other damage to the brake cables.
- Always ensure that when the parking brake is applied the spring button is fully pressed in. If this is not done, the brake lever could be released and the parked carrier could roll away.
- Only park the carrier on flat surfaces.
- Check that the parking brake is working properly. Always check that the carrier cannot roll away. If the carrier is given a push, it should immediately come to a stop once it has been released.
- If the carrier is not held securely by the parking brake, the brake must be readjusted.
- Remember that the brake drums heat up when used, so there is a risk of burning yourself if you touch them.
- Before each journey make sure that the brake system adjusting screws are secured and not unscrewed too far.
- If you need to replace brake system components due to wear or for other reasons, only have replacement carried out by a Authorized Chariot Retailer.
- Keep the insides of the drum brake dry and free of dirt.

Safety instructions for use as a Stroller

- Please make sure you read the safety instructions in the "Safety" section at the beginning of this Owner's Manual.
- Before each journey check that all components are properly fitted, particularly the stroller casters and the handlebar.
- Do not park the carrier on roads or other places which are on an incline.
- If you leave the stroller stationary, always secure it with the parking brake.
- When pushing the stroller, always put the wrist safety strap around your wrist.
- Inline skating with the stroller is not permitted.
- The foot activated parking brake on the Cheetah 1, Cheetah 2, Cougar 1 and Cougar 2 models is not suitable for deceleration of a moving carrier.
- So as to prevent it from tipping backwards, the storage bags at the rear of the carrier may not be loaded with excessive weight. Carry out the following check: Depress the handlebar by about 6"/15 cm. The carrier should return to its original standing position and should not tip backwards. Manufacturer's recommendation: Maximum load in the storage bags together if no handlebar bag is being used. The maximum load of the handlebar bag is 1 kg/2.2lb. The maximum load of the other storage bags is reduced to 2kg /4.4lb if the handlebar bag is loaded with 1 kg/2.2lb.

Assembly

To attach the stroller wheel, press the plastic button on the side of the VersaWing 2.0 until it can go no further. Then, from below, insert the upward pointing caster shaft of the stroller wheel into the vertical hole of the VersaWing 2.0 until it can go no further.



Release the plastic button. This now clicks back towards the outside, resulting in locking of the attachment axle of the stroller wheel.



⚠ WARNING

Always make sure that the stroller wheels are properly and fully engaged and locked. To check this pull the stroller wheels up and down in a vertical direction. Make sure that the plastic locking button has fully clicked back. Failure to do so could result in the lose of the wheels causing an accident in which you and/or your passenger(s) could suffer serious injury or death.

If you want to convert the carrier from Stroller to another CTS Conversion Kit, you can store the stroller wheels on the top of the VersaWing 2.0 .

To attach them proceed as described above. The caster fork arms should point backwards.



⚠ WARNING

Always make sure that the stroller wheels are fully engaged and locked. Failure to do so could result in the lose of the stroller wheels causing an accident in which you and/or your passenger(s) could suffer serious injury or death.

⚠ WARNING

When used as a Bicycle Trailer, the stroller wheels must never be installed in their use position (wheels down). They may only be carried in their out-of-use position (wheels up) Failure to do so may lead to an otherwise avoidable accident in which you and/or your passenger(s) could suffer serious injury or death.



Correct assembly of the stroller wheels for carrying them out-of-use when used as a Bicycle Trailer.

Wrong!!!

Travelling

Always make sure you follow the Owner's Manual for the brake system on the CX – please see Section 4.10.

Weight distribution

⚠ WARNING

So as to prevent it from tipping backwards, the storage bags at the rear of the carrier may not be loaded with excessive weight. Carry out the following check while the carrier is standing on a flat surface:

Push downwards on the handlebar by about 6"/15cm. The carrier should return to its original standing position and should not tip backwards. Manufacturer's recommendation: There should be a maximum load of 4 kg in all the rear storage bags together if no handlebar bag is being used.

The maximum load of the handlebar bag is 1 kg/2.2lb. The maximum load of the other rear storage bags is reduced to 2 kg/4.4lb if the handlebar bag is loaded with 1 kg/2.2lb.



⚠ WARNING

When using the carrier as a Jogging Stroller, always put the safety wrist strap, which is fastened securely on the left rear upper frame tube, around your wrist. Failure to use the wrist strap could cause the carrier to become separated from you resulting in an accident in which your passenger(s) could suffer serious injury or death.

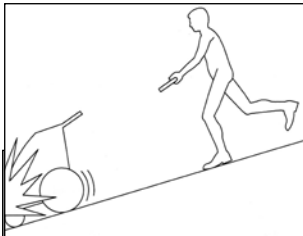

9. The Hiking Kit



Supplied as standard

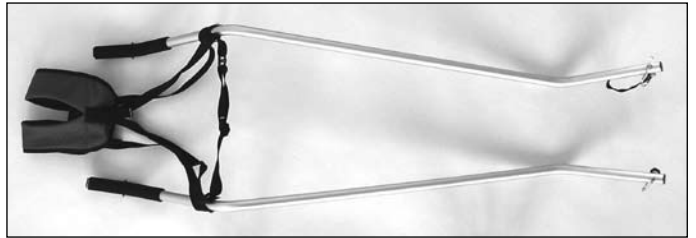

2 hiking arms with shoulder harness and waist strap

Safety instructions for use as a Hiking Carrier

- Please make sure you read the safety instructions in the "Safety" section at the beginning of this Owner's Manual.
- Before each journey check that all components are properly fitted, particularly the wheels and the hiker arms.
- Always make sure that the security pin of the hiker arms is properly installed so as to prevent the carrier from accidentally separating from the arms.
- Be mindful of the space needed due to the width and length of the carrier. Take care in oncoming traffic on narrow paths!
- Please remember that controlling a fully loaded hiker requires experience and good physical fitness.
- Particular care is needed on slopes, uneven terrain and when stopping. Do not use on steep or difficult hiking trails.
- First take the hiker for a practice run without children, but with the maximum load. Perform the practice run on terrain that is more difficult to cover than that which you want to travel later with children.

Assembly

Lay both the hiking arms with shoulder harness and waist strap as shown in the "Supplied as standard" illustration in front of the carrier. The waist strap must be attached to the insides of both arms.

Insert each arm into the VersaWing 2.0 until the vertical holes in the arms and VersaWing 2.0 are aligned with each other. The arms should now protrude about 2 cm / 3/4 inch out of the rear side of the VersaWing 2.0.

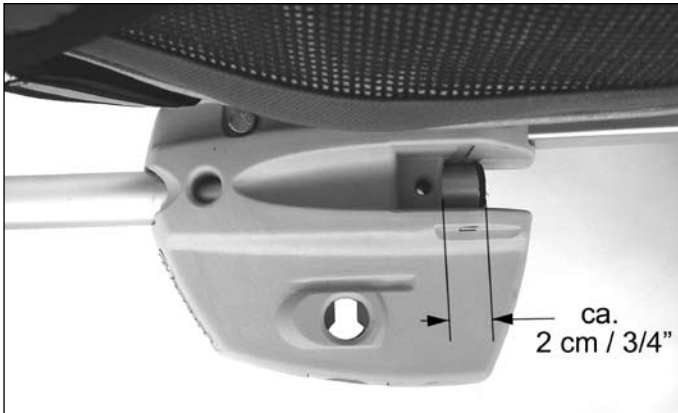

Now secure the arms by inserting the security pin from above through the vertical hole in the arm and VersaWing 2.0 until it stops. Lock the security pin by looping the spring clip over the pins end that protrudes underneath the VersaWing 2.0.



⚠ WARNING

Always make sure that the security pin of the hiking arms are properly inserted to prevent the carrier from accidentally rolling away resulting in an accident in which your passenger(s) could suffer serious injury or death.

The shoulder strap, which is attached in a similar way to that of a backpack, can be adjusted in three positions: at the chest strap at the front,



at the back strap on top for adjusting the height of the waist strap,



and at the waist strap itself.



TIP

The holes in the hiking arms are larger than the security pins, so that the arms can rotate slightly around their longitudinal axes (in order to adapt to narrow or wide hips, and single and double width carriers).

10. The XC-Skiing Kit

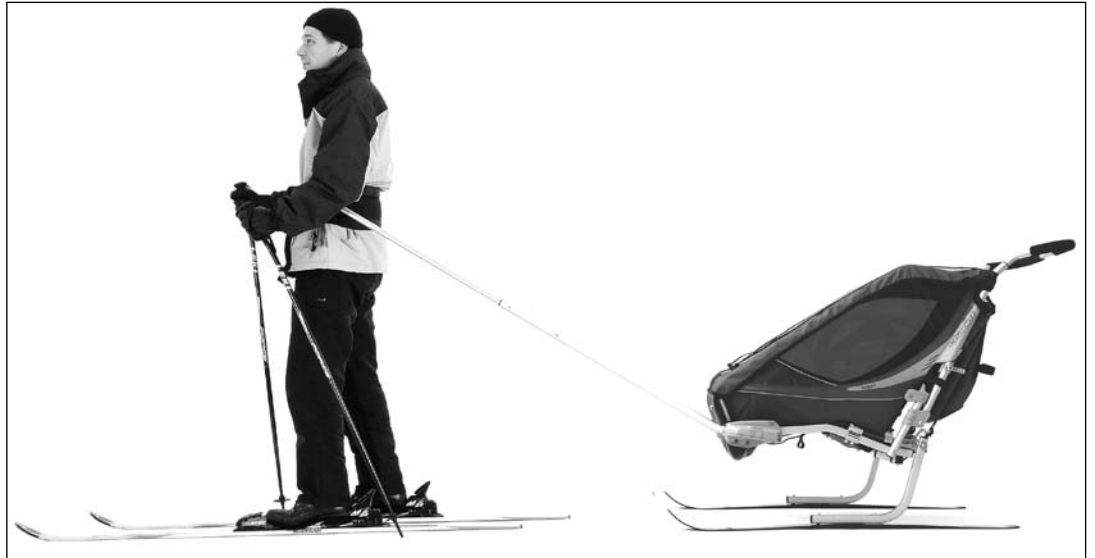

Supplied as standard



Skis with frames, ski arms with waist belt, additional self-locking nuts

Safety instructions for use as an XC Skiing Carrier

- **Please note: For the CX 1 and CX 2 models there is a special XC Skiing Kit axle adapter required. The XC Skiing Kit does not fit because the axle is too short. The short axle will not engage fully in the CX1 and CX2 models, with the result that the skis would not be held securely.**
- Please make sure you read the safety instructions in the "Safety" section at the beginning of this Owner's Manual.
- Before each journey check that all components are properly fitted, particularly the skis and the tow bars.
- Always make sure that the security pin of the tow bars are properly installed, so as to prevent the carrier from accidentally separating from the arms.
- Always make sure the buckle on the strap is securely closed and the strap fits tightly. If this is not done, the XC Skiing Carrier might get separated from you resulting in an accident in which your passenger(s) could suffer serious injury or death.
- Make sure the length of the tow bars are adjusted correctly, to ensure that your skis or poles will not come into contact with the carrier.

- Remember that the additional weight of the carrier with the XC skiing kit considerably changes the way you ski, particularly going up or down hills. For this reason, only an experienced skier should use the carrier with the XC skiing kit.
- First take the carrier with the XC skiing kit for a practice run without children, but with the maximum load. Perform the practice run on terrain that is more difficult to ski than that which you want to travel later with children.
- Be mindful of the increased space needed when cross-country skiing, due to the width and length of the carrier. Take care in oncoming traffic!
- Never use the carrier with the XC skiing kit for downhill skiing.
- Never tow the carrier with the XC skiing kit behind a snowmobile, quad or any motorized vehicle
- Use extreme caution on hills, challenging trails, and when stopping.
- Regularly check on your children to ensure they are comfortable and are warm enough.

TIP

Check that use of the XC Skiing Carrier is allowed in the skiing region where you intend to use it.

Assembly

Fitting the CX Axle Adapter Kit to the skis

If you want to use the XC Skiing Kit on the CX, you must first convert the ski frames. For this you will need to get a special CX Axle Adapter Kit from your authorized Chariot retailer. Install this Adapter Kit to the skis according to the installation instructions supplied with the kit.

⚠ WARNING

Without conversion using the CX Axle Adapter Kit, the XC Skiing Kit must not be used on the CX. The standard XC Ski Kit axles will not engage fully on the CX1 and CX2, with the result that the skis would not be held securely resulting in an accident in which your passenger(s) could suffer serious injury or death.

Attaching the skis to the carrier

Cheetah and Cougar

Remove the wheels (for this, press the rubber cap in the centre of the wheel).

To attach the skis, press the spring button in and insert the attachment axle into the axle socket until it can go no further. Release the spring button. By moving the skis from side to side, check that they are locked in the axle socket and cannot be pulled off.

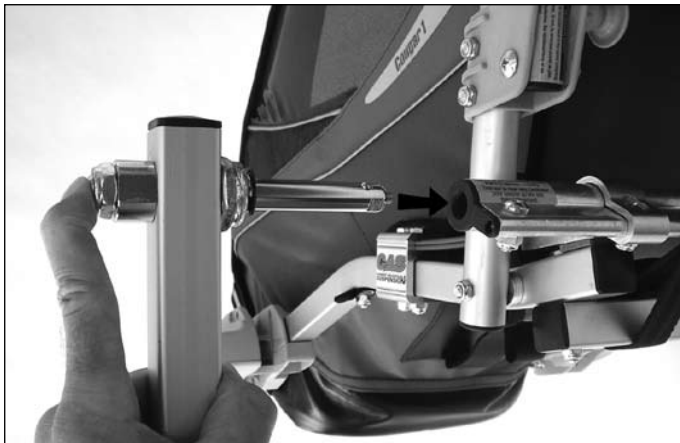

NOTE

Always make sure that the ski tips point towards the front.

⚠ WARNING

Before each journey make sure that the skis are securely locked in the axle socket to prevent the carrier from accidentally sliding away resulting in an accident in which your passenger(s) could suffer serious injury or death.

CX

To attach the XC Skiing Kit to the carrier, first remove the carrier wheels.

Then attach the clear protective caps over the exposed drum brake calipers.

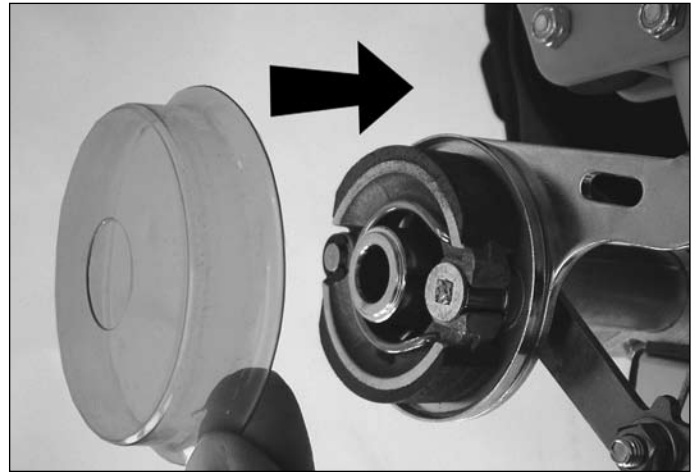

Pressing down the axle's locking button, pull the axle all the way out of the wheel hub.



Pressing down the locking button, insert the axle through the socket at the top end of the ski frame.

Make sure that you insert the axle from the outside inwards, looking in the direction of the ski tip.

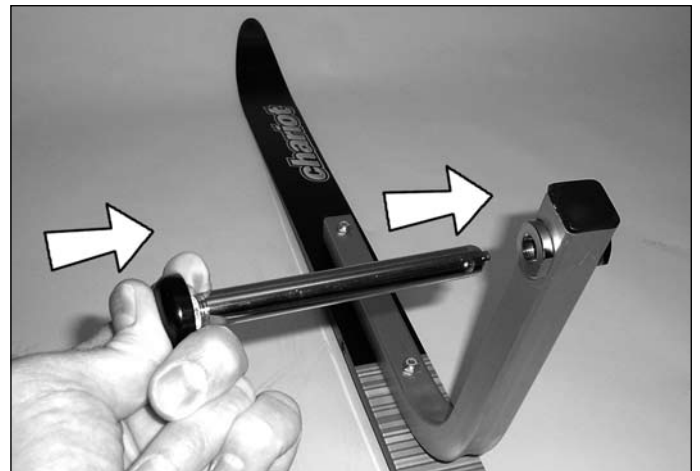

Pressing down the locking button on the axle, insert the XC Skiing Kit into the axle socket on the Chariot CX until it can go no further. Release the locking button. The axle will now click if installed fully.

Make sure the skis are inserted correctly with the ski tips towards the front of the carrier.

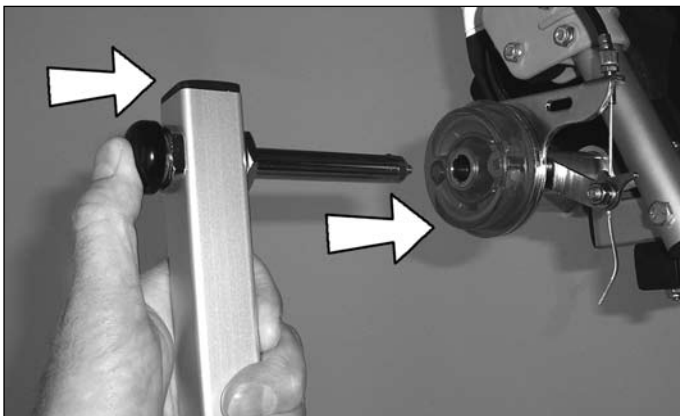

⚠ WARNING

Always check that both ski frames are properly attached by pulling the ski frame outwards hard without pressing the axle's locking button. To do this, lift the carrier slightly and hold it firm with one hand. Make sure that the ski cannot be pulled off. Failure to do so could result in the loss of the skis causing an accident in which your passenger(s) could suffer serious injury or death.

Fitting the ski arms to the carrier

Identical for all models.

Insert each arm into the VersaWing 2.0 until the vertical holes in the arms and VersaWing 2.0 are aligned with each other. The arms should now, at the back in the slot of the VersaWing 2.0, protrude about 2 cm / 3/4" over the plastic edge.



Now secure the arms by inserting the security pin from above down through the vertical hole in the arm and VersaWing 2.0 until it stops. Lock the security pin by looping the spring clip over the pins end that protrudes underneath the VersaWing 2.0.



⚠ WARNING

Always make sure that the security pin of the ski arms are properly inserted to prevent the carrier from accidentally sliding away resulting in an accident in which your passenger(s) could suffer serious injury or death.

TIP

The holes in the ski arms are larger than the security pins, so that the arms can rotate slightly around their longitudinal axes (in order to adapt to narrow or wide hips, and single and double width carriers).

Length adjustment of the ski arms

The ski arms are adjustable for length. To do this, withdraw the security pin which connects the two ski arm tubes.

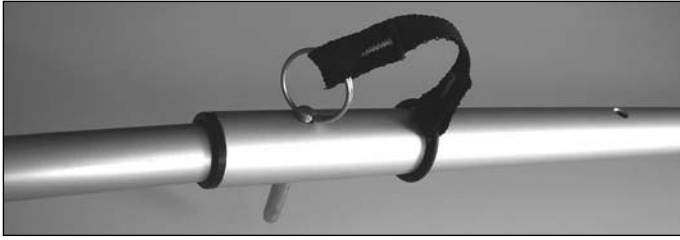

Move both tubes towards each other until the desired holes in both tubes align with each other.

Reinsert the security pin, pushing it in until it goes no further.

⚠ WARNING

Always make sure that the security pins which connect both tubes of the drawbars are properly inserted in to prevent the carrier from accidentally sliding away resulting in an accident in which your passenger(s) could suffer serious injury or death.

Putting on the waist belt

Always put the waist belt on so that the padded area is at the back and the strap with its side-release buckle is at the front. Always close the buckle with care!

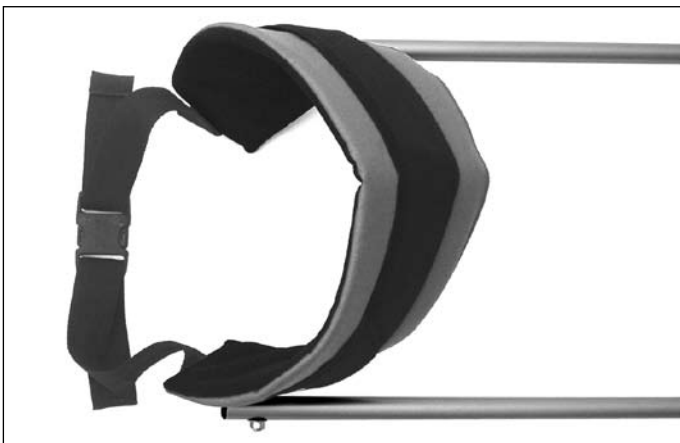

Adjust the 2 straps on either side of the buckle to that it is a tight fit around your hips, and so that the buckle is centered.

⚠ WARNING

Always make sure the buckle on the strap is securely closed and the strap fits tightly. If this is not done, the XC Skiing Carrier might get separated from you resulting in an accident in which your passenger(s) could suffer serious injury or death.

If required, the waist belt can be adjusted for larger and smaller hips. To do this, undo both attachment screws and reinstall them into the appropriate grommets. When refitting the screws, always use the additional self-locking nuts supplied.



⚠ WARNING

Once self-locking nuts have been loosened they cannot be reused. Once they have been loosened, they lose their securing function, and this can lead to unexpected loosening of the screw connection with potentially serious consequences.

11. Accessories

Axle-Mount ez-Hitch for additional bike

Baby Bivy

Baby Supporter

Bunting Bag

Hydration Kit

Handlebar Bag

Infant Sling

Jogging Brake Kit 2.0

Rain Cover

Side Fenders 2.0

Storage Cover

Travel Bag

X-Country Cargo Rack

12. Service, Care and Storage

Hitcharm

Check the hitcharm regularly for signs of damage (e.g. cracks).

⚠ WARNING

If there is any kind of damage whatsoever to the hitcharm, then it must be replaced so as to prevent breakage which could result in an accident in which your passenger(s) could suffer serious injury or death.

Wheels

Clean the wheel axles, the retaining balls and the push-button pin regularly. Apply some grease or oil to the retaining balls and push-button pin.



⚠ WARNING

If the retaining balls and push-button pin are not regularly maintained, they may lose their securing function. This could result could result in the loss of the wheels causing an accident in which you and/or your passenger(s) could suffer serious injury or death.

Have the wheels (tires, rims, tension of spokes, axle bearing) checked by your specialist retailer at least once every year.

Clean the wheels regularly and give them a protective wax, particularly just before the onset of Winter.

Fabric

Check the fabric regularly for signs of damage (e.g. tears).

Contact your authorized Chariot retailer immediately if you find a tear in the fabric. The fabric can be repaired or replaced.

⚠ WARNING

Tears in the fabric actually represent a high safety risk. Due to tears in the fabric, your child could come into contact with the wheels or the road surface and be seriously injured.

Clean the fabric regularly with domestic soap or a mild cleansing agent and warm water. Never use thinners or cleaning solvent.

Storage

Store your Chariot CTS in a dry and well-ventilated place. Before storing your carrier, it should be dry to prevent the growth of mould and the formation of mildew. Expose your carrier as little as possible to direct sunlight to prevent fabric colours from fading. Do not store the Bicycle Trailer coupled to the bicycle over a long period of time.

NOTE

As well as rubber, tires contain many chemical substances which improve their physical characteristics. In unfavourable circumstances, these substances may lead to staining of the transparent side and front windows on the carrier. For this reason, always store wheels in such a way that they do not come into contact with these windows.

General Maintenance

Look after your carrier. All painted, chrome or galvanised parts (including screw connectors) should be regularly cleaned and protected using standard products for this purpose. Ask your specialist retailer about suitable products for protecting your carrier.

13. Specifications

L x W x H, without hitcharm

(Cheetah 1, Cougar 1) (35" x 27" x 34") 89 x 69 x 86 cm

L x W x H, without hitcharm

(CX 1) (35" x 27.5" x 34") 89 x 70 x 86 cm

L x W x H, without hitcharm

(Cheetah 2, Cougar 2) (35.5" x 32" x 34") 90 x 82 x 86 cm

L x W x H, without hitcharm

(CX 1) (35.5" x 32" x 34") 90 x 83 x 86 cm

L x W x H, folded up

(Cheetah 1, Cougar 1) (41" x 23.5" x 12.5") 105 x 60 x 31 cm

L x W x H, folded up

(CX 1) (41" x 23.5" x 12.5") 107 x 60 x 31 cm

L x W x H, folded up

(Cheetah 2, Cougar 2) (41" x 23.5" x 12.5") 107 x 79 x 26 cm

L x W x H, folded up

(CX 2) (41" x 23.5" x 12.5") 109 x 79 x 26 cm

Unladen weight of the Ready Chassis

Modell Cheetah 1	10 kg / 22 lb
Modell Cheetah 2	11 kg / 24,2 lb
Modell Cougar 1	10,2 kg / 22,4 lb
Modell Cougar 2	11,9 kg / 26,2 lb
Modell CX 1	12,7 kg / 28 lb
Modell CX 2	14,8 kg / 32,6 lb

Cargo load single-seater	34 kg / 75 lb
Cargo load two-seater	45 kg / 100 lb

Wheel size for Ready Chassis	20"/51cm
Wheel size for Jogger Kit	16"/41cm

14. Wear and Tear

Our products have components or parts which are also subject to natural wear and tear arising from normal use, depending very much on the type and degree of use and also how well the individual product has been serviced and maintained.

In particular where there has been a lot of use (day in day out and in all kinds of weather), individual parts or components can reach their wear limit before the warranty has expired. Just because a product has become prematurely worn because of use, it does not generally mean the product is defective.

For your information we have therefore listed in the following table the important parts affected by wear and tear, and have named typical contributing factors relating to use, which may considerably influence wear limit.

Maintenance and care of bicycle trailers and jogging strollers:

Irrespective of

- Type of use
- Intensity of use
- Care and maintenance

functional-related wear occurs in bicycle trailers or jogging strollers in the components and parts listed in the following table. Reaching the wear limit very much depends on how well the users have looked after and maintained the product as well as the particular type and intensity of use such as:

- **Mileage**
- **Loading of:**
Passengers
Baggage
- **Type of ride:**
Degree of acceleration and braking
- **Fast cornering**
- **Effects of the weather:**
UV rays
Humidity
Dirt
Temperature
Salty air
Contact with salt water
Roads gritted with salt
- **Storage**
- **Level of maintenance:**
Service intervals
Means of maintenance
Storage
Servicing and inspection work

Please look at the following table: 'Wear factors'.

You can see from this table which factors particularly affect the wear and tear on individual parts.

Factors which particularly increase wear on bicycle trailers and jogging strollers:

Wear factors		Parts								
		Fabric body	Seat	Textile floors & side walls	Windows	Brake pads (stroller)	Brake cable (stroller)	Rims, hubs, axles & spokes	Tires ^{*5}	Hitch arm, hitch
Loading of:	Passengers		x	xx		x	x	x	xx	xx
	Baggage			xx		x	x	x	xx	xx
Type of ride	Degree of acceleration and braking			xx	x	xx	xxx	xxx		
Fast cornering			x		xx	x	xx	xxx	xxx	
Influence of the weather:	UV rays	xx ^{*1}	x	xx	xx				xx ^{*2}	
	Humidity	xx ^{*3}	xx	xx	x		xx	x	x	
	Dirt	xx	xx	xx	xx	x	xx	x	x	
	Temperature	x ^{*6}	x	x ^{*6}	xx ^{*6}		x		x	
	Salty air	x	x	xx	x	x	xx	xx	x	xx
	Contact with salt water	xx	xx	xx	xx	x	xx	xxx	x	xx
	Roads gritted with salt	xx		xx	x	x	xx	xxx	x	xx
Storage		x ^{*3}	x ^{*3}	x ^{*3}	x ^{*3}				x ^{*4}	

Influences on wear and tear:

- x: Moderate effect on wear and tear
- xx: Strong effect on wear and tear
- xxx: Considerable effect on wear and tear

- *1 - If at all possible, avoid exposure to strong sun light
- *2 - If at all possible, avoid long exposure to sun light
- *3 - Avoid mould forming by storage in a dry place
- *4 - No wear and tear if stored in a hanging position
- *5 - Regularly check the air pressure
- *6 - Cold: At temperatures below -20°C / -4°F the material gets brittle and may crack.

15. Warranty



LIMITED LIFETIME WARRANTY

CHARIOT CARRIERS INC. warrants that the frame is free of defects for the lifetime of the product. The fabric and hitch are warranted for one year following the date of delivery to the original purchaser. This warranty does not include the wheels and tires. This warranty is valid only to the original purchaser and under normal use.

Repairs must be made by CHARIOT CARRIERS INC. or an authorized dealer, otherwise this warranty is void. CHARIOT CARRIERS INC. reserves the right to repair or replace the warranted carrier.

This warranty does not apply to damages caused by misuse of this product, accidental or intentional damage, neglect or commercial use. Excluded from this warranty is liability for consequential property or commercial damages or for damages for loss of use.

This constitutes the only warranty of CHARIOT CARRIERS INC. and its authorized agents and dealers and no other warranty or conditions, statutory, parole, collateral or otherwise (including conditions requiring compliance with description, fitness for purpose and merchantable quality) shall be implied.

WARRANTY

To validate your warranty and for contacting you for any future potential safety notices, please complete the following information and send to: Chariot Carriers Inc., Bay F, 6810 – 6th Street SE, Calgary, Alberta, T2H 2K4, CANADA . You can also validate your warranty on-line at www.chariotcarriers.com.

Name:	Model:	
Address:	Serial #: _____ / _____ - _____ M Y/A #N*	
City:	Province or State:	Country:
Postal Code or Zip Code:	Telephone:()	
Date of Purchase:	Store & Location:	

I purchased a CHARIOT CARRIER for the following reason(s):

- | | | | |
|---|--|---|---|
| <input type="checkbox"/> reasonable price | <input type="checkbox"/> easy to assemble | <input type="checkbox"/> recommended by friend | <input type="checkbox"/> the many features |
| <input type="checkbox"/> quality of product | <input type="checkbox"/> North American made | <input type="checkbox"/> visited Chariot's web site | <input type="checkbox"/> saw an advertisement |
| <input type="checkbox"/> lifetime warranty | <input type="checkbox"/> CTS Conversion Kits | <input type="checkbox"/> recommended by salesperson | |

Additional comments:
