



**TRANE®**

# Owner's Manual

## SmartGen® HSC940 Controller



**Note:** "Graphics in this document are for representation only.  
Actual model may differ in appearance."

### **⚠ SAFETY INSTRUCTIONS**

Only qualified personnel should install and service the equipment. The installation, starting up, and servicing of home standby generator equipment can be hazardous and requires specific knowledge and training. Improperly installed, adjusted or altered equipment by an unqualified person could result in death or serious injury. When working on the equipment, observe all precautions in the literature and on the tags, stickers, and labels that are attached to the equipment.

# Table Of Contents

Overview . . . . .	<b>3</b>
Performance & Characteristics . . . . .	<b>4</b>
Specifications . . . . .	<b>5</b>
Operations . . . . .	<b>6</b>
Key Operations / Indicator Lights . . . . .	<b>6</b>
Auto Start / Stop Operation . . . . .	<b>7</b>
Manual Start / Stop Operation . . . . .	<b>8</b>
Protection . . . . .	<b>9</b>
Warnings . . . . .	<b>9</b>
Shutdown Alarms . . . . .	<b>10</b>
Wiring Connections . . . . .	<b>12</b>
Scope & Definition of Configurable Parameters . . . . .	<b>14</b>
Contents & Scope of Parameters . . . . .	<b>14</b>
Enable Definitions of Programmable Output Ports . . . . .	<b>19</b>
Defined Contents of Configurable Input Ports . . . . .	<b>21</b>
Conditions of Crank Disconnect Selection . . . . .	<b>22</b>
Parameter Settings . . . . .	<b>23</b>
Commissioning . . . . .	<b>24</b>
Typical Application . . . . .	<b>25</b>
Connection Between Controller and Genset . . . . .	<b>25</b>
Installation . . . . .	<b>26</b>
Fixing Clips . . . . .	<b>26</b>
Overall Dimension and Panel Cutout . . . . .	<b>27</b>
GSM Short Message Alarm and Remote Control . . . . .	<b>28</b>
GSM Short Message Alarm . . . . .	<b>29</b>
GSM Short Message Remote Control . . . . .	<b>29</b>
Fault Finding . . . . .	<b>30</b>

# Overview

HSC940 genset controllers integrate digitization, intellectualization and network technology which are used for gas genset automation and monitor control system of single unit to achieve automatic start/stop, data measure, alarm protection, three remote: remote control, remote measuring and remote communication (SG485 module must be fitted) and speed regulation. The controller adopts large liquid crystal display (LCD) and selectable Chinese, English, Spanish and Russian interface with easy and reliable operation.

HSC940 genset controllers adopt microprocessor technology with precision parameters measuring, fixed value adjustment, time setting and set adjusting etc. All parameters can be configured from front panel, or by configurable port (USB to LINK, SG72 must be fitted) to adjust via PC. It can be widely used in all types of automatic genset control system with compact structure, advanced circuits, simple connections and high reliability.

# Performance & Characteristics

HSC940, used for single automation systems; it regulates the speed simply by adjust the throttle opening via the driving stepper motor; auto start/stop of the unit are performed with the help of remote signal.

## Key characteristics









- 132×64 LCD with backlight, multilingual interface (including Chinese, English, Spanish and Russian), pushbutton operation;
- Suitable for 3-phase 4-wire, 3-phase 3-wire, single phase 2-wire, and 2-phase 3-wire systems with voltage 120/240V and frequency 50/60Hz;
- Collects and shows 3-phase voltage, current, power parameter and frequency of generator.  
Generator  
Line voltage (Uab, Ubc, and Uca)  
Phase voltage (Ua, Ub, and Uc)  
Frequency Hz
- For generator, controller has over and under voltage, over and under frequency functions;
- Speed regulation function (via Driving Stepper Motor);
- Precision measure and display parameters about Engine,  
Speed (SPD) r/min (unit)  
Battery Voltage (VB) V (unit)  
Charger Voltage (VD) V (unit)  
Hour count (HC) can accumulate to max. 999999 hours.  
Start times can accumulate to max. 999999 times.
- Protection: automatic start/stop of the genset, ATS(Auto Transfer Switch) control with perfect failure indication and protection function;
- ETS (Energize to Stop), idle control, preheat control and raise speed/drop speed control; in addition, they are all relay output.
- Parameter setting: parameters can be modified and cannot be lost even in case of power outage; all parameters can be configured from front panel, or by configurable port (SG72 must be fitted) to adjust via PC.
- Multiple crank disconnect conditions (speed sensor, generator frequency) are optional;
- Widely power supply range DC(8~35)V, suitable to different start battery voltage environment;
- All parameters used digital adjustment, instead of conventional analog modulation with normal potentiometer, more reliability and stability;
- Modular design, self-extinguishing ABS plastic enclosure, pluggable connection terminals and embedded installation way; compact structure with easy mounting.

# Specifications

Items	Contents
Operating Voltage	DC8.0V to DC35.0V, Continuous Power Supply.
Power Consumption	Standby: $\leq 2W$ Working: $< 8W$ (When driving stepper motor is regulating)
Alternator Input Range 3-Phase 4-Wire 2-Phase 3-Wire Single-Phase 2-Wire 3-Phase 3-Wire	AC15V - AC360V (ph-N) AC15V - AC360V (ph-N) AC15V - AC360V (ph-N) AC30V - AC620V (ph-ph)
Alternator Frequency	50Hz/60Hz
Speed Sensor Voltage	1.0V to 24.0V (RMS)
Speed Sensor Frequency	10,000 Hz (max.)
Start Relay Output	5A DC28V supply output
Fuel Relay Output	5A DC28V supply output
Auxiliary Relay Output (1)	5A DC28V supply output
Auxiliary Relay Output (2)	5A DC28V supply output
Auxiliary Relay Output (3)	5A DC28V supply output
Auxiliary Relay Output (4)	5A DC28V supply output
Steady-state Speed Governing Rate	$< 1.5\%$
Steady-state Speed Fluctuation Rate	$< 0.5\%$
Transient Speed Governing Rate	Sudden Load-on $< +10\%$ Sudden Load-off $> -15\%$
Recovery Time	$< 5s$
Driving Stepper Motor	Mixed 2-phase; Drive current $\leq 1A$
Case Dimension	130mm x 112mm x 39mm
Panel Cutout	110mm x 90mm
Working Conditions	Temperature: $(-25 \sim +70)^{\circ}C$ ; Humidity: (20~93)%RH
Storage Condition	Temperature: $(-25 \sim +70)^{\circ}C$
Protection Level	IP55 Gasket
Insulating Intensity	Apply AC2.2kV voltage between high voltage terminal and low voltage terminal; The leakage current is not more than 3mA within 1min.
Net Weight	0.26kg

# Operation

## 4.1 KEY OPERATIONS

	Stop/ Reset	Stop running generator in Auto/Manual mode; Lamp test (press at least 3 seconds); Reset alarm if alarm occurs; During stopping process, press this button again to stop generator immediately.
	Start	Start genset in Manual/Test mode.
	Manual Mode	Pressing this key will set the module into Manual mode. Pressing  and  simultaneously can adjust LCD contrast.
	Auto Mode	Pressing this key will set the module into AUTO mode.
	Set/Confirm	Pressing this key will view set menu; In parameter setting interface, press this key will shift cursor or confirm setting value.
	Up/Increase	Scrolls the screen up; Shift the cursor up or increase the set value in parameter setting menu.
	Down/Decrease	Scrolls the screen down; Shift the cursor down or decrease the set value in parameter setting menu.

## 4.2 INDICATOR LIGHTS

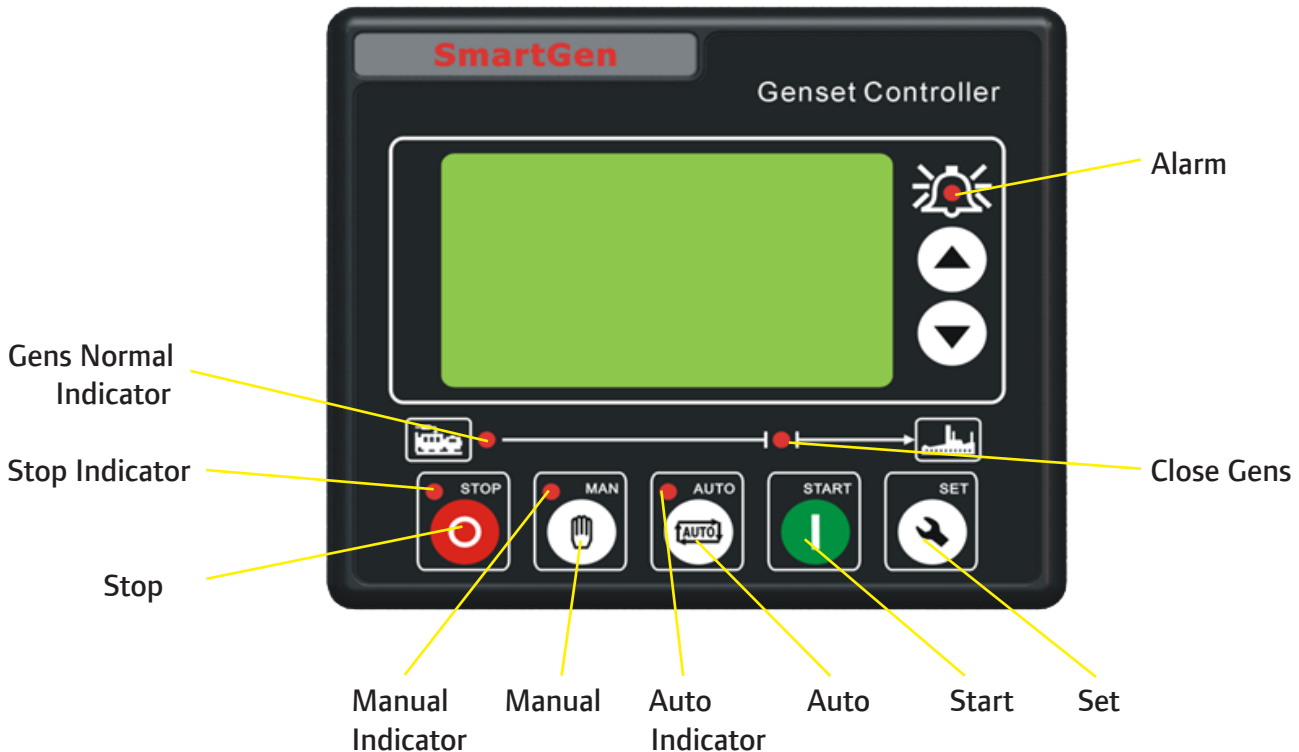

# Operation

## 4.3 AUTO START/STOP OPERATION

Auto mode is selected by pressing the  button; a LED besides the button will illuminate to confirm the operation.

### **Automatic Start Sequence:**

1. When "Remote Start" is active, "Start Delay" timer is initiated;
2. "Start Delay" countdown will be displayed on LCD;
3. When start delay is over, preheat relay energizes (if configured), "preheat delay XX s" information will be displayed on LCD;
4. After the above delay, the Fuel Relay is energized, and then one second later, the throttle of the driving stepper motor will rotate as the pre-set angle and then the Start Relay is engaged. The engine is cranked for a pre-set time. If the engine fails to fire during this cranking attempt then the fuel relay and start relay are disengaged for the pre-set rest period; "crank rest time" begins and wait for the next crank attempt.
5. Should this start sequence continue beyond the set number of attempts, the start sequence will be terminated, the fourth line of LCD display will be highlighted with black and Fail to Start fault will be displayed.
6. In case of successful crank attempt, the "Safety On" timer is activated and the throttle of the driving stepper motor will govern the speed, allowing Low Oil Pressure, High Temperature, Under speed, Charge Alternator Failure and auxiliary inputs (be configured) to stabilise without triggering the fault. As soon as this delay is over, "start idle" delay is initiated (if configured).
7. During "start idle" delay, under speed, under frequency, under voltage alarms are inhibited. When this delay is over, "warming up" delay is initiated (if configured).
8. After the "warming up" delay, if generator status is normal, its indicator will be illuminated. If generator voltage and frequency have reached on-load requirements, then the generator close relay will be energized; genset will take load; generator power indicator will illuminate and generator will enter into Normal Running status. If voltage or frequency is abnormal, the controller will initiate shutdown alarm (alarm information will be displayed on LCD).

### **Automatic Stop Sequence:**

1. When the "Remote Start" signal is removed, the Stop Delay is initiated.
2. Once this "stop delay" has expired, the Generator Breaker will open and the "Cooling Delay" is then initiated. Moreover, the generator indicator is extinguished.
3. During "Stop Idle" Delay (if configured), idle relay is energized.
4. "ETS Solenoid Hold" delay begins, ETS relay is energized while fuel relay is de-energized.
5. "Fail to Stop Delay" begins, complete stop is detected automatically.
6. When generator is stop completely, generator is placed into its standby mode. Otherwise, fail to stop alarm is initiated and the corresponding alarm information is displayed on LCD.

# Operation

## 4.4 MANUAL START/STOP OPERATION

1. MANUAL START: Manual mode is selected by pressing the  button; a LED besides the button will illuminate to confirm the operation.

Then press  button to start the genset; can detect crank disconnect condition and generator accelerates to high-speed running automatically.

With high temperature, low oil pressure, over speed and abnormal voltage during generator running, controller can protect genset to stop quickly. (please refer to No.3~8 of Automatic Start Sequence for detail procedures.) The controller will send Close Gen signal after the genset is normal running.

2. MANUAL STOP: Press  can stop the running generators. (please refer to No.2~6 of Automatic Stop Sequence for detail procedures).



# Protection

## 5.1 WARNINGS

Warnings are not shutdown alarms and do not affect the operation of the genset. Warning alarms does not lead to shutdown and the alarm information will be displayed on the LCD. Warning alarms types are as follows:

No.	Type	Description
1	High Temperature Warn	When the controller detects that there is High Temperature input and the shutdown is prohibited, it will initiate a warning alarm and the alarm information will be displayed on the LCD.
2	Low Oil Pressure	When the controller detects that there is Low Oil Pressure input and the shutdown is prohibited, it will initiate a warning alarm and the alarm information will be displayed on the LCD.
3	Fail to Stop	After the ETS delay/Fail to Stop delay has expired, if the genset stop failure, it will initiate a warning alarm and the alarm information will be displayed on the LCD.
4	Charge Alt Fail	When the controller detects that the charger voltage has fallen below the pre-set value, it will initiate a warning alarm and the alarm information will be displayed on the LCD.
5	Battery Under Voltage	When the controller detects that the battery voltage has fallen below the pre-set value, it will initiate a warning alarm and the alarm information will be displayed on the LCD.
6	Battery Over Voltage	When the controller detects that the battery voltage has exceeded the pre-set value, it will initiate a warning alarm and the alarm information will be displayed on the LCD.
7	Digital Input	When the digit input port is set as warning and active, it will initiate a warning alarm and the alarm information will be displayed on the LCD.
8	Loss of Speed Signal	When the controller detects the speed is 0 and the Loss of Speed Signal delay is set as 0, it will initiate a warning alarm and the alarm information will be displayed on the LCD.
9	Low Coolant Level	When the controller detects that there is Low Coolant Level input, it will initiate a warning alarm and the alarm information will be displayed on the LCD.
10	Low Fuel Level	When the controller detects that there is Low Fuel Level input, it will initiate a warning alarm and the alarm information will be displayed on the LCD.

# Protection

## 5.2 SHUTDOWN ALARM

When controller detects shutdown alarm, it will send signal to open breaker and shuts down generator.

Besides, the alarm information will be displayed on the LCD.

Shutdown alarms as following:

No.	Type	Description
1	Emergency Stop	When the controller detects that there is Emergency Stop input, it will initiate a shutdown alarm and the alarm information will be displayed on the LCD.
2	High Temperature	When the controller detects that there is High Temperature input and the shutdown is allowed, it will initiate a shutdown alarm and the alarm information will be displayed on the LCD.
3	Low Oil Pressure	When the controller detects that there is Low Oil Pressure input and the shutdown is allowed, it will initiate a shutdown alarm and the alarm information will be displayed on the LCD.
4	Over Speed	When the controller detects that the generator speed has exceeded the pre-set value, it will initiate a shutdown alarm and the alarm information will be displayed on the LCD.
5	Under Speed	When the controller detects that the generator speed has fallen below the pre-set value, it will initiate a shutdown alarm and the alarm information will be displayed on the LCD.
6	Loss of Speed Signal	When the controller detects the speed is 0 and the Loss of Speed Signal delay is NOT set as 0, it will initiate a shutdown alarm and the alarm information will be displayed on the LCD.
7	Gen Over Volt.	When the controller detects that the generator voltage has exceeded the pre-set value, it will initiate a shutdown alarm and the alarm information will be displayed on the LCD.
8	Gen Under Volt.	When the controller detects that the generator voltage has fallen below the pre-set value, it will initiate a shutdown alarm and the alarm information will be displayed on the LCD.
9	Fail To Start	If the engine does not fire after the pre-set number of attempts, it will initiate a shutdown alarm and the alarm information will be displayed on the LCD.
10	Gen Over Freq.	When the controller detects that the generator frequency has exceeded the pre-set value, it will initiate a shutdown alarm and the alarm information will be displayed on the LCD.
11	Gen Under Freq.	When the controller detects that the generator frequency has fallen below the pre-set value, it will initiate a shutdown alarm and the alarm information will be displayed on the LCD.

# Protection

## 5.2 SHUTDOWN ALARM continued

When controller detects shutdown alarm, it will send signal to open breaker and shuts down generator. Besides, the alarm information will be displayed on the LCD.

Shutdown alarms as following:

No.	Type	Description
12	No gens freq	When the controller detects the generator frequency is 0, it will initiate a shutdown alarm and the alarm information will be displayed on the LCD.
13	Low Fuel Level	When the controller detects that the fuel level is lower than the set value or there is Low Fuel Level input, it will initiate a shutdown alarm and the alarm information will be displayed on the LCD.
14	Low Coolant Level	When the controller detects that there is Low Coolant Level input, it will initiate a shutdown alarm and the alarm information will be displayed on the LCD.

# Wiring Connections

HSC940 controller's rear as following:

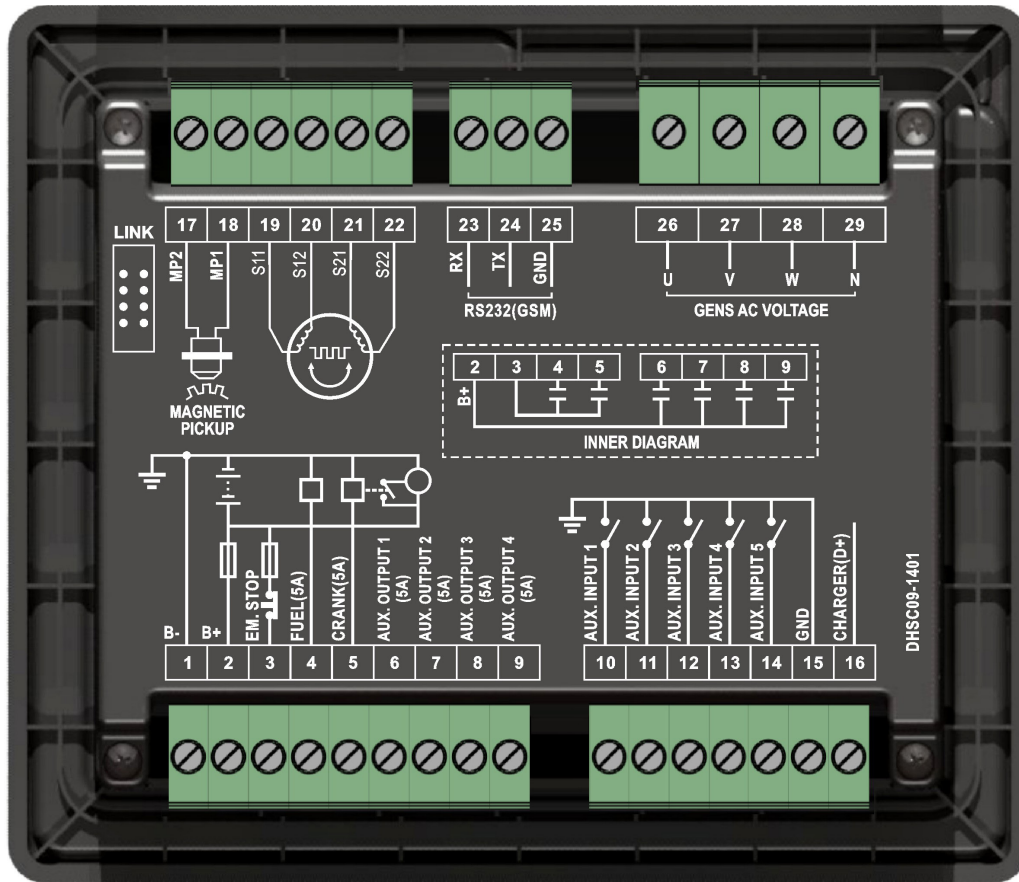

Description of terminal connection:

No.	Function	Cable Size	Remarks
1	B-	2.5mm <sup>2</sup>	Connected with negative of starter battery
2	B+	2.5mm <sup>2</sup>	Connected with positive of starter battery. Max. 20A fuse is recommended.
3	EM. Stop	1.5mm <sup>2</sup>	Connected with B+ via emergency stop button
4	Fuel	1.0mm <sup>2</sup>	Fuel relay output; B+ is supplied by 3 terminal; rated 5A
5	Crank	1.0mm <sup>2</sup>	Start relay output; B+ is supplied by 3 terminal; rated 5A; Connected to starter coil.
6	Aux. Output 1	1.0mm <sup>2</sup>	B+ is supplied by 2 terminal; rated 5A
7	Aux. Output 2	1.0mm <sup>2</sup>	B+ is supplied by 2 terminal; rated 5A;
8	Aux. Output 3	1.0mm <sup>2</sup>	B+ is supplied by 2 terminal; rated 5A;
9	Aux. Output 4	1.0mm <sup>2</sup>	B+ is supplied by 2 terminal; rated 5A;

# Wiring Connections

Continued:

No.	Function	Cable Size	Remarks
10	Aux. Input 1	1.0mm <sup>2</sup>	Ground connected is active (B-)
11	Aux. Input 2	1.0mm <sup>2</sup>	Ground connected is active (B-)
12	Aux. Input 3	1.0mm <sup>2</sup>	Ground connected is active (B-)
13	Aux. Input 4	1.0mm <sup>2</sup>	Ground connected is active (B-)
14	Aux. Input 5	1.0mm <sup>2</sup>	Ground connected is active (B-)
15	GND	The common port of sensor; (B-) has already connected.	
16	CHARGER(D+)	1.0mm <sup>2</sup>	Connected with charger starter's D+ (WL) terminals. Being hang up If there is no this terminal.
17	MP2	1.0mm <sup>2</sup>	(B-) has already connected. Connected with Speed sensor, shielding line is recommended.
18	MP1	1.0mm <sup>2</sup>	Connected with Speed sensor, shielding line is recommended.
19	S11	1.0mm <sup>2</sup>	Connect to stepper motor. S11 and S12 are belong to one phase to the motor while S21 and S22 are belong to the other phase.
20	S12	1.0mm <sup>2</sup>	
21	S21	1.0mm <sup>2</sup>	
22	S22	1.0mm <sup>2</sup>	
23	RS232 RX	0.5mm	Connected to GSM module.
24	RS232 TX	0.5mm	
25	RS232 GND	0.5mm	
26	Gens AC Voltage (U)	1.0mm <sup>2</sup>	Connected to U-phase of generator (2A fuse is recommended).
27	Gens AC Voltage (V)	1.0mm <sup>2</sup>	Connected to V-phase of generator (2A fuse is recommended).
28	Gens AC Voltage (W)	1.0mm <sup>2</sup>	Connected to W-phase of generator (2A fuse is recommended).
29	Gens AC Voltage (N)	1.0mm <sup>2</sup>	Connected to N-phase of generator (2A fuse is recommended).



**NOTE:** LINK interface is parameters configured interface that can be programmed by PC using an SG72 adapter. If there is need to remote control the genset, please use the SG485 module produced by our company.

# Scope & Definitions of Configurable Parameters

## 7.1 CONTENTS AND SCOPES OF PARAMETERS

Form 1

No	Items	Range	Default	Description
1	Start Delay	(0-3600)s	1	Time from remote start signal is active to start genset.
2	Stop Delay	(0-3600)s	1	Time from remote start signal is deactivated to genset stop.
3	Start Attempts	(1-10)times	3	Maximum crank times of crank attempts. When reach this number, controller will send start failure signal.
4	Preheat Delay	(0-300)s	0	Power-on time of heater plug before starter is powered up.
5	Choke Time	(0-300)s	0	Power-on time of choke after crank succeeds.
6	Cranking Time	(3-60)s	8	Power-on time of starter
7	Crank Rest Time	(3-60)s	10	The waiting time before second power up when engine start fail.
8	Safety On Delay	(1-60)s	10	Alarms for low oil pressure, high temperature, under speed, under frequency/voltage, charge alt failure are inactive.
9	Start Idle Time	(0-3600)s	0	Idle running time of genset when starting.
10	Warming Up Time	(0-3600)s	10	Warming time between genset switch on and high speed running.
11	Cooling Time	(3-3600)s	10	Radiating time before genset stop, after it unloads.
12	Stop Idle	(0-3600)s	0	Idle running time when genset stop.
13	ETS Solenoid Hold	(0-120)s	20	Stop electromagnet's power on time when genset is stopping.
14	Fail to Stop Delay	(0-120)s	0	Time between ending of genset idle delay and stopped when "ETS time" is set as 0; Time between ending of ETS hold delay and stopped when "ETS time" is not 0.
15	Close Time	(0-10)s	5.0	Pulse width of generator switch on. When it is 0, means output constantly.

# Scope & Definitions of Configurable Parameters

## 7.1 CONTENTS AND SCOPES OF PARAMETERS continued

Form 1 continued

No	Items	Range	Default	Description
16	Flywheel Teeth	(1-300)	118	Tooth number of the engine, for judging of starter crank disconnect conditions and inspecting of engine speed. See the installation instructions.
17	Gen Abnormal Delay	(0-20.0)s	10.0	The alarm delay of generator over voltage and under voltage.
18	Gen Over Voltage (Shutdown)	(30-620)V	264	When generator voltage has exceed the set value and the "Gen abnormal delay" has expired, Gen Over Voltage shutdown alarm is active. When set the value as 620V, the controller does not detect over voltage signal.
19	Generator Under Voltage (Shutdown)	(30-620)V	88	When generator voltage has fallen below the set value and the "Gen abnormal delay" has expired, Gen Under Voltage shutdown alarm is active. When set the value as 30V, the controller does not detect under voltage signal.
20	Under Speed (Shutdown)	(0-6000) r/min	1000	When engine speed has fallen below the set value for 10s, Under Speed shutdown alarm is active. It will initiate a shutdown alarm signal.
21	Over Speed (Shutdown)	(0-6000) r/min	4200	When engine speed has exceed the set value for 2s, Over Speed shutdown alarm is active. It will initiate a shutdown alarm signal.
22	Under Frequency (Shutdown)	(0-75.0)Hz	45.0	When generator frequency has fallen below the set value but Not equal to 0 for 10s, Under Frequency shutdown alarm is active. It will initiate a shutdown alarm signal.
23	Over Frequency (Shutdown)	(0-75.0)Hz	68.0	When generator frequency has exceeded the set value for 2s, Over Frequency shutdown alarm is active. It will initiate a shutdown alarm signal.
24	Loss of Speed Signal	(0-20.0)s	5.0	If the set value is 0, only warning and not to shutdown the generator.

# Scope & Definitions of Configurable Parameters

## 7.1 CONTENTS AND SCOPES OF PARAMETERS continued

Form 1 continued

No	Items	Range	Default	Description
25	Charge Alt Failure (Warning)	(0-30)V	6.0	During generator is normal running, when alternator D+(WL) voltage has fallen below the set value and remains for 5s, It will initiate a shutdown alarm signal.
26	Battery Over Voltage (Warning)	(12-40)V	33.0	When battery voltage has exceeded the set value and remains for 20s, It will initiate a warning alarm signal. Only warning and not to shutdown the generator.
27	Battery Under Voltage (Warning)	(4-30)V	8.0	When battery voltage has fallen below the set value and remains for 20s, It will initiate a warning alarm signal. Only warning and not to shutdown the generator.
28	Auxiliary Output 1	(0-17)	15	Factory default: Choke Control
29	Auxiliary Output 2	(0-17)	2	Factory default: Energized To Stop
30	Auxiliary Output 3	(0-17)	3	Factory default: Idle Control
31	Auxiliary Output 4	(0-17)	5	Factory default: Close Generator
32	Auxiliary Input 1	(0-15)	1	Factory default: High Temperature Input
33	Auxiliary Input 1 Active	(0-1)	0	Factory default: Close to active
34	Auxiliary Input 1 Delay	(0-20.0)s	2.0	
35	Auxiliary Input 2	(0-15)	2	Factory default: Low Oil Pressure Input
36	Auxiliary Input 2 Active	(0-1)	0	Factory default: Close to active
37	Auxiliary Input 2 Delay	(0-20.0)s	2.0	
38	Auxiliary Input 3	(0-15)	10	Factory default: Remote Start
39	Auxiliary Input 3 Active	(0-1)	0	Factory default: Close to active
40	Auxiliary Input 3 Delay	(0-20.0)s	2.0	
41	Auxiliary Input 4	(0-15)	11	Factory default: Fuel Level Warn



# Scope & Definitions of Configurable Parameters

## 7.1 CONTENTS AND SCOPES OF PARAMETERS continued

Form 1 continued

No	Items	Range	Default	Description
42	Auxiliary Input 4 Active	(0-1)	0	Factory default: Close to active
43	Auxiliary Input 4 Delay	(0-20.0)s	2.0	
44	Auxiliary Input 5	(0-15)	3	Factory default: Warn Input
45	Auxiliary Input 5 Active	(0-1)	0	Factory default: Close to active
46	Auxiliary Input 5 Delay	(0-20.0)s	2.0	
47	Power On Mode	(0-2)	0	0: Stop Mode 1: Manual Mode 2: Auto Mode
48	Module Address	(1-254)	1	Communication address of controller.
49	Passwords	(0-9999)	1234	
50	Crank Disconnect	(0-2)	2	There are 2 conditions of disconnecting starter with engine: Generator Frequency and Speed Sensor. Each condition can be used alone and simultaneously to separating the start motor and genset as soon as possible. See Table 4.
51	Disconnect Engine Speed	(0-3000) r/min	360	When the engine speed has exceeded the set value, starter will be disconnected.
52	Disconnect Generator Freq	(10.0-30.0)Hz	14.0	When the generator frequency has exceeded the set value, starter will be disconnected.
53	High Temp. Inhibit	(0-1)	0	Factory default: High Temp. Shutdown. When high temperature occurs, shutdown alarm is active. Note 1
54	Low OP Inhibit	(0-1)	0	Factory default: when low oil pressure occurs, shutdown alarm is active. Note 2
55	Voltage Input	(0-3)	0	0: 3P4W; 1: 2P3W 2: 1P2W; 3: 3P3W Note 3
56	Rated Speed	(0-6000) r/min	1500	Offer standard to adjust rated speed.

# Scope & Definitions of Configurable Parameters

## 7.1 CONTENTS AND SCOPES OF PARAMETERS continued

Form 1 continued

No	Items	Range	Default	Description
57	Idle Speed	(0-6000) r/min	900	Offer standard to adjust idle speed.
58	Idle Slope	0-6000	10	The rising speed rate during the process of genset change idle running status into rated speed running status.
59	Idle Gain	1-1000	150	The gain is regulated during the genset is idle running.
60	Crank Angle	(0-90)°	45	The throttle opening before the genset is starting.
61	Crank Disc. Angle	(0-90)°	35	The initial opening of the throttle after the genset is started.
62	Proportional Gain	1-3000	1100	The regulated gain when the genset is running in rated speed.
63	Integral Gain	1-3000	20	
64	Differential Gain	1-3000	1	
65	Total Gain	1-1000	100	
66	Window	(1-1000) r/min	1	
67	Window Gain	1000-3000	1950	
68	Position Gain	0-1000	0	
69	Compensate Gain	0-100	0	
70	Scheduled Enable	(0-1)	0	Factory default: Disable
71	Scheduled Run Mode	(0-1)	0	Factory default: Off Load
72	Schedule Period	(0-2)	0	Factory default: 0 Monthly
73	Schedule Day	(1-31)	1	
74	Schedule Week	(0-6)	0	Factory default: 0 Daily
75	Schedule Hour	(0-23)	0	
76	Schedule Minute	(0-59)	0	
77	Schedule Duration	(0-9999)	0	
78	GSM Set	(0-1)	0	Factory default: Disable

# Scope & Definitions of Configurable Parameters

## 7.1 CONTENTS AND SCOPES OF PARAMETERS continued



**Note 1.** If “high temperature inhibit” is configured, or set auxiliary input as “inhibit high temperature stop” and this input is active, when temperature is higher than the preset value, or high temperature alarm input is active, controller will send warning signal only and not stop the unit.



**Note 2.** If “low oil pressure inhibit” is configured, or set auxiliary input as “inhibit low oil pressure stop” and this input is active, when oil pressure is lower than the preset value, or low oil pressure alarm input is active, controller will send warning signal only and not stop the unit.



**Note 3.** If “3P3W” is selected, maximum shutdown threshold of “Gens Over Voltage” can be set as 620V; when select others, maximum shutdown threshold can be set as 360V.

## 7.2 ENABLE DEFINITION OF PROGRAMMABLE OUTPUT PORTS

Form 2

No	Items	Description
0	Not Used	Output port is deactivated when “Not Used” is selected.
1	Common Alarm	Include all shutdown alarms and warning alarms. When there is warning alarm only, it is not self-lock; when a shutdown alarm occurs, it is self-lock until the alarm is reset.
2	Energized to Stop	Suitable for genset with electromagnet and will active after “stop idle delay”. It is deactivated when the “ETS Solenoid delay” expires.
3	Idle Control	Used for engine which has idles. Close before starting and open in warming up delay; Close during stop idle delay and open when stop is completed.
4	Preheat Control	Close before starting and open before power up;
5	Close Generator	When close time is 0, it’s continuous output.
6	Reserved	
7	Open ATS	When close time is 0, it’s disabled.
8	Raise Speed	Close when the generator enters into Warming Up delay (close time: warming up delay) while open when Aux. Raise Speed input is active.

# Scope & Definitions of Configurable Parameters

## 7.2 ENABLE DEFINITION OF PROGRAMMABLE OUTPUT PORTS continued

Form 2 continued

No	Items	Description
9	Drop Speed	Close when the generator enters into Stop Idle delay/ Energized to Stop delay (close time: Stop Idle delay) while open when Aux. Drop Speed input is active.
10	Generator Run	Action when genset is normal running while deactivated when engine speed is lower than the "crank disconnect speed".
11	Fuel Pump Control	Close when fuel level is lower than the "Fuel Pump On" value or when low fuel level warning input is active; Open when fuel level is higher than the "Fuel Pump Off" and low fuel level warning input is deactivated;
12	High Speed Control	Close when the generator enters into Warming Up delay while open after cooling delay.
13	In Auto Mode	The controller is in automatic mode.
14	Fuel Relay Output	To control fuel relay output.
15	Choke Control	Start to output in cranking period; in addition, during safety on running, output for preset delay.
16	Reserved	
17	Reserved	

# Scope & Definitions of Configurable Parameters

## 7.2 DEFINED CONTENTS OF CONFIGURABLE INPUT PORTS (ALL ACTIVE WHEN CONNECT TO GRAND (B-))

Form 3

No	Items	Description
0	Not Used	
1	High Temperature Input	If these signals are active after safety on delay, shutdown alarm will be immediately initiated.
2	Low Oil Pressure Input	
3	Warn Input	Only warning and not shutdown if this input is active.
4	Shutdown input	Shutdown alarm will be immediately initiated if this input is active.
5	WTH STOP by cool	When the genset is running normally and this signal is activated, if there is a high temperature situation, the controller will first cool down the generator and then stop it; if the signal is deactivated and a high temperature situation occurs, the controller will shut down the gen-set without cooling down.
6	Generator Closed input	
7	Reserved	
8	Inhibit High Temperature Stop	When it is active, high temperature shutdown will be prohibited. Note 1
9	Inhibit Low Oil Pressure Stop	When it is active, low oil pressure shutdown will be prohibited. Note 2
10	Remote Start	
11	Fuel Level Warn	
12	Coolant Level Warn	
13	Fuel Level Shutdown	
14	Coolant Level Shutdown	
15	Inhibit Start Auto	In Auto mode, if this input is active, whether remote start signal activates or not, the controller will not give a start command to the generator. If generator is normal running, stop command won't be executed. When this input is deactivated, genset will automatically start or stop.

# Protection

## 7.4 CONDITIONS OF CRANK DISCONNECT SELECTION

Form 4

No.	Setting Description
0	Gen frequency
1	Speed sensor
2	Speed sensor + Gen frequency



### NOTES:

1. There are 2 conditions to make starter disconnected with engine, that is, speed sensor and generator frequency. They all can be used separately. We recommend that speed sensor should be using with generator frequency together, in order to make the starter motor is separated with engine immediately and can check crank disconnect exactly.
2. Speed sensor is the magnetic equipment which be installed in starter for detecting flywheel teeth.
3. When set as speed sensor, must ensure that the number of flywheel teeth is as same as setting, otherwise, "over speed shutdown" or "under speed shutdown" may be caused.
4. If genset without speed sensor, please don't select corresponding items, otherwise, "start fail" or "loss speed signal" maybe caused.
5. If not select generator frequency in crank disconnect setting, controller will not collect and display the relative power quantity (can be used in water pump set); if not select speed sensor in crank disconnect setting, the rotating speed displayed in controller is calculated by generator signal.

# Parameter Settings

Start the controller, then press



enter into the parameters setting menu, see fig 1 below:

Fig. 1



## Parameters Setting

When entering password interface, input correct password (default: 1234) can set all of the parameter items in Form 1. If there is need to set more parameters (e.g. Voltage Calibration), please contact the factory.

**CAUTION:** Please change the controller parameters when generator is in standby mode only (e. g. Crank disconnect conditions selection, auxiliary input, auxiliary output, various delay), otherwise, shutdown and other abnormal conditions may happen.

**CAUTION:** Over voltage set value must be higher than under voltage set value, otherwise over voltage and under voltage condition may occur simultaneously.

**CAUTION:** Over speed set value must be higher than under speed set value, otherwise over speed and under speed condition may occur simultaneously.

**CAUTION:** Please set the generator frequency value as low as possible when cranking, in order to make the starter be separated quickly as soon as possible.

**CAUTION:** Auxiliary input 1~5 could not be set as same items; otherwise, there are abnormal functions. However, the auxiliary output 1~4 can be set as same items.

**CAUTION:** If need to shut down after cooling, please set any digital input as "WTH STOP by cool", then connect this input port to ground soundly.

## Information

LCD will display software version, issue date of the controller.

**Note:** In this interface, pressing  will display the auxiliary inputs and outputs status.

## Language

Chinese, English, Spanish and Russian interface can be selected.

## Time and Date

The time and date information can be set in this interface.

Pressing the  key at any time will quit the setting and return to the previous settings menu.

# Commissioning

Please make the under procedures checking before commissioning,

1. Ensure all the connections are correct and wires diameter is suitable.
2. Ensure that the controller DC power has fuse, controller's positive and negative connected to start battery are correct.
3. Take proper action to prevent engine to crank disconnect (e. g. Remove the connection wire of fuel valve). If checking is OK, make the start battery power on; choose manual mode and controller will executive routine.
4. Set controller under manual mode, press "start" button, genset will start. After the setting times as setting, controller will send signal of Start Fail; then press "stop" to reset controller.
5. Recover the action of stop engine start (e. g. Connect wire of fuel valve), press start button again, genset will start. If everything goes well, genset will normal run after idle running (if idle run be set). During this time, please watch for engine's running situations and AC generator's voltage and frequency. If abnormal, stop genset running and check all wires connection according to this manual.
6. Select the AUTO mode from controller's panel, connect remote start signal. genset will be started automatically and into normal running, then controller send signal to close generator.
7. Cut-off remote start signal, the genset will be stopped automatically and the Open Generator signal will be send out. If not like this, please check ATS' wires connection of control part according to this manual.
8. If there is any other question, please contact Smartgen's service.



# Typical Application

Typical Application Diagram

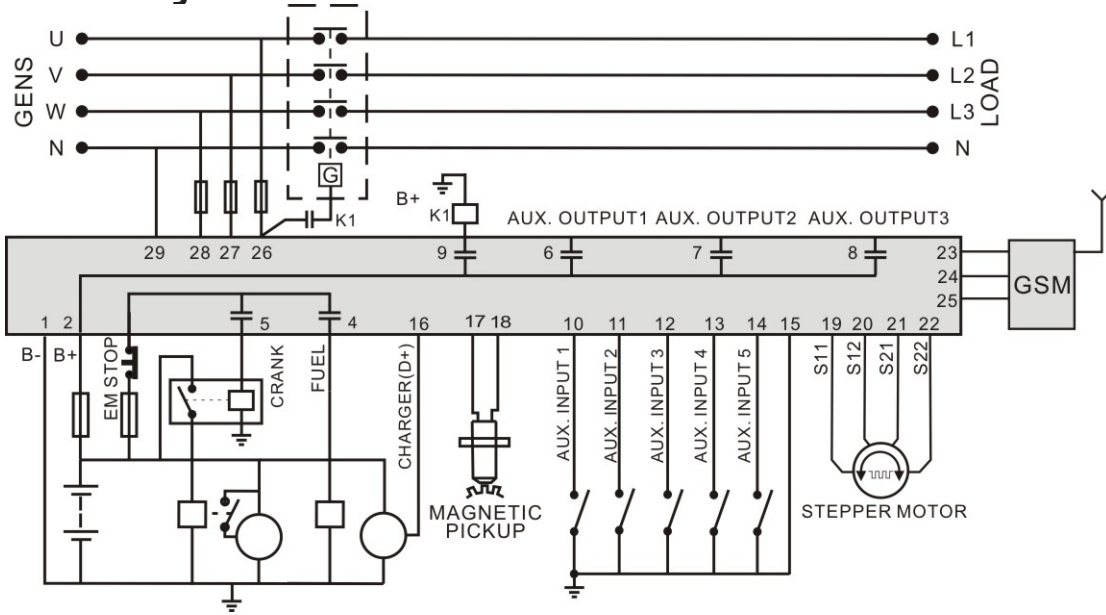

CAUTION! Expand relay with high capacity in start and fuel output is recommend.



CAUTION! Expand relay must be used in generator closed outputs.

## Connection Between Controller and Genset

HSC940

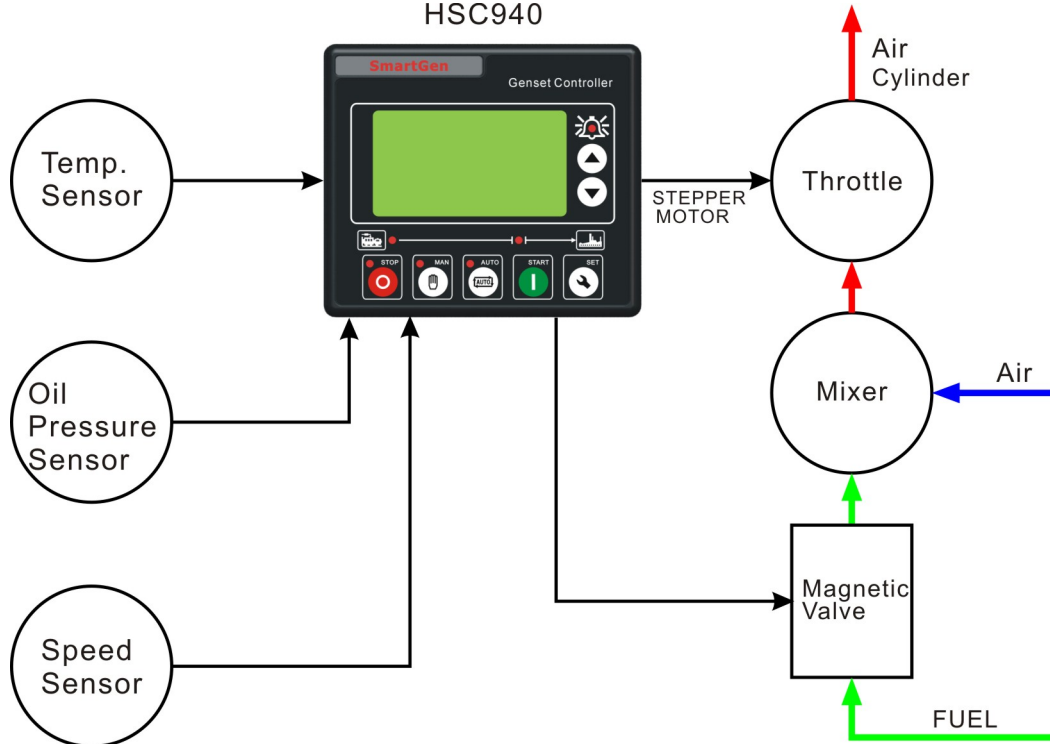

# Installation

## 12.1 FIXING CLIPS

Controller is panel built-in design; it is fixed by clips when installed.

1. Withdraw the fixing clip screw (turn anticlockwise) until it reaches proper position.
2. Pull the fixing clip backwards (towards the back of the module) ensuring two clips are inside their allotted slots.
3. Turn the fixing clip screws clockwise until they are fixed on the panel.

**Note:** Care should be taken not to over tighten the screws of fixing clips.

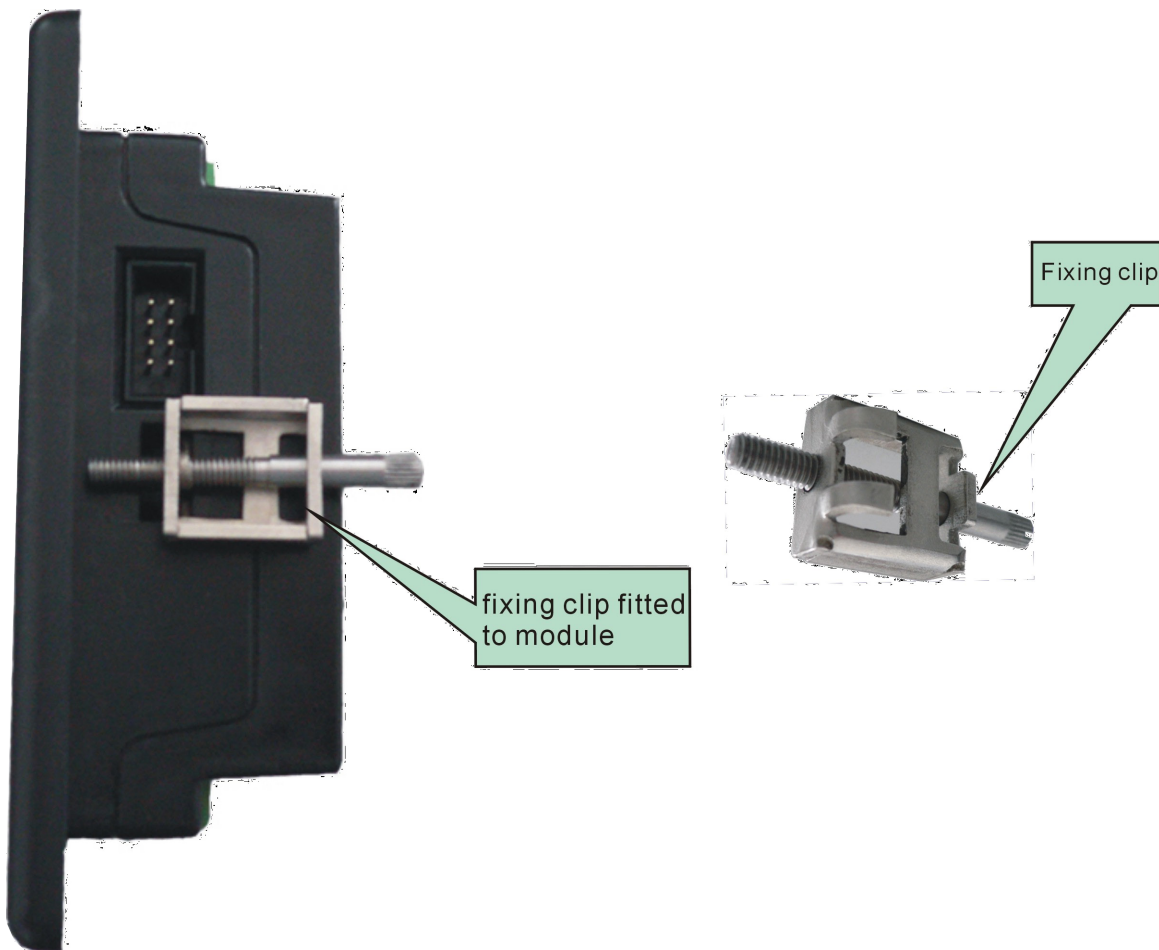

# Installation

## 12.2 OVERALL DIMENSION AND PANEL CUTOUT

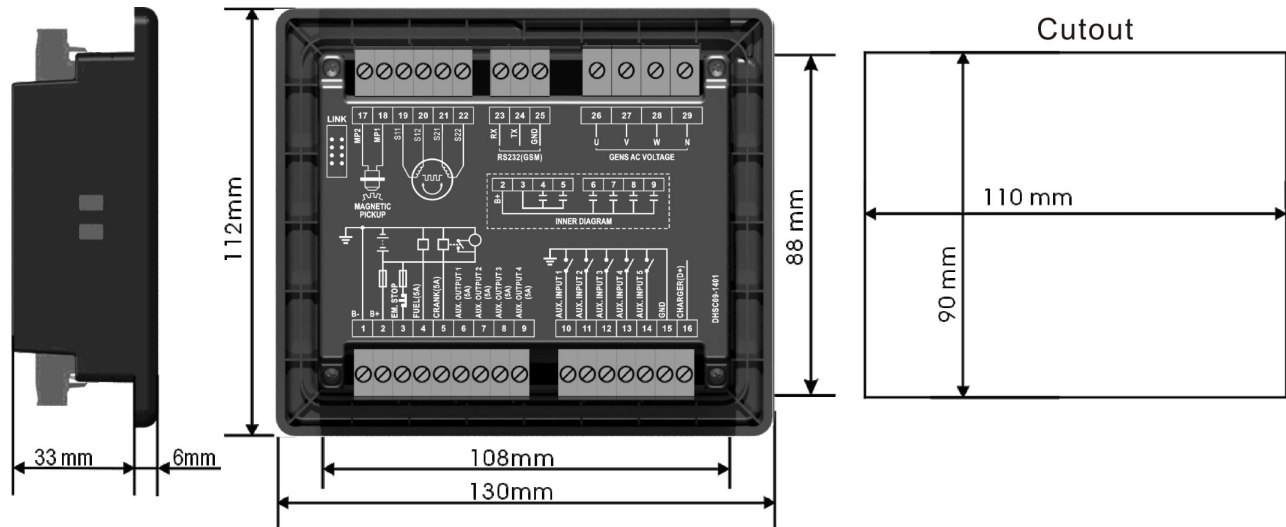

### 1. Battery Voltage Input

HSC940 controller can suit for widely range of battery voltage DC(8~35)V. Negative of battery must be connected with the engine shell. The diameter of wire which from power supply to battery must be over 2.5mm<sup>2</sup>. If floating charge configured, please firstly connect output wires of charger to battery's positive and negative directly, then, connect wires from battery's positive and negative to controller's positive and negative input ports in order to prevent charge disturbing the controller's normal working.

### 2. Speed Sensor Input

Speed sensor is the magnetic equipment which be installed in starter and for detecting flywheel teeth. Its connection wires to controller should apply for 2 cores shielding line. The shielding layer should connect to No. 17 terminal in controller while another side is hanging in air. The else two signal wires are connected to No.17 and No.18 terminals in controller. The output voltage of speed sensor should be within AC(1~24)V (effective value) during the full speed. AC12V is recommended (in rated speed). When install the speed sensor, let the sensor is spun to contacting flywheel first, then, port out 1/3 lap, and lock the nuts of sensor at last.

### 3. Output And Expansion Relay

All outputs of controller are relay contact output type. If need to expand the relays, please add freewheel diode to both ends of expand relay's coils (when coils of relay has DC current) or, add resistance-capacitance return circuit (when coils of relay has AC current), in order to prevent disturbance to controller or others equipment.

### 4. Withdraw Voltage Test

When controller had been installed in control panel, if need the high voltage test, please disconnect controller's all terminal connections, in order to prevent high voltage into controller and damage it.

# GSM Short Message Alarm & Remote Control

## 13.1 GSM SHORT MESSAGE ALARM

When controller detects alarm, it will send short message to phone automatically.

## 13.2 GSM SHORT MESSAGE REMOTE CONTROL

Users send order message to GSM module, then controller will make actions according to this SMS order and pass back corresponding operations information. Controllers only execute the orders by pre-set. Detail orders as following:

No.	SMS Orders	Pass Back Information	Description
1	SMS GENSET	GENSET ALARM	When genset is shutdown alarm
		SYSTEM IN STOP MODE GENSET AT REST	At rest status in stop mode
		SYSTEM IN MANUAL MODE GENSET AT REST	At rest status in manual mode
		SYSTEM IN AUTO MODE GENSET AT REST	At rest status in auto mode
		SYSTEM IN STOP MODE GENSET IS RUNNING	Running status in stop mode
		SYSTEM IN MANUAL MODE GENSET IS RUNNING	Running status in manual mode
		SYSTEM IN AUTO MODE GENSET AT RUNNING	Running status in auto mode
2	SMS START	GENSET ALARM	Generator is shutdown alarm or trip alarm
		STOP MODE NOT START	Cannot start in stop mode
		SMS START OK	Start in manual mode
		AUTO MODE NOT START	Cannot start in auto mode
3	SMS STOP MODE	SMS STOP OK	Set as stop mode

# GSM Short Message Alarm & Remote Control

## 13.2 GSM SHORT MESSAGE REMOTE CONTROL continued

Users send order message to GSM module, then controller will make actions according to this SMS order and pass back corresponding operations information. Controllers only execute the orders by pre-set. Detail orders as following:

No.	SMS Orders	Pass Back Information	Description
4	SMS MANUAL MODE	SMS MANUAL MODE OK	Set as manual mode
5	SMS AUTO MODE	SMS AUTO MODE OK	Set as auto mode
6	SMS DETAIL	Pass back information includes: Working Mode; Generator Voltage; Generator Frequency; Battery Voltage; Charger Voltage; Speed; Total Run Time; Genset Status; Alarm Status	Gets details information of genset.

**NOTE:** Its national and area codes must be added. e.g. China: 861366666666

**NOTE:** When sending orders, users need to follow SMS orders in above form and all the letters must be capital.

# Fault Finding

Symptoms	Possible Solutions
Controller no response with power.	Check starting batteries; Check controller connection wirings; Check DC fuse.
Genset shutdown	Check the water/cylinder temperature is too high or not; Check the genset AC voltage; Check DC fuse.
Low oil pressure alarm after crank disconnect	Check the oil pressure sensor and its connections.
High water temp. alarm after crank disconnect	Check the temperature sensor and its connections.
Shutdown Alarm in running	Check related switch and its connections according to the information on LCD; Check auxiliary input ports.
Fail to start	Check fuel oil circuit and its connections; Check starting batteries; Check speed sensor and its connections; Refer to engine manual.
Starter no response	Check starter connections; Check starting batteries.
Stepping Motor Reverse	Cross connect the S11 and S12; Cross connect the S21 and S22; Change configuration (motor reduce direction) via PC.
GOV is out of control.	Check the speed sensor voltage is no less than 2V when cranking. Check the connections of S11, S12, S21, S22.

# Smartgen — make your generator *smart*

Smartgen Technology Co., Ltd.  
No.28 Jinsuo Road  
Zhengzhou  
Henan Province  
P. R. China

**Tel:** 0086-371-67988888/67981888  
0086-371-67991553/67992951  
0086-371-67981000(overseas)

**Fax:** 0086-371-67992952

**Web:** <http://www.smartgen.com.cn>  
<http://www.smartgen.cn>

**Email:** [sales@smartgen.cn](mailto:sales@smartgen.cn)

All rights reserved. No part of this publication may be reproduced in any material form (including photocopying or storing in any medium by electronic means or other) without the written permission of the copyright holder.

Applications for the copyright holder's written permission to reproduce any part of this publication should be addressed to Smartgen Technology at the address above.

Any reference to trademarked product names used within this publication is owned by their respective companies.

Smartgen Technology reserves the right to change the contents of this document without prior notice.

## Software Version

Date	Version	Note
2014-06-10	1.0	Original release

Chinese Trademark



English Trademark

**Smartgen**<sup>®</sup>



Ingersoll Rand (NYSE:IR) advances the quality of life by creating comfortable, sustainable and efficient environments. Our people and our family of brands—including Club Car®, Ingersoll Rand®, Thermo King® and Trane®—work together to enhance the quality and comfort of air in homes and buildings; transport and protect food and perishables; and increase industrial productivity and efficiency. We are a \$13 billion global business committed to a world of sustainable progress and enduring results.



[ingersollrand.com](http://ingersollrand.com)