

# OWNER'S MANUAL

Service



## Dump Trailers



Craftsmanship

## Experience Excellence

Alliance, Ohio • 14599 Commerce Street, Alliance, Ohio 44601

Salem, Ohio • 1453 Allen Rd., Salem, Ohio 44460

**800-795-8454 • 330-823-9900**

 [www.MACtrailer.com](http://www.MACtrailer.com) 

<b>1.</b>	<b>Introduction And Warranty</b> .....	<b>3</b>
1.1	Introduction .....	3
1.2	Warranty .....	3
<b>2.</b>	<b>Safety</b> .....	<b>4</b>
2.1	Safety .....	4
2.2	Towing Hazards.....	4
2.2.1	Driving Too Fast .....	4
2.2.2	Trailer Not Properly Coupled to truck .....	5
2.2.3	Overloading .....	5
2.2.4	Improper Load Distribution .....	5
2.2.5	Shifting Cargo.....	6
2.2.6	Inappropriate Cargo .....	6
2.3	Tip Over Hazards .....	6
2.4	Brakes and Lights.....	6
2.5	Clearance .....	7
2.6	Hydraulics .....	7
2.7	Maintenance .....	7
2.8	Hazards From Modifying Your Trailer .....	7
2.9	Safety Warning Labels on Your Trailer .....	8
2.10	Reporting Safety Defects .....	10
<b>3.</b>	<b>Coupling Truck To Trailer</b> .....	<b>11</b>
3.1	Providing an Adequate Truck .....	11
3.2	Trailer Information .....	11
3.3	Before Attempting To Couple Truck To Trailer .....	12
3.4	Couple Truck to Trailer.....	12
3.5	Couple Pup To Lead Trailer (If Equipped) .....	15
3.6	Pretrip Inspection .....	17
<b>4.</b>	<b>Towing Trailer</b> .....	<b>19</b>
4.1	Lift Axle(s).....	19
4.2	Wheels and Tires .....	20
4.3	Alignment.....	20
<b>5.</b>	<b>Loading And Unloading The Trailer</b> .....	<b>21</b>
5.1	Load Trailer.....	21
5.2	Unload trailer .....	21
<b>6.</b>	<b>Uncouple Truck</b> .....	<b>28</b>
6.1	Uncouple Pup From Lead Trailer .....	28
6.2	Uncouple Truck from Trailer .....	29
<b>7.</b>	<b>Accessories And Options</b> .....	<b>31</b>
7.1	Ladder.....	31
7.2	Removable Mud Flaps .....	31
7.3	Floor Liner.....	32
<b>8.</b>	<b>Inspections And Lubrication</b> .....	<b>33</b>
8.1	Raise And Support Dump Body.....	33
8.2	Every Day .....	34
8.2.1	Inspect Trailer Body, Chassis And Fasteners.....	34
8.3	Every Week .....	35
8.3.1	Lubrication .....	35
8.3.2	Check Hydraulic Cylinder Bleeder Screw .....	38
8.3.3	Trailer Suspension .....	38
8.3.4	Drain Trailer Air Tanks .....	38
8.3.5	Inspect, Measure And Adjust Brakes .....	38
8.4	Every Six Months .....	39
8.4.1	Air In-Line Filter .....	39
8.4.2	Glad Hand Seals and Screens .....	40
<b>9.</b>	<b>Maintenance And Service</b> .....	<b>41</b>
9.1	Hydraulic System .....	41
9.2	Tires .....	41
9.3	Wheels .....	42
9.3.1	Spoke Wheels .....	42
9.3.2	Disk Wheels.....	43
9.3.3	Wheel Ends .....	43

# **1. INTRODUCTION AND WARRANTY**

---

## **1.1 INTRODUCTION**

Read and understand this manual before using your trailer and follow all of the safety instructions. Keep all manuals provided with your trailer in a safe place inside your truck at all times.

Some components on your MAC trailer have separate instruction manuals. Where this manual indicates that you should read another manual, and you do not have that manual, contact your dealer or MAC Trailer for assistance.

Information provided in this manual was current as of the issue date. MAC Trailer reserves the right to make design changes without further notice or liability.

## **1.2 WARRANTY**

For warranty information, see your warranty manual.

## 2. SAFETY

### 2.1 SAFETY

This Owner's Manual covers dump trailers produced by MAC Trailer. Before towing, operating or servicing a MAC dump trailer, you must read, understand and follow the instructions and safety warnings in this manual. Your trailer may not be equipped with some of the optional equipment shown in the illustrations in this manual.

The safety information in this manual is denoted by the safety alert symbol: ^

The level of risk is indicated by the following signal words.

#### **^ DANGER**

**DANGER** – Indicates a hazardous situation, which, if not avoided, will result in death or serious injury.

#### **^ WARNING**

**WARNING** – Indicates a hazardous situation, which, if not avoided, could result in death or serious injury.

#### **^ CAUTION**

**CAUTION** – Indicates a hazardous situation, which, if not avoided, could result in minor or moderate injury.

#### **NOTICE**

**NOTICE** – Indicates a situation that could result in damage to the trailer or other property.

### 2.2 TOWING HAZARDS

Loss of control of the truck/trailer combination can result in death or serious injury. The most common causes for loss of control are:

- Driving too fast.
- Incorrect coupling.
- Overloading.
- Improper load distribution.
- Shifting cargo.

#### 2.2.1 DRIVING TOO FAST

If you drive too fast, the trailer is more likely to sway, thus increasing the possibility for loss of control.

#### **^ WARNING**

**Collision Hazard.**

**Driving too fast for conditions can result in loss of control and may result death or serious injury.**

**Adjust speed down when towing trailer.**

### 2.2.2 TRAILER NOT PROPERLY COUPLED TO TRUCK

A secure coupling is vital. Uncoupling can result in death or serious injury.

#### **^ WARNING**

**Collision Hazard.**

**An improperly coupled trailer can result in death or serious injury.**

**Before towing trailer, verify that:**

- **The coupler is properly secured and locked.**
- **Trailer landing gear is fully retracted.**
- **Lights and air hoses connected.**
- **Perform pre-trip inspection.**

### 2.2.3 OVERLOADING

An overloaded trailer can result in loss of control, which may result in death or serious injury. Overloading may also result in tire, wheel, axle or structural failure, and also increased stopping distances.

#### **^ WARNING**

**Collision Hazard.**

**An overloaded trailer can result in death or serious injury.**

**Do not load a trailer so that the Gross Vehicle Weight Rating (GVWR) or Gross Axle Weight Rating (GAWR) is exceeded.**

### 2.2.4 IMPROPER LOAD DISTRIBUTION

Improper load distribution can result to poor trailer stability and handling. Refer to "Loading the Trailer" for more information.

Uneven load distribution can cause tire, wheel, axle or structural failure, and can result in the trailer rolling over while dumping. Be sure your trailer is evenly loaded left-to-right and front-to-rear. Keep the center of gravity as low as possible.

#### **^ WARNING**

**Collision Hazard.**

**An improperly loaded trailer can result in failure or loss of control, leading to death or serious injury.**

**Evenly distribute the load through out the trailer.**

### 2.2.5 SHIFTING CARGO

Be certain doors are properly latched to prevent the door from opening while towing.

#### **^ WARNING**

**Collision Hazard.**

**If a door opens, your cargo can spill onto the road, which could result in death or serious injury to other drivers.**

**Verify doors are properly closed and latched.**

### 2.2.6 INAPPROPRIATE CARGO

Carry only the cargo that your trailer was designed for. A trailer must not be used to carry certain items, such as people, containers of hazardous substances or containers of flammable substances.

#### **^ WARNING**

**Never transport people in a trailer.**

**Do not transport flammable, explosive, poisonous or other dangerous materials in your trailer.**

## 2.3 TIP OVER HAZARDS

#### **^ WARNING**

**Tip Over Hazard.**

**The following conditions CAN cause the trailer to tip over while dumping load:**

- **Soft, uneven or obstructed dumping surface.**
- **Unbalanced load in the trailer.**
- **Overloaded trailer.**
- **Weak, broken or leaking trailer suspension parts.**
- **If equipped with an air suspension, not releasing air from the trailer suspension before dumping.**
- **Tires that are flat or low on air pressure.**
- **Moving the trailer with the dump body raised.**
- **High winds.**
- **Jerking the trailer or hydraulics to free a stuck load.**
- **Truck and trailer parked in a jackknife position.**
- **Trailer movement of any kind.**

## 2.4 BRAKES AND LIGHTS

Be sure that the brakes and all of the lights on your trailer are functioning properly before towing your trailer.

### **^ WARNING**

Collision Hazard.

Failure to connect the electrical connector and air hoses will result in inoperable trailer lights and brakes, and can lead to collision.

Before each tow, verify that all lights work.

## **2.5 CLEARANCE**

### **^ WARNING**

Collision Hazard.

Know the height, width and length of the trailer.

Always be aware of clearances.

## **2.6 HYDRAULICS**

### **^ WARNING**

Pressurized fluids can penetrate the skin.

Hydraulic hoses can fail from age, damage and exposure.

Do not search for hydraulic leaks without body and face protection. A tiny, almost invisible leak can penetrate the skin, thereby requiring immediate medical attention.

Use wood or cardboard to detect hydraulic leaks, never your hands.

## **2.7 MAINTENANCE**

### **^ WARNING**

Crushing Hazard.

Before performing trailer inspections, service or maintenance:

- Park trailer on firm, level surface.
- Set brakes, turn truck engine off and remove ignition key.
- Chock tires if brakes are to be released.
- Support trailer with properly rated and placed stands.

## **2.8 HAZARDS FROM MODIFYING YOUR TRAILER**

Before making any alteration to your trailer, contact your dealer or MAC Trailer and describe the alteration you are contemplating. Altering your trailer may void the manufacturers warranty. See "Warranty" in Section 1.

**2.9 SAFETY WARNING LABELS ON YOUR TRAILER**



*Figure 2-1 – Curb Side Rear Safety Labels*

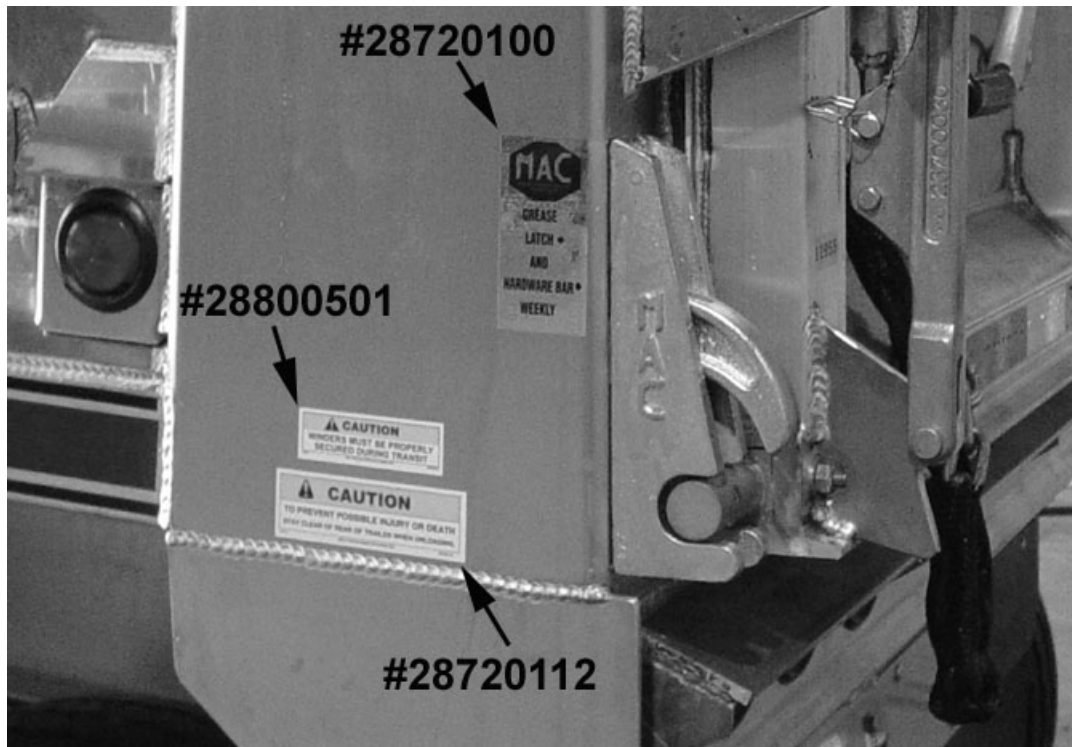

*Figure 2-2 – Street Side Rear Safety Labels*



# Safety



Figure 2-3 Front Safety Labels

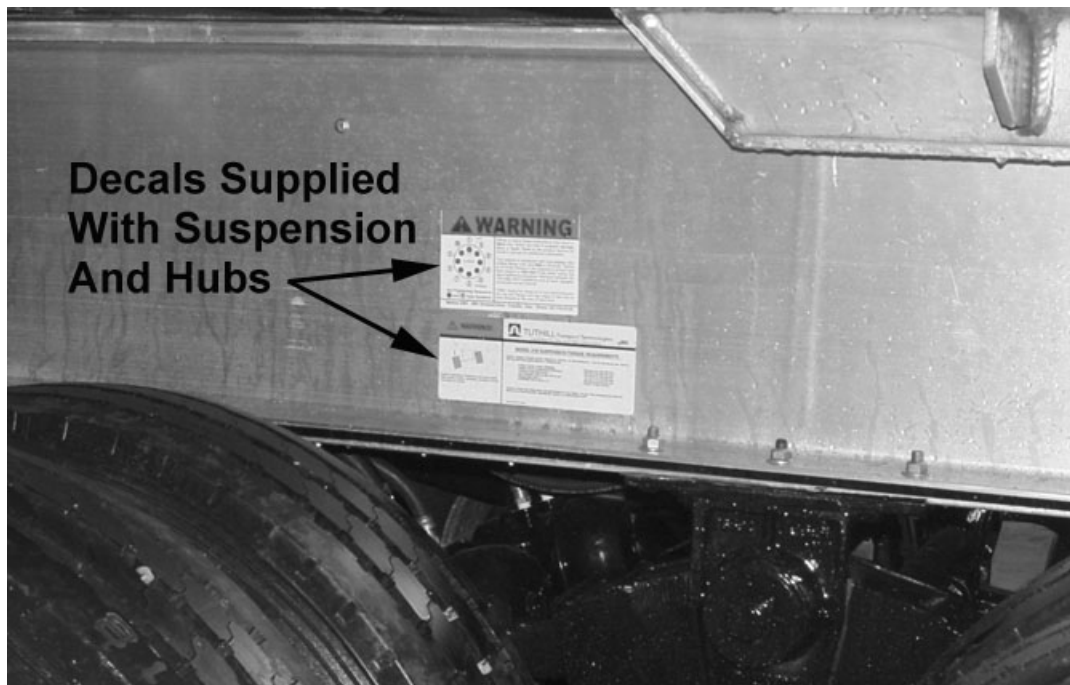

Figure 2-4 Suspension Safety Labels

## Safety

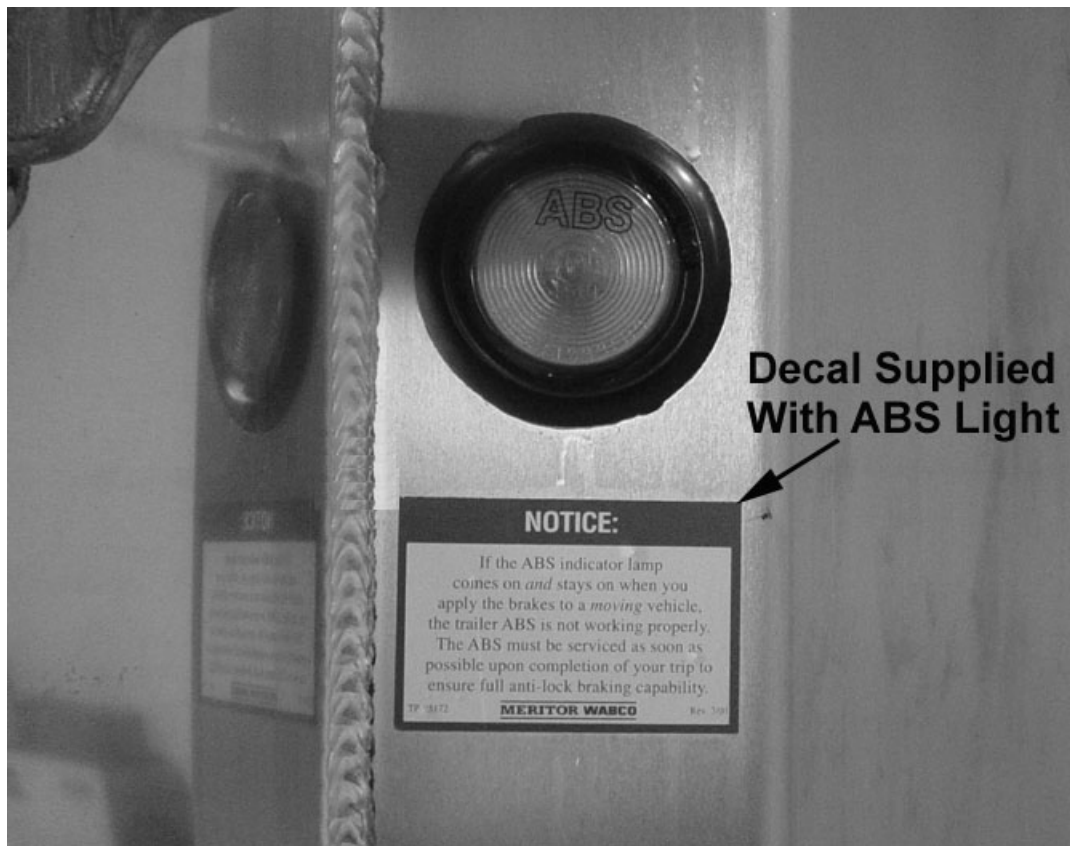

Figure 2-5 ABS Safety Label

Other decals required if equipped:

- Tire carrier decal (on top of carrier) #28800000
- Electric vibrator (bulkhead center) and glad hand #28800527
- HYVA hoist (1 extra decal on bulkhead center)
- Bag pressure gauge decal & high lift gate (located near suspension)
- Canada unit only (near the dolly street side) #28800532, #28800531, #28800530

### **^ WARNING**

**To protect against death or serious injury, all labels must be on the trailer and must be legible.**

**If any of these labels are missing or cannot be read, call MAC Trailer at 1-800-795-8454 for replacement labels.**

## 2.10 REPORTING SAFETY DEFECTS

If you believe that your vehicle has a defect that could cause a crash or could cause injury or death, you should immediately inform the National Highway Traffic Safety Administration (NHTSA) in addition to notifying us. If NHTSA receives similar complaints, it may open an investigation, and if it finds that a safety defect exists in a group of vehicles, it may order a recall and remedy campaign. However, NHTSA cannot become involved in individual problems between you, your dealer, or MAC Trailer.

To contact NHTSA, you may either call the Vehicle Safety Hotline toll-free at 1-888-327-4236 (TTY: 1-800-424-9153), go to <http://www.safercar.gov>; or write to: Administrator, NHTSA, 400 Seventh Street, SW., Washington, DC 20590. You can also obtain other information about motor vehicle safety from <http://www.safercar.gov>.

## 3. COUPLING TRUCK TO TRAILER

### 3.1 PROVIDING AN ADEQUATE TRUCK

The truck must be matched to the Gross Vehicle Weight Rating (GVWR) of your trailer. If you already have a truck, know your trucks tow rating and make certain the trailer's rated capacity is less than or equal to the tow vehicle's rated towing capacity.

#### **^ DANGER**

**Collision Hazard.**

**Use of an under-rated truck could result in loss of control, and can lead to death or serious injury.**

**Be sure your truck is rated for the Gross Vehicle Weight Rating (GVWR) of your trailer.**

### 3.2 TRAILER INFORMATION

The Certification / VIN tag is located on the left side of the trailer, near the landing gear. See figure 3-1.

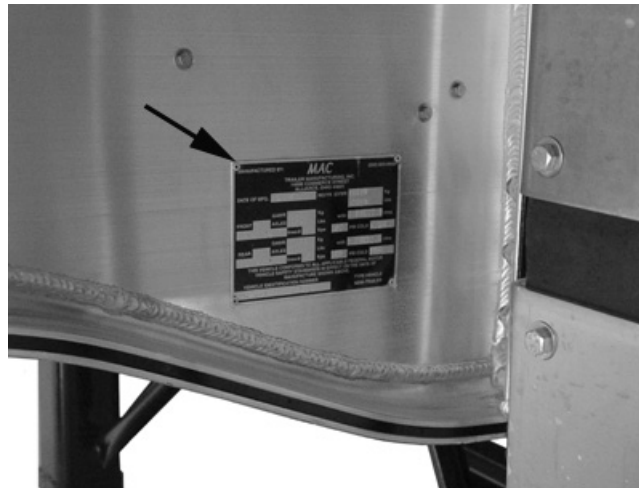

*Figure 3-1 - Certification / VIN Tag Location*

The trailer Certification / VIN tag contains the following information:

**MANUFACTURER:** MAC Trailer Manufacturing, Inc.

**DATE OF MANUFACTURE:** Month and year the trailer was manufactured.

**GVWR WITH \_\_\_\_\_ RIMS:** The Gross Vehicle Weight Rating is the maximum allowable gross weight of the trailer and its contents with the listed wheel rims.

**FRONT GAWR:** The Gross Axle(s) Weight Rating is the maximum gross weight that the front axle(s) can support.

**REAR GAWR:** The Gross Axle(s) Weight Rating is the maximum gross weight that the rear axle(s) can support.

**TIRE SIZE:** The tire size recommended for your trailer and load range.

**PSI:** The "pounds per square inch" is the tire pressure (Kilopascals / Pounds per Square Inch) measured when Cold.

## Coupling Trailer To Truck

---

**VIN:** The Vehicle Identification Number.

**VEHICLE TYPE:** Semi Trailer.

**CERTIFICATION STATEMENT:** “This trailer meets all the Federal Motor Vehicle Safety Standards in effect on the date of manufacture shown above”.

### 3.3 BEFORE ATTEMPTING TO COUPLE TRUCK TO TRAILER

1. Check the condition of the kingpin and mounting plate. Wipe the kingpin clean and inspect it for flat spots, cracks and pits.

#### **^ WARNING**

**Uncoupling Hazard.**

**A worn, bent or damaged kingpin can fail while towing, which can result in death or serious injury.**

**Inspect the kingpin and kingpin plate for wear and damage. Replace a worn or damaged kingpin or kingpin plate before towing trailer.**

2. Verify that the kingpin plate and fifth wheel fasteners are tight and welds are sound.

#### **^ WARNING**

**Uncoupling Hazard.**

**A loose kingpin or fifth wheel can result in the trailer uncoupling, which can result in death or serious injury.**

**Verify the kingpin and fifth wheel are tight.**

3. Lubricate the fifth wheel lock mechanism and verify it will move freely.

4. Clear all hoses and electrical cables from the coupling area.

5. Verify the fifth wheel locks are open.

#### **WARNING**

**Crushing Hazard.**

**Death or serious injury may occur if the trailer drops.**

**Keep bystanders away from trailer while coupling.**

### 3.4 COUPLE TRUCK TO TRAILER

1. Place wheel chocks behind the trailer tires.

2. Place the truck directly in front of the trailer. See figure 3-2. **NEVER** back under the trailer at an angle.

## Coupling Trailer To Truck

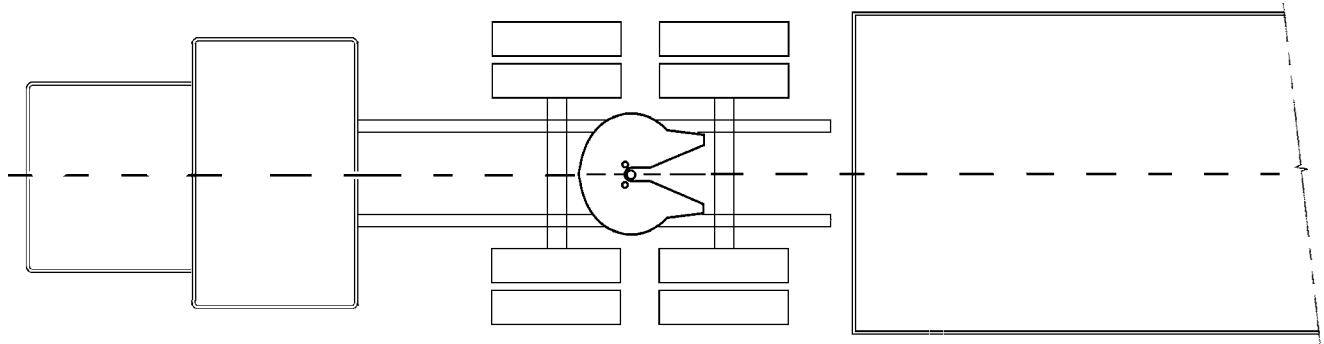

Figure 3-2 Align Truck With Trailer For Coupling

3. Back the truck until close to the trailer.
4. Apply the truck parking brakes and place transmission in neutral.
5. Release air from truck suspension (if equipped).
6. Inspect the height of the trailer vs the fifth wheel. The kingpin plate on the front of the trailer should first contact the fifth wheel 4-6 inches rearward of the fifth wheel centerline. See figure 3-3. The trailer should raise slightly when the truck is backed under it. If the trailer is too low, the truck may strike and damage the front of the trailer. If the trailer is too high, it will not couple correctly. Adjust the landing gear as needed to achieve the correct trailer height.

### **^ WARNING**

#### **Uncoupling Hazard.**

**Trailer must be at the correct height to couple to truck.**

**Verify trailer is at the proper height before coupling.**

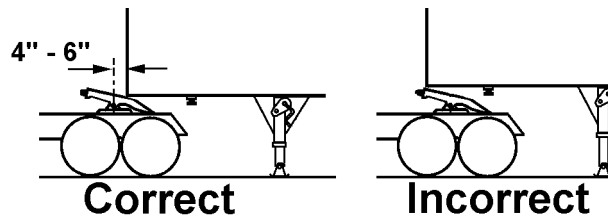

Figure 3-3 Coupling Truck To Trailer

7. Verify that the kingpin and fifth wheel are aligned.
8. Slowly back the truck keeping the kingpin aligned with the fifth wheel. Continue backing until the fifth wheel locks firmly on the kingpin. Attempt to pull forward as a test to verify the fifth wheel is locked. Do not attempt to move the truck and trailer at this time. Apply the truck parking brake and place transmission in neutral.
9. Inspect the coupling. See figure 3-4. Verify there is no space between the kingpin plate and the fifth wheel. **If there is space**, the kingpin may be on top of the fifth wheel jaws. Raise the trailer with the landing gear, pull the fifth wheel release lever and pull the truck ahead. Repeat steps 6-9 again to couple the trailer correctly.

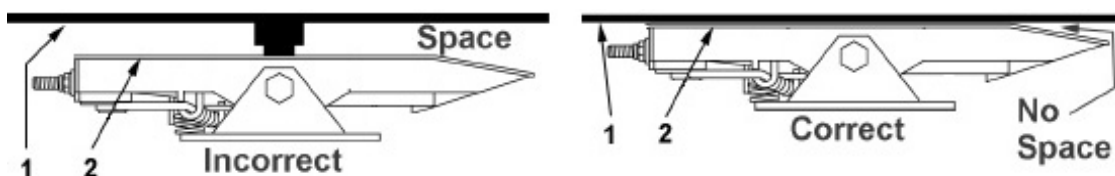

Figure 3-4 Fifth Wheel Checks

## Coupling Trailer To Truck

10. Go under the trailer with a flashlight and look in the back of the fifth wheel. Verify the fifth wheel jaws (A) have closed around the shank of the kingpin and the fifth wheel lock lever is in the locked position. See figure 3-5.

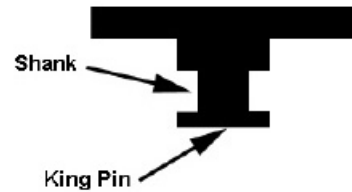
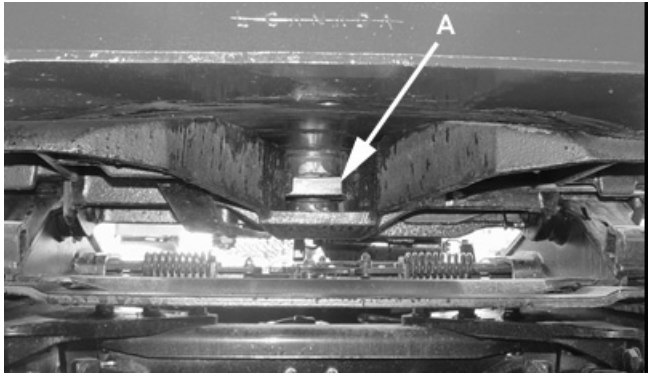

Figure 3-5 Fifth Wheel Jaws Closed Around Kingpin Shank

11. Inflate the truck suspension (if equipped).

12. Connect the supply hose (A), service hose (B), hydraulic hose, electrical connector, and if equipped, connect hoses to the lift axle and tailgate glad hands. See figure 3-6.

### **^ WARNING**

**Pressurized fluids can penetrate the skin.**

**Hydraulic hoses can fail from age, damage and exposure.**

**Do not search for hydraulic leaks without body and face protection. A tiny, almost invisible leak can penetrate the skin, thereby requiring immediate medical attention.**

**Use wood or cardboard to detect hydraulic leaks, never your hands.**

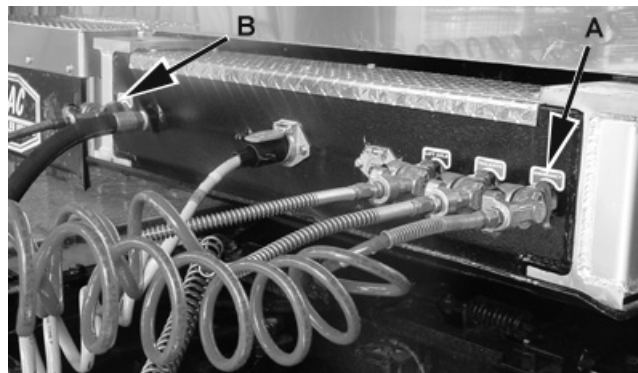

Figure 3-6 Connect Hoses And Electrical Connector

13. Raise the landing gear. Your trailer may be equipped with a two speed landing gear, or no-load support legs. MAC Trailer uses a two speed landing gear from several different manufacturers. High speed may be “in” on some models and “out” on others. Engage the crank handle (A) to the shaft and turn to retract the landing gear, or pull retaining pins and pins (B), fully retract the no-load legs (C) and insert pins and retaining pins. Return the two speed landing gear crank handle to the storage position. See figure 3-7.

## Coupling Trailer To Truck

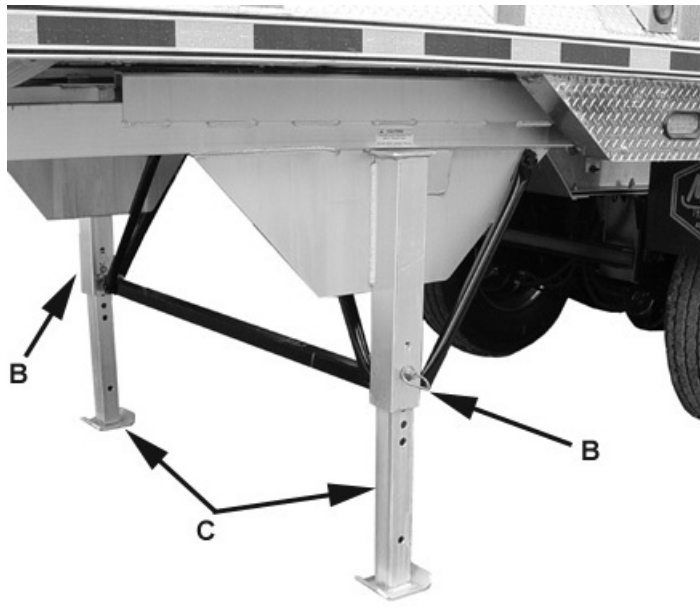

Figure 3-7 No-Load Support Legs



Two Speed Landing Gear

14. Press the trailer air supply valve in the truck to fill the trailer air tanks. Do not release parking brakes.
15. Perform pretrip inspection. See section 3.6.

### 3.5 COUPLE PUP TO LEAD TRAILER (IF EQUIPPED)

1. Place truck and lead trailer directly in front of, and aligned with pup trailer. See figure 3-8.

#### **^ WARNING**

**Crushing Hazard.**

**Truck could be inadvertently moved while you are behind trailer**

**Place truck transmission in neutral, set parking brakes, turn off engine and remove key before entering the area behind trailer.**

2. Place transmission in neutral, set parking brakes, turn off truck engine and remove key.

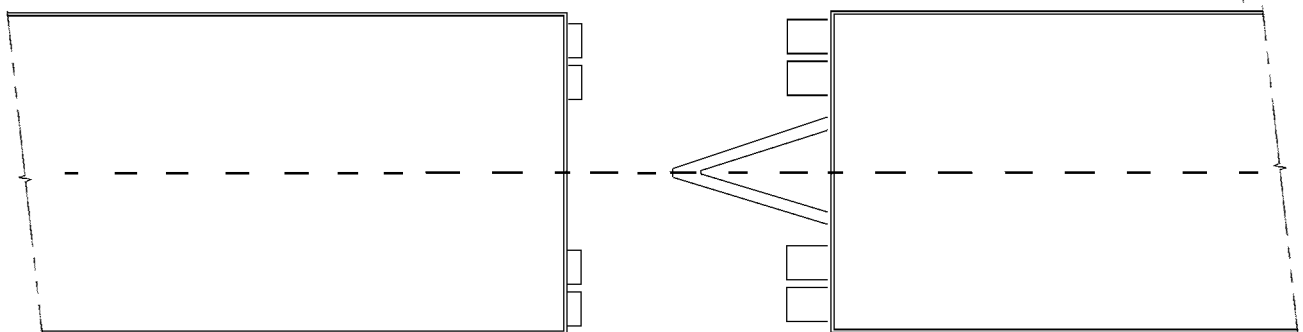

Figure 3-8 Align Truck And Lead Trailer With Pup

3. Remove pin from coupler on rear of lead trailer.
4. Position pup hitch at the same height as the lead trailer coupler.

## Coupling Trailer To Truck

---

5. Slowly back the truck and lead trailer until the hitch on the pup engages the coupler on the lead trailer. Place transmission in neutral, set parking brakes, turn off truck engine and remove key.

### **^ WARNING**

**Crushing Hazard.**

**Truck could be inadvertently moved while you are behind trailer**

**Place truck transmission in neutral, set parking brakes, turn off engine and remove key before entering the area behind trailer.**

6. Insert pin (A) down through coupler and pup hitch, and install safety lock pin (B) in pin (A). See figure 3-9.

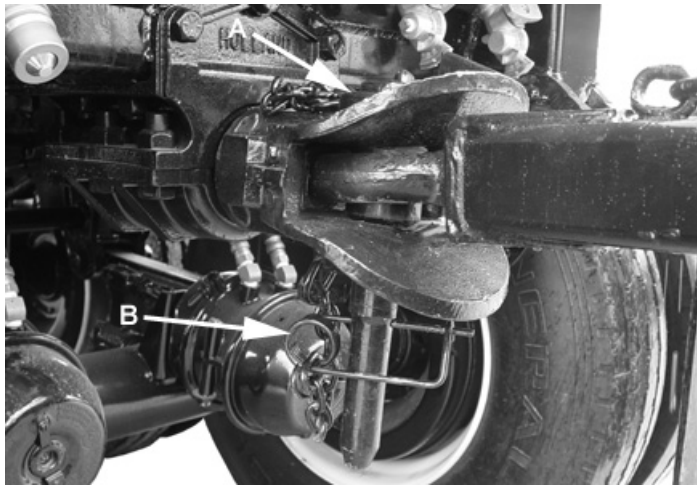

*Figure 3-9 Insert Pin And Safety Lock Pin*

*Note: For steps 7-9, refer to figure 3-10.*

7. Connect both safety chain hooks (A) to lead trailer.

8. Connect hydraulic hose (B), tailgate air hose and pup lock air hose.

### **^ WARNING**

**Pressurized fluids can penetrate the skin.**

**Hydraulic hoses can fail from age, damage and exposure.**

**Do not search for hydraulic leaks without body and face protection. A tiny, almost invisible leak can penetrate the skin, thereby requiring immediate medical attention.**

**Use wood or cardboard to detect hydraulic leaks, never your hands.**

9. Connect service glad hand, electrical connector and supply glad hand.



## Coupling Trailer To Truck

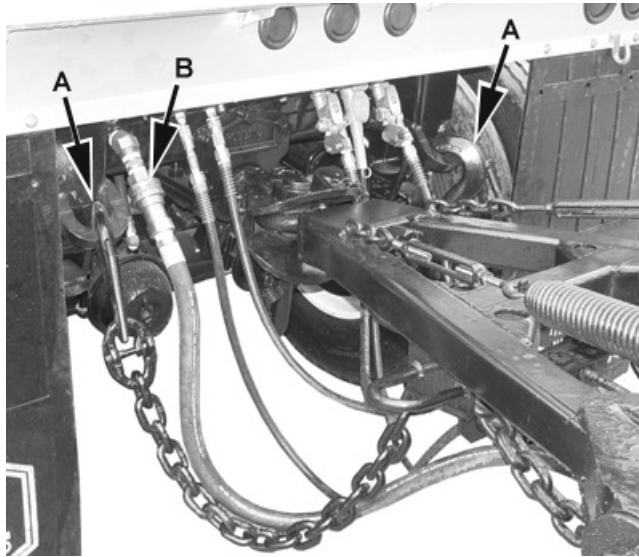

Figure 3-10 Connect To Lead Trailer

10. Open air supply valves (A) on lead trailer glad hands to supply air to the pup trailer. See figure 3-11.



Figure 3-11 Open Valves On Glad Hands

### 3.6 PRETRIP INSPECTION

Perform the inspections and checks before towing trailer:

- Check all lights for operation.
- Check that ABS light on street side rear corner of the trailer is not illuminated.
- Check that all safety decals are in place and in good, readable condition.
- Check that all reflectors are in place and in good condition.
- Check air pressure on all tires. Air pressure is listed on the Certification/VIN tag.
- Check and inspect all tires. If a tire has a bald spot, bulge, cut or cords showing, replace the tire(s) before towing trailer.
- Check wheel lug torque. See the Maintenance Section of this manual.
- Check the wheel hubs for signs of lubricant leakage.
- Check for broken or missing leaf springs or verify that air suspension springs are inflated.
- Check electrical harness and air hoses from truck for damage.
- Listen for air leaks in hoses and air suspension (if equipped).
- Check brakes for wear and adjustment, and verify the brakes function properly.
- Check the oil level in hydraulic oil reservoir. Add hydraulic oil if needed.

Repair or replace any worn, damaged, leaking, broken or non-functioning items before towing the trailer.

## **Coupling Trailer To Truck**

---

# 4. TOWING TRAILER

## 4.1 LIFT AXLE(S)

Your trailer can be equipped with one or more lift axles and may be equipped with a regulator valve. With trailer loaded, the axle(s) are lowered to help carry and distribute the load forces on the trailer. Turn the valve (A) to set the air pressure to the desired level. See figure 4-1.

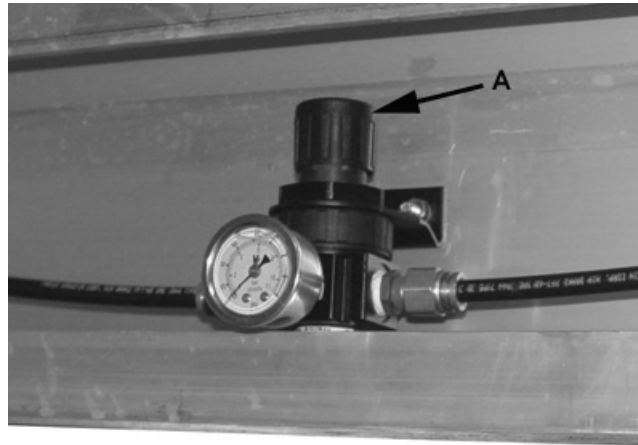

Figure 4-1 Lift Axle Regulator Valve

Use the correct chart below for the axle(s) on your trailer to set the air pressure.

AAL,AAT & AAZNT C-20901,C-23611, C-23612, C-23721, C-23748

<b>SUSPENSION LOAD SCALE INTRAAX 250</b>			
<b>GAUGE</b>		<b>LOAD PER AXLE</b>	
24 PSI	165 KPA	7000 LB	3175 KG
32 PSI	221 KPA	9000 LB	4082 KG
40 PSI	276 KPA	11000 LB	4990 KG
48 PSI	331 KPA	13000 LB	5897 KG
56 PSI	386 KPA	15000 LB	6804 KG
65 PSI	448 KPA	17000 LB	7711 KG
72 PSI	496 KPA	19000 LB	8618 KG
80 PSI	552 KPA	21000 LB	9526 KG
88 PSI	607 KPA	23000 LB	10433 KG
96 PSI	662 KPA	25000 LB	11340 KG

5-5 MAC TRAILER MANUFACTURING INC. 28800529

AAL,AATC-25871,C-23611, C-25872 & C-25873

<b>SUSPENSION LOAD SCALE INTRAAX 300</b>			
<b>GAUGE</b>		<b>LOAD PER AXLE</b>	
30 PSI	207 KPA	10000 LB	4536 KG
37 PSI	255 KPA	12000 LB	5443 KG
44 PSI	303 KPA	14000 LB	6350 KG
51 PSI	352 KPA	16000 LB	7258 KG
58 PSI	400 KPA	18000 LB	8165 KG
64 PSI	441 KPA	20000 LB	9072 KG
71 PSI	490 KPA	22000 LB	9979 KG
78 PSI	538 KPA	24000 LB	10886 KG
85 PSI	586 KPA	26000 LB	11794 KG
92 PSI	634 KPA	28000 LB	12701 KG
99 PSI	683 KPA	30000 LB	13608 KG

5-5 MAC TRAILER MANUFACTURING INC. 28800530

With the trailer empty, raise the axle(s) off the surface by relieving the air pressure on the lift axles.

## **^ WARNING**

**Collision Hazard.**

**An empty trailer with the lift axle(s) in the down position can be unstable while towing, which can result in loss of control.**

**Raise the lift axle(s) off the surface on an empty trailer before towing.**

## **4.2 WHEELS AND TIRES**

Uneven tread wear can be caused by tire imbalance, axle misalignment or improper inflation. If you observe uneven tread wear, take the trailer to an authorized truck/trailer service center for diagnosis. Trailer wheels and lugs are subjected to high side loads. This can cause the wheel lugs to become loose. Check to be certain wheel lugs are tightened to 450-500 lb ft of torque. Refer to the maintenance section for the proper tightening procedure. Failure to perform this check may result in a wheel parting from the trailer, and a crash leading to death or serious injury. You must use a torque wrench to obtain the proper tightening of the lug nuts.

## **4.3 ALIGNMENT**

Properly aligned trailer axles optimize fuel economy and driveability, and help prevent excessive tire wear. A perfect alignment scenario has all trailer wheels parallel to one another and perpendicular to the centerline of the trailer. However due to uncontrollable factors, this perfect scenario is often an unreasonable expectation. A more likely alignment scenario has the trailer wheels parallel within a very small tolerance range to one another and perpendicular within a very small tolerance range to the centerline of the trailer. There are two important trailer axle angles that must be kept within recommended tolerance ranges: thrust angle and scrub angle. These angles, when out of tolerance, can lead to increased rolling resistance, excessive tire wear and can contribute to trailer “dog tracking.” Dog tracking is a condition where the trailer does not follow or track directly behind the truck as the vehicle is being operated in a straight line and is influenced by body rail alignment, king pin location, axle side-to-side location, and other things. If realignment is necessary, take the trailer to your dealer or an authorized trailer service center.

## 5. LOADING AND UNLOADING THE TRAILER

Improper trailer loading causes many accidents and deaths. To safely load a trailer, you must consider the overall load weight and load distribution.

The load distribution must be such that no component part of the trailer is loaded beyond its rating. You must be sure that the load distribution does not exceed the rating of the tires, wheels and axles.

### **^ WARNING**

**Crushing Hazard.**

**An overloaded dump body could cause hydraulic and PTO components to fail, which could result in the dump body falling.**

**Do not overload dump body.**

**Do not load a trailer so that the Gross Vehicle Weight Rating (GVWR) or Gross Axle Weight Rating (GAWR) is exceeded.**

### 5.1 LOAD TRAILER

1. Verify the tailgate closed and properly latched.
2. Load the material into the trailer, distributing the material evenly throughout the trailer.

### **^ WARNING**

**Tip Over Hazard.**

**Improper material distribution in the trailer may result in trailer tip over when dump body is raised.**

**Distribute the material evenly throughout the trailer.**

3. Weigh the trailer to be sure you have not exceeded the weight capacity of the trailer, tires, axles and wheels.
4. All loaded trailers should be covered with a tarp.

### 5.2 UNLOAD TRAILER

**^**

**The operator must be qualified to operate a dump trailer, know and understand the controls and the conditions that can cause a tip over.**

## Loading And Unloading Trailer

---

### **^ WARNING**

Tip Over Hazard.

The following conditions could cause the trailer to tip over while dumping load:

- Soft, uneven or obstructed dumping surface.
- Unbalanced load in the trailer.
- Overloaded trailer.
- Weak, broken or leaking trailer suspension parts.
- If equipped with an air suspension, not releasing air from the trailer suspension before dumping.
- Tires that are flat or low on air pressure.
- Moving the trailer with the dump body raised.
- High winds.
- Jerking the trailer or hydraulics to free a stuck load.
- Truck and trailer parked in a jackknife position.
- Trailer movement of any kind.

### **^ WARNING**

A raised dump body can drop or tip over suddenly.

You must:

- Keep others away while dumping.
- Remain at the controls until dump body is fully lowered.
- Have the dump body fully lower before moving trailer.

If the hoist does not lift the load, manually reduce the load and obtain help from a qualified hydraulics technician.

Never assist the hoist with a crane, forklift, etc.

- If the loaded material does not leave the dump body, lower the dump body and manually free the load.
- Never attempt to free the load from a raised dump body.

### **^ WARNING**

Crushing Hazard.

An altered or component substituted hydraulic system can malfunction, resulting in the dump body falling without warning. Death or serious injury can result.

**NEVER** alter or substitute any hydraulic system component.

## Loading And Unloading Trailer

---

### **^ WARNING**

**Electrocution hazard.**

**Dump body coming near or contacting power lines can cause electrocution.**

**Electrocution can occur without contact.**

**Be sure there are no overhead power lines over or near the trailer before raising dump body.**

1. Park the truck and trailer in a straight line on a firm, level and unobstructed surface.
  - For frame trailers, apply the truck parking brakes.
  - For frameless trailers, apply the trailer parking brakes.
2. If the trailer is equipped with an air spring suspension, release the air from the trailer suspension. The trailer will then sit on the dump blocks that are inside the air springs.

### **^ WARNING**

**Tip Over Hazard.**

**Trailer can be unstable when dump body is raised with air in the air suspension system.**

**Relieve air from the air suspension system before raising dump body.**

3. Get out of the truck and inspect the area where the material is to be dumped. Verify that:
  - The surface where the truck and trailer will sit while dumping is free from obstructions, and is firm and level.
  - There are no electrical wires in the area.
  - The material in the trailer is evenly distributed side to side, and front to rear.
  - The truck and trailer are not sagging from a broken or damaged suspension.
  - The truck and trailer must be in a straight line with all wheels straight.
4. Remove or hang trailer mud flaps. See Accessories section 7.
5. Remove or open tarp if installed.
6. **For Pup And Lead Trailers Only:** Move the selector valve lever (A) inward to operate the lead trailer, or outward to operate the pup. See figure 5-1. The valve is located on the street side of the lead trailer, forward of the landing gear.

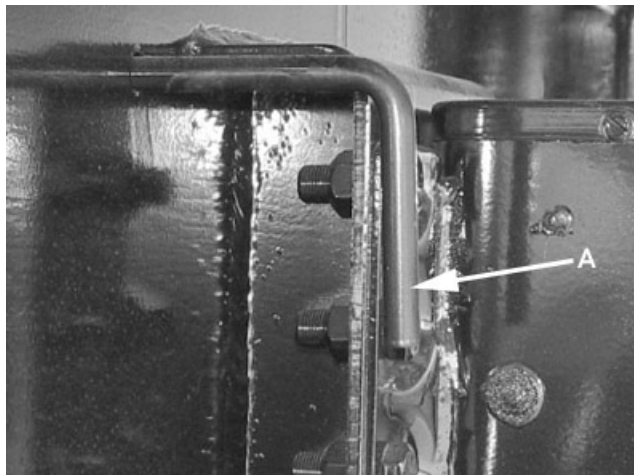

*Figure 5-1 Lead/Pup Selector Valve*

## Loading And Unloading Trailer

7. Release tension on winder (A) and place in the open position as shown. See figure 5-2.



Figure 5-2 Open Winder On Tailgate

**8. Unloading Using The Side Swing Tailgate Only:** Verify that both tailgate hinge pins on the swing side hinges are installed and properly engaged in the hinges.

### **^ WARNING**

**Crushing Hazard.**

**Side swing tail gate can fall, causing death or serious injury if the hinge pins are not engaged in the hinges.**

**Verify that pins are engaged in the side swing hinges as shown in figure 5-3.**



Figure 5-3 Side Swing Hinges Properly Engaged

9. Move tailgate valve (A) to "Open". See figure 5-4. Valve is located on the drivers side of the trailer.



## Loading And Unloading Trailer

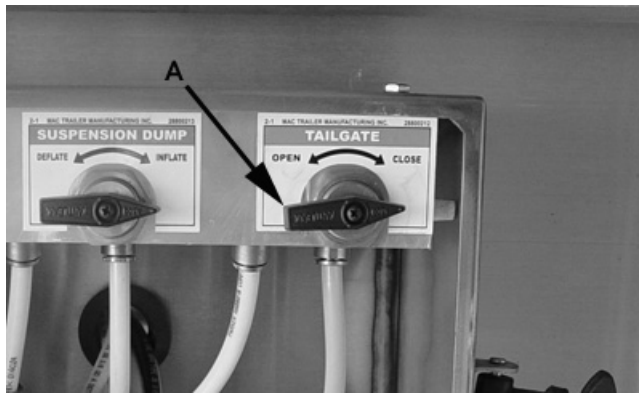

Figure 5-4 Move Tailgate Valve To Open

### **^ WARNING**

**Risk of death or serious injury from tailgate and/or falling materials.**

**Loaded materials can exert pressure against the tailgate, causing the tailgate to swing out with force when unlatched. Materials may fall from trailer when tailgate is unlatched.**

**Do not stand behind tailgate when unlatching.**

10. **Unloading Using The Side Swing Tailgate Only:** Remove safety lock pin and pull down on ground control handle (B) to unlatch tailgate. Shown in the unlatched position in figure 5-5.



Figure 5-5 Pull Down On Ground Control Handle

11. **Unloading Using The Side Swing Tailgate Only:** Swing tail gate fully open and insert chain (D) into anchor. Chain must be tight to prevent damage to the door. See figure 5-6.

## Loading And Unloading Trailer

---

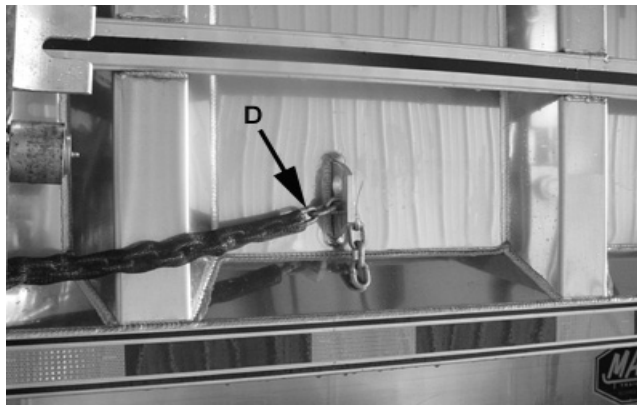

Figure 5-6 Anchor Door In Open Position

### 12. For Frameless Dump Trailers Only

#### **^ WARNING**

##### **Tip Over Hazard.**

**The truck parking brakes must be released and the trailer parking brakes applied when raising or lowering the dump body on a frameless dump trailer. Failure to do so will damage the trailer and can lead to a tip over.**

**Failure to provide a firm, level and uncluttered surface over which the truck wheels will travel can lead to a tip over.**

Release truck brakes and apply trailer brakes. The draft arms will pull the truck back as the dump body raises.

13. Engage power take off (PTO).

14. Move the hoist control to raise the dump body. Raise the dump only to the height needed to dump. Be prepared to lower the dump body immediately if the body moves off the center position.

15. When the material begins to exit the dump body, move the hoist control to the hold position until the material is dumped. Do not move the truck and trailer with the dump body raised.

16. Disengage the PTO and move the hoist control to the down position. Do not move truck and trailer until the dump body is fully lowered.

#### **^ WARNING**

##### **Collision Hazard.**

**Failure to disengage PTO may result in the dump body raising, and collision with overhead obstacles may occur.**

**Verify PTO is disengaged after dump body is lowered.**

17. With the dump body fully lowered, move the truck and trailer ahead to clear the dumped material.

18. Verify the trailer is empty. Remove any material from trailer. If necessary, raise the dump body again using steps 12-17.

19. Close the tailgate and engage latch.

20. Position winder on tailgate and tighten.

## **Loading And Unloading Trailer**

---

21. Unhook or install mud flaps.
22. Move tail gate control valve to "Close".
23. Remove any loose material on the trailer before leaving the dump site.

## 6. UNCOUPLE TRUCK

### 6.1 UNCOUPLE PUP FROM LEAD TRAILER

Follow these steps to uncouple your pup trailer from a lead trailer:

1. Park the truck and trailers on a firm level surface in a straight line.
2. Engage the pup lock to lock the dolly in the centered, straight position. Place transmission in neutral, set parking brakes, turn off truck engine and remove key.

#### **^ WARNING**

**Crushing Hazard.**

**Truck could be inadvertently moved while you are behind trailer**

**Place truck transmission in neutral, set parking brakes, turn off engine and remove key before entering the area behind trailer.**

3. Move the air supply valves on lead trailer glad hands to the off position as shown in figure 6-1.

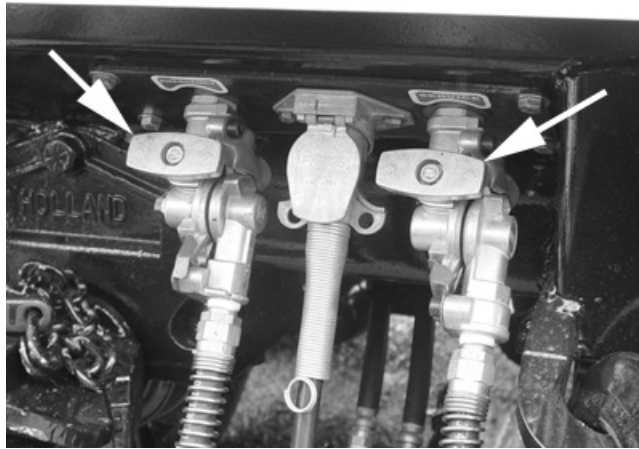

*Figure 6-1 Air Supply Valves On Lead Trailer*

4. Disconnect both safety chains (A), hydraulic hose (B), tailgate air hose, pup lock air hose, service glad hand, electrical connector and supply glad hand. See figure 6-2.

## Uncouple Truck

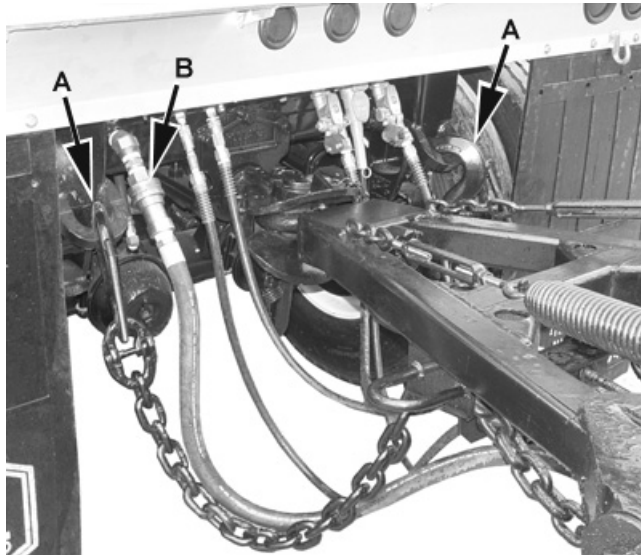

Figure 6-2 Disconnect Hoses And Electrical Connector

5. Remove safety lock pin (B) and pin (A). See figure 6-3.

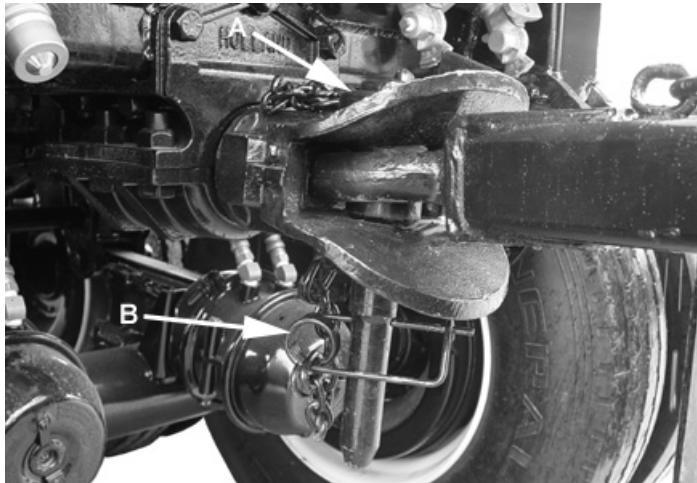

Figure 6-3 Remove Safety Lock Pin and Pin.

6. Check the area and drive truck forward until clear of trailer.

## 6.2 UNCOUPLE TRUCK FROM TRAILER

Follow these steps to uncouple your truck from the trailer:

1. Park the trailer on a firm level surface.
2. Set the parking brakes.
3. If trailer is loaded, place blocks or pads under landing gear legs to prevent setting.

### **NOTICE**

**Risk of Trailer Damage.**

**If trailer is equipped with No-Load Legs, the trailer must be empty before disconnecting truck.**

## Uncouple Truck

4. Your trailer may be equipped with a two speed landing gear, or no-load support legs. MAC Trailer uses a two speed landing gear from several different manufacturers. High speed may be "in" on some models and "out" on others. High speed is used only when landing gear is off the ground. Engage the crank handle (A) and lower the landing gear until it makes firm contact with the ground, blocks or pads. Switch to low gear and crank an additional 4-8 turns.

For no-load support legs, pull retaining pins and pins (B), fully extend the no-load legs (C) and insert pins and retaining pins. Return the two speed landing gear crank handle to the storage position. See figure 6-4.

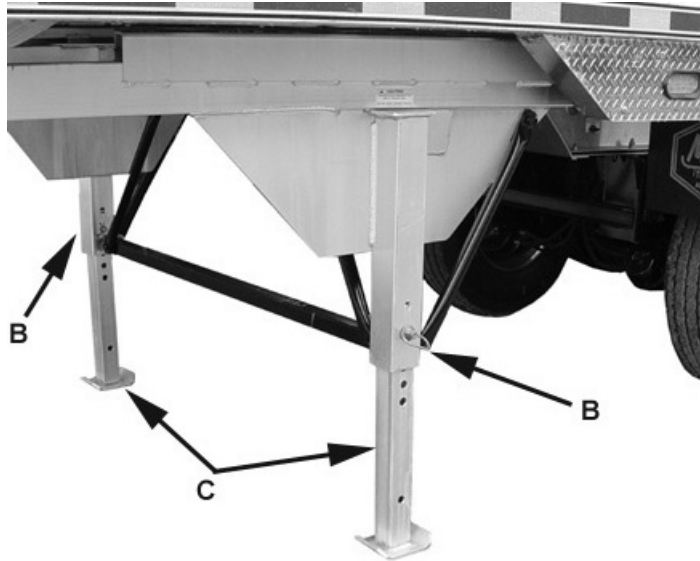

Figure 6-4 No-Load Support Legs



Two Speed Landing Gear

5. Disconnect the supply hose (A), service hose (B), hydraulic hose, electrical connector, and if equipped, disconnect hoses to the lift axle and tailgate glad hands. See figure 6-5.

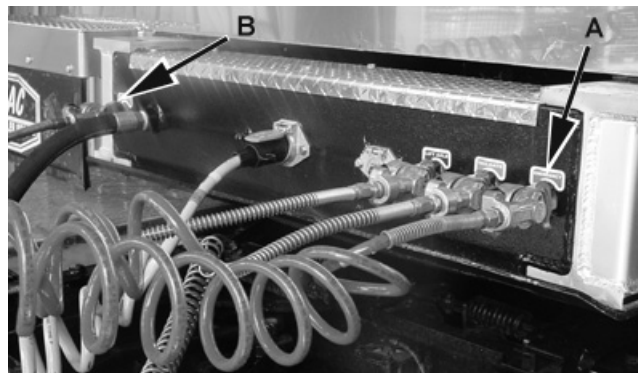

Figure 6-5 Disconnect Hoses And Electrical Connector

6. Pull the fifth wheel release lever.

7. Release air in truck suspension (if equipped) and pull truck forward until fifth wheel comes out from under the trailer.

8. Stop with truck frame under trailer. This will prevent the trailer from falling to the ground if the landing gear should collapse or sink.

9. Apply parking brake and place transmission in neutral.

10. Make sure ground is supporting trailer. Make sure landing gear is not damaged.

11 Check the area and drive truck forward until clear of trailer.

## 7. ACCESSORIES AND OPTIONS

### 7.1 LADDER

A sloped bulk head trailer can be equipped with a fold-away front ladder. To open the ladder, remove pins (A) and pull ladder outward. See figure 7-1.

Install pins (A) through tube and brackets on ladder. Return ladder to storage position before moving trailer.

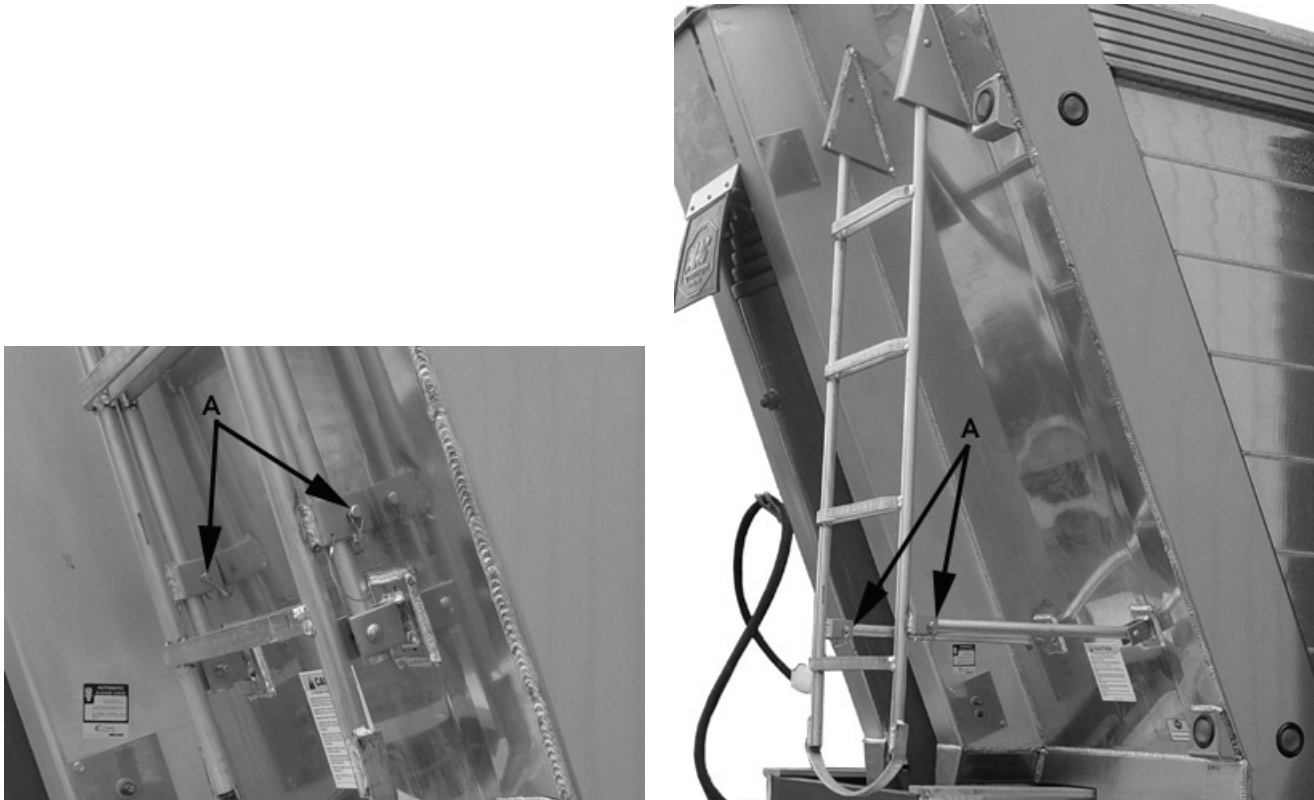

Figure 7-1 Fold-Away Ladder On Sloped Bulkhead Trailer

### 7.2 REMOVABLE MUD FLAPS

Your trailer can be equipped with removable mud flaps to reduce the risk of mud flap damage while dumping. Remove pin (A) and slide mud flap outward to remove. See figure 7-2. Install in track under trailer and install pin (A). Install mud flaps and pins on rear of trailer before traveling on the road.

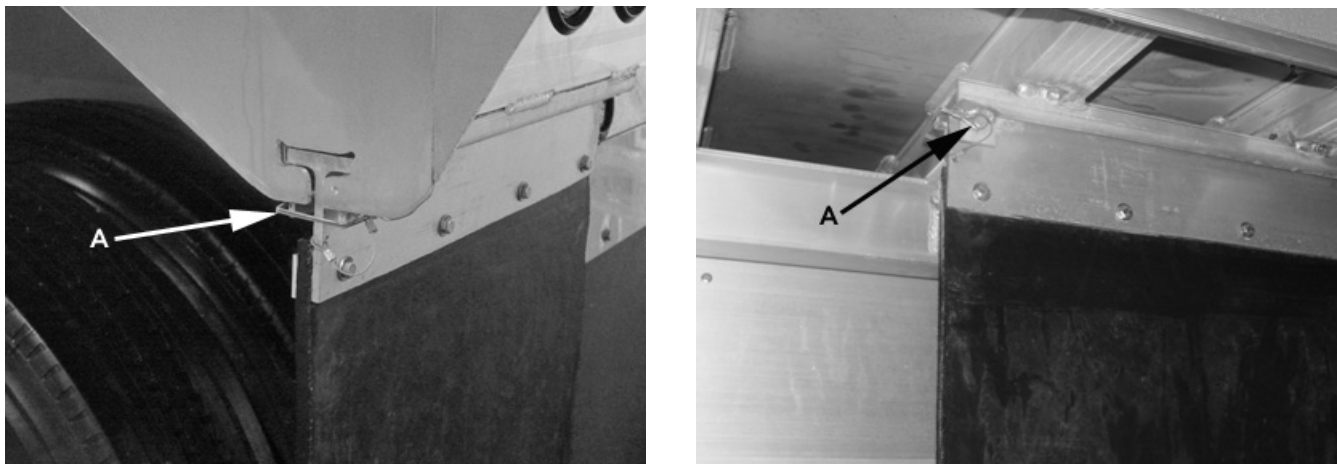

Figure 7-2 Removable Mud Flaps

### 7.3 FLOOR LINER

Your trailer can be equipped with a replaceable floor liner to reduce the wear on the trailer floor. See figure 7-3.



*Figure 7-3 Floor Liner*



## 8. INSPECTIONS AND LUBRICATION

---

Routine inspections, maintenance and service must be performed on your trailer on a regular basis to insure safe and reliable operation. Inspections can be performed by a person trained in spotting potential problems. Service and repairs must be performed by a trained, qualified technician.

*Note: In addition to this manual, also check the relevant component manufacturer's manual.*

### **^ WARNING**

**Crushing Hazard.**

**Before performing trailer inspections, service or maintenance:**

- **Park trailer on firm, level surface.**
- **Set parking brakes, turn truck engine off and remove ignition key.**
- **Chock tires if brakes are to be released.**
- **Support trailer with properly rated and placed stands.**

### 8.1 RAISE AND SUPPORT DUMP BODY

---

#### **^ WARNING**

**Risk of crushing.**

**A falling dump body can cause death or severe injury.**

**Block up the empty, raised dump body before performing any under-body inspection, maintenance or service.**

**NEVER block up a loaded or partially loaded dump body. Empty dump body before blocking up.**

**Use hardwood blocks only.**

To access the hydraulic cylinder on a frame style dump trailer, the dump body must be partially raised and supported with hardwood blocking. Perform the following steps to block up the dump body.

*Note: Lubricating the grease fittings on the hydraulic cylinder is done with the dump body down.*

1. Connect truck to trailer.
2. Empty the dump body. Never attempt to block up a loaded or partially loaded dump body.
3. Check for clearance overhead and raise dump body to desired height.
4. Place one hardwood block minimum 4" x 6" x 7' long between the frame and body rails as shown in figure 8-1.
5. Place two hardwood supports between the tires, up into the floor cross members. See figure 8-1.

## Inspections And Lubrication



Figure 8-1 Block Up Dump Body

6. Slowly lower the dump body onto the blocking.
7. Place the hydraulic hoist control in the hold position.
8. Stop truck engine and remove the key.

### 8.2 EVERY DAY

Perform the inspections and checks before towing trailer. This list is also covered in the pre-trip inspection:

*Note: The following inspections do not require the dump body to be raised.*

- Check all lights for proper operation.
- Check that ABS light on street side rear corner of the trailer is not illuminated.
- Check that all safety decals are in place and in good, readable condition.
- Check that all reflectors are in place and in good condition.
- Check air pressure on all tires. Air pressure is listed on the Certification/VIN tag.
- Check and inspect all tires. If a tire has a bald spot, bulge, cut or cords showing, replace the tire(s) before towing trailer.
- Check wheel lug torque. See Section 9-3.
- Check the wheel hubs for signs of lubricant leakage.
- Check for broken or missing leaf springs or verify that air suspension springs are inflated.
- Check electrical harness and air hoses from truck for damage.
- Listen for air leaks in hoses and air suspension (if equipped).
- Check brakes for wear and verify the brakes function properly.
- Check the oil level in hydraulic oil reservoir. Add hydraulic oil if needed.

Repair or replace any worn, damaged, leaking, broken or non-functioning items before towing the trailer.

#### 8.2.1 INSPECT TRAILER BODY, CHASSIS AND FASTENERS

1. Inspect the trailer body and chassis for damage daily.
2. Inspect all of the fasteners, welds and structural frame members for bending and other damage, cracks, or failure. Repair or replace any damaged fastener and repair the frame member. If you have any questions about the condition or method of repair of fasteners or frame members, get the recommendation of, or have the repair done by MAC Trailer or your dealer. Welds must be repaired by an qualified technician.

## Inspections And Lubrication

### **^ WARNING**

Broken or damaged fasteners or welds can cause injury or damage to trailer and contents.

Inspect for and repair all damaged parts.

## 8.3 EVERY WEEK

### 8.3.1 LUBRICATION

Lubricate the trailer grease fittings at least once per week.

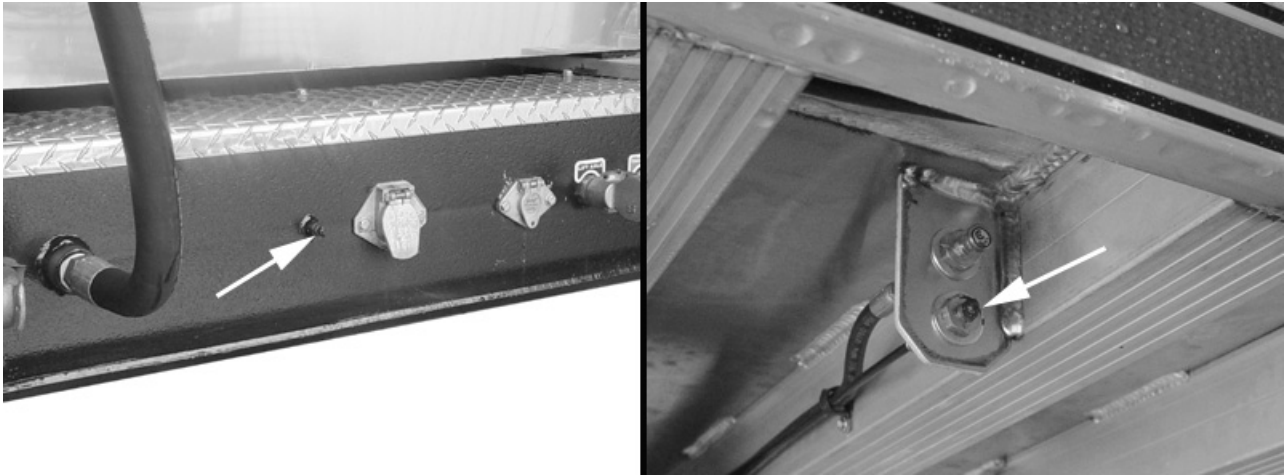

Figure 8-2 Frame Style Trailer Hydraulic Cylinder Grease Fittings

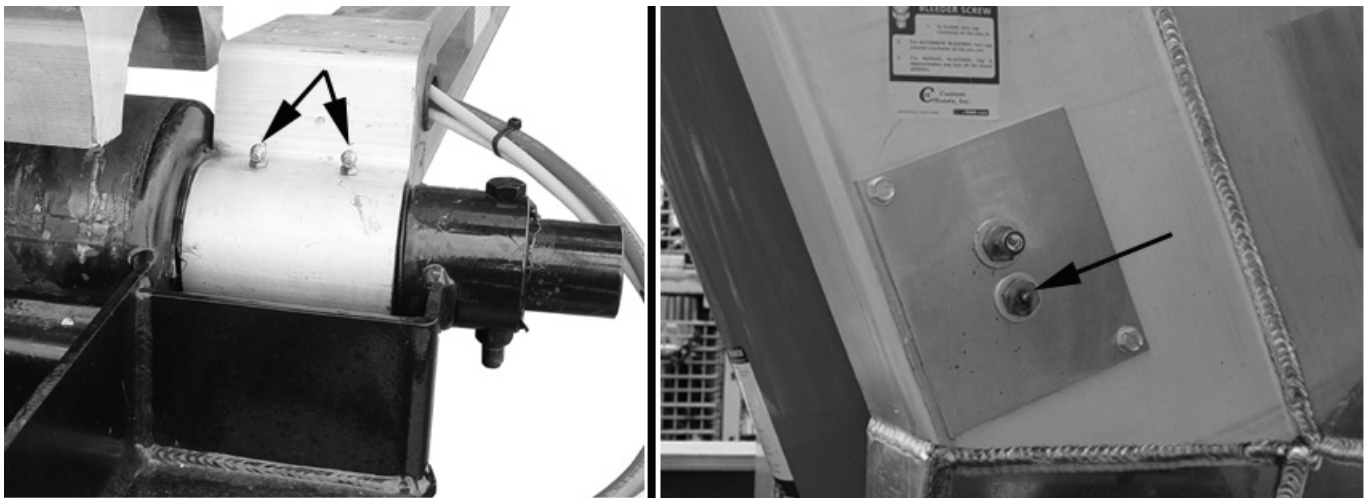

Figure 8-3 Frameless Style Trailer Draft Arms (All Ends) And Hydraulic Cylinder Grease Fittings

## Inspections And Lubrication



Figure 8-4 Side Swing Rear Gate Hinges And Roller Grease Fittings

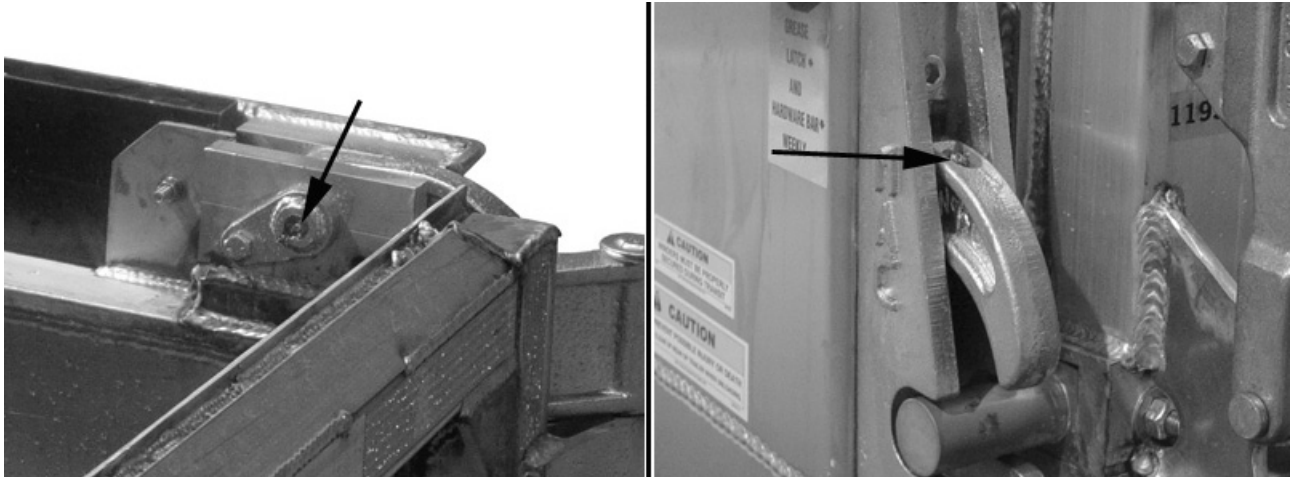

Figure 8-5 Overslung Rear Gate Pivot Pin And Latch Grease Fittings

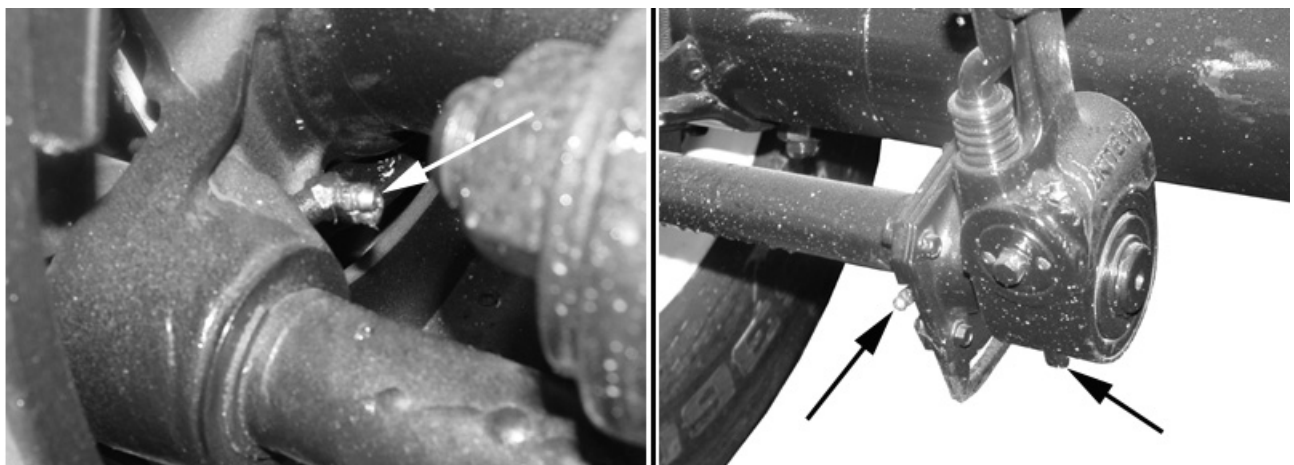

Figure 8-6 Slack Adjusters And Brake Arms Grease Fittings

## Inspections And Lubrication



Figure 8-7 Tailgate Latch Bar Bearing and Remote Grease Fittings

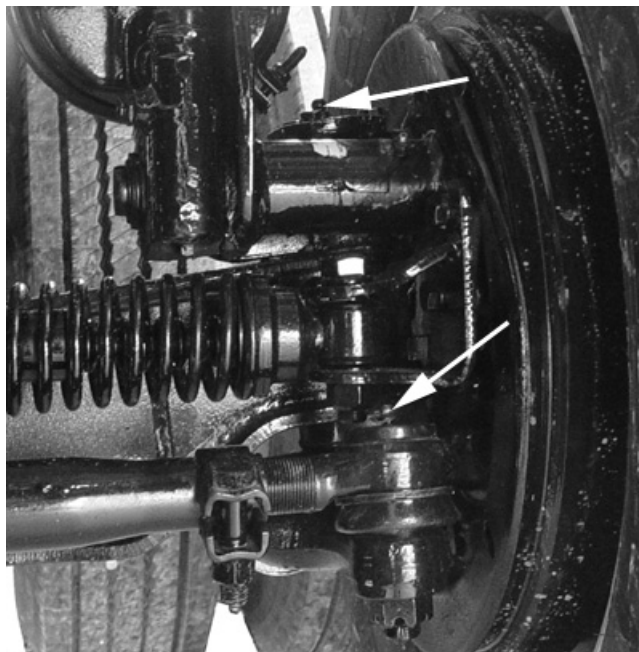

Figure 8-8 Steerable Axle Grease Fittings

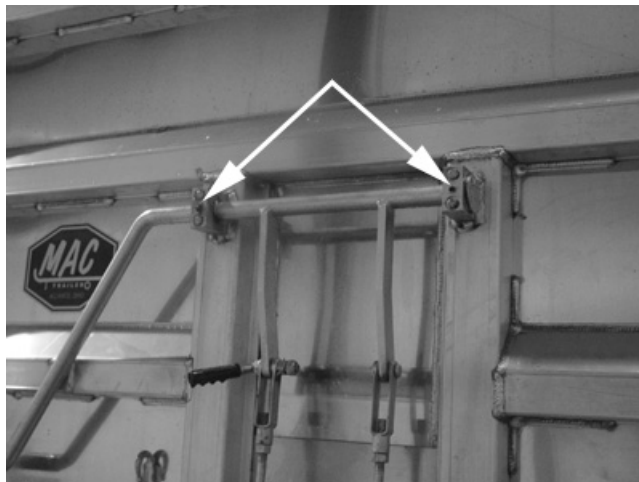

Figure 8-9 Lube Coal Chute Door Fittings

## Inspections And Lubrication

---

### 8.3.2 CHECK HYDRAULIC CYLINDER BLEEDER SCREW

For automatic bleeding, turn cap (A) counter-clockwise all the way out. This will bleed air from the hydraulic cylinder on each raise/lower cycle. See figure 8-10.

For manual bleeding, turn cap (A) approximately one turn off the closed position. Periodically turn the cap counter-clockwise to bleed air from the hydraulic cylinder. Return cap one turn off the closed position. See figure 8-10.

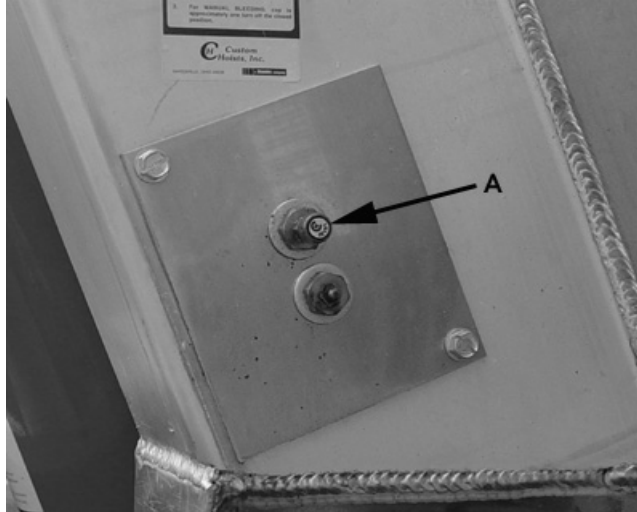

Figure 8-10 Hydraulic Cylinder Bleed Screw

### 8.3.3 TRAILER SUSPENSION

If equipped with air ride suspension, inspect the air springs for damage. If equipped with leaf spring suspension, inspect for broken springs and equal spring arch.

### 8.3.4 DRAIN TRAILER AIR TANKS

Drain moisture from trailer air tanks by opening petcock (A) on the bottom of each air tank. See figure 8-11. Close petcocks after draining.

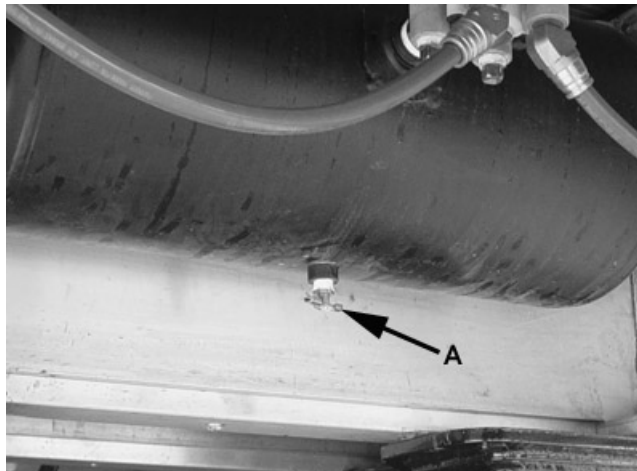

Figure 8-11 Drain Trailer Air Tanks

### 8.3.5 INSPECT, MEASURE AND ADJUST BRAKES

Inspect and measure the brake linings. Replace with a quality shoe and lining if contaminated, cracked or if the lining is worn to less than 1/4 inch thickness at any point. See figure 8-12.

## Inspections And Lubrication

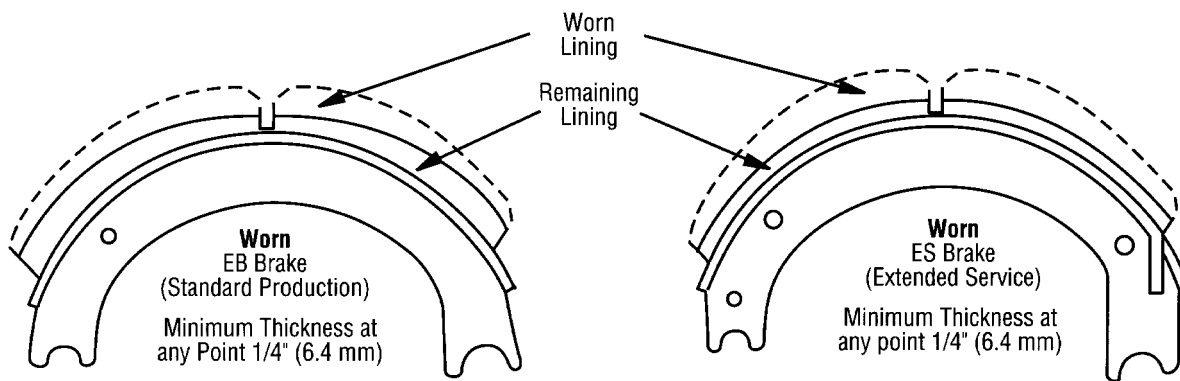

Figure 8-12 Measure Brake Lining

Chock tires and release brakes. Measure the distance (A) with brakes released. See figure 8-13. Use a lever to move slack adjuster until brakes contact the drum and measure the distance (B). Subtract distance A from distance B. The result is the free stroke. Adjust slack adjuster so the free stroke is 3/8 – 5/8 inch on each slack adjuster.

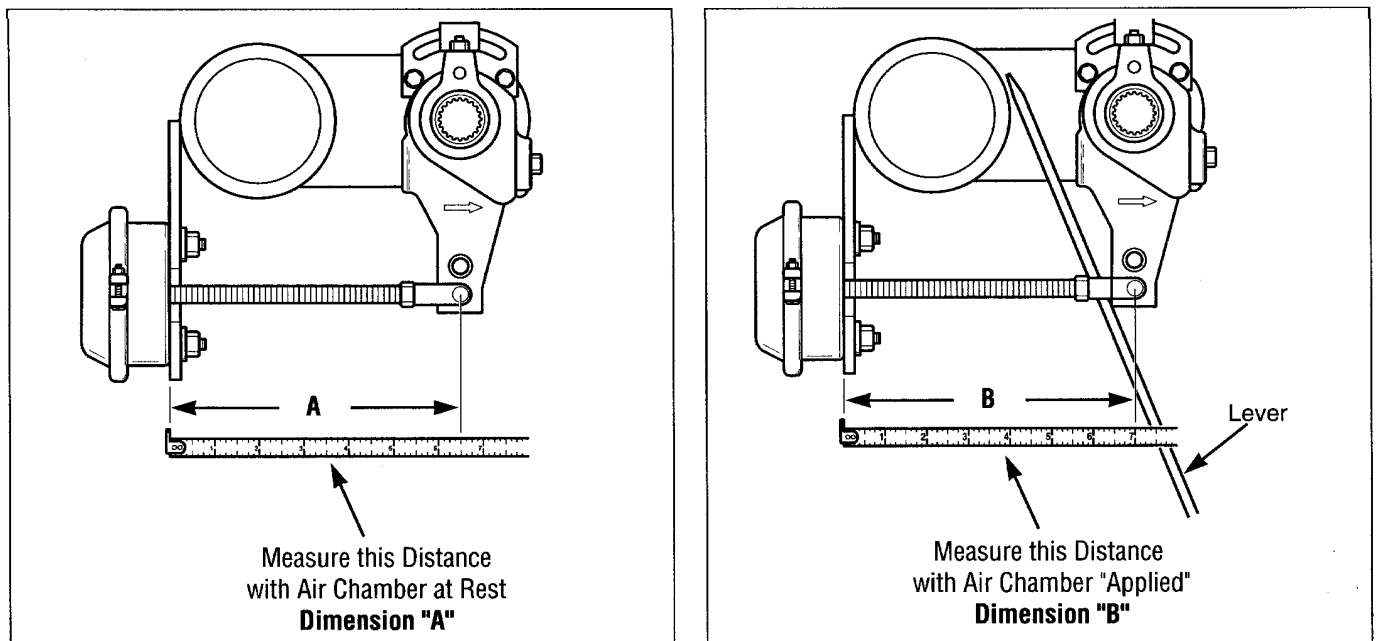

Figure 8-13 Adjust Slack Adjusters

## 8.4 EVERY SIX MONTHS

### 8.4.1 AIR IN-LINE FILTER

Your trailer is equipped with air inline filters. Filters are mounted on the inside of the frame rail. Every six months, relieve the air press in the trailer air tanks and remove the cap (A) and filter screen (B). See figure 8-14. Clean and install filter screen and cap.

#### **^ WARNING**

**Trailer air system is under pressure.**

**Cap and screen can shoot out with force.**

**Relieve air in the trailer air system before removing cap and screen.**

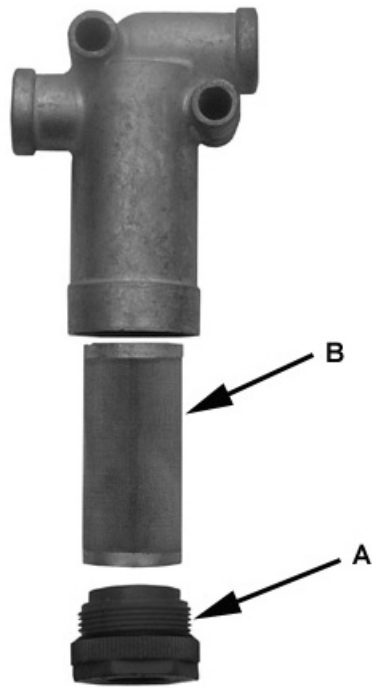

Figure 8-14 Air In-Line Filter

### 8.4.2 GLAD HAND SEALS AND SCREENS

Inspect all glad hand seals (A) and screens (B) (if equipped) for damage and wear. Replace if damaged or worn. See figure 8-15.

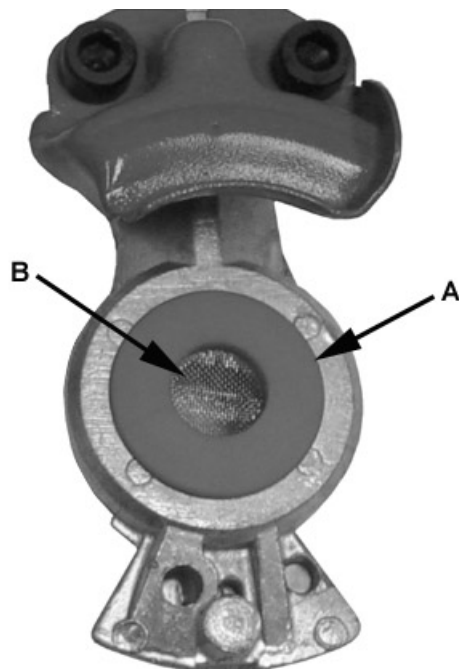

Figure 8-15 Glad Hand Seals And Screens



## 9. MAINTENANCE AND SERVICE

MAC Trailer uses components on their trailers such as landing gear, axle assemblies, tires and rims, hydraulic and air cylinders, which produced by other manufacturers. Refer to the OEM manufacturer's information for specific maintenance instructions. If you do not have the manufacturers information, contact your dealer or MAC Trailer for assistance.

Routine inspections, maintenance and service must be performed on your trailer on a regular basis to insure safe and reliable operation. Inspections can be performed by a person trained in spotting potential problems. Service and repairs must be performed by a trained, qualified technician.

*Note: In addition to this manual, also check the relevant component manufacturer's manual.*

### **^ WARNING**

#### **Crushing Hazard.**

**Before performing trailer inspections, service or maintenance:**

- **Park trailer on firm, level surface.**
- **Set parking brakes, turn truck engine off and remove ignition key.**
- **Chock tires if brakes are to be released.**
- **Support trailer with properly rated and placed stands.**

### 9.1 HYDRAULIC SYSTEM

Use an oil viscosity based on the expected air temperature range during the period between oil changes. Use of a good quality hydraulic oil and oil filter is critical to the performance and life of the hydraulic system.

Check the hydraulic pump, filter and cylinder manufacturer's information for service and maintenance intervals, recommended oil viscosity and oil additives.

Do not adjust pump pressure or relief valve settings. If the hydraulic systems is not operating properly, contact a qualified hydraulics technician.

### **^ WARNING**

#### **Crushing Hazard.**

**Adjusting pump pressure and/or relief valve settings can cause the hydraulic system to malfunction, which can result in the dump body falling.**

**Never adjust the pump pressure and/or relief valve settings. Contact a qualified hydraulics technician.**

### 9.2 TIRES

Before each tow, be sure the tire pressure is at the value indicated on the Certification / VIN label. Tire pressure must be checked while the tire is cold. Do not check the tire pressure immediately after towing the trailer. Allow at least three hours for a tire to cool, if the trailer has been towed for as much as one mile. Replace tires that have the wear bands showing before towing trailer.

A bubble, cut or bulge in a side wall can result in a tire blowout. Inspect both side walls of each tire for any bubble, cut or bulge; and replace a damaged tire before towing the trailer.

### **^ WARNING**

Collision hazard.

Worn, damaged or under-inflated tires can cause loss of control, injury and damage.

Check tires before towing trailer.

## **9.3 WHEELS**

Whenever tires/wheels are removed, check the condition of the wheel, wheel lugs, hubs and studs. Replace any damaged, corroded or worn parts. Use the correct wheel lugs and wedges (if equipped) for your trailer.

### **^ WARNING**

Wheel Failure Hazard.

- **Never weld on wheel or hub for any reason**
- **Never install aluminum wheels on an axle designed for steel wheels. The stud length is greater for aluminum wheels than steel wheels.**
- **Always use the correct lugs and wedges (if equipped).**

### **9.3.1 SPOKE WHEELS**

Lug nuts are prone to loosen right after a wheel is mounted to a hub. When driving on a remounted wheel, check to see if the lug nuts are tight after the first 50-100 miles of driving and weekly thereafter.

When removing a wheel from a trailer equipped with spoke wheels, care must be taken to avoid injury.

### **^ WARNING**

Flying Projectile Hazard.

Wedges can fly out with force when removing wheel.

Partially loosen wheel lugs and relieve tension on wedges before removing wheel lugs.

Loosen the wheel lugs but do not remove at this time. With the wheel lugs loose, strike the wedges with a hammer to free tension on wedges. Now the wheel lugs and wedges can be removed.

Install wheel, wedges and lugs. Rotate the wheel and set runout to a maximum of 1/8 inch. Evenly tighten lugs to 200-250 lb/ft of torque.

### **^ WARNING**

Wheel Failure Hazard.

Lug nuts are prone to loosen after being first assembled. Death or serious injury can result.

Check lug nuts for tightness on a new trailer, and after re-mounting a wheel after the first 50-100 miles and weekly thereafter.

### **NOTICE**

Trailer Damage.

Studs, lugs and wheels can be damaged by over tightening.

Do not over tighten wheel lugs.

### 9.3.2 DISK WHEELS

Lug nuts are prone to loosen right after a wheel is mounted to a hub. When driving on a remounted wheel, check to see if the lug nuts are tight after the first 50-100 miles of driving and weekly thereafter.

### **^ WARNING**

Lug nuts are prone to loosen after being first assembled. Death or serious injury can result.

Check lug nuts for tightness on a new trailer, and after re-mounting a wheel after the first 50-100 miles and weekly thereafter.

1. Place two drops of oil to a point between the nut and flange and two drops to the two or three threads at the end of each wheel stud.
2. Tighten to 50 lb/ft of torque in the sequence shown in figure 9-1.
3. Tighten to 450-500 lb/ft of torque in the sequence shown in figure 9-1.

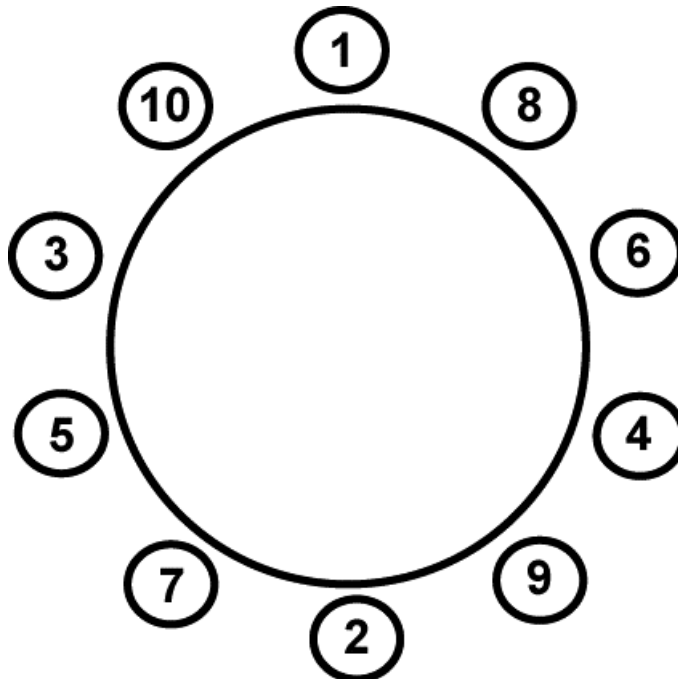

Figure 9-1 Wheel Lug Torque Sequence

### 9.3.3 WHEEL ENDS

Your trailer may be equipped with oil bath (A), grease packed (B) or Hendrickson Long-Lift System™ (HLS™) (C) wheel ends. See figure 9-2.

## Maintenance And Service

---

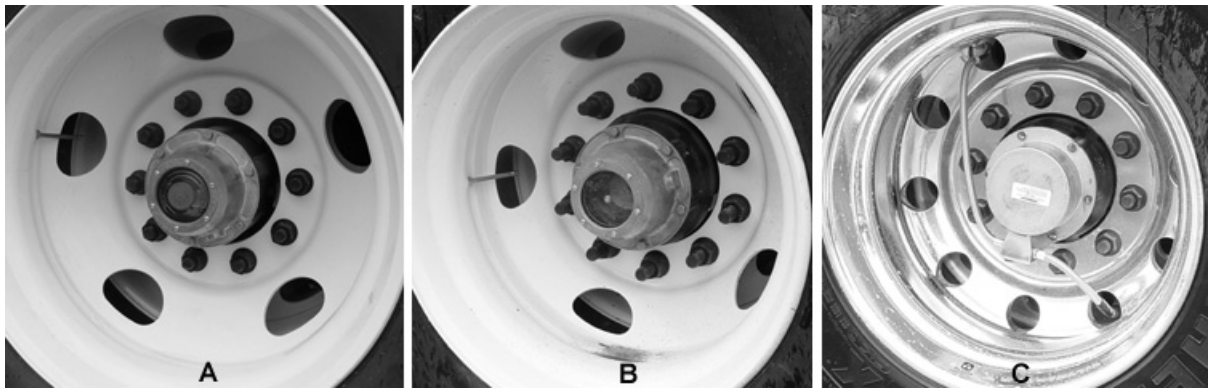

*Figure 9-2 Wheel End Options*

Oil bath style wheel ends (A) use an approved drive axle lubricant gear oil for lubrication. Remove the rubber plug. Use a lubricant meeting MIL-L-2105D specifications. Either 80W-90 mineral based or 75W-90 synthetic lubricant is acceptable. Do not mix lubricants. Add lubricant to the bottom full line on hub cap. Install rubber plug.

Grease packed wheel ends (B) use wheel bearing grease for lubrication. Check the axle manufacturers information regarding service and maintenance intervals.

Hendrickson Long-Life System™ (HLS™) wheel ends (C) are factory lubricated with a synthetic grease. Do not add lubricant, wheel end is factory lubricated. Do not attempt to adjust bearings, they are preset at the factory. Hub removal will void the warranty. Do not remove the (HLS™) hub cap without first contacting Hendrickson.



As a manufacturer, MAC Trailer recognizes the complexity of today's ever changing market and the necessity to make you more competitive with advanced design trailers that will reduce weights, increase payloads, maximize performance and enhance your profitability.

For MAC Trailer, **new technology** is *not something you purchase*, but rather have the **vision and ability to create.**



Alliance, Ohio • 14599 Commerce Street, Alliance, Ohio 44601

Salem, Ohio • 1453 Allen Rd., Salem, Ohio 44460

**800-795-8454 • 330-823-9900**

 [www.MACtrailer.com](http://www.MACtrailer.com) 

MAC Service • **800-297-7986**

MAC Aftermarket Parts • **800-647-9424**

MAC Used Trailers • **330-829-5035 • 800-297-7986**