



WELLS CARGO

The background of the page is a repeating pattern of stylized birds in flight, rendered in a light gray color against a slightly darker gray background. The birds are arranged in a grid-like pattern, facing various directions.

Owner's Manual



ABOUT YOUR NEW WELLS CARGO TRAILER

Now is the right time to complete the information below for your permanent record. Use a typewriter or print clearly. You will also need this Quick Reference when contacting Wells Cargo or a Wells Cargo Dealership regarding your Warranty, Service, Repair, or Replacement parts.

(Feed this side if using a typewriter)

DATE PURCHASED	_____	20	_____
SERIAL NUMBER	_____		_____
MODEL NUMBER	_____		_____
KEY LOCK NUMBER	_____		_____
HITCH SIZE	_____		_____
AXLE SIZE	_____		_____
TIRE SIZE	_____		_____
DEALERSHIP NAME	_____		_____
ADDRESS	_____		_____
CITY	_____		_____
STATE	_____	ZIP	_____
PHONE (_____)	_____



TABLE OF CONTENTS

MESSAGE FROM THE PRESIDENT Page 2

ABOUT THIS MANUAL..... Page 3

DEALERS & SERVICE Page 3

LABELS - INSTRUCTIONS - WARNINGS Pages 4-8

NOTES..... Pages 9

BEFORE YOUR 1ST TRIP - CHECK LIST..... Pages 10

ROUTINE MAINTENANCE - CHECK LIST Pages 11-12

WHAT TO CHECK & HOW TO CHECK Pages 13-14

WARRANTY PROGRAM & CARD Pages 15-18

WHAT TO CHECK & HOW TO CHECK (con't) Pages 19-22

12-VOLT ELECTRICAL SYSTEMS Pages 23-25

PLUMBING..... Pages 26

MISC. INFORMATION Pages 27-29

TIRE SAFETY INFORMATION Pages 30-32

PLANT LOCATIONS Pages 33

REPORTING SAFETY DEFECTS..... Below

REPORTING SAFETY DEFECTS

If you believe that your vehicle has a defect which could cause a crash or could cause injury or death, you should immediately inform the National Highway Traffic Safety Administration (NHTSA) in addition to notifying Wells Cargo, Inc. If NHTSA receives similar complaints, it may open an investigation, and if it finds that a safety defect exists in a group of vehicles, it may order a recall and remedy campaign. However, NHTSA cannot become involved in individual problems between you, your dealer, or Wells Cargo, Inc. To contact NHTSA, you may either call the Vehicle Safety Hotline toll-free at 1-888-327-4236 (TTY: 1-800-424-9153); go to <http://www.safercar.gov>, or write to: Administrator, NHTSA, 1200 New Jersey Avenue S.E., Washington, DC 20590. You can also obtain other information about motor vehicle safety from <http://www.safercar.gov>.



WITH A WELLS CARGO BEHIND . . . YOU NEVER LOOK BACK!

Thank You . . . From Wells Cargo Trailers!

We hear it all the time, "My Wells Cargo pulls so well, I can hardly tell it's there." There's a reason why a Wells Cargo delivers such smooth towing and stable handling. We build them better! Experience makes a difference, and our experience is unmatched in the industry. Since 1954, we've combined State-of-the Art Design with the best materials available to manufacture our trailers.

There's another reason for our slogan, "*With a Wells Cargo Behind . . . You Never Look Back!*" We never want you to "look back" or second guess your decision to buy a Wells Cargo trailer. That's why we support you with a comprehensive Warranty Program that really works for you.

See page 15 for warranty details.



BY UNIVERSAL TRAILER



ABOUT THIS MANUAL . . . DEALERS & SERVICE

OUR PRODUCT

Wells Cargo builds ball coupler and gooseneck trailers in several basic configurations. Most trailers we build are customized on our production lines by the inclusion of one or several optional features as specified by the dealer or customer. The list of options runs into the hundreds of possible combinations.

OUR BRANDS

Wells Cargo manufactures five different model lines: Wells Cargo™, Road Force®, TC Trecker®, MotorTrac®, and Silver Sport™. This manual primarily addresses the Wells Cargo line since it represents our most comprehensive brand with the most sizes, configurations, options, and customizing. However, all our trailer lines feature similar characteristics, components, features, and assemblies. For that reason, almost all the topics addressed in this Owner's Manual are applicable to all lines. There may be slight variations, but the overall concepts are universal.

THIS MANUAL

This manual covers only the basic trailer and standard components. Information and warranty details for any optional equipment are available from Wells Cargo or any Wells Cargo Dealer.

WELLS CARGO DEALER

Authorized Wells Cargo Dealers are responsible business people who have lengthy backgrounds in cargo trailers. They have in depth knowledge about trailer

construction, job specifications and proper applications of specific models. They're equipped to handle your service effectively and efficiently.

NATIONAL SERVICE NETWORK

Wells Cargo has manufacturing facilities in Phoenix, Arizona; Waycross, Georgia; Elkhart, Indiana; Waco, Texas; Ogden, Utah; and Carbondale, Pennsylvania. Each manufacturing plant operates a Customer Service Facility. With the additional Service Facilities at hundreds of Authorized Wells Cargo Dealerships nationwide you are never far from a convenient location for service work anywhere you travel.

IMPORTANT:

We urge you to become familiar with the contents of this manual. Following the basic directions is your key to the safe operation of your Wells Cargo Trailer. It is also the best way to ensure that you keep the full protection of your Warranty.

CALL 1-800-348-7553

For Nearest Location or Any
Other Questions



LABELS - INSTRUCTIONS - WARNINGS

Check your new Wells Cargo trailer for Instructional & Warning Labels like the ones listed below. Many are mandated by the Federal Government and others will help you in proper and safe operation. If decals become faded or damaged to the point where they are unreadable, please contact Wells Cargo for replacement. The information below is included in the event a label is missing.

Located At Lift-Up Nose Cone®

NOTICE
LUBRICATE ALL PIVOT POINTS WITH
SAE 30 WEIGHT OIL A MINIMUM OF
TWO TIMES PER YEAR

*At Propane or
 Natural Gas Appliance*

WARNING
 BE SURE TO
Connect Appliance First
 and check before you
 connect gas bottles to line.
APPLIANCES ARE NOT
CONNECTED AT
FACTORY
 Law requires that
 an authorized competent
 service man **ONLY** can complete
 this installation.

*At Ride-In Entry
 i.e. Snowmobiles, Motorcycles*

CAUTION - LOW CLEARANCE

At Transfer Switch or Junction Box

GENERATOR CIRCUIT. THIS
CONNECTION IS FOR
GENERATORS RATED
110-125 VOLT AC,
60HZ _____ AMPERES
MAXIMUM.

At Transfer Switch or Junction Box

AIR COND. CIRCUIT. THIS
CONNECTION IS FOR
AIR CONDITIONER RATED
110-125 VOLT AC.
60HZ _____ AMPERES
MAXIMUM

LABELS - INSTRUCTIONS - WARNINGS

At Ramp Doors



At Outside Power Supply Connection

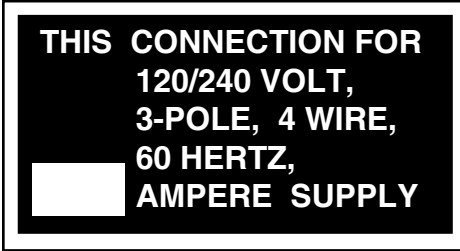

Located at Breakaway Switch Test Light

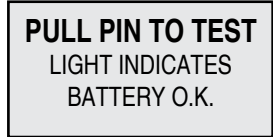

At Outside Power Supply Connection



Located with Customer Information Papers

WARNING — EXTREME — DANGER

The "RAMP-HEISTER" torsion spring assembly has been carefully selected and installed by the manufacturer of this trailer. It has been designed to counterbalance the weight transferred when opening and closing the entrance ramp. The entire torsion spring assembly, mounting hardware and cables are loaded with tremendous energy. Repairs or adjustments by inexperienced persons or without proper tools is hazardous and could cause severe personal injury or death. Do not attempt to remove or repair any door components, hardware or the structure that these components are attached to. Periodic inspection of the entire assembly, to include but not be limited to, cable wear, fastener integrity and proper lubrication, is required. ALL REPAIRS OR ADJUSTMENTS MUST BE PERFORMED BY EXPERIENCED DOOR SERVICE PERSONNEL ONLY!

WARNING — EXTREME — DANGER



WELLS CARGO Owner's Manual

LABELS - INSTRUCTIONS - WARNINGS

Federal I.D. Plate - Mounted Road Side Lower Front Corner

MANUFACTURED BY/FABRIQUE PAR: Wells Cargo, Inc. Date: 8/17/2005
 MODEL/MODELE: TW141-U Elkhart, IN 1-800-348-7553
 GVWR/PNUB: 1356 KG (2990 LB)
 GAWR (EACH AXLE) PNBE (CHAQUE ESSIEU): 7718KG (3500LB)
 TIRES/PNEU: RIMS/JANTE: 15 x 5/38.1x12.7
 COLD INFL PRESS/PRESS DE GONFL A FROID 50
 THIS VEHICLE CONFORMS TO ALL APPLICABLE U.S. FEDERAL MOTOR VEHICLE SAFETY STANDARDS in EFFECT ON THE DATE OF MANUFACTURE SHOWN ABOVE. THIS VEHICLE CONFORMS TO ALL APPLICABLE STANDARDS PRESCRIBED UNDER THE CANADIAN MOTOR VEHICLE SAFETY REGULATIONS IN EFFECT ON THE DATE OF MANUFACTURE. CE VEHICULE EST CONFORME A TOUTES LES NORMES QUI LUI SONT APPLICABLES EN VERTU DU REGLEMENT SUR LA SECURITE DES VEHICULES AUTOMOBILIFS DU CANADA EN VIGUEUR A LA DATE DE SA FABRICATION
 U.I.N./N.I.U. 1MC200G1761114312 TYPE/TYPE: TRAILER/REMORQUE

Tire Placard - Mounted Road Side Lower Front Corner



TIRE AND LOADING INFORMATION

THE WEIGHT OF THE CARGO SHOULD NEVER EXCEED 667 KG 1470 LB

TIRE	SIZE	COLD TIRE PRESSURE	SEE OWNER'S MANUAL FOR ADDITIONAL INFORMATION <small>FD-320</small>
FRONT	ST205/75RR15	345 KPA or 50 PSI	
REAR			
SPARE			

1MC200G1761114312

Manufacturers I.D. Plate - Mounted Road Side Lower Front Corner

SINCE 1954



DESIGN PROTECTED BY TRADEMARK LAW

ELKHART, IN
 WAYCROSS, GA
 WACO, TX
 OGDEN, UT
 PHOENIX, AZ
 MCADOO, PA

TELEPHONE: 1-800-348-7553

LABELS - INSTRUCTIONS - WARNINGS

Aluminum Roof Rack Cross Bars

MAXIMUM WEIGHT 50 LBS

For trailers with rear spotting hitches. Primarily for Cable Splicing trailers.

REAR HITCH ASSEMBLY NOT TO BE USED FOR TOWING PURPOSES. FOR PLACEMENT ONLY!

At Trailer Sidewall above Corner Post Jacks

**STABILIZING JACK
2000 LB. STATIC LOAD**

**STABILIZING JACK
3000 LB. STATIC LOAD**

Ball Hitch Instruction and Warnings

ATTENTION MANUFACTURERS, DISTRIBUTORS, AND DEALERS THIS INFORMATION MUST BE PASSED ON TO THE CONSUMER

⚠ WARNING
PERSONAL INJURY

- Safe towing practice requires the proper use of safety chains used in accordance with instructions provided by the trailer manufacturer.
- Check that the ball has been completely inserted into the coupler ball socket and the ball clamp (inside the coupler) is closed around the underside of the tow ball and the handle is in the closed position.
- The loaded weight of the trailer must never exceed the least capacity marked on the coupler, tow ball, hitch, trailer or vehicle.
- Check coupler, hitch and ball for damage or wear before each use. Assure all parts operate freely. Replace any component if worn or damaged.
- Failure to follow warnings and instructions could result in separation of tow vehicle and trailer which can result in death, personal injury and property damage.

INSTALLATION INSTRUCTIONS
Request Atwood Bulletin for complete instructions on coupler installation, operation and maintenance.
DO NOT ATTEMPT INSTALLATION WITHOUT BULLETIN.
Request MPD 87984 bulletin

Atwood Mobile Products, Rockford, IL 61103
815-877-5700

MARVEL FLIP LATCH COUPLER 2/14/01 MPD 88552

⚠ WARNING
PERSONAL INJURY

- Always open latch handle before inserting ball.

LATCHING INSTRUCTIONS

1. To open, slide forward and pull up open latch before inserting ball FIG 1.
2. Place coupler on ball of same diameter as coupler ball socket size and of same or greater capacity than trailer GVW.
3. When ball is completely nested in socket, push top of latch handle rearward until handle snaps into closed position FIG 2.
4. Extend jack to ground and lift car/trailer combination 2'-4" to insure coupler is securely attached to tow ball. Retract jack completely before towing.
5. Insert padlock through hole in handle FIG 2-A for theft protection.

Note: These couplers are not adjustable for ball size.

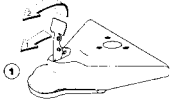
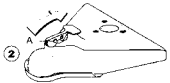



MAINTENANCE INSTRUCTIONS

Lubricate ball socket with extreme pressure grease. Lubricate moving parts with SAE 30 oil.

LABELS - INSTRUCTIONS - WARNINGS

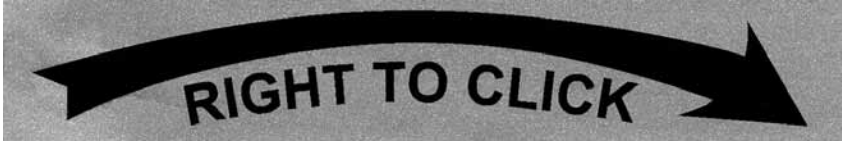
Located above lock assembly on MPT models only.



On Wells Cargo and Road Force trailers with 3,500 lb. to 8000 lb. axles. Located behind fender/fenderette as low as possible.

 <p>DEXTER AXLE</p>	<p>THIS TRAILER IS EQUIPPED WITH DEXTER</p>
<p>Part No. 059-870-00 Rev. A</p>	 <p>NEV-R-ADJUST™ FORWARD SELF-ADJUSTING ELECTRIC BRAKES</p> <p>STOP IN HALF THE DISTANCE</p> <ul style="list-style-type: none"> ■ Reduces Stopping Distance ■ Eliminates Adjustments ■ Retrofits to Existing Axles <p>Proper Brake Adjustment With Every Mile</p>



NOTES

BEFORE YOUR 1ST TRIP - CHECK LIST
CHECK POINT:

Tire Pressure & Tire Condition	X
Wheel Lugs*	X
Bearing Lube & Tightness	X
Burnish Brakes	X
Brakes/Brake Controllers	X
Breakaway Battery Charge	X
Hitch	X
Safety Chains	X
12V Running Lights	X
Doors/Windows/Roof Vents Locked	X
Distribution & Security	X
All Jacks "Up" in Travel Position	X
Level Trailer <i>(Parallel with ground & tow vehicle)</i>	X

***Check Lug Nuts for tightness before initial trip, at 10 miles, 25 miles and 50 miles. Recheck at least every 3 months or 3000 miles.**

Your Wells Cargo Dealer, in all probability, checked each of these Points before you took delivery. However, these are key things you should re-check before taking your trailer on the road for the first time.

A complete description of how to properly check these Points starts on Page 10.



ROUTINE MAINTENANCE CHECK LIST

CHECK:	WHAT TO DO:	EVERY TRIP	EVERY 3000 Mi. or 3 Mo.	EVERY 6000 Mi. or 6 Mo.	See Page # for Details
Tire Air Pressure	Inflate to Proper Pressure Indicated on Sidewall	●			10
Wheel Lugs Bolts & Nuts	Tighten to Proper Torque Specifications		● *		11
Wheel	Check for Damage and/or Out of Round			●	11
Coupler Ball or 5th Wheel & Pin	Check for Sufficient Lube. Check Lock Mechanism. Check for Unusual Wear.	●			12
Coupler	Check for proper fastening & Hitch Pin in position and secure	●			12

***Check Lug Nuts for tightness before initial trip, at 10 miles, 25 miles and 50 miles. Recheck at least every 3 months or 3000 miles.**

AXLES • HUBS • BRAKES: Your Wells Cargo trailer is equipped with Dexter Axles. The Dexter Operation Maintenance Service Manual, along with additional reference materials, can be found inside your trailer's service packet. Replacement copies are available from your Wells Cargo dealer. You can also find useful axle related information by visiting the Dexter Axle On-line Trailer Resource Library at:

www.dexteraxle.com/resource_library

Maintenance for Axles, Hubs and Brakes is extremely important. It is critical for protecting the longevity of your trailer. It is also vital for your personal safety and the protection of others. Follow the Dexter service recommendations exactly as described.

Please, never shortcut Axle • Hub • Brake service and maintenance.



ROUTINE MAINTENANCE CHECK LIST

CHECK:	WHAT TO DO:	EVERY TRIP	EVERY 3000 Mi. or 3 Mo.	EVERY 6000 Mi. or 6 Mo.	See Page # for Details
Safety Chains	Check for abrasion, distortion and general integrity of links	●			14
Brakes	Check for proper adjustment & operation	●			19
Breakaway Switch	Test Switch Operation and Connections	●			19
Breakaway Battery	Pull Switch Pin, Check Charge Indicator Light	●			19 - 20
Doors, Windows & Roof Vents	Check all Windows/Doors/Roof Vents. Make sure all are closed & locked	●			21
Load Distribution	Check Load Distribution & Security	●			21
Leveling Jacks	Check Fastenings. Lube.	●			21
Welds	Check All Weld Beads for Cracks or Separations.			●	22
Hinges	Grease zerks with a Lithium complex grease.		●		22
Tie-Down Devices	Check for fracturing, distortion and improper anchoring.		●		22
Electrical: Lights & Signals	Check to make sure all are working properly. Replace burned out bulbs	●			23 - 25

TIRE PRESSURE: Proper air pressure for your tires is printed on the sidewall. Check pressure while tires are cold. Do not raise or lower pressure to meet load. Pressure other than recommended

pressure will lead to excessive tire wear or tire failure. *Balancing recommended.* Preferred Balancing Method is to center off of stud holes, since 13" thru 17.5" wheels are not hub piloted.

WHAT TO CHECK . . . HOW TO CHECK

WHEELS: Check Wheels for hole elongation or "out of round". This condition can be caused by Lug Nuts not being tight, or too tight. Trailer wheels can be damaged by chuck holes or curb jumping. You may not be aware of the road shock to the wheels without periodic checks. Replace any wheel that is bent. Replace any wheel if you see elongation of the bolt holes.

WHEEL LUGS: Wheel Lug Nuts must be tightened with a torque wrench. Refer to the chart below for proper torque for your trailer. Check Lug Nut tightness before initial trip, at 10 miles, 25 miles and 50 miles. Recheck at least every 3 months or 3000 miles.

TORQUE STAGES

1st Stage	2nd Stage	3rd Stage
20/25 ft. lbs.	40/50 ft. lbs.	Full Torque

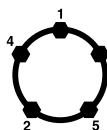

5 BOLT

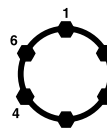

6 BOLT

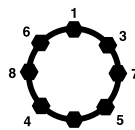

8 BOLT

Note: Warranties on trailer and axle do not apply to damage or injuries caused by loose or improperly tightened lug nuts or broken studs.

AXLE SIZE	WHEEL SIZE	STUD SIZE	STEEL WHEEL TORQUE	ALUMINUM WHEEL TORQUE
2000#	13"	1/2"	50# - 75#	N/A
2000#	14"	1/2"	90# - 120#	N/A
2000#	15"	1/2"	90# - 120#	90# - 120#
2500#	15"	1/2"	90# - 120#	90# - 120#
3500#	13"	1/2"	50# - 75#	N/A
3500#	15"	1/2"	90# - 120#	90# - 120#
5000#	15"	1/2"	90# - 120#	90# - 120#
6000#	15"	1/2"	90# - 120#	90# - 120#
6000#	16"	1/2"	90# - 120#	90# - 120#
7000#	16"	1/2"	90# - 120#	90# - 120#
7000#	16"	9/16"	90# - 120#	90# - 120#
7000#	16"	5/8"	275# - 325#	275# - 325#
7200#	16"	9/16"	90# - 120#	90# - 120#
7200#	16"	5/8"	275# - 325#	275# - 325#
8000#	17.5"	5/8"	275# - 325#	275# - 325#



WHAT TO CHECK . . . HOW TO CHECK

BALL COUPLER HITCHES:

Coupler Assembly includes a Latch Lever, and Latch Lever Safety Pin or Hitch Pin. Be sure the Latch Lever is locked and the Pin properly secured before moving your trailer. The Pin can be engaged fully only if the Ball is properly seated in the Coupler.



HITCH BALLS come in a variety of diameters and capacities. The GVWR capacity is always stamped on the Ball. Wells Cargo trailers use either a 2" Ball or a 2⁵/₁₆" Ball depending on the GVWR of the trailer. *Always* be sure the Hitch Ball at least matches the GVWR of your trailer. *Always* be sure the diameter of the Hitch Ball matches the Coupler diameter. *Never* attempt to tow your trailer with improper size Ball. *Always* keep Ball greased to avoid excessive wear. Replace worn Hitch Balls or Locking Dogs promptly.

GOOSENECK HITCHES: Your Wells Cargo Gooseneck Trailer will be equipped with one of four hitch types pictured below. Be sure the King Pin or 5th Wheel on tow vehicle is rated for at least as much weight as the GVWR of the Trailer. Hitches (A, B & C pictured below)

require a SAE 2" King Pin or 5th Wheel. Hitch D, (the Adjustable Height Ball Coupler Goose Neck) requires a 2⁵/₁₆" Hitch Ball with a rating equal to the GVWR of the unit.

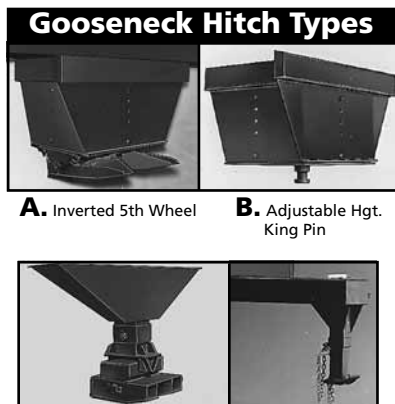

*Note: Ball Coupler Hitch (D.) requires Safety Chains

Recommended: Mount King Pin or 5th Wheel Hitch on the bed of the tow vehicle. This lowers the center of gravity for easier and safer handling. Replace worn Hitch Pins and 5th Wheel Jaws promptly.

Check with Tow Vehicle Manufacturer, Owners Manual or Local Dealership for any Hitch installation requirements. Hitches installed otherwise may void your tow vehicle warranty.

SAFETY CHAINS: Your Wells Cargo Trailer is equipped with Safety Chains that meet the requirements of D.O.T. Regulations 393.70.

Always attach the Chains by crossing them, forming a "cradle". If your Coupler disengages for any reason, the "cradle" will keep the Hitch from dragging the ground. You'll be able to make an easier and safer stop.

NEVER LOOK BACK WARRANTY PROGRAM**WELLS CARGO, INC. LIMITED WARRANTY****DURATION OF WARRANTY**

Your Wells Cargo equipment, which has been manufactured, tested and inspected in accordance with carefully specified engineering requirements, is warranted to the original owner to be free from defects in material and workmanship for the period of **six (6) or four (4) or three (3) years** depending on the brand/model*, except as herein limited, from date of purchase. The obligation of this Warranty shall be limited to repairing or replacing any part or parts which, in the opinion of the Company shall be proved defective in materials or workmanship under normal use and service during the appropriate year(s) period commencing with the date of purchase. Jack rams, electrical wiring, glass sealants, doors, seals, locks, paint, plumbing, couplers and jacks are warranted for a period of one (1) year from the date of purchase. The D.O.T. Wet Cell Battery (Breakaway System) is warranted for a period of six (6) months from the date of purchase.

This Warranty gives you specific legal rights, and you may also have other rights which vary from State to State.

**Length of Warranty by brand/model:*

**6-Year Warranty****4-Year Warranty****MT1000 — 3-Year Warranty
MT2000 & MT4000 — 6-Year Warranty****3-Year Warranty****3-Year Warranty**



NEVER LOOK BACK WARRANTY PROGRAM

LIMITATIONS AND EXCLUSIONS

This Warranty shall not extend to:

- 1)** Wells Cargo equipment which has been modified, repaired, or altered in any way without the express written consent of Wells Cargo.
- 2)** Unreasonable use (including failure to provide reasonable and necessary maintenance.)
- 3)** Tires, wheels, axles, axle assemblies, suspension components, ranges, heaters, refrigerators, air conditioners or all other appliances or components of the Wells Cargo equipment which are warranted separately by the respective manufacturers of said components. These warranties are contained in the owner's packet.
- 4)** Any consequential damages for breach of this or any other warranty expressed or implied whatsoever. Repair or replacement under this Warranty is the exclusive remedy of the customer. Some States do not allow the exclusion or limitation of incidental or consequential damages, so the above limitation or exclusion may not apply to you.
- 5)** Parts not supplied by Wells Cargo.
- 6)** Certain parts which require replacement in the ordinary course of use due to normal wear.

PROCEDURE

To secure repair of a trailer or any warranted parts under this Warranty, the unit or warranted part must be delivered, charges prepaid, to the nearest Wells Cargo Dealer or Wells Cargo manufacturing facility or as directed by the Company.

Your Wells Cargo dealer from whom you purchased your unit is responsible for the registration of your warranty with the factory. We ask that you cooperate with your dealer in supplying the necessary information on the warranty card so that we may better serve you.

Please Note: Should equipment not supplied by Wells Cargo fail, (e.g. the hitch you have installed on your tow vehicle), the result may be an accident, damage or injury beyond our control.

Wells Cargo, Inc. Warranty Registration

Please complete & return card promptly.

NAME: _____

COMPANY: _____

ADDRESS: _____

CITY: _____ STATE: _____

ZIP CODE: _____ COUNTRY: _____

PHONE: (_____) _____ FAX: (_____) _____

EMAIL: _____

Where have you seen Wells Cargo Advertised? _____

Please check the planned use of your Wells Cargo trailer:

- | | | | |
|--|---|--|--|
| <input type="checkbox"/> Motorcycles | <input type="checkbox"/> Auto Racing | <input type="checkbox"/> Moving/Relocating | <input type="checkbox"/> Manufacturer |
| <input type="checkbox"/> Snowmobiling | <input type="checkbox"/> Auto Collector | <input type="checkbox"/> Marching Band | <input type="checkbox"/> Distributor |
| <input type="checkbox"/> ATV | <input type="checkbox"/> Karting | <input type="checkbox"/> Mobile DJ | <input type="checkbox"/> Retailer |
| <input type="checkbox"/> Bicycles | <input type="checkbox"/> Camping/RV | <input type="checkbox"/> Musician/Band | <input type="checkbox"/> Public Utility |
| <input type="checkbox"/> BMX | <input type="checkbox"/> Scouting | <input type="checkbox"/> Photography/Video | <input type="checkbox"/> Government Agency |
| <input type="checkbox"/> RC Models | <input type="checkbox"/> Arts & Crafts | <input type="checkbox"/> Radio/TV | <input type="checkbox"/> School/College |
| <input type="checkbox"/> Ballooning | <input type="checkbox"/> Antiques | <input type="checkbox"/> Hunting | <input type="checkbox"/> Church/Service Group |
| <input type="checkbox"/> Living Quarters | <input type="checkbox"/> Toy Hauler | <input type="checkbox"/> _____ | <input type="checkbox"/> Agricultural/Animal |
| | | | <input type="checkbox"/> Moving Company |
| | | | <input type="checkbox"/> HAZMAT Response |
| | | | <input type="checkbox"/> Fire/Police/Medical |
| | | | <input type="checkbox"/> Landscape |
| | | | <input type="checkbox"/> Ground Maintenance |
| | | | <input type="checkbox"/> Nursery |
| | | | <input type="checkbox"/> Sales/Display |
| | | | <input type="checkbox"/> Restroom Trailers |
| | | | <input type="checkbox"/> Construction (Gen.) |
| | | | <input type="checkbox"/> Mechanical Contractor |
| | | | <input type="checkbox"/> Electrical Contractor |
| | | | <input type="checkbox"/> Painting Contractor |
| | | | <input type="checkbox"/> Remodeling Contractor |
| | | | <input type="checkbox"/> Roofing/Siding/Gutter |
| | | | <input type="checkbox"/> Insulation |
| | | | <input type="checkbox"/> Furniture/Cabinets |
| | | | <input type="checkbox"/> _____ |
| | | | <input type="checkbox"/> Concessionaire |
| | | | <input type="checkbox"/> Catering |
| | | | <input type="checkbox"/> Restaurant |
| | | | <input type="checkbox"/> Delivery Service |
| | | | <input type="checkbox"/> Misc. Service |
| | | | <input type="checkbox"/> Rental/Leasing |
| | | | <input type="checkbox"/> Utility Companies |
| | | | <input type="checkbox"/> _____ |



SERIAL NUMBER:	_____
MODEL NUMBER:	_____
DATE PURCHASED:	_____
DEALER NAME and/or NUMBER:	_____



NO POSTAGE
NECESSARY
IF MAILED
IN THE
UNITED STATES

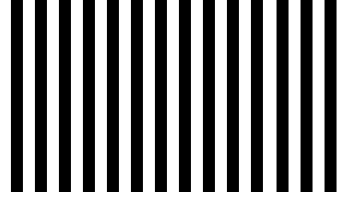

BUSINESS REPLY MAIL
FIRST-CLASS MAIL PERMIT NO. 588 ELKHART, IN

WELLS CARGO INC
PO BOX 728
ELKHART IN 46515-9908



WHAT TO CHECK . . . HOW TO CHECK

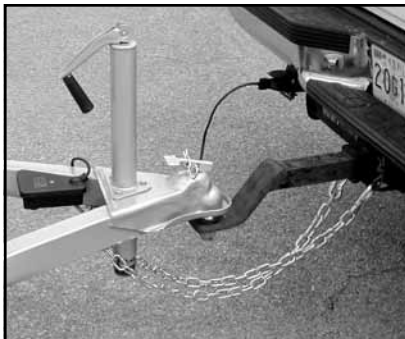

Safety Chain Hook-Up

Abrasion (possibly from dragging on the ground) or unusual stress (like the situation described above) can weaken the links, making them unsafe for trailering. If you detect any of these conditions, replace the Safety Chains immediately! If safety chains are too long, shorten to prevent dragging. **DO NOT TWIST!**

BRAKES: Your Wells Cargo Trailer is equipped with one of several Brake type options. Complete service and repair information for each available type brake is found in the Dexter Service Manual that is furnished with your Trailer. It is important to strictly adhere to the Dexter instructions for brake service and repair. In this way, you are protecting the validity of all applicable Warranties.

BURNISHING BRAKES: Brakes on a new trailer may tend to “grab”, or pulsate. This is normal. To correct the situation, pull the trailer with the trailer brake control slightly engaged a short distance. This action smooths down the brake bands. Do not lock up the wheels.

BREAKAWAY SWITCH & D.O.T.

WET CELL BATTERY: After hitching to Tow Vehicle, pull the Safety Pin on the Breakaway Switch to the first position (no need to completely remove pin). If the Test Light appears, battery is charged and the system is operational. Push Safety Pin back in to its original position. Check Battery fluid level every 60-90 days. Remove Cover. There are two Fill Caps. Refill with distilled water, only. Your Breakaway assembly is equipped with a Charge Line. (See Wire Diagrams, Page 20-21) Tow vehicle must also be wired for a charge line to keep Breakaway Battery charged. During long periods of idleness, keep wet cell battery charged using a trickle charger. A discharged battery can freeze and crack in winter.

BATTERY STORAGE: Before storing your battery, you should:

- 1.) Clean the battery case and terminals with baking soda and water
- 2.) Check the water level and add water if needed
- 3.) Test your battery with a hydrometer and/or voltmeter to ensure the battery is fully charged.
- 4.) If needed, charge your battery. Batteries stored in a discharged state are susceptible to freezing, sulfation and an increased rate of discharge. A fully charged battery will not freeze unless the temperature reaches approximately 80°F below zero. But if discharged, it can freeze at 32°F.

Store your battery in a dry, cool, well-ventilated area—the cooler the better without going below 32°F—out of reach of children and pets. Check the water level and state of charge every 45-60 days. If needed, add distilled water and charge.



WHAT TO CHECK . . . HOW TO CHECK

Breakaway Switch & Test Light - Mounted on A-Frame

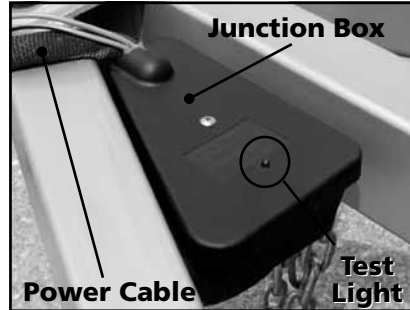

* Attach Breakaway Switch Cable securely to tow vehicle. Locate attachment so little "slack" is left in the Cable; but enough slack to allow for turning without disengaging Pin. Thus, the Cable will activate brakes the instant a trailer becomes disengaged. *Brake adjustment is critical to stopping a disengaged trailer.*

Breakaway Battery on A-Frame



Two Fill
Caps
Underneath
Cover

CHECK BREAKAWAY SYSTEM & BRAKES BEFORE EACH TRIP

1. Disconnect 12V Plug from tow vehicle
2. Pull Breakaway Pin. If RED Test Light appears, there is adequate charge for battery to function.
3. While Pin is pulled, move tow vehicle forward. Brake should be on & wheels locked.
4. Replace Pin and secure to tow vehicle. Do not loop over Hitch Ball.
5. Plug 12V Connector into tow vehicle receptacle.
6. Test Brakes with Brake Controller.

NOTE: When disconnecting trailer from tow vehicle, make sure to replace Safety pin on the Brakeaway Switch. Failure to replace Safety Pin will drain battery and render the Brakeaway System useless. The Breakaway System should **NEVER** be used as a parking brake. Also, the wet cell battery is dedicated to the Brakeaway system only. **DO NOT** run any other charges (i.e., dome lights) from this battery.

WHAT TO CHECK . . . HOW TO CHECK

DOORS, WINDOWS & VENTS:

Before towing your trailer, check that all doors, windows and roof vents are closed and latched. Make sure all closing mechanisms are functioning properly and are secured. Cam Lock Door Closures should be fully engaged. Single Doors with Flush Locks should be locked. Using padlocks on all doors is added insurance against accidental opening from road shock. Taking the above measures means you can travel without danger of doors and windows accidentally opening.

DOOR HOLD BACKS: These devices are intended to hold a door open in grade deviations only. Do not rely on them to hold door open in windy conditions or in travel.

LOAD DISTRIBUTION: The total weight of the load you put in or on your trailer, plus the empty weight of the trailer itself, must not exceed the trailer's Gross Vehicle Weight Rating (GVWR). In addition, you must distribute the load in the trailer such that the load on any tire or axle does not exceed the tire load rating or the Gross Axle Weight Rating or GAWR.

Uneven load distribution can cause tire, wheel, axle or structural failure. Be sure your trailer is properly loaded. A proper weight distribution is equal, right to left; and creates a hitch weight that is in the proper range for stable trailer handling. In the table that follows, the second column notes the "rule of thumb" percentage of total weight of the trailer plus its cargo

(GVW) that should appear on the hitch of the trailer. Consider these percentages as guidelines for Ball Hitch, V-Front and Gooseneck trailers respectively. Actual percentages may vary. Many factors including optional equipment, trailer configuration, towing angle, and load factor can and will affect hitch weight. Never exceed the hitch weight rating stamped on your tow vehicles coupler.

TYPE OF HITCH	HITCH WEIGHT %
Ball Hitch	10% to 15%
V-Front	10% to 15%
Gooseneck	25%

Overloading, uneven load distribution, and improper hitch weight can result in dangerous driving conditions resulting in loss of control of the trailer.

STABILIZER/LEVELING JACKS:

Always block tires before and while using Leveling Jacks! Failure to block tires can result in failure of the Jacks or Stabilizers. This, in turn, can cause property damage and/or personal injury. Stabilizer Jacks (Cornerpost or Swing-Down) installed as original equipment by Wells Cargo have static load capacities ranging from 650 to 3000 lbs. (See label affixed near jack for exact capacity.) Consult individual Manufacturer's Owners Manual for capacity and rating for all Manual and Electric Leveling Jacks.



WHAT TO CHECK . . . HOW TO CHECK

WELDS: Every 6 months or 6,000 miles, check all welds for fractures or cracks. Also, check steel surfaces around the welds for any sign of cracking. If you do detect any of these conditions, *immediately* contact your Wells Cargo Dealer, or call Wells Cargo.

HINGES: Keep Hinges clean and clear of salt and road dirt. Proper maintenance will keep hinges from binding or freezing. Newer models: Steel hinges with a free flow pin and a grease zerks require greasing every 3 months. A Lithium complex grease is adequate for this routine maintenance. Older models: Lubricate with WD 40 or equivalent light oil.

TIE-DOWN DEVICES (ALL): Check regularly for any signs of fracturing, distortion and improper anchoring. Replace as needed.

TRAILER BODY: Keep your trailer clean, both interior and exterior. The exterior metal skin, roof caps, and wheels (standard, chrome, and aluminum) should be waxed at least once a year — more often if needed. Any anodized aluminum including the roof cove and trim accents should be cleaned with a mild detergent, rinsed thoroughly, and waxed as well. Do not use excessive abrasive cleaners as it may mar the protective finish. Make sure to touch up scratches. Scratches on the A-Frame and any exposed steel parts should be sanded, primed, and painted. Regular attention to these simple details will

maintain the attractive appearance of your trailer. It will also help increase the service life and resale value already inherent in your Wells Cargo trailer.

GENERAL APPEARANCE: Just like an automobile, your trailer's exterior skin will look better longer if washed regularly. Dirt, road salt, acid rain, and air pollution can cause unsightly stains. If caught early, stains can be cleaned with a mild detergent. If left unattended, stain removal may require a commercial grade cleaner; or worse cause permanent damage. Call the Wells Cargo Parts Department at 1-800-348-7553 for cleaner recommendations.

SNOW LOAD ON TRAILER

ROOF: Remove excess snow from the roof of your trailer. Units that sit for an extended period of time can accumulate an excessive amount of snow and ice. This can cause your roof to collapse.

SNOW MELT AND WATER

DAMAGE: Do not allow water to accumulate and pool inside trailer. (Example: snow melt off snowmobile.) Over time, this could cause interior floor damage and shorten the life of your trailer. Open the rear door(s) and "jack-up" the front of your trailer. This allows the water to drain out the rear.

12 VOLT ELECTRICAL SYSTEMS - 4, 6 & 7 CIRCUIT CONNECTORS

RACEWAY: Your Wells Cargo Trailer may be equipped with a two-piece, molded snap-a-part wiring Raceway mounted inside, at the roof line. The Power Cable enters the Raceway at the front wall, and supplies connection for all internal and external 12 Volt Lighting. There are NO under carriage splices or taps in the lighting circuits. If you wish to add other lighting in the future, all connections can be made within the snap-a-part Raceway.

TROUBLE SHOOTING: The Raceway provides easy access for trouble shooting should you develop any problems. Circuits can be individually connected or disconnected for testing purposes. Example: Should a Tail Light Fuse blow and continues to blow, disconnect all Brown wires from the Main Cable. Replace Fuse. Reconnect one Brown wire at a time until Fuse blows again. This last wire, then, is the problem. Disconnect it. Reconnect all other wires, and check for lights that are not lit. The problem will be a malfunctioning fixture, or a grounded wiring. Use the same procedure to trouble shoot any other circuit. Some trailer models are not equipped with the Raceway. Instead, they have a Junction Box located at the interior, road side rear. The main 12V power cable feeds through the road side Frame Rail and through the Rear Corner Post to the Junction Box. All distribution for 12V, interior and exterior lighting feeds through the Junction Box.

All checks and trouble shooting can be done at the Junction Box. There are no under carriage splices or taps.

A NOTE ABOUT WIRING YOUR TOW VEHICLE:

The electrical system for your trailer is protected by the circuit protection system in your tow vehicle. When "hot lines" are added for brakes and accessories, this wiring should be fused in the tow vehicle. Never use existing tow vehicle wiring for these lines. Run new wiring directly to the Plus (+) side of the tow vehicle battery. Never use circuit breakers for circuit protection when installing these lines. Use 12 gage wire (minimum) for both the brake and accessory wires. Do not exceed a 30 amp fuse on the brake line and a 20 amp fuse on the accessory line.

TOW VEHICLES (Foreign

makes): Most foreign made tow vehicles have amber turn signals with separate brake and turn signal wiring. In order for the trailer's lights to work properly, one must install a special tail light converter to the tow vehicle. This converter allows the different wiring configurations of the tow vehicle and trailer to be compatible. Most RV and trailer parts supply stores carry this special converter.



12 VOLT ELECTRICAL SYSTEMS - 4, 6 & 7 CIRCUIT CONNECTORS

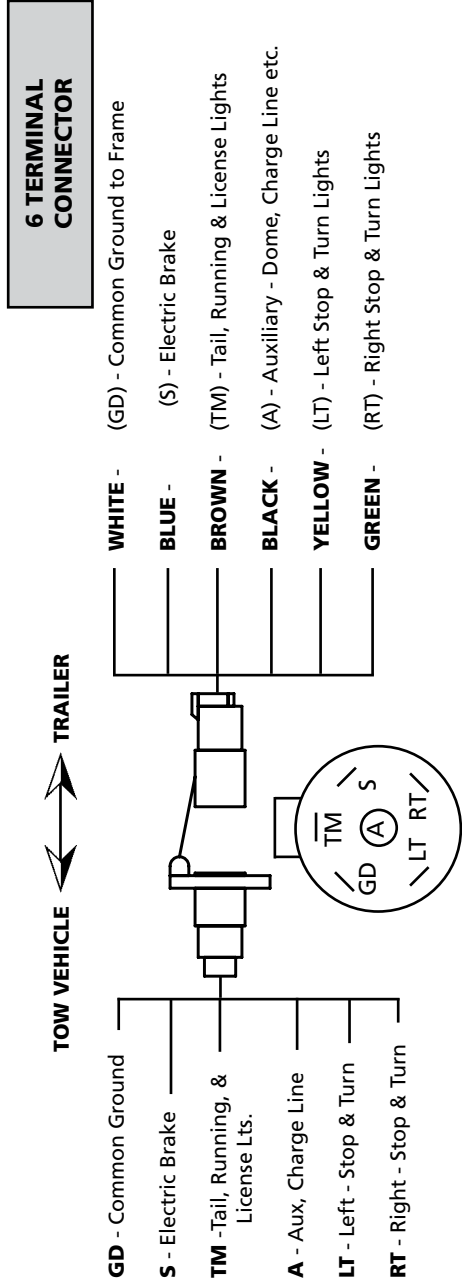
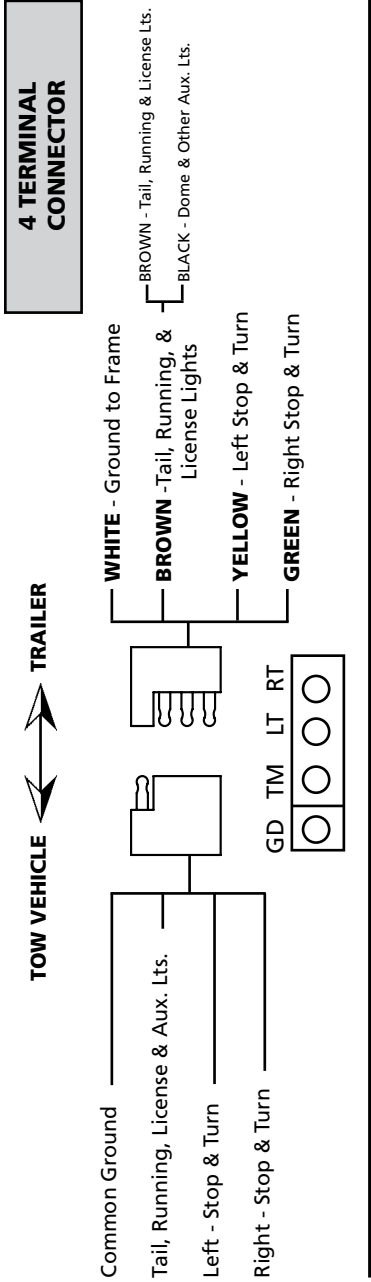

SAE WIRING CODE: The wire colors indicated above are according to this Code. Additional Code Colors: PURPLE - Optional, ORANGE - D.O.T. Breakaway (Wire running from Breakaway Switch thru Junction Box to D.O.T. Battery)

12 VOLT ELECTRICAL SYSTEMS - 4-6 & 7 CIRCUIT CONNECTORS

7 TERMINAL CONNECTOR

TOW VEHICLE ← → TRAILER

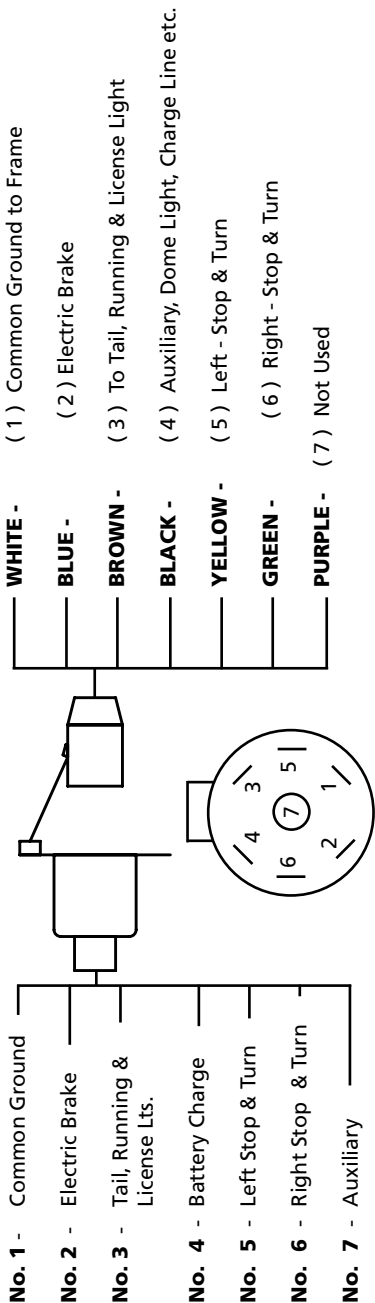

12 VOLT WIRING SYSTEM: All 12V Electrical Power is supplied from the tow vehicle to your trailer through one of the Circuit Connectors diagrammed at the left. All wiring is color coded according to SAE Code. The trailer half of the connector is attached to a flexible, jacketed Power Cable running to a Junction Box. (see upper, right hand illustration - Page 16). From the Junction Box, the Cable then runs through the road side frame channel.

CABLE WIRING CODE:
Yellow and Green - 18 gauge
Brown - 16 gauge
Black - 12 gauge

The Brake Line exits the Frame at the Axle, and connects to the Axle Wire via a water tight boot. Wire and boot are anchored to the Frame with Ring Clamp and Fastener.

WARNING: FOR TRAILERS WITH BREAKAWAY SYSTEM!
Tow vehicle *must* be equipped with a fused, 20 Amp Charge Line connected to Pin 4 of the trailer Connector.

PLUMBING

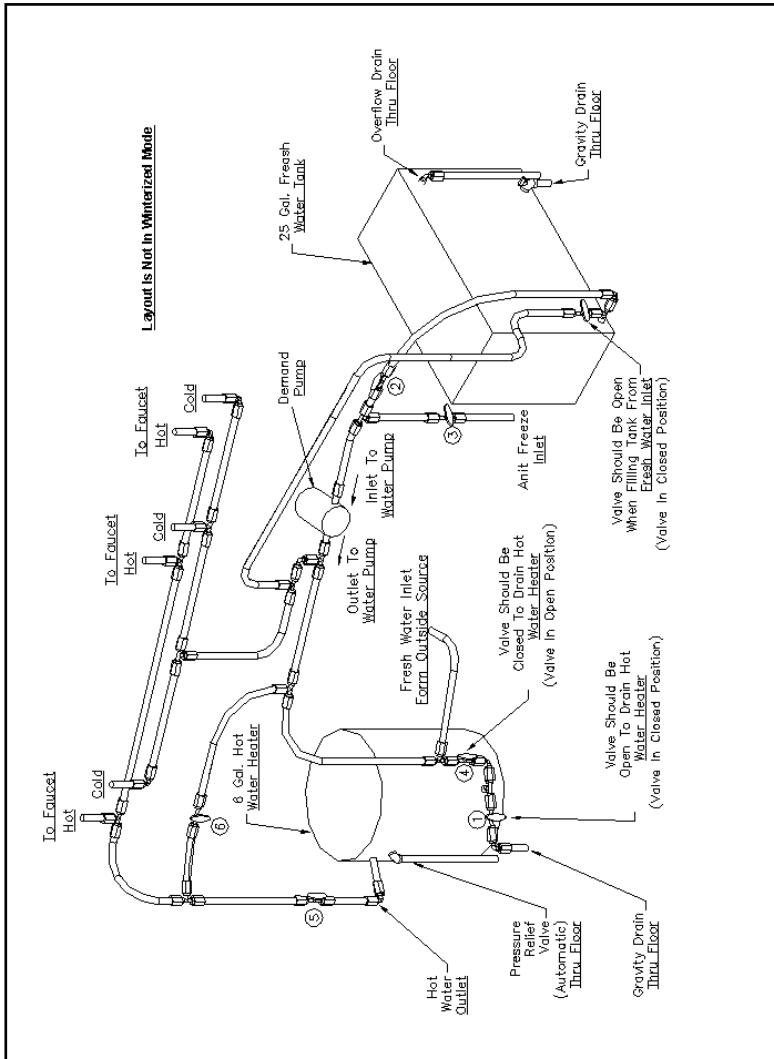

WINTERIZING PLUMBING: After draining the system, close all of the drain valves, except the one that drains the water heater. (See ①) Leave that one open. We have added five shut off valves to our water piping to accommodate RV Non-Toxic antifreeze. Two of the

valves are located on the suction side of the water pump. The first one disconnects the water storage tank. (See ②) It is normally open. Turn it off. The second valve on the suction side of the water pump opens the siphon tube (See ③) and can be opened up after the siphon tube is

MISC. INFORMATION

WINTERIZING PLUMBING (con't):

dipped into a gallon of RV Non-Toxic antifreeze. The other three valves are located right at the water heater and make it possible to leave the water heater full of air, while the hot and cold lines are filled with RV Non-Toxic antifreeze. Shut off the valve that fills the water heater with cold water. (See ④) Shut off the valve that is located on the hot water line off the water heater (See ⑤) Open the valve that joins the hot water lines and the cold water lines (See ⑥) This allows you to bypass the water heater and still fill both the hot and cold water lines. NOW YOU ARE READY. Slip the dip tube into a gallon of RV Non-Toxic antifreeze, with the valve open (See ③), and turn on the water pump. Open one faucet or toilet at a time until you see RV Non-Toxic antifreeze. When finished, the lines are full. Be sure to flush enough RV Non-Toxic antifreeze into the sinks so that the traps are protected as well.

SPECIALIZED PLUMBING: If you have a trailer with a specialized plumbing application, unlike the one shown on the previous page, these types of plumbing systems will need to be drained and winterized properly as well.

PROPER TRAILER LIFTING PROCESS:

Make sure that the trailer is properly blocked or the brakes are applied to prevent the trailer from moving while the trailer is being jacked up. A Torflex® Axle should have the lifting jack of proper capacity placed under the axle mounting bracket when lifting the trailer. A Sprung Axle should have the lifting jack of proper capacity placed as close to the axles hangers on the main frame when lifting the trailer. Lift unit only high enough to do the work required. When working under a trailer, make sure that the trailer is supported properly by using proper capacity jack stands. **CAUTION:** Failure to comply may result in serious injury or death. **CAUTION:** Be sure to wear safety glasses. Failure to comply may result in serious injury.

RAMP DOOR CAPACITY: Two weight ratings (capacities) have been established for standard ramp doors. Ratings do not apply to special built ramp doors or front ramp doors on "V-Front" trailers. Note: Corner Post Jacks should be in the down position when loading and unloading. See illustration below.

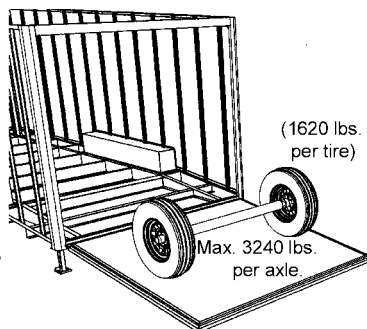
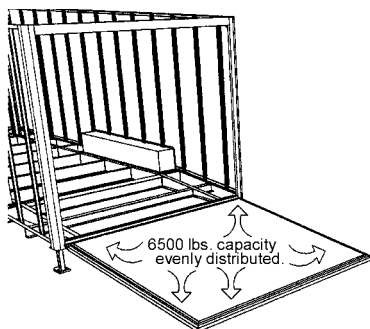



MISC. INFORMATION

TORSION SPRING ASSEMBLY:

Most* Wells Cargo brand trailer that features a ramp style door also includes a torsion spring assembly. The torsion spring assembly is designed to counterbalance the weight transferred when opening and closing the ramp door. This makes the ramp door easier and safer to operate. The torsion spring assembly is under a great amount of tension — especially in the open (or down) position. Do not use the wire cables as handrails. This puts added tension on the torsion spring assembly and increases the likelihood of a torsion spring assembly failure which could result in serious personal injury or death. Just like any other mechanical apparatus, the torsion spring assembly requires periodic inspection; and with repetitive use replacement. Industry standards state that one should consider replacing the entire spring assemble after 8,500 to 10,000 duty cycles. Opening and closing the door equals one (1) duty cycle. Inspection, repair, adjustment, and replacement of the torsion spring assembly must be performed by an experienced and qualified door service professional only. Never attempted to service or replace the torsion spring assembly yourself.

**There is an option to install a rear ramp door on 4' and 5' wide models without a torsion spring assembly. Most customers prefer (and we recommend) a torsion spring assembly on any size ramp door.*

SLIPPERY WHEN WET: Some styles of flooring (and ramp door decking material) may become slippery when wet. This includes, but not limited to, Aluminum Tread Plate, Steel Tread Plate, Linoleum, Painted, and Plastic. Please exercise caution on any wet floor.

ALUMASPORT ALUMINUM

WHEELS: The wheel's protective clear-coating may be permanently damaged by caustic material used in some car washes and by abrasives, chemicals, or steel wool. Use a mild soap and water solution to wash wheels. Rinse thoroughly with clean water and wipe dry. Use of any harsh or acid-based products will void all warranty claims.

MISC. INFORMATION

E-TRACK: The following warnings have been provided by the E-Track manufacturer to assure proper and safe usage.

 *Webbing straps must be protected when used on rough or sharp objects. Straps that are cut, worn or damaged shall not be used and shall be replaced immediately. All strap assemblies shall be inspected prior to each use.*

 *The use of cheater bars (extenders) or other means of increasing leverage on a ratchet buckle handle or winch, other than a manufacturer approved device, can cause serious injury to the user and/or bystanders.*

 *When "Series F" bars are used in the vertical position, the spring end of the bar must be up to avoid bouncing out of the track. Shoring bars shall not be used in decking applications, unless otherwise specified.*

 *Cargo bars are not intended for use with cargo on wheels. Overtensioning of ratchet mechanism may cause damage to trailer sidewalls. NOTE: Cargo bars do not have load ratings due to varying conditions of trailer sidewalls.*

 *Do not overload or create a top-heavy, unstable trailer.*

 *Welding galvanized material may create toxic fumes. Welding shall be done with adequate ventilation.*

 *E-Track and related accessories may be subjected to dirt, mud, snow, ice, road salt, cleaning solution, etc., and therefore require inspection, cleaning, and lubricating to ensure that they are in proper operating condition.*

 *It is the owner's responsibility to evaluate the suitability of any cargo securing product for their particular application. Failure to comply with recommended usage guidelines may result in personal injury or cargo damage.*



TIRE SAFETY INFORMATION



TIRE AND LOADING INFORMATION

THE WEIGHT OF THE CARGO SHOULD NEVER EXCEED 667 KG 1470 LB

TIRE	SIZE	COLD TIRE PRESSURE	SEE OWNER'S MANUAL FOR ADDITIONAL INFORMATION <small>FD-320</small>
FRONT	ST205/75RR15	345 KPA or 50 PSI	
REAR			
SPARE			

1HC200G1761114312

TIRE SAFETY INFORMATION (For trailers with a GVWR of 10,000 lbs. or less):

- 1) Locate the statement "The weight of cargo should never exceed XXX kg. Or XXX lbs.," on your vehicle's placard. (See placard above.)
- 2) This figure equals the available amount of cargo and luggage capacity.
- 3) Determine the combined weight of cargo being loaded on the vehicle. That weight may not safely exceed the available cargo capacity calculated in Step #2.

GLOSSARY OF TIRE TERMINOLOGY:

Bias ply tire

A pneumatic tire in which the ply cords that extend to the beads are laid at alternate angles substantially less than 90 degrees to the centerline of the tread.

Cold inflation pressure

The pressure in the tire before you drive.

Curb weight

The empty weight of the trailer.

Gross Vehicle Weight Rating

The maximum weight of the fully loaded trailer, as published on the Certification / VIN label. Actual weight determined by weighing trailer on a public scale, without being attached to the towing vehicle.



TIRE SAFETY INFORMATION

Hitch Weight

The downward force exerted on the hitch ball by the trailer coupler.

Light truck (LT) tire

A tire designated by its manufacturer as primarily intended for use on lightweight trucks or multipurpose passenger vehicles.

Maximum load rating

The load rating for a tire at the maximum permissible inflation pressure for that tire.

Maximum permissible inflation pressure

The maximum cold inflation pressure to which a tire may be inflated.

Maximum loaded vehicle weight

The sum of curb weight, accessory weight, vehicle capacity weight, and production options weight.

Outer diameter

The overall diameter of an inflated new tire.

Overall width

The linear distance between the exteriors of the sidewalls of an inflated tire, including elevations due to labeling, decorations, or protective bands or ribs.

Ply

A layer of rubber-coated parallel cords.

Radial ply tire

A pneumatic tire in which the ply cords that extend to the beads are laid at substantially 90 degrees to the centerline of the tread.

Recommended inflation pressure

This is the inflation pressure provided by the vehicle manufacturer on the Tire Information label and on the Certification / VIN tag.

Rim

A metal support for a tire or a tire and tube assembly upon which the tire beads are seated.

Rim diameter

This means the nominal diameter of the bead seat.



TIRE SAFETY INFORMATION

Rim width

This means the nominal distance between rim flanges.

Sidewall

That portion of a tire between the tread and bead.

Special Trailer (ST) tire

The "ST" is an indication the tire is for trailer use only.

Tread

That portion of a tire that comes into contact with the road.

Treadwear indicators (TWI)

The projections within the principal grooves designed to give a visual indication of the degrees of wear of the tread.

TIRE SAFETY – EVERYTHING RIDES ON IT

The National Traffic Safety Administration (NHTSA) has published a brochure (DOT HS 809 361) that discusses all aspects of Tire Safety, as required by CFR 575.6. It can be obtained and downloaded from NHTSA, free of charge, from the following web site:

[http://www.nhtsa.dot.gov/cars/rules/TireSafety/ridesonit/tires_index.html]



6 PLANTS WITH SERVICE FACILITIES

Toll-free: (800) 348-7553 Web: www.wellscargo.com



ELKHART, INDIANA

Corporate Offices
1503 W. McNaughton St.
PO Box 728
Elkhart, IN 46515
Phone: (574) 264-9661
Fax: (574) 264-5938



WAYCROSS, GEORGIA

South Division
2250 Industrial Blvd.
PO Box 1318
Waycross, GA 31502
Phone: (912) 285-8132
Fax: (912) 287-0018



WACO, TEXAS

Texas Division
600 Texas Central Parkway
PO Box 7128
Waco, TX 76714
Phone: (254) 772-1740
Fax: (254) 772-7673



OGDEN, UTAH

Wells Industries, Inc. (Subsidiary)
1741 W 2550 S
PO Box 1619
Ogden, UT 84402
Phone: (801) 621-3637
Fax: (801) 392-5443



PHOENIX, ARIZONA

Arizona Division
6902 West Hadley St.
Phoenix, AZ 85043
Phone: (623) 936-8150
Fax: (623) 936-5808



McADOO, PENNSYLVANIA

Pennsylvania Division
6 Banks Ave.
McAdoo, PA 18237
Phone: (570) 282-3726
Fax: (570) 929-2141

