



Owner's Manual

MOVANO

Operation, Safety and Maintenance



MOVANO

VAUXHALL Movano

Operation, Safety, Maintenance

Data specific to your vehicle

Please enter your vehicle's data here to keep it easily accessible.

This information is available under the section "Technical data" as well as on the identification plate and in the Service Booklet.

Fuel

Designation

Engine oil

Grade

Viscosity

Tyre inflation pressure

Tyre size
Summer tyres

Winter tyres

with full load

Front Rear

Front Rear

Weights

Permissible Gross Vehicle Weight

- EC kerbweight

= Loading

Your Movano

is an intelligent combination of forward-looking technology, impressive safety, environmental friendliness and economy.

It now lies with you to drive your vehicle safely and ensure that it performs perfectly. This Owner's Manual provides you with all the necessary information to that end.

Make sure your passengers are aware of the possible risk of accident and injury which may result from improper use of the vehicle.

You must always comply with the specific laws of the country that you are travelling through. These laws may differ from the information in this Owner's Manual.

When this Manual refers to a workshop visit, we recommend your Vauxhall Authorised Repairer.

All Vauxhall Authorised Repairers provide first-class service at reasonable prices.

You will receive quick, reliable and individual service.

Experienced mechanics, trained by Vauxhall, work according to specific Vauxhall instructions.

The Owner's Manual should always be kept in the vehicle: Ready to hand in the glove compartment.

Make use of the Owner's Manual:

- The "In Brief" section will give you an initial overview.
- The table of contents at the beginning of the owner's manual and within the individual chapters will show you where everything is.
- Its index will help you find what you want.
- It will familiarise you with the sophisticated technology.
- It will increase your pleasure in your vehicle.
- It will help you to handle your vehicle expertly.

The Owner's Manual is designed to be clearly laid-out and easily understood.

This symbol signifies:

► Continue reading on next page.

✱ Items marked with an asterisk are not fitted to all vehicles (model variants, engine options, models specific to one country, optional equipment, Genuine Vauxhall Parts and Accessories).

Warning

Text marked  **Warning** provides information on risk of accident or injury. Disregard of the instructions may lead to injuries or endanger life. Inform your passengers accordingly.

Yellow arrows in the illustrations serve as points of reference or indicate some action to be performed.

Black arrows in the illustrations indicate a reaction or a second action to be performed.

Directional data, e.g. left or right, or front or back, in the descriptions always relate to the direction of travel.

Thank you for choosing a Vauxhall. We wish you many hours of pleasurable driving

Your Vauxhall Team

Contents

Commitment to customer satisfaction:

Our aim: to keep you happy with your vehicle. All Vauxhall Authorised Repairers offer first class service at competitive prices. Experienced, factory-trained technicians work according to factory instructions. Your Authorised Repairer can supply you with GENUINE VAUXHALL-APPROVED PARTS, which have undergone stringent quality and precision checks, and of course useful and attractive VAUXHALL-APPROVED ACCESSORIES.

Our name is your guarantee!

For details of the

Vauxhall Authorised Repairer Network please ring this number; 0845 090 2044

| | |
|---|-----|
| In brief | 2 |
| Instruments | 18 |
| Keys, doors, bonnet | 29 |
| Seats, interior | 40 |
| Safety systems | 48 |
| Lighting | 62 |
| Windows..... | 67 |
| Heating, ventilation | 71 |
| Tecshift..... | 80 |
| Driving hints..... | 86 |
| Save fuel, protect the environment | 88 |
| Fuel consumption, fuel, refuelling..... | 90 |
| Catalytic converter, exhaust emissions .. | 92 |
| Drive Control Systems | 96 |
| Chassis systems..... | 98 |
| Brakes..... | 103 |
| Wheels, tyres..... | 107 |
| Roof rack, caravan and trailer towing | 112 |
| Self-help | 115 |
| If you have a problem | 134 |
| Service plan, maintenance | 136 |
| Vehicle care | 147 |
| Technical data | 152 |
| Index..... | 168 |

In brief

Key numbers, Code numbers

Remove key number from key.

The key number is given in the vehicle documents and in the Car Pass ✳.

Electronic immobiliser, radio ✳:

The code numbers are given in the Car Pass and Radio Pass respectively.

Do not keep the Car Pass and Radio Pass in the vehicle.

► Further information - see pages 29, 30.



Unlocking the vehicle: Direct remote control unit towards vehicle, press button , pull door handle

To unlock mechanically:
Insert key and turn in driver's door lock and pull door handle.

To lock doors from inside:
Press central locking button located on the overhead console.

► Door locks - see page 29,
electronic immobiliser - see page 30,
remote control - see page 31,
central locking system - see page 33,
Vauxhall alarm system ✳ - see page 35.



Seat adjustment: Pull handle, slide seat, release handle, allow seat to audibly latch into position

Never adjust the driver's seat whilst driving.
It could move in an uncontrolled manner
when the handle has been pulled.



Adjusting the front seat backrest: Push release lever

Move seat backrest to suit seating position, it will lock in position when the lever is released.

Warning

Important: Do not sit nearer than 10 inches (25 cm) from the steering wheel, to permit safe airbag deployment.

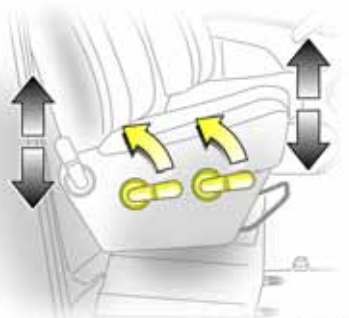

Adjusting the front seat height: Pull up lever, adjust seat, release lever, lock seat into position

Front lever: Adjusts front of seat

Rear lever: Adjusts rear of seat



Driver's seat armrest

Armrest can be lowered from upright position for added comfort. Return armrest to upright position when not required.

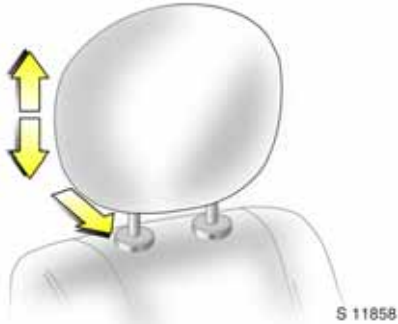

Adjusting head restraint height:
Hold firmly,
raise to adjust height,
press tab to release when
lowering

► Head restraint position – see page 40,
further information - see page 41.



Seat belt:
Draw smoothly from inertia reel,
guide over the shoulder and
engage in buckle

The belt must not be twisted at any point.
The lap belt must fit snugly across the
body. The seat backrest must not be
inclined too far back.

To release belt, press red button on belt
buckle.

► Seat belts - see pages 49 to 50,
airbag system - see page 52,
seat position - see page 40.

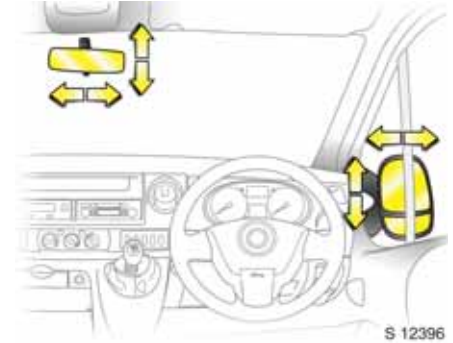

**Adjust interior and exterior
mirrors:**
Swivel to appropriate position

Move lever on underside of interior mirror
housing to reduce dazzle at night.

► Further information - see page 61.



Electrically adjustable exterior mirrors ✳:

Switch in driver's door

Only operational with the ignition on.

Turn switch to left:
switch operates left-hand mirror.

Turn switch to right:
switch operates right-hand mirror.

Switch in central position:
mirror adjustment is off.

The lower aspherical mirrors can be adjusted manually.



Starter switch:

- St = Ignition off
- A = Steering unlocked, ignition off
- M = Ignition on: preheat (see page 14)
- D = Start (transmission in neutral)

► Electronic immobiliser - see page 30.



Releasing the steering column lock:

Move steering wheel slightly, turn key to position 'A'

► Remove key and engage steering column lock - see page 16.

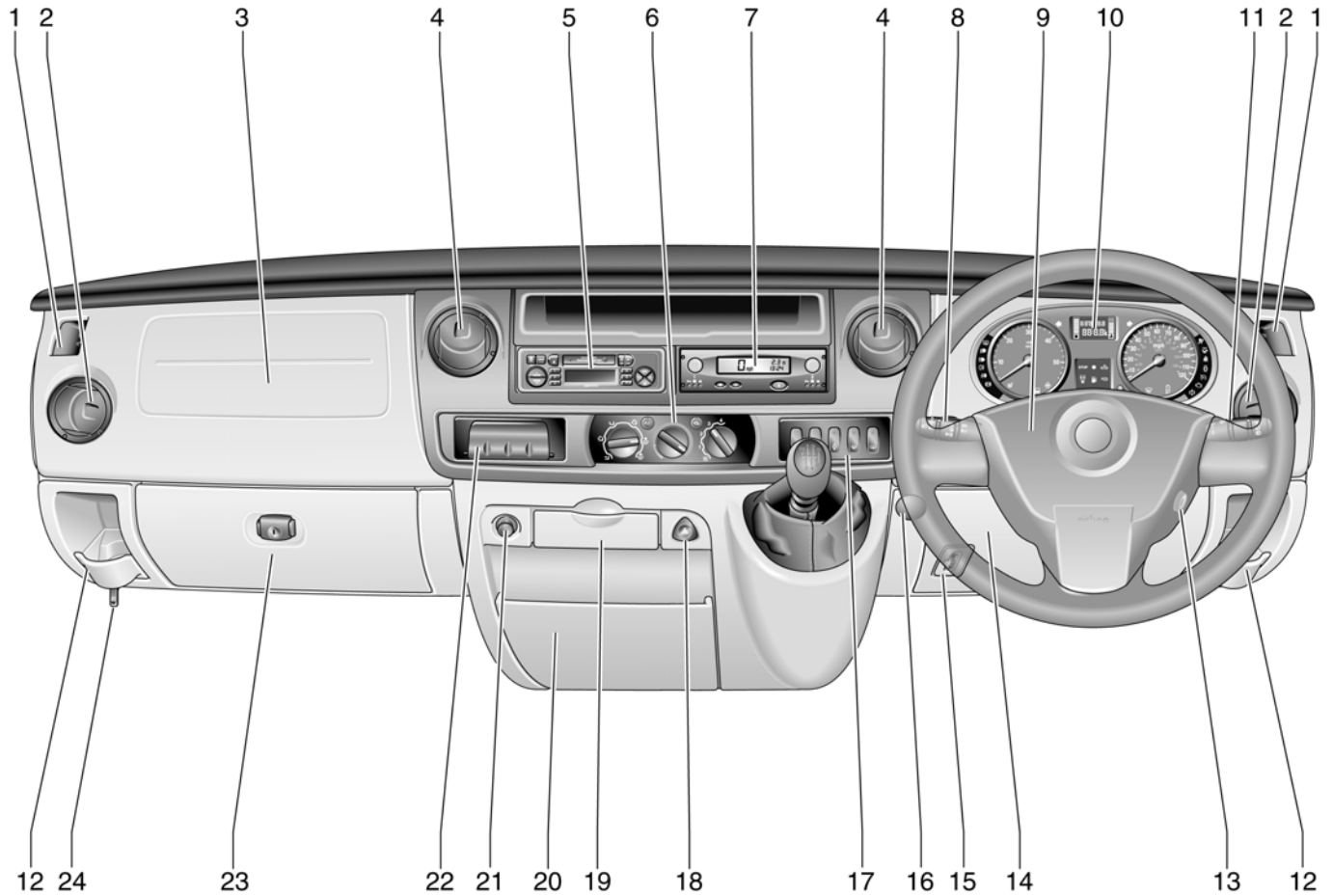





















| | Page |
|---|------------|
| 1 Door window defrosters | 73 |
| 2 Side air vents | 73 |
| 3 Passenger's airbag * or storage area | 52 |
| 4 Centre air vents | 72 |
| 5 Radio / Infotainment system * | 27 |
| 6 Heating and ventilation controls | 71 |
| 7 Electronic tachograph * | 27 |
| 8 Stalk for driving lights, headlight flash, front fog lights, fog tail light, dipped and main beam | 10 |
| turn signals | 11 |
| horn | 11 |
| 9 Driver's airbag | 52 |
| 10 Instruments | 18, 22, 23 |

| | Page |
|---|--------|
| 11 Stalk for windscreen wiper, automatic wiper with rain sensor *, windscreen wash system, headlight wash system * | 12 |
| 12 Drink holder or storage area | |
| 13 Starter switch | 5 |
| 14 Instrument panel fusebox | 127 |
| 15 Headlight range adjustment * | 64 |
| 16 Battery isolation switch * | 126 |
| 17 Switches for heated rear windows | 15 |
| air suspension * | 98 |
| cruise control * | 99 |
| speed limiter * | 100 |
| Winter and Laden programme with Tecshift * | 82, 83 |
| rear seating compartment lights * | 65 |
| ESP * (Electronic Stability Programme) | 96 |

| | Page |
|--|------|
| 18 Hazard warning switch | 11 |
| 19 Ashtray | 45 |
| 20 Document holder | 47 |
| 21 Cigarette lighter | 44 |
| 22 Note pad clip * | 47 |
| rear door lock isolation switch * | 38 |
| rear seating compartment lights * | 65 |
| 23 Glove compartment | |
| 24 Bonnet release lever | 39 |

Control indicators

-  **Airbag system:**
see page 52.
-  **Fog tail light:**
see pages 10, 63.
-  **Front fog lights *:**
see page 63.
-  **Heated front seats *:**
see pages 18, 79.
-  **Anti-lock Brake System (ABS):**
see page 106.
-  **Diesel particle filter *:**
see pages 18, 93.
-  **Exhaust emissions *:**
see pages 20, 93.
-  **Cruise control, speed limiter *:**
see page 100.
-  **Rear door lock isolator *:**
see page 38.
-  Not used
-  **Stop engine:**
see page 19.

-  **Electronic immobiliser:**
see pages 19, 30.
-  **Service / engine electronics *:**
see pages 19, 93.
-  **Turn signals:**
see pages 11, 19.
-  **Fuel level:**
see pages 19, 91, 154.
-  **Oil pressure:**
see page 20.
-  **Engine electronics / Preheating system / Diesel fuel filter:**
see pages 14, 19.
-  **Engine stop:**
see page 19.
-  **Alternator:**
see page 20.
-  **Brake system:**
see pages 20, 105, 142.
-  **ESP (Electronic Stability Programme) *:**
see page 96.

-  **Driver's seat belt *:**
see pages 20, 48.

 Not used

-  **Headlight main beam:**
see pages 10, 62.

-  **Headlight dipped beam:**
see pages 10, 62.

-  **Air suspension: Fault *:**
see page 20.

-  **Electric side step *:**
see page 37.

-  **Engine oil life monitor *:**
see page 94.

Windscreen wiper

Stalk positions:
see page 12,

-  Timed interval wipe or automatic wiping with rain sensor *

1 Slow

2 Fast

-  Windscreen wash and headlight wash *

Lighting - see pages 10, 62.

 **Light switch off position**

 **Parking lights**

 **Headlight dipped beam**

 **Headlight main beam**

 **Fog tail light**

 **Front fog lights ***

 **Turn signals:**
see pages 11, 19.

 **Hazard warning lights:**
see pages 11, 63.

 **Headlight range adjustment *:**
see page 64.

 **Interior light:**
see page 64.

 **Reading light:**
see page 65.

Heating and ventilation

 **Fan switch:**
see page 72.

Air distribution:
see page 71,

 to head area.

 to head area and footwell

 to footwell

 to windscreen, front door windows
and to footwell

 to demist windscreen
and front door windows

 to defrost windscreen
and front door windows

 **Heated rear windows *,
heated exterior mirrors *:**
see pages 15, 75.

AC **Air conditioning system *:**
see page 75.

 **Air recirculation button:**
see page 76.

 **Heated seats *:**
see pages 18, 79.

Tecshift *

 **Winter programme:**
see page 82.

kg **Laden programme:**
see page 83.

 **Transmission electronics:**
see page 85.

 **Footbrake application:**
see page 80.

A **Automatic mode:**
see page 81.

Miscellaneous

 **Horn:**
see page 11.

 **Bonnet:**
see page 39.

 **Central locking:**
see page 34.

 **Cigarette lighter *:**
see page 44.

 **First-aid kit *:**
see page 119.

 **Warning triangle *:**
see page 119.



Light switch:

0 = Off

☼ = Parking lights

☼D = Dipped or main beam

- ▶ Headlight warning device - see page 16,
- Further information - see page 62,
- Automatic dipped beam activation * - see page 63,
- headlight range adjustment - see page 62,
- headlights when driving abroad - see page 66.

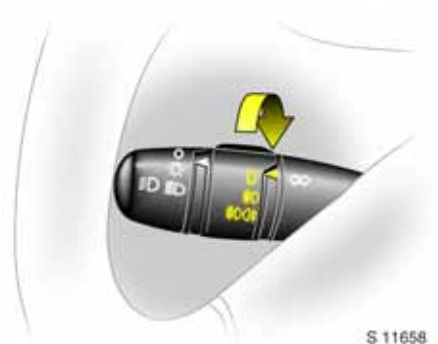

Fog lights:

0 = Off

☼ = On (fog tail light only)

☼D☼ = On (front fog lights * and fog tail light)

The fog tail lights will only illuminate when the headlights and ignition are switched on.

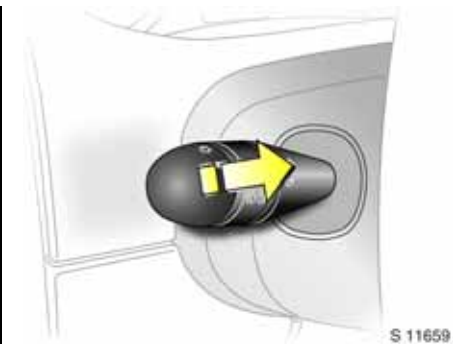

Dipped and main beam,

Headlight flash:

Pull stalk towards steering wheel

To change the headlight beam, pull the stalk towards the steering wheel, then release when a click is felt.

Pulling the stalk towards the steering wheel to the first stop operates the headlight flash.

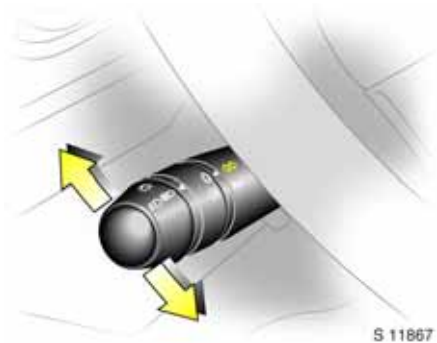

Turn signals:

Stalk in rest position

Upwards = Right turn

Downwards = Left turn

When the steering wheel is turned back, the stalk automatically returns to its original position. This will not happen when making a minor steering manoeuvre such as lane changing.

When lane changing, move stalk part way to first stop. When released, the stalk will spring back.

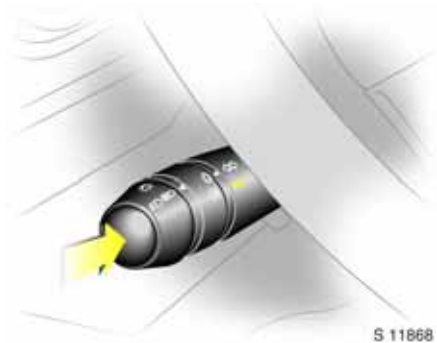

Horn:

Press button 

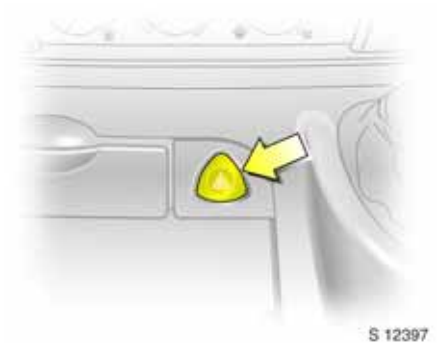

Hazard warning lights:

On = Press button 

Off = Press button  again

When the hazard warning system is actuated, the button's control indicators flash in unison with the hazard warning lights.



S 11870

Windscreen wiper:

Move stalk downwards

= Timed interval wipe

1 = Slow

2 = Fast

Return the stalk to its original position to switch off.

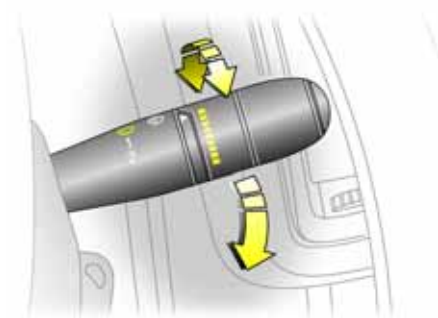

S 13400

Automatic wiping with

rain sensor :

Move stalk downwards

= Automatic wiping with rain sensor

1 = Slow

2 = Fast

The rain sensor detects the amount of water on the windscreen and automatically regulates the windscreen wiper frequency. The sensitivity of the system can be adjusted by rotating the variable wipe:

Less sensitive = rotate down

More sensitive = rotate up

Upon starting the engine, automatic wiping will need to be reselected.

► Further information - see pages 143, 148.

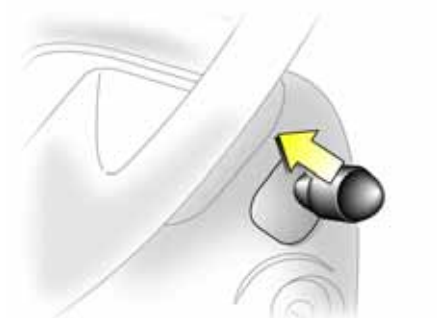

S 11871

Windscreen wash system and

headlight wash system :

Pull stalk towards steering wheel

Wash fluid is sprayed onto the windscreen (and - when the lights are on - onto the headlights); at the same time, the wiper is operated for several cycles.

Check regularly that the headlight wash system is operating efficiently.

On vehicles fitted with rain sensor , it is important to keep the sensor area clean by operating the wash system regularly.

► Further information - see pages 143, 144.

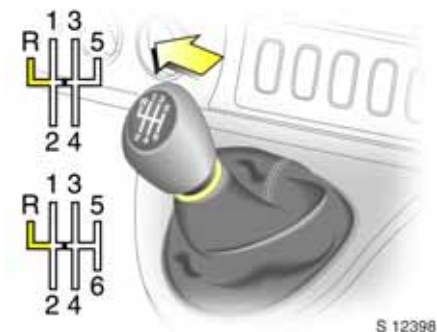

Manual transmission:

- = Neutral
- 1 to 5/6 = 1st to 5th / 6th* gear
- R = Reverse gear

When shifting up from 4th to 5th gear, pressure must be exerted towards the right at the beginning of the shift operation.

When shifting from 5th to 4th gear, do not exert any force towards the left.

Reverse gear:

With vehicle stationary, depress clutch pedal, pull up collar* on gearshift lever and move lever against resistance to engage reverse gear.

If the gear does not engage:

With gearshift lever in neutral, release clutch pedal and depress again, then repeat gear selection.

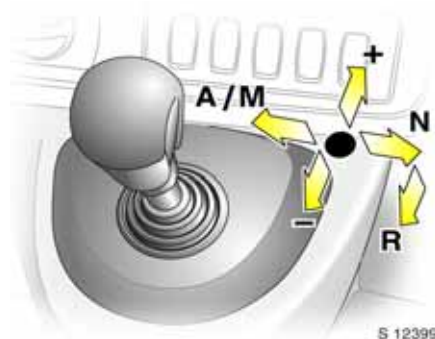

Tecshift*:

- N = Neutral
- = Centre position
- = Shift to lower gear
- + = Shift to higher gear
- A/M = Switch between Automatic mode and Manual mode
- R = Reverse

The selector lever must be moved in the appropriate direction as far as it will go. Upon release, it automatically returns to the centre position. Pay heed to the gear / mode indicator in the transmission display.

► Further information - see page 80.

Before driving, check:

- Tyre inflation pressures and condition.
- Engine oil level and fluid levels in engine compartment (see pages 137 to 138).
- All windows, mirrors, exterior lighting and number plates are free from dirt, snow and ice and are operational.
- Objects are securely located and will not be thrown forwards in the event of sudden braking.
- No objects are placed on the instrument panel or in the area in which the airbags inflate.
- Seats, seat belts and mirrors are correctly adjusted.
- Brake operation.

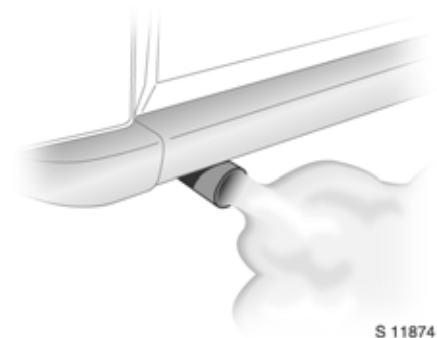

S 11874

Exhaust gases are poisonous

Exhaust gases contain carbon monoxide, which is extremely poisonous but has no odour or colour.

Therefore, never inhale exhaust gases, and never run the engine in an enclosed space.

You should also avoid driving with the doors open, as exhaust gases could enter the passenger compartment.

► Exhaust gases - see page 92.

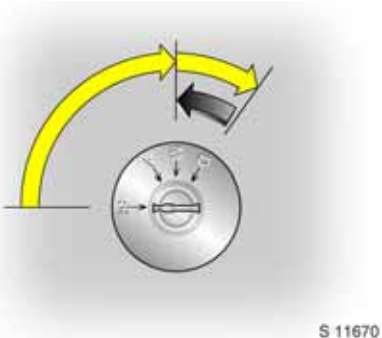

S 11670

Starting the engine:
Transmission in neutral,
Depress clutch pedal,
Do not accelerate,
Turn key to M,
Wait until preheating control
indicator  goes out¹⁾,
turn key to D

► Electronic immobiliser - see page 30,
 further information - see pages 80, 88.

¹⁾ Preheating system switches on only if outside temperature is low.

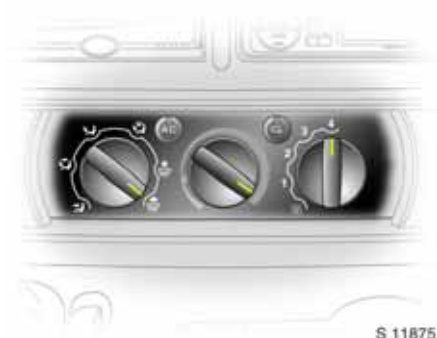

S 11875

Demisting windows:
Set the temperature rotary knob
to red and fan to position 4,
set air distribution to  ²⁾

Close centre air vents; open side air vents and direct them towards the door windows.

► Heating, ventilation - see page 71,
 air conditioning system - see page 75.

²⁾ Air recirculation feature not possible when position selected. On vehicles equipped with air conditioning , the air conditioning is automatically activated when position selected.



S 11876

Defrosting windows:
Set the temperature rotary knob to red and fan to position 4, set air distribution to

Close centre air vents; open side air vents and direct them towards the door windows.

► Heating, ventilation - see page 71,
air conditioning system - see page 75.



S 12400

**Heated rear windows *,
heated exterior mirrors *:**
Press = On
Press again = Off

► Further information - see page 75.



S 12401

Releasing the handbrake:
Raise lever slightly,
press lock button,
lower lever fully

Drive carefully, economically and with the environment in mind. While driving, do not do anything that could distract you.

► Handbrake - see page 104.

Warning buzzers

While driving:

- when operating the turn signals.
- when switching cruise control * on and off.
- during illumination of low fuel control indicator.
- with Tecshift *, at high clutch temperatures.
- when driver's seat belt is not fastened *.

When the vehicle is parked and driver's door is opened:

- when headlights are switched on.
 - with Tecshift *, when neutral is not selected, footbrake is not depressed or handbrake is not applied.
- Driving hints - see page 86,
Save fuel, protect the environment - see page 88.

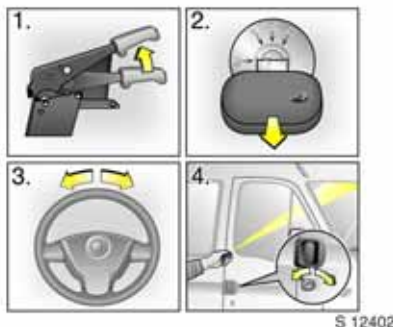

**Parking the vehicle:
Apply handbrake firmly,
Close windows,
Switch off engine,
Remove key,
Engage steering column lock,
Lock doors**

► Further information - see pages 30, 87,
remote control - see page 31,
central locking system - see page 33,
Vauxhall alarm system * - see page 35.

When parking:

- Always apply handbrake firmly. Engage first gear or reverse gear. On slopes apply the handbrake as far as it will go.
- Turn steering wheel until lock is felt to engage (anti-theft protection).
- Switch off exterior lights, otherwise the headlight warning device will sound when the driver's door is opened.
- Cooling fans may run on after the engine has been switched off.
- Do not park vehicle on easily ignitable surfaces as the hot exhaust system temperatures could cause the surface to ignite.

Service work, Maintenance

We recommend that you entrust all work to your Vauxhall Authorised Repairer, who can provide you with reliable service and correctly perform all work according to factory instructions.

If you have a problem - see page 134.

Genuine Vauxhall Parts and Accessories

We recommend the use of "Genuine Vauxhall Parts and Accessories" and conversion parts released expressly for your vehicle type. These parts have undergone special tests to establish their reliability, safety and specific suitability for your vehicle. Despite continuous market monitoring, we cannot assess or guarantee these attributes for other products, even if they have been granted approval by the relevant authorities or in some other form.

"Genuine Vauxhall Parts and Accessories" and conversion parts approved by Vauxhall can be obtained from your Vauxhall Authorised Repairer. You will be given advice about permitted technical changes and correct installation will take place.

Warning

Carry out regularly the checks recommended in this Owner's Manual.

Ensure that your vehicle is serviced at the service intervals specified in the Service Booklet. We recommend that you entrust this work to your Vauxhall Authorised Repairer.

Have faults remedied without delay! Consult a workshop. We recommend your Vauxhall Authorised Repairer. If necessary, interrupt your journey.

► Maintenance - see pages 136 to 146.

That was a brief overview of the most important information for your first drive in your Movano.

Your vehicle has still more instruments and controls, possibly also optional equipment.

The remaining chapters of the Owner's Manual contain important information on operation, safety and maintenance as well as a complete index.

Instruments

Control indicators 18
 Tachometer..... 21
 Speedometer..... 21
 Fuel gauge 21
 Coolant temperature gauge..... 22
 Multi-function display 22
 Oil level display *..... 23
 Trip computer * 24
 Engine oil life monitor *..... 27
 Radio *..... 27
 Electronic tachograph *..... 27
 Navigation system *..... 28
 Mobile telephones and radio
 equipment (CB) * 28



S 13643

Control indicators

The control indicators described here are not present in all vehicles. The descriptions however, apply to all instrument versions.



Heated rear windows *,
heated exterior mirrors *
 see pages 15, 75.



Headlight dipped beam
 Illuminates when dipped beam is on.



Headlight main beam
 Illuminates when main beam is on and
 when headlight flash is operated.



Fog tail light
 Illuminates when fog tail light is switched
 on.



Front fog lights *
 Illuminates when front fog lights are
 switched on.



Anti-lock Brake System (ABS)
 see page 105.



Diesel particle filter *
 Illuminates when regeneration of diesel
 particle filter is required - see page 93.



Heated front seats *
 Illuminates when seat heating system is
 switched on.

**Electric side step ***

Illuminates when electric side step is activated by operating sliding side door. If illuminated continuously it indicates a fault. Consult a workshop.

**ESP (Electronic Stability Programme) ***

see page 96.

**Engine oil life monitor ***

see page 94.

**Turn signals**

Flashes when turn signals are on. If they flash rapidly: a turn signal bulb has failed.

**Tecshift, Laden programme ***

Control indicator illuminates in transmission display when Laden programme is enabled - see page 83.

**Tecshift, footbrake application ***

see page 80.

**Tecshift, transmission electronics ***

Control indicator illuminates in transmission display when fault has occurred - see page 85.





**Tecshift, Automatic mode ***

Control indicator illuminates in transmission display when Automatic mode is selected - see page 81.

**Tecshift, Winter programme ***

Control indicator illuminates in transmission display when Winter programme is enabled - see page 82.

STOP**Stop engine**

If  illuminates in conjunction with either , , or , stop engine as soon as possible without impeding other vehicles and consult a workshop.

**Electronic immobiliser**

If it flashes when the ignition is on, there is a fault in the immobiliser system; the engine cannot be started - see page 30.

**Service / engine electronics ***

If it illuminates while driving, interrupt your journey. If illuminated in conjunction with another control indicator, observe this also. Consult a workshop.

Further information - see page 93.

**Engine electronics / Preheating system / Diesel fuel filter**

Illuminates briefly during engine preheating. If illuminated continuously it indicates:

- The presence of water in the diesel fuel filter. Drain diesel fuel filter of residual water - see page 140.
- An electronic system failure or the presence of water in the diesel fuel filter. Consult a workshop.

**Fuel level**

If it illuminates: fuel level low, fill up.

Never let the tank become empty!

To start the engine after the tank has been run empty, the fuel system must be bled - see page 115.

**Engine stop**

Illuminates in conjunction with control indicator  (stop engine) if coolant temperature is too high. Stop vehicle and consult a workshop.



Alternator

Illuminates when ignition is switched on. Goes out after engine is started.

If illuminated during driving: Stop vehicle and switch off engine. The battery is not being charged and the engine cooling may be interrupted. The brake servo unit may cease to be effective. Interrupt your journey and check drive belt condition and tensioning before consulting a workshop.



Oil pressure

Illuminates when ignition is switched on. Goes out after engine is started.

If illuminated during driving: Engine lubrication may be interrupted, resulting in damage to the engine and/or locking of the driving wheels:

- Move out of the flow of traffic as quickly as possible without impeding other vehicles.
- Depress clutch.
- Move gearshift lever to neutral.
- Switch off ignition (to position A).

Warning

When the engine is off, considerably greater force will be required for braking and steering.

Do not remove key until vehicle has come to a standstill, otherwise the steering column lock could engage unexpectedly.

Check oil level before consulting a workshop.



Brake system

Illuminates when ignition is switched on if handbrake is applied and/or fluid level for brake hydraulics is too low.

Warning

If it illuminates when the handbrake is not applied: stop vehicle; interrupt your journey immediately and consult a workshop.

Further information - see page 103.



Rear door lock isolator *

see page 38.



Airbag system

see page 52.



Not used



Driver's seat belt *

Illuminates when ignition is switched on to remind driver to engage seat belt. Seat belts - see page 48.



Not used



Cruise control, speed limiter *

see page 100.



Exhaust emissions *

If it illuminates, there is a fault in the emission control system. The permitted emission limits may be exceeded. Consult a workshop.

For faults that can lead to destruction of the catalytic converter - see page 92. Consult a workshop immediately.



Air suspension: Fault *

Illuminates when a fault has occurred in the air suspension system. Consult a workshop.



Tachometer

Making use of the tachometer helps to save fuel; it indicates the engine speed.

Warning zone on right:
Maximum permissible engine speed exceeded, danger to engine.

If possible, drive in each gear in the low engine speed range (between approx. 2000 and 3000 rpm) and maintain an even vehicle speed.

Start-up limiter *

To reduce the risk of engine damage on certain models, engine rpm will be limited when starting.



Speedometer

Indicates the vehicle speed.

Certain vehicle variants feature a speed regulator *¹⁾ which restricts the vehicle's maximum speed. As a visible indication of this, a warning label is located on the instrument panel.

Vehicles with cruise control may feature a speed limiter *¹⁾ (which enables a variable maximum vehicle speed to be set) - see page 100.

¹⁾ Depending on driving environment (e.g. when descending steep inclines), the vehicle speed can exceed set limits. In such instances, it remains the driver's responsibility to adhere to the specific speed limits.



Fuel gauge

Display of fuel level:

Illumination of bars displays fuel level.

When the fuel gauge indicates that the fuel supply is low, low fuel level control indicator  illuminates = fill up.

See page 90.

Never let the tank become empty!



Coolant temperature gauge

Display of coolant temperature:

- Bars illuminated in lower area = Engine operating temperature not yet reached
- Bars illuminated up to central area = Normal operating temperature
- Bars illuminated to uppermost area or control indicator  is illuminated * = Temperature too high. Stop vehicle, switch off engine. Danger to engine. Check coolant level. See page 141.

For physical reasons, the coolant temperature gauge shows the coolant temperature only if the coolant level is adequate.



During operation, the system is pressurized. The temperature may therefore rise to over 100 °C.



Multi-function display

Transmission display *

Display of the selected gear and mode with Tecshift *.

- N** Neutral or idling position.
- R** Reverse gear.
- A** Automatic mode.
- kg** Laden programme.
-  Winter programme.
-  Footbrake application.
-  Transmission electronics.



S 12293

Electronic odometer / clock ❄

Normal mode:

The odometer and clock are visible.

Reset:

The reset button is located alongside the speedometer. Press button once to display the trip odometer.

Press the button and hold; the display will flash and after 1 second will reset to zero. Press the button again to return the odometer to normal mode.

Clock adjust mode:

With the display in normal mode, press and hold the button and the minutes reading will begin to increase.

After the button is released, the clock will continue to flash for a further 5 seconds to enable further adjustments to be made.



S 14349

Oil level display ❄

The oil level display is correct only if the vehicle is parked on level ground with a cold engine. The oil level display will only be reset if the ignition has been switched off for more than two minutes.

If "oil" appears in the display, the oil level may need topping up. To gain a more accurate indication of the oil level, press and hold the reset button - see page 26.

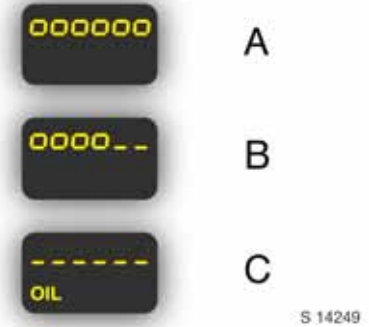

S 14249

The squares that appear on the display indicate the level. As the oil level diminishes, the squares in the display disappear and are replaced with dashes.

- A:** Maximum level
- B:** Intermediate level
- C:** Minimum level = check and top up engine oil¹⁾

¹⁾ Control indicator  illuminates if oil level is too low.

To return to the normal display, press the reset button again.

Checking and topping up fluids - see page 138.



S 11684

Trip computer *

In addition to the electronic odometer functions, the trip computer can also display additional monitored vehicle data.

- Fuel used,
- Average consumption,
- Instantaneous consumption,
- Range,
- Distance travelled,
- Average speed,
- Cruise control speed limiter *

Pressing the selection switch located on the end of the windscreen wash control stalk will cycle through these displays.



S 12295

Fuel used

Displays the amount of fuel consumed since the last reset.

The measurement can be restarted at any time - see page 26.



S 12296

Average consumption

Displays the average amount of fuel consumed, taking into consideration the distance travelled and the fuel used since the last reset.

The measurement can be restarted at any time - see page 26.

**Instantaneous consumption**

Displays the current fuel consumption level.

The value is displayed after reaching a speed of 15 mph (25 km/h).

**Range**

Displays the distance the vehicle can travel on its current fuel tank contents.

The range is calculated from the current contents of the fuel tank and the average consumption since the last reset - see page 26.

The measurement can be restarted at any time - see page 26.

**Distance travelled**

Displays the distance driven since the last reset.

The measurement can be restarted at any time - see page 26.



S 12300

Average speed

Displays the average speed since the last reset.

The measurement can be restarted at any time - see end column.

Stoppages in the journey with the ignition off are not included in the calculations.



S 12405

Cruise control speed limiter ✳

Displays the preset speed limit.

Cruise control and speed limiter - see page 100.



S 12406

Reset current trip computer information

The following trip computer information can be reset:

- Fuel used,
- Average consumption,
- Range,
- Distance travelled,
- Average speed.

To reset the trip computer, select one of its functions then press and hold the reset button; the display will flash and after 1 second will reset.

Interruption of power supply

If the power supply has been interrupted or the battery voltage drops too low, the values stored in the trip computer will be lost.



Engine oil life monitor *

Each time the ignition is switched on, the remaining distance before the next engine oil and filter change is due may be shown in the display for approx. 5 seconds.

Within 1,800 miles (3,000 km) of the next engine oil change being due, the remaining distance and control indicator  will be displayed for approx. 30 seconds as a reminder. Make an appointment with a workshop for service work as soon as possible.

Further information - see page 94.

Radio *

The radio is operated as described in the operating instructions supplied.

Vehicle radio reception will differ from that obtained with domestic radios.

As the vehicle antenna is relatively near the ground, the broadcasting companies cannot guarantee the same quality of reception as is obtained with a domestic radio using an overhead antenna.

- Changes in distance from the transmitter,
- multi-path reception due to reflection and
- shadowing

may cause hissing, noise, distortion or loss of reception altogether.



Electronic tachograph *

The tachograph is operated as described in the operating instructions supplied.

Observe regulations regarding use.

Navigation system *

The navigation system is operated as described in the operating instructions supplied.

The navigation system is supplied with a CD or DVD detailing the local territory.

Refer to the navigation system operating instructions for details on how to access additional countries / territories.

Mobile telephones and radio equipment (CB) *

The Vauxhall installation instructions and the operating guidelines provided by the telephone manufacturer must be observed when fitting and operating a mobile telephone. Failure to do so could invalidate the vehicle's operating permit (EU Directive 95/54/EG).

Requirements to ensure trouble-free operation:

- Professionally installed exterior aerial to obtain the maximum range possible,
- Maximum transmission power 10 W,
- Installation of the telephone in a suitable spot (see notes on page 54).

Obtain advice on predetermined installation locations for the external antenna and equipment holder and ways of using devices with transmission power of more than 10 Watts. We recommend that you consult your Vauxhall Authorised Repairer, who will have consoles and various installation kits and install them in accordance with regulations.

Use a hands-free attachment if you must use your phone while driving. Even with a hands-free attachment, the telephone could distract you from the traffic situation. Follow the national regulations of the country in which you are driving.

Warning

When used in the vehicle interior, mobile telephones and radio equipment (CB) with integrated antenna may cause malfunctions in the vehicle electronics.

Mobile telephones and radio equipment (CB) should only be used with an antenna fitted on the vehicle exterior.

Keys, doors, bonnet

| | |
|--------------------------------------|----|
| Replacement keys | 29 |
| Lock cylinders | 29 |
| Door locking and unlocking..... | 29 |
| Child safety locks *..... | 29 |
| Electronic immobiliser..... | 30 |
| Radio frequency remote control | 31 |
| Central locking system | 33 |
| Automatic locking | 34 |
| Vauxhall alarm system *..... | 35 |
| Sliding side door * | 36 |
| Electric side step * | 37 |
| Back doors | 38 |
| Bonnet release | 39 |

Replacement keys

The key is a constituent of the electronic immobiliser. Ordering keys from a Vauxhall Authorised Repairer guarantees problem-free operation of the electronic immobiliser. Keep the spare key accessible in a safe place.

Locks - see page 150.

Lock cylinders

Designed to free-wheel if they are forcefully rotated without the correct key or if the correct key is not fully inserted.

To reset, turn cylinder with the correct key until its slot is vertical, remove key and then re-insert it. If the cylinder still free-wheels, turn the key through 180° and repeat operation.

Door locking and unlocking

From outside:

Pull outside handle to open the front door.

Remote control - see page 31,
central locking system - see page 33.

From inside:

Pull the inside lever to open the front door.

The door can be locked or unlocked by pushing the lock button or by using the central locking switch - see page 34.

To prevent the driver from being inadvertently locked out, the front doors cannot be locked when they are open.

Further information - see page 2.



S 12407

Child safety locks *

Turn rotary knob on forward face of sliding side door from vertical position:
Door cannot be opened from the inside.

Warning

Use the child safety lock whenever children are occupying the rear seats.

Disregard of these instructions may lead to injuries or endanger life. Vehicle passengers must be informed accordingly.



Electronic immobiliser

The system checks whether the vehicle may be started using the key that has been inserted. If the key is recognised as "authorised", the vehicle can be started. The check is carried out via a transponder housed in the key.

The electronic immobiliser is automatically activated when the key is removed from the starter switch.



Control indicator for immobiliser

The control indicator illuminates when the ignition is switched on then goes out.

If the control indicator flashes rapidly after the ignition is switched on, there is a fault in the immobiliser system.

- Turn ignition off and remove key,
- wait approximately two seconds,
- then repeat starting procedure.

If the control indicator fails to extinguish, try to start the engine using the spare key. Obtain assistance from a workshop.

Note

The immobiliser does not lock the doors. Therefore after leaving the vehicle, always lock it and switch on the Vauxhall alarm system ✱.

The Car Pass contains all the vehicle's data and therefore must not be kept in the vehicle.

Have your Car Pass ready to hand when consulting your Vauxhall Authorised Repairer.



S 12391

Radio frequency remote control

The remote control is used to operate the central locking system.

Depending on model the vehicle may use a two remote control or three button (selective door locking).

The remote control has a range of approx. 3 metres. The range may be reduced owing to shadowing and reflection of the radio waves. To operate the remote control, direct the remote control unit towards the vehicle.



S 13026

For your convenience we recommend that the central locking system is always operated using the remote control.

Treat the remote control with care; it should be protected against moisture and should not be operated unnecessarily.

Central locking system,
see page 33.

Vauxhall alarm system *,
see page 35.

Automatic locking *,
see page 34.

Note

If the central locking system cannot be operated with the remote control, this may be due to the following reasons:

- The remote control is out of range.
- The battery voltage of the remote control is too low. Change the battery in the remote control.
- The remote control has been operated too many times in succession outside the vehicle's reception range (e.g. at too great a distance from the vehicle).

The remote control must be reprogrammed. We recommend you consult your Vauxhall Authorised Repairer.

- Interference from higher power radio waves from other sources.

Lock or unlock the doors manually using the key or central locking switch. Manual locking does not operate the central locking system. Have cause of fault remedied by a workshop.



Changing the battery in remote control

Replace the battery in accordance with the Service Booklet or when the range of the remote control starts to become reduced.

Two function remote control:

Open the battery compartment by inserting a coin into the slot and twisting.

Ensure the new battery is installed correctly.

Replace the cover and press until it is fully engaged.



Selective door locking remote control

Open the battery compartment by removing the screw on the rear cover, then inserting a coin into the slot and twisting.

Ensure the new battery is installed correctly.

Replace the cover and press until it is fully engaged, then replace and secure screw.

Make sure that you dispose of old batteries in accordance with environmental protection regulations.



S 12391

Central locking system

For front, side and back doors ✱. With selective door locking ✱, the passenger compartment and rear load compartment are locked and unlocked separately

To unlock - two function remote control:

Press button on remote control:

- Hazard warning lights flash once.
- Doors are unlocked.

To unlock - selective door locking:

Press button on remote control:

- Hazard warning lights flash once.
- Doors of the passenger compartment only are unlocked.

To lock - two function remote control:

Press button on remote control:

- Hazard warning lights flash twice.
- Doors are locked.

To lock - selective door locking:

Press button on remote control:

- Hazard warning lights flash twice.
- Passenger compartment doors only are locked.

Always ensure that the side door ✱ or back doors are properly closed before locking the vehicle with the remote control.

Warning

For safety reasons, the vehicle cannot be locked if the ignition key is in the ignition.

Manually locking or unlocking a door with the key does not operate the central locking system.



S 13078

Rear load compartment doors - selective door locking

To unlock

Press button on remote control.

If no door is opened within 30 seconds (approximately) after the vehicle has been unlocked by the remote control the vehicle is re-locked automatically.

To lock

Press button on remote control. The rear load compartment doors are now locked.



Central locking switch

Use the central locking switch (arrowed) to lock or unlock the doors from inside the vehicle.

Press the bottom of the switch to lock or  to unlock.

Automatic locking

The central locking system can be activated to automatically lock the doors as soon as a speed of approximately 4 mph (6 km/h) is reached.

To activate

With the ignition switched on, press the central locking switch on the locking side (opposite ) and hold for approx. 5 seconds, until audible confirmation is heard.

To deactivate

With the ignition switched on, press  on the central locking switch and hold for approximately 5 seconds, until audible confirmation is heard.

Unlocking the door

The doors are unlocked by opening any door from inside the vehicle or by operating the central locking switch.

Fault

In the event of a fault e.g. automatic locking doesn't take place, ensure all the doors have been properly closed. Check to ensure that the automatic locking function has not been deactivated inadvertently. If this is the case, switch the ignition off and on again and reactivate the system as described previously.

If the automatic locking function still fails to operate, consult a workshop. We recommend that you contact your Vauxhall Authorised Repairer.

Warning

If you decide on having the system active (with the doors closed) whilst driving, it may become difficult for those assisting you in gaining access to your vehicle in the event of an emergency.



Vauxhall alarm system *

The system monitors:

- Front and side doors.
- Back doors and bonnet.
- Passenger compartment.
- Starter switch.
- Siren power supply *

The remote control is used to operate the anti-theft alarm system.

To activate

All doors must be fully closed; press the  button on the remote control, the hazard warning lights flash twice. If the hazard warning lights do not flash on activation, this may indicate that a door or the bonnet is not fully closed.

To deactivate

Press the  button on the remote control, the hazard warning lights flash once.

If the alarm has been triggered, the hazard warning lights will not flash upon deactivation.

When unlocking the vehicle using the key, the alarm will sound; to deactivate, insert the key and switch on the ignition.

Note

The anti-theft alarm system cannot be deactivated in any other way so keep a spare key in a safe place.

Alarm

During a switch-on phase the sensors can trigger a maximum of 10 times¹⁾.

The alarm takes the form of:

- an acoustic signal (horn, 25 seconds) and
- a visual signal¹⁾ (hazard warning lights, 25 seconds).

¹⁾ Varies from country to country on account of national regulations

Passenger compartment monitoring

When the anti-theft alarm is activated, the system automatically monitors the inside of the vehicle for movement.

To disable the passenger compartment monitoring, (for example if an animal is left in the vehicle):

- Press and hold the  button on the remote control.
- An audible beep will sound to confirm that the passenger compartment monitoring function is disabled.

The disable monitoring function will remain until the alarm is deactivated or the doors unlocked.

Alarm back-up system *

The alarm system has a battery back-up siren unit which, in the event of its power supply being disconnected or disconnection of the vehicle battery, will sound for approx. 5 minutes on its internal batteries.

If the vehicle battery has to be disconnected it will be necessary to deactivate the alarm system.

To stop the siren if activated, reconnect the vehicle battery and press the rear  button on remote control.

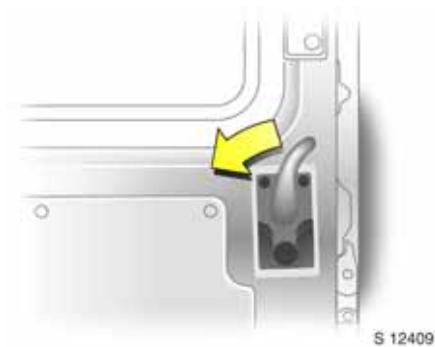

Sliding side door *

Open the door by pulling the outside handle, or by pulling the interior lever to the rear, then sliding the door rearwards.

To close the door, slide it fully forwards using the upper handle and ensure it is fully closed.

Warning

When closing the door from the outside of the vehicle, use the door handle and not its recess.

The door can be locked or unlocked with the key, the remote control, the central locking switch or by the interior lock switch.

Warning

Ensure the side door is closed before driving the vehicle.

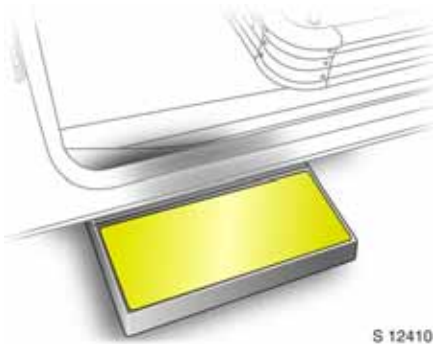

S 12410

Electric side step *

On opening the sliding side door, the electric side step extends automatically to improve access when entering and exiting vehicle. The  remains illuminated while the side step is extended.

On certain models the handbrake will need to be applied before the side step extends.

When closing the sliding side door, the electric side step is automatically retracted.

Warning

Ensure there is adequate clearance to allow electric side step to fully extend and retract without obstruction.

When closing the sliding side door, if the electric side step fails to retract, control indicator  illuminates in the instrument cluster and will remain illuminated to indicate a fault.

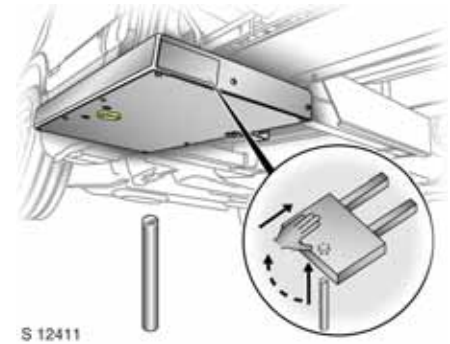

S 12411

In such cases the step can be retracted manually (ensure that the sliding side door remains closed). Insert bar from tool kit in the hole located under the electric side step. Draw towards you then push electric side step to retract.

Have the cause of the fault remedied by a workshop. We recommend your Vauxhall Authorised Repairer.

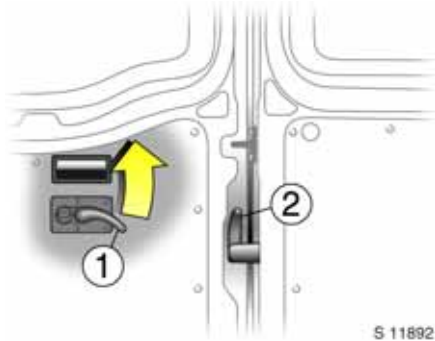

Back doors

The doors can be locked or unlocked with the key, the remote control, the central locking switch or by turning the interior lock switch.

To open the right-hand back door from outside pull the outside handle; from inside the vehicle, raise lever 1.

Open the left-hand rear door *¹⁾ with lever 2.

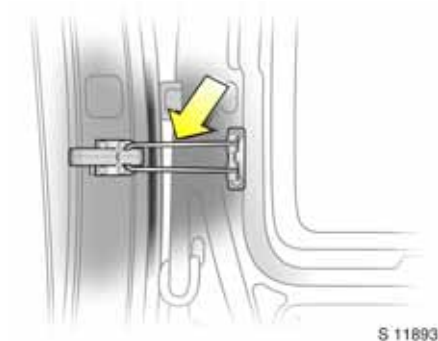

The doors are retained in the 90° position by locking stays (arrowed).

Warning

Opened doors may slam closed due to the force of the wind!

To open the doors to 180°, release locking stays from the catches on the door frames.

When opening the doors to 270°*, the doors are retained in the fully open position by magnets on the body side.

Always close the left-hand door before the right-hand door.

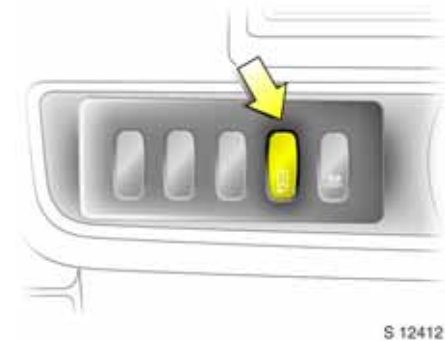

Rear door lock isolation switch *

Bus

The rear door lock isolation switch, when activated, locks the rear doors to prevent them from being opened from the inside.

Press the switch again to unlock.

¹⁾ On some variants, the left-hand rear door may be fixed and cannot be opened.

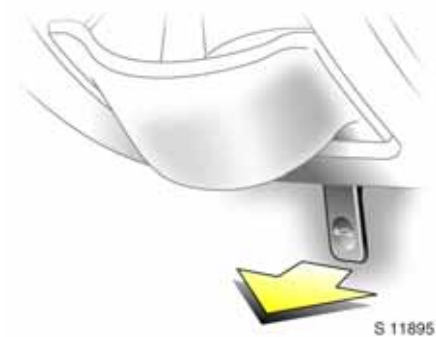

Bonnet release

To open the bonnet, pull the release lever located on the left-hand side below the instrument panel. The bonnet will then be unlocked and will partially open. Return release lever to its original position.

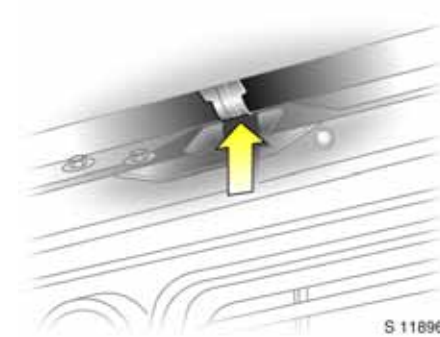

To open completely, locate the safety catch, located to the right of centre - as viewed from the front - lift upwards and open the bonnet.



To hold bonnet in the open position, insert the support rod, located across the radiator grille, into the slot provided in the underside of the bonnet.

Before closing bonnet, press the support rod firmly into its retainers. Lower bonnet gradually to be finally dropped by its own weight.

Check that the bonnet is locked in position by pulling at its front edge. If it is not locked in position, repeat closing procedure.

Seats, interior

| | |
|--|----|
| Seat adjustment | 40 |
| Seat position | 40 |
| Head restraint position | 40 |
| Head restraints | 41 |
| Removable rear seats *..... | 41 |
| Office bench seat *..... | 41 |
| Rear bench seat *..... | 42 |
| Lashing eyes * | 43 |
| Load anchorage rails *..... | 43 |
| Notes on loading the vehicle..... | 43 |
| Cigarette lighter  *..... | 44 |
| Ashtrays *..... | 45 |
| Overhead storage | 45 |
| Luggage rack *..... | 46 |
| Additional storage | 47 |
| Coat hook..... | 47 |

Seat adjustment

see page 2

Seat position

Adjust driver's seat such that with the driver sitting upright the steering wheel is held in the area of its upper spokes with the driver's arms slightly bent.

The seat backrests must not be tilted too far back (recommended maximum tilting angle approx. 25°).

Warning

Important: Do not sit nearer than 10 inches (25 cm) from the steering wheel, to permit safe airbag deployment.

Disregard can lead to injuries which could be fatal. Vehicle passengers must be informed accordingly.

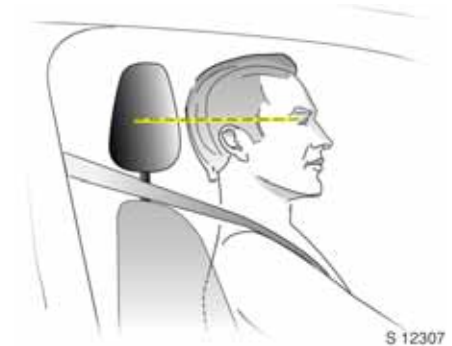

S 12307

Head restraint position

The centre of the head restraint should be at eye level. Adjust to highest position if this is not possible for extremely tall people, and adjust to lowest position for extremely small people.

Warning

Disregard can lead to injuries which could be fatal. Vehicle passengers must be informed accordingly.

Setting – see page 4.

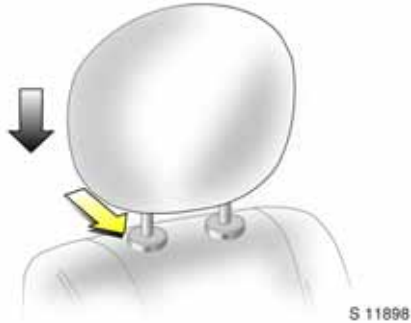

Head restraints

To raise the height of the head restraints, pull upwards. To lower, press the larger lock tab (arrowed) and press the restraint down.

Allow restraint to lock in position after adjustment.

To remove the head restraints, depress both lock tabs and pull the restraint upwards.



Removable rear seats *

On Combi variants, the cargo area can be increased by removing the rear seats.

Release the rear seats by lifting both locking catches on the front and rear seat mountings. Push the seat unit sideways to release it from the floor anchor points and lift out the seat.

Warning

Removable seats are heavy! Do not attempt to remove without assistance.

When installing the seats, ensure that the seats are properly located on the anchor points and that the locking catches are fully engaged.



Office bench seat *

The office bench seat has provision for storage under the seat cushions.

To gain access to the storage net under the outer seat, pull up on the front part of the seat cushion and pull forward.

Warning

Always ensure the seat cushions are returned to the rest position. Never drive the vehicle with the seat cushions in the upright position.

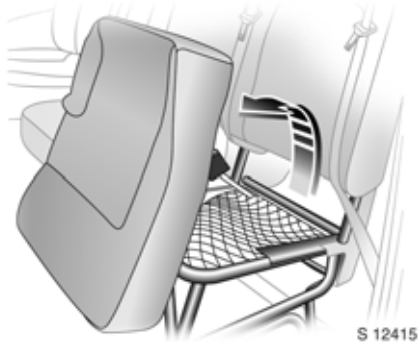

Storage net

Raise the seat cushion to the upright position to expose the storage net. Lower seat cushion and push down into place before occupying seat.

Warning

Heavy objects should not be placed within this storage area.



Storage tray

The centre seat can be raised in the same way as the outer seat to gain access to the under seat pocket and storage tray.

Warning

The maximum weight of objects placed in the storage tray should not exceed 3 kg.

Documents can be placed in the under seat pocket which has a zip fastener to secure its contents.

Lower seat cushion and push down into place before occupying seat.



Rear bench seat *

On Crew Cab models, lift the rear bench seat cushion to access additional storage area.

Warning

Heavy objects should not be placed within this storage area.

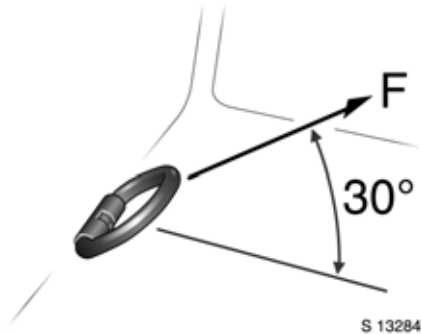

Lashing eyes *

Lashing eyes are mounted in the load compartment to enable cargo to be secured in position using lashing straps * or a luggage net *.

The maximum force applied to the lashing eyes should not exceed 5000 N at 30°.

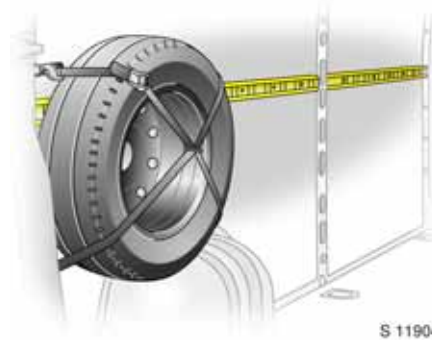

Load anchorage rails *

Load anchorage rails mounted in the load compartment, provide anchorage points for securing cargo.

Warning

The use of ratchet straps is not permitted when securing items using the load anchorage rails.

The maximum weight for items attached to each load anchorage rail, must not exceed 75 kg.

Notes on loading the vehicle

- Heavy objects in the load compartment should be placed as far forwards as possible. If objects are to be stacked, the heavier objects should be placed at the bottom. Unsecured objects in the load compartment would be thrown forwards with great force in the event of heavy braking, for example.
- Secure heavy objects with lashing straps * attached to the lashing points. If heavy loads slip when the vehicle is braked heavily or driven around a bend, the handling of the vehicle may change.
- The warning triangle * and first-aid kit * should always be freely accessible.
- No objects should be placed on the instrument panel. They are reflected in the glass, obstruct the driver's view and will be thrown through the vehicle in the event of heavy braking, for example.

- No objects should be placed in any of the airbag inflation zones, as they could cause injury when the airbag is triggered.
- Bulky objects should do not transported with the back doors open or ajar, otherwise poisonous exhaust fumes may enter the vehicle. In addition, the number plate is only distinguishable and illuminated correctly if the doors are closed.
- Weights, payload and roof load - see page 156.
- Driving with a roof load (see page 112) increases the sensitivity of the vehicle to crosswinds and has a detrimental effect on vehicle handling owing to the higher centre of gravity of the vehicle.

⚠ Warning

Disregard of these instructions may lead to injuries or endanger life. Vehicle passengers must be informed accordingly.

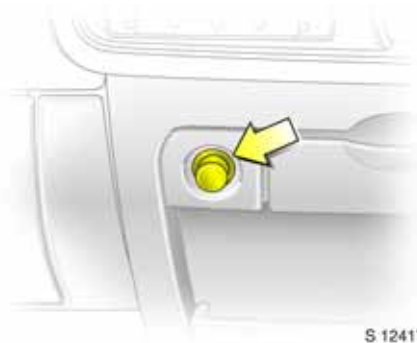

Cigarette lighter ⚠*

With ignition switched on, press the cigarette lighter. Heating up ceases once element is glowing. Withdraw lighter.

Accessory socket

The cigarette lighter socket can be used to connect electrical accessories.

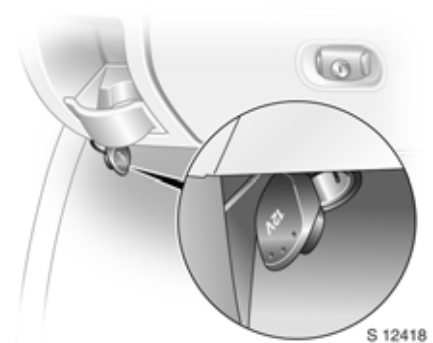

An additional accessory socket* is located in the passenger side below the instrument panel.

When the engine is not running using the accessory socket will cause the battery to be discharged. Do not connect any current-delivering accessories, e.g. electrical charging devices or batteries.

The maximum power requirement of electrical accessories must not exceed 120 watts.

Connected electrical accessories must comply with the EC standard in terms of electromagnetic compatibility requirements laid down in DIN VDE 40 839, otherwise vehicle malfunctions may occur.

The use of non-approved accessories may cause damage to the socket.

Ashtrays ❖

To be used only for ash and not for combustible rubbish.

Ashtray, front ❖

To open: pull lid towards you.

To empty: open the ashtray, depress spring plate and lift out.

To install, seat the edge of the ashtray on its housing, then push the ashtray fully in.

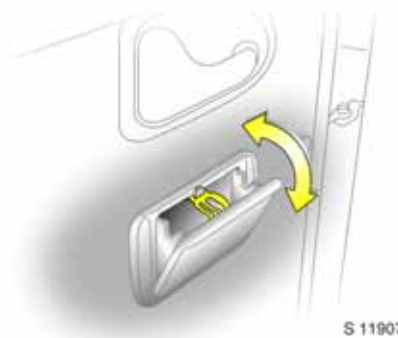
**Ashtray, rear ❖**

To empty: open the ashtray, depress spring plate and lift out ash container.

To install, seat the lower edge of the ash container then push the ashtray fully in.

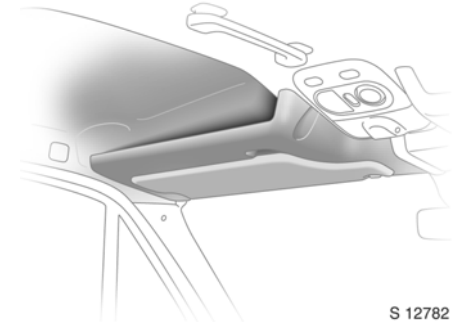
**Overhead storage**

Overhead storage compartments can be found above the driver and front passenger seats.

The total weight in each compartment must not exceed 1 kg.

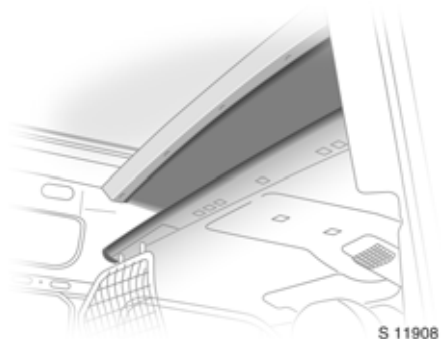

Over-cab storage area *

The total weight in this compartment must not exceed 30 kg.

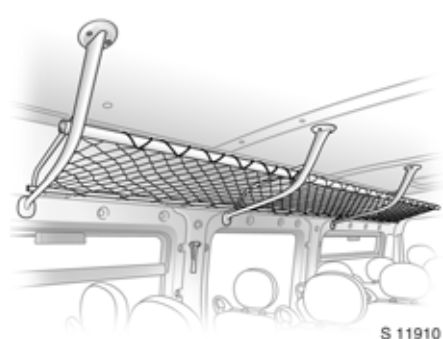

Overhead storage rack *

Bus

Objects can be stored in the overhead storage rack located along the inside of the vehicle. The total weight in this rack must not exceed 75 kg.

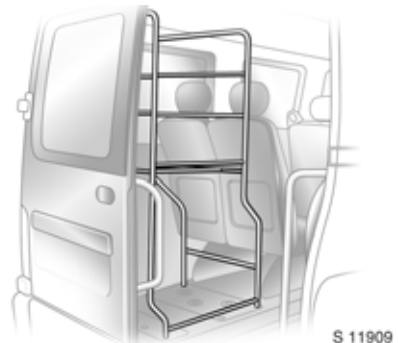

Luggage rack *

Bus

A luggage rack is located in the rear of the vehicle. It is purposely designed for the safe storage and transport of objects.

Additional storage

- Document holder and note pad clip * - on instrument panel.
The total weight in the document holder must not exceed 2 kg.
- Pockets and bottle holder - on lower front doors.
- Drink holders - on lower instrument panel.
- Tray, net and pocket storage under office bench seat * - see page 41.
- Document strap * - between front seats.
- Tray * - under passenger bench seat.

Coat hook

Located above the front seat belt upper anchorage points. Items should not impair driver's vision or restrict seat belt operation.

Safety systems

Three-stage restraint system..... 48
 Seat belts..... 49
 Three-point seat belts 49
 Using the belts 49
 Centre seat belts *..... 50
 Inspection of belts 50
 Belt tensioners *..... 51
 Airbag system..... 52
 Child restraint systems * 55
 Exterior mirrors..... 61
 Aspherical exterior mirror *..... 61
 Sunvisors..... 61
 Safety accessories * 61

Three-stage restraint system

The system comprises

- three-point seat belts
- belt tensioners on the front seats *
- airbag system for driver and front passenger *.

The three stages are activated in sequence depending on the seriousness of the accident:

- The automatic seat belt locking devices prevent the belt strap from being pulled out and thus ensure that the vehicle occupants are retained in their seats.
- The front seat belt buckles are pulled downwards. As a result, the seat belts are instantaneously tightened and the occupants are made aware of the deceleration of the vehicle at a very early stage. This reduces stress placed on the body.
- The airbag system is additionally triggered in the event of a serious accident involving a frontal impact and forms a safety cushion for the driver and front passenger.

Warning

The airbag system serves to supplement the three-point seat belts. The seat belts must therefore always be worn. Disregard of these notes can lead to injuries or endanger life. Vehicle passengers must be informed accordingly.

Be sure to read the descriptions of all the restraint systems on the following pages.

Seat belts

Warning

Always wear your seat belt - and that means also in urban traffic and when you are a rear seat passenger. It can save your life!

Pregnant women too must always wear a seat belt - see page 49.

In the event of an accident, persons not wearing seat belts endanger their fellow occupants and themselves.

Seat belts are designed to be used by only one person at a time. They are only suitable for children aged up to 12 or smaller than 150 cm if used in conjunction with a child restraint.

Three-point seat belts

The vehicle is equipped with three-point seat belts with automatic retractors and locking devices, allowing freedom of body movement although the spring tensioned belts are always a snug fit.

The belt has a “vehicle sensitive retractor” which is designed to lock during heavy acceleration or deceleration in any direction.



S 12279

Using the belts

Fitting the belt

Pull the belt out from the retractor and guide it across the body, making certain that it is not twisted.

Insert the latch plate into the buckle. The seat backrest must not be tilted back too far; the recommended angle of inclination is approx. 25°. The lap belt must not be twisted and must fit snugly across the body. Tension the belt frequently whilst driving by tugging the diagonal part of the belt.



S 12314

Warning

On pregnant women in particular the lap belt must be positioned as low as possible across the pelvis in order to prevent pressure on the abdomen.

Bulky clothing prevents the belt from fitting properly. The belt must not rest against hard or fragile objects in the pockets of your clothing (e.g. ballpoint pens, keys, spectacles) because these could cause injury. Do not place any objects (e.g. handbags) between the belt and your body.

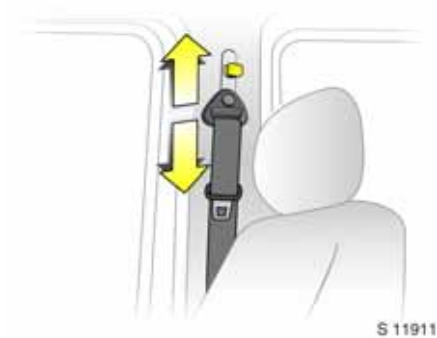

Upper anchorage point height adjustment *

- Do not adjust height whilst driving
- Pull anchorage adjuster against resistance
- Adjust height
- Release adjuster and allow it to lock in position

Adjust height so that the belt passes over the wearers shoulder and rests against the shoulder. It must not pass over the neck or upper arm.

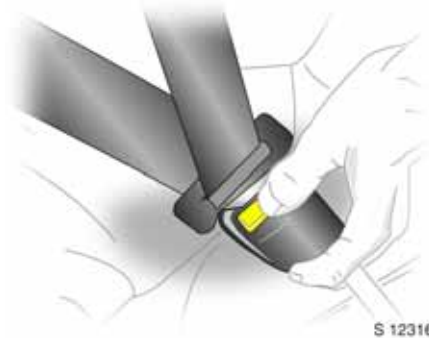

Removing the belt

To remove the belt, depress the red pushbutton on the buckle; the belt will retract automatically.

Centre seat belts *

On certain models the centre seat belt can be a retractable lap type or three point seat belt. In both cases pull the belt out from the retractor and guide it across the body, making certain that it is not twisted. Insert the latch plate into the buckle.

Inspection of belts

Periodically inspect all parts of the belt system for damage and to make sure they are functioning properly. Have damaged parts replaced. After an accident, overstretched belts must be replaced by new ones. Consult a workshop.

Do not perform any alterations on the belts, their anchorages, the automatic retractors or the belt buckles.

Make sure that belts are not damaged or trapped by sharp-edged objects.

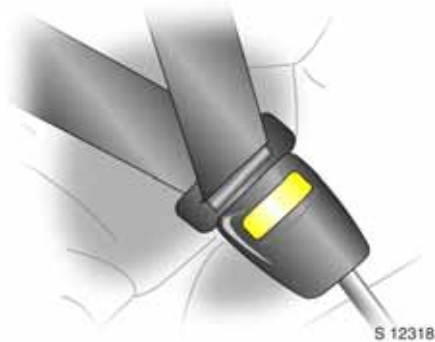

Belt tensioners *

The front seat belt system incorporates belt tensioners. In the event of a head-on or tail-end collision the belt buckles are pulled downwards; the diagonal and lap belts are instantaneously tightened.

Actuation of belt tensioners

If the belt tensioners have been actuated, they must be replaced. Consult a workshop.

Warning

The belt tensioners are operational only when the control indicator is unlit.

The seat belts remain fully operational even when the belt tensioners have been actuated.



Belt tensioner control indicator *

The seat belt tensioners are monitored electronically together with the airbags, and their operational readiness shown by the control indicator in the instrument cluster. When the ignition is switched on, the control indicator illuminates, then extinguishes. If it does not illuminate or if it illuminates during driving, there is a fault in the airbag system or the belt tensioners (see also page 53).

Warning

Have the cause of the fault remedied by a workshop.

The system's integral self-diagnosis facility allows faults to be quickly remedied. Have Car Pass to hand when consulting your Vauxhall Authorised Repairer.

Important

- Accessories not released for your vehicle type and other objects must not be affixed or placed in the area in which the belt tensioners operate, as they could cause injury when the belt tensioners are activated.
- Do not make any modifications to the components of the belt tensioners, as this will render the vehicle unroadworthy.

⚠ Warning

Improper handling (e.g. removal or installation) can activate the belt tensioners – risk of injury.

- The belt tensioner and airbag system control electronics can be found in the centre console area. In order to avoid malfunctions, do not store magnetic objects in this area.
- We recommend that you have the front seats removed by a Vauxhall Authorised Repairer in the event of actuation of the belt tensioners.
- The belt tensioners only actuate once. Please replace belt tensioners that have been triggered. We recommend that you consult your Vauxhall Authorised Repairer.
- When disposing of the vehicle, please observe the applicable regulations. Please have the vehicle disposed of by a disposal company. We recommend that you consult your Vauxhall Authorised Repairer.



S 12421

Airbag system

The airbag system is identified by the word “airbag” on the steering wheel and above the glove compartment ✱.

The airbag system comprises:

- an airbag with an inflator in the steering wheel, and a second one behind the trim panel above the glove compartment ✱
- the control electronics with impact sensor
- the airbag system control indicator ✱ in the instrument cluster.

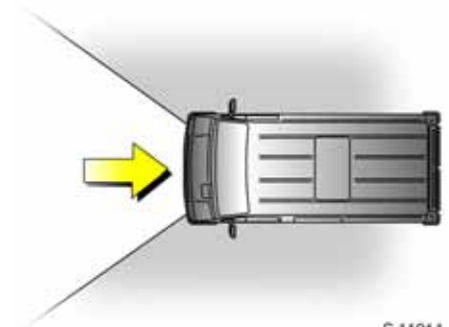

S 11914

The airbag system is triggered:

- depending on the severity of the accident
- depending on the type of impact
- within the range shown in the illustration.

Examples:

- Impact against a non-yielding obstacle: the airbag is triggered at low vehicle speed.
- Impact against a yielding obstacle (such as another vehicle): the airbag is only triggered at a higher vehicle speed.

When triggered, the driver's airbag and front passenger airbag * inflate in milliseconds and form safety cushions for the driver and front passenger. The forward movement of the driver and front passenger is checked and the risk of injuries to the upper body and head are thereby substantially reduced.

- No impairment of view will occur, because the airbags inflate and deflate so quickly.

⚠ Warning

The front airbag system provides optimum protection when the seat, backrest and head restraint are correctly adjusted. Adjust the driver's seat according to the occupant's height such that with the driver sitting upright, the steering wheel is held in the area of its upper spokes with the driver's arms slightly bent. The passenger seat should be as far back as possible, with the backrest upright. Do not place the head, body, hands or feet on the cover of the airbag system.

Do not place any objects in the area in which the airbags inflate.

The three-point seat belt must be correctly fitted (see page 49).

The airbag system will not be triggered in the event of

- the ignition being switched off
- minor frontal collisions
- accidents in which the vehicle overturns
- collisions involving a side or rear-impact where it would not be of benefit to the occupants.

⚠ Warning

Seat belts must therefore always be worn. The airbag system serves to supplement the three-point seat belts. If you do not wear your seat belt you risk being seriously injured, or even thrown from the vehicle, in the event of an accident.

The belt helps to keep you in the correct seating position, in which the airbag system will provide you with effective protection in the event of an accident.



S 12420

Airbag control indicator *

The airbag system is monitored electronically together with the belt tensioners, and their operational readiness shown by the control indicator in the instrument cluster. When the ignition is switched on, the control indicator illuminates then extinguishes. If it does not illuminate, or if it illuminates during driving, there is a fault in the airbag system.

The system might not be triggered in the event of an accident.

⚠ Warning

Have the airbag system checked without delay. We recommend you consult your Vauxhall Authorised Repairer.

The system's integral self-diagnosis facility allows faults to be quickly remedied. Have your Car Pass ready to hand when consulting your Vauxhall Authorised Repairer.

Important

- Accessories not released for your vehicle type and other objects must not be affixed or placed in the area in which the airbags inflate, as they could cause injury when the airbag is triggered.
- Do not place any objects between the airbag systems and the vehicle occupants; danger of injury.
- Do not stick or place anything on the steering wheel, and instrument panel.
- The airbag systems and belt tensioner control electronics can be found in the centre console area. In order to avoid malfunctions, do not store magnetic objects in this area.

- Use only a dry cloth or interior cleaner to clean the steering wheel and instrument panel. Aggressive cleaning agents may cause damage.
- The airbags only actuate once. Please replace airbags that have been triggered. Have the cause of the fault remedied by a workshop.
- The speeds, directions of movement and deformation properties of the vehicles, and the properties of the obstacle concerned, determine the severity of the accident and triggering of the airbags. The degree of damage to your vehicle and the resulting repair costs alone are not indicative that the criteria for triggering of the airbags were met.
- Do not make any modifications to the components of the airbag system as this will render the vehicle unroadworthy.

| |
|--|
|  Warning |
| The systems can be triggered abruptly and cause injury if they are handled improperly. |

- We recommend having the steering wheel, the instrument panel and the front seats removed by your Vauxhall Authorised Repairer.
- When disposing of the vehicle, please observe the applicable safety regulations. Please have the vehicle disposed of by a disposal company. We recommend that you consult your Vauxhall Authorised Repairer.

| |
|--|
|  Warning |
| Child restraint systems as well as other heavy objects must never be carried on the lap of passengers; risk of fatal injury. |



17118T

Use of child restraint systems * on front passenger seat in vehicles with airbag systems *

⚠ Warning

Vehicles with front passenger airbag *: Rear-facing child restraints must not be fitted on the front passenger seat, danger of fatal injury.

Forward-facing child restraints can be fitted on the front passenger seat provided that the latter is moved as far back as it will go.

Vehicles with front passenger airbag can be identified by the word "Airbag" above the glove compartment and the warning sticker on the side of the instrument panel, visible when passenger door is open.

Child restraint systems *

Vauxhall child restraint systems are designed specifically for your vehicle and thus provide optimum safety for your child in the event of impact. The use of a Vauxhall child restraint system is therefore recommended.

⚠ Warning

Disregard of these instructions may lead to injuries or endanger life!

Selecting the right system

Your child should be transported facing rearwards in the vehicle as long as possible. It is appropriate to change the system when the child's head can no longer be properly supported at eye height. The child's cervical vertebrae are still very weak and in an accident they suffer less stress in the semi-prone rearward position than when sitting upright.

Note

- Children under 12 years or under 150 cm tall should only travel in an appropriate child safety seat.
- When transporting children, use the child restraint systems suitable for the child's weight.
- Ensure that the child restraint system to be installed is compatible with the vehicle type.
- The covers of the Vauxhall child restraint system can be wiped clean.
- Do not stick anything on the child restraint systems and do not cover them with any other materials.
- A child restraint system which has been subjected to stress in an accident must be replaced.
- Ensure that the mounting location of the child restraint system within the vehicle is correct.
- You should also observe the instructions on installation and use supplied with the child restraint system.

The following Vauxhall child restraint systems have been approved for installation in your Movano:

| Group, weight and age class ¹⁾ | | Vauxhall system |
|---|--|-----------------|
| 0 | From birth - 10 kg, 0 - 10 months | Baby Safe |
| 0+ | From birth - 13 kg, 0 - 2 years | |
| I | From 9 - 18 kg, 8 months - 4 years | Duo ISO-FIX |
| II | from 15 - 25 kg, 3 years - 7 years | Kid |
| III | from 22 - 36 kg, 6 years - 12 years | |

¹⁾ We recommend the use of each system until the child reaches the upper weight limit.

If child restraint systems of other manufacture are to be installed, ensure that they conform to the appropriate safety regulations.

| |
|--|
|  Warning |
| Disregard of these instructions may lead to injuries or endanger life. |

The country in which you are travelling may prohibit child restraint installation in certain locations. Always observe local or national regulations.

Front seats - all variants

| Group, weight and age class | Facing direction | Front passenger seat ¹⁾ (includes single or double seats) | | | |
|--|------------------|---|------------|--------------------------|------------|
| | | with passenger airbag | | without passenger airbag | |
| | | single or centre seat | outer seat | single or centre seat | outer seat |
| 0: up to 10 kg or approx. 10 months 0+: up to 13 kg or approx. 2 years | Rearward | X | X | U | X |
| I: 9 to 18 kg or approx. 8 months - 4 years | Forward | UF | X | U | X |
| II: 15 to 25 kg or approx. 3 - 7 years III: 22 to 36 kg or approx. 6 - 12 years | Forward | UF | X | U | X |

¹⁾ If adjustable, ensure seat is in its rearmost position. Make sure vehicle seat belt is as straight as possible between shoulder and upper anchorage point.

U = Suitable for universal category restraint systems for use in this mass group, in conjunction with three-point seat belt.

UF = Suitable for universal category forward facing restraint systems for use in this mass group, in conjunction with three-point seat belt.

X = Seat position not suitable for children of this mass group.

Crew Cab - rear seats

| Group, weight and age class | Facing direction | Rear seats | |
|--|------------------|------------------------------|---------------------------|
| | | outer seat (3-point belt) | centre seat (lap belt) |
| 0: up to 10 kg or approx. 10 months 0+: up to 13 kg or approx. 2 years | Rearward | U | X |
| I: 9 to 18 kg or approx. 8 months - 4 years | Forward | U | X |
| II: 15 to 25 kg or approx. 3 - 7 years III: 22 to 36 kg or approx. 6 - 12 years | Forward | U | X |

U = Suitable for universal category restraint systems for use in this mass group, in conjunction with three-point seat belt.

X = Seat position not suitable for children of this mass group.

Combi - rear seats

| Group, weight and age class | | Facing direction | Rear seats | | | | | |
|-----------------------------|---|------------------|------------|--|---|------------|--|---|
| | | | 2nd row | | | 3rd row | | |
| | | | outer seat | centre seat (lap belt) (3-point belt) | | outer seat | centre seat (lap belt) (3-point belt) | |
| 0: | up to 10 kg or approx. 10 months | Rearward | X | X | U | X | X | X |
| 0+: | up to 13 kg or approx. 2 years | | | | | | | |
| I: | 9 to 18 kg or approx. 8 months - 4 years | Forward | UF | X | U | L | X | X |
| II: | 15 to 25 kg or approx. 3 - 7 years | Forward | UF | X | U | L | X | L |
| III: | 22 to 36 kg or approx. 6 - 12 years | | | | | | | |

U = Suitable for universal category restraint systems for use in this mass group, in conjunction with three-point seat belt.

UF = Suitable for universal category forward facing restraint systems for use in this mass group, in conjunction with three-point seat belt.

L = Suitable only for specifically approved child restraints. Vauxhall has approved child restraint systems from the 'Baby-safe', 'Duo-ISO-FIX' and 'Kid' ranges. We recommend that you consult a Vauxhall Authorised Repairer.

X = Seat position not suitable for children of this mass group.

Bus - 11 to 16 places

| Group, weight and age class | Facing direction | Rear seats |
|--|------------------|------------|
| 0: up to 10 kg or approx. 10 months 0+: up to 13 kg or approx. 2 years | Rearward | X |
| I: 9 to 18 kg or approx. 8 months - 4 years | Forward | X |
| II: 15 to 25 kg or approx. 3 - 7 years III: 22 to 36 kg or approx. 6 - 12 years | Forward | X |

X = Seat position not suitable for children of this mass group.



Exterior mirrors

For the safety of pedestrians, the exterior mirrors will swing out of their normal mounting position in the event of an accident-like impact.

Aspherical exterior mirror *

Increases the field of vision. Slight distortion means that it is difficult to estimate the distance between the vehicle and those behind it.

Sunvisors

The sunvisors are padded and can be swung up and down and to the side for protection of driver and passenger against glare.

Safety accessories *



The wide range of Vauxhall accessories allows you to equip your vehicle in accordance with your own wishes. In addition to safety accessories, items for improving comfort and a complete range of vehicle care products you will find many articles which will be of great value to you when needed.

All items are “Genuine Vauxhall Parts and Accessories”, guaranteeing high quality and an accurate fit.

Your Vauxhall Authorised Repairer will be happy to advise you, for example with regard to:

- Vauxhall child restraint system
- Tow rope
- Tow rod
- Jump leads
- Spare bulb kit
- Spare fuse kit
- Halogen fog lights
- Mudflaps
- Magnetic light
- Warning triangle
- First-aid kit (box)
- First-aid kit (cushion)



Lighting

Exterior lights 62
 Automatic dipped beam activation * 63
 Turn signals, hazard warning lights.. 63
 Fog tail light  63
 Front fog lights  * 63
 Reversing lights 63
 Door-to-door illumination * 64
 Headlight range adjustment  * 64
 Interior lighting 64
 Headlights when driving abroad 66





Exterior lights

Turn light switch:

- 0** = Off
-  = Parking lights
-  = Dipped or main beam

Dipped / main beam and headlight flash - see page 10.

In positions  and , the tail lights and number plate light are also illuminated.

Vehicles with daytime running lights *:
 When the ignition is on, the dipped beam is on and the instrument illumination is subdued.

The daytime running lights go off when the ignition is switched off.

Follow the regulations of the country in which you are driving when using daytime running lights and front fog lights *.

Driving abroad - see page 66.

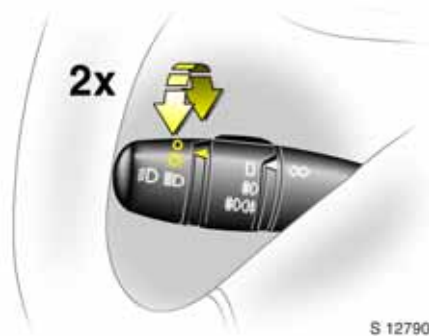

S 12790

Automatic dipped beam activation *

Dipped beam switches on or off automatically when the engine is running based on the outside light conditions.

The exterior lights switch off when the ignition is switched off.

To deactivate function:

1. Switch on the ignition.
2. Turn light switch to and return **0**.
3. Repeat stage 2 within approximately 5 seconds.

This action is confirmed with a single audible warning.

To activate:

1. Switch on the ignition.
2. Turn light switch to and return **0**.
3. Repeat stage 2 within approximately 5 seconds.

This action is confirmed with a double audible warning.

For reasons of safety it is advisable to have the automatic dipped beam function activated.

Turn signals, hazard warning lights

see page 11.



S 11658

Fog tail light

Front fog lights *

Rotate switch, control indicator and in instrument cluster illuminates:

- | | | |
|----------|---|--|
| 0 | = | Off |
| | = | Fog tail light on |
| and | = | Front fog lights and fog tail light on |

Reversing lights

Illuminate when reverse gear is engaged and ignition is switched on.

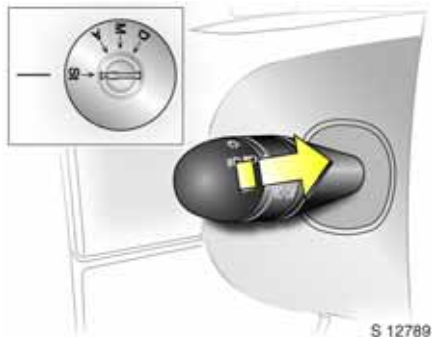

Door-to-door illumination *

The headlights are switched on and remain illuminated for a short time after the vehicle is parked.

To activate:

1. Switch off ignition.
2. Remove ignition key.
3. Open driver's door.
4. Pull stalk towards steering wheel.

The dipped beam illuminates for approx. 30 seconds. This action can be repeated up to four times to a maximum period of two minutes.

Switching on the ignition or rotating the light switch cancels the function before the lights automatically switch off.



Headlight range adjustment *

With dipped beam switched on, adjust headlight range to suit vehicle load.

Correct adjustment of the headlight range reduces dazzle for other road users.

- | | | |
|---|---|---|
| ■ No load | = | 0 |
| ■ Loaded up to permissible maximum weight | = | 4 |



Interior lighting *

Operated by the switch. With the switch in its central position, the light functions as a courtesy light *.

The courtesy light * operates when the front doors are opened or closed.

Once the front doors are closed, the courtesy light goes out after a 15 second delay.

When the keys are removed from the ignition the courtesy light * will illuminate for 15 seconds then gradually fade.

The courtesy light * extinguishes immediately if the ignition is switched on.

When the vehicle is locked or unlocked with the remote, the courtesy light * will illuminate for approx. 15 seconds then gradually fade.

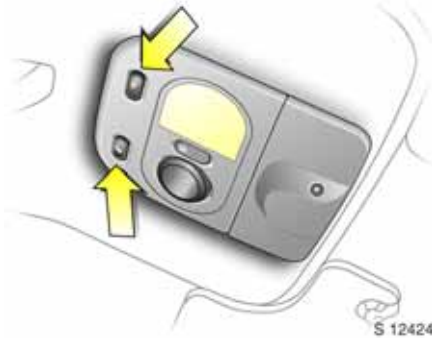

S 12424

Interior light and reading light

Each light can be independently operated by a switch nearest the respective light.

With the switch in its central position, the interior light functions as a courtesy light * and operates when the front doors are opened or closed.

On vehicles with remote control central locking, the courtesy light function incorporates a 15 second delay.

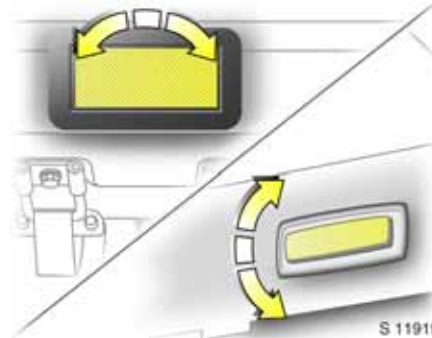

S 11919

Load and rear passenger compartment lights *

Operated by tilting the light lens to one of 3 positions:

- On constantly
- On when a rear door is opened
- Off constantly

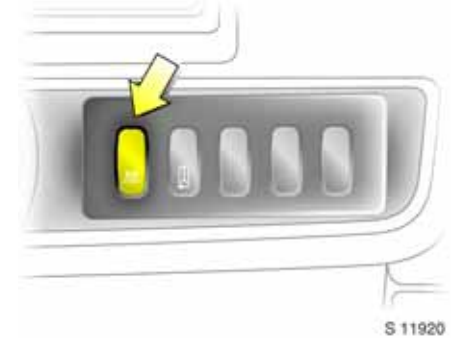

S 11920

Rear seating compartment lights *

Bus

The rear seating compartment has lights fitted for illuminating the rear seating area.

The button located on the instrument panel enables you to switch the lights on or off providing the lights are in the operating position.

Press  = On

Press  again = Off

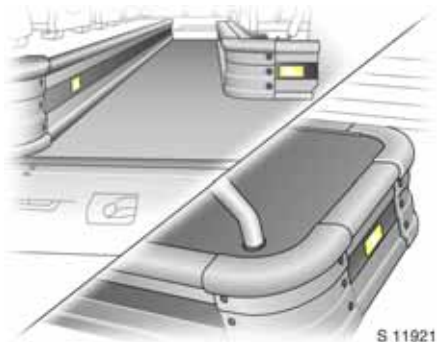

Low level interior lights ✱

Bus

Low level interior lights are installed. They are located on the raised seat platform along the centre aisle. The lights are operated by opening the sliding side door or rear door.



Rear interior light

Crew cab

Operated by tilting the lens to one of 3-positions:

- On constantly
- On when a rear door is opened
- Off constantly

Instruments, cigarette lighter and ashtray illumination

Illuminates when exterior lights are switched on.

Headlights when driving abroad

The asymmetrical dipped beam increases the field of vision on the near side of the lane.

To avoid glare, conventional headlight glasses must be provided with a black cover strip. Consult a workshop.

Windows

Door windows 67
 Sliding side windows *..... 68
 Electrically operated door windows * 68
 Opening upper windows *..... 69
 Sunroof * 69
 Emergency roof *..... 70

⚠ Warning

Care must be taken when operating the electrically operated windows. There is a risk of injury, particularly for children, and a danger that articles could become trapped.

Make sure that all vehicle occupants know how to operate the windows correctly.

Keep a close watch on the windows when closing them. Ensure that nothing becomes trapped in them.

Before leaving the vehicle, remove the ignition key in order to prevent unauthorized operation.



Door windows

The door windows can be operated with the crank.

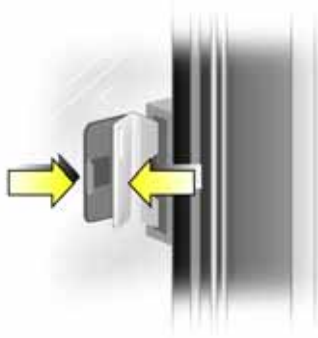

S 11924

Sliding side windows *

To open, pull up catch and slide open.

To close, pull up catch and slide window until catch engages.

Note: during window opening or closing, keep the catch raised to allow the glass sufficient clearance.



S 12427

Electrically operated door windows *

The driver's window is operated by the switch located in the driver's door.

To open the window, push the top of the switch and to close, pull the top of the switch. The window stops when switch is released.

With the engine running: briefly pushing or pulling the switch fully opens the driver's side window. Briefly press the switch again to stop the window during this operation.



S 12428

The passenger's window is similarly operated by a switch in each front door.

Warning

Before leaving the vehicle, remove the ignition key in order to prevent unauthorized operation of the windows - risk of injury.

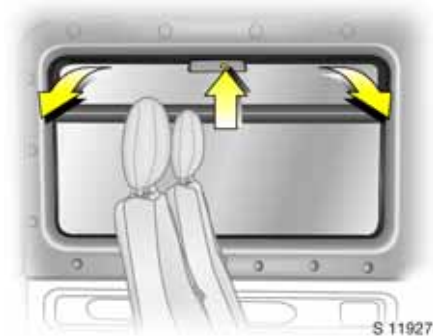

Opening upper windows *

To open upper window press catch to release and pull window inward until resistance is felt.

To close, push window back into its recess until catch engages.

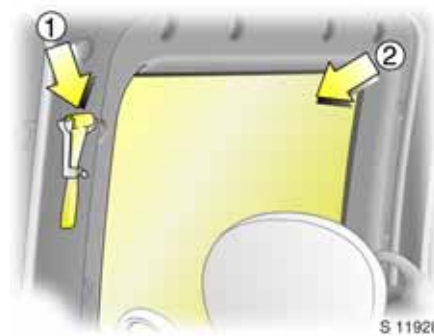

To provide an emergency exit from the vehicle, the centre fixed pane of glass can be broken. Use hammer * 1, located on window pillar to strike glass 2.

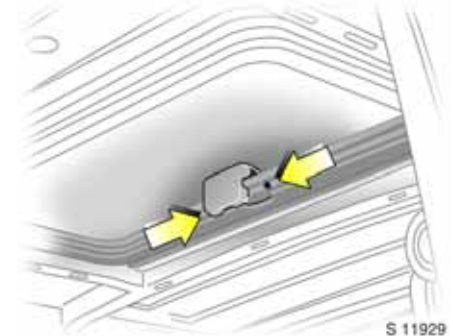

Sunroof *

To open the sunroof, pull the catch handle down to release it from its closed position. Depress the two lock buttons on either side of the handle and push upwards.

To close, depress lock buttons, pivot the catch handle down and back into its recess.

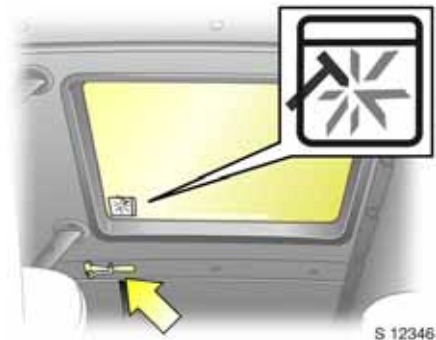

Emergency roof *

Bus

To provide an emergency exit from vehicle, the glass can be broken on the emergency roof. Use the hammer to break the glass panel.

Heating, ventilation

Heating and ventilation system 71
 Heating and ventilation controls 71
 Air vents 72
 Ventilation 73
 Heating 73
 Heating the footwell 74
 Window demisting 74
 Window defrosting 74
 Heated rear windows * 75
 Heated exterior mirrors * 75
 Air conditioning system * 75
 Air recirculation button 76
 Rear compartment air conditioning * 76
 Rear compartment additional heating * 77
 Heated front seats * 79

Heating and ventilation system

Vauxhall air mixture system: by mixing cold and hot air the temperature can be regulated without delay and held practically constant at all speeds.



Heating and ventilation controls

Air distribution switch

- To head area
- To head area and footwell
- To footwell
- To windscreen, front door windows and to footwell
- To defrost windscreen and front door windows
- To demist windscreen and front door windows¹⁾

The rotary knob can be set to any intermediate position in order to adjust the air distribution to suit personal requirements.

Open the air vents when the switch is set to or .

¹⁾ Air recirculation feature not possible when position selected.



S 11931

Temperature switch

To red Hotter

To blue Colder

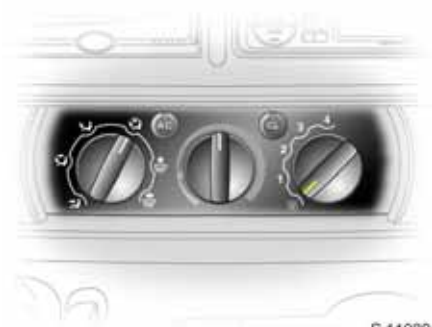

S 11932

Fan switch

Four speeds:

0 Off

4 High speed

The rate of airflow is determined by the fan. The fan should therefore also be switched on during driving.

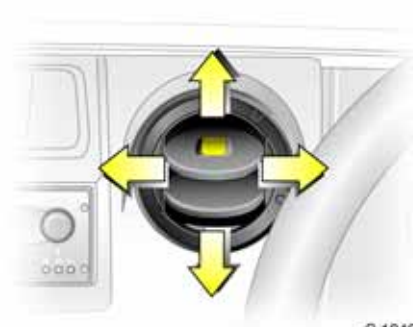

S 12429

Air vents

Centre air vents

Pleasant ventilation to the head area is controlled by the position of the temperature switch.

To open air vents, press the recess in centre of closed air vent.

☞ Open

● Closed

The air supply is increased by switching on the fan.

The airflow can be directed as desired by tilting and swivelling the fins.



S 12430

Side air vents



Depending upon the position of the temperature switch, air will be directed into the vehicle via these air vents.

The air vents are opened by means of pressing the recess in centre of closed air vent. To close swivel the fins to the closed position.

The airflow can be directed as desired by tilting and swivelling fins.

To increase the air supply, switch on the fan.



Door window defrosters

Air distribution switch set to  or : cold or heated air will be directed onto the windscreen and onto the door windows (mainly in the area of the exterior mirrors).



S 11935

Ventilation

- Turn temperature switch to blue.
- Switch on fan.
- For maximum ventilation in head area: set air distribution switch to  and open all air vents.
- For ventilation to footwell: set air distribution switch to .
- For simultaneous ventilation to head and footwells: set air distribution switch to .

Heating

The amount of heat is dependant on the engine temperature and is thus not fully attained until the engine is warm.

For rapid warming of the passenger compartment,

- Turn temperature switch to red.
- Switch on fan.
- Set the air distribution switch to the desired position.

The comfort and general well-being of the vehicle occupants are to a large extent dependent on a correct setting of the ventilation and heating.

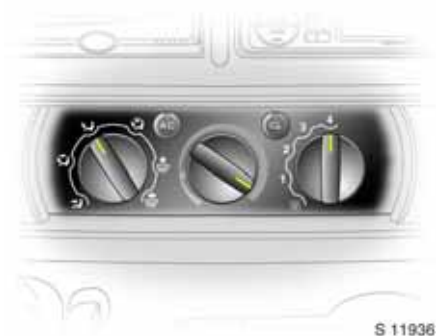

S 11936

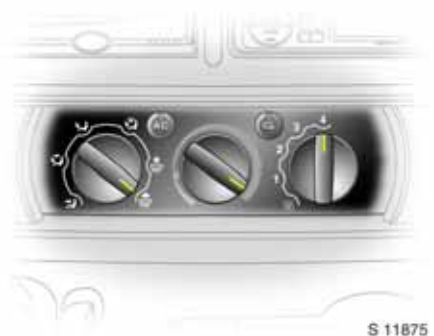

Heating the footwell

- Turn temperature switch to red.
- Set the air distribution switch to .
- Switch on fan.



S 11875

Window demisting

- Turn temperature switch to red.
- Switch on fan.
- Set air distribution switch to demist ¹⁾.
- Open side air vents as required and direct them towards the door windows.
- Close centre air vents.
- Switch on heated rear windows .

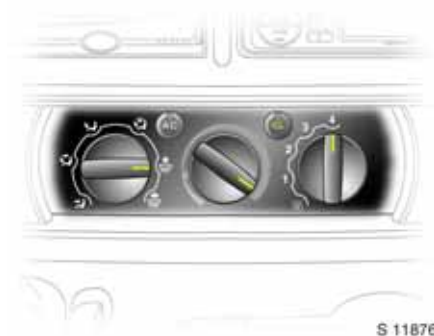

For simultaneous warming of the footwell, set air distribution switch to .

¹⁾ Air recirculation feature not possible when position selected. On vehicles equipped with air conditioning , the air conditioning is automatically activated when position selected.



S 11876

Window defrosting

- Turn temperature switch to red.
- Switch on fan.
- Set air distribution switch to defrost .
- Open side air vents as required and direct them towards the door windows.
- Close centre air vents.
- Switch on heated rear windows .

For simultaneous warming of the footwell, set air distribution switch to .



Heated rear windows *

Heated exterior mirrors *

Operate only with engine running.

Pushbutton  on instrument panel.

Press = on

Press again = off

Control indicator in pushbutton illuminates.

Turn off as soon as rear vision is clear. The heating switches off automatically after 10 minutes.

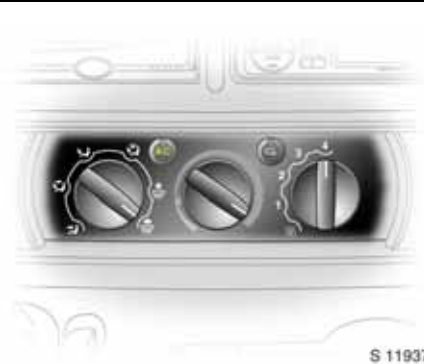

Air conditioning system *

The air conditioning system is designed to operate in conjunction with the heating and ventilation system to provide maximum comfort under any weather conditions.

The air conditioning system cools the air and removes moisture from it. It is operational only in temperatures above approx. +4 °C, with the engine running and with the fan switched on:

Press AC = on

Press AC again = off

Once activated the air conditioning system is operated via the normal heating and ventilation controls.

To improve efficiency of the air conditioning, always close the windows to prevent chilled air from escaping.

Switching on the air conditioning will assist in windscreen demisting.

In very hot temperatures, before switching on the air conditioning, allow hot air to escape from the vehicle by opening the windows.

When the system is switched on, at least one air vent must be open so that the evaporator does not ice up due to lack of air movement.

When the air conditioning is on, fuel consumption increases. Switch off the system whenever it is not required.

Maintenance

To ensure efficient performance of the air conditioning system, it must be switched on once a month for a short time, irrespective of the weather and time of year (possible only when outside temperature is above +4 °C).

Malfunctions in the system must not be rectified by the owner; consult a workshop.



S 11938

Air recirculation button

During "normal" operation, the heating, ventilation and air conditioning systems use outside air, however, to prevent fumes from entering the vehicle when in stationary traffic press the  button and air will be recirculated.

Recirculated air should only be used for brief periods due to the gradual deterioration in the air quality and increase in humidity.

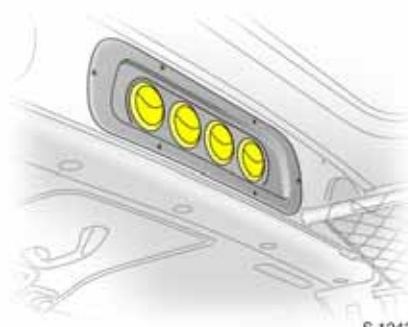

S 12431

Rear compartment air conditioning *

Bus

Additional air conditioning is supplied to the rear passenger compartment via the four air vents located above the driver and front passenger compartment. These can be positioned in the same way as the front centre and side air vents.

When the system is switched on, ensure that at least one of the air vents remains open so that the evaporator does not ice up due to lack of air movement.



S 11940

In order to operate the rear compartment additional air conditioning, the standard air conditioning system must be operated - see page 75.

The quantity and flow of air can be adjusted by rotating the knob located on the overhead control panel.

Three speeds:

- 0 Off
- 3 High speed

To increase rotate knob clockwise and to decrease rotate knob anticlockwise.



S 11941

Rear compartment additional heating *

If the engine is switched off the rear compartment can be heated by the additional heating, through low level vents. By programming values using the overhead control panel the user can adjust the time, day and temperature settings.

Note

When the rear compartment additional heating is switched on there may be briefly some smoke and noise.



Warning



Do not switch additional heating on in fuel stations or closed spaces - risk of injury.





S 11942

Setting the time and day

Press button  until the time display flashes. If the battery supply has been interrupted prior to its use press the  or  button briefly to make the time display flash.

Adjust the time using the  or  buttons.

The time is set when the displayed time stops flashing.

The display for the day will then flash: adjust the day using the  or  buttons.

The day is set when the display stops flashing.

The display will remain illuminated for approximately 15 seconds after the ignition is switched off.







S 11943

Operating and switching of the rear compartment additional heating

Press button  to operate heating. The tell-tale will appear on the display to indicate that the heating is operating.

Changing the period for which heating is operating

With the heating switched off  (tell-tale extinguished on display), press  button for approximately 3 seconds until the period for which heating is provided flashes on the display.

Use the  or  buttons to adjust the heating duration. The duration is set when the display extinguishes.



S 11944

Programming the heating mode

It is possible to store up to three programmes which allow the heating to be switched on.

Press **P** button the number of times for selecting the desired stored programme.

Press the ◀ or ▶ buttons briefly. the programming time flashes on the display.

Using the ◀ or ▶ buttons adjust to the desired time, as soon as the time display stops flashing adjust the day using the ◀ or ▶ buttons.

The time and day are set when the display stops flashing.



S 11945

Recalling a programming mode

To activate a stored programme press **P** button until the corresponding number appears on the display.

Neutral position or no stored programme activated

Press press **P** button until there is no stored programme number visible on the display.



S 11946

Adjusting the temperature

To adjust the temperature of the heating rotate the rotary knob located on the overhead control panel.

Rotate clockwise to increase temperature.

Rotate anticlockwise to decrease temperature.



Heated front seats *



Pushbutton  in trim panels of the seat belt buckle mountings. Operate only with engine running.

Press  = On

Press  again = Off

Seat heating is thermostatically controlled and will automatically cease when the seat temperature is sufficient. The control indicator will illuminate when system is on, not just when heating.

Tecshift

| | |
|--|----|
| Transmission display | 80 |
| Starting the engine | 80 |
| Tecshift operation | 81 |
| Winter programme  | 82 |
| Laden programme (kg)..... | 83 |
| Kickdown | 83 |
| Engine braking assistance | 83 |
| Stopping the vehicle | 84 |
| Parking | 84 |
| Rocking the vehicle..... | 84 |
| Manoeuvring the vehicle..... | 84 |
| Fault  | 85 |
| Interruption of power supply | 85 |

The semi-automatic Tecshift transmission permits manual (Manual mode) or automatic gearshifting (Automatic mode), both with fully automatic clutch control.

Warning

Disregard of these instructions may lead to injuries or endanger life.



Transmission display

Shows the mode, programme and current gear.

Starting the engine

Depress footbrake, turn on ignition. If control indicator  is shown in the transmission display, the footbrake is not depressed. When "N" is shown in the transmission display the engine can be started.

It is not necessary to select the neutral "N" position before starting. If a gear other than "N" is selected, depress the footbrake and there will be a short delay whilst the transmission automatically shifts into neutral.

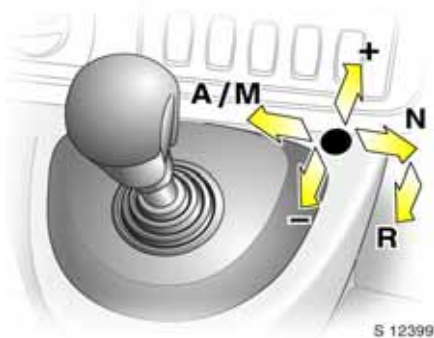

Tecshift operation

The selector lever needs to be moved in the appropriate direction only slightly. It then returns to the centre position. Observe the gear / mode indicator in the transmission display.

Selecting neutral

Move the selector lever towards **N**.

Automatic mode

When the engine is started, Tecshift is in Automatic mode "A" is shown in the transmission display.

To engage 1st gear depress footbrake and move selector lever towards **+**.

The vehicle will begin to "creep" when the footbrake is released without accelerating.

It is possible to start-off quickly by releasing the footbrake and accelerating.

In Automatic mode the transmission shifts to other gears automatically dependent on driving conditions.

Manual mode

Manual gearshifting is possible in Manual mode. If the vehicle is in Automatic mode, Manual mode can be selected by moving the selector lever towards **A/M**. The current gear will appear in the transmission display.

To engage 1st gear depress footbrake and move selector lever towards **+** or **-** and **1** will appear in the transmission display.

Moving selector lever toward:

- + Shifts to a higher gear.
- Shifts to a lower gear.

If the engine speed is too low Tecshift will automatically shift to a lower gear even in Manual mode. This prevents the engine from stalling.

If a higher gear is selected when the running speed is too low, or a lower gear when the speed is too high, no shift is effected. This prevents the engine from running at too low or too high revs.

Gears can be skipped by moving the selector lever repeatedly at short intervals.

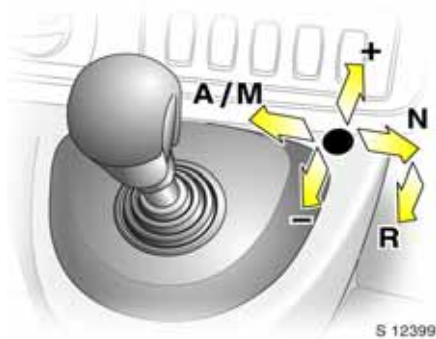

Selecting reverse

Engage only when the vehicle is stationary.

With the footbrake depressed, move the selector lever towards **R**. Reverse gear is engaged and "R" appears in the transmission display.

The vehicle begins to creep when the footbrake is released. Accelerate gently to move.



Winter programme ❄️

In the event of difficulties starting-off on slippery surfaces, press button ❄️ and ❄️ is shown in the transmission display. Tecshift switches to Automatic mode and the vehicle sets off in a suitable gear.

The Winter programme is switched off by:

- pressing button ❄️ again,
- turning off the ignition.

In order to protect Tecshift at extremely high clutch temperatures, an intermittent audible warning may sound. In such cases depress the footbrake, select "N" and apply the handbrake allowing the clutch to cool down.

If the vehicle is switched to Manual mode while Winter programme is active, the Winter programme is switched off.

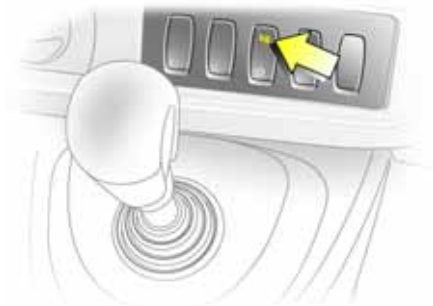

S 12436

Laden programme (kg)

It is possible to use Laden programme in both manual and Automatic modes. In both cases, the gearshifting patterns are adapted automatically for carrying an increased payload. Press button **kg**, Laden programme will be selected and **kg** will appear in the transmission display. Tecshift will then select optimized gearshift patterns.

The Laden programme is switched off by:

- pressing button **kg** again,
- turning off the ignition.

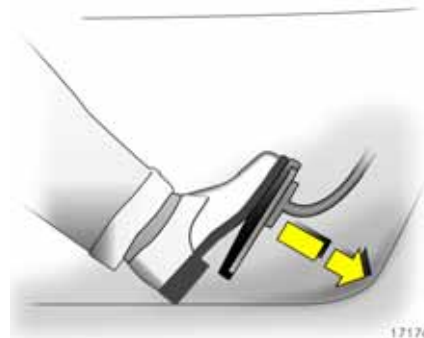

17176 T

Kickdown

Accelerator pedal pressed past the pressure point: below certain speeds, the transmission shifts down into a lower gear. Full engine power is available for acceleration.

When the engine speed approaches its upper limit, the transmission shifts to a higher gear during kickdown even in Manual mode.

Without kickdown this automatic shift is not affected in Manual mode.

Engine braking assistance

Automatic mode

When driving downhill Tecshift does not shift into the higher gears until a fairly high engine speed has been reached. During braking Tecshift shifts down to a lower gear in good time.

Manual mode

To utilize the engine braking effect, select a lower gear in good time when driving downhill.

Stopping the vehicle

In Automatic or Manual mode, once the vehicle is stationary first gear engages automatically and the clutch opens. In R, reverse remains engaged.

When stopping on gradients engage handbrake or depress brake pedal. To prevent overheating of the clutch, an intermittent, audible warning may sound as a signal to depress the footbrake or apply the handbrake.

Switch off engine if stopping for a lengthy period, e.g. in traffic jams.

Parking

Before leaving the vehicle:

- engage handbrake,
- remove ignition key.

The most recently engaged gear (indicator in transmission display) remains engaged. With **N**, no gear is engaged.

When the ignition is switched off Tecshift no longer responds to movements of the selector lever.

If the ignition is not switched off, or the handbrake has not been applied, an intermittent audible warning will sound upon opening the driver's door.

Rocking the vehicle

If it becomes necessary to rock the vehicle to free it from sand, mud, snow or a hole, move the selector lever between **R** and **A** (or + or -) in a repeat pattern while applying light pressure to the accelerator pedal. Do not race the engine and avoid sudden acceleration.

This applies only in exceptional circumstances mentioned above.

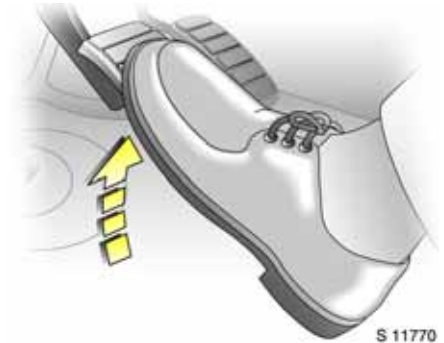

Manoeuvring the vehicle

To manoeuvre the vehicle back and forth during attempts to park or in garage entrances, the creeping movement can be utilized by releasing the footbrake.

Never actuate the accelerator and brake pedals simultaneously.

In order to protect Tecshift at extremely high clutch temperatures, an intermittent audible warning will sound. In such cases depress the footbrake, select "N" and apply the handbrake allowing the clutch to cool down.



Fault ⚡

If a fault occurs in Tecshift, control indicator ⚡ will be shown in the transmission display.

You can continue driving, provided you drive with care and anticipation. Consult a workshop to have the cause of the fault eliminated by a workshop. The system's integral self-diagnosis facility allows faults to be quickly remedied.

Interruption of power supply

The clutch is not disengaged if the vehicle battery is discharged and a gear has been selected. The vehicle cannot move.

If the battery is flat, start the vehicle using jump leads - see page 116.

If the cause of the interruption to the power supply is not a discharged battery, consult a workshop. We recommend your Vauxhall Authorised Repairer.

Driving hints

The first 600 miles (1000 km)

Drive your vehicle at various speeds. Do not use full throttle. Never allow the engine to labour at low revs.

Make good use of all gears. Depress the accelerator pedal a maximum of around three quarters of the available pedal travel in all gears and drive ranges.

Do not drive faster than three quarters of maximum speed.

The information concerns the engine and parts of the power train, e.g. the final drive.

Never coast with engine not running

Many units will then not function (e.g. turn signals, brake servo unit, power steering, airbag system). Driving in this manner is a danger to yourself and others.

Brake servo unit

With the engine not running the brake servo unit is no longer effective once the brake pedal has been depressed once or twice. The braking effect is not reduced but substantially greater foot pressure is necessary to stop the vehicle.

Power steering

Never leave the steering wheel on full lock when the vehicle is stationary as this may damage the power steering pump.

If the power steering should fail - e.g. when the vehicle is being towed with the engine switched off - the vehicle can still be properly steered but considerably greater effort is necessary.

Driving in mountainous terrain or with caravan / trailer

Electrically driven fan: The fan cooling capacity is not dependant on engine speed. It is not necessary, therefore, when driving uphill to shift down into a lower gear if the vehicle can climb in a higher gear.

Driving with a roof load

Do not exceed the permissible roof load. For safety reasons, distribute the load evenly and secure it tightly with straps so that it cannot slip. Set the tyre inflation pressure to the value given for full load. Do not drive faster than 75 mph (120 km/h). Check and retighten straps at frequent intervals.

Switching off the engine

If the engine temperature is very high, e.g. after driving in mountainous terrain: allow the engine to idle for approximately two minutes in order to prevent heat accumulation.

When you switch off, fans in the engine compartment may continue running for a time to cool the engine.

Vehicles with turbocharged engine

After running at high engine speeds or high engine loads, operate the engine briefly at a low load or run in neutral for approx. 30 seconds before switching off in order to protect the turbocharger.

Save energy – more miles / kilometres

Please observe the running-in hints on the previous page and the tips for energy saving on the following pages.

Good, technically correct and economical driving ensures maximum durability and performance for your vehicle.

Overrun

The fuel supply is automatically shut off during overrun, e.g. when the vehicle is being driven down long gradients or during braking. To enable the overrun cut-off to come into action, do not accelerate or declutch during overrun.

Engine rpm

Drive in a low engine speed range for each gear as much as possible.

Warming up

Run the engine warm, do not allow it to “tick over” when started from cold. Speed should be moderate until the engine has reached operating temperature.

After a cold start, Tecshift * do not shift into higher gears until higher engine speeds have been reached. This allows the catalytic converter to quickly reach the temperature required for optimum pollutant reduction.

Correct gear selection

Transmission in neutral and without revving in the lower gears. Stop-and-go traffic and driving at a speed too high for the selected gear or transmission ratio increases wear and fuel consumption.

Change down

When decreasing speed shift down into the next lowest gear. Do not slip the clutch with a high-revving engine. This is especially important when hill climbing.

Clutch operation

Always depress the clutch pedal hard to the floor to prevent shifting difficulties and transmission damage. There must be no mats in the area of the pedals.

When driving do not use the pedal as a footrest; this will cause substantial clutch wear.

Pedals

Do not place any objects in the footwell which could slip under the pedals and inhibit the pedal travel.

To ensure the pedal travel is uninhibited, there must be no mats in the area of the pedals.

Battery care whilst driving

When driving slowly or when the vehicle is stationary, e.g. in slow urban traffic, stop-and-go traffic or traffic jams, turn off all unnecessary electrical loads where possible (e.g. heated rear window, heated seats).

Declutch when starting in order to relieve the strain on the starter and battery.

Save fuel, protect the environment

Trend-setting technology

When developing and manufacturing your vehicle, Vauxhall used environment-friendly and in the main recyclable materials. The production methods used to make your vehicle are likewise environmentally-compatible.

Recycling of production wastes keeps the circulation of material closed. Reduction of energy and water requirements also helps to conserve natural resources.

A highly advanced design means that your vehicle can be easily disassembled at the end of its working life, and the individual materials separated for subsequent re-use.

Materials such as asbestos and cadmium are not used. The refrigerant in the air conditioning system * is CFC-free.

New painting techniques employ water as a solvent.

End-of-life vehicle recovery

For detailed information on Vauxhall's on-going commitment to achieving an environmentally sustainable future, including; design for recycling, take back of End-of-Life Vehicle's (ELVs) and the recycling of ELVs, view www.vauxhall.co.uk/recycling for details.

Drive in an energy and environment-conscious way

■ High fuel consumption, noise levels and exhaust emission are often caused by a driving style that is not energy and environment-conscious.

■ You should therefore drive with energy in mind: "more miles with less fuel".

Reduce the noise level and exhaust emissions by adopting an environment-conscious driving style. This is extremely worthwhile and improves the quality of life.

Fuel consumption depends to a great extent on your own personal driving style. The following hints are intended to help you consume fuel at a rate that is as close as possible to the specified levels.

Check your vehicle's fuel consumption every time you refuel. This facilitates early detection of any irregularities causing increased fuel consumption.

Warming up

- Full throttle and warming up at idle speed increase wear, fuel consumption, fuel emission, the amount of pollutant in the exhaust and the amount of noise.
- Drive off immediately after starting. Warm up the engine by running it at moderate engine speeds.

Uniform speed

- Hectic driving significantly increases fuel consumption, the quantity of emission and the proportion of pollutant in the exhaust.
 - Do not accelerate and brake unnecessarily. Drive at uniform speed.
- Avoid frequent starting-off and stopping e.g. at traffic lights, in short distance traffic and in queues of traffic by means of clever planning. Select roads with good traffic flow.

Idling

- The engine also consumes fuel when idling.
- If you have to wait for more than one minute, it is worthwhile switching off the engine. Five minutes of idling corresponds to approx. 0.6 miles (1 km) of driving.

Overrun

- The fuel supply is automatically shut off during overrun, e.g. when the vehicle is being driven down long gradients or during braking - see page 87
- To enable the overrun cut-off to take effect and save fuel, do not accelerate or declutch.

Correct gear selection

- High revs increase engine wear and fuel consumption.
- Do not race your engine. Avoid driving at high engine speeds.

Driving with an eye on the tachometer saves fuel. If possible, drive at low revs in each gear and at constant speed. Drive in top gear as much as possible, shift up as soon as possible and do not shift down until the engine is no longer running truly.

High speed

- The faster the speed, the higher the consumption and noise level. Driving at full throttle uses up a great deal of fuel and generates excessive noise and high emission levels.

- Slightly releasing the accelerator pedal results in distinct fuel savings with no major loss of speed.

Drive at no more than around three quarters of maximum speed and you will use up to 50% less fuel, without losing a great deal of time.

Tyre inflation pressure

- Inadequate tyre inflation pressure, leading to higher road resistance, costs money in two ways: for more fuel and increased tyre wear.
- Regular checks (every 14 days) pay off.

Electrical loads

- The power consumption of electrical equipment increases fuel consumption.
- Switch off all additional consumers (e.g. air conditioning ✳, heated rear window ✳) when they are no longer required.

Roof racks

- Roof racks can increase fuel consumption by approximately 3.5 gal./1000 miles (1 l/100 km) due to air resistance.
- Remove them if they are not being used.

Repair and maintenance

- Improper repairs or adjustment and maintenance work can increase fuel consumption. Do not carry out work on the engine yourself.

You may out of ignorance infringe environmental laws by not disposing of materials properly.

Appropriate parts might not be recycled.

Contact with some of the materials involved may pose a health hazard.

- We recommend that repairs and maintenance be entrusted to a Vauxhall Authorised Repairer.

Extreme driving conditions

- Driving up steep gradients, cornering, driving on poor roads, and winter driving all increase fuel consumption.
- Fuel consumption increases dramatically in urban traffic and at winter temperatures, especially on short trips when the engine operating temperature is not reached.
- Follow the hints given above to keep consumption to a minimum under such conditions.

Fuel consumption, fuel, refuelling

| | |
|------------------------------|----|
| Fuel consumption | 90 |
| Fuel for diesel engines..... | 90 |
| Refuelling..... | 91 |
| Fuel cut-off device * | 91 |

Fuel consumption

Fuel consumption is determined under specific driving conditions.

Fitting special equipment will increase the weight of the vehicle. This in turn increases fuel consumption and reduces the specified maximum speed of the vehicle.

For the first few thousand miles / kilometres, friction between the engine and transmission components is higher. This increases fuel consumption.

Fuel for diesel engines

Diesel engines must be operated only on commercially available diesel fuel meeting the specifications of DIN EN 590.

Since January 2004, some oil companies have mixed their diesel fuel with up to 5% Bio fuel (FAME = Fatty Acid Methyl Esters) like RME (Rape-Oil Methyl Ester). This is in accordance with the current DIN EN 590 and does not harm the fuel injection system. The characteristics of a diesel fuel mixed up with 5% Bio fuel (FAME) do not differ from conventional diesel fuel and do not influence the vehicle's driveability.

Important: Diesel fuel mixed with 5% FAME according to DIN EN 590 must not be confused with 100% Bio Diesel, which is not to be used in Vauxhall engines.

The flow and filterability of diesel fuel are temperature-dependent.

Diesel fuels with improved low temperature properties are therefore available on the market during the winter months. Make sure that you fill the tank with winter fuel before the start of the cold weather season.

Additives can be used with diesel fuels with winter properties that are guaranteed by the manufacturer and when using diesel fuel filters that are heated depending on the outside temperature.

Diesel fuels must not be diluted with fuels that are intended for petrol engines.

Refuelling

Warning

Care must be taken when handling fuel.

Before refuelling, switch off the engine and any external heaters with combustion chambers (identified by a sticker on the tank flap). Switch off mobile phones.

Fuel is flammable and explosive. Therefore, avoid naked flames and sparks when handling or in the vicinity of fuel. Do not smoke! This also applies in places where fuel can only be detected by its characteristic smell. If you can smell fuel in the vehicle, have the cause thereof remedied immediately by a workshop.



S 11950

Correct filling depends to a large extent on proper operation of the fuel dispensing pump:

1. Fully insert the pump nozzle and switch it on.
2. After the automatic cut-off, the nominal capacity of the tank can be obtained by topping up with two doses of fuel. Make sure the nozzle is fully inserted.

To close the filler cap, refit it and rotate it clockwise against resistance until the filler cap ratchet audibly clicks.

Wipe off any overflowing fuel immediately.

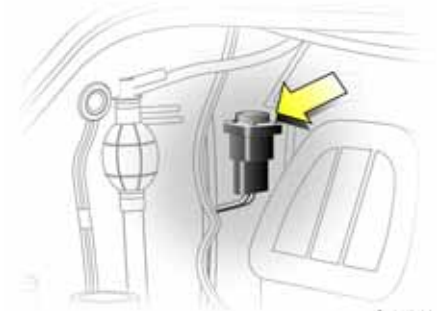

S 11951

Fuel cut-off device *

If the vehicle is involved in a collision, the fuel cut-off device automatically isolates the fuel supply.

Prior to restarting first check:

- that the vehicle is driveable
- there is no smell of fuel
- fuel is not leaking

To restart the fuel supply, reset the cut-off device by pressing down the button.

Catalytic converter, exhaust emissions

| | |
|--|----|
| Catalytic converter for diesel engines | 92 |
| Controlling exhaust emission..... | 92 |
| Diesel particle filter *..... | 93 |
| Engine oil life monitor *..... | 94 |
| Exhaust gases..... | 94 |
| Maintenance..... | 95 |

Catalytic converter for diesel engines

Damage to the catalytic converter or the vehicle may result if the following points are not observed:

Consult a workshop as quickly as possible in the event of irregular engine running, a significant loss of engine power or other unusual malfunctions. If necessary, driving may be continued for a short time at a low speed and with a low engine speed.

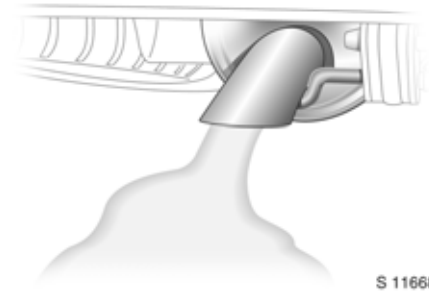

S 11668

Controlling exhaust emission

Through design-related measures - mainly in the area of the mixture formation system - the proportion of noxious materials in the exhaust, such as carbon monoxide (CO), hydrocarbons (CH) and nitrogen oxides (NO_x), is reduced to a minimum.



S 12437

Control indicator for exhaust emissions

If it illuminates while the engine is running, it is possible a fault has occurred in the emission control system. The permitted emission values may be exceeded. Consult a workshop immediately.



S 14351

Control indicator for engine electronics

Illuminates for a few seconds when ignition is switched on.

If the control indicator illuminates when the engine is running, there is a fault in the engine electronics. The electronics switch to the emergency running programme, fuel consumption may increase and the driveability of the vehicle may be affected. In some cases the fault can be eliminated by switching the engine off and back on again. If the control indicator illuminates again when the engine is running, consult a workshop to have the cause of the fault eliminated by a workshop.



S 12780

Diesel particle filter *

Even during normal use, there is still a possibility that the diesel particle filter may become partially blocked. The filter is automatically cleaned under certain driving conditions, however when control indicator  is illuminated, the diesel particle filter requires driver-induced regeneration¹⁾.

Warning



Before attempting regeneration of the diesel particle filter, ensure road conditions will allow the vehicle to safely travel at speeds in excess of approx. 40 mph (60 km/h) for up to 20 minutes.

¹⁾ During regeneration, white smoke can be emitted from the exhaust which is not detrimental to the vehicle.

To carry out regeneration¹⁾:



With the engine at normal operating temperature, maintain an average speed of approx. 40 mph (60 km/h) until control indicator  goes out. In some cases this can take up to 20 minutes.



Failing to achieve these speeds or an interruption to your journey may prevent regeneration taking place. The regeneration process will then need to be restarted.

If control indicator  fails to extinguish or illuminates in conjunction with , consult a workshop to have the cause of the fault eliminated.



Engine oil life monitor *

If control indicator  illuminates and control indicator  flashes continuously in the display, the engine oil has become oxidized.

If the engine oil has become diluted, control indicator  will illuminate in conjunction with control indicator . In either case it is necessary to carry out an engine oil and oil filter change and to reset the engine oil life monitor.

Make an appointment with a workshop for service work as soon as possible. We recommend your Vauxhall Authorised Repairer.

Exhaust gases

 Warning

Engine exhaust gases contain poisonous carbon monoxide, which has no colour or odour and can be lethal if inhaled.

If exhaust fumes penetrate the vehicle interior, open the windows and consult a workshop immediately.

When the vehicle is driven for the first time, wax and oil on the exhaust system may evaporate, producing smoke-like emissions which should not be inhaled. Allow wax and oil to evaporate while the vehicle is in the open air. Avoid inhaling.

¹⁾ Where speed limits and traffic conditions permit.

Maintenance

Have all maintenance work carried out at the intervals specified by Vauxhall. We recommend that you entrust this work to your Vauxhall Authorised Repairer, who has proper equipment and trained personnel available. Electronic testing systems permit rapid diagnosis and remedy of faults. This way you can be certain that all components of the vehicle's electrical, injection and ignition systems operate correctly, that your vehicle has a low level of pollutant emission and that the catalytic converter system will have a long service life.

You are thereby making an important contribution towards keeping the air clean and compliance with emissions legislation.

Checking and adjustment of the fuel-injection and ignition systems is part of the scope of a Service. For this reason you should have all maintenance work carried out at the intervals specified in your Service Booklet.

Drive Control Systems

Electronic Stability Programme (ESP) *

The ESP (Electronic Stability Programme) * improves driving stability when necessary, independently of the type of road surface and the tyre grip. It also includes the Traction Control system function.

The system monitors vehicle movements. As soon as the vehicle starts to swerve (understeers / oversteers) engine output is reduced (the sound of the engine changes) and individual wheels are specifically braked. This considerably improves the driving stability of the vehicle on slippery road surfaces.

The ESP is ready for operation as soon as the ignition is switched on and the control indicator  goes out.

When the ESP comes into action,  flashes.

The vehicle is now in a critical situation; the ESP assists you to keep control of the vehicle and reminds you to match your speed to the road conditions.

Warning

Do not let this special safety feature tempt you into taking risks when driving.

Traffic safety can only be achieved by adopting a responsible driving style.



Control indicator

Illuminates for a few seconds when ignition is switched on. The system is now ready for operation.

Flashing during driving:

This shows the system has come into action. The engine output may be reduced (the sound of the engine changes) and the vehicle may be braked automatically to a small degree.

Illuminated during driving:

Fault in the system. Driving can be continued. Poor road surface conditions may however still cause vehicle stability to be impaired.

Have the cause of the fault remedied by a workshop. The system's integrated self-diagnostics allows faults to be quickly remedied.



Switching off

The traction control function of ESP can be switched off by pressing the  button.

When deactivated, control indicator  in the instrument cluster illuminates.

The function is switched on again by pressing the  button again or the next time the ignition is switched on.

Chassis systems

Air suspension *..... 98
Cruise control *..... 99
Cruise control speed limiter *..... 100
Parking distance sensors *..... 102



S 11953

Air suspension *

Operates automatically when the vehicle is driven.

The air suspension system adjusts the ride height of the rear of the vehicle according to the weight of the load.

If the red control indicator  illuminates in the instrument cluster, there is a fault. Consult a workshop. We recommend your Vauxhall Authorised Repairer.



S 12439

Manual operation

Operative with the ignition on and handbrake applied.

To lower: Push  button once.

To raise: Push  button again.

Whilst in operation, the light on the switch will flash intermittently until the correct height is achieved.

| |
|--|
|  Warning |
| After manual operation, the air suspension will automatically adjust when the handbrake is released. |

Cruise control *

The cruise control makes it possible to store and maintain any speed from approx. 20 mph (30 km/h) to almost maximum speed.

The cruise control is operated with the switches located on the instrument panel.

Do not use the cruise control if it is not advisable to maintain a constant speed (e.g. in situations presenting a danger to yourself or other road users, in heavy traffic or on winding, slippery or greasy roads).

With Tecshift *, it is advisable to only use cruise control in "A"; Automatic mode.

When cruise control is active, reaction times may be increased due to the different position of your feet.



Warning

Disregard of these instructions may lead to injuries or endanger life.



S 12440

To activate¹⁾:

Press switch , the  control indicator in instrument cluster illuminates green: cruise control is now active. The stored vehicle speed information appears on the multi-function display.



S 12441

Press switch + -. The current speed is now stored and maintained and the accelerator pedal can be released.

The vehicle speed can be increased or decreased by holding down switch + - or tap repeatedly:

Press - to decrease the speed,
Press + to increase the speed.

Vehicle speed can be increased at any time by depressing the accelerator pedal.

¹⁾ Switch location may vary according to equipment levels.



To deactivate:

Press switch , the cruise control is deactivated. The vehicle slowly decelerates. To continue driving depress the accelerator pedal in the usual way. Cruise control is also deactivated if:

- The clutch pedal is depressed.
- The brake pedal is depressed.
- The vehicle speed drops below approx. 20 mph (30 km/h).



Cruise control speed limiter *

The speed limiter prevents the vehicle exceeding a preset maximum speed above approx. 20 mph (30 km/h).

To activate¹⁾:

Press switch , control indicator in instrument cluster illuminates orange: speed limiter becomes active and trip computer enters speed limiter mode.



Press switch + -: the speed limit is then stored and is displayed on the trip computer.

When the speed limit is stored, the vehicle can be driven normally but it will not be possible to exceed the programmed speed except in an emergency.

Exceeding the speed limit in the event of an emergency - see page 101.

¹⁾ Switch location may vary according to equipment levels.



The speed limit can be increased or decreased by holding down switch + - or tap repeatedly:

Press - to decrease the speed limit,
Press + to increase the speed limit.

Where the speed limit cannot be maintained for example when driving on a steep incline, the speed limit will flash on the trip computer display¹⁾.

Exceeding the speed limit

In the event of an emergency it is possible to exceed the speed limit by: depressing the accelerator firmly beyond the point of resistance.

The speed limit will flash on the trip computer display to inform you that the stored speed is being exceeded.

Release the accelerator pedal and the speed limiter function will return once a speed lower than the speed limit is reached.



To deactivate:

Press switch : speed limiter is deactivated and the vehicle can be driven normally.

¹⁾ In such instances it remains the driver's responsibility to adhere to the specific speed limits.



Parking distance sensors *

The parking distance sensors make reverse parking easier by measuring the distance between the rear of the vehicle and an obstacle through ultrasonic reflection and warning you with an acoustic signal in the passenger compartment.

The system records the distance using sensors in the rear bumper.

The parking distance sensors are automatically enabled when the ignition is switched on and reverse gear is selected. Readiness for operation is indicated by brief acoustic alarm.

As the vehicle slowly gets close to an object while reversing, an intermittent acoustic signal is audible in the passenger compartment.

The interval between the signals becomes shorter as the distance is reduced. If the distance is less than 25 cm, a continuous signal is audible.

Warning

Under certain circumstances, various reflective surfaces on objects or clothing as well as external noise sources may cause the system to fail to detect obstacles. For this reason, care must be taken when reversing even if the parking distance sensors are operational. This is of particular importance when in the vicinity of pedestrians.

The system registers the distance by means of sensors on the rear bumper. To ensure that the sensors function correctly and that the information provided is accurate, they must be undamaged and free of dirt, snow and ice.

Should the parking distance sensors fail to operate, consult a workshop.

If towing equipment is required for your vehicle, we recommend contacting your Vauxhall Authorised Repairer.

Brakes

The effectiveness of the brakes is an important factor for traffic safety.

In the interest of effectiveness, do not brake unnecessarily hard during the first 120 miles (200 km) after new disc brake pads have been fitted.

Wear of the brake linings must not exceed a certain limit. Regular maintenance as detailed in the Service Booklet is therefore of the utmost importance for traffic safety.

Have worn brake pads replaced. We recommend that you consult your Vauxhall Authorised Repairer, who will fit parts that have been tested and approved by Vauxhall and guarantee optimum braking power.

| | |
|-----------------|-----|
| Footbrake..... | 104 |
| Handbrake | 104 |
| ABS (®) | 105 |

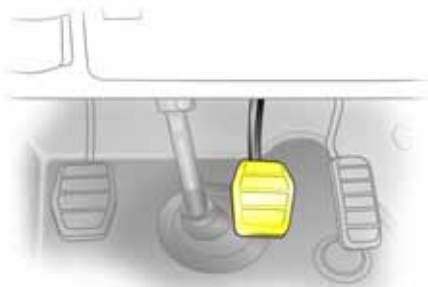

S 11965

Footbrake

The braking system comprises two separate, brake circuits. If one brake circuit should fail, the vehicle can still be stopped with the second remaining circuit. If this happens, the brake pedal must be fully depressed with greater pedal pressure. The distance required for braking will be greater. Before continuing your journey, consult a workshop.

In order to utilise the full pedal travel - particularly in the event of a brake circuit fault - there must be no mats in the area of the pedals.

With the engine stopped the servo assistance is discontinued after the brake pedal has been depressed once or twice. The braking action will not be reduced but greater pedal pressure will be necessary. Take extra care when the vehicle is being towed.

Check the brake lights before starting out on a journey.

Shortly after starting each journey the effectiveness of the brake system should be tested at low speed without inconveniencing other traffic, especially if the brakes are wet, e.g. after the vehicle has been washed.

The brake fluid level should be checked regularly. If the brake fluid level is too low and the handbrake is not applied, control indicator (D) in the instrument cluster illuminates - see page 20.



S 12401

Handbrake

Always apply handbrake firmly. On slopes apply the handbrake as firmly as possible.

The mechanical handbrake acts on the brakes on the rear wheels. It engages automatically when applied.

To release the handbrake pull the lever up slightly, press the ratchet knob, and fully lower the lever.



Control indicator (ⓘ) for brake system

Control indicator illuminates when ignition is switched on if handbrake is applied and/or fluid level for brake system is too low. Brake fluid level - see page 142.

Warning

If the control indicator illuminates when the handbrake is not applied: stop vehicle; interrupt your journey immediately. Consult a workshop.

ABS (ABS)

The ABS (Anti-lock Brake System) continuously monitors the vehicle's brake system and prevents the wheels from locking, irrespective of the road condition and tyre grip.

It starts to regulate the braking pressure as soon as a wheel shows a tendency to lock. The vehicle remains steerable, even in the event of very heavy braking, for instance on bends or when swerving to avoid an obstacle. Even in the case of full-on braking, the ABS makes it possible to drive round an obstacle without releasing the brakes.

ABS control is made apparent through a pulse in the brake pedal and the noise of the regulation process.

⚠ Warning

For optimum braking, keep the brake pedal fully depressed throughout the braking process, despite the fact that the pedal is pulsating. Do not reduce the pressure on the pedal.

Do not let this special safety feature tempt you into taking risks when driving.

Traffic safety can only be achieved by adopting a responsible driving style.



Control indicator for ABS

When the ignition is switched on, the ABS control indicator illuminates. At the same time, the system performs a self-check which may be audible. When the control indicator goes out the system is ready for operation.

If the control indicator does not go out after a few seconds, or if it illuminates during driving, there is a fault in the ABS. The vehicle's brake system remains operational without ABS regulation.

⚠ Warning

If there is a fault in the ABS, the rear wheels may tend to lock in the event of unusually heavy braking. This may cause the vehicle to swerve. The benefits of the ABS are lost.

You can continue driving, provided you drive with care and anticipation

Have the cause of the fault remedied by a workshop. The system's integrated self-diagnostics allows faults to be quickly remedied.

Wheels, tyres

| | |
|---------------------------------------|-----|
| Tyres | 107 |
| Tyre inflation pressure..... | 107 |
| Tyre condition, wheel condition | 108 |
| Winter tyres *..... | 110 |
| Tyre chains *..... | 111 |

Tyres

See page 159 for suitable tyres and restrictions.

Factory-fitted tyres are matched to the chassis and offer optimum driving comfort and safety.

Changing tyre / wheel type

Before switching to different tyres or wheels, seek advice on technical possibilities. We recommend that you consult your Vauxhall Authorised Repairer, who will be able to advise you of any necessary modifications.

Warning

Use of unsuitable tyres or wheels may lead to accidents and render the vehicle unroadworthy.

Fitting new tyres

New tyres should be fitted in pairs, or for preference in sets. Make sure that both tyres on an axle are

- the same size
- the same design
- the same make
- and have the same tread pattern.

Warning

We recommend that you consult your Vauxhall Authorised Repairer to have the tyres replaced. Your Vauxhall Authorised Repairer knows the legal regulations concerning the disposal of tyres and therefore protects the environment and your health.

Tyre inflation pressure

Check tyre inflation pressures, including the spare wheel, at least every 14 days and prior to any long journey. The tyres should be checked when cold. Don't forget to check the spare.

Tyre inflation pressures - see page 159.



Increased pressure resulting from tyre warm-up must not be reduced, otherwise the pressure may drop below the permissible minimum.

After having checked the tyre inflation pressures, securely tighten the valve caps.

Incorrect inflation pressures will impair safety, vehicle handling, comfort and fuel economy and will increase tyre wear.

⚠ Warning

If the pressure is too low, this can result in considerable tyre warm-up and internal damage, leading to tread separation and even to tyre blow-out at high speeds.

Hidden tyre damage is not eliminated by subsequently adjusting the inflation pressure.



Tyre condition, wheel condition

Driving over sharp edges can lead to hidden tyre damage and wheel damage which is only noticed later on: there is a danger of tyre blow-out.

Drive over edges slowly and at a right angle if possible. When parking, ensure that the tyres are not pressed against the edge of the kerb.

Check tyres regularly for damage (foreign bodies, punctures, cuts, cracks, bulges in sidewalls). Check wheels for damage. In the event of damage or abnormal wear, consult a workshop.

⚠ Warning

Damage may lead to tyre blowout.

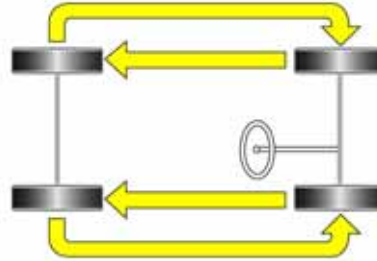

S 11568

Tread depth

Check tread depth regularly. Should the front tyres show greater wear than the rear tyres, have both front wheels exchanged with the rear wheels so that the tyres with deeper tread are on the front axle.



17216 T

For safety reasons, tyres should be replaced when their tread depth has worn down to 2-3 mm. The legal permissible minimum tread depth (1.6 mm) has been reached when the tread has worn down as far as one of the wear indicators. A number of wear indicators are spaced at equal intervals around the tyre within the tread. Their position is indicated by markings on the tyre sidewall.

General information

Note that the danger of aquaplaning is greater if the tyres are worn.

Tyres age, even if they are used only very little or not at all. A spare wheel * which has not been used for six years should be used with care.

Never fit used tyres the previous history and use of which you do not know.

Tyre designations

Meanings:

e.g. **195/65 R 16 C**

195 = Tyre width in mm

65 = Aspect ratio in %
(tyre height to tyre width in %)

R = Belt type: Radial

16 = Rim diameter in inches

C = Cargo or Commercial use



S 11969

Winter tyres *

See page 159 for restrictions.

M+S tyres improve safety at temperatures below 7 °C and should therefore be fitted on all wheels.

The design of summer tyres means they have limited qualities for winter driving.

If the maximum permissible speed for the winter tyres is less than that of the vehicle, a notice indicating the maximum permissible speed for the tyres must be affixed within the driver's field of vision *¹⁾.

If you use winter tyres *, the spare wheel may still be fitted with a summer tyre. If you use the spare wheel the vehicle's handling may be altered. Obtain a replacement for the faulty tyre as soon as possible, and have the wheel balanced and fitted to the vehicle.

¹⁾ Varies from country to country on account of national regulations.



S 11970

Tyre chains *

See page 159 for restrictions.

Tyre chains may be used only on the drive wheels (front axle). They must be fitted symmetrically on the tyre to ensure that they are seated concentrically.

Only fine-linked chains - not protruding more than 15 mm on the tyre tread and inboard sides (including chain lock) - as recommended by Vauxhall may be used.

Wheel covers on steel wheels may come into contact with parts of the chains. In such cases, remove the wheel covers.

Tyre chains may only be used at speeds up to 30 mph (50 km/h) and, when travelling on roads that are free of snow, they may only be used for brief periods since they are subject to rapid wear on a hard road and may snap.

Roof rack, caravan and trailer towing

| | |
|--|-----|
| Roof racks *..... | 112 |
| Towing equipment *..... | 112 |
| Caravan / trailer loads | 112 |
| Coupling socket load..... | 113 |
| Rear axle load during towing | 113 |
| Tyre inflation pressure..... | 113 |
| Driving characteristics, towing tips ... | 113 |
| Starting on inclines | 114 |

Warning

Disregard of these instructions may lead to injuries or endanger life. Vehicle passengers must be informed accordingly.

Roof racks *

For safety reasons and to avoid damaging the roof, we recommend the Vauxhall roof rack system. Your Vauxhall Authorised Repairer will be happy to advise you.

Driving hints - see page 86.

Towing equipment *

We recommend that towing equipment be installed by a Vauxhall Authorised Repairer, who can inform you about possible increases in the caravan / trailer load. Your Vauxhall Authorised Repairer will also be in possession of specifications concerning installation as well as any necessary modifications to the vehicle regarding the cooling system or other features.

Mounting dimensions of towing equipment see page 165.

Caravan / trailer loads¹⁾

The permissible caravan / trailer loads are vehicle-dependent and engine-dependent maximum values which must not be exceeded. The actual caravan / trailer load is the difference between the actual gross weight of the caravan / trailer and the actual coupling socket load with the caravan / trailer coupled. When the caravan / trailer load is being checked, therefore, only the caravan / trailer wheels - and not the jockey wheel - must be standing on the weighing apparatus.

The permissible caravan / trailer loads for your vehicle are given in the vehicle documents²⁾. Unless otherwise stated, they are valid for gradients up to max. 12%.

The permissible caravan / trailer load should be fully utilized only by drivers who are adequately experienced in towing large caravans / trailers.

In higher elevations the engine output and gradability may drop so that it may not be possible for the permissible caravan / trailer loads to be fully utilized in mountainous territory.

1) Observe national regulations.

2) Gross Combination Weight - see page 152.

Coupling socket load

The coupling socket load is the load exerted by the caravan / trailer on the coupling ball. It can be varied by changing the weight distribution when loading the caravan / trailer.

The maximum permissible coupling socket load for the towing vehicle, stated on the label, should always be aimed for, particularly in the case of heavy caravans / trailers. The coupling socket load should never be below 25 kg.

When measuring the coupling socket load, make sure that the drawbar of the loaded caravan / trailer is at the same height as it will be when the caravan / trailer is coupled with the towing vehicle loaded. Particularly important for caravan / trailer with tandem axle.

Rear axle load during towing

When the caravan / trailer is coupled and the towing vehicle fully loaded (including all occupants), the permissible rear axle load must not be exceeded.

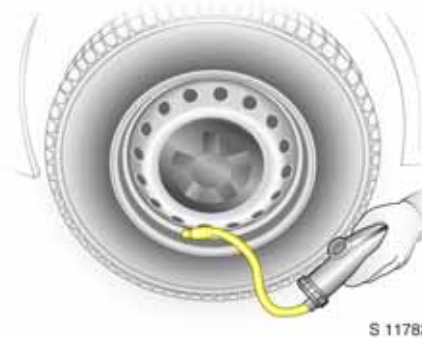

Tyre inflation pressure

Increase the tyre inflation pressure on the towing vehicle to the value given for full load (see page 159). Also check the pressure of the caravan / trailer tyres.

Driving characteristics, towing tips

In the case of caravans / trailers with brakes, attach the breakaway stopping cable.

Before coupling the caravan / trailer, lubricate the ball of the caravan / trailer towing device. However, do not do so if a stabilizer which acts on the coupling ball is being used to damp rolling motions.

Genuine Vauxhall Parts and Accessories which can be subsequently fitted aid trailer operation, e.g. large mirrors for wide caravan / trailer.

In the case of caravan / trailer with low directional stability, it is advisable to use a stabilizer to damp rolling motions.

Do not drive faster than 50 mph (80 km/h) if possible, even in countries where higher speeds are permitted.

Make sure that you have enough room when cornering and avoid sudden manoeuvres.

If the caravan / trailer starts to sway, drive more slowly, do not attempt to correct the steering and brake sharply if necessary.

Electrically driven fan: The fan cooling capacity is not dependant on engine speed. It is not necessary, therefore when driving uphill to shift down into a lower gear if the vehicle can climb in a higher gear.



S 11971

Starting on inclines

Hold engine rpm constant, engage clutch gradually (let slip), release brake and open throttle. If possible, the engine speed should not drop during this procedure.

For vehicles with Tecshift ✱ in Automatic mode, apply full throttle.

Before starting-off under extreme conditions (high combination weight, mountainous terrain with steep inclines), switch off all unnecessary electrical loads (e.g. heated rear window ✱).

Self-help

| | |
|---|-----|
| Do not start with quick charger..... | 116 |
| Starting the engine with jump leads * | 116 |
| Jump start terminal | 117 |
| Towing the vehicle..... | 118 |
| Towing another vehicle..... | 119 |
| First-aid kit ☹️ * and fire extinguisher *..... | 119 |
| Warning triangle ⚠️ *..... | 119 |
| Spare wheel *..... | 120 |
| Jack and vehicle tools | 121 |
| Wheel changing..... | 121 |
| Tyre repair kit *..... | 122 |
| Battery isolation switch *..... | 126 |
| Electrical system | 127 |
| Fuses and the most important circuits they protect | 127 |
| Bulb replacement | 129 |

⚠️ Warning

Disregard of these instructions may lead to injuries or endanger life. Vehicle passengers must be informed accordingly.

If the fuel tank has been allowed to run dry, it will be necessary to air vent or bleed the system before attempting to start the engine.

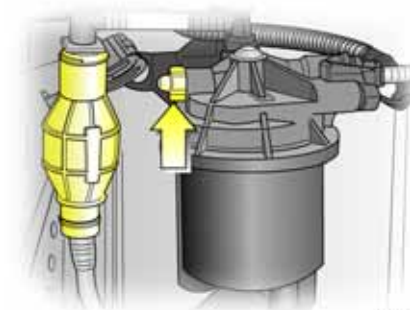

S 11789

Fill the tank with fuel and proceed as follows:

1. Place a suitable container underneath the vent screw to collect fuel.
2. Loosen the fuel filter vent screw (arrowed) by one turn.
3. Manually operate the in-line supply pump slowly and steadily until fuel discharging from the loosened vent screw is free of air bubbles.
4. Retighten the vent screw.

Draining water from diesel fuel filter
- see page 140.

Do not start with quick charger

This prevents damage to electronic components.

⚠ Warning

If the vehicle battery requires charging whilst still in the vehicle, ensure there is adequate ventilation in and around the battery compartment to prevent risk of explosion.

Do not start by pushing or towing

If your vehicle is fitted with a catalytic converter it must not be started by pushing or towing - see page 92.

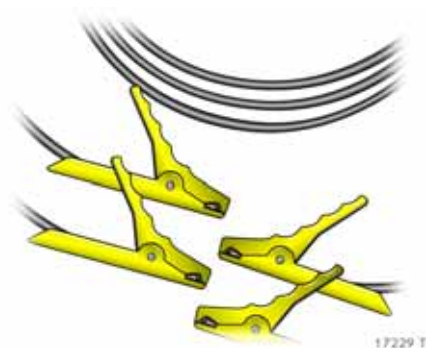
**Starting the engine with jump leads ***

A vehicle with a discharged battery can be started using jump leads and the battery of another vehicle. Attempts to start the vehicle should be made at intervals of one minute and should not last longer than 15 seconds.

⚠ Warning

This must be done with extreme care. Any deviation from the following instructions could lead to personal injury or damage resulting from battery explosion, as well as to damage to the electrical systems in both vehicles.

- Never expose the battery to naked flames or sparks.
- A discharged battery can freeze at temperatures as low as 0 °C. Defrost the battery before connecting the jump leads.
- Do not allow battery fluid to contact eyes, skin, fabrics or painted surfaces. The fluid contains sulphuric acid which can cause injuries and damage in the event of direct contact.
- Wear eye protection and protective clothing when handling a battery.
- Use auxiliary battery with same voltage (12 volts). Its capacity (Ah) must not be considerably less than that of the discharged battery. Voltage and capacity information can be found on the batteries.
- Use jump leads with insulated terminals and a width of at least 25 mm².

- Do not disconnect the discharged battery from the vehicle.
 - Switch off all unnecessary electrical consumers.
 - Do not lean over the battery during jump starting.
 - Do not allow the terminals of one lead to touch those of the other lead.
 - Do not touch the vehicles while jump starting.
 - Apply handbrake. Transmission in neutral (Tecshift * in N).
 - Do not connect leads to negative terminal of discharged battery!
 - The connection point should be as far away from the discharged battery as possible.
- Route the leads so that they cannot catch on rotating parts in the engine compartment.
 - Start the engine of the vehicle providing the jump start.
 - After 5 minutes, start the other engine. Start attempts should be made at intervals of 1 minute and should not last longer than 15 seconds.
 - After starting, allow both engines to idle for approx. 3 minutes with the leads connected.
 - In order to avoid excess voltage in the electrical system, before removing a lead, switch on an electrical consumer (e.g. light, heated rear window *) in the vehicle receiving the jump start.
 - Reverse above sequence exactly when removing leads.



Jump start terminal

In the event of a discharged battery, the jump start terminal enables the vehicle to be started without the need to access the battery inside the vehicle.

The jump start terminal is located in the engine compartment and identified by a "+" sign on the red insulating cover.

Lift the red insulating cover to access the terminal connector. Ensure the red insulating cover is latched back into position when not in use.

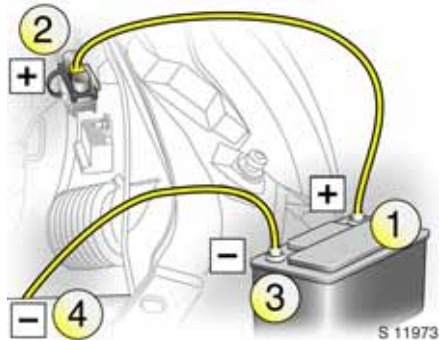

Connect the leads in the order shown in the picture:

1. Connect one end of the first jump lead to the positive terminal **1** of the battery providing the jump start (identified by "+" sign on battery case or terminal).
2. Connect the other end of this lead to the jump start terminal **2** of the vehicle with the discharged battery.
3. Connect the first end of the other jump lead to the negative terminal **3** of the battery providing the start ("- " sign).
4. Connect the other end of the second jump lead **4** to ground on the other vehicle, e.g. engine block.

- Do not connect leads to negative terminal of discharged battery!
- The connection point should be as far away from the discharged battery as possible.
- Route the leads so that they cannot catch on rotating parts in the engine compartment.
- The engine of the vehicle providing the jump start can be allowed to run during starting. Attempts to start the engine of the vehicle with the discharged battery should be made at intervals of one minute and should not last longer than 15 seconds. After starting, allow both engines to idle for approx. 3 minutes with the leads still connected.
- Reverse above sequence exactly when removing leads.

Fuel cut-off device - see page 91.



Towing the vehicle

Screw the front towing eye (stowed in the tool kit) fully into the front towing point.

Attach the tow rope * - or better still, a tow rod * - to the front towing eye, never to the bumper or front suspension units.

Warning

Never lift the vehicle using the front towing eye!

Place the gearshift lever in the neutral position. Switch on the ignition to release the steering column lock and to permit the operation of the brake lights, horn and windscreen wiper.

Drive off slowly and avoid jerky movements. Impermissible tractive forces could damage the vehicles.

Warning

More brake pedal pressure is necessary when braking since the brake servo unit is operative only when the engine is running.

On vehicles with power steering, considerably greater steering force is necessary since this unit is operative only when the engine is running.

To prevent the entry of exhaust fumes from the towing vehicle, switch on the air circulation system and close the windows.

Consult a workshop. We recommend your Vauxhall Authorised Repairer, who will serve you best to get your vehicle back on the road.

Towing service

Entrust your vehicle only to the towing service of your choice and obtain an estimate on towing costs before employing any towing service. This will prevent unnecessary expense and possible insurance problems during claim processing.

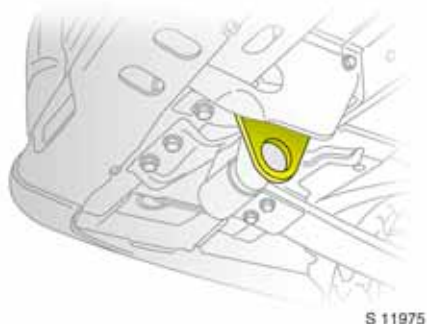

Towing another vehicle

Attach a tow rope * - or better still a tow rod * - to the rear towing eye, never to the rear axle and suspension units.

Warning

Never lift the vehicle using the rear towing eye!

Drive off slowly and avoid jerky movements. Impermissible tractive forces could damage the vehicles.

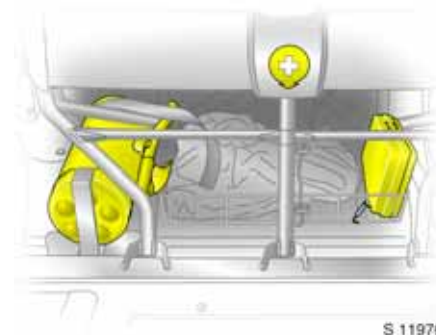

First-aid kit * and fire extinguisher *

Your first-aid kit and fire extinguisher are accommodated in the space under the front passenger seat. Alternatively the fire extinguisher can be located in the driver's door pocket. For correct use, carefully follow instructions on the body of the fire extinguisher.

Warning triangle *

Your warning triangle can be accommodated in the space under the front passenger seat.

Warning

Ensure items stowed under the seats are securely restrained.



Spare wheel ❄

The spare wheel may be mounted in the load compartment or under the chassis depending on variant.

General information

If you use winter tyres ❄, the spare wheel may still be fitted with a summer tyre. If you use the spare wheel when it is fitted with a summer tyre the vehicle's driveability may be affected, especially on slippery road surfaces. Obtain a replacement for the faulty tyre as soon as possible, and have the wheel balanced and fitted to the vehicle.

Spare wheel retaining clamp ❄

The spare wheel in the load compartment is vertically mounted. To release the wheel, remove the retaining clamp.

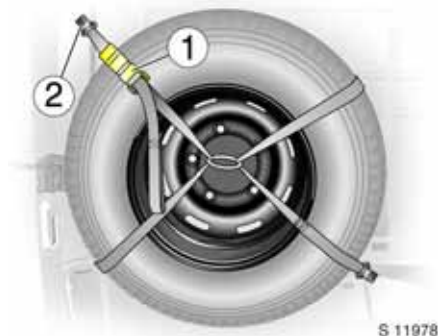

Spare wheel straps ❄

To remove, support the wheel and remove the tension on the straps by releasing the ratchet assembly 1. Detach the strap from the top left anchorage point using the quick release clip 2.

To install, attach the quick release clip to the anchorage point and tension the straps using the ratchet. Store the loose end of the strap on the lower right strap using the Velcro patch.

⚠ Warning

Ensure the spare wheel is securely restrained and the ratchet handle is returned to its locked position.

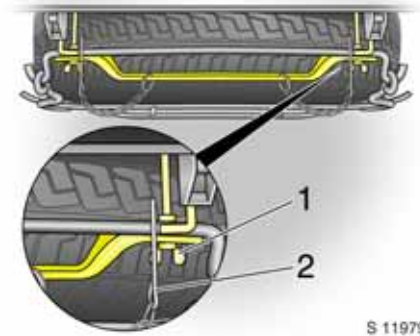

Chassis mounted spare wheel ❄

The chassis mounted spare wheel is located horizontally under the centre rear chassis.

It may be necessary to jack the vehicle up to gain access to the spare wheel on a fully loaded vehicle with a flat rear tyre.

To release the wheel, withdraw the two split pins 2 ❄ and loosen the two fixings 1 on the retaining assembly. With the retaining assembly loosened, the spare wheel carrier can be released and gradually lowered to the ground.

When installing the wheel ensure that the spare wheel carrier is correctly located within the retaining assembly before tightening the fixings. Ensure that the two split pins ❄, are reinstalled correctly.

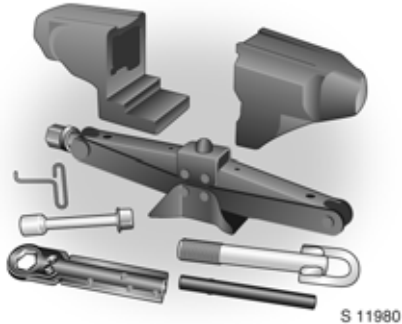

Jack and vehicle tools

The jack, adapter, ratchet, extension bar and towing eyes are contained in a unit, stowed under the driver's seat.

Open the unit by pulling off the two end pieces. For safety reasons always reinstall the tools as shown on the end pieces.

Wheel changing

In order to reduce the chance of possible injuries, make the following preparations and note the procedure:

- Park on a level, firm and non-slippery surface.
- Switch on hazard warning lights and apply handbrake. Engage first gear or reverse.
- Correctly set up warning triangle.
- No people or animals may be in the vehicle when it is jacked-up.
- Before lifting the vehicle, turn front wheels to straight-ahead position.
- Never change more than one wheel at a time.
- Block wheel diagonally opposite the wheel to be changed by placing wedge blocks, any available blocks of wood or rocks behind and in front of it.
- Use jack only when changing wheels.
- If the ground on which the vehicle is standing is soft, a solid board (max. 1 cm thick) should be placed under the jack. Using a thicker board could lead to damage of the jack and the vehicle.
- Never crawl under a jacked-up vehicle.
- Do not start or run the engine while the vehicle is on the jack.

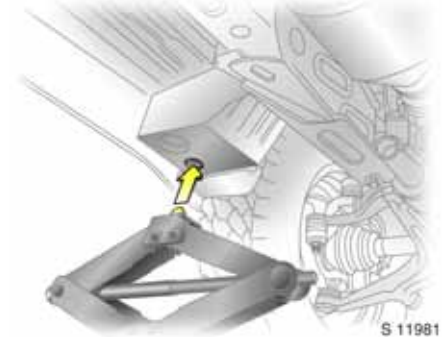

Wheel changing procedure

1. Remove wheel trim and loosen the wheel bolts with the ratchet, extension bar and adapter. The ratchet should turn anticlockwise to loosen the bolts - invert the ratchet if necessary.
2. To raise vehicle, place locating peg of the jack under the jacking hole located nearest the wheel concerned.

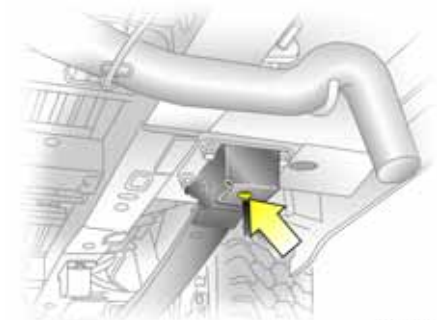

S 11982

3. Install adapter onto the jack and raise the vehicle by turning the ratchet until the wheel is clear of the ground.
4. Unscrew wheel bolts.
5. Change wheel.
6. Refit wheel bolts.
7. Lower vehicle.

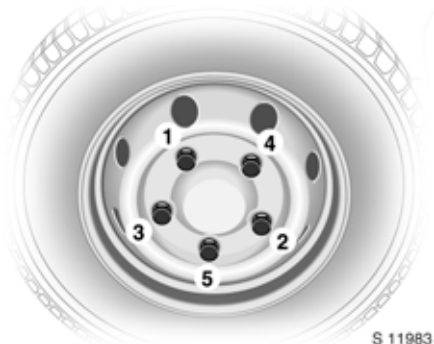

S 11983

8. Tighten wheel bolts in criss-cross sequence.
9. Refit wheel trim
10. Stow the wheel, jacking equipment and warning triangle *.

Have the new wheel balanced on the vehicle and have the torque of the wheel bolts checked as soon as possible. Tightening torque - see page 159.

Have defective tyre repaired and balanced.



17251 T

Tyre repair kit *

The repair kit is located under the front seat.

1. Carefully remove the components from the case.
2. Remove the compressor.
3. Remove the electrical connection cable and air hose from the compartments on the underside of the compressor.



4. Screw the compressor air hose to the connection on the sealant bottle.
5. Invert the sealant bottle in the retainer on the compressor.

Position the compressor near the tyre in such a way that the sealant bottle is upright.

6. Remove the valve cap from the defective tyre.

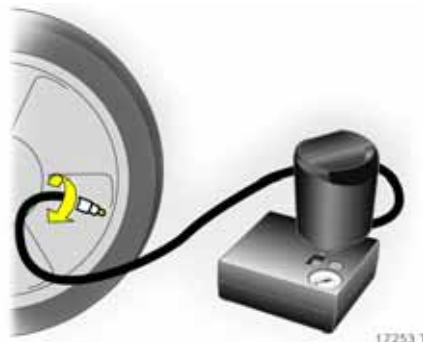

7. Screw the filler hose to the tyre valve.

Warning

Do not allow the sealant to contact skin, eyes or clothing. In an emergency, rinse thoroughly with water and seek medical advice. If swallowed do not induce vomiting, seek medical advice immediately.

Highly flammable, avoid naked flames - no smoking! Do not inhale vapour.

8. The switch on the compressor must be set to .

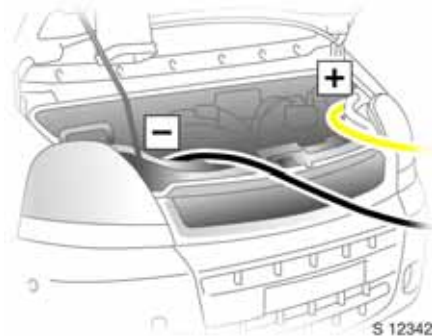

9. Connect the red + power supply lead on the compressor to the battery jump start terminal, for jump start terminal - see page 117.

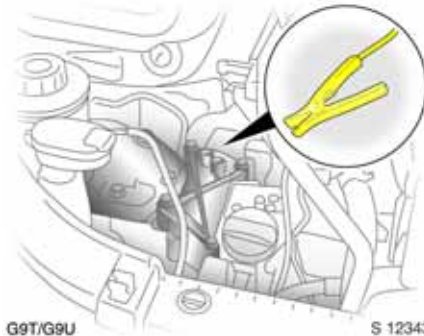

10. Connect the black - power supply lead to a suitable earth point, e.g. engine block or engine support bracket - see illustration above.



11. With the engine running, set the rocker switch on the compressor to I. The tyre is filled with sealant.
12. While the sealant bottle drains (approx. 30 seconds) the pressure indicator on the compressor briefly points to 6 bar (87 psi). Pressure then sinks again.
13. All of the sealant is pumped into the tyre and then the tyre is filled with air.

The prescribed tyre inflation pressure (see page 159) should be reached within 10 minutes. Switch off the compressor when the correct pressure is obtained.

Warning

Do not run the compressor for more than 10 minutes - see "Important information" on page 126.

If the prescribed tyre inflation pressure is not reached within 10 minutes, detach the tyre repair kit. Move the vehicle one tyre revolution (approx. 2 metres) in a straight line. Reconnect the tyre repair kit and continue the filling procedure for 10 minutes. If the prescribed tyre inflation pressure is still not reached, the tyre is too badly damaged. Park the vehicle and consult a workshop.



Reduce excess tyre inflation pressure with the button above the pressure indicator.

14. Disconnect the tyre repair kit and power supply leads. Screw the filler hose to the free connection on the sealant bottle. This prevents sealant leakage. Stow the tyre repair kit in the vehicle.
15. Wipe away any sealant spill with a cloth.
16. Dismantle and stow the warning triangle ✱.
17. The sticker supplied in the kit shows the maximum permitted speed at which the tyre repair may be used. Apply sticker in the driver's field of vision.

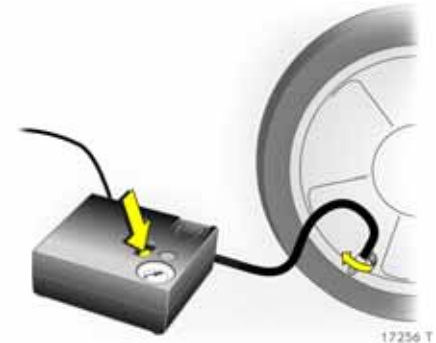

18. Continue driving immediately to allow the sealant to distribute evenly throughout the tyre. Stop after approx. 6 miles (10 km) but no more than 10 minutes, and check tyre inflation pressure. Screw the compressor air hose directly onto the tyre valve.

As long as the tyre inflation pressure is more than 3.1 bar (45 psi), it may be adjusted to the prescribed value. Repeat the procedure until there is no more pressure loss.

If tyre inflation pressure is below 3.1 bar (45 psi), the vehicle must not be driven. Consult a workshop for assistance.

19. Stow the tyre repair kit under the front seat.

Important

⚠ Warning

Do not drive faster than 50 mph (80 km/h). Have the tyre permanently repaired or replaced before subjecting it to prolonged usage.

Have the repaired tyre replaced as soon as possible. Do not drive with more than one repaired tyre.

Steerability and driving behaviour may be impaired. Take bends slowly.

If the compressor makes abnormal noises or heats up greatly, switch it off for at least 30 minutes.

Protect the compressor from moisture and rain.

The sealant can only be stored for approx. 4 years. After this time, the sealing properties can no longer be guaranteed. Heed the expiration date on the sealant bottle.

The sealant bottle can only be used once. Replace a used sealant bottle.

The compressor and sealant can be used from approx. -30 °C.

**Battery isolation switch ***

A battery isolation switch is installed as a safety measure. In an emergency, the engine and vehicle electrics can be isolated by pulling the switch towards you.

When the switch is pulled, the hazard warning lights will flash automatically.

To reset, press the switch back to its original position and the hazard warning lights will stop flashing.

⚠ Warning

The battery isolation switch should only be used in cases of emergencies and not operated during normal driving. Failure to disregard these instructions may result in fatal injuries.

Electrical system

Fusebox

The fusebox is located in the lower instrument panel below the steering wheel.

When replacing a fuse, turn off the respective switch and the ignition.

A defective fuse can be recognized by its melted wire. A new fuse should only be installed after the cause of the trouble has been eliminated.

Only install fuses of the specified rating. Each fuse has its rating written on it, in addition the fuses are colour coded

It is advisable to carry a full set of fuses, available from your Vauxhall Authorised Repairer.

Provision is made in the fusebox for the storing of spare fuses

| Fuses, Colour | Fuses, Rating ¹⁾ |
|------------------|--------------------------------|
| Grey | 2 A |
| Light brown | 5 A |
| Brown | 7.5 A |
| Red | 10 A |
| Blue | 15 A |
| Yellow | 20 A |
| White | 25 A |
| Green | 30 A |
| Orange | 40 A |

¹⁾ Rating in Amperes.

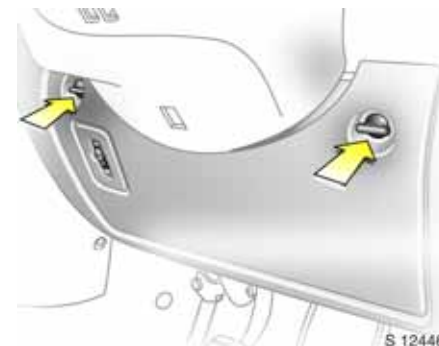

Fuses and the most important circuits they protect

Instrument panel fusebox

To open the cover, depress the tabs on the cover, then pivot downwards.

To help in replacing fuses, a fuse remover is located in the fusebox.



S 12378

Fuses

| Symbol | Application |
|--------|-------------------------|
| | Air conditioning |
| | Heated exterior mirrors |
| | Electronic immobiliser |
| | Heated seats |
| | Electric windows |
| | Left-hand main beam |
| | Right-hand main beam |
| | Navigation system |

| Symbol | Application |
|--------|---------------------------|
| | Windscreen wiper |
| | Radio / cigarette lighter |
| | Horn |
| | Pneumatic suspension |
| | Left-hand dipped beam |
| | Right-hand dipped beam |
| | Instrument panel |
| | Cigarette lighter |
| | Preheating system |

Symbol Application

| | |
|-----------------|--|
| | Interior light |
| | Anti-lock Brake System |
| | Heated rear windscreen |
| | Clock / interior lights / radio |
| | Left-hand parking light |
| | Right-hand parking light |
| | Hazard warning lights |
| | Accessory socket |
| | Central locking |
| | Heated windscreen |
| STOP | Stop light |
| | Rear window wash |
| | Fog tail light |
| INJECT | Injection |
| | Electrically adjustable exterior mirrors |
| ALIM UCH | Body control module |

Bulb replacement

Before replacing a bulb, turn off the respective light switch. Only hold new bulb at base! Do not touch the bulb glass with bare hands, as otherwise fingerprints on the glass evaporate. Residue builds up on the reflector eventually resulting in a dull reflector. Inadvertently stained bulbs may be cleaned with a clean non-fluffy cloth, using alcohol or white spirit.

Replacement bulb must be in accordance with data on base of defective bulb. Do not exceed wattage given on bulb base.

Headlight aiming

We recommend that headlight aiming be carried out by your Vauxhall Authorised Repairer, who will have special equipment.

On vehicles with headlight range adjustment, carry out headlight aiming with switch in position 0.



Headlight dipped and main beam

Dipped beam bulb

1. Unclip the dust cover.
2. Remove harness connector.
3. Unclip retaining clip and remove bulb.
4. Insert new bulb and secure with retaining clip.
5. Install harness connector and dust cover.

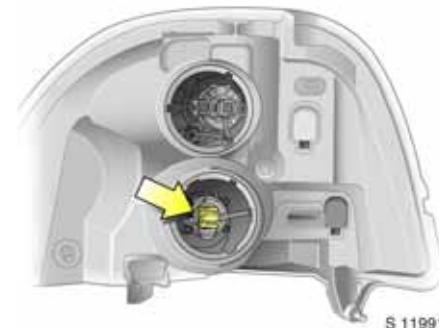

Main beam bulb

1. Unclip the dust cover.
2. Remove harness connector.
3. Unclip retaining clip and remove bulb.
4. Insert new bulb and secure with retaining clip.
5. Install harness connector and dust cover.

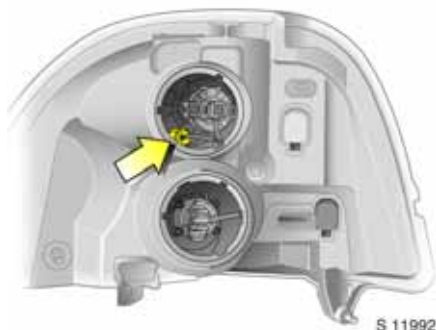

Parking lights

1. Unclip the dust cover.
2. Remove harness connector.
3. Turn bulb holder through 90° and withdraw.
4. Renew bulb and install bulb holder.
5. Install harness connector and dust cover.

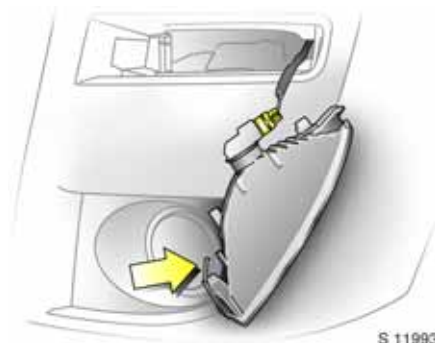

Front turn signals

1. Release light retaining clip from aperture (arrowed), using a flat screwdriver and lift out.
2. Remove bulb holder from light by rotating through 90° and install new bulb.
3. Install bulb holder in light, install light assembly into aperture ensuring retaining clip engages.

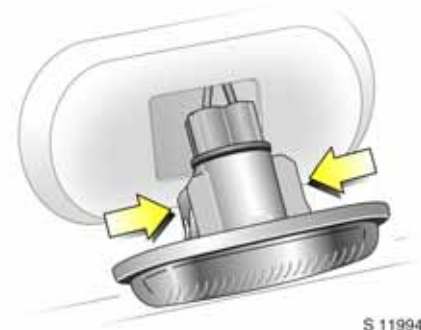

Side repeater lights

1. Release light clips from wing using a flat screwdriver and lift out.
2. Remove bulb holder from light by rotating through 90° and renew bulb.
3. Install bulb holder in light and install light assembly into aperture.

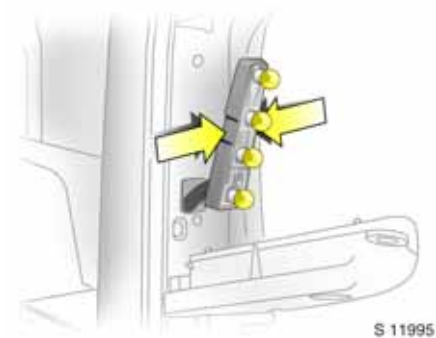

S 11995

Rear brake, tail, turn signal, reverse and fog lights

Van variants:

1. Remove retaining screw from top of light assembly and pull assembly downwards.
2. Press the retaining tabs together to separate bulb holder from lens.
3. Renew bulb; sequence from top to bottom:
Tail and brake light
Turn signal light
Reverse light
Fog tail light ✱
4. Install bulb holder to lens; engage clips.
5. Install light assembly with screw.

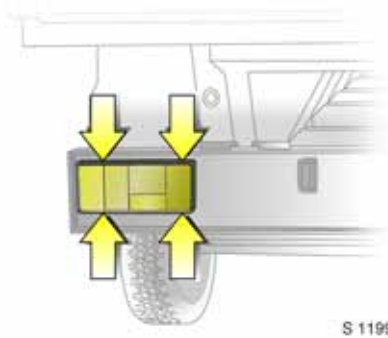

S 11996

Chassis variants:

1. Remove four retaining screws.
2. Renew bulb; sequence outer to inner:
Turn signal light
Brake light
Tail light
Reverse light or fog tail light
3. Install four screws.

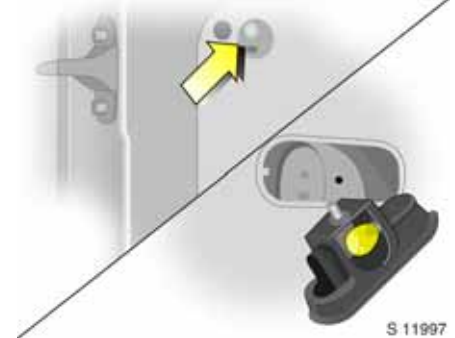

S 11997

High level brake light

1. Remove cover disc from access hole in inner rear door trim.
2. Remove retaining nut, and pull light away from door.
3. Install light in door and retain with nut.
4. Replace trim cover disc.

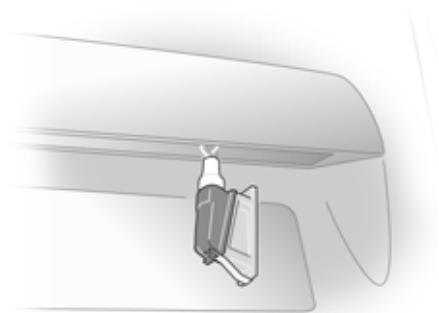

S 11998

Number plate lights

Van variants:

1. Unclip the light from its aperture using a screwdriver and unclip lens from light.
2. Renew bulb.
3. Install lens to light and light into aperture.

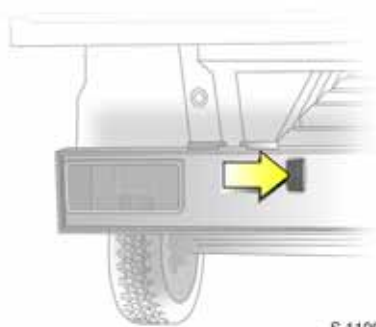

S 11999

Chassis variants:

1. Remove screw from light.
2. Renew bulb.
3. Install screw.



S 12447

Interior lights

1. Unclip lens assembly using a flat blade.
2. Renew bulb.
3. Reinstall lens assembly.



Reading lights

1. Unclip lens assembly using a flat blade.
2. Renew bulb.
3. Reinstall lens assembly.

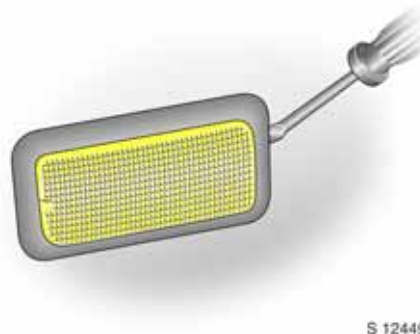

Load compartment light *

1. Unclip lens using a flat blade.
2. Renew bulb.
3. Reinstall lens assembly.

Third brake light, front fog lights *, instrument and glove compartment illumination

We recommend having bulb replacements carried out by your Vauxhall Authorised Repairer.

Rear courtesy lights *

We recommend having bulb replacements carried out by your Vauxhall Authorised Repairer.

Rear seating compartment lights and low level interior lights *

We recommend having bulb replacements carried out by your Vauxhall Authorised Repairer.

If you have a problem

In our experience, the most common cause of all complaints is the result of misunderstanding or lack of communication between the customer and the Vauxhall Authorised Repairer.

We sincerely hope you will never have cause to complain about your vehicle. However, if things do go wrong, the best course of action for you to take is to contact your Vauxhall Authorised Repairer's Service Reception Staff and explain the difficulty you are having. We are confident they will do their utmost to resolve the problem to your complete satisfaction.

Sometimes, however, despite the best of intentions of all concerned, misunderstandings can occur. If your problem has not been resolved to your satisfaction, please make an appointment to discuss the matter with the Manager of the department concerned.

The majority of areas of concern can be quickly resolved in this way.

Should you wish to pursue the matter further, the Principal of the Vauxhall Authorised Repairer should be made aware of your concern. It is advisable in cases such as this to write to him to confirm your problem and the solutions that have been offered.

You can be assured the Authorised Repairer's Principal will only be too anxious to fully investigate your problems and correct any errors made. After all, he has a large investment in his business and is proud of his reputation and professionalism and fully realises that satisfied customers are his key to success.

In the unlikely event that you are still not happy with the answer your Vauxhall Authorised Repairer has given, or the action he proposes to correct the problem, you may contact the Customer Care Department¹⁾ where a team of Customer Care Consultants will spare no effort to ensure your complete satisfaction.

Vauxhall Motors Ltd.

Customer Care,
Griffin House,
Osborne Road,
LUTON,
Beds., LU1 3YT
Telephone: 0845 090 2044

They will review all the facts involved. Then if it is felt some further action can be taken, the Vauxhall Authorised Repairer will be advised accordingly. In any case, your contact will be acknowledged confirming Vauxhall Motors' position in the matter.

If you are not satisfied with the outcome, you can if you wish, seek advice from an independent third party such as:

¹⁾ Calls may be monitored and recorded for training purposes.

Automobile Association (A.A.)

Fanum House,
BASINGSTOKE,
Hants., RG21 2EA

Royal Automobile Club (R.A.C.),

R.A.C. Motoring Services Ltd.,
89-91 Pall Mall, LONDON, SW1Y 545

The Customer Relations Department,
Society of Motor Manufacturers and Traders Ltd. (S.M.M.T.),
Forbes House, Halkin Street,
LONDON, SW1X 7DS

Customer Complaints Service,
Scottish Motor Trade Association,
(S.M.T.A.),
3 Palmerston Place,
EDINBURGH, EH12 5AQ

The National Conciliation Service,
Retail Motor Industry Federation,
9 North Street,
RUGBY, CV21 2AB

If you have a problem whilst abroad:

The Service Departments of ADAM OPEL GmbH and General Motors branches everywhere will provide information and assistance:

In **Luxembourg** please contact the General Motors Service Department in Antwerp – Belgium
Telephone 00 32-34 50 63 29

General Motors Austria GmbH
Groß-Enzersdorfer Str. 59
1220 Vienna – Austria
Tel. 00 43 1-2 88 77 444 or
00 43-1-2 88 77 0

General Motors Belgium N.V.
Noorderlaan 401 – Haven 500

2030 Antwerp – Belgium

Telephone 00 32-34 50 63 29

General Motors Southeast Europe,
org. složka
Olbrachtova 9

140 00 Prague – Czech Republic

Tel. 00 420-2 39 004 321

General Motors Denmark
Jaegersborg Alle 4

2920 Charlottenlund – Denmark

Telephone 00 45-39 97 85 00

Vauxhall Motors Ltd.

Customer Care

Griffin House, Osborne Road

Luton, Bedfordshire, LU1 3YT – England

Tel. 00 44-845 090 2044

General Motors Finland Oy
Pajuniityntie 5

00320 Helsinki – Finland

Tel. 00 358-9 817 101 47

General Motors France

1 – 9, avenue du Marais

Angle Quai de Bezons

95101 Argenteuil Cedex – France

Tel. 00 33-1-34 26 30 51

ADAM OPEL GmbH

Bahnhofplatz 1

65423 Rüsselsheim – Germany

Tel. 00 49-61 42-77 50 00 or

00 49-61 42-7 70

General Motors Hellas S.A.

56 Kifisias Avenue & Delfon str.

Amarousion

151 25 Athens – Greece

Tel 00 30-1-6 80 65 01

General Motors Southeast Europe Ltd.

Szabadsag utca 117

2040 Budaörs – Hungary

Tel. 00 36-23 446 100

General Motors India

Sixth Floor, Tower A, Global Business Park

Mehrauli – Gurgaon Road

Gurgaon – 122 022, Haryana – India

Tel. 00 91-124 280 3333

General Motors Ireland Ltd.

Opel House, Unit 60, Heather Road

Sandyford, Dublin 18 – Ireland

Tel. 00 353-1-216 10 00

General Motors Italia Srl
Piazzale dell'Industria 40

00144 Rome – Italy

Tel. 00 39-06-5 46 51

General Motors Nederland B.V.

Lage Mosten 49 – 63

4822 NK Breda – Netherlands

Tel. 00 31-76-5 44 83 00

General Motors Norge AS

Kjeller-Vest 6

2027 Kjeller – Norway

Tel. 00 47-23 50 01 04

General Motors Poland Sp. z o. o.

Domaniewska 41

06-672 Warsaw – Poland

Tel. 00 48- 22-606 17 00

General Motors Portugal

Quinta da Fonte

Edifício Fernão Magalhães, Piso 2

2780-190 Paço d'Arcos – Portugal

Tel. 00 351- 21 440 75 00

General Motors Southeast Europe,
org. zložka

Apollo Business Centre

Mlynské Nivy 45

821 09 Bratislava – Slovakia

Tel. 00 421-2 58 275 543

General Motors España S.L.

Paseo de la Castellana, 91

28046 Madrid – Spain

Tel. 00 34-902 25 00 25

General Motors Norden AB

Årstaängvägen 17

100 73 Stockholm – Sweden

Tel. 00 46-20 333 000

General Motors Suisse S.A.

Stelzenstraße 4

8152 Glattbrugg – Switzerland

Tel. 00 41-44 828 28 80

General Motors Türkiye Ltd. Sti.

Kemalpaşa yolu üzeri

35861 Torbalı / Izmir – Turkey

Tel. 00 90-2 32-8 53-14 53

In **Albania, Bosnia-Herzegovina,
Bulgaria, Croatia, Estonia, Latvia,
Lithuania, Macedonia, Romania,**

Serbia-Montenegro and Slovenia

please contact the

General Motors Service Department in

Budaörs – Hungary

Tel. 00 36-23 446 100

Service plan, maintenance

| | |
|---|-----|
| A note on safety | 137 |
| Checking and topping up fluids | 137 |
| Engine oil | 138 |
| Diesel fuel filter | 140 |
| Engine airflow indicator * | 140 |
| Coolant | 140 |
| Brake fluid | 142 |
| Windscreen wiper | 143 |
| Windscreen and headlight * wash system | 144 |
| Power steering fluid | 144 |
| Battery | 145 |
| Protection of electronic components | 146 |
| Vehicle storage | 146 |

In order to guarantee economical and safe vehicle operation and to maintain the value of your vehicle it is of vital importance that all maintenance work is carried out at the proper intervals as specified by Vauxhall in the Service Booklet. Time or mileage / kilometre intervals - whichever is reached first - determine when your vehicle is due for its next service.

In the case of low mileage / kilometre accumulation with frequent cold starts or predominantly urban traffic and stop-and-go traffic, an additional engine oil and filter change is recommended.

You will find the Service Booklet in the literature pack.

Have service work and repair work to body and equipment carried out by professionals. We recommend that you consult your Vauxhall Authorised Repairer. Your Vauxhall Authorised Repairer has excellent knowledge of Vauxhall vehicles, and has the special tools and the latest Vauxhall Service Instructions. It is particularly advisable to use a Vauxhall Authorised Repairer during the warranty period to avoid loss of warranty claims. See Service Booklet for additional information.

Separate anti-perforation service

Have this performed regularly, either within the scope of a Service or separately, see Service Booklet. We recommend that you consult your Vauxhall Authorised Repairer in order to avoid loss of warranty claims for repair.



S 11814

A note on safety

To avoid the possibility of injury, only carry out engine compartment checks (e.g. checking the brake fluid level or the engine oil level) when the ignition is switched off.

Warning

The cooling fan may be operated by a thermostich and can therefore start to operate unexpectedly even when the ignition is switched off. Risk of injury.

Electronic ignition systems generate very high voltages. Do not touch the ignition system; high voltage can be fatal.

Never carry out any repairs or adjustment and maintenance work on the vehicle yourself. This especially applies to the engine, chassis and safety parts. You may out of ignorance infringe the provisions of the law and, by not performing the work properly, you may endanger yourself and other road users.

Checking and topping up fluids

To aid identification, the engine oil filler cap, the coolant expansion tank cap, the lid of the fluid container for the windscreen wash system and the handle of the oil dipstick may be coloured yellow.



S 12002

Oil filler funnel

To assist in topping up the engine oil the vehicle is supplied with an oil filler funnel to prevent the unnecessary spillage of oil.

The oil filler funnel is located beneath the driver's seat. After use, ensure the items are cleaned and stowed beneath the driver's seat.

Further information - see page 139.

Engine oil

Information on engine oils is available in the Service Booklet.

Engine oil level

It is normal for every engine to consume some oil, and it is sometimes necessary to check and top up the engine oil level between oil changes.

Warning

Do not allow the engine oil level to drop below the minimum level!

For this reason the engine oil level should be checked every 300 miles (500 km) or before starting a long trip.

Engine oil level check and topping up

The oil level must be checked with the vehicle horizontal and with the engine (which must be at operating temperature) switched off. Wait approximately 15 minutes before checking the level to allow the normal oil accumulation in the engine to drain back into the oil pan.

Warning

Important: It is the owner's responsibility to maintain the correct level of an appropriate quality oil in the engine.

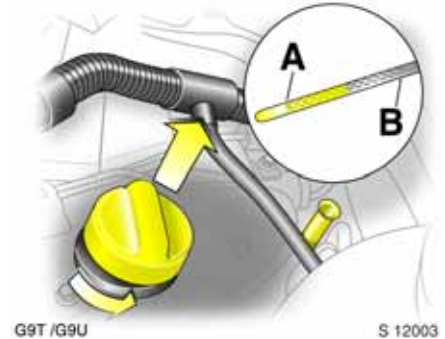

The illustrations show checking and replenishing the oil in the respective diesel engines.

To check the level remove the oil gauge (dipstick), wipe it clean and re-insert it as far as it will go. Top up if the oil level has dropped to the "add oil" mark **A**.

The oil level must not go above the upper mark **B** on the dipstick. This would lead, for example, to increased oil consumption and excessive formation of carbon residue.

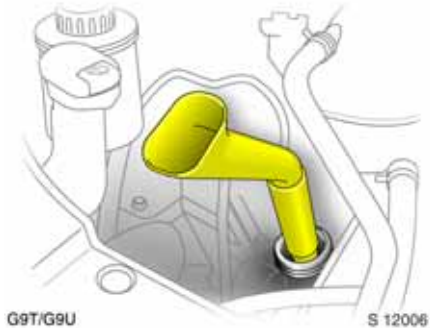

When replenishing, attempt to use the same type of oil as used at the last oil change. Use the oil filler funnel supplied to ensure oil is poured into the engine to avoid unnecessary spillages.

Capacities - see page 160.

If consumption exceeds more than 0.5 litre every 600 miles (1000 km) after this running-in period, consult a workshop.

A stabilization of the oil consumption will not take place until the vehicle has been driven several thousand miles. Only then can the actual degree of consumption be established.

Oil change, oil filter change

Engine oil changes are to be carried out depending on time intervals or mileage intervals, since oil loses its lubrication properties not only through engine operation but also through ageing.

We recommend that you use genuine Vauxhall oil filters.

⚠ Warning

Used oil filters and empty oil cans do not belong in the domestic garbage. We recommend having oil changes and oil filter changes carried out by a Vauxhall Authorised Repairer. The Vauxhall Authorised Repairer knows the laws concerning the disposal of used oil and therefore protects the environment and your health.

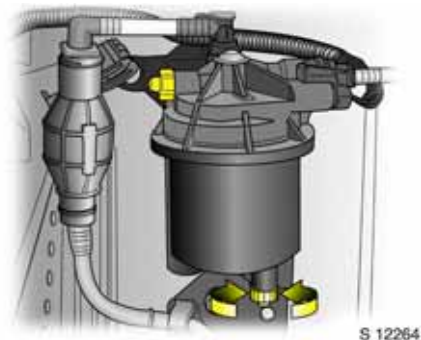

Diesel fuel filter

Drain fuel filter of residual water at every engine oil change.

Place a container underneath the filter housing. Loosen the knurled screws on the filter cover and on the lower part of filter by approx. one turn to drain off the water.

The filter is drained as soon as diesel emerges from the knurled screw at the bottom. Retighten the two screws.

General information

Check filter at shorter intervals in the case of extreme operating conditions such as poor quality fuel, high humidity (primarily in coastal areas), extremely high or low outside temperatures and substantially varying daytime and night-time temperatures.

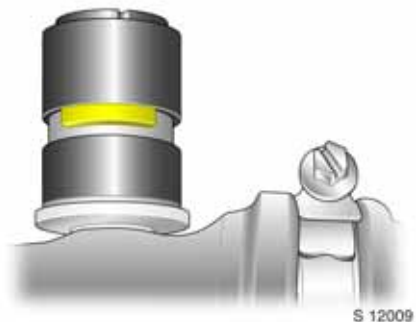

Engine airflow indicator *

On certain models, an indicator is located in the engine induction system and indicates if the air-intake to the engine is restricted.

Clear = No restriction
 Red tell-tale = Restricted

If the red tell-tale is displayed when the engine is running, consult a workshop.

Coolant

During operation the system is pressurized. The temperature may therefore rise to over 100 °C.

The anti-freeze provides excellent corrosion protection for the cooling and heating system, as well as freeze protection down to -30 °C.

Certain types of anti-freeze can lead to engine damage. Make sure that you are informed! We therefore recommend the use of anti-freeze that has been approved by Vauxhall.

Warning

Anti-freeze is a danger to health; it must therefore be kept in the original container and out of the reach of children.

We recommend that the coolant is changed by your Vauxhall Authorised Repairer who will be familiar with the requirements of the law as regards disposal of coolant and can thus help to protect the environment and your health.



S 12010

Freeze protection and corrosion protection

Before the start of the cold weather season, have the coolant checked for correct concentration by a workshop. The amount of anti-freeze must provide protection up to approx. $-30\text{ }^{\circ}\text{C}$. If the anti-freeze concentration is too low, this reduces protection from freezing and corrosion. Top up anti-freeze if necessary.

If coolant loss is topped up with water, have anti-freeze concentration checked and more anti-freeze added as necessary.



S 12011

Coolant level

Hardly any losses occur since the cooling system is sealed and it is thus rarely necessary to top up the coolant.

The coolant level in the expansion tank should be slightly above the MIN mark when the system is cold. It rises at engine operating temperature and drops again when the engine cools down. If the level falls below the MIN mark, the coolant should be replenished to a little over the mark.

Warning

Allow engine to cool down before removing coolant filler cap. Remove filler cap carefully so that pressure can escape slowly, otherwise there is a risk of scalding.

Top up anti-freeze. If no anti-freeze is available, top up with clean tap water.

If tap water is unavailable, distilled water can be used.

After topping up with tap or distilled water, have the anti-freeze concentration checked, and anti-freeze added if necessary. Have the cause of the coolant loss remedied by a workshop.

When closing, tighten coolant filler cap as far as it will go.

Coolant temperature

For physical reasons, the engine temperature gauge shows the coolant temperature only if the coolant level is adequate.

During operation the system is pressurized. The temperature may therefore rise to over 100 °C.

If the temperature gauge enters the upper zone, check the coolant level immediately.

■ Coolant level too low:

Top up coolant. Pay strict attention to the instructions given under "Anti-freeze and corrosion protection" and "Coolant level". Have the cause of coolant loss remedied by a workshop.

■ Coolant level OK:

Have the cause of increased coolant temperature remedied by a workshop.



Brake fluid

Brake fluid level

Warning

Caution - brake fluid is poisonous and corrosive. Do not allow it to contact eyes, skin, fabrics or painted surfaces. Direct contact may cause injuries and damage.

The fluid level in the container must not be higher than the "MAX" mark or lower than the "MIN" mark.

Use of some brake fluids could cause damage or impair braking effectiveness. Stay well informed. We recommend that you use Vauxhall-approved high performance brake fluid.

Extreme cleanliness is important, since brake fluid contamination can lead to brake system malfunctions.

After correcting the brake fluid level, have the cause of the loss remedied by a workshop.

Brake fluid change

As brake fluid is hygroscopic, it absorbs water. Vapour bubbles which impair the braking effect may occur during braking.

The fluid change intervals specified in the Service Booklet must therefore be observed.

Warning

We recommend that you have brake fluid changed by a Vauxhall Authorised Repairer, who will be familiar with the requirements of the law as regards disposal of brake fluid and can thus help to protect the environment and your health.

Windscreen wiper

Clear vision is essential for safe driving.

Perform regular checks on the windscreen wiper to ensure it is operating correctly. We recommend wiper blade replacement at least once a year.

If the windscreen is dirty, operate the windscreen wash system before switching on the windscreen wiper. This will avoid wiper blade wear.

Do not switch on the windscreen wiper if the windscreen is iced up as this could damage the wiper blades or the wiper system.

If the wiper becomes frozen on to the glass, we recommend that it be released with the aid of Vauxhall De-icer Spray before starting the vehicle, to prevent wiper motor damage.

Smearing wiper blades can be cleaned with a soft cloth and Vauxhall Windscreen Wash Solvent.

Wiper blades whose lips have become hardened, cracked or covered with silicone must be replaced. This may be necessary as a result of the effects of ice, thawing salt or heat, or the incorrect use of cleaning agents.

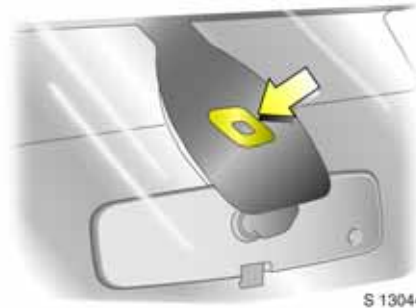

To ensure proper operation of the rain sensor , the sensor area must be free from dust, dirt and ice.

The windscreen wash system must also be operated at regular intervals and the sensor area must be de-iced. Vehicles with rain sensor can be identified by the sensor area near the top of the windscreen.



To replace wiper blade, first lift wiper arm and detach wash pipe from spray nozzle. Move release lever and detach wiper blade.



Windscreen and headlight *wash system

The filler opening of the fluid container for the windscreen and headlight wash system is located on the front left-hand side - as seen from the front of the engine compartment.

Fill only with clean water to prevent the nozzles from clogging. To improve cleaning efficiency, we recommend that you add a little Vauxhall Windscreen Wash Solvent.

The windscreen wash system will not freeze in winter:

| Freeze protection down to | Mixture - Vauxhall Windscreen Wash Solvent : Water |
|---------------------------|--|
| - 5 °C | 1 : 3 |
| - 10 °C | 1 : 2 |
| - 20 °C | 1 : 1 |
| - 30 °C | 2 : 1 |

When closing the container, press the lid firmly over the beaded edge.

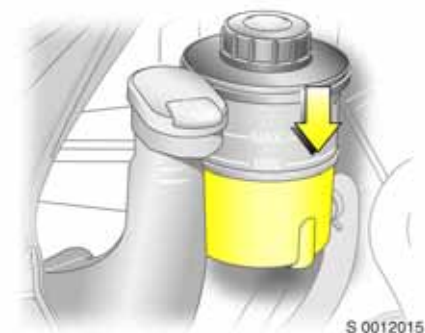

Power steering fluid

The power steering fluid does not require any additional maintenance than that detailed in the Service Booklet.

If the fluid in the reservoir falls below the MIN mark consult a workshop.



Battery

Battery access

The battery is located beneath the front centre floor panel. Lift the floor covering and use the tool supplied in the tool kit to loosen 4 screws. Remove cover plate.

Warning

Ensure adequate ventilation when charging the battery. There is a risk of explosion if gases generated during charging are allowed to accumulate!

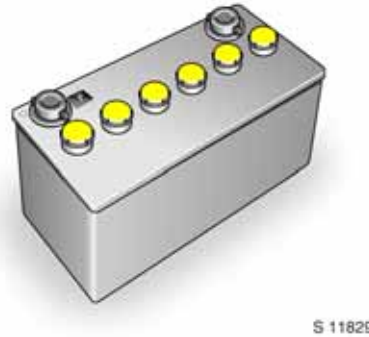

Battery maintenance ✳

If the battery installed to your vehicle is not maintenance free:

Remove battery caps and ensure electrolyte level is 15 mm above the plates. Add distilled or demineralised water to correct the level.

If battery fluid level drops below the plates, do not attempt to test or recharge the battery or jump start the engine.

Warning

We recommend that you have battery changes carried out by a Vauxhall Authorised Repairer. The Vauxhall Authorised Repairer knows the laws concerning the disposal of used batteries and therefore protects the environment and your health.

Electrical or electronic accessories fitted at a later stage can place an additional load on the battery or discharge the battery. Consult a workshop. We recommend a Vauxhall Authorised Repairer, as regards technical possibilities, such as fitting a more powerful battery.

Leaving the vehicle parked for more than four weeks may lead to the battery being discharged. This could shorten the service life of the battery. The battery should, therefore, be disconnected by disengaging the negative terminal from the vehicle. After the battery has been connected, you must reset the time in the information display.

Battery terminal connection

Note: when connecting the battery cables to the terminals, ensure they are aligned correctly, and in position with the protective cover.



S 11814

Protection of electronic components

In order to avoid the breakdown of electronic components within the electrical system, never disconnect the battery with the engine running. Never start the engine while the battery is disconnected (e.g. when using jump leads).

The battery must be disconnected from the vehicle before being charged: first disconnect the negative cable and then the positive cable. The polarity of the battery, i.e. the connections for the positive and negative cables, must not be interchanged. When reconnecting, first connect the positive cable and then the negative cable.

To avoid damaging the vehicle, do not make any modifications to the electrical system, e.g. connecting additional consumers or tampering with electronic control units (chip tuning).

Warning

Electronic ignition systems generate very high voltages. Do not touch the ignition system; high voltage can be fatal.

Disconnecting / connecting the battery from / to the electrical system

Disconnect the battery from the vehicle electrical system before charging: First detach the negative and then the positive lead. Do not reverse the polarity of the battery, i.e. do not confuse the terminals for the positive and negative leads. When connecting, start with the positive lead and then connect the negative lead.

Vehicle storage

If your vehicle is to be stored for long periods without use, we recommend you consult your Vauxhall Authorised Repairer for advice.

Vehicle care

Consult a Vauxhall Authorised Repairer with regard to care aids tested and recommended by Vauxhall.

In caring for your vehicle observe all national environmental regulations, particularly when washing your vehicle.

Regular, thorough care contributes to improving the appearance of your vehicle and maintaining its value. It is also a prerequisite for claims made under the warranty in the event of paint or corrosion damage. In the following pages, we give you tips for vehicle care which, with correct use, will help to ward off unavoidable and harmful environmental influences.

Vehicle care aids *

Vehicle wash:

- Car Shampoo
- Sponges
- Chamois Leather
- Wheel Cleaners
- Engine Cleaners
- Glass Cleaners

Exterior care:

- Touch-up Paints
- Car Polishes / Colour Restorers
- Car Waxes / Sealers
- Rust Preventative
- Lubricant Sprays
- De-icer Sprays
- Windscreen Wash Solvent

Interior care:

- Interior / Upholstery Cleaner

Washing

The paintwork of your vehicle is exposed to environmental influences, e.g. continuous changes in weather conditions, industrial waste gases and dust or thawing salts, so wash and wax your vehicle regularly. When using automatic car washes, select a programme which includes waxing.

Bird droppings, dead insects, resin, pollen and the like should be cleaned off immediately, as they contain aggressive constituents which can cause paint damage.

If using a car wash, comply with the pertinent instructions of the car wash manufacturer. The windscreen wiper or the automatic wiper with rain sensor* must be switched off – see page 12. Remove the detachable rod antenna.

If you wash your vehicle by hand, use Car Shampoo. Make sure that the insides of the wings are also thoroughly rinsed out.

Clean edges and folds on opened doors and flaps as well as the areas they cover.

Thoroughly rinse off and leather-off the vehicle. Rinse leather frequently. Use separate leathers for paint and window surfaces: remnants of wax on the windows will impair vision.

Waxing

Wax your vehicle regularly, in particular after it has been washed using shampoo and at the latest when water no longer forms beads on the paintwork, otherwise the paintwork will dry out.

Never let things deteriorate this far. Waxing prevents harmful chemical action.

Also wax edges and folds on opened doors and flaps as well as the areas they cover.

Polishing

Polishing is necessary only if the paint has become dull or if solid deposits have become attached to it.

Polish with Silicone forms a protective film, making waxing unnecessary.

Plastic body parts should not be treated with wax and polish.

Use Wax for Metallic Paintwork on vehicles with a metallic-effect paint finish.

Wheels

Wheels are painted and can be treated with the same agents as the body. For alloy wheels we recommend use of Alloy Wheel Cleaner.

Paint damage

Minor paint damage such as stone chips, scratches etc. should be treated immediately with Vauxhall Touch-Up Paint or Aerosol before corrosion can form. If corrosion has already formed, consult a workshop. Do not forget the surfaces and edges nearest to the road where rust may also form unnoticed.

Exterior lights

If the light covers require additional cleaning after the vehicle has been washed, clean them with Car Shampoo. Do not use any abrasive or caustic agents, do not use an ice scraper, and do not clean them dry.

Plastic and rubber parts

For additional cleaning of plastic and rubber parts use Cleaner. Do not use any other agent, and in particular do not use solvents or petrol.

Wheels and tyres

Do not use high-pressure jet cleaners on wheels and tyres.

Interior and upholstery

Clean the vehicle interior trim, including the instrument panel using cleaner.

Clean fabric upholstery with a vacuum cleaner and brush. For removal of stains use cleaner, which is suitable for both fabrics and vinyl.

For cleaning fabrics, carpets and also the instrument panel in the vehicle interior, do not use cleaning agents such as acetone, carbon tetrachloride, paint thinner, paint remover, nail varnish remover, washing powder or bleach. Petrol is also unsuitable.

Seat belts

Always keep seat belts clean and dry.

Clean only with lukewarm water or Cleaner.

Windows

When cleaning ensure that the heating element on the heated rear window is not damaged.

Use a soft fluff-free cloth or chamois leather in conjunction with Window Cleaning Spray.

Vauxhall Windscreen Wash Solvent is suitable for de-icing windows.

For mechanical removal of ice, use a commercially available sharp-edged ice scraper. Press the scraper firmly against the glass so that no dirt can get under it and scratch the glass.

Windscreen wiper blades

Smearing wiper blades should be cleaned with a soft cloth and Vauxhall Windscreen Wash Solvent, and replaced if necessary.

Locks

The locks are lubricated before they leave the factory with a high-grade lock cylinder grease. Vauxhall lock cylinder grease prevents the locks from freezing up. Use de-icing agents only in emergencies, as they have a degreasing effect and will impair the functioning of the locks. After using de-icing agents regrease the locks.

Engine compartment

Important areas of the engine compartment have been provided with permanent protection at the factory in the form of a high-quality, smooth protective lacquer coating. Parts of the engine compartment lacquered in the same colour as the vehicle's paintwork can be treated in the same way as all painted surfaces.

Wash engine only if absolutely necessary. Before washing the engine, protect alternator and brake fluid container with plastic covers.

When washing the engine with a steam-jet cleaner, do not direct the steam-jet at ABS components, the air conditioning system * or the belt drive and its components.

When the engine is washed, subsequently applied protective wax is also removed. After washing, the engine as well as parts of the brake system, axle components (with steering) and body parts and cavities should therefore be thoroughly coated with Protective Wax by a workshop.

Underbody

Your vehicle has a factory-applied PVC undercoating in the wheel arches (including the longitudinal members) which provides permanent protection and needs no special maintenance. The surfaces of the vehicle underside not covered by PVC are provided with a durable protective wax coating.

In vehicles which are washed frequently in automatic car washes with underbody washing facility, the protective wax coating may be impaired by dirt-dissolving additives, so check the underbody after washing and have it waxed. Before the start of the cold weather season, check PVC coating and protective wax coating and, if necessary, have them restored to perfect condition.

Caution: commercial bitumen and rubber materials can damage the PVC coating. We recommend having all the work on the underbody performed by a Vauxhall Authorised Repairer, as it requires knowledge of the specified materials and experience concerning their application.

The underbody should be washed following the end of the cold weather season to remove any dirt adhering to the underbody since this may also contain salt. Check protective wax coating and, if necessary, have it restored to perfect condition.

Technical data

The technical data are determined in accordance with European Community standards. We reserve the right to make modifications. Specifications in the vehicle documents always have priority over those given in this manual.

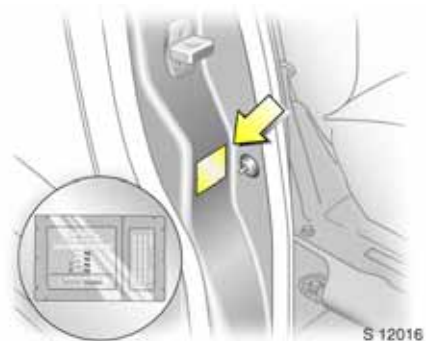

Vehicle identification data

The Vehicle Identification Number is on the vehicle identification plate, which is located on the right-hand door pillar.

The vehicle identification plate also lists, in kilograms, the Gross Vehicle Weight (GVW), the Gross Combination Weight (GCW) and the maximum front and rear axle loads respectively. Observe these limits when using the full load or towing capacity of your vehicle.

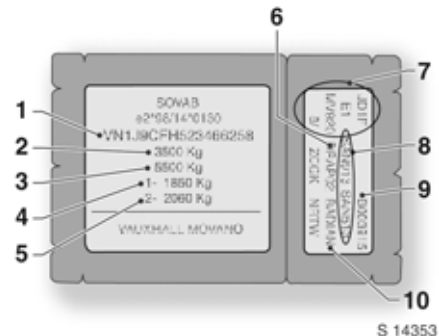

Information on identification plate:

- 1 Vehicle Identification Number
- 2 Permissible Gross Vehicle Weight
- 3 Permissible Gross Combination Weight
- 4 Maximum permissible front axle load
- 5 Maximum permissible rear axle load
- 6 Trim code
- 7 Technical specifications of vehicle
Vehicle paint code
Equipment level
Vehicle type
- 8 Additional equipment specification
- 9 Fabrication number
- 10 Interior trim code



S 12018

The Vehicle Identification Number is also displayed behind a removable plastic cover above the right-hand side door step.

Engine identification

It is possible, using the Vehicle Identification Number (VIN), to determine the engine type that is installed in your vehicle. The seventh digit denotes the engine type:

| 7th character | Engine |
|---------------|--|
| 1 | 2.5 Diesel, G9U 650 - 88 kw ¹⁾ |
| 2 | 2.5 Diesel, G9U 650 - 74 kw ¹⁾ |
| U | 2.5 Diesel, G9U 754 - 84 kw ²⁾ |
| V | 2.5 Diesel, G9U 754 - 73 kw ²⁾ |
| Y | 2.5 Diesel, G9U 632 - 107 kw ³⁾ |

- 1) Euro IV
 2) Euro III
 3) Euro IV with DPF

Engine identifier code and engine number

Stamped on a machined surface on the rear of the engine block or stamped on a metal plate on the right side of the engine block depending on variant.

Coolant, oils, brake fluid

To top up or lubricate:

- Coolant,
- Brake fluid,
- Manual transmission oil,
- Power steering fluid.

We recommend you consult your Vauxhall Authorised Repairer, who will advise you of the correct products to use.

Important: The use of incorrect lubricants and fluids can cause severe damage to your vehicle.

Engine oils

Information on engine oils is available in the Service Booklet.

154 Technical data

Engine data

| Sales designation Engine identifier code | 2.5 CDTI G9U 754¹⁾ | 2.5 CDTI G9U 754²⁾ |
|---|---|---|
| Number of cylinders | 4 | 4 |
| Bore dia. (mm) | 89.0 | 89.0 |
| Stroke (mm) | 99.0 | 99.0 |
| Piston displacement (cm ³) | 2464 | 2464 |
| Max. engine power (kW) at rpm | 73 3500 | 84 3500 |
| Torque (Nm) at rpm | 260 1500 | 290 1600 |
| Compression ratio | 17.8 : 1 | 17.8 : 1 |
| Emission standard | Euro III | Euro III |
| Cetane requirement (CN) ³⁾⁴⁾ | 49 (D) | 49 (D) |
| Fuel system type | Common rail | Common rail |

1) Low output

2) High output

3) Standard high-quality fuels, e.g. diesel EN 590; value printed in bold: recommended fuel.

4) A lower value is possible with winter fuels.

Engine data

| Sales designation Engine identifier code | 2.5 CDTI G9U 632 | 2.5 CDTI G9U 650¹⁾ | 2.5 CDTI G9U 650²⁾ |
|---|----------------------------|---|---|
| Number of cylinders | 4 | 4 | 4 |
| Bore dia. (mm) | 89.0 | 89.0 | 89.0 |
| Stroke (mm) | 99.0 | 99.0 | 99.0 |
| Piston displacement (cm ³) | 2464 | 2464 | 2464 |
| Max. engine power (kW) at rpm | 107 3500 | 74 3500 | 88 3500 |
| Torque (Nm) at rpm | 320 1500 | 260 1600 | 290 1600 |
| Compression ratio | 18.1 : 1 | 18.1 : 1 | 18.1 : 1 |
| Emission standard | Euro IV with DPF | Euro IV | Euro IV |
| Cetane requirement (CN) ³⁾⁴⁾ | 49 (D) | 49 (D) | 49 (D) |
| Fuel system type | Common rail | Common rail | Common rail |

1) Low output.

2) High output.

3) Standard high-quality fuels, e.g. diesel EN 590; value printed in bold: recommended fuel.

4) A lower value is possible with winter fuels.

Weights, payload and roof load

The payload is the difference between the permissible Gross Vehicle Weight and the EC kerbweight.

The combined total of front and rear axle loads (see vehicle identification plate) must not exceed the permissible Gross Vehicle Weight, i.e. if the front axle load is being fully utilized, the rear axle load must not be such that the permissible Gross Vehicle Weight is exceeded.

Optional equipment and accessories increase the kerbweight and in some cases also the permissible Gross Vehicle Weight, which means that the payload will also change slightly.

Note the weights given on the vehicle identification plate.

Roof loads must not be carried on maxi-roof variants. For standard or high roof variants, the maximum permissible roof load (which includes the weight of the roof rack) is 300 kg.

The maximum load on the Vauxhall full length roof rack system is 202 kg for short wheelbase models, 195 kg for medium wheelbase models and 188 kg for long wheelbase models.

Driving hints – see page 86.

Vehicle weights (approx. kg)

| Model | Wheelbase | Roof | GVW ¹⁾ | Kerbweight ²⁾ | | |
|-------|-----------|----------|-------------------|---------------------------|---------------------------|---------------------------|
| | | | | G9U 632 | G9U 650 | G9U 754 |
| Van | Short | Standard | 2800 | 1829 | 1815 | 1799 |
| | | | 3300 | 1832 | 1818 | 1802 |
| | | | 3500 | 1839 | 1825 | 1809 |
| | | High | 3300 | 1860 | 1846 | 1830 |
| | | | 3500 | 1867 | 1853 | 1837 |
| | | | 3500 | 1909 | 1894 | 1879 |
| | Medium | High | 3300 | 1901 | 1887 | 1871 |
| | | | 3500 | 1909 | 1894 | 1879 |
| | | Maxi | 3500 | 1932 | 1918 | 1879 |
| | | | 3500 | 1951 | 1937 | 1949 |
| Long | Maxi | 3500 | 1979 | 1964 | 1921 | |
| | | 3500 | 1979 | 1964 | 1921 | |
| Combi | Short | Standard | 2800 | 1916 / 1993 ⁴⁾ | 1901 / 1977 ⁴⁾ | 1850 / 1913 ⁴⁾ |
| | | | 2800 | 1994 / 2068 ⁴⁾ | 1980 / 2053 ⁴⁾ | 1928 / 1989 ⁴⁾ |
| | | | 3500 | 2007 / 2081 ⁴⁾ | 1992 / 2065 ⁴⁾ | 1940 / 2001 ⁴⁾ |

¹⁾ Both the Gross Vehicle Weight (GVW) and Gross Combination Weight (GCW) are shown on the VIN plate - see page 152.

²⁾ In accordance with EC directive of a base model, including assumed weights of driver (68kg), luggage (7kg) and all fluids (tank 90% full).

³⁾ Sales designation: see page 154.

⁴⁾ Half / fully glazed.

Vehicle weights (approx. kg)

| Model Engine ⁴⁾ | Wheelbase | Roof | GVW ¹⁾ | Kerbweight ^{2) 3)} | | |
|-------------------------------|-----------|----------|-------------------|-----------------------------|---------------------------|---------------------------|
| | | | | G9U 632 | G9U 650 | G9U 754 |
| Chassis cab | Short | Standard | 2800 | - | 1667 | 1651 |
| | Medium | Standard | 3500 | 1646 | 1632 | 1617 |
| | Long | Standard | 3500 | 1662 | 1648 | 1632 |
| Crew cab | Medium | Standard | 2800 | - | 1798 | 1783 |
| | | Standard | 3500 | 1821 | 1805 | 1801 |
| | Long | Standard | 3500 | 1831 | 1816 | 1814 |
| Platform cab | Medium | Standard | 3500 | 1654 | 1600 | 1584 |
| | | High | 3500 | 1672 | 1617 | 1602 |
| | Long | Standard | 3500 | 1654 | 1640 | 1625 |
| | | High | 3500 | 1672 | 1657 | 1642 |
| Chassis cowl | Medium | - | 3500 | 1359 | 1345 | 1330 |
| | Long | - | 3500 | 1374 | 1360 | 1344 |
| Bus | Long | High | 3900 | 2398 / 2403 ⁵⁾ | 2390 / 2395 ⁵⁾ | 2392 / 2397 ⁵⁾ |

¹⁾ Both the Gross Vehicle Weight (GVW) and Gross Combination Weight (GCW) are shown on the VIN plate - see page 152.

²⁾ In accordance with EC directive of a base model, including assumed weights of driver (68 kg), luggage (7 kg) and all fluids (tank 90% full).

³⁾ Chassis without body conversion.

⁴⁾ Sales designation: see page 154.

⁵⁾ 15 / 16 places.

158 Technical data

Weights, (approx. kg) optional equipment

Accessories

MTA (Tecshift) transmission

Weight

8

Tyre inflation pressures in bar/psi

The tyre inflation pressures given are valid for cold tyres. The increased tyre inflation pressure resulting from extensive driving must not be reduced.

The pressures given apply to both summer and winter tyres.

See page 110.

Tyre chains *

Tyre chains may be used on the front drive wheels only. We recommend you consult your Vauxhall Authorised Repairer - see page 111.

Restrictions

Not all tyres available on the market currently fulfill the necessary design requirements. Details on suitable makes of tyre are available from your Vauxhall Authorised Repairer.

Wheels

Tightening torque: 170 Nm

| Tyre | Inflation pressure with full load (bar/psi) ¹⁾ | |
|---------------------------|---|--------|
| | Front | Rear |
| 195/65 R 16 | 3.8/55 | 3.8/55 |
| 215/65 R 16 | 3.9/57 | 4.3/62 |
| 225/65 R 16 | 3.8/55 | 4.4/64 |
| 205/75 R 16 ²⁾ | 4.2/61 | 4.7/69 |

¹⁾ 1 bar corresponds to 100 kPa / 14.5 psi.

²⁾ Tyre chains must not be fitted, we recommend you consult your Vauxhall Authorised Repairer.

160 Technical data

Capacities (approx. in litres)

| | |
|--|-------------------|
| Cooling system | 10.0 |
| Fuel tank | 100 ¹⁾ |
| Engine oil with filter change: | |
| Euro IV | 7.5 |
| Euro III | 8.0 |
| Engine oil between MIN and MAX on dipstick | 1.5-2.0 |

¹⁾ Bus models and long wheel base Crew Cab - 70 litre fuel tank.

Dimensions (approx. mm)

| Type | Van | | | Combi | | Chassis cab | | |
|--------------------------------|-------|--------|------|-------|--------|-------------|--------|------|
| | Short | Medium | Long | Short | Medium | Short | Medium | Long |
| Wheelbase | Short | Medium | Long | Short | Medium | Short | Medium | Long |
| Length | 4899 | 5399 | 5899 | 4899 | 5399 | 4869 | 5369 | 5869 |
| Width | 1990 | 1990 | 1990 | 1990 | 1990 | 1990 | 199 | 1990 |
| with exterior mirrors | 2361 | 2361 | 2361 | 2361 | 2361 | 2361 | 2361 | 2361 |
| Height ¹⁾ - unladen | | | | | | | | |
| Standard roof | 2232 | - | - | 2206 | - | 2199 | 2198 | 2194 |
| High roof | 2472 | 2486 | 2484 | - | 2480 | - | - | - |
| Maxi | - | 2717 | 2716 | - | - | - | - | - |
| Wheelbase | 3078 | 3578 | 4078 | 3078 | 3578 | 3078 | 3578 | 4078 |
| Track width | | | | | | | | |
| Front | 1740 | 1740 | 1740 | 1740 | 1740 | 1740 | 1740 | 1740 |
| Rear | 1725 | 1725 | 1725 | 1725 | 1725 | 1725 | 1725 | 1725 |

¹⁾ Actual height is dependant on suspension type.

162 Technical data

Dimensions - continued (approx. mm)

| Type | Crew cab | | Platform cab | | Chassis cowl | | Bus |
|--------------------------------|----------|------|--------------|------|--------------|------|------|
| | Medium | Long | Medium | Long | Medium | Long | Long |
| Wheelbase | Medium | Long | Medium | Long | Medium | Long | Long |
| Length | 5369 | 5869 | 5313 | 5813 | 5352 | 5852 | 5899 |
| Width | 1990 | 1990 | 1990 | 1990 | 1970 | 1970 | 1990 |
| With exterior mirrors | 2361 | 2361 | 2361 | 2361 | - | - | 2361 |
| Height ¹⁾ - unladen | | | | | | | |
| Standard roof | 2208 | 2202 | 2198 | 2192 | 1641 | 1640 | - |
| High roof | - | - | 2439 | 2433 | - | - | 2456 |
| Maxi | - | - | - | - | - | - | - |
| Wheelbase | 3578 | 4078 | 3578 | 4078 | 3578 | 4078 | 4078 |
| Track width | | | | | | | |
| Front | 1740 | 1740 | 1740 | 1740 | 1740 | 1740 | 1740 |
| Rear | 1725 | 1725 | 1725 | 1725 | 1725 | 1725 | 1725 |

¹⁾ Actual height is dependant on suspension type.

Loadspace dimensions (approx. mm)

Van

| Wheelbase | Short | | Medium | | Long | |
|-------------------------------------|---------------|-----------|---------------|-----------|-------------|-----------|
| Roof height | Standard Roof | High Roof | High Roof | Maxi Roof | High Roof | Maxi Roof |
| Maximum rear door aperture height | 1632 | 1874 | 1874 | 1874 | 1874 | 1874 |
| Rear door aperture width (at floor) | 1515 | 1515 | 1515 | 1515 | 1515 | 1515 |
| Maximum load area height | 1670 | 1912 | 1912 | 2146 | 1912 | 2146 |
| Maximum load area width | 1764 | 1764 | 1764 | 1764 | 1764 | 1764 |
| Width between wheel arches | 1282 | 1282 | 1282 | 1282 | 1282 | 1282 |
| Max load floor length | 2634 | 2634 | 3134 | 3134 | 3634 | 3634 |
| Loading height unladen (approx.) | 543 | 543 | 540 | 539 | 537 | 536 |
| Sliding side door aperture width | 1099 | 1099 | 1099 | 1099 | 1099 | 1099 |
| Sliding side door aperture height | 1555 | 1800 | 1800 | 1800 | 1800 | 1800 |

164 Technical data

Turning circle diameter (approx. m)

| Type | Van | | | Combi | | Chassis cab | | |
|--------------|-------|--------|-------|-------|--------|-------------|--------|-------|
| | Short | Medium | Long | Short | Medium | Short | Medium | Long |
| Wheelbase | | | | | | | | |
| kerb to kerb | 12.07 | 13.75 | 15.20 | 12.07 | 13.75 | 13.75 | 13.75 | 15.20 |
| wall to wall | 12.48 | 14.11 | 15.68 | 12.48 | 14.11 | 14.11 | 14.11 | 15.68 |

| Type | Crew cab | | Platform cab | | Chassis cowl | | Bus |
|--------------|----------|-------|--------------|-------|--------------|-------|-------|
| | Medium | Long | Medium | Long | Medium | Long | Long |
| Wheelbase | | | | | | | |
| kerb to kerb | 13.75 | 15.20 | 13.75 | 15.20 | 13.75 | 15.20 | 15.20 |
| wall to wall | 14.11 | 15.68 | 14.11 | 15.68 | 14.11 | 15.68 | 15.68 |

Mounting dimensions of caravan/trailer towing equipment

all dimensions (in mm) for caravan/trailer towing equipment.

Dimension

| | |
|---|------|
| A | 961 |
| B | 100 |
| C | 393 |
| D | 1054 |
| E | 527 |
| F | 990 |
| G | 495 |
| H | 467 |
| J | 124 |
| K | 33 |

Warning

We recommend having caravan/trailer towing equipment retro-fitted by a Vauxhall Authorised Repairer.

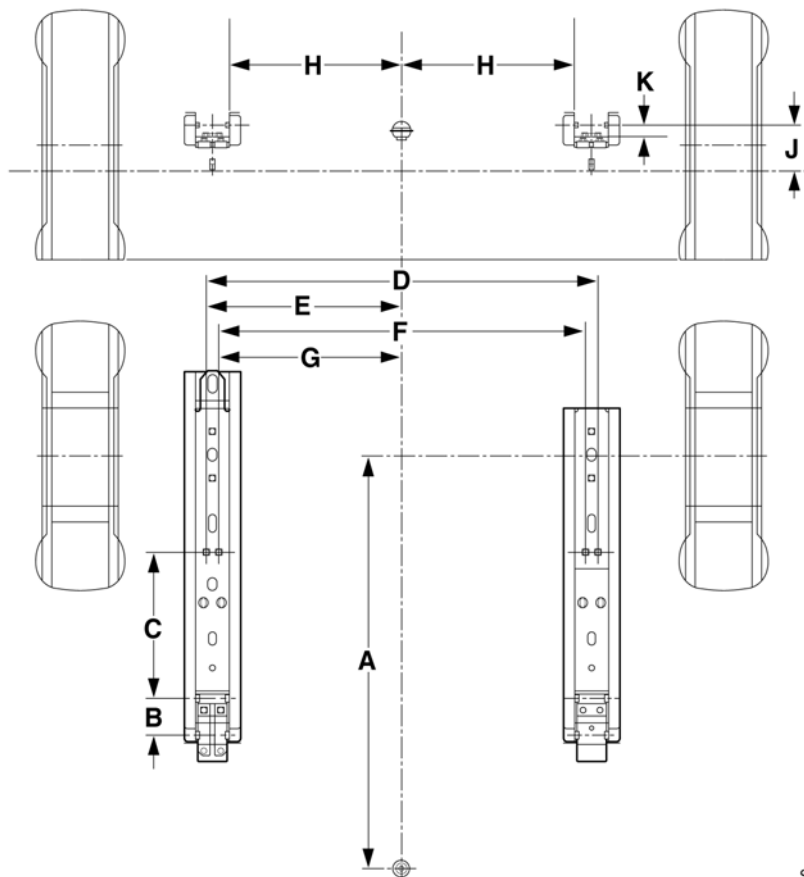

166 Technical data

Official authorization labels for the radio frequency remote control

D: G134324K

GB: 13598

B : RTT/D/X1669

DK CEPT/LPD/DK 9854

E: S36

FIN: FI 98080047

F: 98 0217 PP O

I: S37

N: NO9800394-R

P: S29

S: UE980096

CH: BAKOM 98038 S.K.P.

Index

A

| | |
|---------------------------------------|-------------|
| ABS | 105 |
| Accessories | 17 |
| Accessory socket | 44 |
| Air conditioning | |
| Rear compartment air conditioning ... | 76 |
| Air conditioning system | 75 |
| Air recirculation button | 76 |
| Air suspension | 98 |
| Airbag | 48, 52 |
| Alarm System | 35 |
| Antenna | 27, 28, 148 |
| Anti-corrosion service | 136 |
| Anti-freeze | 141 |
| Anti-freeze protection | 144 |
| Anti-theft alarm system | 35 |
| Ashtrays | 45 |
| Automatic locking | 34 |
| Automatic wiper | 12, 148 |

B

| | |
|-----------------------------------|----------|
| Back doors | 38 |
| Battery access | 145 |
| Battery isolation switch | 126 |
| Battery maintenance | 145 |
| Bonnet | 39 |
| Brake fluid | 142 |
| Brakes | 103 |
| Bulb replacement | 128, 129 |
| Fog lights | 133 |
| Front turn signal indicator | 130 |
| Headlights | 129 |
| High level brake light | 131 |
| Instrument illumination | 133 |
| Interior lights | 132, 133 |
| Number plate lights | 132 |
| Parking light | 130 |
| Side repeater light | 130 |
| Tail and brake lights | 131 |
| Third brake light | 133 |

C

| | |
|------------------------------|---------|
| Capacities | 160 |
| Caravan/trailer loads | 112 |
| Catalytic converter | 92, 95 |
| Central locking | 2, 33 |
| Child restraint system | 55 |
| Child safety locks | 29 |
| Cigarette lighter | 44 |
| Cleaning | 147 |
| Clock | 23 |
| Coat hook | 47 |
| Code numbers | 2 |
| Control indicators | 8, 18 |
| Coolant | 22, 140 |
| Coupling socket load | 113 |
| Cruise control | 99 |
| Speed limiter | 100 |

D

| | |
|------------------------------------|---------|
| Defrosting | 15 |
| Demisting | 14, 74 |
| Diesel fuel filter | 140 |
| Diesel fuel system, bleeding | 115 |
| Diesel particle filter | 93 |
| Dipped and main beam | 10 |
| Door locks | 2 |
| Door-to-door illumination | 64 |
| Driver's seat armrest | 3 |
| Driving abroad | 66, 134 |

E

| | |
|--|------------|
| Economical driving | 88 |
| Electric mirrors | 5 |
| Electric side step | 37 |
| Electric windows | 68 |
| Electronic immobiliser | 30 |
| Electronic tachograph | 27 |
| Emergency roof | 70 |
| Engine | |
| Data | 154 |
| Identification | 153 |
| Oil | 138 |
| Engine airflow indicator | 140 |
| Engine control indicator | 93 |
| Engine oil life monitor | 27, 94 |
| ESP (Electronic Stability Program) | 96 |
| Exhaust | |
| Emissions | 92 |
| Gases | 14, 93, 94 |

F

| | |
|----------------------|--------|
| First-aid kit | 119 |
| Flat tyre | 121 |
| Fog lights | 10 |
| Fog tail light | 10, 63 |
| Footbrake | 104 |
| Front doors | 29 |
| Fuel | 90 |
| Consumption | 88 |
| Cut-off device | 91 |
| Gauge | 21 |
| Fusebox | 127 |

G

| | |
|---|----|
| Genuine Vauxhall Parts and Accessories | 17 |
|---|----|

H

| | |
|--|---------|
| Handbrake | 15, 104 |
| Hazard warning lights | 11 |
| Head restraints | 4, 40 |
| Headlight | |
| Aiming | 129 |
| Flash | 10 |
| Range adjustment | 64 |
| Wash system | 12 |
| Heated exterior mirrors | 75 |
| Heated rear windows | 15, 75 |
| Heated seats | 79 |
| Heating | 71, 73 |
| Rear compartment additional heating | 77 |
| Horn | 11 |

I

| | |
|-----------------------|------------|
| Ignition | 14 |
| Immobiliser | 30 |
| Indicators | 11 |
| Instruments | 18 |
| Interior lights | 64, 65, 66 |

J

| | |
|------------------------------|-----|
| Jack and vehicle tools | 121 |
| Jump start terminal | 117 |

K

| | |
|------------|-------|
| Keys | 2, 29 |
|------------|-------|

L

| | |
|----------------------------|--------|
| Laden programme | 83 |
| Lashing points | 43 |
| Light switch | 10, 62 |
| Lighting | 62 |
| Load anchorage rails | 43 |
| Loadspace dimensions | 163 |
| Luggage rack | 46 |

M

| | |
|---|-------|
| Maintenance | 17 |
| Manual transmission | 13 |
| Mirrors | 4, 61 |
| Mobile telephones and radio equipment (CB) | 28 |
| Multi-function display | 22 |

N

| | |
|-------------------------|----|
| Navigation system | 28 |
|-------------------------|----|

O

| | |
|-------------------------|--------|
| Office bench seat | 41 |
| Oil filler funnel | 137 |
| Oil level display | 23 |
| Oil life monitor | 27, 94 |
| Overhead storage | 45, 46 |

P

| | |
|---|-----|
| Parking | 16 |
| Parking distance sensors | 102 |
| Parts | 17 |
| Power steering | 86 |
| Power steering fluid | 144 |
| Protection of electronic components ... | 146 |

R

| | |
|---------------------------------------|---------|
| Radio | 27 |
| Rain sensor | 12, 143 |
| Rear axle load during towing | 113 |
| Rear bench seat | 42 |
| Rear compartment lights | 65 |
| Rear door lock isolation switch | 38 |
| Refuelling | 91 |
| Remote control | 31 |
| Battery changing | 32 |
| Replacement keys | 29 |
| Reverse lights | 64 |
| Roof rack | 89, 112 |

S

| | |
|----------------------------|--------------------|
| Safety | 137 |
| Safety accessories | 57, 58, 59, 60, 61 |
| Saving energy | 88 |
| Seat belts | 4, 48, 49 |
| Seats | 2, 40 |
| Height adjustment | 3 |
| Office bench seat | 41 |
| Rear bench seat | 42 |
| Removable | 41 |
| Self-help | 115 |
| Service | 17 |
| Service Booklet | 17 |
| Sliding side door | 36 |
| Spare keys | 29 |
| Spare wheel | 120 |
| Speed | |
| Fuel consumption | 88 |
| Speedometer | 21 |
| Starter switch | 5 |
| Starting on inclines | 114 |
| Starting the engine | 5, 14 |
| Jump leads | 116 |
| Pushing or towing | 116 |
| Steering column lock | 5 |
| Sunroof | 69 |
| Sunvisors | 61 |

T

| | |
|----------------------------|---------------|
| Tachograph | 27 |
| Tachometer | 21 |
| Tecshift | 13, 80, 82 |
| Towing | |
| Another vehicle | 119 |
| Service | 119 |
| The vehicle | 118 |
| Towing equipment | 112 |
| Transmission display | 22, 80 |
| Trip computer | 24 |
| Trip odometer | 23 |
| Turn signal lights | 11 |
| Tyre chains | 111 |
| Tyre repair kit | 122 |
| Tyres | |
| Condition | 108 |
| Inflation pressures | 107, 113, 159 |

V

| | |
|--------------------------------------|------------|
| Vauxhall alarm system | 35 |
| Vauxhall Parts and Accessories | 17 |
| Vauxhall Service | 17 |
| Vehicle care | 147 |
| Vehicle identification data | 152 |
| Vehicle loading | 43 |
| Vehicle storage | 146 |
| Vehicle weights | 157 |
| Ventilation | 71, 72, 73 |

W

| | |
|-------------------------------|---------|
| Warning buzzers | 16 |
| Warning triangle | 119 |
| Washing | 147 |
| Wheel changing | 121 |
| Wheels, tyres | 107 |
| Windows | 67 |
| Opening upper windows | 69 |
| Sliding side windows | 68 |
| Windscreen wash system | 12, 144 |
| Windscreen wiper | 12, 143 |
| Winter operation | |
| Fuel for diesel engines | 90 |
| Winter programme | 82 |
| Winter tyres | 110 |



©Copyright by Vauxhall Motors Ltd., England.

Reproduction or translation, in whole or in parts, is not permitted without prior written consent from Vauxhall Motors Ltd.

All rights as understood under the copyright laws are explicitly reserved by Vauxhall Motors Ltd.

All information, illustrations and specifications contained in this manual are based on the latest production information available at the time of publication.

The right is reserved to make changes at any time without notice.

Edition: July 2007.

TS 1515-A-08

