

Original Instruction

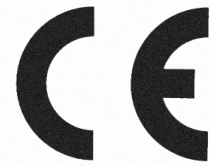

---

# Owner's (Operator's) Manual and Safety Instructions

---

## Manually Lever Operated Chain Hoist Model L5

 **WARNING**

This equipment must not be installed, operated or maintained by any person who has not read and understood all the contents of this manual. Failure to read and comply with the contents of this manual can result in serious bodily harm or death, and/or property damage.

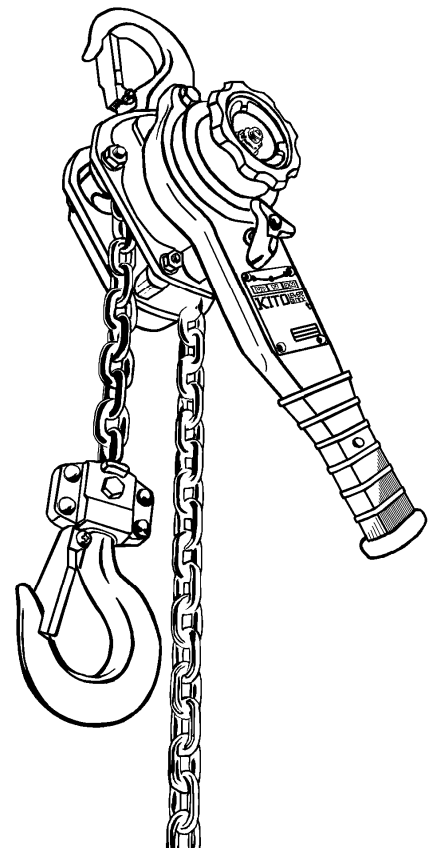

# KITO

Fill in the following product information for identification and future reference to avoid referring to the wrong manual for information or instructions on installation, operation, inspection, maintenance, or parts.

Model Code:

---

Serial Number:

---

Date of Purchase:

---

Dealer:

---

# Table of Contents

<b>1. IMPORTANT INFORMATION AND WARNINGS .....</b>	<b>4</b>
1.1. REGARDING THIS INSTRUCTIONS MANUAL .....	4
1.2. PROHIBITED PRACTICES .....	4
<b>2. TECHNICAL INFORMATION.....</b>	<b>8</b>
2.1. SPECIFICATIONS.....	8
2.2. DIMENSIONS .....	9
<b>3. MOUNTING .....</b>	<b>10</b>
<b>4. OPERATION .....</b>	<b>11</b>
4.1. INTRODUCTION .....	11
4.2. FREE CHAINING.....	11
4.3. LOAD OPERATION .....	12
4.4. LOAD SIGNAL (AS OPTION).....	13
<b>5. INSPECTION.....</b>	<b>14</b>
5.1. INSPECTION CLASSIFICATION .....	14
5.2. DAILY INSPECTION .....	15
5.3. FREQUENT INSPECTION .....	15
5.4. PERIODIC INSPECTION .....	18
<b>6. MAINTENANCE AND STORAGE .....</b>	<b>23</b>
6.1. GENERAL.....	23
6.2. DISASSEMBLY, ASSEMBLY AND ADJUSTMENT .....	23
6.3. TOOLS .....	24
6.4. COMPONENTS.....	25
6.5. DISASSEMBLY.....	26
6.6. ASSEMBLY .....	26
6.7. PREOPERATIONAL CHECKS .....	31
<b>7. TROUBLESHOOTING .....</b>	<b>32</b>
<b>8. WARRANTY .....</b>	<b>37</b>
<b>9. PARTS LIST .....</b>	<b>38</b>
9.1. UP TO 3.2 TONNES.....	38
9.2. EXCLUSIVE PARTS .....	39
9.3. OPTIONAL PARTS.....	40
<b>10. CONTENTS OF EC DECLARATION OF CONFORMITY .....</b>	<b>41</b>

# 1. Important Information and Warnings

## 1.1. Regarding this instructions manual

This manually lever-operated chain hoist model L5 is designed to lift and lower a load by using manual force, and hold it by using the braking device under normal working conditions, not intended to transport a person.

The following symbols are used in this manual to identify the degree or level of hazard seriousness.

### **DANGER**

This symbol indicates an imminently hazardous situation which, if not avoided, **will** result in **death or serious injury**, and property damage.

### **WARNING**

This symbol indicates a potentially hazardous situation which, if not avoided, **could** result in **death or serious injury**, and property damage.

### **CAUTION**

This symbol indicates a potentially hazardous situation which, if not avoided, **may** result in **minor or moderate injury**, or property damage.

Even the caution situations may result in serious injury or death depending on conditions. Therefore, notice should be taken whenever encountering them.

**Always keep this manual in a convenient place for operator's reference.**

## 1.2. Prohibited practices

### 1.2.1. General

Improper usage or negligent maintenance of the hoist may result in dangerous situations arising such as a lifted load dropping. Before installing, operating or maintaining, read and comply with both this manual for the safety and operation instructions, and notes for all the equipments.

KITO will not be held liable for any malfunction, lack of performance or accident if the product is being used in conjunction with any other equipment. If the product is to be used for unintended purposes, please confirm with your dealer in advance.

### **DANGER**

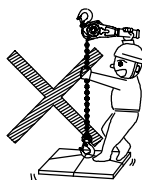

- Do not use the hoist to support, lift or transport people.

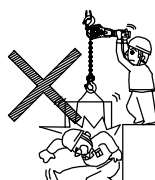

- Do not go under a lifted load or its path, and do not move the lifted load over people.

### **WARNING**

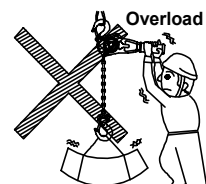

- Do not lift more than the rated load.

- Do not modify the product or its accessories.

**! CAUTION**

- Before moving the load, warn all people in the vicinity.
- Do not operate the hoist unless the contents of this operating manual and the warning labels are fully understood.

1.2.2. Prior to operation

**! CAUTION**

- This manual is intended for the operator who will use the hoist. Prior to operation, all of the safety and operating instructions must be fully understood.

**! WARNING**

- Do not use a deformed or scarred hook.
- Replace components with new ones authorized by KITO.

**! CAUTION**

- Be sure to wear the proper clothing and personal protective equipment when using and operating the product.
- Make sure that the nameplate is readable
- Before operation, make sure to perform all inspections given in **5.1 Inspection classification**
- Use a proper hoist for your purpose, capacity and lift.
- Ensure to check that the hook latches are not deformed or scarred, and are moving smoothly.
- Ensure to check that the brake and free chaining functions properly work.
- Ensure to check that the load chain is well-lubricated.
- Ensure to avoid welding sparks on the hoist and load chain.

1.2.3. Operation

**! WARNING**

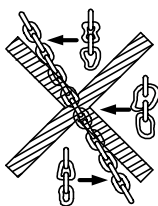

- Do not use the hoist with deformed or scarred load chain.

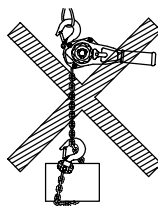

- Do not use the load chain as a sling.

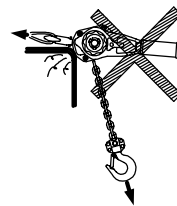

- Do not use the hoist as a fulcrum.

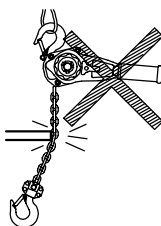

- Do not impede the chain on any surface e.g. a steel plate.

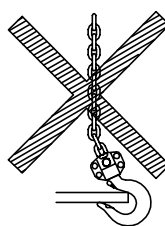

- Do not support a load on the tip of the hook.

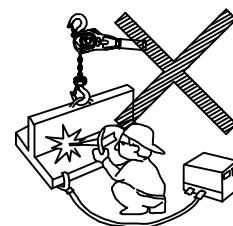

- Do not perform welding or cutting operation on the load being suspended.

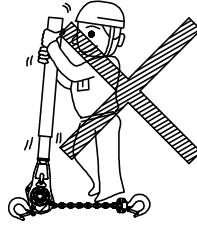
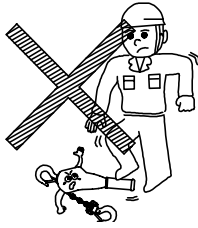

- Do not use the hoist by stepping on the lever.
- Do not extend the lever by attaching a pipe to it.
- Do not swing a lifted load.
- Do not use the load chain as an earth for welding.
- Do not lift excessively until the bottom yoke comes into contact with the hoist body.
- Do not lower excessively until the chain stopper comes into contact with the hoist body.
- Do not use a damaged hoist or one having abnormal sounds.
- Do not use a hoist with a loose lever grip.
- Do not leave a lifted load unattended for a long time.
- In lowering mode, do not pull the no-load-side chain which could cause a hazardous situation arising the grip revolving.

### CAUTION

- Ensure to place a load properly on the middle of the hook saddle.
- Before lifting, ensure to eliminate load chain slack to avoid a shock load.
- There are risks of overheating of the braking system during prolonged lowering of loads. If you are considering the use under such condition, consult KITO.
- When any abnormality is observed during the operation, stop the operation immediately, indicate "FAILURE" and contact with the maintenance engineers.
- When inspecting and repairing, be sure to indicate "INSPECTION" and carry out without lifting a load.

#### 1.2.4. After operation

### CAUTION

- After operating, ensure to put a load down securely to avoid dropping it.

### WARNING

- Do not drag or throw the hoist when carrying it.

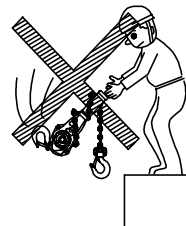

#### 1.2.5. Inspection and Maintenance

### CAUTION

- Ensure that competent people periodically conduct inspections and maintenance corresponding to **5 Inspection** and **6 Maintenance** otherwise please confirm with your dealer.
- Indicate "CHECKING" when performing the inspection.
- Wear protection equipment such as protection goggles and gloves depending on the work contents.
- Pay attention to work method, work procedure and work posture.
- Wear helmet and safety belt when carrying the high lift work.
- Remove the oil or grease attached to the product or spilt on the floor.
- Keep the work area clean when disassembling the product.

**! WARNING**

- Do not extend or weld the load chain.

1.2.6. Others

**! CAUTION**

- In case of use in special environments such as salt water, seawater, acidic, alkaline or explosive atmospheres, confirm with your dealer in advance.

**! WARNING**

- Do not use the hoist which is out of order or under repair.
- Do not use the hoist with warning labels or tags missing.

## 2. Technical Information

### 2.1. Specifications

#### 2.1.1. Schematics

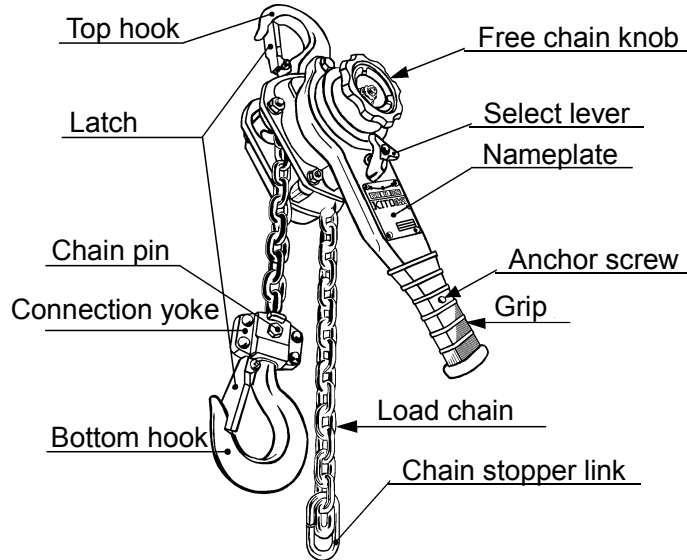

#### 2.1.2. Operating conditions and environment

Temperature range: -40° to +60°C (-40° to +140°F)

Humidity: 100% or less, this is not an underwater device.

Not applicable for explosive atmosphere (No special materials such as sparkless used)

**Table 2-1 Hoist Specifications**

Capacity (t)	Product Code	Standard Lift (m)	Pull to Lift Rated Load (N)(kgf)	Load Chain Diameter x Pitch (mm)	Chain Fall Lines	Test Load (t)	Net Weight (kg)	Weight for Additional One Meter of Lift (kg)
0.8	LB008	1.5	284(29)*	5.6 × 15.7	1	1.2	5.7	0.7
1	LB010	1.5	353(36)*		1	1.5	5.9	0.7
1.6	LB016	1.5	333(34)*	7.1 × 19.9	1	2.4	8.0	1.1
2.5	LB025	1.5	363(37)*	8.8 × 24.6	1	3.8	11.2	1.7
3.2	LB032	1.5	363(37)*	10 × 28.0	1	4.8	15.0	2.3
6.3	LB063	1.5	372(38)*		2	7.9	26	4.7
9	LB090	1.5	382(39)*		3	11.3	40	7.0

- This device was tested according to the required static and dynamic load test provided on the European standard EN 13157.
- \*marked "Pull to Lift Rated Load" does not comply with the requirement of EN 13157. (5.2.6 Operating effort)



## 2.2. Dimensions

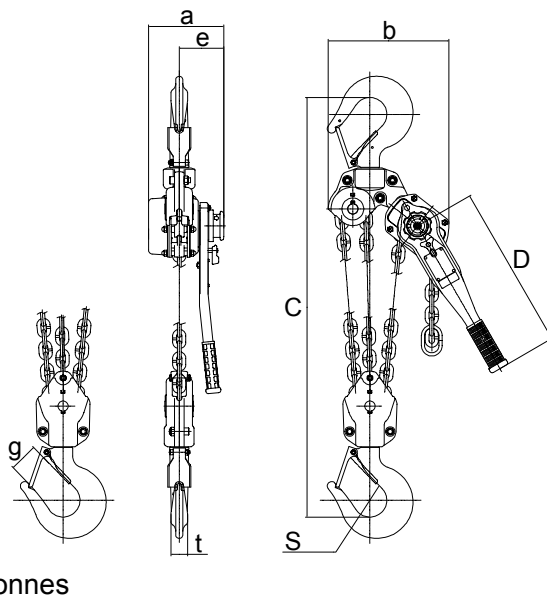
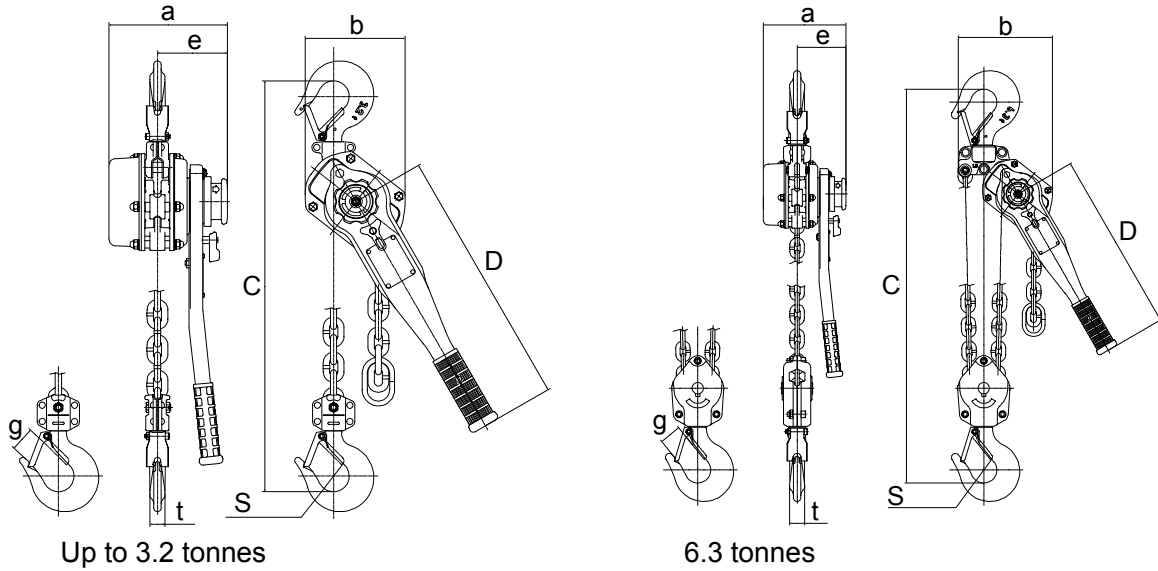

**Table 2-2 Hoist Dimensions**

Units: mm

Hoist Code	a	b	c	d	e	g	s	t
LB008	114	119	280	245	97	23.5	35.5	14
LB010	114	119	300	245	97	29	42.5	15
LB016	159	126	335	265	100	32	42.5	19
LB025	173	150	375	265	102	36.5	47	21
LB032	190	159	395	415	112	39	50	24.5
LB063	190	217	540	415	112	50	60	34
LB090	190	304	680	415	112	72.5	85	41.5

### 3. Mounting

#### **WARNING**

##### **Avoid the following when mounting the hoist.**

- ALWAYS** Failure to comply with these instructions may result in death or severe injury.
- Ensure that only trained or competent persons install the hoist.
  - Do not install the hoist within the range of movement of other devices (equipment), such as a trolley.

---

##### **Comply with the following instructions when installing the hoist.**

- ALWAYS** Failure to comply with these instructions may result in death or severe injury.
- The hoist may lift and hold a load more than the rated load. Check that the structure for mounting the hoist has sufficient strength.
  - Fix the Top Hook to the structure securely.

#### **CAUTION**

##### **Comply with the following instructions when installing the hoist.**

- ALWAYS** Failure to comply with these instructions may result in injury or damage to property.
- Install the hoist to avoid impeding the hoist.
  - Install the Load Chain with sufficient length for lifting work.

## 4. Operation

### 4.1. Introduction

Operating a heavy load may result in hazardous situations. Before operating, read and comply with all of the information in this clause and **1.2 Prohibited practices**.

Before operating the hoist, secure the workplace as follows:

- Ensure to arrange the workplace to work smoothly.
- Ensure to keep a good view to monitor the operation, otherwise arrange watch personnel.

### 4.2. Free chaining



**DANGER**

Do not operate the hoist in free chaining mode under a load.

#### 4.2.1. Features

- Free chaining can freely feed the load chain as the brake is released under no load situations.
- Pulling the free chain knob moves the internal spring to release the mechanical brake and to pull the load chain in either direction to its needed length.

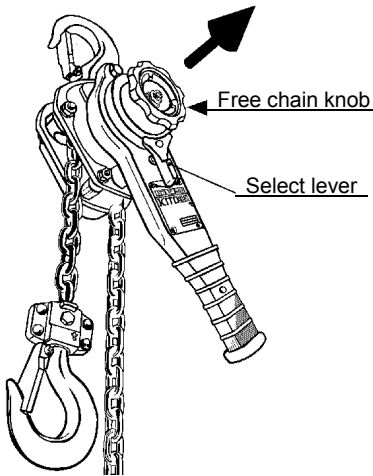

#### 4.2.2. How to operate

1. Set the select lever to the neutral ('N') position.
2. Pull the free chain knob upwards.
3. In this mode, the load chain can be pulled through the hoist to its required length.



**CAUTION**

Do not pull the load chain suddenly in free chaining mode.

- Excessive pulling may make a brake and can not feed the chain.
- In this case, reset the hoist (see 4), make some lowering operations, and then start over.
- 4. To reset the hoist for load operation, turn the free chain knob clockwise with the load-side chain pulled lightly. The knob will come into contact again to operate the hoist with the grip.

When a load under the minimum load for each capacity shown in the following table is applied to the load chain, the brake does not operate.

Do not apply any load to the load chain in free chaining mode, except for the positional adjustment of the load chain by an operator.

Capacity (t)	0.8, 1	1.6	2.5	3.2	6.3	9
Minimum load for the automatic closing of the brake (kg)	25	38	54	35	90	130

### 4.3. Load operation

#### 4.3.1. Features

Operating the grip with the select lever set to the lifting ('UP') or the lowering ('DN') position, the hoist performs as follows:

- In lifting mode, the tightened mechanical brake rotates as one and supports a load on the pawls when the grip stops.
- In lowering mode, grip operation un-tightens the mechanical brake and lowers the load chain, and when the grip stops, the mechanical brake is tightened and supports the load instantly.
- In lifting and lowering, braking always acts.

#### 4.3.2. How to operate



**DANGER**

Do not operate the free chain knob in lifting or lowering.



**CAUTION**

Before operating, make sure that the hoist is out of the free chaining mode and the select lever position meets your operation demands.

The following table shows select lever position and grip operation for lifting and lowering.

**Table 3-1 Hoist & Grip Operation**

Hoist Operation	Select Lever	Grip Operation
Lifting	UP	Clockwise
Lowering	DN	Counterclockwise



**CAUTION**

Under no load conditions, in the case that the load chain does not lower against your lowering operation, operate the grip with the load-side chain pulled lightly. (This is a standard manner.)

#### 4.4. Load signal (as option)

This load signal is designed as an overload detecting device to warn an operator that an excessive load has been applied which could cause a hazardous situation.

#### **! DANGER**

- Disregarding the overload sign could cause bodily harm or damage to the hoist. Do not lift an overload. Warn all the people in the vicinity and remove the causes.

#### **! CAUTION**

- Do not leave dust or foreign objects in the load signal.
- Disassembling the hoist or changing the signal setting will invalidate your product warranty. Contact your dealer for disassembly or repair.
- Excessive impact on the grip may result in a malfunctioning signal or damage to the components.
- Using the hoist recklessly may cause the load signal to work improperly.

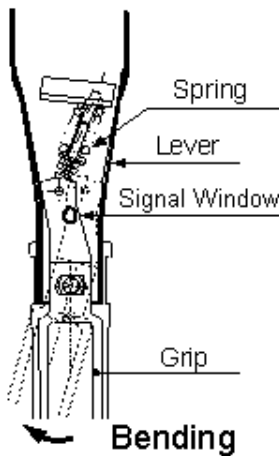

##### 4.4.1. Features

- Lifting pull is transmitted to the grip through the spring inside the lever.
- A pull over the designed limit\* compresses the spring and bends the grip. (\*in response to 100 to 120 % of the rated capacity)
- Then the color of the signal window on the lever changes to warn the operator of an overload.
- The signal colors are identified as shown in the following table.

**Table 3-2 Signal Warning**

Signal Color	Load Status	Instructions
Green	Safe load	Continue operation
Red	Overload	Do not continue operation

##### 4.4.2. How to operate

1. Operate the hoist by holding the grip in the middle.
2. The following events of the load signal warn you of an overload.
  - The grip is bent.
  - The lever clicks.
  - The signal window changes from green to red.
3. Stop lifting and lower immediately when an overload is detected.
4. Reset the grip into its straight position (back in place) before operation commences.
5. Reduce the load to less than the rated load.
  - Check that the structure for mounting the hoist has no damage.

## 5. Inspection

To maintain continuous and satisfactory operation, a regular inspection procedure must be initiated to replace worn or damaged parts before they become unsafe.

### 5.1. Inspection classification

Inspection intervals must be determined by the individual application and are based on the type of service to which the hoist will be subjected and the degree of exposure to wear, deterioration or malfunction of the critical components.

The type of service to which the hoist is subjected can be classified below:

- **Normal Service** – service that involves operation with randomly distributed loads within the rated load limit, or uniform loads less than 65% of rated load for not more than 15% of the time.
- **Heavy Service** – service that involves operation within the rated load limit which exceeds normal service.
- **Severe Service** – service that involves normal or heavy service with abnormal operating conditions.

The three general classifications are herein designated as DAILY, FREQUENT and PERIODIC, with respective intervals between inspections as defined below.

**DAILY Inspection** – by the operator or other designated people before daily operation.

**FREQUENT Inspection** – by the operator or other designated people with intervals per the following criteria:

- Normal service – monthly
- Heavy service – weekly to monthly
- Severe service – daily to weekly

Records are not required.

**PERIODIC Inspection** – by a designated people with intervals per the following criteria:

- Normal service – yearly
- Heavy service – semiannually – 6 months
- Severe service – quarterly – 3 months

Records are to be kept for continuing evaluation of the condition of the hoist.

5.2. Daily inspection

**Table 4-1 Daily Inspection Methods and Criteria**

Item	Method	Criteria	Action
Nameplate, Warning Tag	Visual	Should be affixed properly and readable.	Replace.
Function – Lifting	Set the select lever to 'UP' and make lifting operation with the load-side chain pulled slightly.	Moving the lever forward and backward should make clicking sounds.	Repair or replace as necessary.
Function – Lowering	Set the select lever to 'DN' and make lowering operation with the load-side chain pulled slightly.	Moving the lever only backward, not forward, should make clicking sounds.	Repair or replace as necessary.
Function – Free Chaining	Set the select lever to 'N' and pull the free chain knob upward into free chaining mode to adjust the chain length.	- The chain should be pulled smoothly. - The free chain knob should be easily pulled or reset.	Repair or replace as necessary.
Hooks – Condition	Visual, Function	- Should be not deformed. - Should turn smoothly.	Replace
Hooks – Latches	Visual	Should be not deformed or scarred.	Replace
Load Chain	Visual	- Should be free of severe rust. - Should be coated with lubricant. - Should not be deformed or scarred.	Replace Clean/Lubricate Replace
Others	Visual	- Nuts, split pins, grip or screws should not be loose or missing. - Hoist should not be scarred or damaged. - Chain stopper link at no-load side should not be missing or deformed. - Bottom hook on multiple chain fall line models should not be capsized.	Replace  Correct all chain irregularities as shown in the following picture.

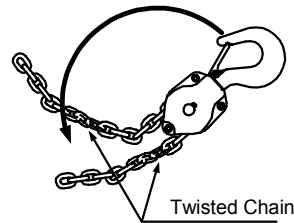

Capsized Hook and Chain  
Double Fall Models

5.3. Frequent Inspection

Evaluation and resolution of the results of the frequent inspections shall be made by a designated person so that the hoist is maintained in safe working condition.



**WARNING**

Do not use components beyond the stated criteria or KITO-unauthorized ones.



In addition to the daily inspections, perform the following checks.

**Table 4-2 Frequent Inspection Methods and Criteria**

Item	Method	Criteria	Action
------	--------	----------	--------

Put the hoist under a light load and check the following items of "Function - ....."

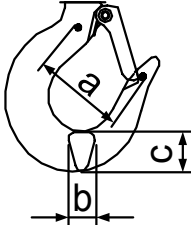
Function – Lifting	Set the select lever to 'UP' and lift the load operation 20 to 30 cm.	Moving the lever forward and backward should make clicking sounds.	Repair or replace as necessary.
Function – Lowering	Set the select lever to 'DN' and lower the load operation 20 to 30 cm.	Moving the lever only backward, not forward, should make clicking sounds.	Repair or replace as necessary.
Function – Abnormal Sounds	Check auditorily.	Should have no damped clicking or irregular sounds.	Repair or replace as necessary.
Function – Pull	Check function.	Should not be extremely heavy.	Repair or replace as necessary.
Function – Braking	Check function.	Should not slip.	Repair or replace as necessary.

Hooks – Stretch	<p>Measure</p>  <p>Record the following sizes, a, b and c at the time of purchase.</p> <table border="1" data-bbox="622 929 1157 1086"> <thead> <tr> <th>Measured when new (mm)</th> <th>Discard limit</th> </tr> </thead> <tbody> <tr> <td>a:</td> <td>Over the measured</td> </tr> <tr> <td>b:</td> <td>5 % or more reduction</td> </tr> <tr> <td>c:</td> <td>5 % or more reduction</td> </tr> </tbody> </table>	Measured when new (mm)	Discard limit	a:	Over the measured	b:	5 % or more reduction	c:	5 % or more reduction	Replace																																															
Measured when new (mm)	Discard limit																																																								
a:	Over the measured																																																								
b:	5 % or more reduction																																																								
c:	5 % or more reduction																																																								
Hooks – Abrasion	<table border="1" data-bbox="486 1120 1141 1388"> <thead> <tr> <th rowspan="2">Capacity (tonnes)</th> <th colspan="2">a* (mm)</th> <th colspan="2">b (mm)</th> <th colspan="2">c (mm)</th> </tr> <tr> <th>Nominal</th> <th>Standard</th> <th>Standard</th> <th>Discard</th> <th>Standard</th> <th>Discard</th> </tr> </thead> <tbody> <tr> <td>0.8</td> <td>44</td> <td>14.0</td> <td>13.3</td> <td>19.6</td> <td>18.6</td> </tr> <tr> <td>1</td> <td>52</td> <td>15.0</td> <td>14.3</td> <td>21.0</td> <td>20.0</td> </tr> <tr> <td>1.6</td> <td>55</td> <td>19.0</td> <td>18.1</td> <td>25.7</td> <td>24.4</td> </tr> <tr> <td>2.5</td> <td>63</td> <td>21.0</td> <td>20.0</td> <td>29.0</td> <td>27.6</td> </tr> <tr> <td>3.2</td> <td>67</td> <td>24.5</td> <td>23.3</td> <td>31.0</td> <td>29.5</td> </tr> <tr> <td>6.3</td> <td>90</td> <td>34.0</td> <td>32.3</td> <td>41.0</td> <td>39.0</td> </tr> <tr> <td>9</td> <td>111</td> <td>41.5</td> <td>39.4</td> <td>52.0</td> <td>49.4</td> </tr> </tbody> </table> <p>*These values are nominal since the dimensions are not controlled to a tolerance. The measurements at the time of purchase become the reference ones. Subsequent measurements are compared to these references to make determinations about hook deformation/stretch.</p>	Capacity (tonnes)	a* (mm)		b (mm)		c (mm)		Nominal	Standard	Standard	Discard	Standard	Discard	0.8	44	14.0	13.3	19.6	18.6	1	52	15.0	14.3	21.0	20.0	1.6	55	19.0	18.1	25.7	24.4	2.5	63	21.0	20.0	29.0	27.6	3.2	67	24.5	23.3	31.0	29.5	6.3	90	34.0	32.3	41.0	39.0	9	111	41.5	39.4	52.0	49.4	Replace
Capacity (tonnes)	a* (mm)		b (mm)		c (mm)																																																				
	Nominal	Standard	Standard	Discard	Standard	Discard																																																			
0.8	44	14.0	13.3	19.6	18.6																																																				
1	52	15.0	14.3	21.0	20.0																																																				
1.6	55	19.0	18.1	25.7	24.4																																																				
2.5	63	21.0	20.0	29.0	27.6																																																				
3.2	67	24.5	23.3	31.0	29.5																																																				
6.3	90	34.0	32.3	41.0	39.0																																																				
9	111	41.5	39.4	52.0	49.4																																																				
Hooks – Deformation, Scars	<p>Check visually.</p> 	<ul style="list-style-type: none"> <li>- Should not be significantly twisted or deformed.</li> <li>- The shank portions of the hook should be evenly worn.</li> <li>- Should have no deep scars.</li> <li>- Should have no loose or missing rivets, bolts or nuts.</li> <li>- Should have no welding sparks.</li> </ul>	Replace																																																						
Hooks – Swivel	<p>Check visually, and check function.</p> 	The hook should rotate smoothly.	Replace																																																						

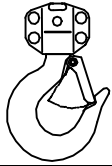
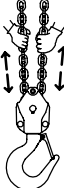
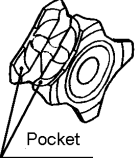

Item	Method	Criteria	Action
Hooks – Hook Latches	Check visually, and check function. 	- Should be held in place on the tip of the hook. - Should move smoothly. <b>⚠ WARNING</b> Do not use the hook with the latch missing.	Replace the hook latch.
Hooks – Idle Sheave (bottom hook on double fall hoist)	Check visually, and check function. 	<b>⚠ WARNING</b> Make sure to avoid having your fingers caught. Should rotate smoothly. (If not, idle sheave or axle may be deformed or worn.)	Replace the idle sheave and axle.
Hooks – Idle Sheave	Check visually. 	Pockets of idle sheave should be free of wear or scars.	Replace the idle sheave and axle.

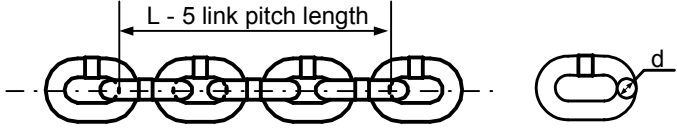
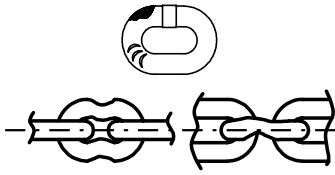
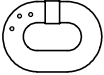
Load Chain – Wear	Measure 		Replace																													
	<table border="1"> <thead> <tr> <th rowspan="2">Capacity (tonnes)</th> <th colspan="2">L dimension (mm)</th> <th colspan="2">d dimension (mm)</th> </tr> <tr> <th>Standard</th> <th>Discard</th> <th>Standard</th> <th>Discard</th> </tr> </thead> <tbody> <tr> <td>0.8, 1</td> <td>79.0</td> <td>81.3</td> <td>5.6</td> <td>5.1</td> </tr> <tr> <td>1.6</td> <td>100.0</td> <td>102.9</td> <td>7.1</td> <td>6.4</td> </tr> <tr> <td>2.5</td> <td>124.0</td> <td>127.6</td> <td>8.8</td> <td>7.9</td> </tr> <tr> <td>3.2, 6.3, 9</td> <td>141.0</td> <td>145.1</td> <td>10.0</td> <td>9.0</td> </tr> </tbody> </table> <p>Notice: If wear on the load chain is found, make sure to check the load sheave.</p>	Capacity (tonnes)	L dimension (mm)		d dimension (mm)		Standard	Discard	Standard	Discard	0.8, 1	79.0	81.3	5.6	5.1	1.6	100.0	102.9	7.1	6.4	2.5	124.0	127.6	8.8	7.9	3.2, 6.3, 9	141.0	145.1	10.0	9.0		
Capacity (tonnes)	L dimension (mm)		d dimension (mm)																													
	Standard	Discard	Standard	Discard																												
0.8, 1	79.0	81.3	5.6	5.1																												
1.6	100.0	102.9	7.1	6.4																												
2.5	124.0	127.6	8.8	7.9																												
3.2, 6.3, 9	141.0	145.1	10.0	9.0																												
Load Chain – Rust	Check visually.	Should be free of significant rust. <b>⚠ WARNING</b> Make sure to lubricate the load chain frequently.	Replace																													
Load Chain – Deformation, Scars	Check visually. 	- Should be free of deformation (such as twist). - Should be free of deep scars or dents.	Replace																													
Load Chain – Welding Sparks	Check visually. 	Should be free of welding sparks. <b>⚠ WARNING</b> Make sure to avoid welding sparks on the hoist.	Replace																													

### 5.4. Periodic Inspection

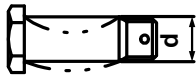

In addition to the frequent inspections, perform the following checks.

**Table 4-3 Periodic Inspection Methods and Criteria**

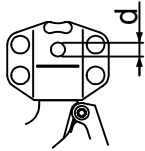
Item	Method	Criteria	Action																	
Chain Pin – Deformation	Check visually, and measure 	<ul style="list-style-type: none"> <li>- Significantly deformed pin should be discarded.</li> <li>- Should be free of scars or deformation on the thread.</li> </ul> <table border="1"> <thead> <tr> <th rowspan="2">Capacity (tonnes)</th> <th colspan="2">d dimension (mm)</th> </tr> <tr> <th>Standard</th> <th>Discard</th> </tr> </thead> <tbody> <tr> <td>0.8, 1</td> <td>6.8</td> <td>6.5</td> </tr> <tr> <td>1.6</td> <td>8.7</td> <td>8.3</td> </tr> <tr> <td>2.5</td> <td>10.8</td> <td>10.3</td> </tr> <tr> <td>3.2, 6.3, 9</td> <td>12.1</td> <td>11.5</td> </tr> </tbody> </table>	Capacity (tonnes)	d dimension (mm)		Standard	Discard	0.8, 1	6.8	6.5	1.6	8.7	8.3	2.5	10.8	10.3	3.2, 6.3, 9	12.1	11.5	Replace
Capacity (tonnes)				d dimension (mm)																
	Standard	Discard																		
0.8, 1	6.8	6.5																		
1.6	8.7	8.3																		
2.5	10.8	10.3																		
3.2, 6.3, 9	12.1	11.5																		
Chain Pin – Wear			Replace																	
Chain Pin – Rust	Check visually.	Should be free of significant rust.	Replace																	

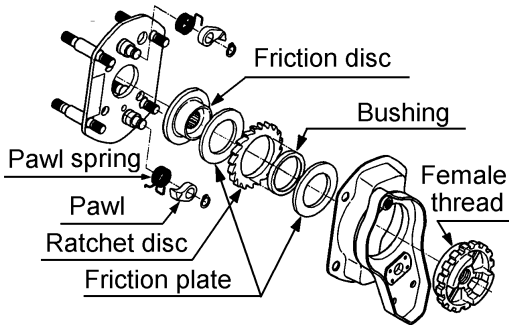
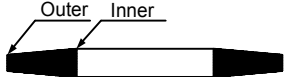

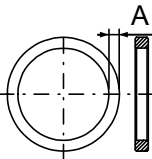
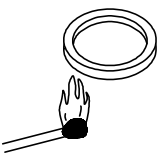
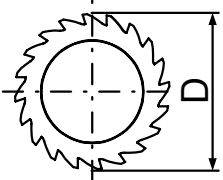
Yoke – Hole Deformation	Measure Check the diameters of the top pin and chain pin hole. 	Replace the hook set.																																						
	<table border="1"> <thead> <tr> <th rowspan="3">Capacity (tonnes)</th> <th colspan="4">Diameter (mm) for</th> </tr> <tr> <th colspan="2">Chain pin</th> <th colspan="2">Top pin</th> </tr> <tr> <th>Standard</th> <th>Discard</th> <th>Standard</th> <th>Discard</th> </tr> </thead> <tbody> <tr> <td>0.8, 1</td> <td>7.1</td> <td>7.6</td> <td>12.2</td> <td>12.7</td> </tr> <tr> <td>1.6</td> <td>8.9</td> <td>9.4</td> <td>12.2</td> <td>12.7</td> </tr> <tr> <td>2.5</td> <td>11.0</td> <td>11.5</td> <td>14.2</td> <td>14.7</td> </tr> <tr> <td>3.2</td> <td>12.3</td> <td>12.8</td> <td>16.2</td> <td>16.7</td> </tr> <tr> <td>6.3, 9</td> <td>12.3</td> <td>12.8</td> <td>16.4</td> <td>16.9</td> </tr> </tbody> </table>	Capacity (tonnes)	Diameter (mm) for				Chain pin		Top pin		Standard	Discard	Standard	Discard	0.8, 1	7.1	7.6	12.2	12.7	1.6	8.9	9.4	12.2	12.7	2.5	11.0	11.5	14.2	14.7	3.2	12.3	12.8	16.2	16.7	6.3, 9	12.3	12.8	16.4	16.9	
Capacity (tonnes)	Diameter (mm) for																																							
	Chain pin		Top pin																																					
	Standard	Discard	Standard	Discard																																				
0.8, 1	7.1	7.6	12.2	12.7																																				
1.6	8.9	9.4	12.2	12.7																																				
2.5	11.0	11.5	14.2	14.7																																				
3.2	12.3	12.8	16.2	16.7																																				
6.3, 9	12.3	12.8	16.4	16.9																																				

Braking System – Components	 <p>Friction plates are made of asbestos free material.</p>										
Braking System – Friction Surface	Check visually.	The surfaces of the friction disc, friction plate, ratchet disc and female thread should be free of scars, gouges or wear.	Replace								
Braking System – Friction Plate	Measure 	<ul style="list-style-type: none"> <li>- Should have uniform thickness. The plate with thinner outer than the inner should be discarded.</li> <li>- Should be free of scars or cracks.</li> </ul> <table border="1"> <thead> <tr> <th rowspan="2">Capacity (tonnes)</th> <th colspan="2">Thickness of Friction Plate (mm)</th> </tr> <tr> <th>Standard</th> <th>Discard</th> </tr> </thead> <tbody> <tr> <td>All</td> <td>3.5</td> <td>3.0</td> </tr> </tbody> </table>	Capacity (tonnes)	Thickness of Friction Plate (mm)		Standard	Discard	All	3.5	3.0	Replace
Capacity (tonnes)	Thickness of Friction Plate (mm)										
	Standard	Discard									
All	3.5	3.0									

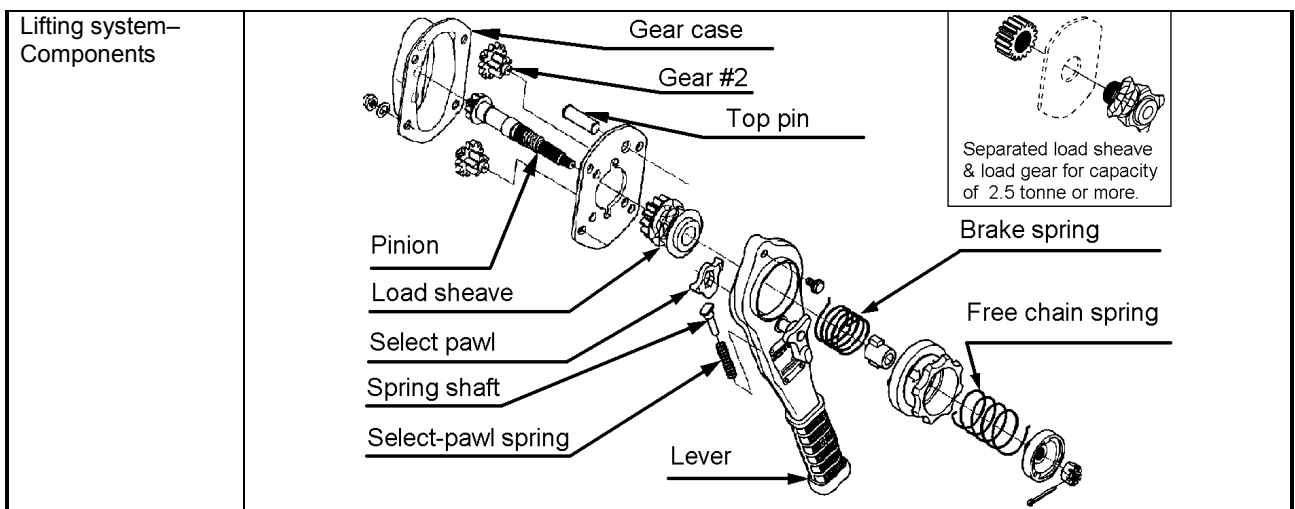
Item	Method	Criteria	Action													
Braking System – Bushing Wear	Measure 	Should have uniform thickness of A dimension. <table border="1" data-bbox="774 347 1141 459"> <thead> <tr> <th rowspan="2">Capacity (tonnes)</th> <th colspan="2">A dimension (mm)</th> </tr> <tr> <th>Standard</th> <th>Discard</th> </tr> </thead> <tbody> <tr> <td>All</td> <td>4.0</td> <td>3.0</td> </tr> </tbody> </table>	Capacity (tonnes)	A dimension (mm)		Standard	Discard	All	4.0	3.0	Replace					
Capacity (tonnes)	A dimension (mm)															
	Standard	Discard														
All	4.0	3.0														
Braking System – Bushing Lubrication	Check visually. Heat with a match flame in a short time. 	Should be so lubricated that lubricant oozes off the surface. <b>⚠ WARNING</b> -Even for repair or assembly, soak the bushing in turbine oil for a day before reuse. -Pay attention to heat of fire around	Soak the bushing in turbine oil for a day.													
Braking System – Ratchet Disc	Measure 	<table border="1" data-bbox="758 772 1157 996"> <thead> <tr> <th rowspan="2">Capacity (tonnes)</th> <th colspan="2">D dimension (mm)</th> </tr> <tr> <th>Standard</th> <th>Discard</th> </tr> </thead> <tbody> <tr> <td>0.8, 1</td> <td rowspan="2">64</td> <td rowspan="2">61</td> </tr> <tr> <td>1.6</td> </tr> <tr> <td>2.5</td> <td rowspan="2">74</td> <td rowspan="2">71</td> </tr> <tr> <td>3.2, 6.3, 9</td> </tr> </tbody> </table>	Capacity (tonnes)	D dimension (mm)		Standard	Discard	0.8, 1	64	61	1.6	2.5	74	71	3.2, 6.3, 9	Replace
Capacity (tonnes)	D dimension (mm)															
	Standard	Discard														
0.8, 1	64	61														
1.6																
2.5	74	71														
3.2, 6.3, 9																
Braking System – Pawl	Check visually. 	As shown in the left picture, the side of the pawl should not be worn.	Replace													
Braking System – Pawl Spring	Check visually. 	Should not be deformed or scarred.	Replace													
Braking System – Female thread	Check visually.	The cogs should be free of significant deformations.	Replace													
Braking System – Rust	Check visually.	All parts should be free of rust.	Replace													

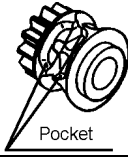
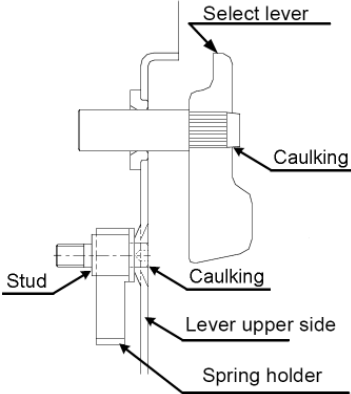
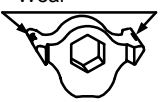
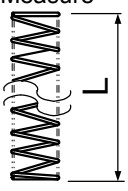
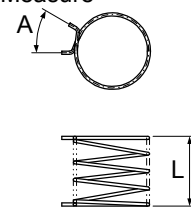
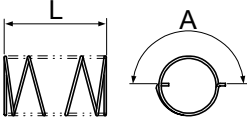

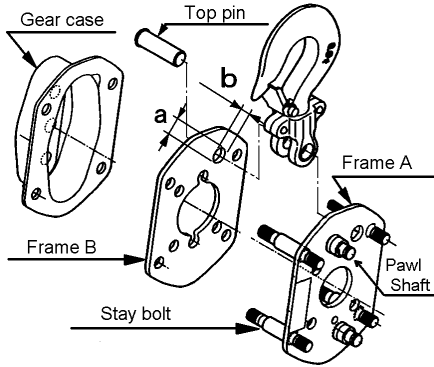
Item	Method	Criteria	Action																					
Lifting system – Load Sheave	Check visually. 	Should be free of wear in the pockets or scars on the rising parts.	Replace																					
Lifting system – Cogs	Check visually.	Should not be chipped, unevenly worn or scarred.	Replace																					
Lifting system – Pinion	Check visually.	A deformed pinion should be discarded.	Replace																					
Lifting system – Lever	Check visually. 	Should be free of bends or cracks of whole lever and loose swaging of select lever and stud.	Replace																					
Lifting system – Select Pawl	Check visually. 	As shown in the left picture, the sides of the pawl should not be worn.	Replace																					
Lifting system – Spring Shaft	Check visually.	Should be free of deformation (such as bend).	Replace																					
Lifting system – Select-pawl Spring	Measure 	<table border="1"> <thead> <tr> <th>Capacity (tonnes)</th> <th>L dimension (mm) Minimum</th> </tr> </thead> <tbody> <tr> <td>0.8, 1</td> <td rowspan="3">37</td> </tr> <tr> <td>1.6</td> </tr> <tr> <td>2.5</td> </tr> <tr> <td>3.2, 6.3, 9</td> <td>42</td> </tr> </tbody> </table>	Capacity (tonnes)	L dimension (mm) Minimum	0.8, 1	37	1.6	2.5	3.2, 6.3, 9	42	Replace													
Capacity (tonnes)	L dimension (mm) Minimum																							
0.8, 1	37																							
1.6																								
2.5																								
3.2, 6.3, 9	42																							
Lifting system – Brake Spring	Measure 	<table border="1"> <thead> <tr> <th rowspan="2">Capacity (tonnes)</th> <th rowspan="2">L dimension (mm) Minimum</th> <th colspan="2">A angle (°: degree)</th> </tr> <tr> <th>Standard</th> <th>Discard</th> </tr> </thead> <tbody> <tr> <td>0.8, 1</td> <td rowspan="3">30</td> <td>30</td> <td>45</td> </tr> <tr> <td>1.6</td> </tr> <tr> <td>2.5</td> </tr> <tr> <td>3.2, 6.3, 9</td> <td>30</td> <td>25</td> <td>40</td> </tr> </tbody> </table>	Capacity (tonnes)	L dimension (mm) Minimum	A angle (°: degree)		Standard	Discard	0.8, 1	30	30	45	1.6	2.5	3.2, 6.3, 9	30	25	40	Replace					
Capacity (tonnes)	L dimension (mm) Minimum	A angle (°: degree)																						
		Standard	Discard																					
0.8, 1	30	30	45																					
1.6																								
2.5																								
3.2, 6.3, 9	30	25	40																					
Lifting system – Free Chain Spring	Measure 	<table border="1"> <thead> <tr> <th rowspan="2">Capacity (tonnes)</th> <th colspan="2">L dimension (mm)</th> <th colspan="2">A angle (°: degree)</th> </tr> <tr> <th>Standard</th> <th>Discard</th> <th>Standard</th> <th>Discard</th> </tr> </thead> <tbody> <tr> <td>0.8, 1</td> <td rowspan="3">66</td> <td rowspan="3">59</td> <td>180</td> <td>165</td> </tr> <tr> <td>1.6</td> </tr> <tr> <td>2.5</td> </tr> <tr> <td>3.2, 6.3, 9</td> <td>71</td> <td>64</td> <td>180</td> <td>165</td> </tr> </tbody> </table>	Capacity (tonnes)	L dimension (mm)		A angle (°: degree)		Standard	Discard	Standard	Discard	0.8, 1	66	59	180	165	1.6	2.5	3.2, 6.3, 9	71	64	180	165	Replace
Capacity (tonnes)	L dimension (mm)			A angle (°: degree)																				
	Standard	Discard	Standard	Discard																				
0.8, 1	66	59	180	165																				
1.6																								
2.5																								
3.2, 6.3, 9	71	64	180	165																				

Item	Method	Criteria	Action															
Body – Components																		
Body – Frame A, B Stay Bolts Top Pin Hole Pawl Shafts	Check visually.	<ul style="list-style-type: none"> <li>- Should be free of major deformation or significant scars.</li> <li>- Should be free of loose swaging.</li> <li>- Should be free of cracks on the welding parts.</li> <li>- The maximum difference between a and b in the picture on previous page should be 0.5 mm.</li> <li>- The bearing holes should not be deformed.</li> </ul>	Replace															
Body – Gear Case	Check visually.	<ul style="list-style-type: none"> <li>- Should be free of major deformation or significant scars.</li> <li>- The bearing holes for the gear #2 and the pinion should not be deformed.</li> </ul>	Replace															
Body – Top Pin	Measure 	Should be free of significant deformation. <table border="1" data-bbox="772 1144 1150 1350"> <thead> <tr> <th rowspan="2">Capacity (tonnes)</th> <th colspan="2">d dimension (mm)</th> </tr> <tr> <th>Standard</th> <th>Discard</th> </tr> </thead> <tbody> <tr> <td>0.8, 1</td> <td rowspan="2">12</td> <td rowspan="2">11.4</td> </tr> <tr> <td>1.6</td> </tr> <tr> <td>2.5</td> <td>14</td> <td>13.3</td> </tr> <tr> <td>3.2, 6.3, 9</td> <td>16</td> <td>15.2</td> </tr> </tbody> </table>	Capacity (tonnes)	d dimension (mm)		Standard	Discard	0.8, 1	12	11.4	1.6	2.5	14	13.3	3.2, 6.3, 9	16	15.2	Replace
Capacity (tonnes)	d dimension (mm)																	
	Standard	Discard																
0.8, 1	12	11.4																
1.6																		
2.5	14	13.3																
3.2, 6.3, 9	16	15.2																

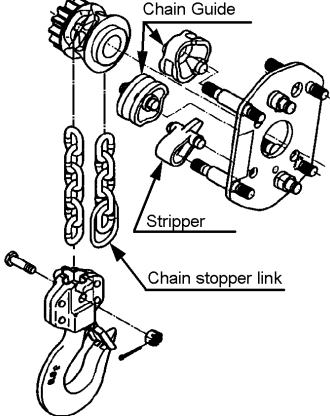
Others – Components			
Others – Stripper	Check visually.	Should be free of cracks or deformation on the tip.	Replace
Others – Chain Stopper Link	Check visually.	Should not be open or significantly deformed.	Replace
Others – Chain Guide	Check visually.	Should be free of damage or significant deformation.	Replace

Item	Method	Criteria	Action
Preoperational Checks	Before reuse, reassemble properly the hoist in accordance with section 6 Maintenance in this manual and perform the following the checks.		
Checks under No Load – Lifting	Check function, and check auditorily. Set the select lever to 'UP' and make lifting operation with the load-side chain pulled slightly.	<ul style="list-style-type: none"> <li>- The lever should be operated smoothly.</li> <li>- Moving the lever forward and backward should make clicking sounds.</li> </ul>	Repair or replace as necessary.
Checks under No Load – Lowering	Check function, and check auditorily. Set the select lever to 'DN' and make lowering operation with the load-side chain pulled slightly.	<ul style="list-style-type: none"> <li>- The lever should be operated smoothly.</li> <li>- Moving the lever only backward, not forward, should make clicking sounds.</li> </ul>	Repair or replace as necessary.
Checks under No Load – Free Chaining	Check function. Set the select lever to 'N' and pull the free chain knob upward into free chaining mode to adjust the chain length.	<ul style="list-style-type: none"> <li>- The chain should be pulled smoothly.</li> <li>- The free chain knob should be easily pulled or reset.</li> </ul>	Repair or replace as necessary.
Checks under the rated load	Check function. Lift and lower the rated load from 20 to 30 cm. Check the functions in accordance with "Function - ....." of 5.3 Frequent Inspection.	See "Function - ....." of 5.3 Frequent Inspection.	See "Function - ....." of 5.3 Frequent Inspection.

## 6. Maintenance and storage

### 6.1. General

Improper maintenance may result in death or serious injury. Have only a trained or competent person maintain the hoist, or contact your dealer.

#### CAUTION

- Do not drag or throw the hoist when carrying.
- Do not use the hoist which is under maintenance.
- Remove any dirt or water of the hoist.
- Perform all inspections given in **5 Inspection** if irregularity of the hoist is found after operation.
- Always ensure that lubricant is applied to the load chain, the chain pin, the top pin, the hook necks, the hook latches. Refer to **2.1.1 Schematics**.
- Load chain – The load chain is one of critical parts of the hoist. Ensure to lubricate the load chain well with machine oil equivalent to ISO VG46.
- Others - Lubricate the contacting parts as instructed in the following sections.

#### Storage

- When not in use, ensure that it does not encumber other works.
- Before storing the hoist, rotate the lever counterclockwise several times to lower the hook and ensure that the brake is released.
- Store the hoist in a dry and clean area.
- Do not store the hoist under a load.
- When installing outdoors, cover the hoist to avoid exposure to rain or store in a place with covering against rain. When transferring, including handling, and storing the product, carry it out carefully making sure of the product's weight and size.

### 6.2. Disassembly, Assembly and Adjustment

#### WARNING

- Perform proper disassembly or assembly in accordance with this manual.
- The friction plates are dry ones. Do not lubricate them.
- Do not extend the load chain.
- Remove old grease of the disassembled parts.
- Replace components with new ones authorized by KITO.
- To reassemble, apply new grease, and use new split pins and snap rings.

Note: The following symbols in this manual indicate the recommended lubricants.

G1: JIS K2220 general class 1, No.2 grease (EPNOC GREASE AP(N)2, JX Nippon Oil & Energy)

G2: JIS K2246 general class 2, No. 1 rust preventive oil (Antirust P-210, JX Nippon Oil & Energy)

G3: Moly Speed Grease No. 2 (SUMICO LUBRICANT)

### 6.3. Tools

To disassemble or reassemble the hoist, prepare for the following tools:

**Table 5-1 Tools**

#	Tools	For
1	Snap ring pliers	Opening a snap ring
2	Socket wrenches 12, 14 mm	Slotted nuts
3	Hex keys 4, 5, 10, 12 mm	Socket head cap screws
4	Wrenches 10, 12, 13, 14, 17 mm	Bolts and nuts
5	Philips screwdriver	Machine screws
6	Pliers	Split pins
7	Soft-face (plastic) hammer	



## 6.4. Components

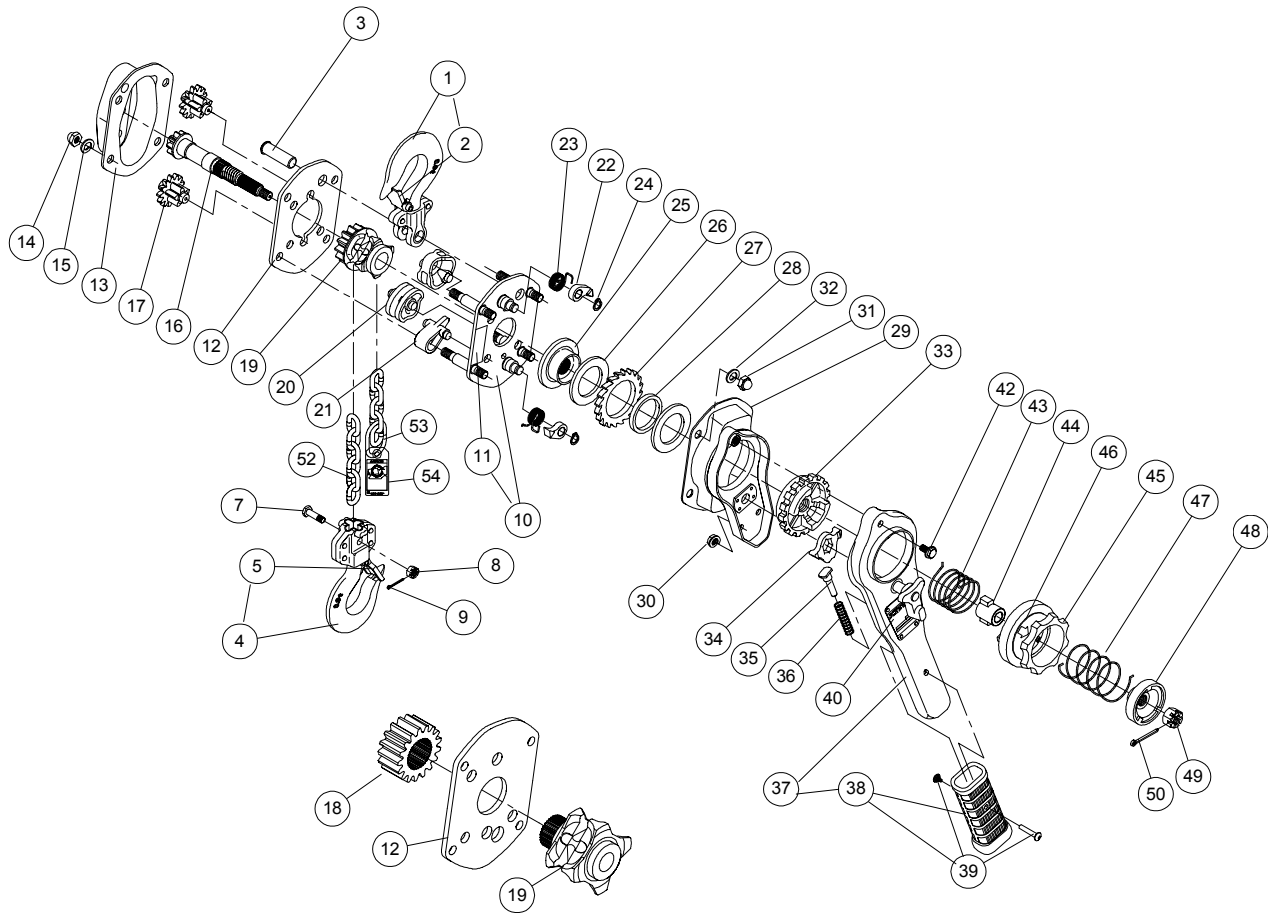

Exclusive for 2.5 & 3.2 tonnes

Fig. #	Part #	Part Name	Fig. #	Part #	Part Name	Fig. #	Part #	Part Name	
1	1001	Top Hook Set	19	116	Load Sheave	36	223	Select-pawl Spring	
	2	Latch Assembly	20	161	Chain Guide	37	5211	Lever Assembly	
3	163	Top Pin	21	162	Stripper		38	1231	Grip
4	1021	Bottom Hook Set	22	155	Pawl		39	232	Binding Screws
	5	Latch Assembly	23	158	Pawl Spring	40	800	Nameplate	
7	41	Chain Pin	24	188	Snap Ring	42	221	Hex Cap Screw	
8	49	Slotted Nut	25	153	Friction Disc	43	207	Brake Spring	
9	96	Split Pin	26	151	Friction Plate	44	203	Cam Guide	
10	5101	Frame A Assembly	27	152	Ratchet Disc	45	201	Free Chain Knob	
	11	Nameplate F	28	154	Bushing	46	810	Nameplate U	
12	102	Frame B	29	5214	Brake Cover Assembly	47	205	Free Chain Spring	
13	5103	Gear Case Assembly	30	281	Flange Nut	48	208	Spring Holder	
14	181	Domed Cap Nut	31	184	Domed Cap Nut	49	183	Slotted Nut	
15	182	Spring Lock Washer	32	185	Spring Lock Washer	50	187	Split Pin	
16	111	Pinion	33	160	Female Thread	52	841	Nickel-plated Load Chain	
17	112	Gear #2	34	218	Select Pawl	53	45	Chain Stopper Link	
18	114	Load Gear	35	222	Spring Shaft	54	931	Warning Tag CE	

## 6.5. Disassembly

Proceed as follows:

### 6.5.1. Free Chain Knob

- Pull out (50) Split pin and remove (49) Slotted nut.
- Remove (48) Spring holder, (47) Free chain spring, (45) Free chain knob assembly, (43) Brake spring and (44) Cam guide from (16) Pinion.

### 6.5.2. Lever

- Remove (31) Domed cap nut and (32) Spring lock washer which fix (29) Brake cover assembly to (10) Frame A assembly, and then remove (29) Brake cover assembly.
- While holding (37) Lever assembly horizontally by hand, turn (33) Female thread counterclockwise and remove the lever assembly from the hoist.
- Remove (42) Hex cap screw and (30) Flange nut, and separate (37) Lever assembly and (29) Brake cover assembly.
- Remove (33) Female thread from (29) Brake cover assembly.
- Remove (34) Select pawl, (35) Spring shaft and (36) Select-pawl spring from (37) Lever assembly.

### 6.5.3. Brake

- Remove the parts from (16) Pinion in the following order, (26) Friction plate (one piece), (27) Ratchet disc, (28) Bushing, (26) Friction plate (one piece) and (25) Friction disc.
- Remove (24) Snap ring from the pawl shaft with snap ring pliers, and remove (22) Pawl and (23) Pawl spring.

### 6.5.4. Gears

- Remove (14) Domed cap nut and (15) Spring lock washer, and detach (13) Gear case assembly.
- Remove (17) Gear #2, (16) Pinion, (18) Load gear.  
Note: For capacity 1.6 tonnes or less, the load gear and (19) Load sheave are as one, and the load gear will not be detached.
- Pull out (3) Top pin and remove (1) Top hook set.

### 6.5.5. Load Chain

- Remove (12) Frame B, (20) Chain guide and (21) Stripper.
- Remove (52) Load chain from (19) Load sheave.
- Remove (9) Split pin, (8) Slotted nut and (7) Chain pin from yoke part of (4) Bottom hook set, and remove (52) Load chain.
- Remove (19) Load sheave.

## 6.6. Assembly

### WARNING

- Do not reconnect components beyond the stated criteria as a result of inspection.
- Ensure to secure the nuts and bolts firmly.
- Ensure to secure also the split pins.

Proceed as follows:

### 6.6.1. Lever

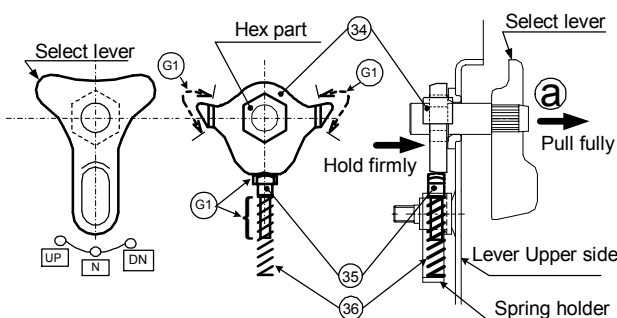

- Set the select lever on the lever upper side to 'N' position.
- With the select lever pulled in the 'a' direction, as shown in the left picture, insert the hex part of the select lever into (34) Select pawl.
- Apply (G1) grease lightly to the pawl of (34) Select pawl.
- Apply (G1) grease lightly to the part of (35) Spring shaft as shown in the above picture.
- Insert (35) Spring shaft into (36) Select-pawl spring and attach them into the spring holder.

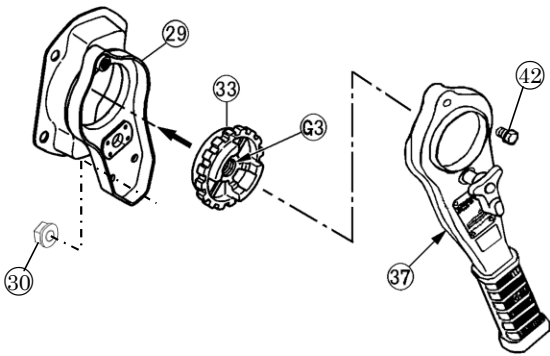

**! WARNING**

Do not apply oil to the friction side of the female thread.

**! CAUTION**

Ensure to clean the friction side of the female thread.

- Apply (G3) grease lightly to the thread of (33) Female thread.
- Attach the friction side of (33) Female thread to (29) Brake cover assembly and set (37) Lever assembly on them.
- Secure it with (42) Hex cap screw and (30) Flange nut.

### 6.6.2. Lever Grip

**! CAUTION**

New glue accompanies the lever grip when it is ordered for repair. Read and comply with its instruction manual and remove dirt such as water, oil and rust from the part glue-applied on the lever.

#### Applying glue

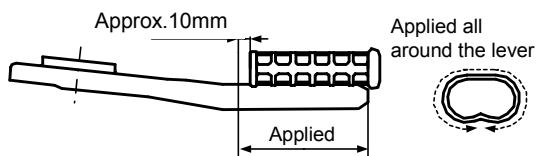

- Make a quick and even application of the glue on the all around the lever assembly as shown in the above picture.
- As instructed below, attach (38) Grip to the lever within 10 seconds after applying the glue. (Note: It will be difficult to attach if the glue dries or hardens.)

#### Fitting

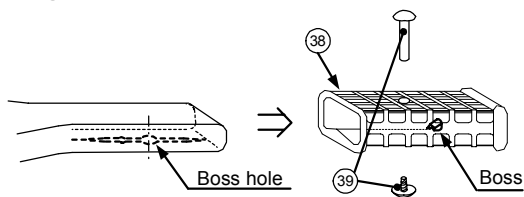

- Place (38) Grip with its inside boss (rising part) downward.
- Insert the boss of (38) Grip until it completely fits into the boss hole of the lever.
- Tighten the binding screws firmly.

### 6.6.3. Load Sheave & Chain

- Attach (4) Bottom hook set to (52) Load chain with (8) Slotted nut and (7) Split pin.

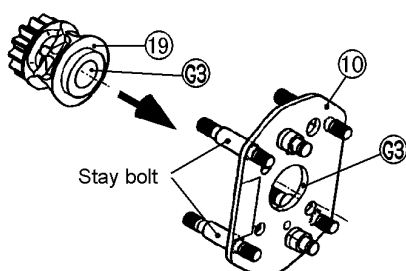

**! CAUTION**

Use a new split pin.

- Apply (G3) grease to the inner parts of the bearing hole of (10) Frame A Assembly and (19) Load sheave as shown in the left picture.
- Attach (19) Load sheave to (10) Frame A Assembly at the stay-bolt longer side of the frame. Note: Face the side of the load sheave where it has no gear or serration.

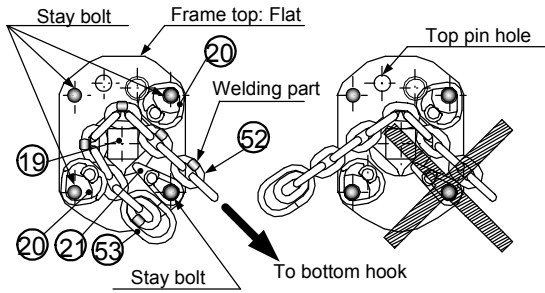

- Set (52) Load chain to (19) Load sheave as shown in the left picture, and attach (20) Chain guide and (21) stripper.

**CAUTION**

- Keep (53) Chain stopper link in parallel with the frame and set (52) Load chain with its welding part directed outward.
- Reeve (52) Load chain through (19) Load sheave and (20) Chain guide.

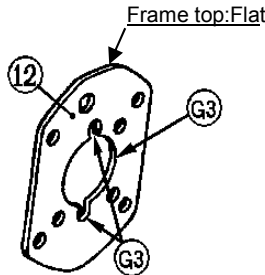

- Apply (G3) grease to the bearing part of (12) Frame B.
- Make sure of proper fitting before attaching (12) Frame B to the stay bolts.

**CAUTION**

Make sure to set the flat parts of (10) Frame A Assembly and (12) Frame B in the same position with the holes for the top pin arranged.

6.6.4. Chain stopper link

- If the no-load side of the load chain is disengaged from the load sheave by free chaining and excessive rewinding, you are exposed to an extremely dangerous state. To avoid this, attach a (53) chain stopper link.

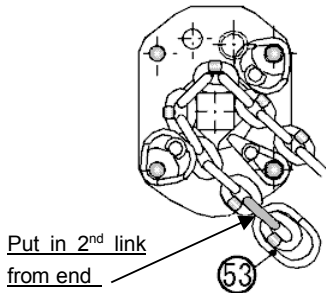

**DANGER**

- When attaching the (53) chain stopper link afresh, be sure to use new one and attach it to the second link of the load chain from the no-load side. If attached to the end link, it may be deformed or fractured, failing to prevent disengagement of the load chain.

- The gaps when the link is closed shall be as per table.

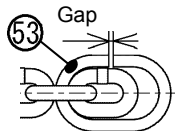

Product Code	LB008	LB016, LB025, LB032 LB063, LB090
Gap (mm)	1 ± 1	2 ± 1

6.6.5. Top Hook

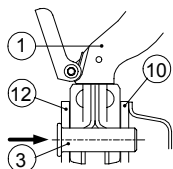

- Fit (1) Top hook set between (10) Frame A assembly and (12) Frame B.
- Insert (3) Top pin from the side of (12) Frame B to fasten (1) Top hook set.

### 6.6.6. Gears

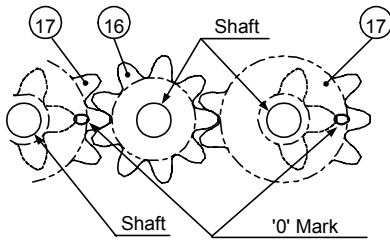

- For capacity of 2.5 tonnes or more, attach (18) Load gear to the serration part of (19) Load sheave.  
Note: Make sure that the load sheave is inserted to the load gear completely. If necessary, use a plastic hammer.
- Insert (16) Pinion into (19) Load sheave and arrange the pinion with (17) Gear #2 as shown in the left picture.

**! CAUTION** If 'O' mark alignment on two of the gear #2 do not match to the above picture, the gears will not rotate.

- Apply (G1) grease to gear cogs and shafts of e.g. (16) Pinion, (17) Gear #2 and (18) Load gear.

**! CAUTION** Apply grease good enough to the cogs. (approx. 20 g for 0.8 & 1 t, 30 g for 1.6 & 2.5 t, 60 g for 3.2 t or more)

- Set (13) Gear case assembly over the gears and fix it firmly to the stay bolts with (14) Domed cap nut and (15) Spring lock washer.

**! CAUTION** Fit the rims of (12) Gear frame B and (13) Gear case in right direction.

### 6.6.7. Brake

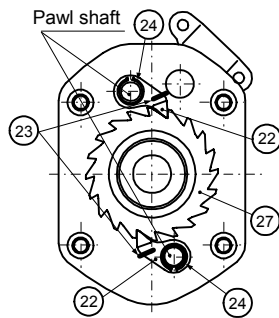

- Apply (G2) grease to the pawl shaft and (22) Pawl.

**! CAUTION** For (22) Pawl, just coat it with the grease, not too much.

- Fasten two sets of (23) Pawl spring and (22) Pawl with (24) Snap ring.
- While holding two pawls outward, set (25) Friction disc, (26) Friction plate, (28) Bushing, (27) Ratchet disc and (26) Friction plate properly in this order.

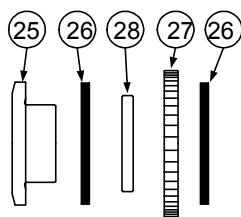

**! CAUTION**

- Make sure that the pawl spring fits into the pawl.
- Make sure that the pawl comes into good contact with the ratchet disc.
- The friction plates are dry ones. Do not apply oil to them.
- Make sure that (28) Bushing has sufficient oil. If the bushing oil is not enough, soak the bushing in turbine oil for a day and wipe extra oil for reuse.

### 6.6.8. Lever & Body

- Attach the lever assembled in 6.6.1 to the previously-assembled bake.

**CAUTION** Fit the rims of (10) Frame A assembly and (29) Brake cover assembly in right direction.

- Fit (29) Brake cover assembly and (10) Frame A assembly by screwing (33) Female thread of the lever assembly clockwise to the thread of (16) pinion until making clicking sounds.
- Fasten (29) Brake cover assembly firmly to the stay bolts with (14) Domed cap nut and (15) Spring lock washer.

**CAUTION** To eliminate a clearance in the brake section, perform the following procedures before moving to the next step.

- (1) Set the select lever to 'N' position.
  - (2) Turn (33) Female thread clockwise to tighten the brake lightly with (52) Load chain at the hook side held by hand firmly without (19) Load sheave's rotation.  
Insufficient hold of the chain makes clicking sounds. Even in this case, the clearance is eliminated. After tightening, make sure that the female thread will not rotate counterclockwise
- To attach (44) Cam guide to (16) Pinion, set a jog of the guide to right a bit from the middle of (33) Female thread's jog as shown in the following picture.
  - Apply (G3) grease lightly to the side of (44) Cam guide.

**CAUTION**

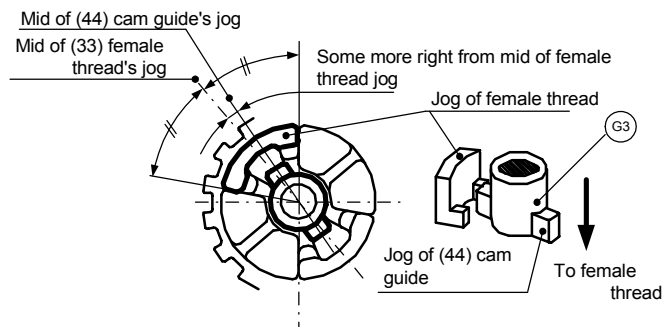

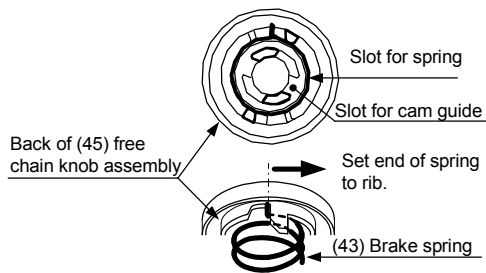

- Set (43) Brake spring (silver color) into the slot of the back of (45) Free chain knob assembly.  
Note: As indicated in the left picture, set the end of the spring to the rib of the knob.

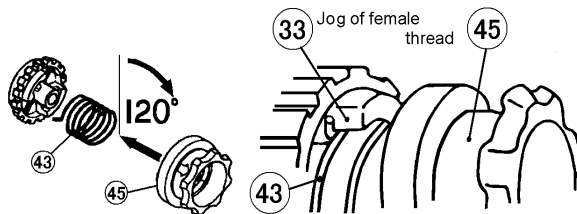

- Fit the other end of (43) Brake spring to the jog of the female thread.
- Hold the load chain in the hook side firmly to prevent (19) Load sheave from rotating.
- Turn (45) Free chain knob assembly 120° **clockwise** while pressing it lightly on (33) Female thread.

Note: As the free chain knob turns, the cam parts of (44) Cam guide fit into the slots of the knob to set the knob down.

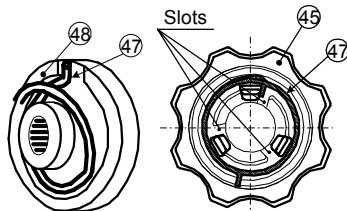

- With (45) Free chain knob assembly pressed, hook the outward-projecting end of (47) Free chain spring onto the slot at the back of (48) Spring holder, and hook the other end (inward-projecting) of the spring onto the slot of (45) Free chain knob assembly.

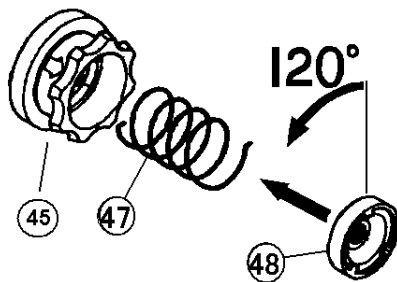

- Turn (48) Spring holder 120° **counterclockwise** while pressing it lightly toward (45) Free chain knob assembly to insert it along the pinion serration.  
Note: (47) Free chain spring raises (48) Spring holder. Hold and do not loosen it.
- With (48) Spring holder held, fasten it with (49) Slotted nut and (50) Split pin.
- Set the select lever to 'N' position and pull the free chain knob into the free chaining mode. Ensure to perform the free chaining operation.

### **! CAUTION**

If the free chaining can not be performed, the hoist has been misassembled. Ensure to reassemble in accordance with this instruction.

## 6.7. Preoperational Checks



### **! CAUTION**

After assembly, ensure to perform the preoperational checks with the following points before reuse.

- Check defects in appearance, any parts left to be assembled.
- Perform lifting and lowering operation and check the following items.
  - Should be free of irregular clicking sounds in lifting or abnormal sounds
  - Should be free of heavier pull to lift
  - Should be free of brake slipping
- Ensure that the hoist operate properly under no load before checking the hoist under a load.

## 7. Troubleshooting

### **! WARNING**

- If a defect is found in the hoist, stop using it immediately and check the cause of the defect.
- Read and comply with instructions in this manual and use the hoist properly.
- Ensure that competent people conduct repairs, otherwise please confirm with your dealer.
- Replace components with new ones authorized by KITO.

Symptom	Cause	Remedy
---------	-------	--------

For lifting

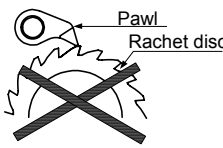
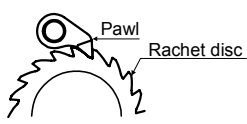
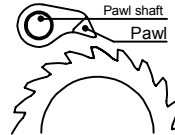
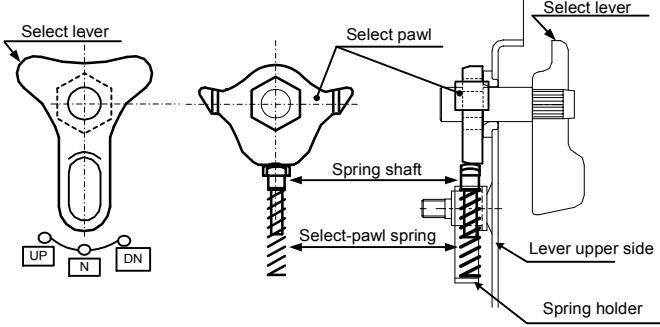
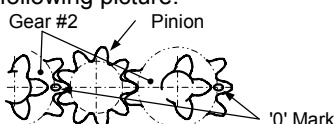
<p><b>! CAUTION</b></p> 	<p>Checking sounds from the hoist is a critical inspection. So, note the sounds of the hoist in operation.</p> <ul style="list-style-type: none"> <li>-For lifting, moving the lever forward and backward should make clicking sounds.</li> <li>-For lowering, moving the lever only backward, not forward, should make clicking sounds.</li> </ul>	
<p>Hoist will not lift -Slight clicking</p>	<p>Improper assembly of ratchet disc, i.e. incorrect contact with the pawl caused by its wrong side fitting.</p> 	<p>Reassemble the pawl and ratchet disc properly and ensure to check click sounds before reuse.</p> 
<p>Hoist will not lift -Not clicking</p>	<p>Faulty pawl contact</p> <ul style="list-style-type: none"> <li>-The pawl or pawl shaft stuck with dust or oil caused by long-term negligent maintenance may make poor contact for the pawl and ratchet disc.</li> <li>-Faulty pawl spring may cause this symptom.</li> </ul>	<p>Perform periodic overhauls. Faulty contact:</p> 
	<p>Improper select-lever fitting</p> <ul style="list-style-type: none"> <li>-Missing select-pawl spring</li> <li>-Assembly in wrong direction</li> <li>-Clogged with rust</li> </ul> 	<p>Reassemble it properly and ensure to check click sound of the select lever before reuse.</p>
<p>Hoist will not lift -Impossible lever operation</p>	<p>Loose select-pawl spring</p> <p>Improper assembly of gear #2</p> <ul style="list-style-type: none"> <li>-Mis-located '0' mark</li> </ul>	<p>Perform periodic overhauls.</p> <p>Reassemble it properly and ensure to check smooth operation before reuse.</p> <p><b>! CAUTION</b> Ensure to set the '0' marks of the gear #2 as shown in the following picture.</p> 

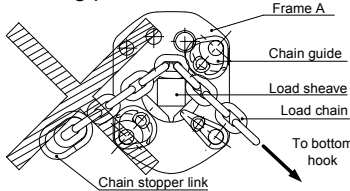
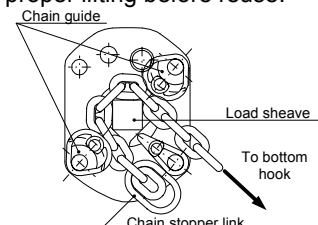
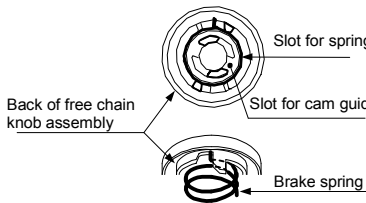
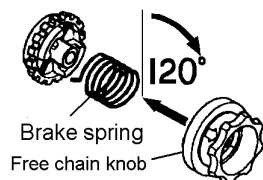
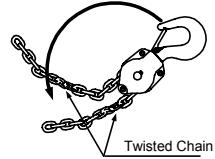

Symptom	Cause	Remedy
Hoist will lift intermittently	Poor pawl movement caused by faulty pawl spring. -The spring is loose or damaged.	Perform periodic overhauls.
-Slight or irregular clicking	Mis-assembly of pawl spring.	Reassemble it properly and ensure to check click sound of the pawl before reuse.
During operation, hoist idles or load drifts	Poor contact of load sheave and load chain caused by improper chain-reeving such as the following picture. 	Reassemble it properly and ensure to check proper lifting before reuse. 
Hoist will not lift under no load	Mis-assembly of brake spring -Insufficient angle to set the spring will cause a poor braking. 	Reassemble it properly. <b>CAUTION</b> Turn the free chain knob 120° clockwise and set the brake spring. 
Hoist will not lift all over the way	Capsized hook	Reset the capsized hook. Check the chain for any damage. 
		Capsized Hook and Chain Double Fall Models

### For lowering

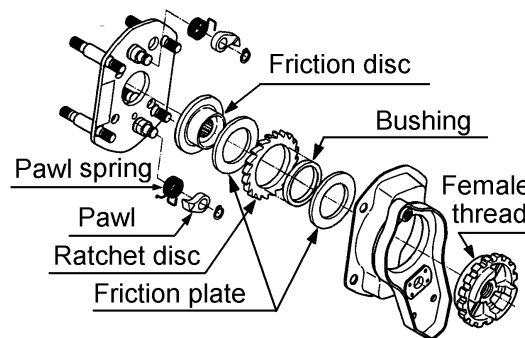
<p><b>CAUTION</b></p> <p>-Faulty braking may cause improper lowering. -The friction method is a dry one. Do not apply oil to friction surfaces.</p> 		
Load will not go down	Excessively tightened brake -The hoist under a load left for a long period. -A shock during operation. -Brake tightened by rust.	Set the select lever to 'DN' position and reset the brake by lowering with larger pull.  Replace the rusty components and Perform periodic overhauls.
Load drops when lowering starts.	A foreign object between friction surfaces.  Brake slip caused by significant rust.	Remove the object and clean the surfaces. Replace if the surface is scarred.  Replace the rusty component and perform periodic overhauls.

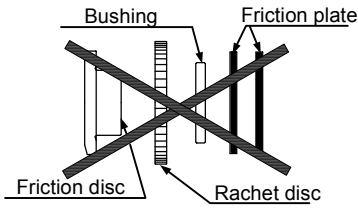
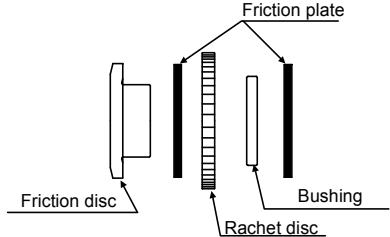
Symptom	Cause	Remedy
Load drops when lowering starts.	Mis-assembly of friction plates, i.e. friction plates at one side as shown in the following picture or one lost. 	Reassemble it properly as shown in the following picture and ensure to check hoist functions before reuse. 
	Cracked friction plate caused by overload.	Replace the friction plate and use the hoist properly within rated capacity.
Load drifts.	A foreign object between friction surfaces.	Remove the object and clean the surfaces. Replace if the surface is scarred.
	Friction plate wear -Caused by high frequent and long term use.	Perform periodic overhauls.
Load drifts.	Mis-assembly of female thread and cam guide -Attaching cam guide without tightening female thread may cause an un-tightened brake.	Reassemble it properly. <b>CAUTION</b> Secure the female thread firmly before attaching cam guide.

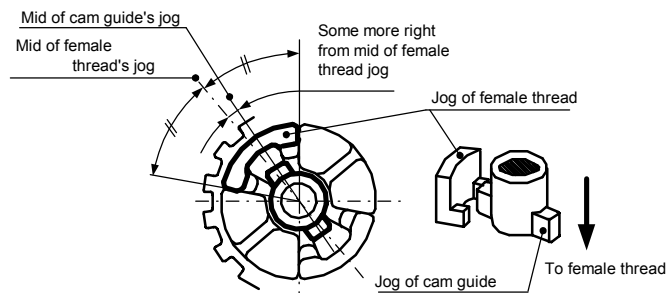

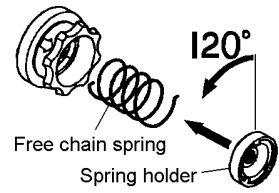

**For free chaining**

Free chain knob does not rise.	Damaged or deformed friction plate.	Perform periodic overhauls.
Load chain is not pulled in free chain mode. Note: Not defect	Load chain pulled with free chain knob held.	Pull the load chain without holding the free chain knob.
	Load chain pulled with excessive force (brake excessively tightened).	Pull the load chain with smaller force. <b>CAUTION</b> This prevents the load from dropping even with unintentional operation to free chain mode.
	Mis-assembly of free chain spring -Twisted with excessive angle.	See the symptom of "Hoist will not lift under no load."
Load drops when select lever is set in free chain mode.	Mis-assembly of free chain spring -Poorly tightened brake caused by insufficient twist angle.	See the symptom of "Hoist will not lift under no load."
Hard to reset the hoist out of free chain mode.	Mis-assembly of free chain spring -Insufficient twist angle.	Reassemble it properly. 

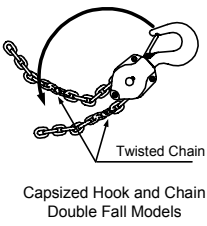
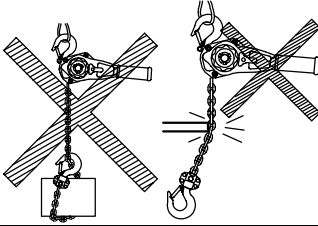
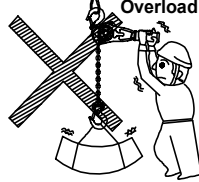

Symptom	Cause	Remedy
---------	-------	--------

For load chain

<p><b>⚠ CAUTION</b></p> <p>-The load chain is one of critical parts of the hoist. Ensure to maintain the chain carefully including proper handling, good maintenance and inspection.            -Replace the chain pin for the load chain replacement.</p>		
Load chain wear.	Lack of lubricant -Caused by high frequent and long term use.	Keep the load chain lubricated.
Deformed or scarred load chain.	Twisted load chain caused by mis-assembling.	Reeve the load chain into hoist properly. Replace as needed.
Deformed or scarred load chain.	Capsized hook	Reset the capsized hook. Replace as needed.  
	Contact with load or an obstacle.  	Replace as needed. Do not use the load chain as a sling.
Rusty load chain.	Extended pitch of load chain caused by overload.	Replace as needed.  <b>⚠ WARNING</b> Do not lift over the rated capacity.  
	Lack of lubricant. Exposed to rain. Exposed to seawater or chemicals.	Handle and maintain the hoist properly corresponding to your operating conditions.  <b>⚠ CAUTION</b> Keep the hoist hooked indoors when out of use.  
Broken load chain.	Caused often by a combination of the three symptoms as mentioned above and shock load.	<b>⚠ WARNING</b> Broken load chain could result in death or serious injury. Ensure to maintain the chain carefully including proper handling, good maintenance and inspection.

Symptom	Cause	Remedy
---------	-------	--------

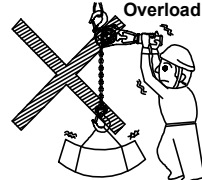
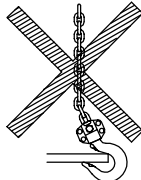
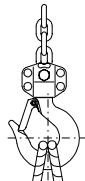
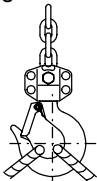
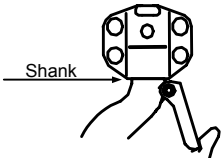
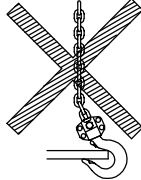
For hooks

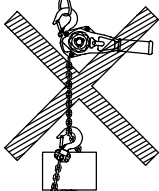
<p><b>! CAUTION</b> To prevent the hooks from being damaged, handle them properly in accordance with this manual.</p>		
<p>Stretched hook.</p>	<p>Overload -Hook will begin to deform gradually when the load applied exceeds the double of rated load.</p>	<p><b>! WARNING</b> Stretched hook warns you about overload. Do not lift over the rated capacity.</p> 
	<p>Support on tip of hook.</p> 	<p>Support a load in the middle of the hook saddle.</p> 
	<p>Improper slinging, sling size used to hook, or suspension angle.</p> 	<p>-Use a sling suitable for your operation. -Use the sling with suspension angle of 120 degrees or less.</p>
<p>Bend shank or neck of hook.</p> 	<p>Support on tip of hook.</p> 	<p><b>! WARNING</b> Ensure to support a load in the middle of the hook saddle, otherwise the hook could be damaged.</p>
<p>Twisted hook.</p>	<p>Attaching load chain around load.</p> 	<p>Do not use the load chain as a sling.</p> 
<p>Broken hook latches.</p>	<p>Hook deformed by overloading. Improper sling in size used to hook. Sling hooked on latch.</p>	<p>Perform proper hooking.</p>

## 8. Warranty

KITO Corporation (referred to after as KITO) extends the following warranty to the original purchaser (referred to after as Purchaser) of new products manufactured by KITO (KITO's Products)

KITO warrants that KITO's Products, when shipped, shall be free from defects in workmanship and/or materials under normal use and service and KITO shall, at the election of KITO, repair or replace free of charge any parts or items which are proven to have said defects, provided that all claims for defects under this warranty shall be made in writing immediately upon discovery and, if there is anything within one(1) year from the date of purchase of KITO's Products by Purchaser and provided, further, that defective parts or items shall be kept for examination by KITO or its authorized agents or returned to KITO's factory or authorized service center upon request by KITO.

KITO does not warrant components of products provided by other manufacturers. However to the extent possible, KITO will assign to Purchaser applicable warranties of such other manufacturers.

Except for the repair or replacement mentioned above which is KITO's sole liability and purchaser's exclusive remedy under this warranty, KITO shall not be responsible for any other claims arising out of the purchase and use of KITO's Products, regardless of whether Purchaser's claims are based on breach of contract tort or other theories, including claims for any damages whether direct, indirect incidental or consequential.

This warranty is conditional upon the installation, maintenance and use of KITO's Products pursuant to the product manuals prepared in accordance with content instructions by KITO. This warranty shall not apply to KITO's Products which have been subject to negligence, misuse, abuse, misapplication or any improper use or combination or improper fittings, alignment or maintenance.

KITO shall not be responsible for any loss or damage caused by transportation, prolonged or improper storage or normal wear and tear of KITO's Products or for loss of operating time.

This warranty shall not apply to KITO's Products which have been fitted with or repaired with parts, components or items not supplied or approved by KITO or which have been modified or altered.

THIS WARRANTY IS IN LIEU OF ALL OTHER WARRANTIES. EXPRESS OR IMPLIED, INCLUDING BUT NOT LIMITED TO ANY WARRANTY OF MERCHANTABILITY OR OF FITNESS FOR A PARTICULAR PURPOSE.

# 9. Parts List

## 9.1. Up to 3.2 tonnes

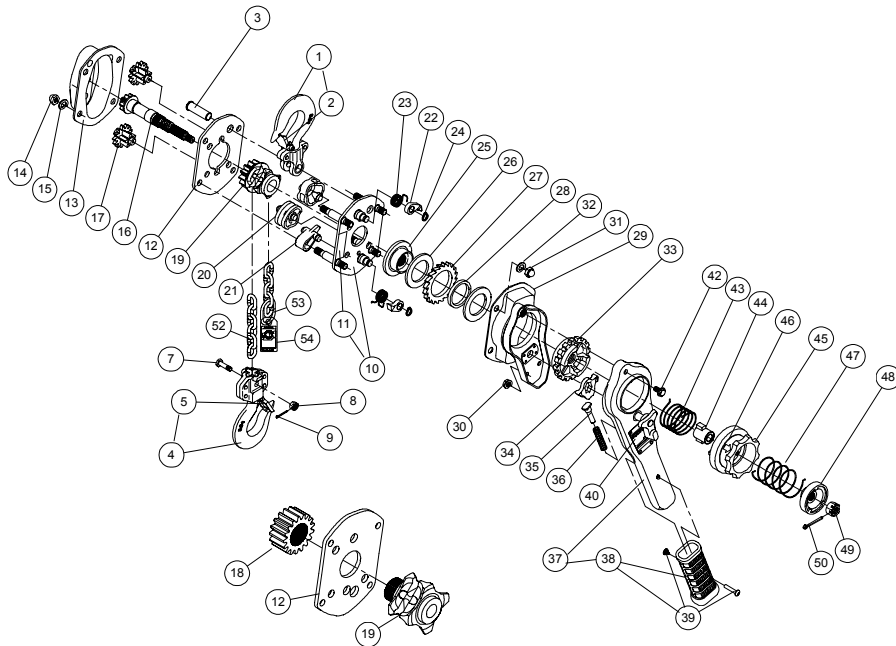

Exclusive for 2.5 & 3.2 tonnes

Fig. #	Part #	Part Name	Nos. per Hoist	Capacity (tonnes)				
				0.8	1	1.6	2.5	3.2
1	1001	Top Hook Set	1	L5BA008-1001	L5BA010-1001	L5BA016-1001	L5BA025-1001	L5BA032-1001
	1071	Latch Assembly	1	L5BA008-1071	L5BA010-1071	L5BA016-1071	L5BA025-1071	L5BA032-1071
3	163	Top Pin	1	L5BA008-9163				
4	1021	Bottom Hook Set	1	L5BA008-1021	L5BA010-1021	L5BA016-1021	L5BA025-1021	L5BA032-1021
	1071	Latch Assembly	1	L5BA008-1071	L5BA010-1071	L5BA016-1071	L5BA025-1071	L5BA032-1071
7	41	Chain Pin	1	L4BA008-9041	C3BA015-9041	L5BA025-9041	L4BA030-9041	
8	49	Slotted Nut	1	C3BA005-9049				
9	96	Split Pin	1	J1PW01-016010	J1PW01-020012	J1PW01-020014		
10	5101	Frame A Assembly	1	L5BA008-5101	L5BA016-5101	L5BA025-5101	L5BA032-5101	
	806	Nameplate F	1	C3BA005-9806				
12	102	Frame B	1	L5BA008-9102	L5BA016-9102	L5BA025-9102	L5BA032-9102	
13	5103	Gear Case Assembly	1	L5BA008-5103	L5BA016-5103	L5BA025-5103	L5BA032-5103	
14	181	Domed Cap Nut	4	J1ND005-30080				
15	182	Spring Lock Washer	4	J1WS011-20080				
16	111	Pinion	1	L5BA008-9111	L5BA016-9111	L5BA025-9111	L5BA032-9111	
17	112	Gear #2	2	L5BA008-9112	L5BA016-9112	L5BA025-9112	L5BA032-9112	
18	114	Load Gear	1	L5BA025-9114				
19	116	Load Sheave	1	L5BA008-9116	L5BA016-9116	L5BA025-9116	L5BA032-9116	
20	161	Chain Guide	2	L5BA008-9161	L5BA016-9161	L5BA025-9161	L5BA032-9161	
21	162	Stripper	1	L5BA008-9162	L5BA016-9162	L5BA025-9162	L5BA032-9162	
22	155	Pawl	2	L4BA008-9155				
23	158	Pawl Spring	2	L5BA008-9158	L5BA016-9158	L5BA025-9158	L5BA032-9158	
24	188	Snap Ring	2	L4BA008-9188				
25	153	Friction Disc	1	L5BA008-9153				
26	151	Friction Plate	2	L4BA008-9151				
27	152	Ratchet Disc	1	L4BA008-9152				
28	154	Bushing	1	L4BA008-9154				
29	5214	Brake Cover Assembly	1	L5BA008-5214	L5BA016-5214	L5BA025-5214		
30	281	Flange Nut	2	J1NF005-10060				
31	184	Domed Cap Nut	4	J1ND005-30080				
32	185	Spring Lock Washer	4	J1WS011-20080				
33	160	Female Thread	1	L5BA008-9160				
34	218	Select Pawl	1	L4BA008-9218				
35	222	Spring Shaft	1	L2BA008-9221				
36	223	Select-pawl Spring	1	L2BA008-9223				
37	6211	Lever Assembly	1	L5BA008-6211	L5BA016-6211			L5BA032-6211
	1231	Grip	1	L5BA008-1231	L4BA008-1231			L4BA015-1231
38	232	Binding Screws	1	L5BA008-9232				
	800	Nameplate (Other)	1	L5BA008-9800	L5BA010-9800	L5BA016-9800	L5BA025-9800	L5BA032-9800
40	800	Nameplate (Europe)	1	L5BG008-9800	L5BG010-9800	L5BG016-9800	L5BG025-9800	L5BG032-9800
	221	Hex Cap Screw	1	L4BA008-9221				
42	207	Brake Spring	1	L4BA008-9207				
43	203	Cam Guide	1	L5BA008-9203				
44	201	Free Chain Knob	1	L4BA008-9201				
45	810	Nameplate U	1	L4BD015-9810				
46	205	Free Chain Spring	1	L4BA008-9205				
47	208	Spring Holder	1	L5BA008-9208				
48	183	Slotted Nut	1	C3BA020-9049				
49	187	Split Pin	1	J1PW01-020014				
50	841	Nickel-plated Load Chain	1	KAQN056J0000	KAQN071J0000	KAQN088J0000	KAQN100J0000	
52	45	Chain Stopper Link	1	L5BA008-9045	L5BA016-9045	L5BA025-9045	L5BA032-9045	
53	931	Warning Tag CE (Other)	1	E7AR003S9886				
	931	Warning Tag CE-G (Europe)	1	ER1BS9686				

9.2. Exclusive Parts

6.3 tonnes

9 tonnes

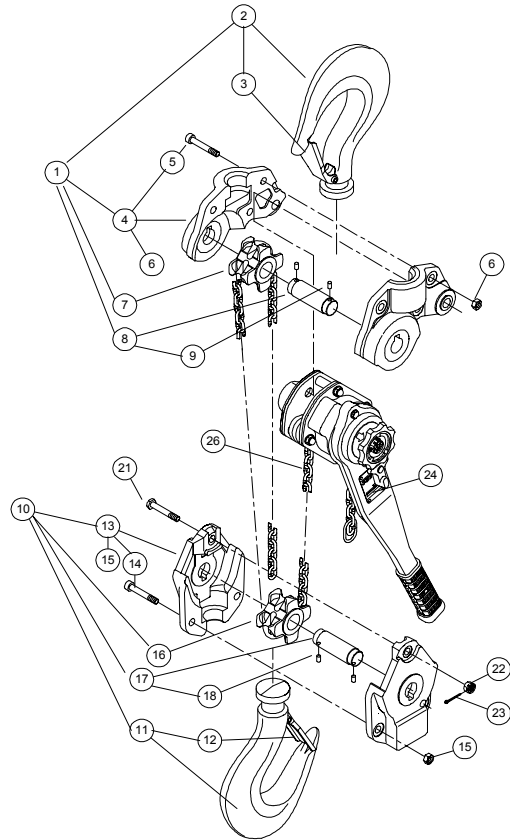
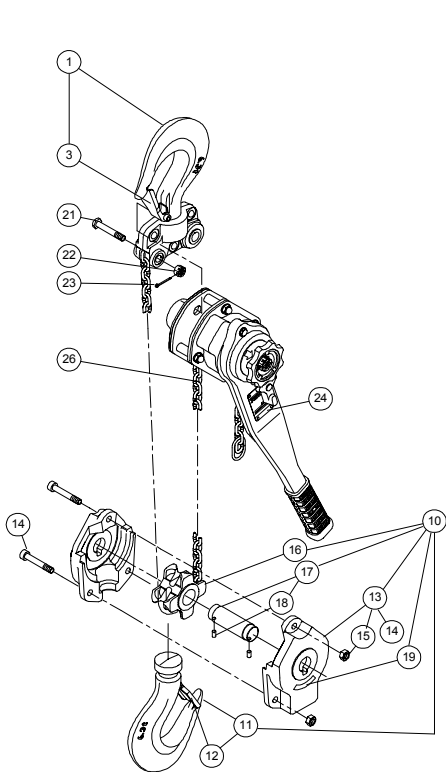

Note: These basic bodies are the same as 3.2 tonnes.

Fig. #	Part #	Part Name	Nos. per Hoist	Capacity (tonnes)		
				6.3	9	
1	1001	Top Hook Set	1	L5BA063-1001	L5BA090-1001	
	2	2001	Hook Assembly	1		L5BA090-2001
		1071	Latch Assembly	1	L5BA063-1071	L5BA090-1071
	4	2011	Top Hook Yoke A & B Assembly	1		L5BA090-2011
		81	Socket Bolt	3		J1BE1-1204040
		82	Lever Nut	3		C2BA400-9074
	7	51	Idle Sheave	1		L5BA063-9051
	8	53	Shaft Assembly	1		L4BA060-9053
		83	Shaft Stopper Pin	2		L4BA060-9083
10	1021	Bottom Hook Set	1	L5BA063-1021	L5BA090-1021	
	11	2001	Hook Assembly	1	L5BA063-2001	L5BA090-2001
		1071	Latch Assembly	1	L5BA063-1071	L5BA090-1071
	13	1031	Bottom Hook Yoke Assembly	2	L5BA063-9031	L5BA090-9031
		81	Socket Bolt	2		J1BE1-1204040
			3		3	J1BE1-1003232
	15	82	Lever Nut	2		C2BA400-9074
				3		C2BA200-9074
	16	51	Idle Sheave	1		L5BA063-9051
	17	53	Shaft Assembly	1		L4BA060-9053
83		Shaft Stopper Pin	2		L4BA060-9083	
19	805	Nameplate C	1	L4BH060-9805		
21	41	Chain Pin	1		L4BH060-9041	
22	49	Slotted Nut	1		C2BA020-9049	
23	96	Split Pin	1		J1PW01-020014	
24	800	Nameplate (Other)	1	L5BA063-9800	L5BA090-9800	
	800	Nameplate (Europe)	1	L5BG063-9800	L5BG090-9800	
26	841	Nickel-plated Load Chain	1		KAQN100J0000	

9.3. Optional Parts

Lever assembly for load signal type

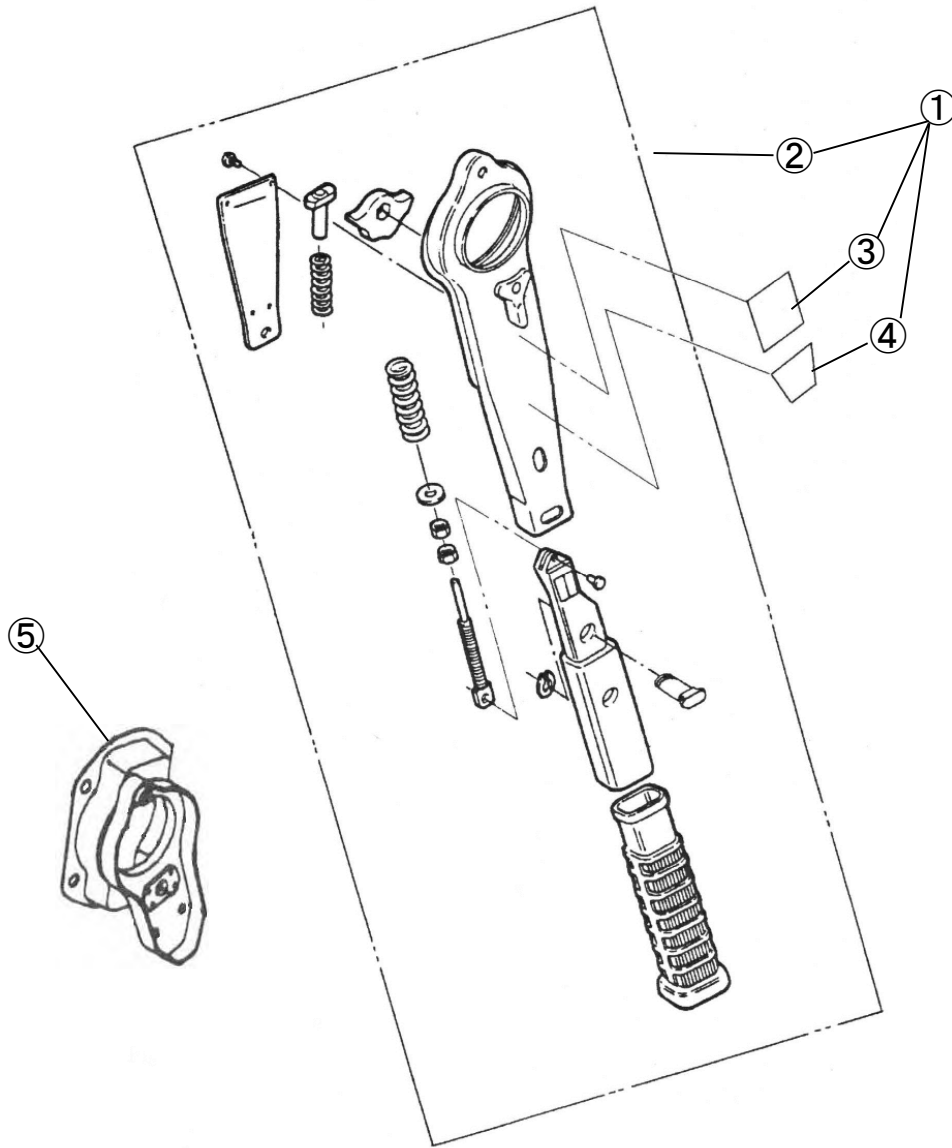

Fig.#	Part#	Part Name	Nos per Hoist	Capacity (tonnes)						
				0.8	1	1.6	2.5	3.2	6.3	9
1	5211	Lever Set	1	Y3SS008-5211	Y3SS010-5211	Y3SS016-5211	Y3SS025-5211	Y3SS032-5211	Y3SS063-5211	Y3SS090-5211
2	6211	Lever Assembly	1	Y3SE008-6211	Y3SE010-6211	Y3SE016-6211	Y3SE025-6211	Y3SE032-6211	Y3SE063-6211	Y3SE090-6211
3	800	Name Plate With Rivets	1 *1	Y3SE008-9800	Y3SE010-9800	Y3SE016-9800	Y3SE025-9800	L5BA032-9800	L5BA063-9800	L5BA090-9800
4	801	Name Plate B	1	Y3SS008-9801						
5	5214	Brake Cover Assembly	1 *2	Y3SE008-5214	—	—	—	—	—	—

\*1. Four rivets are also supplied to fasten the nameplate.

\*2. Since Brake Cover Assembly is exclusive for LOAD SIGNAL 0.8 tonne and 1 tonne, their standard Brake Cover Assembly needs to be exchanged for LOAD SIGNAL installation.



## 10. Contents of EC Declaration of Conformity

We, **KITO Corporation**,  
2000 Tsuijirai, Showa-cho,  
Nakakoma-gun, Yamanashi-ken, 409-3853, Japan  
declare under our sole responsibility that the products:

**Manually lever operated chain hoist** **LB, model L5**  
in capacity range of 800 kg up to 9 tonnes

to which this declaration relates is in conformity with the following EC directives and standards.

EC directives:

**Machinery Directive** **2006/42/EC**

Harmonized standards:

**EN ISO 12100:2010** **Risk assessment and risk reduction**

**EN 13157:2004+A1:2009** **Hand powered lifting equipment,  
except for the requirement of "5.2.6 Operating effort"**

The person authorized to compile the technical file:

**Udo Kleinevoß**  
**Technical manager**  
**Kito Europe GmbH. 40549 Düsseldorf**

# KITO

URL. <http://www.kito.com>

## **KITO Europe GmbH**

Heerdter Lohweg 93, D-40549 Düsseldorf, Germany

TEL: +49-(0)211-528009-0

FAX: +49-(0)211-528009-59

E-mail: [info@kito.net](mailto:info@kito.net)

URL: <http://www.kito.net>

## **KITO corporation**

### **Tokyo Head office:**

SHINJUKU NS Building 9F, 2-4-1, Nishi-Shinjuku, Shinjuku-ku, Tokyo 163-0809, Japan

URL: <http://www.kito.com>

### **Head office & Factory:**

2000 Tsuijjarai Showa-Cho, Nakakoma-Gun, Yamanashi 409-3853, Japan

URL: <http://www.kito.com>