

ROCKVILLE



p OWNERS MANUAL
PHENOM
SERIES

Introduction

Thank you for purchasing this Rockville Phenom Marine Series amplifier. Over the years, the technology used to create audio amplifiers has grown by leaps and bounds. Our competition is satisfied with just continuing to build the same units year after year without thought for improvement, but not Rockville. We consider it our mission to use our expertise in developing the latest technologies and to bring you the absolute best sounding amplifiers on the market and of course at a reasonable price. You will be amazed at the quality and power that these new amps offer.

We have spared no expense in designing these amplifiers, creating the most rugged, reliable, powerful and best performing amplifiers. In fact we are so sure of the quality we backup every Phenom Marine Series amplifier with one year warranty which exemplifies our commitment to the end user. (See enclosed warranty card for details.)

Please read this installation guide carefully for proper use of your Phenom Marine Series amplifier. Read this entire guide fully before attempting your installation.

WARNING: BE AWARE! Use of this amplifier at extreme high volumes for extended periods of time may cause hearing loss and or hearing damage. During periods of prolonged high volume levels it is recommended that you use ear safety devices. Your ability to hear necessary traffic sounds will be impaired. While driving always keep your sound volume at reasonable levels. We at Rockville want you listening for many years to come.

When installing the amplifier, secure it tightly. An unmounted amplifier in your car can cause serious injury to passengers and damage to your vehicle if it is set in motion by an abrupt driving maneuver or short stop.

Features

GOLD PLATED TERMINALS:

All the terminals on the amplifier are solid brass and platinum plated for high conductivity and minimum impedance loss. The power and ground terminals are extra large and capable of accepting 4-8 gauge wire. The speaker terminals can accept 14-16 gauge wire. When wiring the amplifier, be sure to strip just enough wire that fits into the terminal so that bare wires do not touch each other, or the amplifier chassis and cause a short circuit. We recommend using lug and spade connectors for optimum signal transfer.

POWER AND PROTECTION CIRCUITRY:

Phenom Marine Series amplifiers feature our unique IC controlled protection circuitry. This sophisticated circuit constantly monitors the heat sink internal temperature and various voltages, adjusting the amp automatically and protecting it from dangerous conditions. The 2 LED's located on the side of the amplifier provide indication of the amplifier status, the Power LED will light when the amplifier is receiving proper power, ground and remote voltages and the IC monitoring sequence indicates the amp is functional. In case the amplifier encounters a diagnostic condition as listed below, the second LED will light indicating a Diagnostic condition. When a diagnostic condition is sensed the amplifier will then turn into a self preservation mode and if the cause of the diagnostic condition is not corrected will eventually shut down. There are certain critical diagnostic conditions which will turn the amplifier off immediately.

- 1. Speaker short circuit.**
- 2. Input Overload.**
- 3. Thermal overload.**
- 4. Reverse Polarity.**

To reset the amplifier, you must first diagnose what caused the problem, correct the fault and restart the system.

MUTE CIRCUIT:

Phenom Marine Series amplifiers feature an anti-thump, mute and delay circuit. This eliminates irritating speaker damaging turn-on and turn-off transients normally experienced with less expensive amplifiers.

BASS DRIVE EQUALIZATION CIRCUITRY:

A narrow "Q" shelving equalization circuit is included in the amplifiers. The equalization system is preset at 45Hz. The boost control allows you to add up to 18dB of Bass Drive effect. Utilize the Bass Drive to tailor your bass response to your systems needs. Please keep in mind that by adding Bass Drive you are adding stress on your speakers. Make sure your speakers can handle the extra power output! It would be foolish to add 18dB of gain to low excursion 8" and 10" Sub woofers or mid ranges and tweeters. It's a sure way to blow your speakers. The Bass Drive was designed for High Power sub woofers.

"ADR": - ACTIVE DYNAMIC REGULATION

RX Phenom Series amplifiers feature our proprietary ADR, Active Dynamic Regulated power supplies. 100% HexFET devices are utilized in the power supply for high speed (100KHz) switching frequencies. The power supplies are capable of supplying the main amplifier with a considerable amount of reserve voltage for peak "high demand" situations. The ADR circuit provides full bandwidth power for authoritative bass response, high current output into low impedance loads and increased headroom. The ADR is supplied with power via a high speed, high temperature capacitance bank and 100% pure copper rails on the PCB enabling fast transient response to musical demands.

SUPER CLASS AB AUDIO STAGE PERFORMANCE

The audio output section of the Phenom Marine Series amplifiers feature Japanese studio grade, high current Bi-Polar audio transistors. Unlike other manufacturers who use a host of different type of transistors, not originally designed for audio output, i.e.: power supply transistors, motor control transistors to produce the audio signal, (You can only imagine what they sound like.) Rockville uses only true audio transistors in the audio section of these amplifiers. These transistors were designed and engineered to produce music. That's why Rockville amplifiers clearly sound better. They are cleaner with lower distortion, higher current capable and more reliable. We challenge you to test listen a Rockville amplifier and hear the difference yourself.

Features

“ARVA” - AUTOMATIC RAIL VOLTAGE ADJUSTMENT CIRCUITRY:

Rockville Phenom Marine Series amplifiers feature “ARVA” circuitry in their power supply. This circuit constantly monitors the output stage and under high current demands will adjust the power supply rail voltages so that enough power is available for peak situations. The “ARVA” also improves the damping factor of the amplifier when playing low impedance mono loads. Rockville RX Phenom Series amplifiers have tighter sounding bass reproduction thanks to this unique circuitry.

BATTERY VOLTAGE:

Rockville Phenom Marine Series amplifiers are rated and regulated to 13.8 volts and below. Increasing voltage to 14.4 volts will increase the power output of the amplifier in the same proportion. Maximum input voltage is 14.4 volts while the minimum voltage is 12 volts.

***** DO NOT EXCEED 14.4 INPUT VOLTAGE. *****

Though capable of high power reproduction, Rockville RX Phenom Series amplifiers are not competition style amplifiers! They were designed for audiophile sound reproduction.

PROTECTION CIRCUITRY:

Rockville amplifiers incorporate many outstanding protection circuits to help protect the amplifier from being damaged during operating conditions.

Thermal Protection: When the amplifier reaches an unsafe operating temperature of 80 degrees Celsius the amplifier will turn off. Once the amplifier cools down, simply reset the amplifier by its Remote connection, (turn the amplifier off and then on again once you have given the amplifier a chance to cool down) and the amp will once again begin to play.

If you live in a hot climate we suggest installing additional cooling fans in your trunk to exhaust the hot air which can build up in the trunk this will help keep the ambient temperature in the trunk as low as possible so that your amps work flawlessly and without any musical interruption.

Speaker Short Circuit Protection: Should your speakers short circuit due to voice coil burn out, or should the amplifier sense an impedance too low to handle, the Protection LED will light, indicating a diagnostic condition. Turn off your system, disconnect one speaker at a time and try to determine which speaker might be faulty. Correct the condition and restart the amplifier. You must reset the amplifier by turning it OFF and then ON again by the Remote power connection after correcting a diagnostic condition. (Turn your radio off and then on again.)

Clipping or total shutdown may also be a result of a bad ground connection or loose ground. If you find that your speakers and speaker wires are not shorted, please check your ground connection.

Input Overload Protection: This circuit will either shutdown the amplifier completely or make the amplifier spurt on and off indicating that it is in a diagnostic condition. Turn the system off and reduce the gain on the amplifier or volume from your head unit, this should result in a corrected condition.

DC Offset Protection: Should any DC voltage try to enter the amplifier via the speaker terminals it will cause the amplifier to shut down and not operate until this condition is remedied. This circuit will also protect damaging high DC voltages from reaching your speakers should your amplifier ever malfunction.

INSTALLATION BASICS:

Before you begin with your installation, disconnect the NEGATIVE (-) terminal from your car's battery. This safety precaution will avoid possible short circuits while wiring your amplifier. Rockville amplifiers operate on 12-volt negative ground systems only.

It is recommend that you layout your sound system design on paper first. This will help you during the installation so that you will have a wiring flow chart and not miss-wire any of your components.

Mount the amplifier in the trunk or hatch area of your vehicle. Never install an amplifier in the engine compartment or on the firewall. Please be sure to leave breathing room around the amplifier heat sink so that it can dissipate the heat it produces efficiently. The amplifier can be installed either horizontally or vertically.

When mounting the amplifier on the trunk floor, be sure to watch for your gas tank, gas lines and electrical lines. Do not drill or mount any screws where they might penetrate the gas tank of your car.

Installation Basics

The remote turn on connection is located on the barrier strip next to the power and ground connections. This connection is responsible for turning the amplifier on and off with the rest of the system. A smaller gauge wire can be used to make this connection to your radio's power antenna lead. Should your system not have any turn on leads, you can wire the remote terminal to an accessory lead, which turns on, with your cars ignition.

The Phenom Marine Series amplifiers are supplied with built-in fuses, never replace the fuse that the amp came with, with one of a larger value.

We suggest you construct a Red wiring harness with 2 additional fuses. One fuse should be located near the car battery. This fuse near the battery offers protection against damage from short circuits to the car chassis between the battery and the amplifier. A second fuse closer to the amplifier offers additional safety to the amplifier itself. This fused red power wire should be attached to the amplifier power terminal marked

The wire harness should be made of red primary cable of at least 8 gauge and at least 4 gauge for all arger models. The harness should terminate in a large ring terminal for connection directly to the positive terminal of the car battery. Use a spade plug to attach the wire, which connects to the amplifier location marked

A second black color wire of equal gauge should be used as a ground connection to a welded chassis member. When connecting the ground wire make sure that there is no paint or other insulator blocking a good ground connection. When installing multiple amplifiers, mount them in close proximity so that they can all share the same ground point. Attach the black ground wire to the amplifier screw terminal marked

We have received amplifiers back to our service department with melted power/ground terminals. The cause of this is a bad ground connection. When there is a lack of good ground, heat builds up at the weakest point which happens to be the contact screw of the amplifier terminal. Over time the heat generated will begin to melt the terminal. It is a good practice to feel the power and ground wires with your hands, near their amplifier connection after having played the amp for a while. If the wires feel hot to the touch you probably have a bad or loose connection. If you are sure of your connections and the wires still feel hot to the touch, you should upgrade the gauge of wire to next heaviest gauge.

SETTING THE CONTROLS:

AUDIO PREAMP INPUT

The Phenom Marine Series amplifiers feature RCA pre amp inputs. Run RCA cables from your sound source to the inputs of the amplifier. We suggest the use of high quality shielded RCA patch cords to help reduce and eliminate unwanted electrical noise to your system.

Be sure to run the RCA cables on the opposite side of the vehicle that you used to carry the power and ground leads of the amplifier.

USING THE BUILT-IN LOW PASS ELECTRONIC CROSSOVER

All the Phenom MARINE Series amplifiers feature 12dB per octave fully adjustable low-pass and high pass electronic crossovers.

For Low Pass sub woofer systems, set the CROSSOVER MODE switch to LOW PASS. Now the knob marked FREQUENCY will control the low pass frequencies depending on the model anywhere from 50Hz to 3KHz. A frequent error made is setting the low pass frequency too low, especially when using vented sub woofer enclosures. We recommend that for most installations you do not set the frequency knob lower than 80 - 100Hz (the 12 o'clock position).

When using the amplifiers for component speakers or co-axials, you will want to set the CROSSOVER MODE switch to HIGH PASS. The FREQUENCY control knob adjusts the high pass frequencies between 15Hz and 1KHz. Do not attach tweeters directly to the amplifier, (even in the high pass mode) without a secondary passive crossover to protect them. 500Hz high pass is not a frequency high enough for tweeters.

SUBSONIC FILTERING

For sub woofer installations with a passive LP crossover, you can set the amplifier's CROSSOVER MODE selector to HIGH PASS while setting the FREQUENCY KNOB to 30Hz, this will act as SUBSONIC FILTER for all signals below 30Hz. This is especially useful for vented enclosures where the port tuning frequency falls below the sub woofer tuning frequency to protect against sub woofer unloading.

Installation Basics

ADJUSTING THE SYSTEM

Once the system is operational, the first thing to do, is set all crossover points to approximate settings. In the case of the basic sub woofer system Low Pass filter crossover at 100 Hz or so. Set the Bass Boost equalizer controls to 0 dB (Flat Switch Position.)

Now you should set the amplifiers Input Sensitivity adjustment. The knob accessible on the side of the amplifier marked INPUT LEVEL adjusts the input sensitivity from 150mV to 8 Volts.

To adjust the input sensitivity, turn the control using a small flat head screwdriver fully counter clock wise to the minimum position. Do not apply any pressure while turning as this might break the control unit. Adjust your radio volume level to maximum volume. Now turn the level control on the amplifier clockwise towards the Maximum marking until audible distortion occurs. When you begin to hear any distortion in the sound, back down one notch and your amp is set. It is helpful to have a second person to help you set the gain.

When setting up a multi-amp system, set each amplifier's gain separately. Start off with the bass amplifier, then adjust the highs amplifier's level control to match.

Once you are satisfied with the level control settings, use any equalizer controls to adjust the system tonal level for personal preference. Keep in mind that after equalizing, you may have to go back and reset the amplifiers level controls.

*** The level control of any car amplifier should not be mistaken for a volume control. It is a sophisticated device designed to match the output level of your source unit to the input level of the amplifier. Do not adjust the amplifier gain to maximum unless your input level requires it.

If your unit has been professionally installed please do not change the gain settings set by the installer, he is the professional!

Your system can also be extremely sensitive to noise when the LEVEL is set to maximum and does not match your input signal. The gain adjustments need to be made only once when first setting up the system.

USING THE ELECTRONIC CROSSOVER - 4 CHANNEL MODELS

The four and five channel models feature separate crossovers for channels 1-2, 3-4, and 5. All the Phenom Marine Series amplifiers feature 12dB per octave fully adjustable low-pass and high pass electronic crossovers.

FOUR CHANNEL AMPLIFIER CONFIGURATIONS.

1. All four channels High Pass for internal component speakers in doors and rear decks.
2. Channels 1 and 2 High Pass for front component speakers, while channels 3 and 4 are wired to sub woofers.
3. Bridge channels 1 and 2 for single high power sub woofer channel. Bridge channels 3 and 4 for second high power sub woofer channel.

For Low Pass systems, set the CROSSOVER MODE switch to LOW PASS. Now the knob marked FREQUENCY will control the low pass frequencies from 40Hz to 150Hz. A frequent mistake made is setting the low pass frequency too low, especially when using vented sub woofer enclosures. We recommend that for most installations you do not set the frequency knob lower than 100Hz (the 12 o'clock position).

When using the amplifiers for component speakers or coaxial, you will want to set the CROSSOVER MODE switch to HIGH PASS. The FREQUENCY control knob adjusts the high pass frequencies between 50Hz and 500Hz. Do not attach tweeters directly to the amplifier even in the high pass mode without a secondary passive crossover to protect them. 500Hz high pass is not a frequency high enough for tweeters.

PASSIVE SUBSONIC FILTERING

For sub woofer installations with a passive LP crossover, you can set the amplifier's CROSSOVER MODE selector to HIGH PASS while setting the FREQUENCY KNOB to 40Hz, this will act as SUBSONIC FILTER for all signals below 40Hz. This is especially useful for vented enclosures where the port tuning frequency falls below the sub woofer tuning frequency to protect against sub woofer unloading.

Mounting and Wiring

MOUNTING THE AMPLIFIERS:

The Phenom Marine Series amplifiers feature four mounting tabs located at the amplifiers four corners. Choose a convenient mounting location with unobstructed airflow.

Using the supplied screws and grommets, gently mount the amplifier in to position.

*** Do not over tighten the screws.***

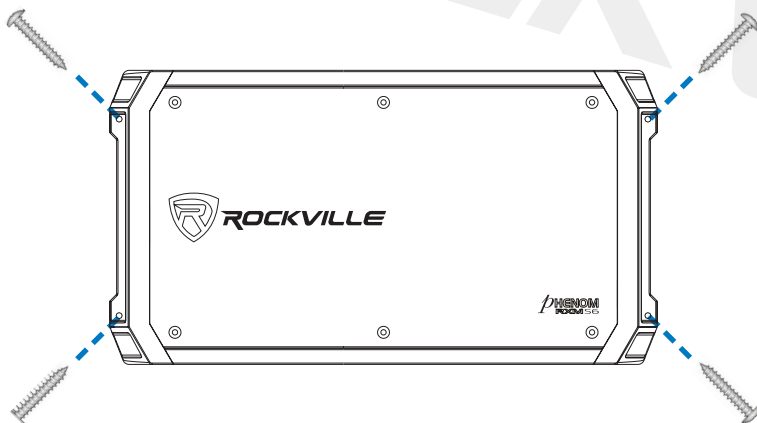

Phenom Marine Series amplifiers are supplied with built-in fuses, never replace the fuse that the amp came with, with one of a larger value.

We suggest you construct a Red wiring harness with 2 additional fuses. One fuse should be located near the car battery. This fuse near the battery offers protection against damage from short circuits to the car chassis between the battery and the amplifier. A second fuse closer to the amplifier offers additional safety to the amplifier itself. This fused red power wire should be attached to the amplifier power terminal marked **12V+**.

The wire harness should be made of red primary cable of at least 4 gauge for all Phenom Marine Series amplifiers. The harness should terminate in a large ring terminal for connection directly to the positive terminal of the car battery. Use a spade plug to attach the wire, which connects to the amplifier location marked **12V+**.

A second black color wire of equal gauge should be used as a ground connection to a welded chassis member. When connecting the ground wire make sure that there is no paint or other insulator blocking a good ground connection. When installing multiple amplifiers, mount them in close proximity so that they can all share the same ground point. Attach the black ground wire to the amplifier screw terminal marked **Ground**.

We recommend that you use the Rockville RWK41 amplifier installation kits, which contains all the cabling and accessories necessary for a good, reliable installation.

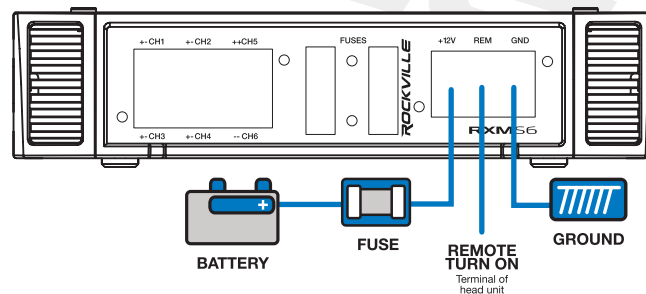

Special Features

HIGH LEVEL INPUTS

Because many factory radios do not have pre-amp outputs the RXM-F3, RXM-F4, and RXM-T1 models feature High Level inputs. High Level inputs, also referred to as Speaker Level inputs, allow you to connect to the factory speaker wires. They are called High Level inputs because they convert the high voltage running through factory speaker wires to one the amplifier can handle. These inputs will provide the end user with clean, well defined sound for optimal musical enjoyment. This unit also features Smart Auto Turn-On. When the amplifier senses a signal from the head unit, it automatically powers up. **Be sure to not use the Remote Turn-On wire when using High Level inputs.**

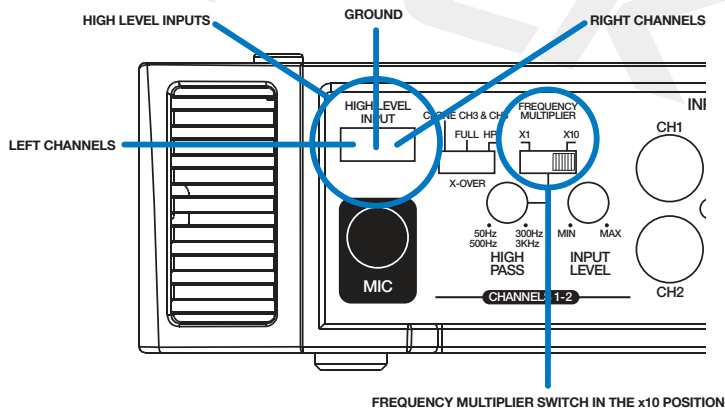

FREQUENCY MULTIPLIER

The RXM-F4 and RXM-F3 feature a Frequency Multiplier Function. Moving the switch from the x1 position to the x10 position will change the Crossover frequency range from 50Hz - 300Hz to 500Hz - 3KHz.

PUBLIC ADDRESS FUNCTION

The RXM-F3, RXM-F4, and RXM-S6 feature a marine public address system with microphone. Simply plug the microphone in to the 3.5mm jack and you are ready to go. The amplifier features talk-over functionality. When microphone is keyed music will fade to the background. When microphone is unkeyed, music slowly fades back in.

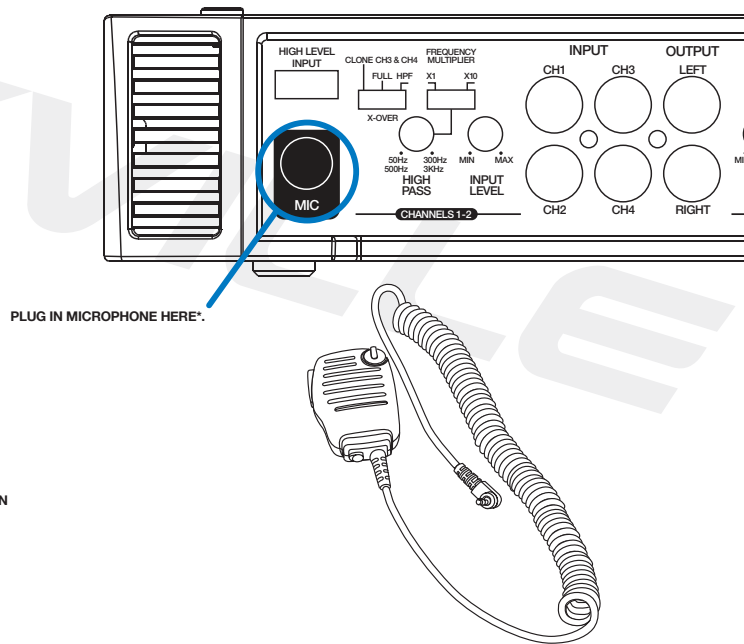

CLONE FUNCTION

The RXM-F3 and RXM-F4 feature a unique CLONE FUNCTION to assist in setting up a 2-channel bridged system with perfect gain and crossover tracking between the speakers. Typically when setting up a system you would need to set up channels 1 - 2 and then channels 3 - 4 crossovers and gains separately not guaranteeing perfect balance or frequency cutoffs. By using the CLONE FUNCTION you can control channels 1 - 2 from the processed signals of channels 3 - 4 thereby guaranteeing that all 4 channels are getting identical voltages and have their crossover settings identical at identical frequencies. Here is how you do it:

2. SET THE CROSSOVER MODE SWITCH TO CLONE CH3 AND CH4. THIS WILL SEND THE PROCESSED SIGNAL OF CH3 AND CH4 TO CH1 AND CH2.

1. PLUG STEREO RCA'S INTO CH3 AND CH4.

3. NOW ALL CONTROLS FOR CH1 AND CH2 WILL BE NON FUNCTIONAL. ALL CROSSOVER SETTINGS WILL BE CONTROLLED FROM CH3 AND CH4.

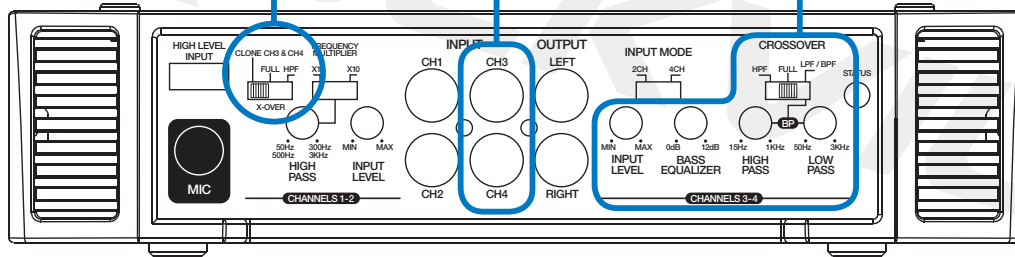

BAND PASS FUNCTION

The RXM-F4 and RXM-F3 feature a BANDPASS FUNCTION. In the LPF/BPF position the High Pass and Low Pass frequency controls work together creating a band pass channel optimized for midrange playback.

CROSSOVER MODE SWITCH
IN LPF/BPF POSITION

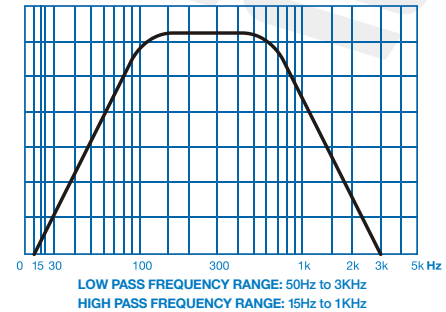
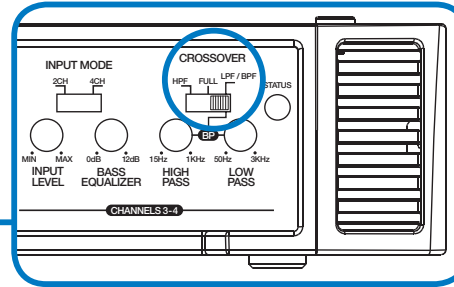

4 Channel Amp with 2 Channel Input

If your head unit has only one pair of Left and Right RCA out put jacks, plug them in to RCA input Jacks 1 and 2 of the amplifier and set the Input model switch to the 2CH position.

The amplifier preamp circuit will automatically mix the signals to channels 3 and 4 thereby preserving your Left and Right Balance control but with no Fade control Front to Rear.

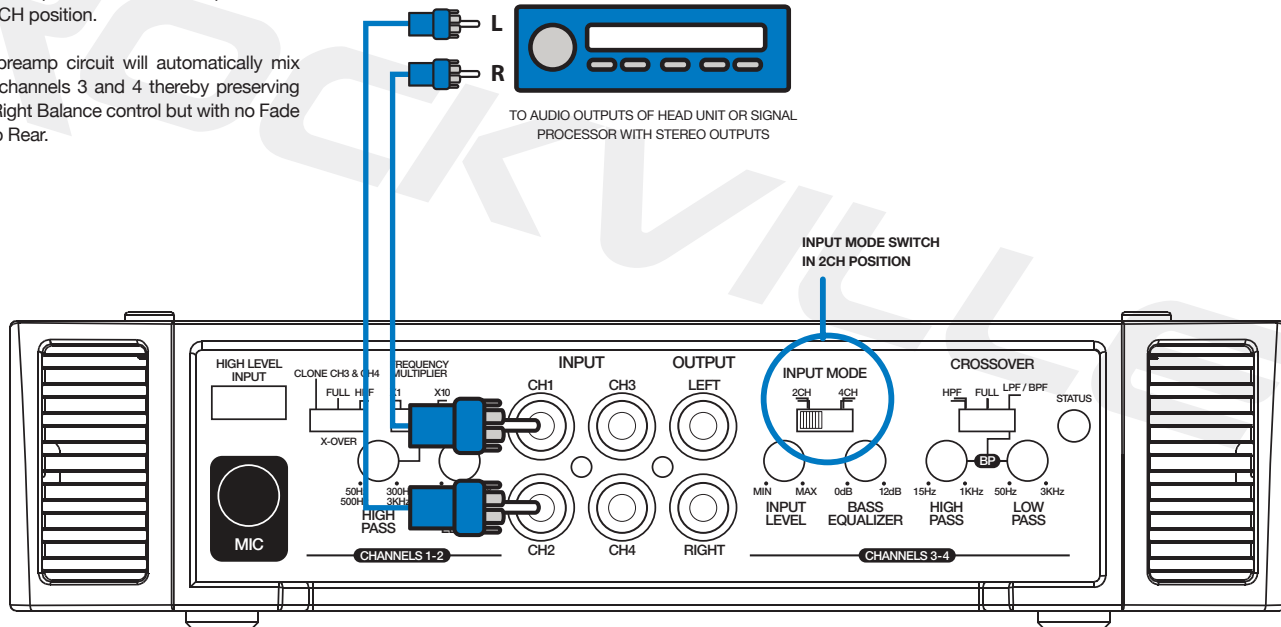

4 Channel Amp with 4 Channel Input

If your head unit has 2 pairs of RCA output jacks, input Front Left and Front Right in to Channels 1 and 2. Then attach radio output Rear Left and Rear Right to Channels 3 and 4. Set the Input Mode Switch to 4Ch position. The pre amp circuitry will not mix any signals thereby preserving full Left to Right Balance and Front to Rear fader control.

Should your head unit have an additional subwoofer RCA output, that typically needs to be attached to a separate subwoofer amplifier.

When configuring a 4 channel amplifier to a 3 channel system, you can use an RCA Y adaptor to send the subwoofer preamp signal to channels 3 and 4 and bridge those channels to the subwoofer. Use Y adaptors to mix channels 1 and 3 and input them into RCA Channel 1, then mix channels 2 and 4 and input them into RCA Channel 2. The result will be preserved Left and Right balance with constant subwoofer output.

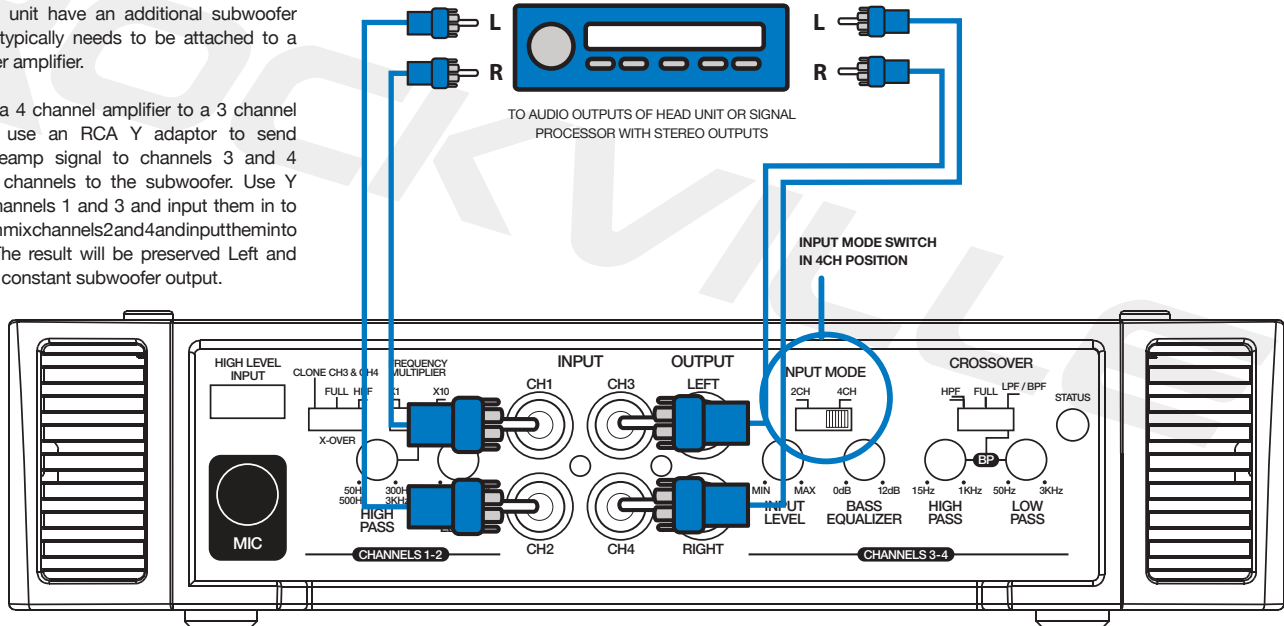

Basic 4 Channel Configuration

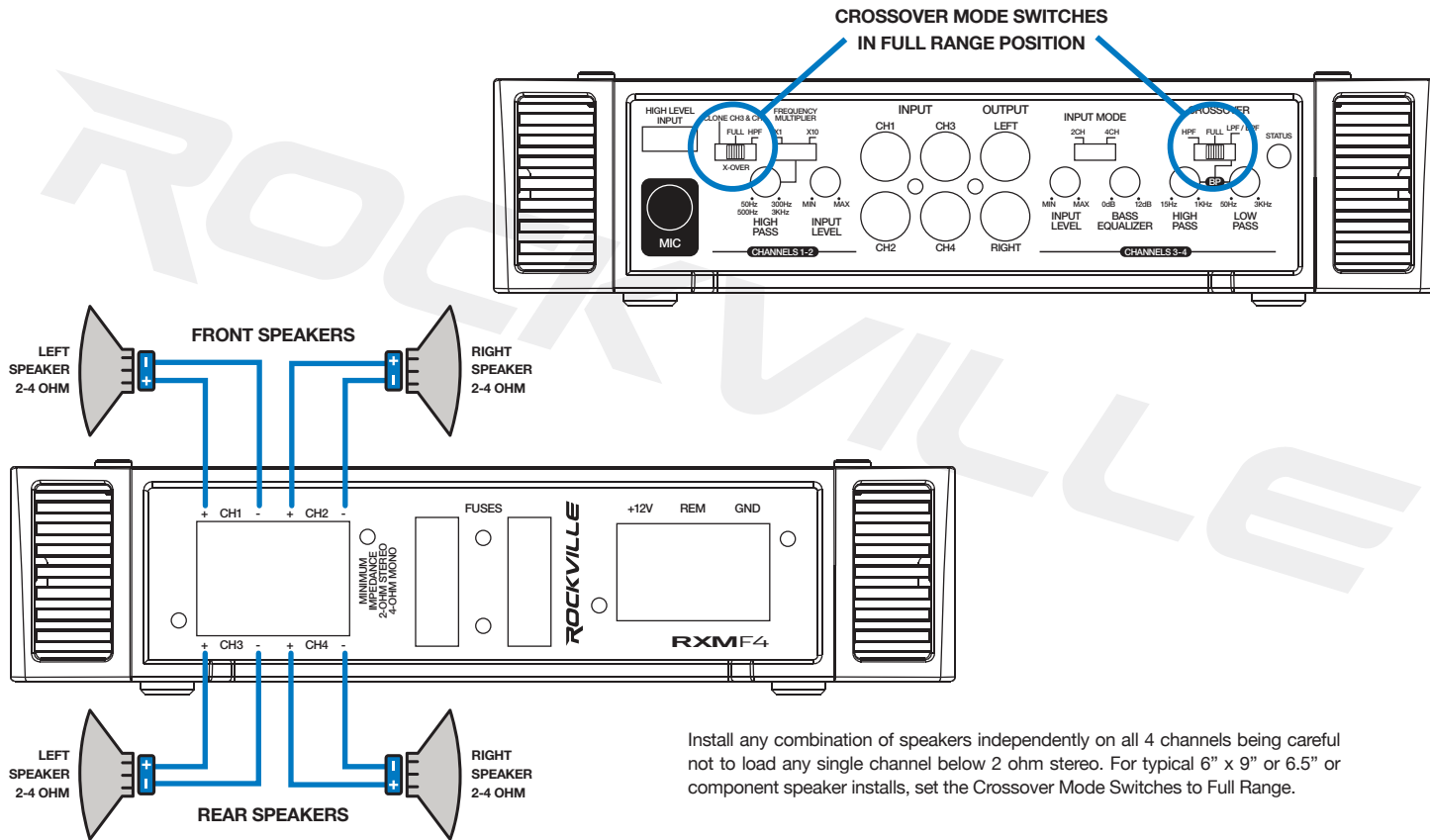

Install any combination of speakers independently on all 4 channels being careful not to load any single channel below 2 ohm stereo. For typical 6" x 9" or 6.5" or component speaker installs, set the Crossover Mode Switches to Full Range.

4 Channel Amplifier Bridged to 2 Channels

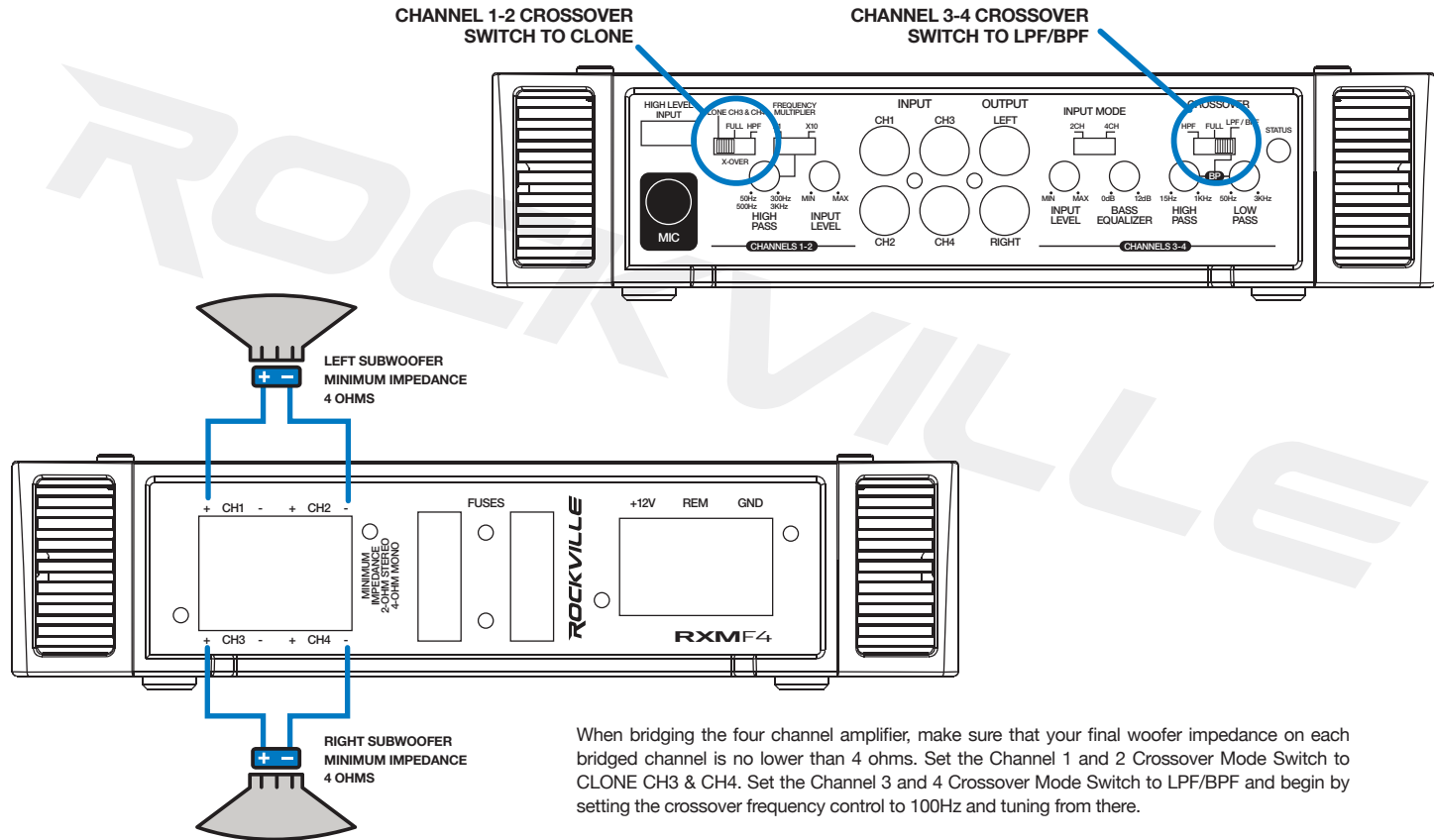

When bridging the four channel amplifier, make sure that your final woofer impedance on each bridged channel is no lower than 4 ohms. Set the Channel 1 and 2 Crossover Mode Switch to CLONE CH3 & CH4. Set the Channel 3 and 4 Crossover Mode Switch to LPF/BPF and begin by setting the crossover frequency control to 100Hz and tuning from there.

4 Channel Amplifier in 3 Channel Mode

Channels 1 and 2 should be wired to speakers no lower than 2 ohm loads per channel in stereo. Channel 3 and 4 should be bridged as per the diagram wiring the woofer to Channel 3 positive side (+) and Channel 4 negative side (-) terminals.

Set the crossover mode switch of Channels 1 and 2 to either Full Range or High Pass, while Channels 3 and 4 should be set to Low Pass.

Please see page 9 for RCA input configuration details and instructions when wiring a 3 channel system.

CROSSOVER MODE SWITCH IN FULL RANGE OR HIGH PASS POSITION

CROSSOVER MODE SWITCH IN LOW PASS POSITION

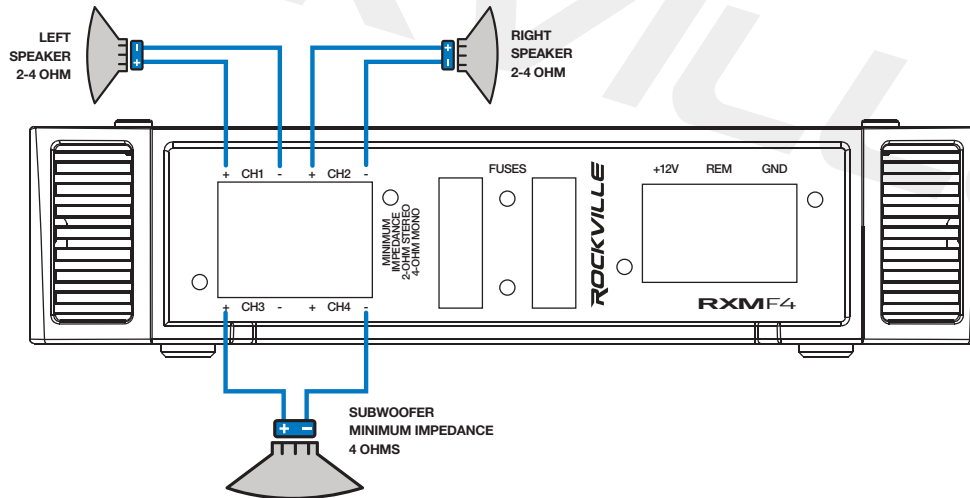
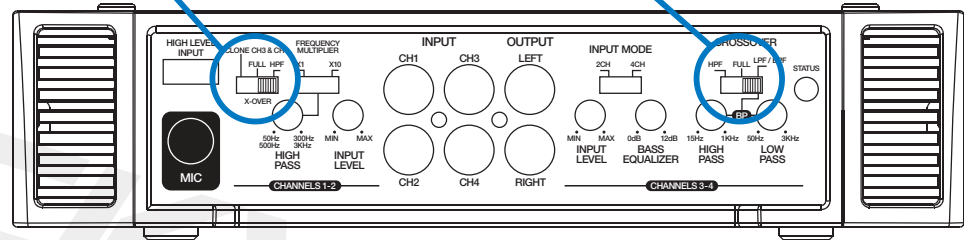

4 Channel with Mixed Mono

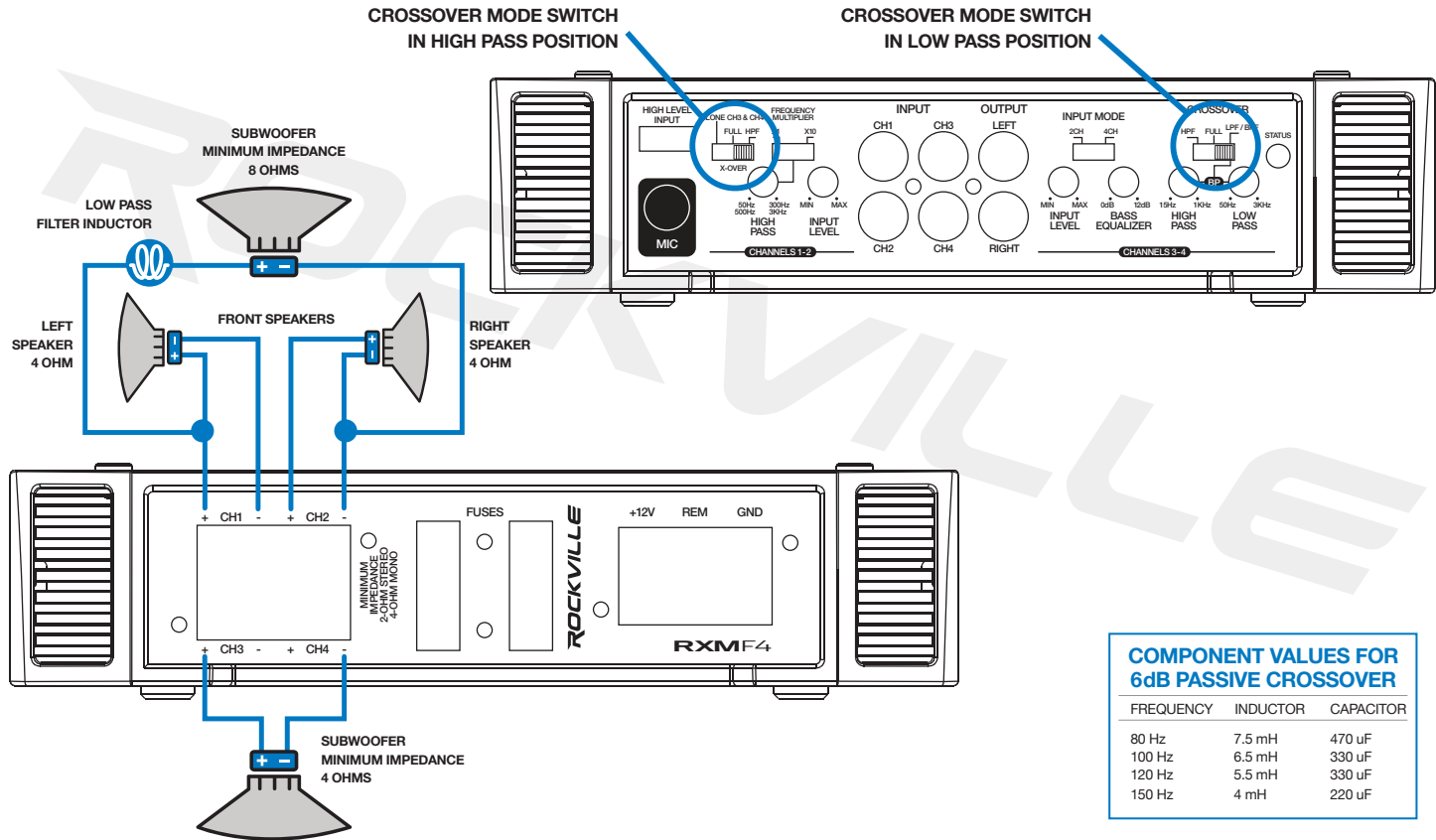

4 Channel with Dual Mixed Mono Configuration

SYSTEM A

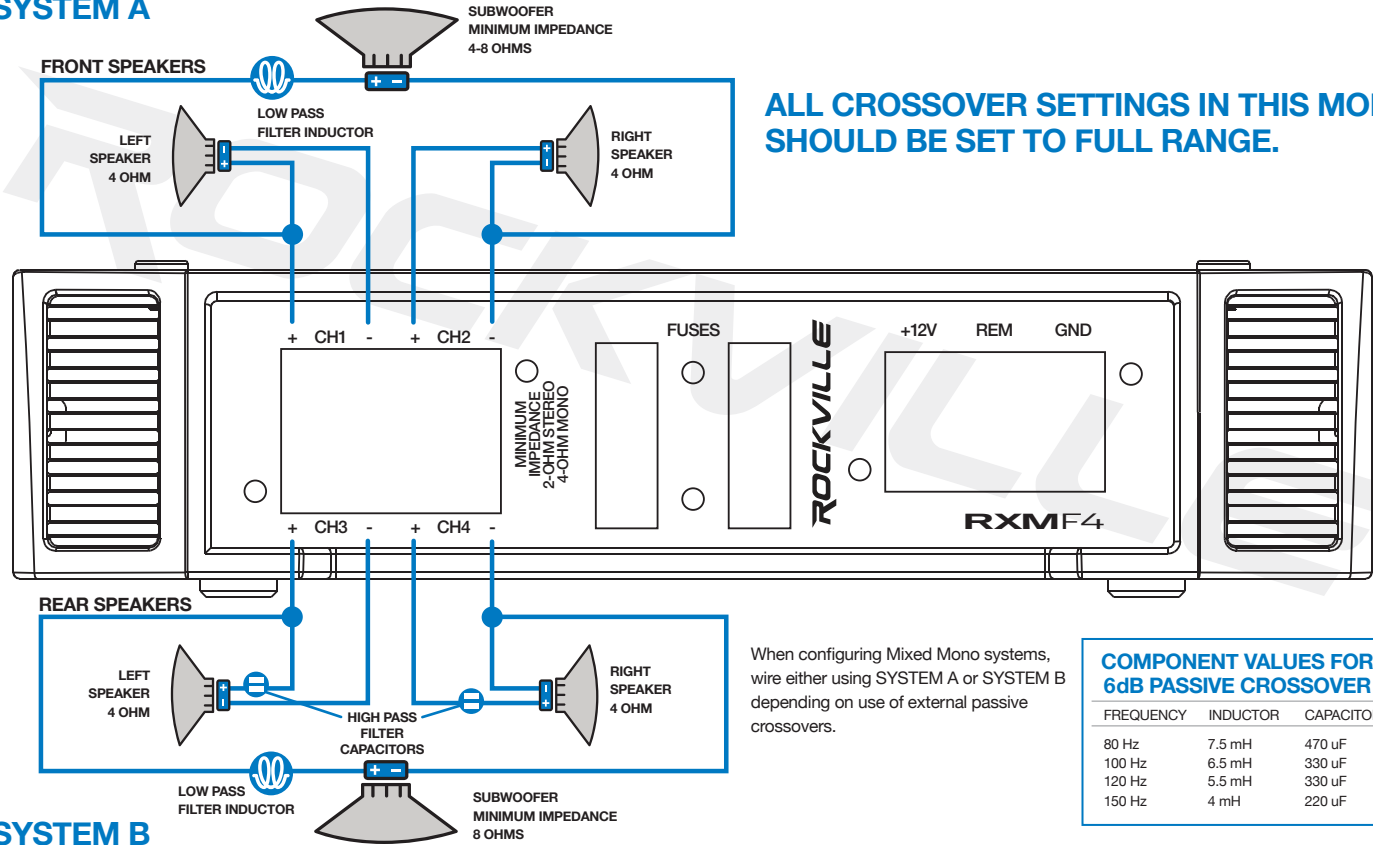

ALL CROSSOVER SETTINGS IN THIS MODE SHOULD BE SET TO FULL RANGE.

When configuring Mixed Mono systems, wire either using SYSTEM A or SYSTEM B depending on use of external passive crossovers.

COMPONENT VALUES FOR 6dB PASSIVE CROSSOVER

FREQUENCY	INDUCTOR	CAPACITOR
80 Hz	7.5 mH	470 uF
100 Hz	6.5 mH	330 uF
120 Hz	5.5 mH	330 uF
150 Hz	4 mH	220 uF

SYSTEM B

RXM F6 Channel Input Mode

If your head unit has one single pair of RCA outputs, input them in to the amplifiers Channel 1 and 2 input jacks and set the Input Mode Switch to 2Ch. The amplifiers preamp circuitry will automatically mix all the channels and output will occur on all 6 channels. There will be Left and Right balance with constant subwoofer but no Front to Rear Fader Control.

If your head unit has two pairs of RCA outputs, input Front Left and Front Right in to amplifier Channels 1 and 2 input jacks. Rear Left and Rear Right in to amplifiers Channels 3 and 4 input jacks. Set the Input Mode Switch to 4Ch. The amplifiers preamp circuitry will automatically mix all the channels and output will occur on all 6 channels. There will be Left and Right balance, Front to Rear Fader with constant subwoofer.

If your head unit has three pairs of RCA outputs, input Front Left and Front Right in to amplifier Channels 1 and 2 input jacks. Rear Left and Rear Right in to amplifiers Channels 3 and 4 input jacks. Subwoofer output in to Channel 5 and 6. If your head unit has only a single subwoofer output, use a Y adaptor to feed both Channel 5 and 6 inputs. Set the Input Mode Switch to 6Ch. The amplifiers preamp circuitry will automatically mix all the channels and output will occur on all 6 channels. There will be Left and Right balance, Front to Rear Fader with independent subwoofer.

2 CHANNEL MODE

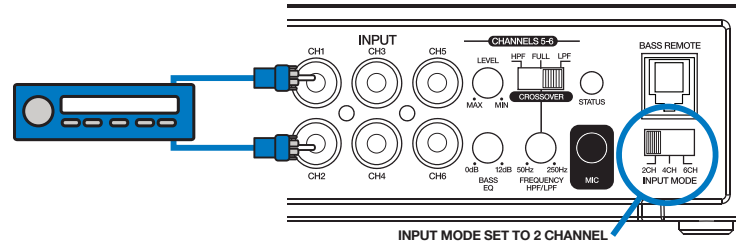

4 CHANNEL MODE

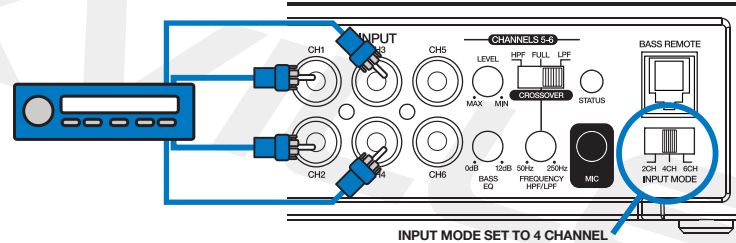

6 CHANNEL MODE

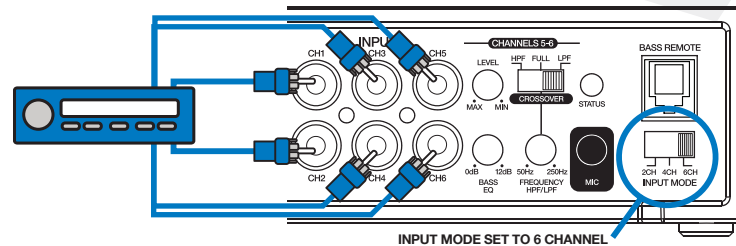

6 Channel Amplifier Speaker Wiring

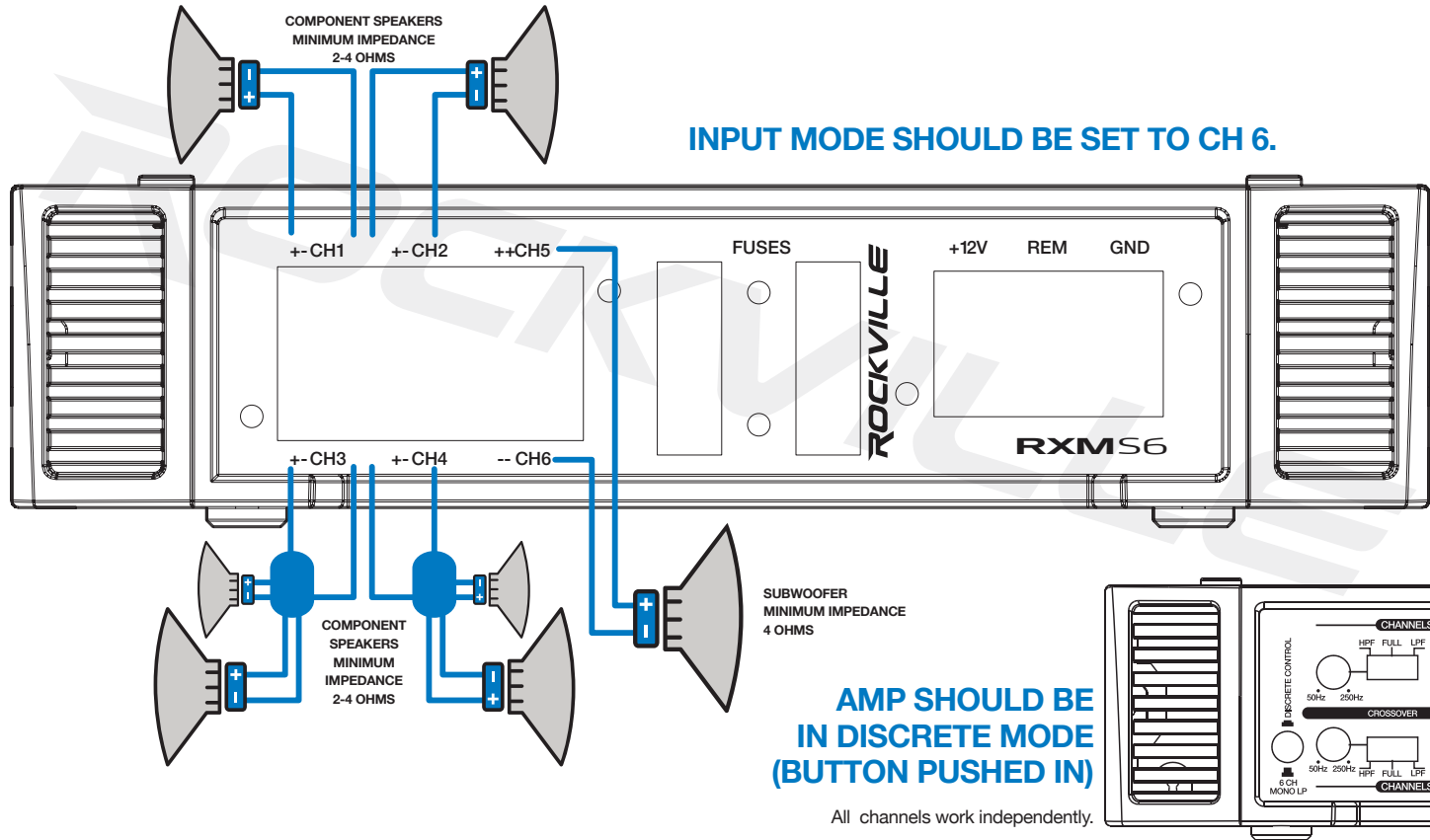

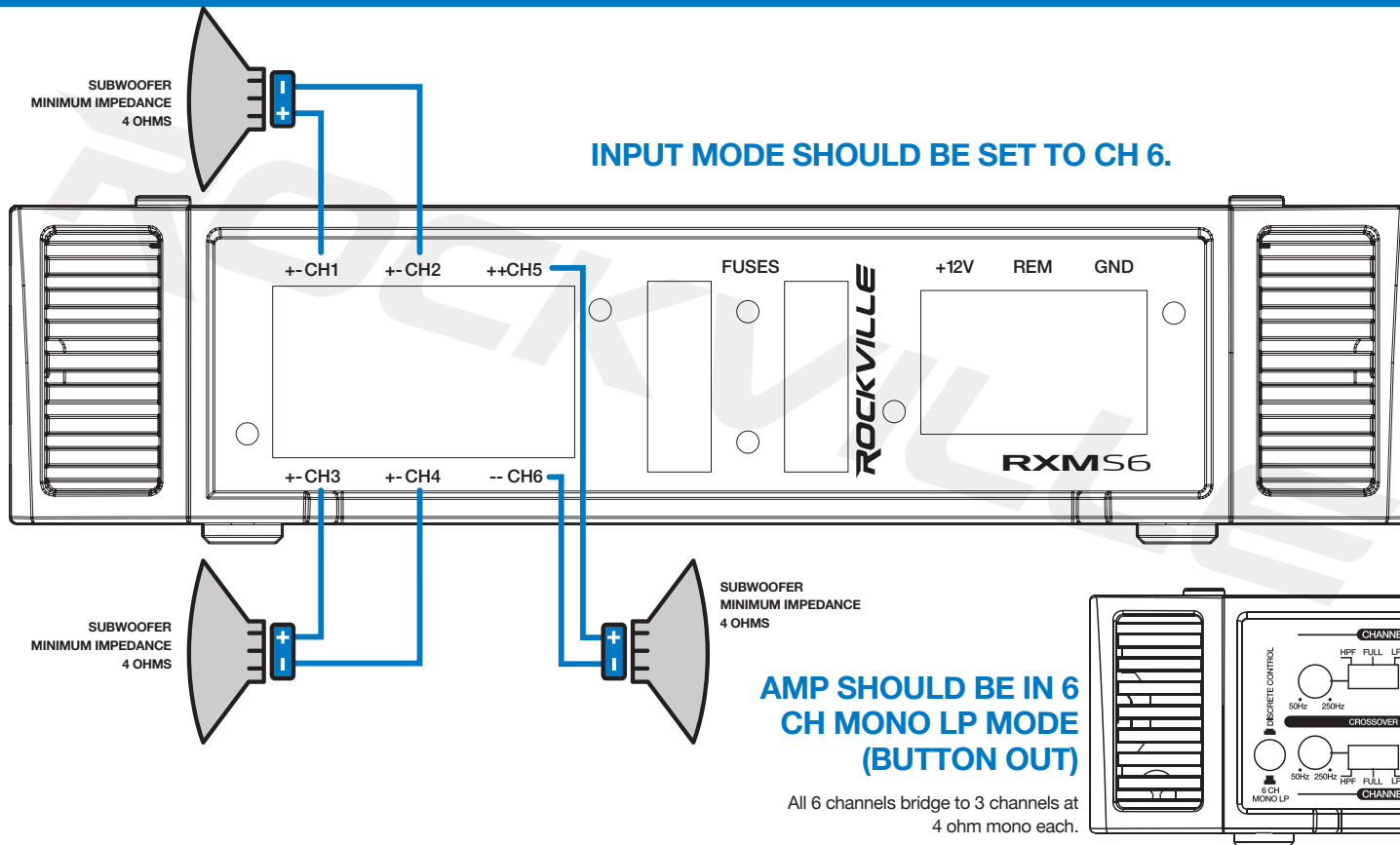

Class D Mono Block 1 Ohm Amplifier

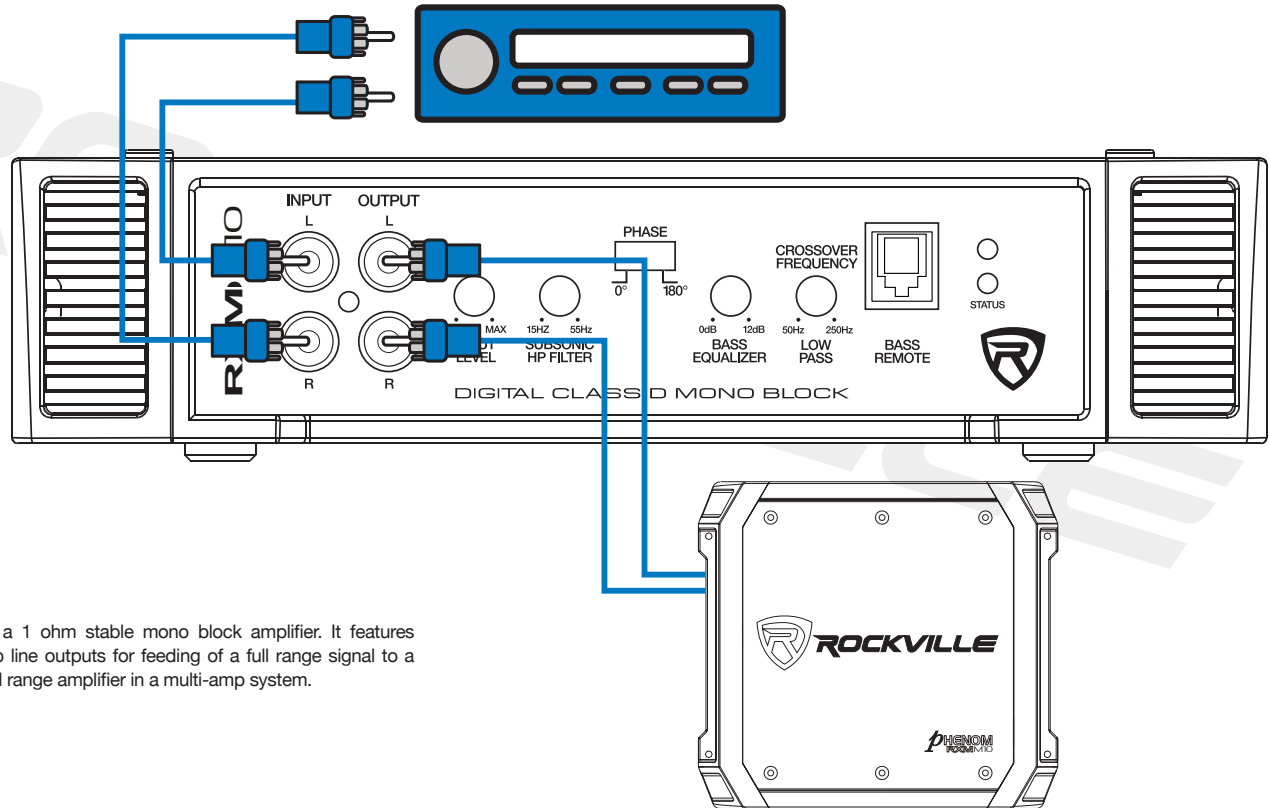

RXM-M10 is a 1 ohm stable mono block amplifier. It features RCA pre amp line outputs for feeding of a full range signal to a secondary full range amplifier in a multi-amp system.

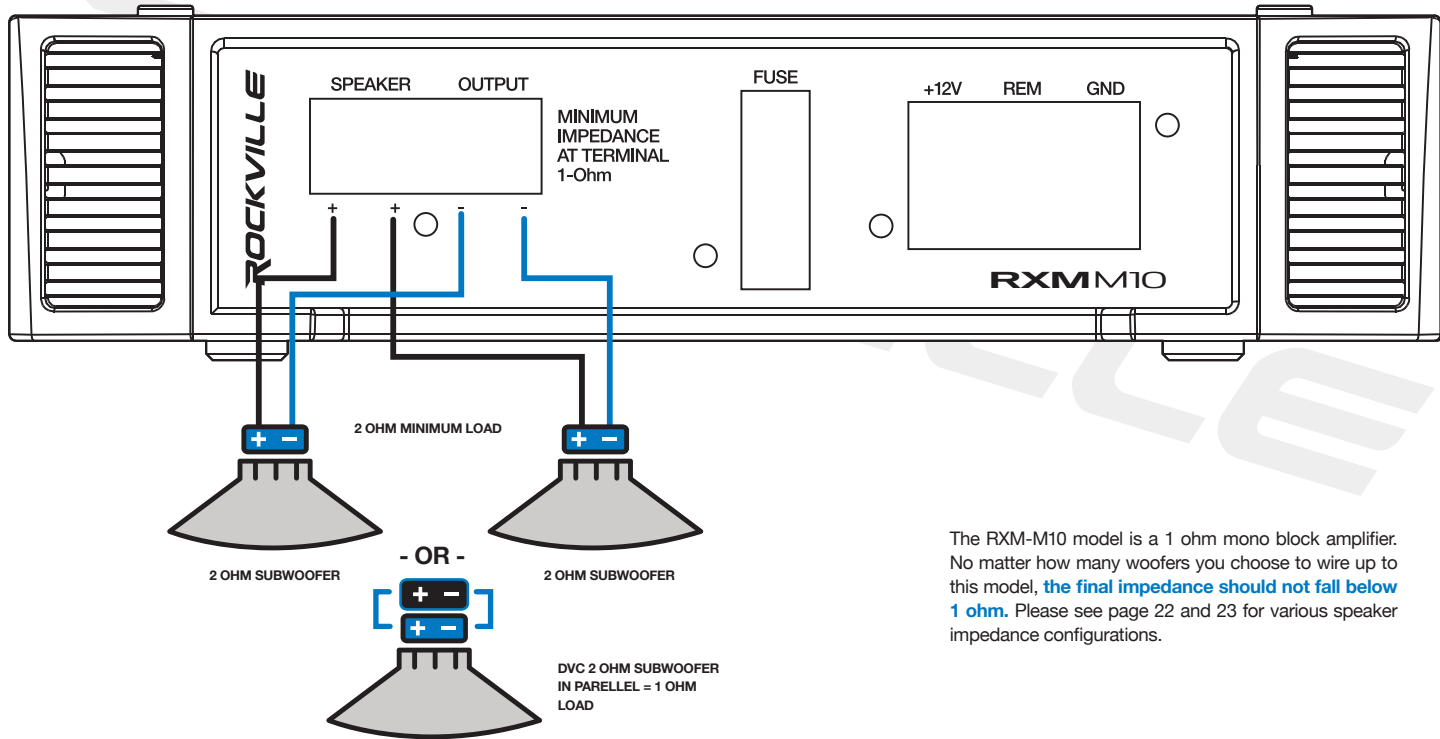

The RXM-M10 model is a 1 ohm mono block amplifier. No matter how many woofers you choose to wire up to this model, **the final impedance should not fall below 1 ohm**. Please see page 22 and 23 for various speaker impedance configurations.

Speaker Wiring Chart

**4 X DUAL VC 8 OHM
SPEAKERS WITH
VOICE COILS, ALL IN
PARALLEL**

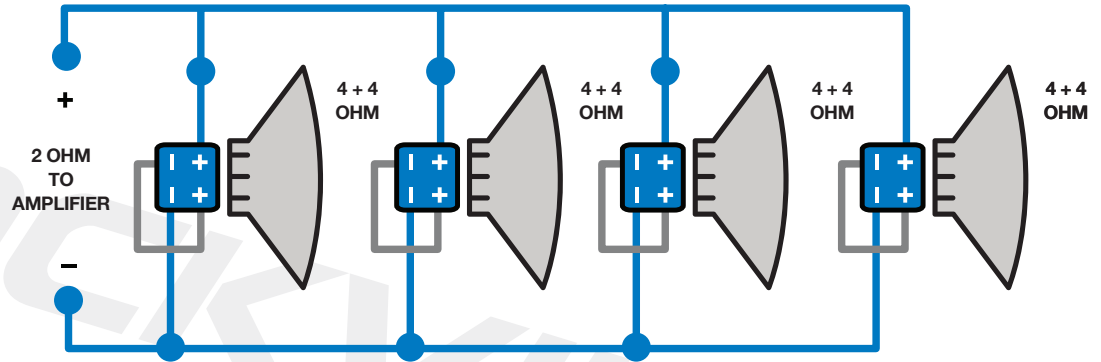

**SERIES:
SINGLE VOICE
COIL SPEAKERS**

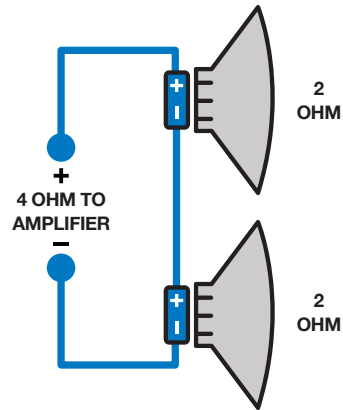

**PARALLEL:
SINGLE VOICE
COIL SPEAKERS**

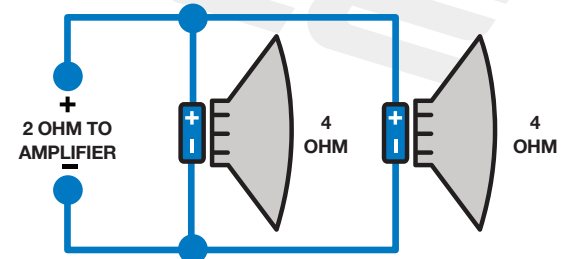

Speaker Wiring Chart

SERIES: DUAL VOICE COIL SPEAKERS

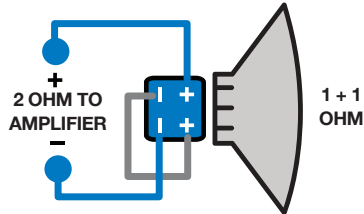
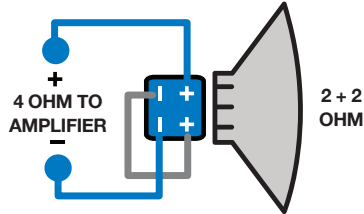
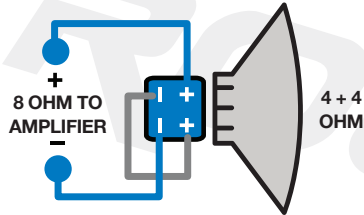

PARALLEL: DUAL VOICE COIL SPEAKERS

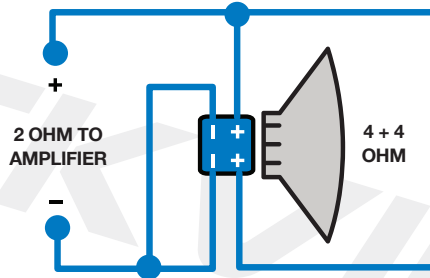

2 X DUAL VC 2 OHM SPEAKERS WITH VOICE COILS, ALL IN PARALLEL

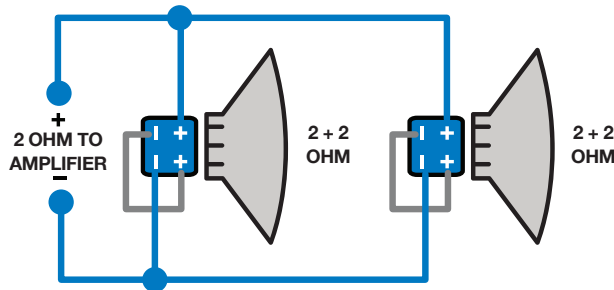

Please note that the minimum impedance load for single RX Phenom Series Amplifiers is 2 ohm stereo and 4 ohm mono bridged.

Lower impedance loads will cause overheating and may damage the amplifiers.

Do not mix different impedance speakers in series and / or parallel combinations, as unequal power sharing and acoustic outputs will result.

Specifications

RXM-S6 6 Channel Amplifier

- CEA Power Rating: 420 Watts (6 x 70 Watts) @ 4 Ohms and 1% THD+N
- RMS: 780 Watts (6 x 130 Watts) @ 4 Ohms and 1% THD+N
- RMS: 1300 Watts (6 x 220 Watts) @ 2 Ohms and 1% THD+N
- RMS: 3 x 440 Watts @ 4 Ohm Bridged Mono
- **Total System Peak Power: 2600 Watts**
- Minimum THD at Rated Power: < 0.05%
- Frequency Response: 10Hz - 40KHz
- S / N Ratio: > 100dB
- Damping Factor: > 200 @ 100Hz
- Dual 60 Amp Maxi Fuses
- Dimensions: (W x H x L) 8.6" x 2" x 16.1"
- High-Speed MOSFET Power Supply
- Studio-Grade Bipolar Output Stage Transistors
- Fully Adjustable 12dB / Octave Crossover with Differential Circuitry
CH 1 - 6 Low Pass 50Hz - 250Hz
High Pass 50Hz - 250Hz
- Fully Adjustable Bass Equalization Control
- 2 Ohm Stable Stereo
- 4 Ohm Mono Bridgeable
- 3 Channel Mono Capable @ 4 Ohm
- 2 CH / 4 CH / 6 CH Input Mode Selector
- ELNA Brand Audiophile Quality Capacitors
- Status Moded LED Indicator
- Mute and Delay Soft Start System
- Full IC-Controlled Protection Circuitry
- Remote Dashboard Subwoofer Control
- 8 Volt Preamp Circuitry



RXM-F4

- CEA Power Rating: 400 Watts (4 x 100 Watts) @ 4 Ohms and 1% THD+N
- RMS: 800 Watts (4 x 200 Watts) @ 4 Ohms and 1% THD+N
- RMS: 1200 Watts (4 x 300 Watts) @ 2 Ohms and 1% THD+N
- RMS: 2 x 600 Watts @ 4 Ohm Bridged Mono
- Peak Power: 2400 Watts
- Frequency Response: 10Hz - 40KHz
- Sensitivity: 100dB @ 1w / 1m
- Damping Factor: > 200 @ 100Hz
- Dual 40 Amp Maxi Fuses
- Dimensions: (W x H x L) 8.6" x 8" x 16.1"
- High-Speed MOSFET Power Supply
- Studio-Grade Bipolar Output Stage Transistors
- Fully Adjustable 12dB / Octave Crossover with Differential Circuitry
CH3 & CH4 Low Pass 50Hz - 3KHz
CH3 & CH4 High Pass 15Hz - 1KHz
CH1 & CH2 High Pass 50Hz - 300Hz
500Hz - 3KHz (x10)
- Crossover Band-Pass Control
- Fully Adjustable 12dB Bass Equalizer
- 2 Ohm Stable Stereo
- 4 Ohm Mono Bridgeable
- 3 Channel Mixed-Mono Capable
- Mute and Delay Soft Start System
- High Level Input with Smart Auto Turn-On
- Full IC-Controlled Protection Circuitry
- 2 CH / 4 CH Input Mode Switch
- RCA Preamp Line Output
- ELNA Brand Audiophile Capacitors
- 8 Volt Preamp Circuitry
- Status Mode LED Indicator



RXM-F3

- CEA Power Rating: 260 Watts (4 x 65 Watts) @ 4 Ohms and 1% THD+N
- RMS: 800 Watts (4 x 200 Watts) @ 2 Ohms
- RMS: 2 x 400 Watts @ 4 Ohm Bridged Mono
- Peak Power: 1600 Watts
- Minimum THD at Rated Power: <0.05%
- Frequency Response: 10Hz - 40KHz
- Sensitivity: 100dB @ 1w / 1m
- Damping Factor: > 200 @ 100Hz
- Three 20 Amp Maxi Fuses
- Dimensions: (W x H x L) 8.6" x 2" x 13.7"
- High-Speed MOSFET Power Supply
- Studio-Grade Bipolar Output Stage Transistors
- Fully Adjustable 12dB / Octave Crossover with Differential Circuitry
 - CH3 & CH4 Low Pass 50Hz - 3KHz
 - CH3 & CH4 High Pass 15Hz - 1KHz
 - CH1 & CH2 High Pass 50Hz - 300Hz
 - 500Hz - 3KHz (x10)
- Crossover Band-Pass Control
- Fully Adjustable 12dB Bass Equalizer
- 2 Ohm Stable Stereo
- 4 Ohm Mono Bridgeable
- 3 Channel Mixed-Mono Capable
- Mute and Delay Soft Start System
- High Level Input with Smart Auto Turn-On
- Full IC-Controlled Protection Circuitry
- 2 CH / 4 CH Input Mode Switch
- RCA Preamp Line Output
- ELNA Brand Audiophile Capacitors
- 8 Volt Preamp Circuitry
- Status Mode LED Indicator



Specifications

RXM-M10

- CEA Power Rating: 1 x 300 Watts @ 1 Ohm and 1% THD+N
- RMS: 1 x 600 Watts @ 1 Ohm and 1% THD+N
- Peak Power: 1 x 1200 Watts @ 1 Ohm
- Minimum THD @ Rated Power: <0.05%
- Frequency Response: 10Hz - 500KHz
- Sensitivity: 100dB @ 1w / 1m
- Damping Factor: > 220 @ 100Hz
- 50 Amp Maxi Fuse
- Dimensions: (W x H x L) 8.6" x 2" x 9.4"
- High-Speed MOSFET Power Supply
- Studio-Grade Bipolar Output Stage Transistors
- Fully Adjustable 12dB / Octave Crossover with Differential Circuitry Low Pass 50Hz - 250Hz
- Subsonic Filter 15Hz - 55Hz
- Fully Adjustable 12dB Bass Equalizer
- RCA Preamp Line Output
- Phase Control Switch
- Mute and Delay Soft Start System
- Full IC-Controlled Protection Circuitry
- Remote Dashboard Subwoofer Control
- Now exclusively with "Professional Peak limiter Circuitry" which guarantess distortion free musical playback at all levels.
- 8 Volt Preamp Circuitry
- Status Mode LED Indicator



RXM-T1

- CEA Power Rating: 250 Watts (2 x 125 Watts) @ 4 Ohms and 1% THD+N
- RMS: 500 Watts (2 x 250 Watts) @ 4 Ohms <1% THD+N
- RMS: 750 Watts (2 x 375 Watts) @ 2 Ohms and 1% THD+N
- RMS: 1 x 750 Watts @ 4 Ohms Bridged Mono
- Peak Power: 1500 Watts (2 x 750 @ 2 Ohms or 1 x 1500 @ 4 Ohms)
- Minimum THD @ Rated Power: <0.05%
- Frequency Response: 10Hz - 40KHz
- Sensitivity: 100dB @ 1w / 1m
- Damping Factor: > 200 @ 100Hz
- 50 Amp Maxi Fuse
- Dimensions: (W x H x L) 8.6" x 2" x 13"
- High-Speed MOSFET Power Supply
- Studio-Grade Bipolar Output Stage Transistors
- Fully Adjustable 12dB / Octave Crossover Low Pass 50Hz - 250Hz High Pass 15Hz - 250KHz
- Fully Adjustable 12dB Bass Equalizer with Differential Circuitry
- 2 Ohm Stable Stereo
- 4 Ohm Mono Bridgeable
- Mute and Delay Soft Start System
- High Level Input with Smart Auto Turn-On
- Full IC-Controlled Protection Circuitry
- RCA Preamp Line Output
- ELNA Brand Audiophile Capacitors
- 8 Volt Preamp Circuitry
- Status Mode LED Indicator





ROCKVILLE

ROCKVILLE

ROCKVILLE



ROCKVILLE

Features and specifications subject to change and or improvement without notice.
Though we tried our best to ensure that this manual is free and clear of errors please don't hold us responsible for printing errors.

Copyright 2015
RockvilleAudio.com