PACKAGING, LABELING AND SHIPPING GUIDELINES

For Shipments to Buyer, Buyer's Subcontractor or Logistics Provider, or Non-U.S. Government Customers, or for Direct Shipment to a "Designated Recipient" on a Commercial Packing Sheet

PM-5010K

February 4, 2015

Fort Worth, TX



Marietta, GA



Palmdale, CA



REVISION RECORD

PM-5010J SECTIONS REVISED	DESCRIPTION	REVISION
Cover Page	Added the words "Logistics Provider."	K
2.4 & 2.5	Added parenthesis to clarify polyethylene bag must be rust preventative.	K
2.6	Added: "Examples below are minimum requirements."	K
2.7	Removed staples as an acceptable method for sealing bags.	K
3.3	Clarified title and that each package of parts shall have a label attached to each package with buyer's PO and part number.	K
3.4	Added: "For hazardous materials requirements see section 9.6."	K
4.1	Added "Seller may use staples to construct fiberboard containers."	K
5.1	Added supply chain security assessment requirement for unique containers.	K
6.1	Added: "If "Supplier Provided" option is used in TMS, the Seller must utilize only approved Lockheed Martin commercial carriers."	K
6.2	Added "LM" to PO Number, Line Item , and Part Number to insure suppliers provide LM PO info on packing sheet.	K
6.2	Added "Ship To" address on packing sheet should be as exactly shown in LM PO including, for example, "Attn:" address line items.	K
8.1	Updated section to clarify requirements and RFID label location placement.	K
8.2.1	Added it is acceptable to print bar code labels on non-adhesive backed paper.	K
8.2.1.4	Added graphic to show RFID label placement requirements.	K
8.2.2	Added this section only applies to those not on-boarded to TMS.	K
9.5.1	Added PM-4043 Electrostatic Discharge document reference.	K
9.6	Clarified HAZMAT packing requirements.	K
10.2	Clarified Center of Gravity location should be provided by engineering.	K
11.0	Added Supply Chain Security as its own section. Completely rewritten.	K
12.0	Changed to section 13.	K
13.0	Changed to section 14.	K
14.0	Changed to section 15. Updated Palmdale address.	K
Revised by: Craig Spyhalski		

TABLE OF CONTENTS

Document Note: All Section Heads in the Table of Contents are hotlinks. Click on any Section Head and your page view will shift to that section of the document. Additionally all websites listed are hotlinks. Click on a specific website and you will be taken to the online location listed.

- 1.0 OVERVIEW** 7
 - 1.1 Strategic Intent
 - 1.1.1 Returnable Reusable Solutions
 - 1.1.2 Radio Frequency Identification (RFID) Data
 - 1.2 Purpose of PM-5010
 - 1.3 Scope of Compliance
 - 1.4 Communications in English
 - 1.5 Measurements and Standards in English

- 2.0 PACKAGING – BASICS** 8
 - 2.1 Minimum Container/Surface Size
 - 2.2 Irregularly Shaped Containers
 - 2.3 Box Selection
 - 2.4 Specialized Bagging Requirements
 - 2.5 Rust Prevention Requirements
 - 2.6 Sealing A Box
 - 2.7 Sealing A Bag - Shipped in Corrugated Box

- 3.0 PACKAGING – PARTS** 12
 - 3.1 General Standards
 - 3.2 Buyer Procured Tooling
 - 3.3 Mechanical and Electrical Hardware and Other Small Parts
 - 3.4 Carton Consolidation
 - 3.5 Raw Stock
 - 3.5.1 Raw Stock – Skid Design
 - 3.5.2 Raw Stock – Preparation
 - 3.5.3 Raw Stock – Packaging
 - 3.5.4 Raw Stock – Identification

- 4.0 SHIPPING CONTAINERS – GENERAL** 18
 - 4.1 Overview
 - 4.2 Regulated WPM
 - 4.3 Non-Regulated WPM
 - 4.4 Reusable
 - 4.5 Standard

Table of Contents - continues

TABLE OF CONTENTS (continued)

5.0 SHIPPING CONTAINERS – UNIQUE	19
5.1 Unique Containers	
5.2 Conditions for Unique Design/Transportability	
5.2.1 Conditions for Unique Design/Transportability	
5.2.2 Shipping Long Items	
5.3 Waterproof Barriers	
5.4 Undesired Packaging Materials	
5.5 Desired Packaging Materials	
6.0 SHIPMENTS	21
6.1 How To Route Shipments	
6.2 Packing Sheets	
6.3 Classified Shipments	
6.4 Communications Security (COMSEC) Shipments	
7.0 MARKING - GENERAL	23
7.1 Containers	
7.2 Labels - General	
7.2.1 Minimum Size	
7.2.2 Label Material	
7.3 Hang Tags	
7.4 Electrostatic Discharge (ESD) Sensitive - Labels	
7.5 Open Immediately/Mixed Box/Remove All Items - Labels	
7.6 Material Safety Data Sheet (MSDS) Information	
7.7 Cadmium Warning Labels	
7.8 Special Labels or Markings	
7.9 Material Review Board (MRB) Items	
7.10 Exterior of Reusable/Returnable Container	
8.0 MARKING - LABELS	26
8.1 Radio-Frequency Identification (RFID) Tag	
8.1.1 Passive RFID Tag Requirements for Non-IUID Shipments Using TMS	
8.1.2 Affixing Passive RFID Tags	
8.1.2.1 Data Syntax and Standards	
8.1.2.2 Advance Shipment Notice (ASN) Requirements	
8.1.3 Tag Requirements	
8.1.4 RFID Tag Construction Standards	
8.1.5 Sourcing Passive RFID Tags	

Table of Contents - continues

TABLE OF CONTENTS (continued)

8.2	Receiving Labels	
8.2.1	Generated by TMS	
8.2.1.1	Transportation Handling Unit (THU) Label	
8.2.1.2	ASN Receipt Label	
8.2.1.3	Additional Carton Label	
8.2.1.4	Label Placement Examples	
8.2.2	Generated by Bar Code Generator	
8.2.2.1	Bar Code Data Elements for a Standard PO	
8.2.2.2	Bar Code Data Elements for eCAT	
8.2.2.3	Bar Code Data Elements for JSF TFE	
8.3	Examples of Label Placement - Odd Shaped Shipments	
9.0	SPECIAL HANDLING	38
9.1	Age Sensitive Items	
9.2	Temperature Sensitive Marks	
9.3	Composite Parts Protection	
9.4	Machined Parts Protection	
9.5	Electrostatic Discharge (ESD) Sensitive - Items	
9.5.1	Additional Information on ESD	
9.6	Hazardous Materials/Dangerous Goods Packaging	
9.6.1	Certification/Permits	
9.6.2	Classification	
9.6.3	Closure/Tests Instructions	
9.6.4	Explosives	
9.6.5	Hazard Class Labels	
9.6.5.1	Hazard Class Labels - Minimum Sizes	
9.7	High Risk Shipments	
10.0	SPECIAL HANDLING SYMBOLS	47
10.1	General Symbols	
10.2	Stacking Safety Symbols	
10.3	Lifting Safety Symbols	
10.4	Environmental Transportation Symbols	
10.5	Time Sensitive Contents Symbols	

Table of Contents - continues

TABLE OF CONTENTS (continued)

11.0	<u>SUPPLY CHAIN SECURITY</u>	51
11.1	Ensuring Supply Chain Security	
11.2	Container and Trailer Security	
11.3	Ocean Container and Truck Trailer Storage	
11.4	Security and Control of Container and Trailer Seals	
12.0	<u>APPLICABLE DOCUMENTS</u>	54
12.1	Materials	
12.2	Military Standards	
12.3	Industrial Manuals	
12.4	Other	
13.0	<u>DEFINITIONS</u>	55
14.0	<u>ACRONYMS</u>	56
15.0	<u>ADDRESSES</u>	57
	<u>SUPPLEMENT A:</u>	58
	F-35 Additional Packaging, Labeling and Shipping Guidelines	
	<u>SUPPLEMENT B:</u>	64
	F-16 Additional Packaging, Labeling and Shipping Guidelines	
	<u>SUPPLEMENT C:</u>	67
	F-22 Additional Packaging, Labeling and Shipping Guidelines	
	<u>SUPPLEMENT D:</u>	69
	Returnable Reusable Containers and Fixtures (RRCF)	

1.0 OVERVIEW

1.1 Strategic Intent

Lockheed Martin Aeronautics is committed to improving packaging and handling efficiencies and is aggressively expanding the utilization of:

- Returnable reusable container and fixture solutions
- RFID data technologies

1.1.1 Returnable Reusable Solutions

Every packaging initiative should strive to maximize part protection and transit flexibility, while minimizing its cost and carbon footprint. If required per the Purchase Order, the Seller shall look to deliver parts in returnable reusable containers that:

- Are easily accessible
- Are stackable
- Are collapsible and/or nestable when emptied
- Maximize reusability

1.1.2 Radio Frequency Identification (RFID) Data

RFID is an automatic identification and data capture technology comprised of one or more reader/interrogators and one or more radio frequency transponders. Data transfer is achieved by means of suitably modulated inductive or radiating electromagnetic carriers. Passive RFID tags operate without a separate external power source and obtain operating power generated from the reader. Lockheed Martin (LM) is committed to RFID implementation (reference section 8.1).

1.2 Purpose of PM-5010

The purpose of this document is to set out the requirements and establish guidelines for the packaging, marking, handling, preservation, and shipping for all shipments or drop shipments by Seller and by Seller's subtiers. These guidelines apply to all production and sustainment initiatives for shipments to non-U.S. Government locations. Seller shall always preserve and package material and equipment in accordance with good commercial practice, and as suggested herein, such as to afford the degree of protection necessary to prevent deterioration or damage during shipment under normal environmental conditions and commercial modes of transportation.

1.3 Scope of Compliance

These instructions supplement the Purchase Order ("PO") and establish the packaging, marking, handling, preservation, and shipping guidelines for all shipments or drop shipments by Seller and by Seller's subtiers at all tiers to FORT WORTH, MARIETTA, or PALMDALE; or other Lockheed Martin (LM) facilities; or to a third-party logistics provider (3PL); or other Lockheed Martin (LM) Customers as directed by Buyer, or other Supplier (other than Seller), or subcontractor, or Buyer's non-U.S. Government Customers on a commercial packing sheet. Seller shall inform each of its subtiers, making any shipment to other than Seller, of this PM-5010 protocol.

(Note: In this document, the term PO is interchangeable with the word "Contract"; and the term "Buyer" is interchangeable with the term "LOCKHEED MARTIN").

1.4 Communications in English

Seller shall transmit all communications, data, drawings, messages and correspondence in the English language.

1.5 Measurements and Standards in English

Seller shall submit all standards and costs in U.S. units of measure (i.e. all drawings are to be dimensioned in inches).

2.0 PACKAGING – BASICS

Polyethylene (poly) bags can be used for interior packaging to individually package parts, which are to be placed inside a corrugate carton. Poly bags are the preferred method for small parts with very basic structures that are durable (e.g. nuts, trim clips, small brackets, etc.). Chipboard or corrugated boxes must be used for small parts when a higher degree of protection for more complex structures is needed. While regular inventory turn is the norm, exceptions occur and any individual package may be stored for an extended period of time. It is required that the packaging utilized provide the necessary long-term protection along with the lowest costs.

2.1 Minimum Container/Surface Size

The minimum allowable container size shall be 5 inches high by 5 inches wide by 1 inch deep. Flat containers such as envelopes, bags, etc. shall have a surface area minimum of 30 square inch bounded by dimensions of 5 inch by 6 inch to ensure that a shipment label can be attached without wrapping around the container. Adequate area must be maintained to allow the printing or the application of a ship to address on all packages, containers or envelopes.

2.2 Irregularly Shaped Containers

Containers which are irregularly shaped, are cylindrical in nature, or have no flat plane surface shall have labels applied in such a manner which places the read direction of the bar code running along the longitudinal axis of the surface.

2.3 Box Selection

Box types include chipboard boxes and corrugate cartons.

Box Type:

- **Single-Wall Corrugated Chipboard (c-flute)** is recommended for lightweight parts
- **Double-Wall Corrugated Cardboard (b+c flute)** is required for larger/heavier parts



Single-Wall Corrugated Chipboard

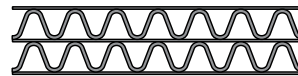

Double-Wall Corrugated Chipboard

Strength:

A box should: 1) Withstand the rigors of the shipping process. 2) Have the strength to properly protect the contents. 3) Ensure stacking at least five layers high in transit. All corrugate cartons are required to be at least 32 ECT Test material. Depending on the part application, some cartons may exceed this standard. All cartons must carry the box manufacturer's certificate detailing its specifications. In addition, all cartons must be at least double-faced, single-wall corrugate. However, double-wall corrugate will be required for large, heavy parts (i.e. windshields and certain sheet metal parts). All carton joints should be glued or stitched.

Density:

Use cartons efficiently. It is recommended that the part density not be less than 80% of the overall density of a packed carton. If carton uses pallet, include size and weight of pallet in calculations.

Formula for Calculating Density: Divide the weight of the carton/pallet by the number of cubic feet.

Dunnage:

If applicable, dunnage will be required to prevent part movement within the carton. However, the use of newsprint and loose-fill (packing peanuts) is not allowed. Interior corrugate, polyethylene and/or polystyrene inserts may be used to support the part and minimize part movement. Corrugated partitions or dividers may be required to provide cells for fragile items.

2.4 Specialized Bagging Requirements

For the following part types, use the associated bagging requirements:

Part Type	Bagging Requirement
Parts that require rust protection if not already rust protected on part surface.	A rust preventative Volatile Corrosive Inhibitor (VCI) paper (or clear polyethylene bag) is required. Or use emitters as necessary to protect parts for up to 36 months in storage.
No rust protection required, but damage potential exists if poly bag is used.	A laminated bag is recommended, if available. If laminated bag is not available, a chipboard box or a corrugate carton should be used.
Comparatively heavy parts. (parts over 5 lbs)	A polyethylene bag of at least 4 mil, plus a reinforcing fiberboard is required.

2.5 Rust Prevention Requirements

The following should be used to determine the appropriate rust prevention treatment.

Examples of Parts Requiring Rust Prevention	Requirement
Small parts without plating. (e.g. bolt, nut, washer)	Rust preventative paper bag (or poly bag).
Metal or non-metal parts.	Rust preventative airtight paper or polyethylene bag.
Parts processed by machine. Specified items.	Rust preventative oil (dipping method) and airtight poly bag.
Wires, hinges, etc.	Grease
Casting parts, springs.	Rust preventative coating.

Note: Overall or partial rust prevention is to be determined on an item-by-item basis.

2.6 Sealing A Box

Pressure sensitive clear 2" wide PVC or reinforced gummed tape is preferred. Paper sealing tape is not acceptable. All tape must extend a minimum of 2" beyond the width of the flaps for sealing onto the carton sides. While clear sealing tape is preferred, the weight of the part inside may require the carton be sealed with reinforced gum tape. Examples below are minimum requirements.

EXAMPLES: CORRUGATED BOX PACKAGING

Regular Slotted Container (RSC)

Contents under 5 lbs

1 Strip of tape

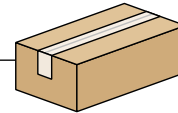
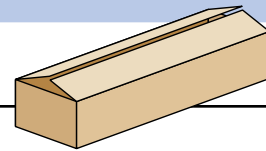

Contents over 5 lbs

2 Strips of tape at right angles

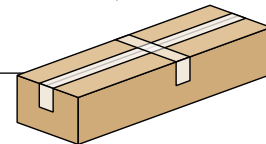

Full-Overlap Container

Contents under 5 lbs

1 Strip of tape lengthwise

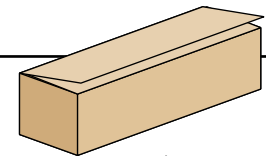

Contents over 5 lbs

3 Strips of tape

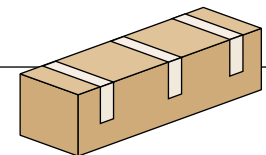

**Tuck Folder
 (ONLY FOR PARTS 5 LBS OR LESS)**

Width is less than 12"

1 Strip of tape

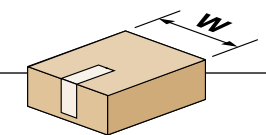
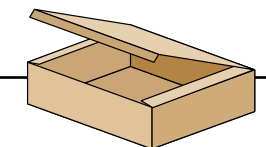

Width is greater than 12"

2 Strips of tape

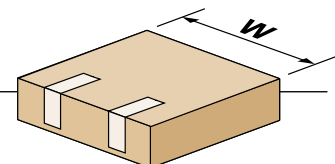

2.7 Sealing A Bag - Shipped in Corrugated Box

Heat sealing and adhesive tape are acceptable for sealing plastic bags. Stapling is not acceptable.

EXAMPLES: TWO METHODS OF PROPERLY SEALING CLEAR POLYETHYLENE BAG

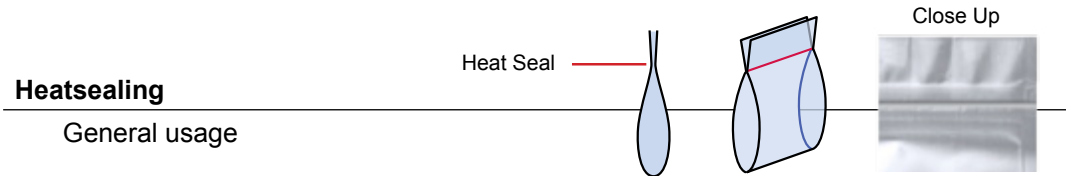

Note: Rust preventive polyethylene bag is restricted to this method

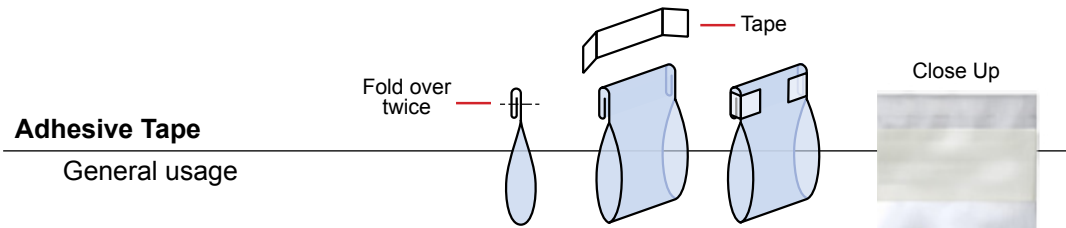

Note: Tape should wrap around sides at least 1"

3.0 PACKAGING – PARTS

3.1 General Standards

Seller shall preserve, package and pack material and protection necessary to prevent deterioration or damage during shipment, under normal environmental conditions and commercial modes of transportation. See sections 9.3 and 9.4.

3.2 Buyer Procured Tooling

Seller shall follow the Buyer Procured Tooling shipping and packaging requirements specified in the PM-4053 Tooling Manual (Ref. Sec. 3.16.4 & 3.16.5). Access to the PM-4053 Tooling Manual can be made upon request to the Buyer or Co-Production Support Dept.

3.3 Mechanical and Electrical Hardware and Other Small Parts

Seller shall package hardware type items (i.e. O-rings, gaskets, seals, nuts, bolts, terminal lugs, electrical contacts/sockets/splices and other small parts) in packages of no more than 100 pieces per package. Seller shall apply a label on each package including each intermediate package depicting the quantity inside and the Buyer's PO and part number. Additionally, each individually packaged part must have a label with the Buyer's PO and part number affixed to the outside of the package or enclosed and clearly visible within a transparent package.

Package rivets and other parts that have a unit of measure of pounds shall be packaged in one-pound packages. Any package quantities already established between Buyer and Seller shall continue unless a change in quantities is incorporated into the PO. Seller shall not exceed container weight limits. When shipping small, heavy, hardware-type parts, Seller shall use appropriate packaging material and containers to protect the hardware and prevent distortion and splitting of carton sides. Whenever multiple pieces make up one part (e.g. a resistor, a washer and a nut), Seller shall package assembly into one bag/carton. Seller shall accumulate bags/cartons into multiples of 25. If the quantity is less than 25 Seller shall accumulate into one container.

3.4 Carton Consolidation

Carton consolidation is acceptable per the following guidelines:

- Multiple cartons may be used for one P.O. line item and consolidated into one Transportation Handling Unit (THU) as long as proper labeling is applied per section 8.2.
- Consolidating multiple P.O. line items into one THU is acceptable but each P.O. line item must be properly packaged and enclosed within its own carton. There may be multiple parts per carton but all parts must be of the same P.O. line item and properly protected.
- For hazardous materials requirements see section 9.6.

Example #1: Multiple Cartons

Seller shall affix the appropriate Receiving Labels (as required by section 8.2 Receiving Labels) to the outside of each carton.

Seller shall consolidate multiple cartons (including multiple POs) into a single shipping container (Transportation Handling Unit -THU). Seller shall mark the THU "Contains multiple bar coded line items inside box".

Seller shall place THU label and packing sheet for each individual line item on the outside of the THU. Seller shall apply the "Mixed Box" label (see section 7.5) to the exterior of any boxes that contain multiple part types or line items inside a multipack carton.

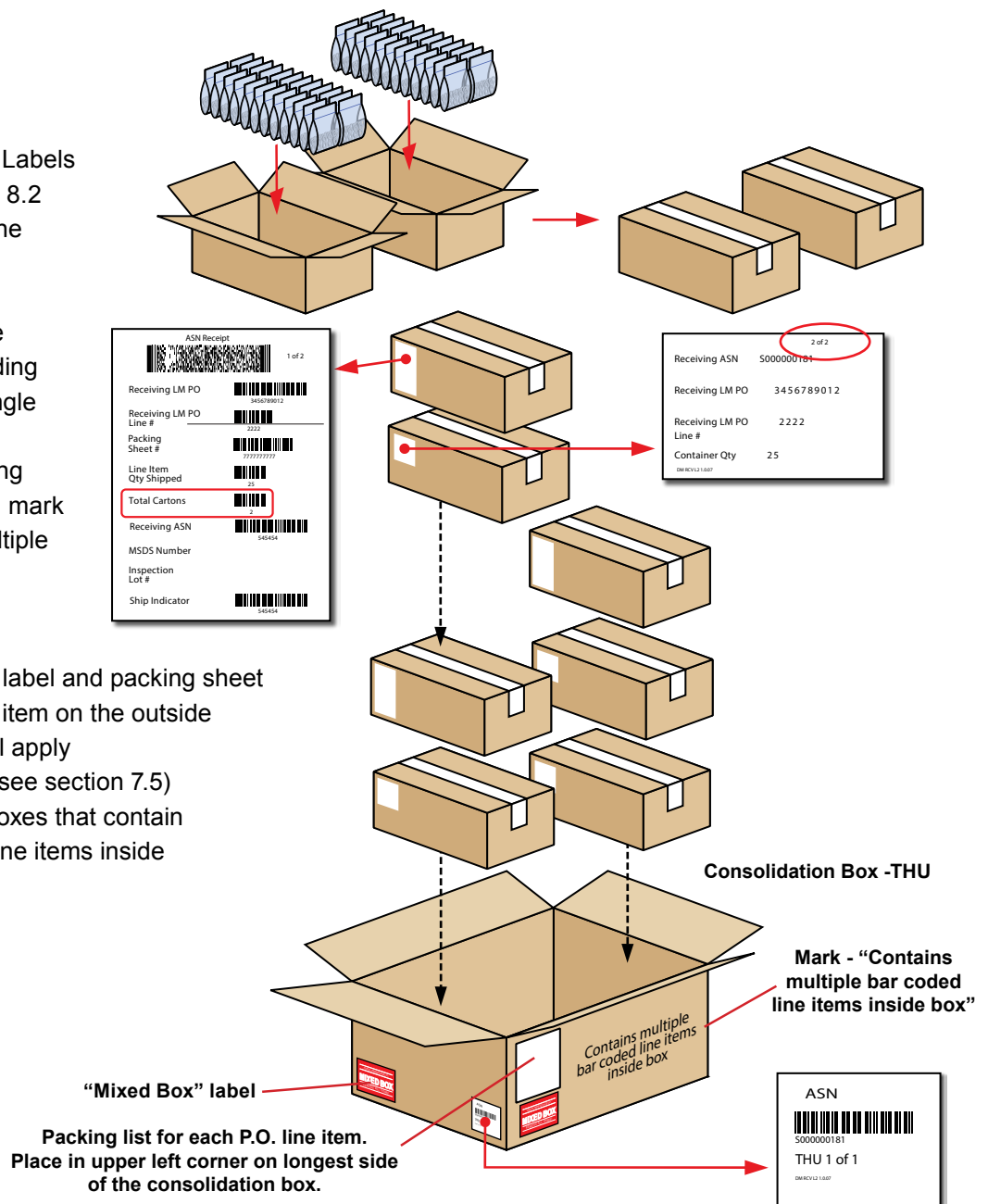

**Example #2:
 Machined or Composite Parts**

When consolidating cartons with a machined part (or composite part), the part must be properly protected (per section 9.4).

Seller shall affix the appropriate Receiving Labels (as required by section 8.2 Receiving Labels) to the outside of each carton.

Seller shall consolidate cartons (including multiple POs) into a single shipping container (Transportation Handling Unit -THU). Add packaging materials to avoid excessive movement of contents.

Do not use loose-fill packing materials.

Seller shall mark the THU
 "Contains multiple bar coded line items inside box".

Seller shall place THU label and packing sheet for each individual line item on the outside of the THU. Seller shall apply the "Mixed Box" label (see section 7.5) to the exterior of any boxes that contain multiple part types or line items inside a multipack carton.

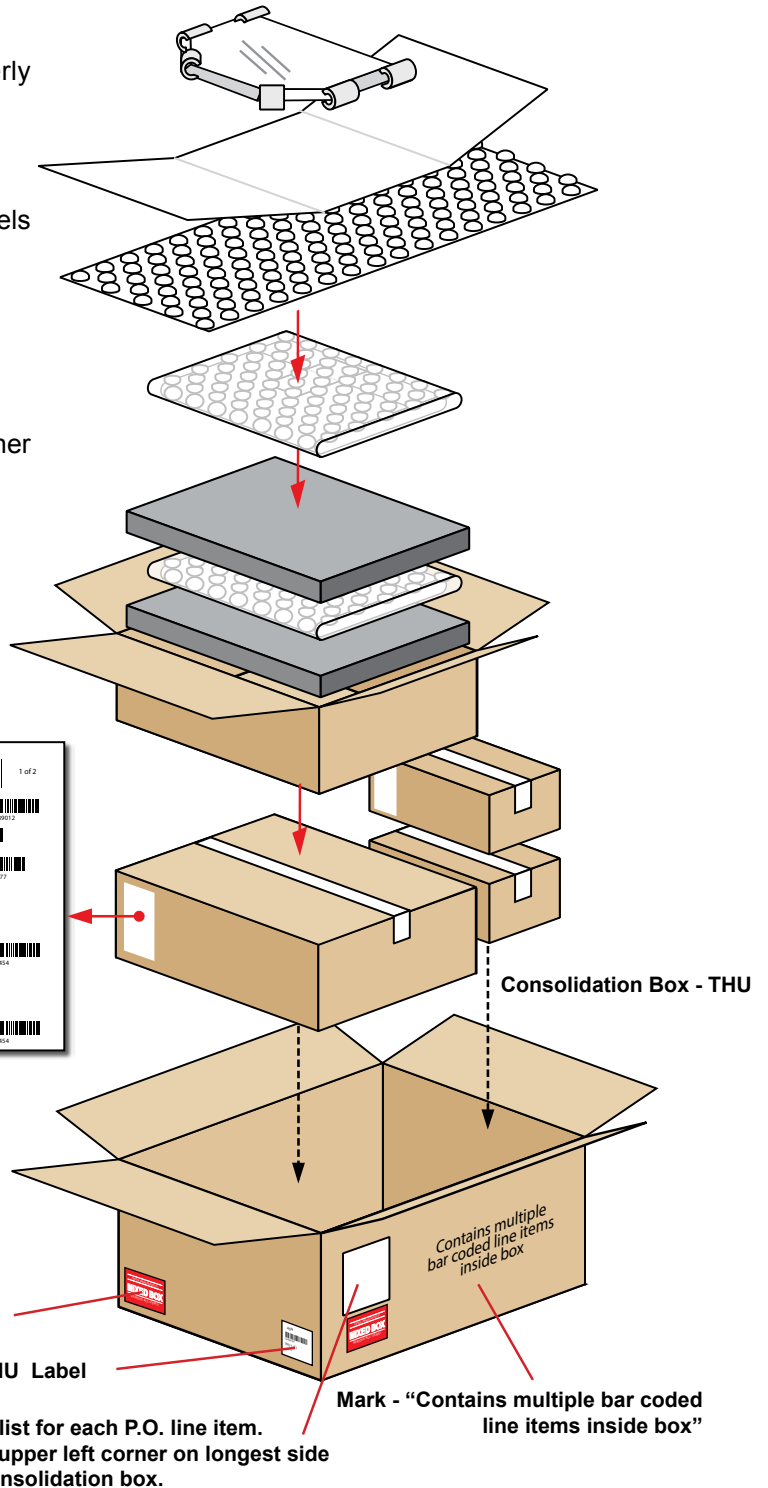

Example #3: Kits

When consolidating a kit with a machined part, if the part is not enclosed in its own carton, it must be properly protected (per section 9.4).

Seller shall affix the appropriate Receiving Labels (as required by section 8.2 Receiving Labels) to the outside of kit and wrapped part.

Seller may consolidate kits (including multiple POs) into a single shipping container (Transportation Handling Unit -THU). Add packaging materials to avoid excessive movement of part.

Do not use loose-fill packing materials.

Seller shall mark the THU "Contains multiple bar coded line items inside box".

Seller shall place THU label and packing sheet for each individual line item on the outside of the THU. Seller shall apply the "Mixed Box" label (see section 7.5) to the exterior of any boxes that contain multiple part types or line items inside a multipack carton.

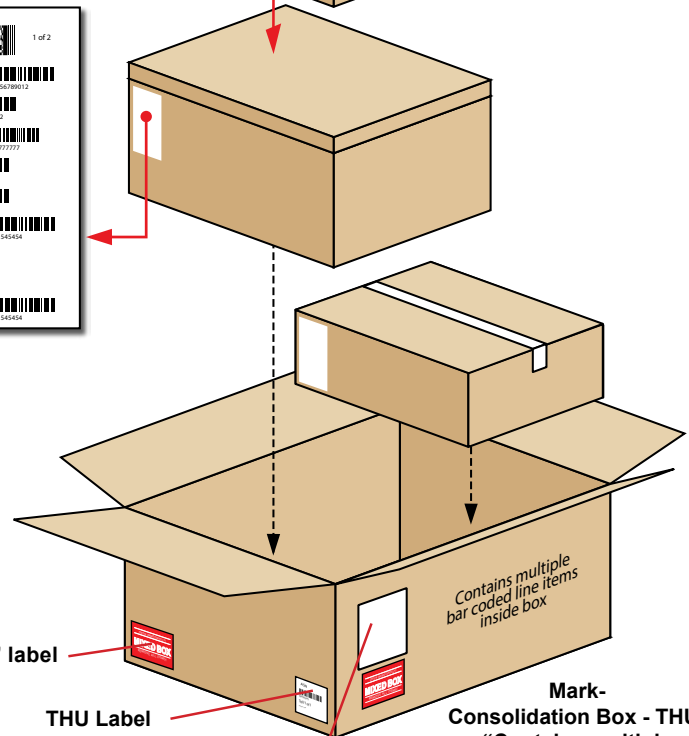
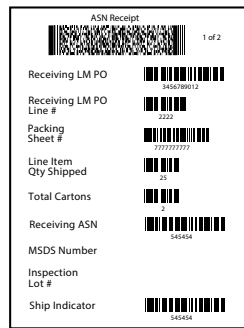
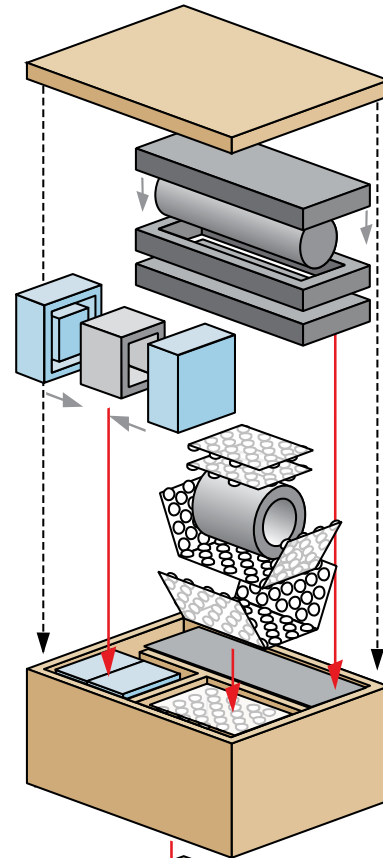

"Mixed Box" label

THU Label

Packing list for each P.O. line item. Place in upper left corner on longest side of the consolidation box.

Mark-Consolidation Box - THU: "Contains multiple bar coded line items inside box"

3.5 Raw Stock

3.5.1 Raw Stock – Skid Design

Seller shall ship raw material sheet stock on a skid-like base in accordance with the illustrations and notes below. Solid wood products shall be Heat Treated (HT) or Kiln Dried (KD).

Note: If the width of the Raw Stock is more than 48", Seller shall contact the Packaging Engineer for further shipping instructions.

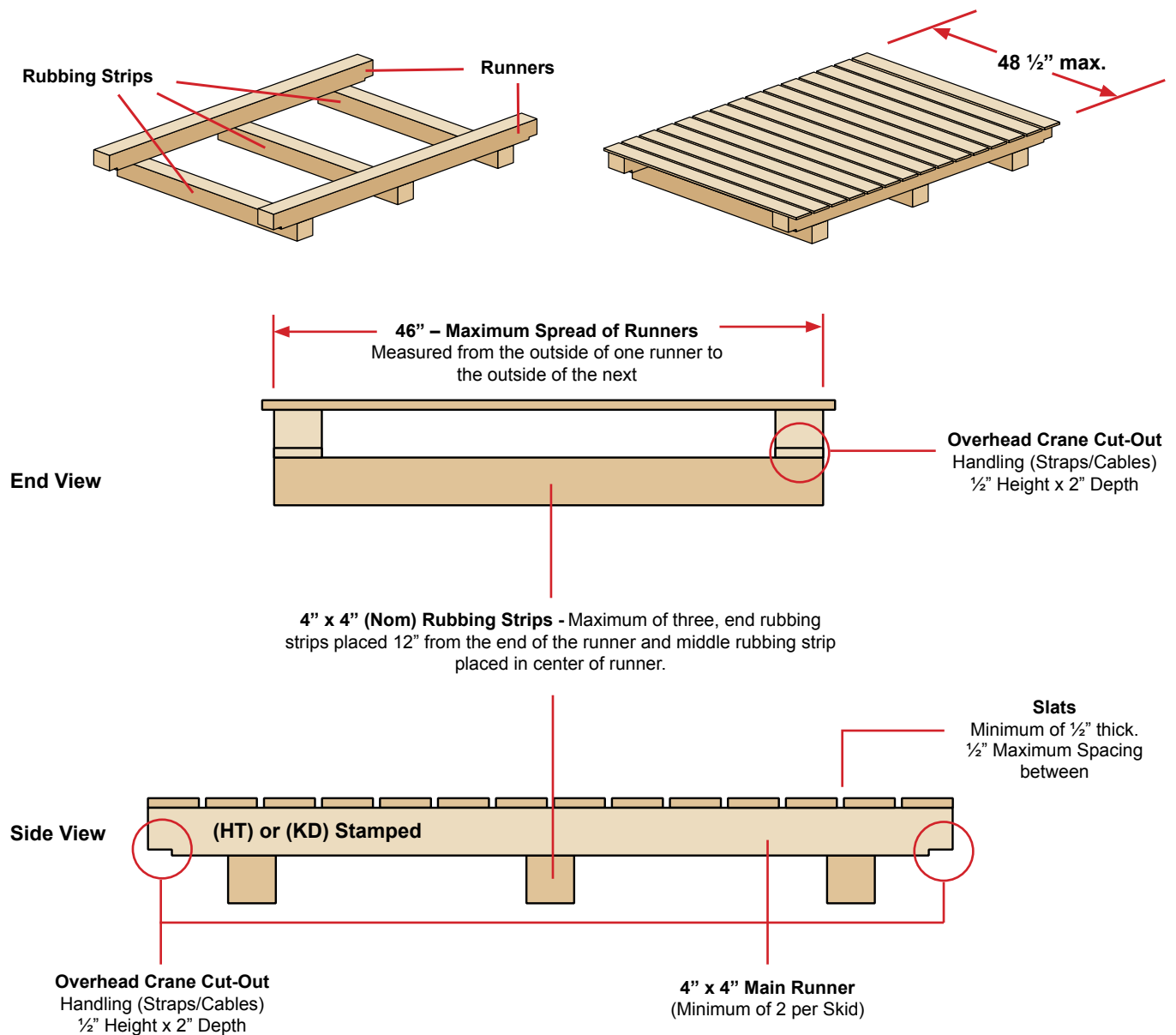

3.5.2 Raw Stock – Preparation

Seller shall oil raw material sheet stock in accordance with the requirements of the Aluminum Association Standard, Protective Oil for Aluminum, or equivalent protective oil for steel, titanium and other sheet stock. Seller shall place a protective wrapping between the bottom sheet of sheet stock and the supporting skid to protect material from corrosion.

Expanded View

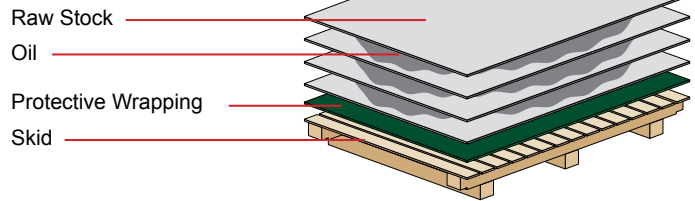

3.5.3 Raw Stock – Packaging

Seller shall ensure material does not extend beyond the edge of the skid. Steel banding shall be placed against the runners between top slats, be a minimum of 3/4" wide, and be tensioned adequately to prevent damage and/or shifting of contents.

Steel Banding
 Steel banding to be placed against the runners between top slats. 3/4" minimum

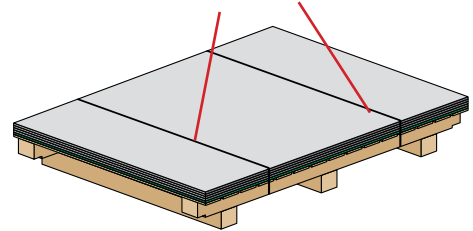

3.5.4 Raw Stock – Identification

All packing lists, text reports, etc. must be securely attached to the skid/material. Cut shapes to be stacked so the heat lot and purchase order number are visible from the outside without cutting the retaining bands.

Legible skid identification is needed on each end to include, at a minimum, the following:

LOCKHEED MARTIN P.O. _____
LOCKHEED MARTIN P.O. line item _____
LOCKHEED MARTIN P/N _____
QTY _____ UOM _____
PACKING SLIP NUMBER NO. _____

4.0 SHIPPING CONTAINERS – GENERAL

4.1 Overview

Seller shall provide containers of minimum tare weight and size consistent with the protection required. Seller shall utilize containers that meet the minimum packaging requirements of the common carriers (if so shipped) for acceptance for safe transportation at the lowest rate applicable. Disassembly of items to conserve size is desirable when reassembly can be done by unskilled labor, using common hand tools, and at no risk to the finish or function of the part. Seller shall make maximum use of corrugated fiberboard containers which meet or exceed those specifications of ASTM D 5118/D5118M, and which shall be closed by taping or banding so they may be opened without damaging the packaged item. Seller may use staples to construct fiberboard containers but they shall not use metal staples to close fiberboard containers. If Seller determines the capacity of fiberboard containers is exceeded, Seller shall use wood packaging material “WPM”, crates/pallets/skids/etc. that comply with the requirements listed in 4.2 and 4.3. Closure by use of removable fasteners such as “Klimps” or steel banding is desirable unless other means are required for item protection. Seller shall install all inner bracing on wooden crates with phillips head wood screws.

4.2 Regulated WPM

Seller shall process or treat raw wood in accordance with the current version of International Standard for Phytosanitary Measures (ISPM) 15 – “Guidelines for Regulating Wood Packaging Material in International Trade”, document can be found at: https://www.ippc.int/sites/default/files/documents/1110806941500_Chapter_11_US_import_requirements_2_E.pdf. In conjunction with ISPM 15, Seller shall obtain certification from an accredited agency recognized by the Seller’s National Plant Protection Organization “NPPO”. (United States – Animal and Plant Health Inspection Service “APHIS” – http://www.aphis.usda.gov/plant_health/acns/index.shtml).

4.3 Non-Regulated WPM

Plywood, particle board, oriented strand board or veneers are exempt from 4.2.

4.4 Reusable

Seller shall utilize reusable containers when cost effective. Container accountability, return, and maintenance for reuse shall be at Seller’s expense, unless prior agreement exists with Buyer. Ownership of the containers shall be vested in Buyer at the conclusion or termination, if any, of the PO. For more information see Supplement D of this document.

4.5 Standard

Seller shall make maximum use of carrier’s standard containers in lieu of special design containers where cost effective. Seller shall utilize shipping containers uniform in size whenever possible.

5.0 SHIPPING CONTAINERS – UNIQUE

5.1 Unique Containers

A unique container that doesn't conform to commercial standards may be necessary to protect a component and provide safe transport. In these cases, when cost justifiable and pre-approved by the Buyer's Packaging Engineer, the Seller may design their own container. Upon design completion, the Seller's engineering drawings must also be sent to Buyer's Packaging Engineer (see section 15.0) and Supply Chain Security Lead (see section 11.1) for approval (for control of materials, dimensional tolerances, fabrication, assembly and security assessment) prior to fabrication.

Note: Major subcontractors with preapproved packaging policy and procedures in place with LM and an in-house supply chain security lead do not need Buyer's Packaging Engineer/Security Lead approval.

5.2 Unique Container Design/Transportability

Where item design factors or configuration inhibit transportability, Seller shall contact the Buyer's Packaging Engineer for further shipping instructions. For the purpose of this specification, design factors or configuration shall be regarded as inhibiting transportability when:

5.2.1 Conditions for Unique Design/Transportability

- A. **Domestic Transport** - Dimensions exceed 8 feet in height, 8 feet in width, 32 feet in length, and/or gross weight is in excess of 11,200 pounds

or

- B. **International Transport** - Dimensions exceed 7 feet in height, 6.5 feet in width, 18.5 feet in length, and/or gross weight is in excess of 10,000 pounds

or

- C. Item requires temperature, pressure, shock, or vibration isolation in containers and fixtures

or

- D. Unusual and/or abnormal item configuration

5.2.2 Shipping Long Items

When long items are to be trucked, such as long skids of raw stock, Seller shall utilize flat bed trucks if at all possible to facilitate safe unloading.

5.3 Waterproof Barriers

Items suitable for shipment in open crates or without over box will not require protection against moisture. However, for those items that require such protection, a suitable shroud or membrane shall be used. Seller shall place shrouds to avoid formation of water pockets and to permit free circulation of air. Seller shall cushion sharp points of contact between the item and the shroud to prevent rupture or chafing.

5.4 Undesired Packaging Materials

Seller shall not use materials that endanger the product by corrosion, static damage or contamination (FOD). Seller shall not apply to the product being shipped any preservative which, when removed from such product using a standard removal technique, would cause damage to such product. Seller shall not use metal staples to secure polyethylene wrapped or bagged items. Seller shall not use newsprint, styrene “chips”, “peanuts,” “popcorn” or shredded paper for wrapping or cushioning.

5.5 Desired Packaging Materials

Seller shall use Cosmoline only when required, such as for tooling. Seller shall hermetically seal small oil saturated parts such as pumps and valves in a barrier bag that will contain the oil, or for larger parts, Seller shall ship the items in wood boxes to prevent container saturation and degradation. Seller shall not use metal staples to close fiberboard/cardboard containers. More detailed examples of desired packaging materials and packing procedures can be found in sections 3.4, 9.3, and 9.4.

6.0 SHIPMENTS

6.1 How To Route Shipments

For Sellers that have been through the LM Transportation Management System (TMS) onboard training program, the Seller shall utilize the TMS application, via Exostar, to route all shipments.

- TMS is accessible via Exostar at: <https://portal.exostar.com>
- If the “Supplier Provided” option is used in TMS, the Seller must utilize only approved Lockheed Martin commercial carriers

For Sellers that have not been on-boarded to TMS, the Seller shall utilize the Carrier Selection Guide and Barcode Generator to route all shipments until the Seller is on-boarded onto the TMS application.

- The Carrier Selection Guide is accessible via the Lockheed Martin Aeronautics Supply Chain Management home page at: <http://www.lockheedmartin.com/us/aeronautics/materialmanagement/scm-shipping.html>
- The Barcode Generator available is at: http://www.lockheedmartin.com/us/aeronautics/materialmanagement/scm-shipping/scm-shipping_shippinginstructions.html

6.2 Packing Sheets

With the exception of LM Catalog Orders received via Exostar, whether Seller ships material to Fort Worth, Marietta or Palmdale or other LM facilities as directed by Buyer, or other Supplier (other than Seller), or subcontractor, or Buyer’s Logistics Provider, or Buyer’s non-U.S. Government Customers, seller shall ensure that all materials shipped shall be accompanied by a standard commercial packing sheet located on the outside of the carton. Seller’s packing sheet number shall not exceed 12 characters.

Seller shall include the following information on the packing sheet:

- LM PO Number
- LM PO Line Item Number
- Ship Quantity
- Number of Cartons
- LM Part Number
- Part Name
- Traceability Data (i.e. LM serial number, date code/production lot#)
- Ship To address as exactly notated on LM PO (ex. If “Attn: L-11” is in the Shipping Address in the LM PO it must say “Attn: L-11” in the Ship To field of the packing sheet).

Seller shall affix one packing sheet to the outside of each individual line item carton. For consolidation shipments, Seller shall affix all the packing sheets to the outside of the consolidation box. For hazmat shipments, Seller shall affix all the packing sheets to the outside of the container. Seller shall include copy of the packing sheet inside container.

6.3 Classified Shipments

Seller shall follow the shipping requirements stipulated in this document for all classified shipments. Seller shall place all paperwork (packing sheet, etc) on the outside of the box. Seller shall bar code the box per Receiving Labels Sec 8.2. Per the NISPOM, section 5-408 and 5-409, the bar code shall include a line below the MSDS line that stipulates whether the part is Constant Surveillance Service (“CSS”) or Protective Security Service (“PSS”). Further, Seller shall mark the Bill of Lading or other applicable DOT document PSS or CSS. Seller shall not mark or otherwise indicate on the outside of the box the classification of the part.

6.4 Communications Security (COMSEC) Shipments

Seller shall follow the shipping requirements stipulated in this document for all COMSEC shipments. Seller shall place all paperwork (packing sheet, etc) on the outside of the box. Seller shall bar code the box per Receiving Labels Sec 8.2. Per the NSA Industrial COMSEC Manual, NSA Manual 90-1, the bar code shall include a line below the MSDS line that stipulates the part is CCI. Further, Seller shall mark the Bill of Lading, or other applicable DOT document as CCI.

7.0 MARKING - GENERAL

7.1 Containers

Seller shall mark all shipping containers in accordance with ASTM D3951-10 with permanent type ink or paint. Seller shall add pictorial markings on packages or containers in accordance with ASTM D5445 "Standard Practice for Pictorial Markings for Handling of Goods" when conditions warrant special handling during the unloading process. For example, Seller shall apply the pictorial marking when the center of balance is uneven on the container, or if the container is top heavy and may tip over easily. Seller shall apply two (2) person lift labels on four sides and top and include the gross weight of the contents when shipping containers weigh more than 50 pounds and less than 100 pounds (See 10.0 Special Handling Symbols). Seller shall apply a skid to facilitate the safe material handling on containers weighing more than 100 pounds and mark the total packaged weight on three sides with 1" high letters. Seller shall include markings required by section 8.2 Label Using Bar Code Markings, as well as Buyer's part number, serial number and individual carton number (i.e. 2 of 3) and any special markings as required by carrier rules and regulations that apply. Seller shall bar code any items packaged individually inside a consolidated shipment container per section 8.2 Label Using Bar Code Markings. Seller shall apply a unique mark, as described in section 9.7 High Risk Shipments, to any shipping container that requires specialized handling, caging and loading techniques and devices, which are required to protect the item during shipment, storage, installation, or removal. Seller shall use hand-written black or red ink marks that measure at least 4 inches high. Seller shall mark magnetic items that identify the item as being magnetic. The markings shall indicate in milligauss, at a fifteen-foot distance, the magnetic field strength of the unpackaged component. Seller shall mark or tag hydraulic, fuel, and oil units including accessories indicating the internal flushing, filling, or calibrating fluid used. Seller shall clearly identify the delivery limitations and handling requirements for age control items on the interior and exterior containers in accordance with section 9.1 Age Sensitive Items of this document.

7.2 Labels - General

7.2.1 Minimum size

The minimum label size is 4"x 4" If you have any question as to readability, please send a sample to your local Lockheed Martin Site Representative (click here for information: <https://embastion.external.lmco.com/bar-coding/contacts.htm>)

7.2.2 Label material

Unless otherwise specified in this document, the label material shall be white in color with black printing to provide maximum contrast. The label may be self adhesive, either pressure sensitive or dry gummed, or held in place on the package with a self adhesive over laminate (such as clear shipping tape). The supplier shall assure the label is attached to the container substrate securely and the application is wrinkle free.

7.3 Hang Tags

When the packaging material prohibits the use of containers which allow the application of self adhesive labels, a tag shall be securely fastened to the container. The supplier shall assure that the location and attachment of the tag under normal conditions will not cause damage or premature removal of the tag prior to reaching its intended destination.

7.4 Electrostatic Discharge (ESD) Sensitive - Labels

For electrostatic sensitive devices, seller shall apply proper ESD labels on interior and exterior containers, i.e. 2x2 labels on interior and 4x4 labels on exterior containers. Preprinted labels are available online from various sources.



7.5 Open Immediately/Mixed Box/Remove All Items - Labels

Any box that contains multiple part types, multipack cartons, time sensitive items or dangerous goods must be opened immediately. It is important that the Seller apply the label below to all four sides and top of each box. To download this label go to: http://www.lockheedmartin.com/us/aeronautics/materialmanagement/scm-shipping/scm-shipping_shippinginstructions/pm-5010labels.html



7.6 Material Safety Data Sheet (MSDS) Information

Seller shall reference Buyer's approved MSDS number, in the appropriate field, on the bar code label on all hazardous materials packaging. See section 8.2 Receiving Labels.

7.7 Cadmium Warning Labels

Seller shall label shipping and storage containers for cadmium, cadmium compounds, cadmium containing materials or articles (such as cadmium plated mechanical fasteners) that are capable of releasing cadmium during Buyer's manufacturing processes, as required by the Occupational Safety & Health Administration regulations found in 29CFR1910.1027. As a minimum, these warning labels shall include the following information: Danger, Contains Cadmium, Cancer Hazard, Avoid Creating Dust, Can Cause Lung and Kidney Disease. Preprinted labels are available online from various sources.

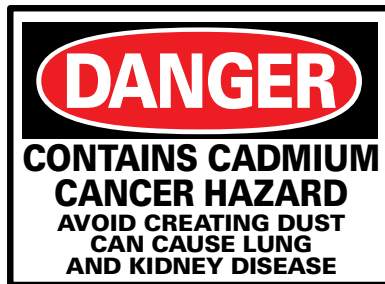

7.8 Special Labels or Markings

Special labels or markings may be used to identify program, shortages, etc. Detailed instructions will be provided from time to time by Buyer as required. Seller shall affix special labels or markings to the exterior of the shipping containers in accordance with Buyer's request.

7.9 Material Review Board (MRB) Items

Seller shall mark all containers identified as an MRB item as follows:

MRB ITEM

Box No. _____ of _____

Deliver to: Receiving Dock

MRB Crib

Seller shall clearly identify the outside of the shipping container(s) with 1/2" high lettering on contrasting background and on all four sides. The prescribed marking is a Buyer control mechanism to prevent suspect or non-conforming items from commingling with production parts.

When specified by a Supplier Quality Assurance Report (SQAR) disposition, secure a completed Supplier Open Rejection tag to each part and securely fasten a Supplier Open Rejection tag to the outside of each side of the shipping container. Seller shall place rejection tags in a weather proof jacket prior to fastening to the shipping container or completely cover with transparent tape. If the part is to be shipped to a sub tier supplier for additional processing prior to shipment to LM Aero, Seller shall provide instructions for the sub tier supplier to maintain or replace the Supplier Open Rejection tags on the part and the shipping container.

8.0 TMS MARKING – LABELS

8.1 Radio-Frequency Identification (RFID) Tag

LM Aeronautics is in the process of having all sub-contractors go through the Transportation Management System (TMS) onboard training program. If you have been through this TMS training program this RFID requirement applies.

The following section describes passive RFID labeling requirements for shipments to LM Aeronautics facilities or other designated receiving locations on behalf of LM Aeronautics. (Note: For shipments to U.S. Gov't facilities please see Lockheed Martin document PM-801 for guidance.)

8.1.1 Passive RFID Tag Requirements for Shipments Using TMS

- A. Seller must be able to access the LM TMS, to comply with the LM Aeronautics RFID requirement.
- B. Seller must affix Passive RFID tags at the Transportation Handling Unit (THU) level for all shipments to LM Aeronautics facilities. THU is defined as the shipping container or outermost box (when multiple boxes are consolidated into one bigger box).

8.1.2 Affixing Passive RFID Tags

- A. Seller shall ensure that the data encoded on each passive RFID tag are globally unique (i.e. the tag ID is never repeated or duplicated) and conforms to the requirements specified in the most current version of the United States Department of Defense Suppliers' Passive RFID Information Guide (http://www.acq.osd.mil/log/sci/DoD_Suppliers_Passive_RFID_Info_Guide.html)
- B. Seller shall use passive tags that are readable; and
- C. Seller shall place the RFID tag next to the ASN THU label as illustrated below. Do not place the RFID tag over a seam, corner, or other location on the box that is likely to be torn or ripped. Rubbing or smearing of the surface is okay and is not considered damage.

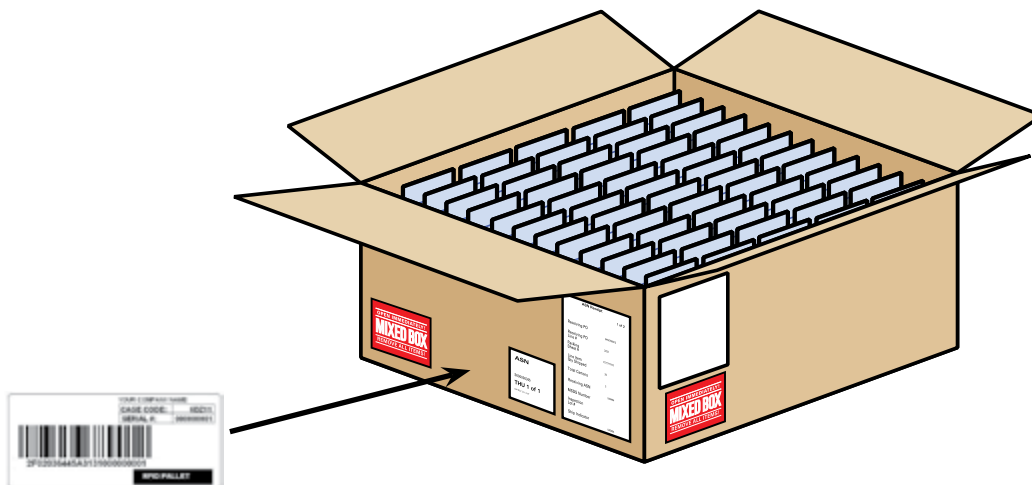

8.1.2.1 Data Syntax and Standards

The Seller shall encode (or procure) an approved RFID tag using the instructions provided in the EPC Tag Data Standards in effect at the time of contract award for a UHF Class 1 Gen 2 RFID tag. The EPC/RFID Tag Data Standards are available at: <http://www.gs1.org/epc-rfid>.

- A. The Seller shall employ the DoD identifier, the Seller shall use its previously assigned Commercial and Government Entity (CAGE) code, CAGE codes can be found at: https://www.logisticsinformationservice.dla.mil/BINCS/begin_search.aspx. If the Seller uses a third-party packaging house to encode its tags, the CAGE code of the third-party packaging house is acceptable.
- B. The seller is responsible for ensuring that the tag ID encoded on each passive RFID tag is globally unique, per the requirements stated paragraph in 8.1.2A.

8.1.2.2 Advance Shipment Notice (ASN) Requirements

Seller shall use TMS to enter the RFID tag serial number (24 Character value that begins with 2F) in the space provided on the Create THU screen for shipments to LM Aeronautics facilities.

8.1.3 Tag Requirements

Seller shall prepare (or obtain) passive tags that meet the EPC Global Class 1 Generation 2 and ISO/IEC 18000-6C specification with a read range of at least 5 feet. Seller shall use Class 1, 96-bit tags.

8.1.4 RFID Tag Construction Standards

All RFID tags will have encoded data impregnated into RFID tag. Both the Department of Defense (DoD) and Electronic Product Code (EPC) global have developed construct standards for encoding RFID tags. Construct data consists of the supplier's CAGE (Commercial and Government Entity) code, tag serial number (independent of the part serial number that is being shipped), and type of container (i.e. pallet or case). Seller shall ensure each RFID tag is unique for each shipment. Seller is responsible to ensure the RFID tags have been encoded correctly per DoD 96 construct. If the seller does not have the capability to confirm, obtaining confirmation from the tag provider or providing sample tags to LM Aeronautics for confirmation is acceptable.

8.1.5 Sourcing Passive RFID Tags

Sellers may create their own Passive RFID tags or may purchase pre-encoded RFID tags directly from a supplier of their choice. An internet search of DoD 96 RFID tag Suppliers will return several options. More RFID requirements information (including potential label suppliers) is available at the following link: http://www.lockheedmartin.com/us/aeronautics/materialmanagement/scm-shipping/scm-shipping_shippinginstructions.html

8.2 Receiving Labels

Note: LM is in the process of having all sub-contractors go through the Transportation Management System (TMS) on-board training program. If you have been on-boarded to TMS proceed to section 8.2.1. If not proceed to section 8.2.2.

8.2.1 Generated by TMS

Upon being on-boarded by the TMS project team, Seller must identify all containers using labels with TMS markings. Seller shall print labels on adhesive-backed, label stock and properly adhere to container. (Note: Printing labels on a sheet of paper and inserting into a clear sleeve label, with barcode visible through the sleeve, is acceptable but not the preferred method)

Seller shall construct bar codes and apply markings as follows:

8.2.1.1 Transportation Handling Unit (THU) Label

- A. Receiving ASN #

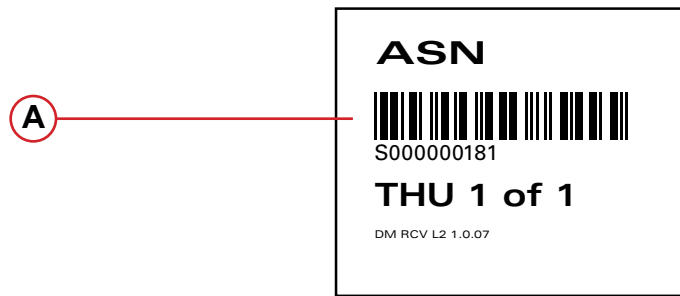

8.2.1.2 ASN Receipt Label

- A. Carton Number and Total Number of Cartons
- B. Receiving LM PO
- C. Receiving LM PO Line Item Number
- D. Packing Sheet Number (maximum 12 character limit)
- E. Line Item Quantity in Shipment
- F. Total Cartons
- G. Receiving ASN
- H. MSDS Number (only if hazardous)
- I. Inspection Lot Number (only if inspected at source)
- J. Shipment Indicator (required for Classified part shipments only)

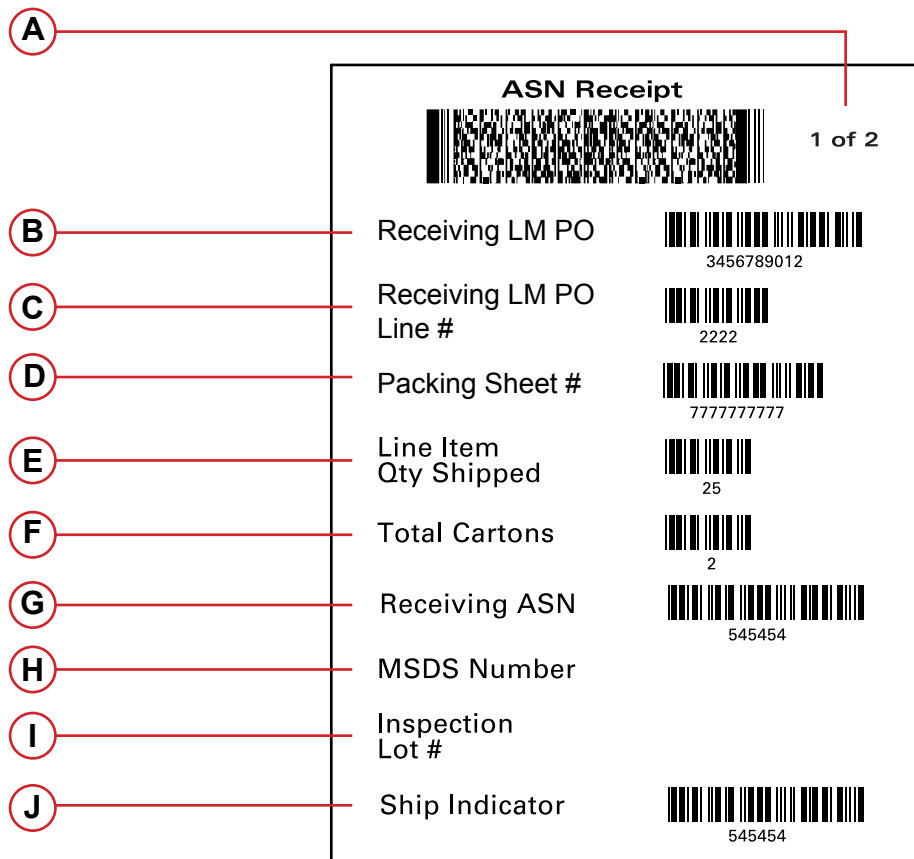

8.2.1.3 Additional Carton Label

- A. Carton Number and Total Number of Cartons
- B. Receiving ASN Number
- C. Receiving LM PO Number
- D. Receiving LM PO Line Number
- E. Container Quantity

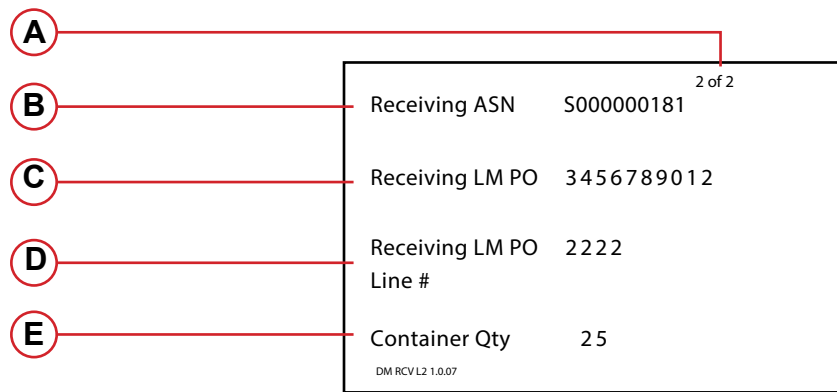

8.2.1.4 Label Placement Examples

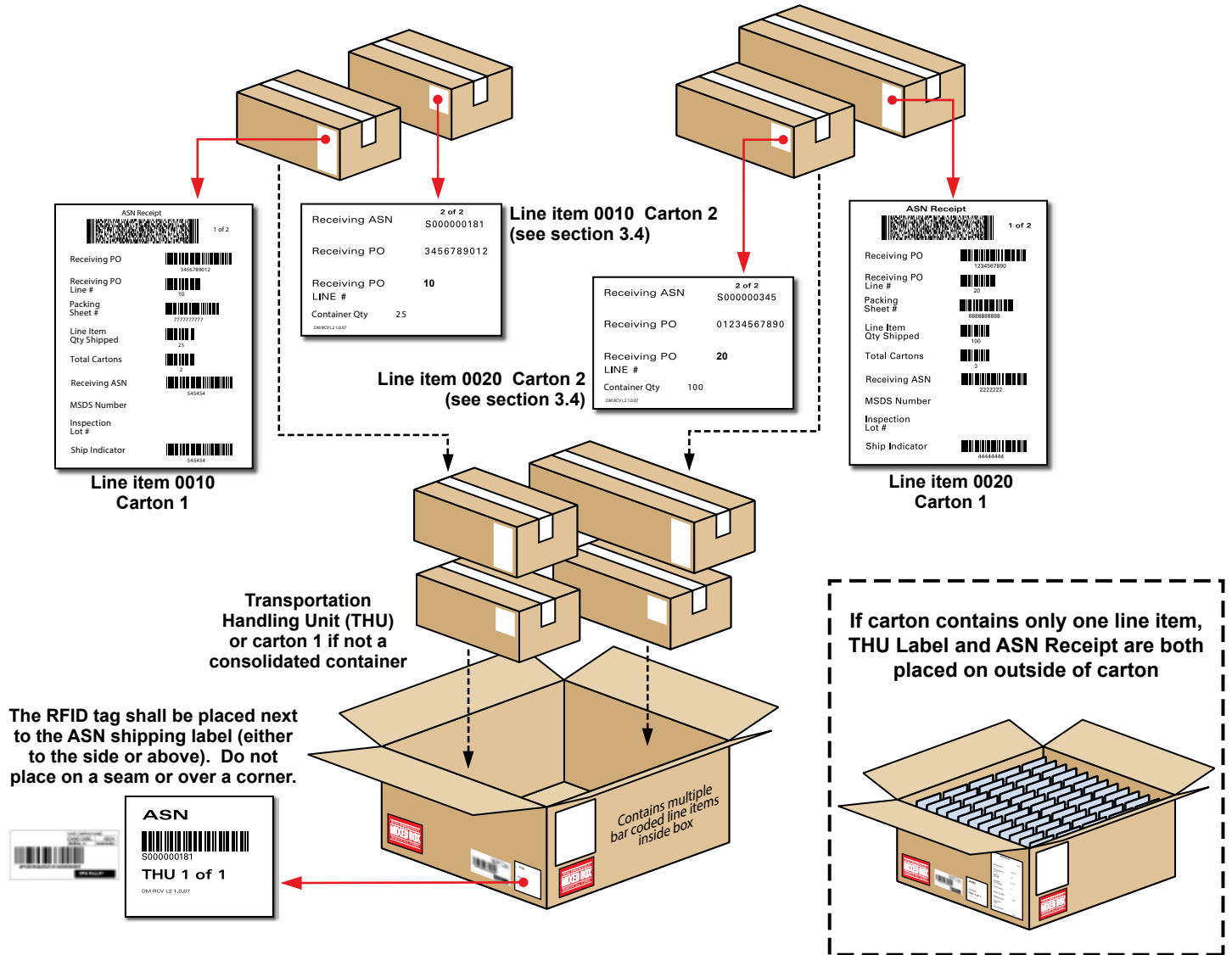

No labels shall be placed on bottom of box.

Note: If material is “non-markable” (i.e., oily raw stock, etc.), Seller may place the ASN bar codes with the packing sheet. Seller may use separate labels for each ASN bar code in lieu of all bar codes being on one label as long as the correct order is maintained.

8.2.2 Generated by Bar Code Generator (Note: This section only for those not on-boarded to TMS)

Seller must identify all containers using labels with Bar Code Markings. Simple bar code programs that conform to this specification are available at: <https://embastion.external.lmco.com/bar-coding/> Seller shall print labels on adhesive-backed, label stock and properly adhere to container.

When generating a bar code label, there are four different label formats available. Examples of properly bar coded shipments are in the following sections:

Examples of properly bar coded shipments are in the following sections:

Standard PO	Section 8.2.2.1
eCat	Section 8.2.2.2
JSF TFE	Section 8.2.2.3
Block 60	Supplement B Section 2.0

Seller shall construct bar codes and apply markings as follows:

8.2.2.1 Bar Code Data Elements for a Standard PO



- A. Receiving LM PO
- B. Receiving LM PO Line Item Number
- C. Packing Sheet Number (maximum 12 character limit)
- D. Line Item Quantity in Shipment
- E. Total Cartons
- F. MSDS Number (only if hazardous)
- G. Shipment Indicator (required for Classified part shipments only)

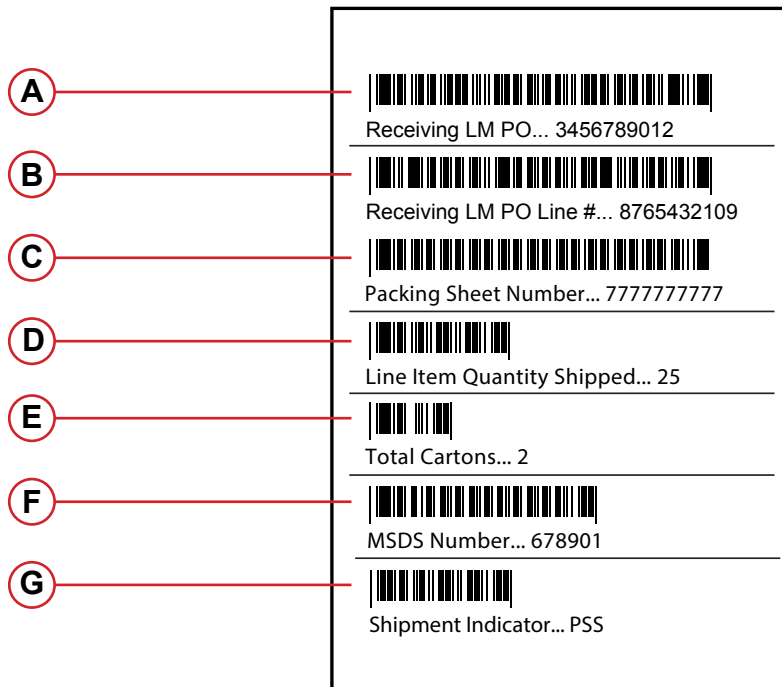

8.2.2.2 Bar Code Data Elements for eCAT



The LM Catalog bar coded labels must include the following data elements: For each of the three bar code data elements below, Seller shall specify the bar code description to the left of the bar code. On the top of the label, Seller shall indicate “Direct Delivery” in bold letters.

- A. Order Number (LM Catalog Purchase Order Number)
- B. Packing List Number (maximum 12 character limit)
- C. Deliver to (building, floor and column)

Direct Delivery

A [Barcode] LM Order Number... EC987654321

B [Barcode] Packing Slip Number... 123456789

C [Barcode] Deliver to Address... 00050186

User	Joe
Telephone	817-555-1234
Building	5
Floor	1
Column	86

Note: For any additional human readable data, Seller shall include User Name and Phone Number and on separate line, the deliver to: Building, Floor and Column in bold letters.

8.2.2.3 Bar Code Data Elements for JSF TFE

Standard PO eCAT JSF TFE Block 60

- A. Receiving LM PO
- B. Receiving LM PO Line Item Number
- C. Packing Slip Number (maximum 12 character limit)
- D. Line Item Quantity in shipment
- E. Total Package Count
- F. MSDS Number (only if hazardous)
- G. LM Part Number
- H. Procuring PO & Line Number

A	Receiving LM PO... 1234567890
B	Receiving LM PO Line #... 0987654321
C	Packing Slip Number... 8888888888
D	Quantity... 100
E	Total Package Count... 3
F	MSDS Number... 555555
G	LM Part Number... 567890123
H	Procuring PO & Line Number...1234560789012

Note: If the PO number is 1234567, then Seller shall display only 1234567 on the bar code and shall not fill in remaining field with any leading and/or trailing characters, such as XXXXX1234567 or 1234567YYYYY.)

Requirements:

- a. Seller shall print elements in the order shown (A through G above) and all fields must be filled.
- b. Data elements will be in a stacked array. Use of MSDS bar code is not required or value "N/A" (per instructions on LM provided bar code application) is acceptable if shipment is non-hazardous.
- c. Bar codes must be readable commercial Code 3 of 9.
- d. Bar codes will be applied by means of labels.
- e. Bar codes will be a vertical "picket fence" with minimum height of 0.25 inches.
- f. Bar codes will apply to the total quantity of a given line item regardless of the number of cartons required to contain that line item.
- g. If multiple cartons are required for one line item, only the first carton must be bar coded. The remaining cartons shall be marked as follows:
 - Carton number (e.g., 2 of 3, 3 of 3, etc.)
 - LM PO number
 - LM PO Line item number
 - Quantity PER BOX

Containers labeled using bar code markings may not contain more than one line item. Seller may consolidate different bar coded containers containing different line items for shipping/handling purposes. Seller shall mark the consolidation box "Contains multiple bar coded line items inside box."

- h. Seller shall affix a packing sheet to the outside of the shipping container. For consolidation shipments, Seller shall affix all the packing sheets to the outside of the consolidation container. Seller shall include a copy of a packing sheet inside each carton. Seller shall limit the packing sheet number to a maximum of 12 characters.
- i. If material is "non-markable" (i.e., oily raw stock, etc.), Seller may place the bar codes with the packing sheet. Seller may use separate labels for each bar code in lieu of all bar codes being on one label as long as the correct order is maintained.

8.3 Examples of Label Placement - Odd Shaped Shipments

- All labels affixed to the outside of container shall be of a type that allow for easy removal
- All prior labels need to be removed prior to shipping to LM
- All labels are to be properly attached to the item being shipped using one of the following:
 - Adhesive Backed Label
 - Non-Printed Adhesive Backed Clear Packing List Envelopes
 - Industrial Quality Lanyard Tags

Note: Placing clear tape over labels is not recommended. Tape affects the scan ability of labels.

See below for approximate locations for label placement.

Wire Mesh Container

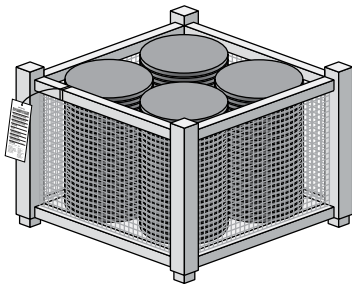

Bag

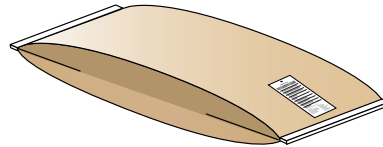

Pallet Box

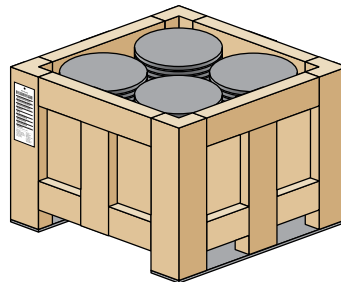

Bundle

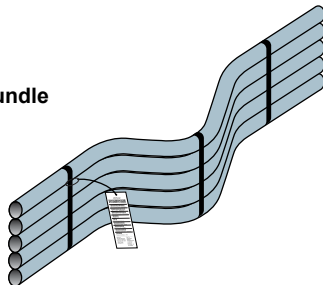

Metal Bin or Tub

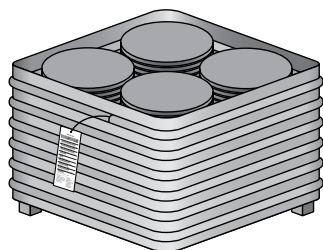

Rack

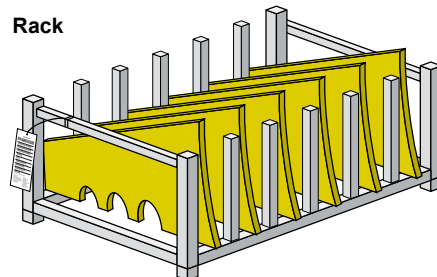

Roll

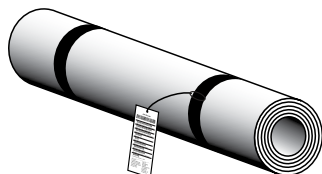

9.0 SPECIAL HANDLING

9.1 Age Sensitive Items

Seller shall clearly identify the delivery limitations, marking, special handling, and specialized equipment requirements for Age Sensitive Items on the interior and exterior containers. Markings shall include the manufacturer, part number, serial number, cured, assembled or packed date (apply one date); and the expiration or inspect/test date. Seller shall notify Buyer prior to shipment where precautionary measures are required.

If Seller packs an Age Sensitive Item - the container should be marked with the Age Sensitive Symbol (Hourglass) To download this symbol go to: http://www.lockheedmartin.com/us/aeronautics/materialmanagement/scm-shipping/scm-shipping_shippinginstructions/pm-5010labels.html



9.2 Temperature Sensitive Markings

Temperature Sensitive markings shall be shown as part of the item identification data on unit packs, intermediate containers, exterior containers, and unpacked items. If Seller packs a Temperature Sensitive Item - the container should also be marked with either one of the Temperature Sensitive markings shown below (whichever is most appropriate), including the manufactured, cured, assembled or packed date (apply one date), and the expiration or inspect/test date, as appropriate. Preprinted labels are available online from various sources.

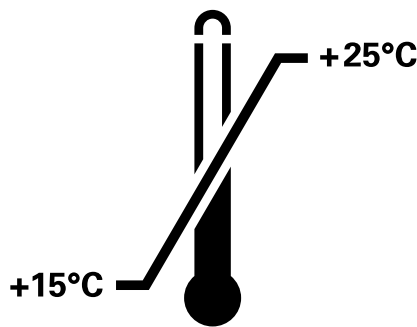

Temperature Sensitive

or

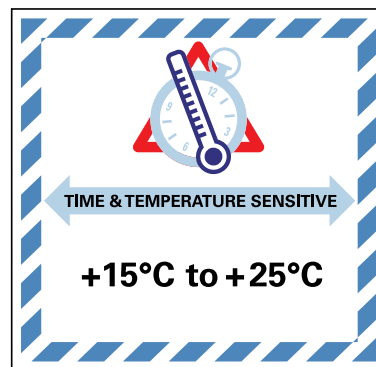

Time and Temperature Sensitive

Containers shall be marked with pictorial symbols to indicate temperature limits

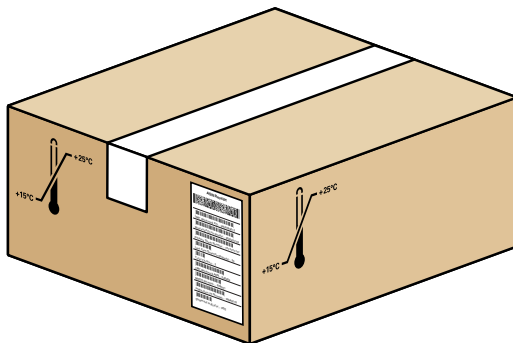

or

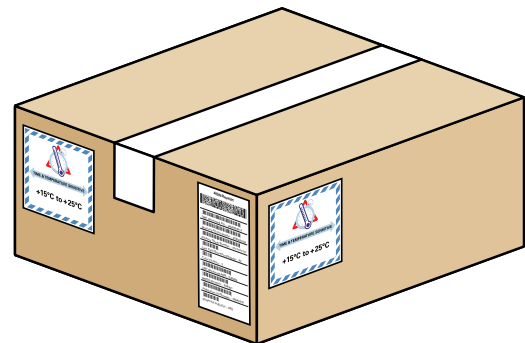

Note: Temperature Sensitive is defined as: The total period of time beginning with the date of manufacture, cure date (for elastomeric and rubber products), assembly, pack, or after visual inspection/certified laboratory test/restorative action, that an item may remain in storage.

9.3 Composite Parts Protection

Seller shall properly protect all composite parts by individually enclosing each line item (Part Number) in a carton segregating it from other line items. See section 9.4.

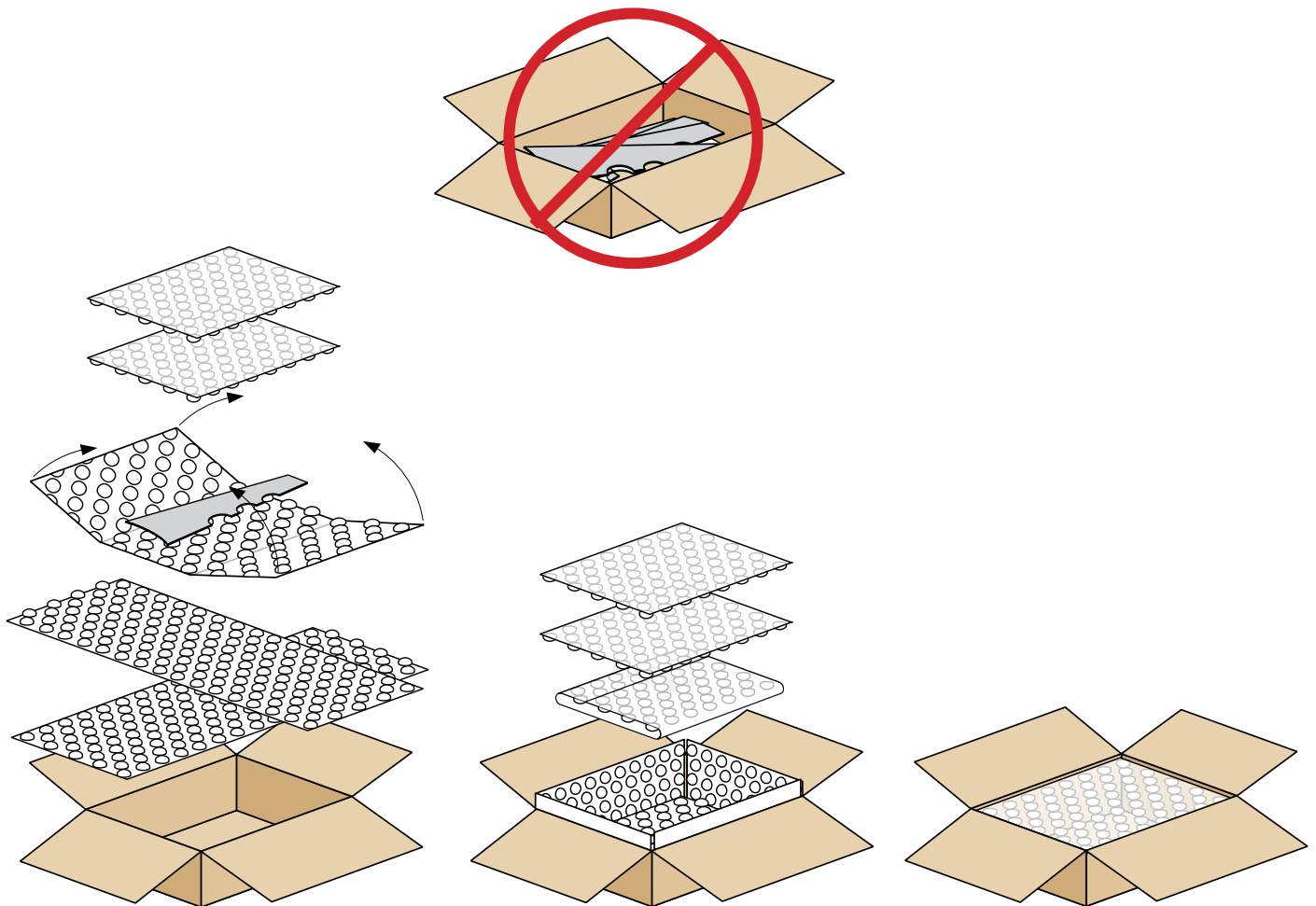

Packaging Steps / Instructions (minimum guidelines):

1. Inside dimensions of container are calculated by measuring the part and adding a minimum of 4 inches to each dimension.
2. Wrap part completely in bubble wrap. Use tape to hold wrap in place.
3. For bottom of container, prepare bubble wrap. Bubble wrap length should be at least twice the length of each container dimension (length/width) and placed perpendicular into bottom of container creating overhang over the edges.
4. Place part in container.
5. Wrap part with bubble wrap overhang and fill in sides of container with bubble wrap.
6. Place bubble wrap on top of part, filling in remaining space to top of container.
7. Make sure part is secure in package. Use bubble wrap for any loose areas.
8. Close container and seal with tape.

9.4 Machined Parts Protection

Seller shall properly protect machined parts or assemblies with chevron, beveled, pointed and/or sharp edges. Preferred packaging examples are shown below. The materials listed in this section are minimum examples only, other materials that are similar and FOD friendly are acceptable (Seller shall not use newsprint, styrene “chips”, “peanuts,” “popcorn” or shredded paper for wrapping or cushioning). Consolidation of these items is acceptable per Sec. 3.4. Seller shall place appropriate bar code label on the outside of each carton. Place packing list for each P.O. line item on the outside of the consolidation box. Any combination of the following examples of part protection and consolidation would be considered acceptable.

Example #1 - Bubble Wrap

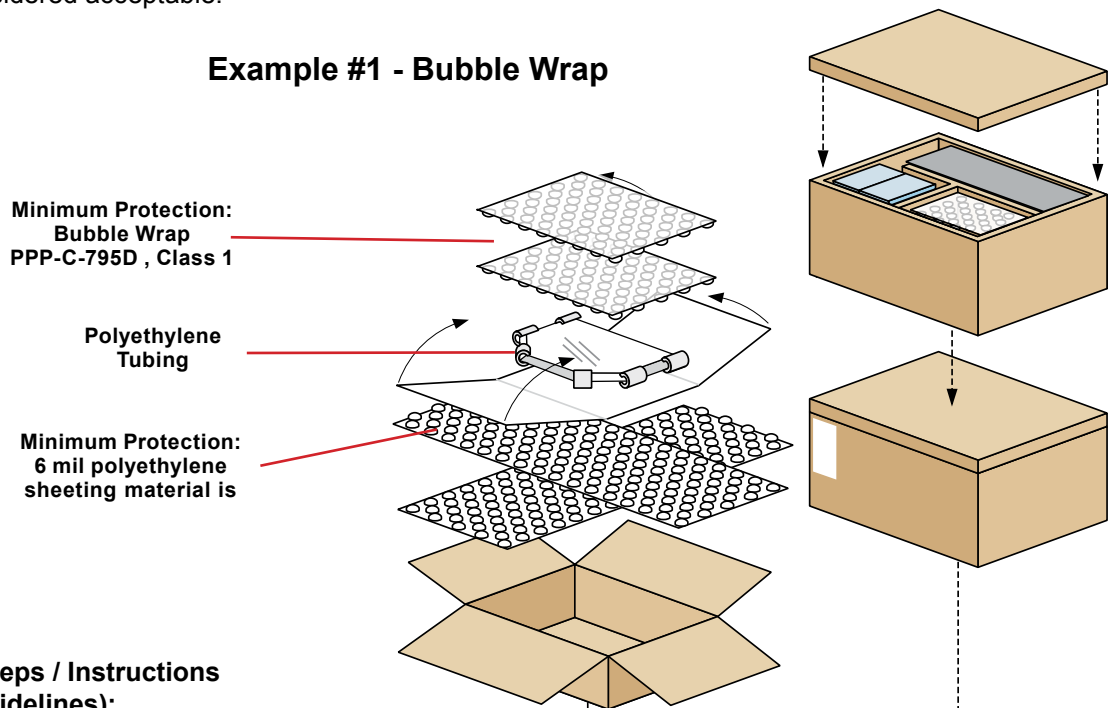

Packaging Steps / Instructions (minimum guidelines):

1. Inside dimensions of container are calculated by measuring the part and adding a minimum of 4 inches to each dimension.
2. Attach polyethylene tubing or polyurethane foam cushioning to part where necessary and cover with polyethylene wrap. Use tape to hold wrap in place. (Note: tubing shown in illustration)
3. For bottom of container, prepare bubble wrap. Bubble wrap length should be at least twice the length of each container dimension (length/width) and placed perpendicular into bottom of container creating overhang over the edges. Place part in container.
4. Wrap part with bubble wrap overhang and fill in sides of container with bubble wrap.
5. Place bubble wrap on top of part, filling in remaining space to top of container.
6. Make sure part is secure in package. Use bubble wrap for any loose areas.
7. Close container and seal with tape.

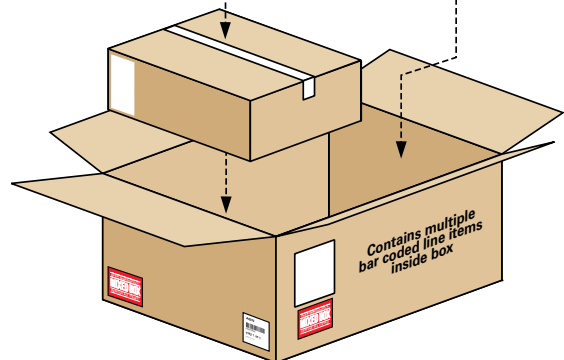

Example #2 - Polyethylene Foam

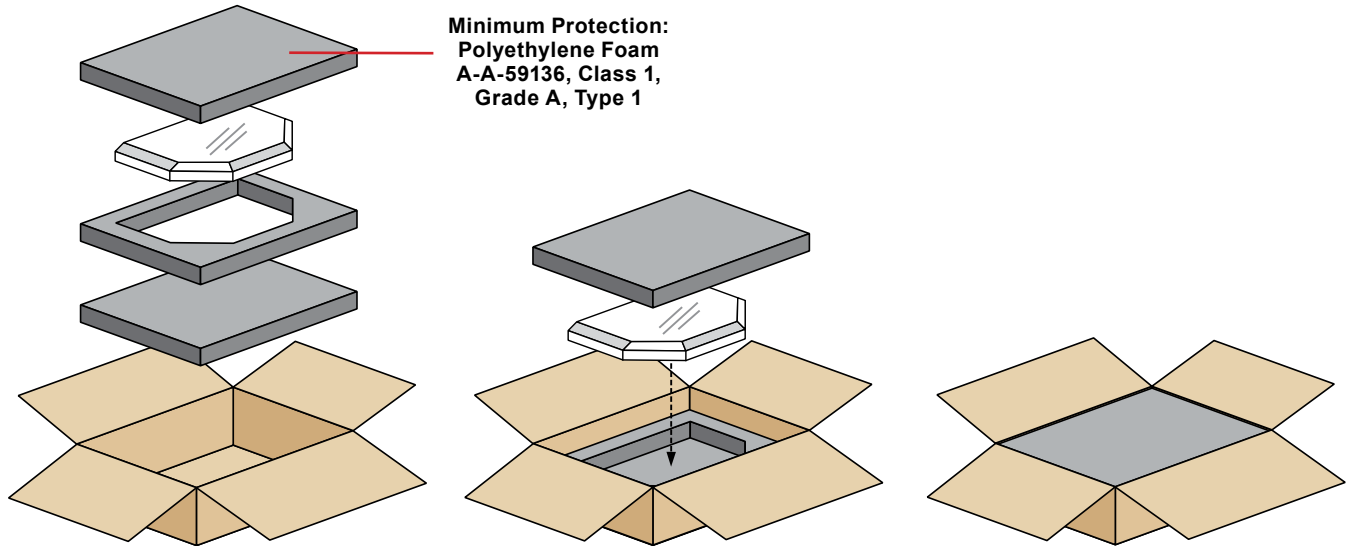

Packaging Steps / Instructions (minimum guidelines):

1. Inside dimensions of container are calculated by measuring the part and adding minimum of 4 inches to each dimension (length, width, & depth).
2. Cut three 2 inch polyethylene foam cushions equaling the inside length and width dimensions of container.
3. Take one polyethylene cushion from Step 2, center the part on it, and scribe around part with a marker. Cut out traced pattern once completed. The goal is to have two solid pieces (top and bottom pads) and one cut-out piece to encase the part.
4. Place one untraced cushion in bottom of container.
5. Set traced cushion inside container.
6. Set part inside of traced cushion. Use small bubble wrap to fill any gaps.
7. Place other untraced cushion in container
8. Close container and seal with tape.

Example #3 - Semi-Rigid Foam-In-Place

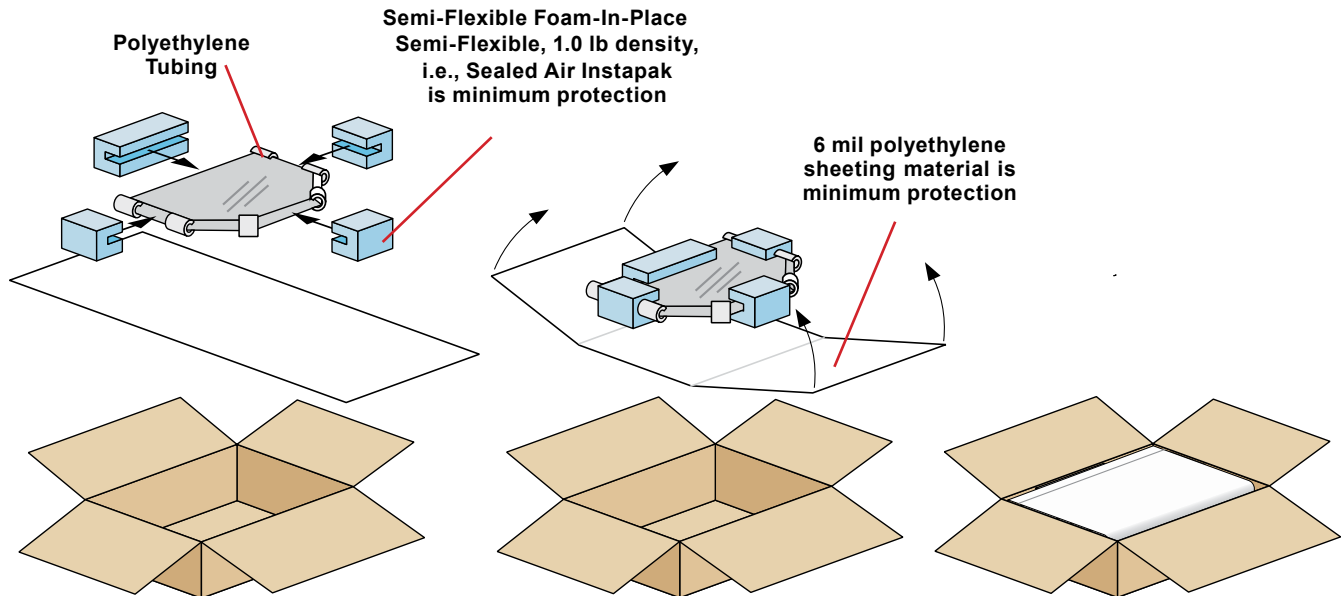

Packaging Steps / Instructions (minimum guidelines):

1. Inside dimensions of container are determined by measuring the part and adding minimum of 4 inches to each dimension (length, width & depth).
2. Attach polyethylene tubing or polyurethane foam to part where necessary and cover with polyethylene wrap. Use tape to hold wrap in place. (Note: Blue foam shown in illustration)
3. Center part in container and block with Foam-In-Place. Do not Foam-In-Place on any beveled, sharp or chevron edges.
4. Close container and seal with tape.

9.5 Electrostatic Discharge (ESD) Sensitive - Items

Seller shall package electronic hardware, which is sensitive to ESD, so as to protect sensitive items during shipment and storage. Seller shall individually package each item. Seller shall cover external connectors on equipment containing ESD sensitive hardware with conductive caps. The caps shall be black and have a maximum surface resistivity of $10E5$ OHMS per square. Metal caps are also acceptable. Seller shall mark part number and serial number on the outside of each package.

9.5.1 Additional Information on ESD

Additional information on ESD can be found in LM's PM-4043 "Supplier Electrostatic Discharge Damage Prevention Requirements" document and the Electrostatic Discharge Association website located at <http://www.esda.org>. That website includes information on static control procedures and materials, how to eliminate and reduce generation, dissipate and neutralize charges, and protect sensitive products from ESD.

9.6 Hazardous Materials/Dangerous Goods Packaging

Seller shall pack dangerous goods per United Nations (UN) performance-tested specification packaging. Seller shall package, pack and mark hazardous materials and dangerous goods according to the following specifications/standards/publications to determine the packaging requirements for dangerous goods depending on mode of transportation:

- International Air Transport Association's Dangerous Goods Regulations (IATA)
- United Nation's Recommendation on the Transport of Dangerous Goods
- International Maritime Organization's International Maritime Dangerous Goods Code (IMDG)
- International Civil Aviation Organization's Technical Instructions for the Safe Transport of Dangerous Goods by Air (ICAO)
- Code of Federal Regulations Title 49 – Transportation

9.6.1 Certification/Permits

Seller shall forward all certifications of exemptions to Department of Transportation (DOT) Regulations to the "Buyer's Packaging Engineering Address" to be retained on file.

9.6.2 Classification

For explosives or other dangerous items which require Bureau of Explosives or DOT review and approval, Seller shall submit to the "Buyer's Packaging Engineering Address" data setting forth the proper explosive and dangerous articles classification.

9.6.3 Closure/Tests Instructions

Seller shall forward tests and closure instructions to the "Buyer's Packaging Engineering Address" to be retained on file by the Buyer. This includes tests and closure instructions from third-party packaging distributors. Seller shall provide closure instructions that shall include instructions for inner packaging and receptacles, a description of the types and dimensions of closures and any other significant information.

9.6.4 Explosives

All explosive item containers or boxes shall be properly marked and labeled to include part number, National Stock Number (NSN), Department Of Transportation (DOT) hazard class (see section 9.6.5), compatibility group and quantity. In addition to meeting requirements noted above, the following packaging requirements shall be met:

1. Explosive components or assemblies should be packaged singularly in compliant individual packaging.
2. If more than one item must be packed within an outer container ensure all items are the same part number. All parts contained within shall be listed on outer packaging. Ensure all inner items are packaged in compliant singular containers or boxes marked and labeled in accordance with the packaging requirements of this document.
3. When not feasible to package a singular part number (i.e. packaged as a kit) all items contained within shall be listed on outer packaging. All inner parts shall be packaged in compliant singular containers or boxes and marked and labeled in accordance with the packaging requirements of this document.

9.6.5 Hazard Class Labels

Preprinted Hazard Class Labels are available online from various sources. Attach labels to the containers on the same side as the address labels. Laminating or covering the label with clear plastic is acceptable to improve label durability. To ensure shipment labeling meets all of the Department of Transportation's standards, consult website: <http://www.gpo.gov/fdsys/pkg/CFR-1999-title49-vol1/content-detail.html> Note: Type label name in search window.

Non-Flammable Gas Label



Flammable Liquid Label



Corrosive Label



Class 9 Label

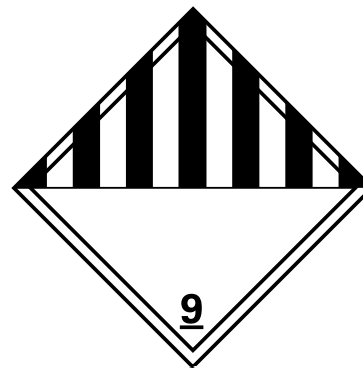

Lithium Battery Label



Cargo Aircraft Only



9.6.5.1 Hazard Class Labels - Minimum Sizes

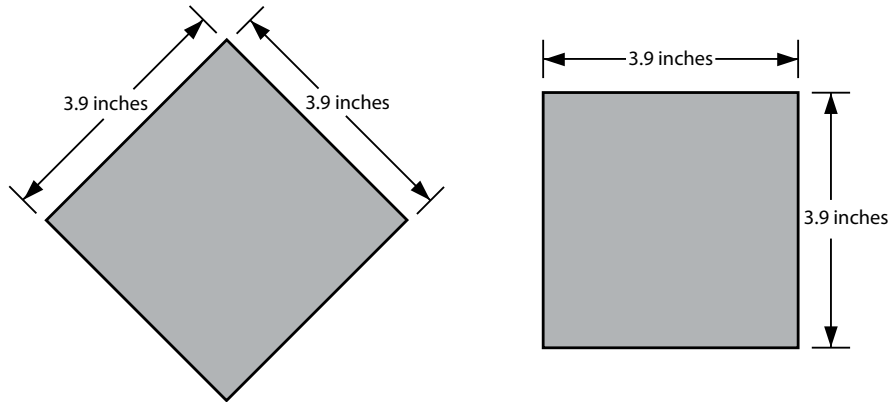

9.7 High Risk Shipments

High Risk Shipments are defined as items where the shipping container requires specialized handling, loading techniques and devices, which are required to protect the item during shipment, storage, installation, or removal. Seller shall place the High Risk Shipment mark shown below on four sides of package so it is in visible range of receiving personnel. Make the mark at least 4 inches high and in red or black ink. To download this symbol go to: http://www.lockheedmartin.com/us/aeronautics/materialmanagement/scm-shipping/scm-shipping_shippinginstructions/pm-5010labels.html





This marking should be used when a shipping container requires more than one standard rated forklift truck (3,000 lbs capacity) to safely perform the unloading process and/or when the shipping container is top heavy and could tip over easily if not properly handled.

10.0 SPECIAL HANDLING SYMBOLS

This section shows symbols from ASTM D5445. The items listed below may be applied to the package as a label or as printed text directly on the package. The method of application is left largely to each shipper to determine the best method unless otherwise specified below. Downloadable PDF files are available at: http://www.lockheedmartin.com/us/aeronautics/materialmanagement/scm-shipping/scm-shipping_shippinginstructions/pm-5010labels.html



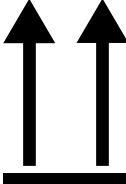
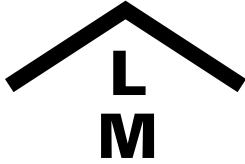

10.1 General Symbols

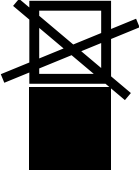
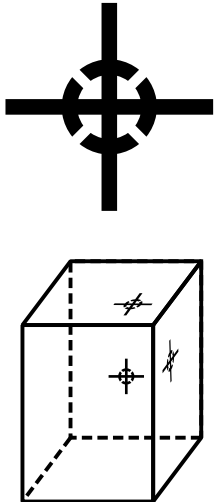
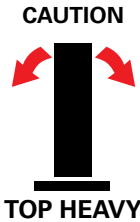
Sample of symbol or special label	Description
	<p>Fragile indicator.</p> <p>This symbol shall be printed or affixed directly on the carton.</p>
	<p>Keep Dry indicator.</p> <p>This symbol shall be printed or affixed directly on the carton.</p>
	<p>This End Up</p> <p>This symbol shall be printed or affixed directly on the carton. Place it on two opposite sides of carton in the area closest to upper left corner of vertical panel. This symbol is used routinely to indicate optimum stacking orientation.</p>
	<p>High Risk Shipment</p> <p>This symbol shall be printed or affixed directly on the carton. Place it on all four sides of carton. This symbol is used when the shipping container requires specialized handling, loading techniques and devices.</p>

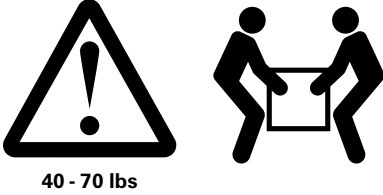

10.2 Stacking Safety Symbols

Sample of symbol or special label	Description
	<p>Stacking - Safe Stack Height.</p> <p>The number, N, identifies the maximum number of boxes that should be stacked vertically. It is to be printed on the carton. This symbol is required for packages to indicate safe stack height with regard to tipping over or calculated limits of package compression strength.</p>
	<p>Do not stack</p> <p>Stacking of the container is not allowed and no load should be placed on it</p>
	<p>Center of Gravity Indicator</p> <p>These should be used on containers which are top heavy or unevenly weighted. The location of the placement of this indicator should be provided by appropriate engineering personnel.</p> <p>Four are used - one on each vertical side to indicate the location of the center of gravity. This symbol is required for large crates regardless of height.</p>
	<p>Top Heavy</p> <p>The label should be placed on the two narrowest vertical sides of the product package.</p>

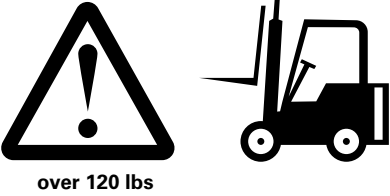
10.3 Lifting Safety Symbols

Sample of symbol or special label	Description
	<p>Safety Alert symbol</p> <p>The Safety Alert symbol is generally followed by the word "DANGER" or "CAUTION" in large bold letters:</p> <ul style="list-style-type: none"> • DANGER: Applicable to situations with the potential of causing death or serious injury. • CAUTION: Applicable to situations with the potential of causing moderate or minor injury.
	<p>Weight warning symbol: Heavy Package 25 - 40 lbs</p> <p>The Weight symbol is comprised of the Safety Alert symbol, followed by the weight range of the box.</p>
	<p>Weight warning symbol: Heavy Package 40 - 70 lbs</p> <p>The Weight symbol is comprised of the Safety Alert symbol and two figures lifting a box, followed by the weight range of the box.</p>
	<p>Weight warning symbol: Heavy Package 70 - 120 lbs</p> <p>The Weight symbol is comprised of the Safety Alert symbol and three figures lifting a box, followed by the weight range of the box.</p>
	<p>Weight warning symbol : Heavy Package over 120 lbs</p> <p>The Weight symbol is comprised of the Safety Alert symbol and a forklift, followed by the weight range of the box.</p>

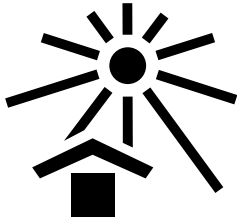
10.4 Environmental Transportation Symbols

Sample of symbol or special label	Description
	<p>Not for outside storage</p> <p>Container should be stored inside a structure. Avoid exposure to the elements.</p>
	<p>Container must be covered at all times during shipping</p> <p>Container must be covered by tarp or better during shipping</p>

10.5 Time Sensitive Contents Symbols

Sample of symbol or special label	Description
	<p>Age Sensitive Contents</p> <p>This symbol is required on all cartons containing Age Sensitive Items. Remove all items from container immediately after delivery</p>

11.0 SUPPLY CHAIN SECURITY

11.1 Ensuring Supply Chain Security

Lockheed Martin supports the U.S. Customs and Border Protection (CBP) Customs-Trade Partnership Against Terrorism (C-TPAT) initiative. The C-TPAT program is a joint effort between CBP and the trade community to reduce the threat of terrorism, by protecting the integrity of cargo imported into the United States. To the extent that the Seller is a foreign supplier of imported goods, it agrees to utilize, based on risk, appropriate security measures throughout the supply chain such as transportation, conveyance, warehouse, broker, consolidators or other elements. The Seller agrees to work with business partners to ensure that effective security measures are in place and adhered to and, where necessary, develop sufficient security measures within its own supply chain. If the Seller is uncertain as to whether Supply Chain Security applies to a shipment, the Seller is to contact LM Supply Chain Security Lead Vicki Nichols (vicki.l.nichols@lmco.com).

The Seller shall ensure the following processes are in place to assist the Buyer in supporting the U.S.C-TPAT) initiative. The following instructions pertain to the Seller's exporting, shipments to the U.S.

- A. The shipping papers shall contain accurate weight, piece count of the number of boxes shipped and value of goods in U.S. dollars as stated on the PO.
- B. The Seller shall ensure that shipments of ocean containers and truck trailers are secured with high security mechanical seals. Seals must be affixed at the manufacturer point of origin (loading) and shall meet or exceed the ISO guideline for high security seals "ISO 17712:2013, Freight Containers – Mechanical Seals". The Seller shall record all seal numbers on the shipping paperwork.
- C. The physical integrity of the ocean container structure shall be verified/inspected prior to loading, to include the reliability of the locking mechanisms of the doors.

For ocean containers, the following 7-point inspection process is required:

- 1) Front wall; 2) Left side; 3) Right side; 4) Floor; 5) Ceiling/Roof; 6) Inside/Outside doors; 7) Outside/Undercarriage.



For truck trailers, both truck and trailer require a 17-point inspection that must be completed and documented on all containers/trailers/conveyances bound for the U.S. Per C-TPAT guidelines, the following 17-point inspection process is required:



Strengthening the Customs-Trade Cooperative Partnership



11.2 Container and Trailer Security

Container and trailer integrity must be maintained to protect against the introduction of unauthorized material and/or persons. At the point-of-stuffing, procedures must be in place to properly seal and maintain the integrity of the shipping containers and trailers. A high security seal must be affixed to all loaded containers and trailers bound for the U.S. All seals must meet or exceed the current ISO 17712:2013 standard for high security seals.

In those geographic areas where risk assessments warrant checking containers or trailers for human concealment or smuggling, such procedures should be designed to address this risk at the manufacturing facility or point-of-stuffing.

11.3 Ocean Container and Truck Trailer Storage

Ocean containers and truck trailers under the supplier's/shipper's control or located in a facility of the supplier/shipper must be stored in a secure area to prevent unauthorized access and/or manipulation.

11.4 Security and Control of Container and Trailer Seals

The international supplier/shipper must affix a high security seal to all fully loaded ocean containers or truck trailers (i.e. from Canada or Mexico) bound for the U.S. when such trailers and containers are stuffed at the supplier's/shipper's location.

International suppliers/shippers must have documented procedures in place to manage, control and record the issuance and use of high security bolt seals. Such procedures should include procedures for recognizing and reporting compromised seals and/or containers/trailers. Only designated employees should distribute and apply seals for security purposes. Best practices include storing seals in a locked area or cabinet, limiting access to select employees, and keeping a documented inventory of all seals.

International supplier/shippers must contact the LM Aeronautics Monitoring and Response Center (AMRC) immediately at 1-877-214-5230 upon knowledge of any security breach affecting Aeronautic goods (contraband, smuggling, or threatening/suspicious activities).

12.0 APPLICABLE DOCUMENTS

The following specifications and standards are supporting documents and are to be used in conjunction with this PM-5010 document for clarification or further instruction where appropriate. Any questions not covered herein should be directed to the Buyer.

12.1 Materials

- Commercial Packaging: ASTM D3951-10 – Standard Practice for Commercial Packaging
- Corrugated: ASTM D4727/D4727M-12 – Standard Specification for Corrugated and Solid Fiberboard Sheet
- Cushioning: PPP-B-1672-D – Boxes, Shipping, Reusable with Cushioning
- Fiberboard: ASTM D5118/D5118M – Standard Practice for Fabrication of Fiberboard Shipping Boxes
- Seals: ISO 17712:2013 – Freight Containers – Mechanical Seals
- Shapes: Stock (Container Grade) and Cut Shapes
- Wood: A-A-55057A – Panels, Wood/Wood Based; Construction and Decorative
- PM-4043 Supplier Electrostatic Discharge Damage Prevention Requirements - LM Internal Document
- PM-4053 Tooling Manual - LM Internal Document

12.2 Military Standards

- MIL-STD-2073-1E

12.3 Industrial Manuals

- National Industrial Security Program Operating Manual (NISPOM), Sections 5-408 and 5-409
- NSA Industrial COMSEC Manual (NSA Manual 90-1, Section 6 – latest version)

12.4 Other

- Incoterms – Uniform International Rules for Trade Terms

13.0 DEFINITIONS

The following list of definitions clarify terms used in this document:

Case: An exterior container within a palletized unit load or an individual shipping container.

Drop Shipment: Lockheed Martin owned material the supplier delivers to a destination other than LM Aero.

LM Catalog Orders: Any purchase order that is 12 characters in length and begins with the letters "EC". An example would be "EC0000000256".

Item (plural Items): Refers to the supplies to be shipped in connection with the PO. "Item" and its plural, "Items", are interchangeable with the defined word "Work" as may be used elsewhere in the PO.

Palletized Unit Load: The arranging cases or packages on a pallet – secured, strapped or fastened to the pallet – so the whole palletized load is handled as a single unit.

Piece Part Packaging: The encasing, boxing, enclosing or wrapping an individual part numbered assembly or a grouping (contained in a fiberboard box, bag, etc.) of identical consumable items such as screws, rivets, etc. Piece part packaging can be the final packaging which is used in the shipping of said assemblies or groupings and/or it can be the package which contains such assemblies or groupings for the purposes of warehouse/supply storage and/or it can be the package which is aggregated with other such packages inside a consolidation container/crate / fiberboard box in accordance with ASTM-D5118/D5118M for shipping purposes.

Repairable Item: An item which, by the application of engineering, economic, and other factors, could be reasonably restored to a serviceable condition through regular repair procedures.

Shall: "Shall" expresses a requirement that is binding on Seller or Buyer, as noted.

Other Types of Teammate Furnished Hardware Items: Includes planned omission, traveled work, incomplete task log (ITL), flight test, mock-ups, test articles, tooling and contract deliverables.

14.0 ACRONYMS

3PL	3rd Party Logistics
ALGS	Autonomic Logistics Global Sustainment
ASN	Advanced Shipping Notice
CAGE	Commercial and Government Entity
CBP	U.S. Customs and Border Protection
CONUS	Continental United States
C-TPAT	Customs-Trade Partnership Against Terrorism
DOT	Department of Transportation
ESD	Electrostatic Discharge Sensitive
FOD	Foreign Object Debris/Damage
IT	Information Technology
ITL	Incomplete Task Log
IUID	Item Unique Identification
LM	Lockheed Martin
LRU	Line Replaceable Unit
MIL-STD	Military Standard
MRB	Material Review Board
MSDS	Material Safety Data Sheet
NON-IUID	Non Item Unique Identification
OEM	Original Equipment Manufacture
PHS&T	Packaging, Handling, Storage and Transportation
PO	Purchase Order
RFID	Radio Frequency Identification

15.0 ADDRESSES

Buyer's Packaging Engineer Address:

Lockheed Martin Aeronautics Company – Fort Worth
P.O. Box 748
Fort Worth, TX 76101
Attn: Packaging Engineering
Mail Zone: 6888

Lockheed Martin Aeronautics Company – Marietta
86 South Cobb Drive
Marietta, GA 30063
Attn: Packaging Engineering
Mail Zone: 0664

Lockheed Martin Aeronautics Company – Palmdale
1011 Lockheed Way
Palmdale, CA 93599
Attn: General Receiving
Plant 10, Bldg. 601

Lockheed Martin Aeronautics Company – Palmdale
1011 Lockheed Way
Palmdale, CA 93599
Attn: Hazardous Materials Receiving
Plant 10, Bldg. 644d.

SUPPLEMENT A: F-35 ADDITIONAL PACKAGING, LABELING AND SHIPPING GUIDELINES

This F-35 program-specific set of instructions pertains to Shipments of F-35 Global Sustainment items from Seller Locations to Regional Warehouses (3PL), Retail Military Supply Locations, Retail Contractor Logistics Services (CLS) Supply Locations, and Military Depot Supply Locations.

February 4, 2015

TABLE OF CONTENTS

1.0 <u>OVERVIEW</u>	60
2.0 <u>PACKAGING GUIDELINES</u>	60
2.1 F-35 Low Rate Initial Production	
2.2 F-35 General Packaging Information (Repairable Items Only)	
3.0 <u>SHIPPING CONTAINERS</u>	61
3.1 Dual Function and Reusable Containers for F-35 LRIP Assets	
4.0 <u>LOOSE PARTS KITS - Production</u>	62
4.1 Part Numbers Within Loose Parts Kits	
4.2 Kit Contents	

1.0 OVERVIEW

The following instructions are F-35 unique requirements and are intended as a supplemental document to the PM-5010 Packaging, Labeling and Shipping Guidelines document. The Seller is contractually bound to insure that any subcontractors or sub-tier entities that may ship F-35 items on their behalf are in compliance with this working instruction. Any topics not addressed in this F-35 Additional Guidelines document shall revert back to the PM-5010 Packaging, Labeling and Shipping Guidelines base document.

2.0 PACKAGING

2.1 F-35 Low Rate Initial Production

Seller shall package all F-35 assets in accordance with Commercial Standard ASTM D3951-10 or a recognized equivalent commercial packaging standard such as BS1133 (British Standard-Commercial). If Seller determines a Commercial Packaging Standard cannot meet the known distribution and environment requirements associated with the delivery, storage and end-use, Seller shall pack in accordance with MIL-STD-2073-1E or Def Stan 81-41.

2.2 F-35 General Packaging Information (Repairable Items Only)

Seller shall package all F-35 assets in accordance with Commercial Standard ASTM D3951-10 or a recognized equivalent commercial packaging

PART NUMBER _____	
NATIONAL STOCK NUMBER (NSN) _____	
NOMENCLATURE (DESCRIPTION) _____	
CAGE (SUPPLIER/SELLER) _____	
SQAR NUMBER _____	
ITEM DIMENSIONS (INCHES)	LENGTH _____ WIDTH _____ HEIGHT _____
ITEM WEIGHT _____	
ITEM FRAGILITY RANGE (SEE BELOW) _____	
IS ITEM SUSCEPTIBLE TO ESD DAMAGE?	YES _____ NO _____
IS ITEM SUSCEPTIBLE TO CORROSION?	YES _____ NO _____
ARE THERE CRITICAL SURFACES ON ITEM?	YES _____ NO _____
PRESERVATIVE REQUIREMENTS	YES _____ NO _____
PACKAGED DIMENSIONS (INCHES) LENGTH _____ WIDTH _____ HEIGHT _____	
<ul style="list-style-type: none"> • Fragility range definition – the maximum energy permitted to reach the item during transportation and handling. • Note: approximate fragility factors are listed in MIL-STD-2073-1E, Table I 	

3.0 SHIPPING CONTAINERS

3.1 Dual Function and Reusable Containers for F-35 LRIP Assets

Seller shall provide a Dual Function or reusable container when delineated in the PO. Seller shall be responsible for the maintenance of the reusable or dual function container. Seller shall use a reusable container for all repairable items, e.g. Fast-Pack (PPP-B-1672-D). See Supplement D of this document for additional guidance.

4.0 LOOSE PARTS KITS - Production

The Seller will receive manufacturing/engineering planning work instructions from the Buyer's Purchase Order (PO). These instructions will define kitting requirements that includes which loose parts are applicable for each component.

Seller shall package all loose parts into the pre-determined Loose Parts Kit "CARD" Numbers as an individual kit. Seller shall tag each loose part number for a component shipping to LM. Each loose part shall be tagged and kitted together based on LM instructions within the P.O. Each tag must be similar to LM Tag 12687-05162011 (purple color - see below), and have the following information:

- Bag & Tag for FWT (Ft. Worth) or MAR (Marietta)
- Part Number
- Kit Number - Each Kit number shall be called out according to the P.O.'s special instructions within the OPOS (Outside Production Operation Sheet).
- TV/E Number (Type Version / Effectivity) the part is being tagged against.

Example: Tagging for Loose Parts Kits



Tag size is approximately 6" x 3"

Example: Loose Parts Kits



4.1 Part Numbers Within Loose Parts Kits

Seller shall label every Bag & Tag Kit coming from outside facilities, with the following label on the Kit bag. The contents of the label shall be circled with the LM delivered-to-site location.

It shall also include:

- Title of Kit Number
- MKPL #
- CR#
- Item #
- SB
- Date Sent Out
- Kit Need Date
- Effectivity of Kit
- And any Misc. Notes.

4.2 Kit Contents

The package contents sheet shall be placed within each “Loose Parts Kit” clear plastic box. The kit shall also have a “Kit Contents Label” - showing a visual location of each part number, which shall be visible inside the plastic box.

Example: Labeling for Loose Parts Kit within the box

KIT CONTENTS				
2WSH33265-0001 & 2WSH33612-0001				
2WSH33265-0001 & 2WSH33611-0001				
2WBH03481-0001	2WBH04317-0001	2WSH43540-0001	2WSH43542-0001	JSFM34AB06CPW
2WBH02183-0003 (2EA)	2WBH04846-0002 (3EA)		2WSH43916-0001	

SUPPLEMENT B: F-16 ADDITIONAL PACKAGING, LABELING AND SHIPPING GUIDELINES

This F-16 program specific set of instructions pertains to Shipments of F-16 Global Sustainment Items from Seller Locations to Regional Warehouses (3PL), Retail Military Supply Locations, Retail Contractor Logistics Services (CLS) Supply Locations, and Military Depot Supply Locations.

February 4, 2015

1.0 Additional Bar Code Data Elements for F-16 Block 60

For Shipments Direct to UAE or CONUS Inventory Accumulation (Non-Production Support) Shipments, Seller shall bar code the container unless deviation is granted by the Buyer. See example below. Seller shall construct these bar codes as follows:

A. Part number

B. Concatenated Bar Code containing the following:

- i. CAGE Code
- ii. Alphanumeric Identifier – 1 character (used to identify type of serial number, e.g., CFE, Vendor Assigned, Locally Assigned, etc.)
- iii. Serial Number - Date of Manufacture (Year/Julian date; e.g.: 12022 = 2012 January 22)

2.0 Additional Label for F-16 Block 60

For Shipments Direct to UAE or CONUS Inventory Accumulation (Non-Production Support Example)

Standard PO eCAT JSF TFE Block 60

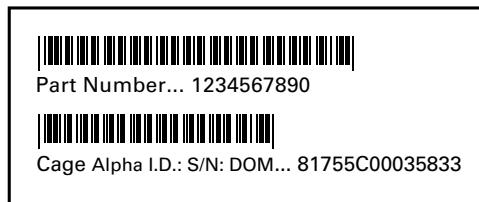

Part Number

The part number may be up to 20 characters long. If the part number is less than 20 characters long the remainder of the field will be blank. If the part number is greater than 20 characters only the first 20 characters will be utilized.

CAGE Code

Seller shall use the 5-digit Commercial and Government Entity code.

Alpha ID

The identifier designates who assigned the serial number that follows. Serialized items should use a capital "C" for this field. This designates that the Supplier/Seller provided the serial number. For all non-serialized items, a capital "N" will be used; which will indicate no serial number is available.

Serial Number

This is a 5-digit serial number field. If an item is not serialized, the serial number field shall be zero filled (00000) by the Seller. For repair and return shipment, the serial number MUST be present-for both outbound and inbound shipments.

Date of Manufacture (DOM)

This is a four digit Julian date. This is the item's actual date of manufacture, if known. Seller shall provide the date of manufacture if it can be determined. However, if the date of manufacture is unknown, seller shall complete the field with the date packaged/ shipped. For repair and return shipments, the DOM should be the date packaged/shipped.

Note: For F-16 Block 60 shipments Direct to UAE or CONUS Inventory Accumulation (Non-Production Support), the Standard P.O. and LM Catalog bar code labels identified in this document apply. If a consolidation box is used, the bar code label should be on the outside of the consolidation box. Each individual container inside the consolidation box shall have the appropriate bar code label attached by the Seller.

SUPPLEMENT C: F-22 ADDITIONAL PACKAGING, LABELING AND SHIPPING GUIDELINES

This F-22 program specific set of instructions pertains to Shipments of F-22 Global Sustainment Items from Seller Locations to Regional Warehouses (3PL), Retail Military Supply Locations, Retail Contractor Logistics Services (CLS) Supply Locations, and Military Depot Supply Locations.

February 4, 2015

1.0 F-22 Non-Production Packaging

Seller shall package F-22 consumable and hardware items in accordance with Commercial standards.

Seller shall package Repairable / Spares in accordance with MIL-STD-2073-1E.

SUPPLEMENT D: RETURNABLE REUSABLE CONTAINERS & FIXTURES (RRCF)

Enable extended logistics capabilities supporting Lockheed Martin Aeronautics' programs utilizing Returnable Reusable Containers and Fixtures (RRCF).

February 4, 2015

1.0 Objective

Returnable Reusable Containers and Fixtures (RRCF) are any pre-approved container or fixture designed to be reusable in an effort to increase supply chain efficiency, affordability and sustainability. RRCF are utilized between Lockheed Martin Aeronautics locations and the supply base.

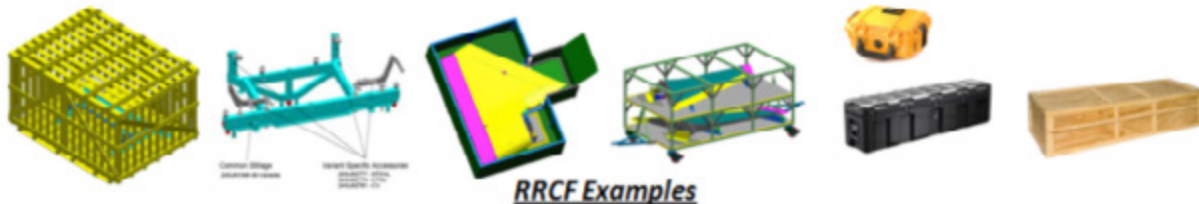

This method of packaging is intended for supporting multiple, repeated shipments of component(s) or part(s). All materials, structure and dunnage used in RRCF is designed and constructed to adequately withstand the demands of multi-modal transportation between point of manufacture and receiving locations without failure.

The selection of RRCF design may vary upon the component or part, method of transportation and the material handling requirements at suppliers and Lockheed Martin Aeronautics locations. When RRCF is utilized, certain basic factors will be considered:

- **Focus on affordable, efficient and sustainable packaging solutions**
- **Minimize material handling effort, equipment and tools required to:**
Load, crate, ship and transport then receive, uncrate and re-crate for return shipment to suppliers
- **Multi-modal transportability and appropriate shock, G-force and environmental protection, as appropriate.**
- **Consistency in design, features and function across component/part families and multiple receiving locations.**
- **Dunnage reduction and simplified reconfiguration supporting multiple variants of the component/part.**
- **Efficient movement and ergonomically safe handling by internal transportation using multiple methods.**
- **Appropriate presentation and unobstructed access of the component/part for end users.**
- **Minimize floor space required for un-packaging, re-assembly and storing of RRCF.**
- **Durability and longevity of RRCF maximizing life span and reduction of maintenance and repairs.**

• **Total life cycle cost of RRCF:**

- Design, construction materials, quantities in rotation and investments.
- Inbound and reverse logistics costs between point of manufacture and receiving locations including premiums for special handling, equipment and permitted or escorted loads.
- Internal material handling, capacity, identification and tracking cost at both supplier and Lockheed Martin Aeronautics locations.
- Scheduled maintenance, repairs and/or replacement costs for damaged RRCF.
- Disposal cost

Multiple RRCF options are available for suppliers to evaluate and propose. As most designs and material types are applicable, more efficient designs and material selection can provide greater benefits in support of affordability and sustainability objectives over the life of a program.

RRCF -Wood Crate Example

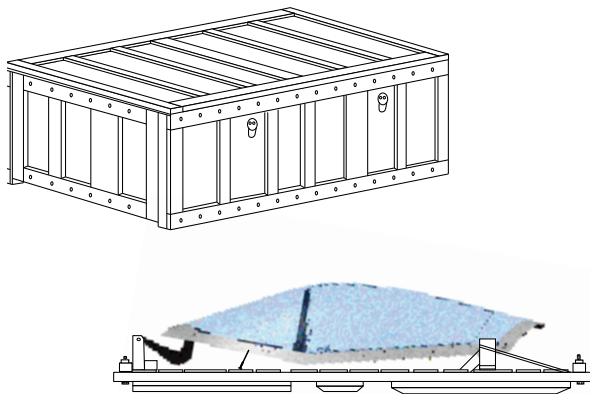

Less Optimized for Sustainability and Affordability

- Single Tier Supply Chain Application
- Overhead Crane Requirements for Crating/Un-crating
- Lag Bolt Installation and Removal of Crate Top
- Greater Material Handling and Transportability Requirements
- Greater Repair, Maintenance and Replacement Requirements
- Less Procurement Cost per Container, Lesser Operational Savings

RRCF - FRP Composite/Carbon Fiber

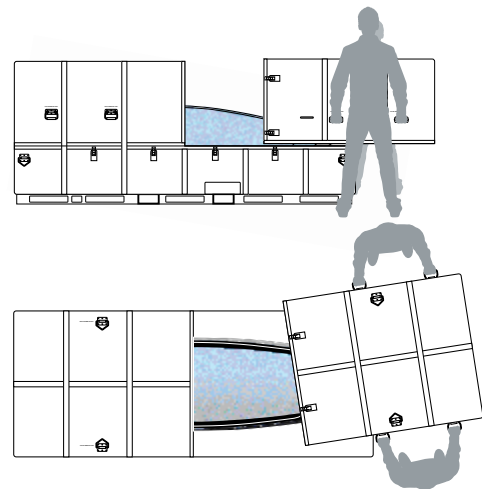

Most Optimized for Sustainability and Affordability

- Designed for Production and Global Sustainment Use
- Supports Multiple Supply Chain Tiers and Receiving Locations
- Ergonomic design and efficiencies Including Quick-Release Latches
- Stackable a Efficient use of Floor Space
- Multi-Modal with Material Handling and Transportability Efficiencies
- Reconfigurable Dunage Supporting Multi-Tier Component Build-Up
- Minimum Repair/Maintenance Requirements
- More Procurement Cost per Container, Greater Operational Savings

The following illustration demonstrates Lockheed Martin Aeronautics' RRCF Strategy in a multi-tier environment supporting both; a Program's Global Assembly Sites and Sustainment requirements for given component(s).

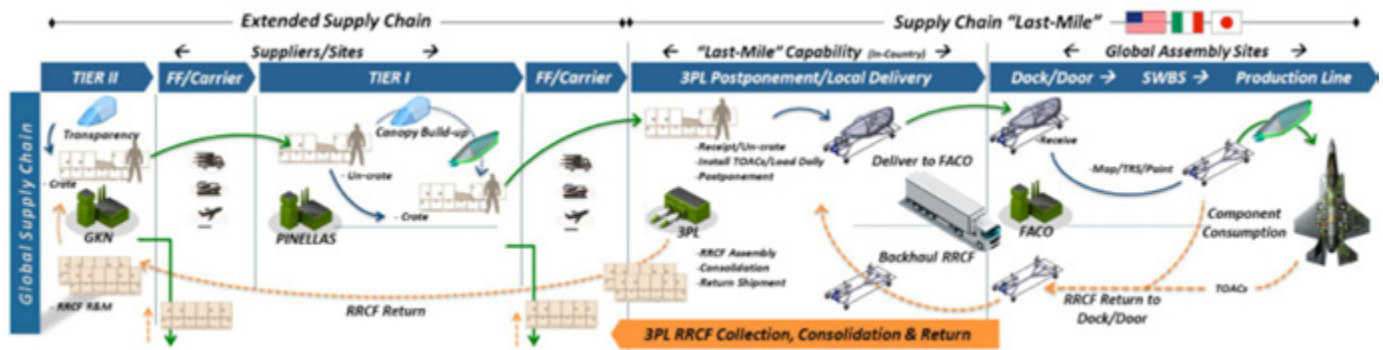

Suppliers, Buyers, Program and Supply Chain Logistics CORE should collaborate and gain complete understanding of the supply chain when considering RRCF to assure its capability is fully scoped and utilized to its fullest extent for the component(s) being evaluated.

Suppliers considering RRCF coordinate with their Buyers on solutions proposed. Buyers then coordinate with Supply Chain Logistics CORE and Programs for an internal Lockheed Martin Aeronautics evaluation of the proposed solutions to assure alignment with Affordability, Sustainability and Transportability objectives.

When RRCF is selected, suppliers are responsible for inspection, repair and maintenance. The use of original, damage-free RRCF perpetuates a commitment to quality and FOD free products. Damaged RRCF shall be repaired before its re-introduction into the supply chain. The use of faulty RRCF can lead to further damage of the RRCF, its contents or represent a material handling or safety hazard.

2.0 RRCF Markings/License Plates

Additional markings are necessary for all approved RRCF to assure they are appropriately identified for Lockheed Martin Aeronautics return processes. An example and description of the marking is provided below.



RRCF Marking/License Plate

Marking Colors:	Construction Orange background with bold Black letters
Size:	Appropriate size in relationship to RRCF being marked, easily seen and identified from a distance
Return To:	Supplier name and State (or) Country Code
Ship-to-Party:	Supplier's Ship-to-Party number assigned by Buyer within Lockheed Martin Aeronautics SAP MRP/ERP System and used to process the SAP outbound delivery to supplier
	Reserved area on the marking for a Lockheed Martin Aeronautics visual color code to be applied indicating internal return instruction

Markings should either be stenciled with paint, plastic or metal plates, industrial labels, lanyards for smaller accessories or similar type. Marking methods and materials used should be based on application and permanently secured to the RRCF.

All markings should be placed on RRCF in clear view of employees and in multiple locations for larger fixtures and containers. Material flow may require that container, fixture or tooling accessories be separated when moving RRCF to and from the production line. Supplier should consider marking each "major" container, fixture and tooling accessory piece that may be separated to assure they are all identified for return.

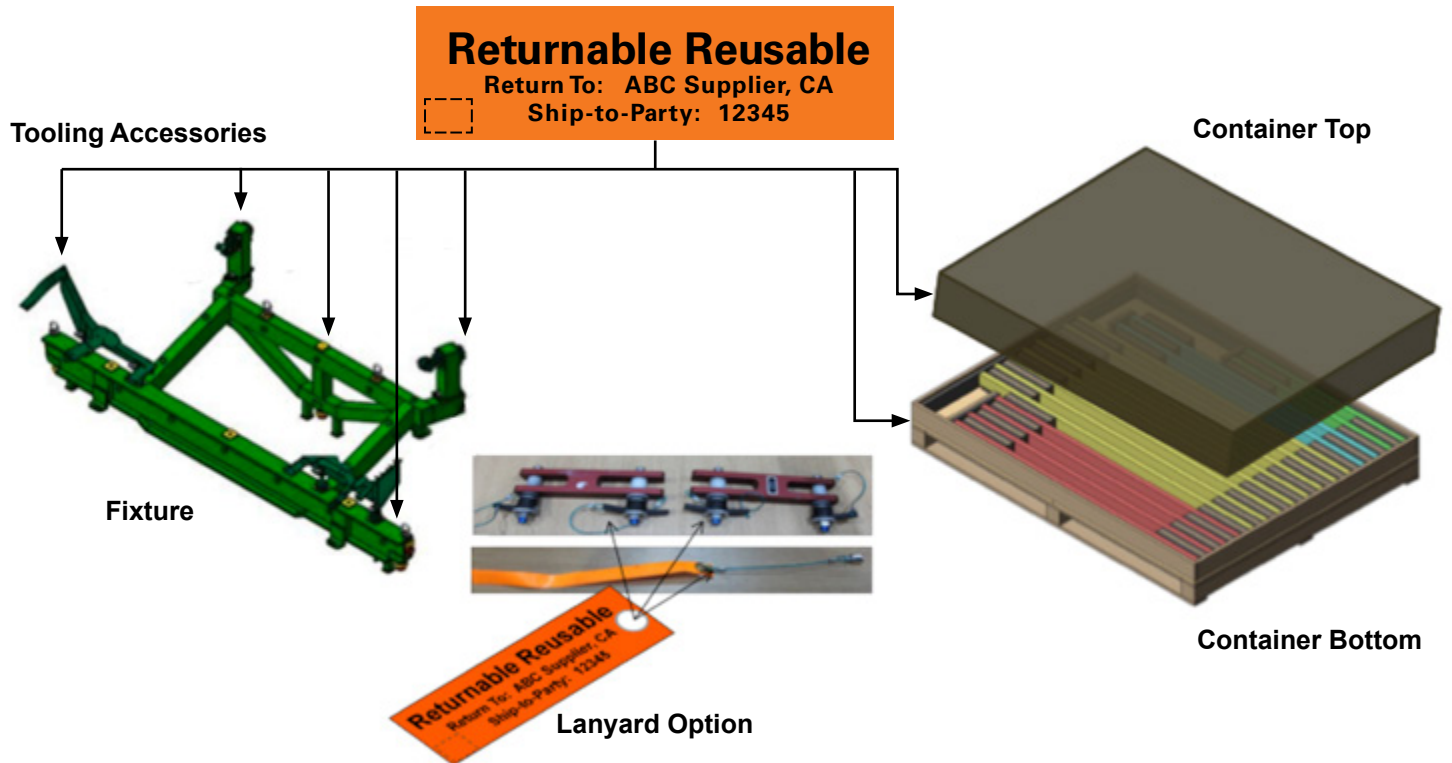

Smaller tooling accessories to be returned together may be accompanied by an empty shadow box kit that includes an inventory list. The shadow box should include the appropriate RRCF marking for return of its contents.