

FreeStyle Shaper Optimizer & Profiler



Preface

- Using This Guide
- More Information

What's New?

Getting Started

- Starting the FreeStyle Workbench
- Creating a First Surface
- Editing the Surface
- Creating a Second Surface
- Creating a Blend Between Surfaces
- Applying a Global Deformation

Basic Tasks

- Opening a New CATPart Document
- Importing and Exporting Files
- Creating and Managing Curves
 - Creating Associative 3D Curves
 - Creating 3D Curves on a Scan of Cloud
 - Creating Curves on Surface
 - Projecting Curves
 - Creating Blend Curves
 - Styling Corners
 - Matching Curves
 - Editing Curves Using Control Points
 - Smoothing Curves
 - Extrapolating Curves
 - Extending Curves
 - Trimming Curves
 - Concatenating Curves
 - Fragmenting Curves
 - Approximating/Segmenting Procedural Curves
- Creating and Managing Surfaces
 - Creating Planar Surfaces
 - Creating 3-Point Surfaces
 - Creating 4-Point Surfaces
 - Creating a Surface on an Existing Surface
 - Creating Revolution Surfaces
 - Editing Surfaces Using Control Points
 - Editing a Surface Boundary
 - Extruding Surfaces

- Offsetting Surfaces
- Extrapolating Surfaces
- Creating Blend Surfaces
- Creating an ACA Fillet
- Creating Filling Surfaces
- Creating Associative Filling Surfaces
- Manipulating Surfaces Using the Compass
- Rotating Surfaces Using the Compass
- Matching Surfaces
- Multi-Side Matching
- Extending Surfaces
- Smoothing Surfaces
- Redefining Surfaces Limits
- Restoring a Surface
- Concatenating Surfaces
- Fragmenting Surfaces
- Disassembling Elements
- Approximating Procedural Surfaces
- Copying Geometric Parameters
- Creating a Continuity Constraint

Analyzing Curves and Surfaces

- Checking Connections Between Surfaces
- Checking Connections Between Curves
- Performing a Curvature Analysis
- Analyzing Distances Between Two Sets of Elements
- Using Dynamic Cutting Planes
- Analyzing Using Highlight Lines
- Performing a Surfacic Curvature Analysis
- Performing a Draft Analysis
- Mapping an Environment on a Surface
- Analyzing Using Isophotes
- Analyzing Using Highlights

Generic Tools

- Setting FreeStyle Visualization Options
- Displaying Geometric Information on Elements
- Displaying a Part Symmetrically
- Analyzing Using Parameterization
- Managing the Compass
- Using Manipulators
- Defining an Axis System
- Using the Stretch View Analysis Tool
- Manipulating Views
- Defining Views
- Creating Datums
- Performing a Symmetry on Geometry
- Keeping the Initial Element
- Inserting in a New Geometrical Set
- Creating a Temporary Analysis
- Auto-detection
- Setting the Manipulators Attenuation Factor

- Displaying Manipulators On Elements
- Displaying Control Points Temporarily
- Inserting Geometrical Sets
- Selecting a Support
- Editing and Keeping a Point

Advanced Tasks

- Using FreeStyle Optimizer
 - Fitting a Curve to a Cloud of Points
 - Fitting a Surface to a Cloud of Points
 - Globally Deforming Surfaces
 - Analyzing Reflect Curves
 - Creating Inflection Lines
- Interoperability Between the FreeStyle Shaper & Optimizer
 - Creating Four-Points Patches
 - Deforming the Surface Limits
 - Fitting the Surface to a Cloud of Points
 - Analyzing the Surface
 - Smoothing the Surface
 - Extracting the Surface
- Using FreeStyle Profiler
 - Creating a Net Surface
 - Creating a Styling Sweep
- Interoperability with Part Design
 - Creating a Sketch and a Pad
 - Creating a Surface
 - Splitting the Pad
 - Modifying the Splitting Surface
- Interoperability with Wireframe
 - Creating Points
 - Creating Lines
 - Creating Planes
 - Creating Circles

FreeStyle Interoperability

- Optimal CATIA PLM Usability for FreeStyle

Workbench Description

- Menu Bar
- Creation Toolbars
- Modification Toolbars
- Analysis Toolbar
- Generic Tools Toolbar
- FreeStyle Dashboard
- FreeStyle Constraints Toolbar
- Views Toolbar
- Wireframe Toolbar
- Specification Tree

Customizing

Glossary

Index

Preface

FreeStyle Shaper is a powerful modeling tool used to dynamically design all types of surface elements, from the stylist's drawing to the final surface, ready for the manufacturing processes.

Using this product you can generate free form 3D curves and surfaces from scratch, and dynamically deform and analyze all produced elements.

Using the FreeStyle Optimizer you can create and modify curve and surface shapes based on other elements such as digitized data.

Using FreeStyle Profiler, you can directly create complex surfaces based on profiles and sets of curves in one step, without having to deform them in a second step.

The FreeStyle Shaper, Optimizer & Profiler User's Guide has been designed as an aid to using the FreeStyle Shaper, FreeStyle Optimizer, and FreeStyle Profiler by themselves, but also in conjunction with other CATIA Version 5 workbenches.

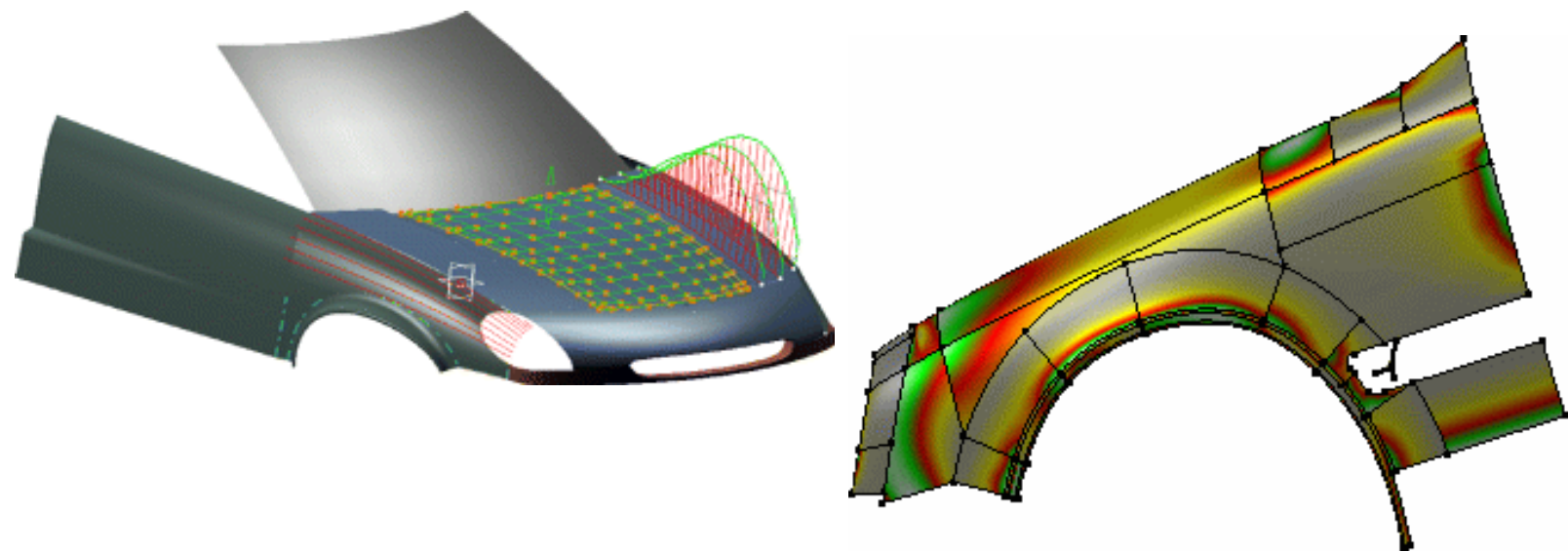

[Using This Guide](#)
[More Information](#)

Using This Guide

This User's Guide is intended for the user who need to become quickly efficient with the FreeStyle Shaper, FreeStyle Optimizer, and FreeStyle Profiler.

Before reading it, you should be familiar with the basic CATIA Version 5 concepts, such as the document windows, standard toolbars and menus.

To make the most out of this book, we suggest that a beginning user reads the [Getting Started](#) chapter first of all and the [Workbench Description](#) to find his way around the FreeStyle Shaper workbench.

User's familiar with the product should browse the Table of Contents rapidly, then move on directly to specific sections of interest to them: curve and surface creation, edition, and analysis. More advanced users, and those using the FreeStyle Optimizer will find an [Advanced Tasks](#) and [Customizing](#) chapters that should answer their needs.

Where to Find More Information

Prior to reading this book, we recommend that you read the *Infrastructure User's Guide* that describes generic capabilities common to all products. It also describes the general layout, and interoperability between workbenches.

Also read the *CATIA V4 Integration User's Guide* that presents interfaces with standard exchange formats and most of all with CATIA V4 data.

See also the [Conventions](#).

What's New?

New Functionalities

Managing Ordered Geometrical Sets

Optimal CATIA PLM Usability for FreeStyle

Enhanced Functionalities

Creating and Managing Curves

Creating Associative 3D Curves

New **Automatic order** option when creating a Near Points 3D curve

New **smoothing** options when creating a Near Points 3D curve

You can now impose a **curvature constraint** when creating a Near Points 3D curve

Creating Blend Curves

Tensions are now homogenized between blend surfaces and blend curves

Extending Curves

Multi-selection of curves is now possible

New options are available from the contextual menu: **Slave** and **Free**

Trimming Curves

The **Tools Palette** is now available to help you select elements in the 3D geometry

New Break type: **curves by points**

Curves by curves Break type: the **Break Report** panel enables you to manage the information on the cutting elements

Curves by curves Break type: you can now **cut the cutting elements** in the curves by curves Break type

Curves by curves Break type: new **contextual menu** to choose which parts of the curves to keep or not

Creating and Managing Surfaces

Creating Blend Surfaces

Tensions are now homogenized between blend surfaces and blend curves

Redefining Surfaces Limits

The **Tools Palette** is now available to help you select elements in the 3D geometry

The **Break Report** panel enables you to manage the information on the cutting elements

New **contextual menu** to choose which parts of the curves to keep or not

Analyzing Curves and Surfaces

Analyzing Distances Between Two Sets of Elements

New **Texture** option to allow a check by color distribution

Checking Connections Between Surfaces

New **Light** option to detect discontinuities

Generic Tools

Generic Tools

Setting FreeStyle Visualization Options

A new contextual option is available to [keep all patches limits](#)

The [Insert in a new geometrical set](#) is available from the FreeStyle Dashboard

Advanced Tasks

Globally Deforming Surfaces

The Keep option is now available from the FreeStyle Dashboard

Getting Started

The following tutorial aims at giving you a feel of what you can do with FreeStyle Shaper & Optimizer. It provides a step-by-step scenario showing you how to use key capabilities.

The main tasks proposed in the chapter are:

Starting the FreeStyle Workbench
Creating a First Surface
Editing the Surface
Creating a Second Surface
Creating a Blend Between Surfaces
Applying a Global Deformation

 All together, this scenario should take about 15 minutes to complete.

The final surface element will look like this:

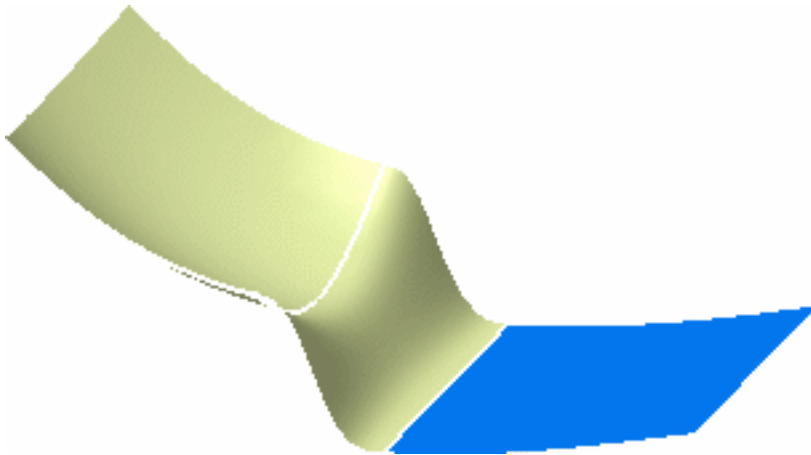

Starting the FreeStyle Workbench

The first task will show you how to enter the FreeStyle Shaper workbench.

The only pre-requisite for this task is to have a current CATIA V5 session running.

1. Choose **FreeStyle** from the **Start** -> **Shape** menu, or click the FreeStyle icon  from the

Welcome to CATIA V5 dialog box. The FreeStyle Shaper workbench is displayed and ready to use.

The workbench looks like this:

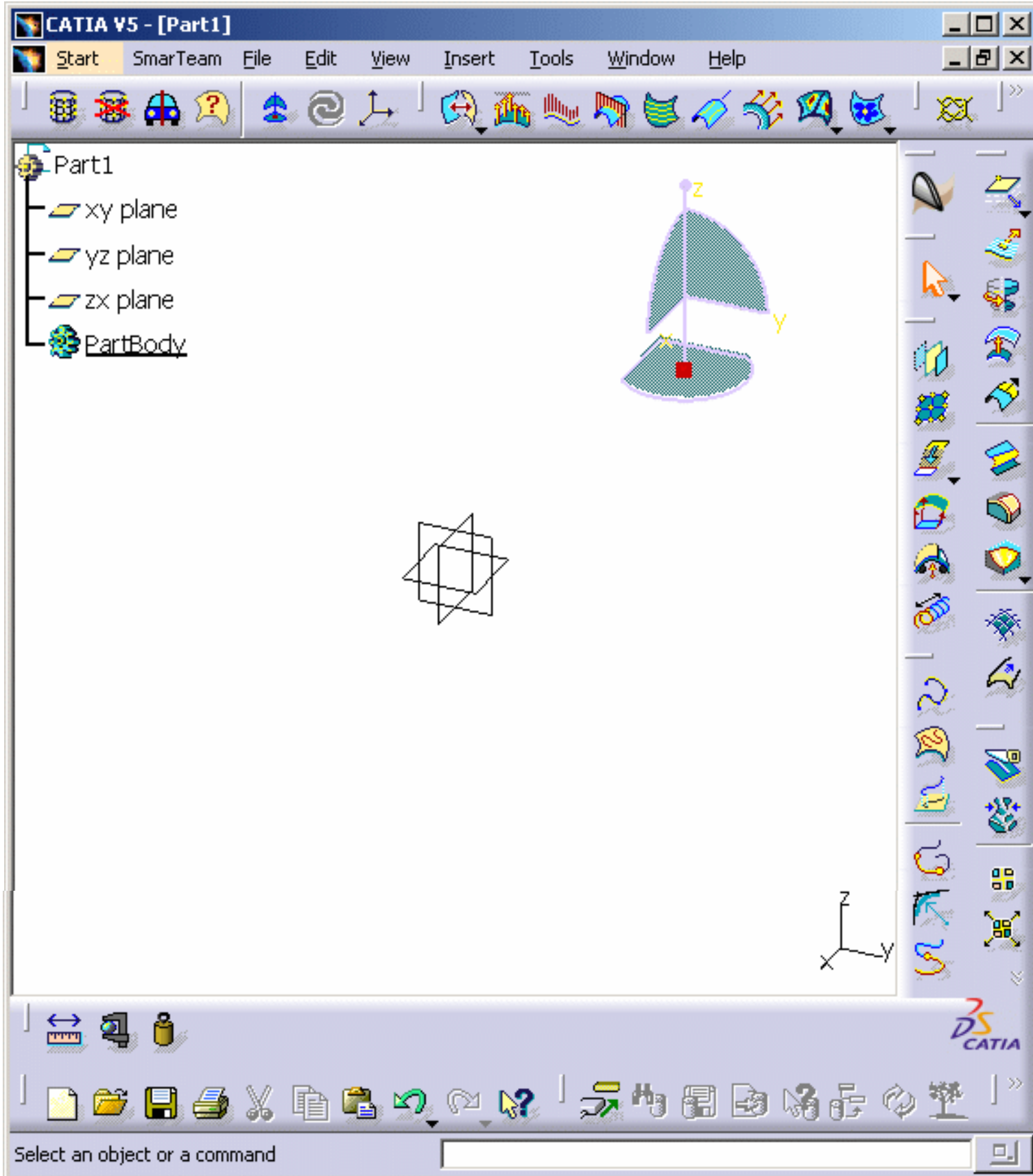

 If you wish to use the whole screen space for the geometry, remove the specification tree clicking off the **View -> Specifications Visible** menu item or pressing F3.



Creating a First Surface



The first task will show you how to create a single-patch planar surface in the current plane.



1. Select the **Planar patch** icon 

2. Right-click in the document and choose the **Edit Orders** item from the contextual menu.

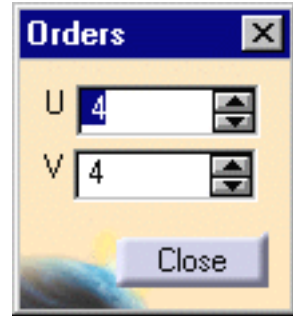

You can now define the degree of the mono-patch surface along U and V from the Orders dialog box.
Set it to 5 for along U.

3. Click **Close** when finished defining these parameters.

4. Click anywhere in the workbench, and drag the mouse.

A surface outline appears as you drag the pointer, one of its corner located where you clicked in the document.

Two values are displayed on the outline, indicating the length and width of the patch.

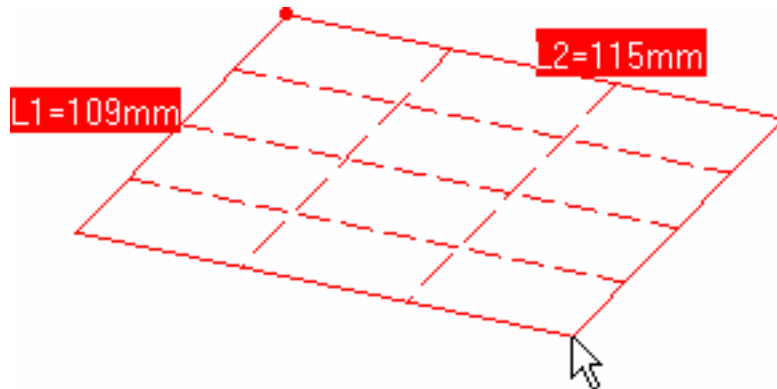

Use the Ctrl-click capability if you want the middle of the patch to be centered on the axis origin, that is centered around the point you clicked.

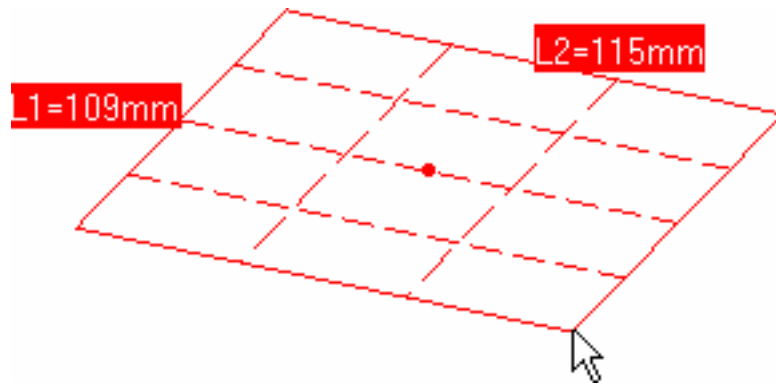

5. When you have reached the adequate size, click again.

The corresponding surface has been created.

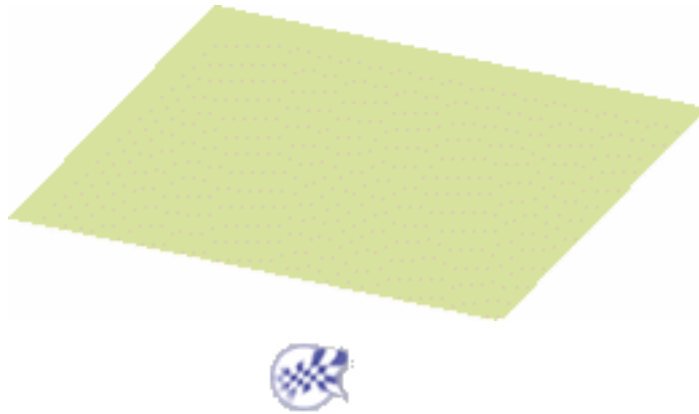

Editing the Surface

 This task will show you how to modify the surface you just created.

 **1.** Select the surface.

2. Click the **Control Points** icon 

As soon as you clicked the icon, control points and mesh lines are displayed. They are used to manually pull on the surface so as to deform it.

Deformation can also be done using the **Tuner** dialog box displayed using the Edit contextual command on control points or mesh lines.

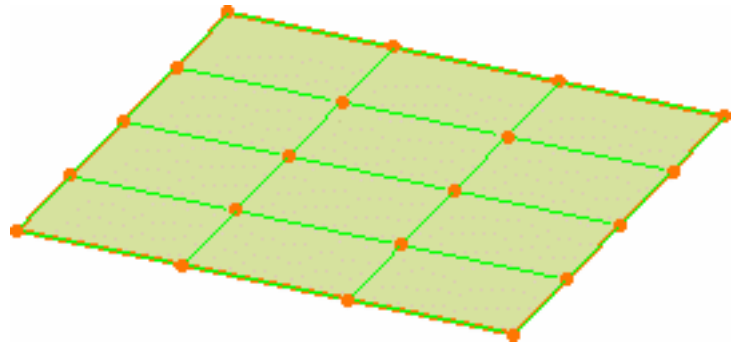

 Depending on the settings, texts may be displayed on the surface, allowing to modify the U, V **orders**, or to set **continuity** constraints on the surface edges. For further details, refer to [FreeStyle Settings](#).

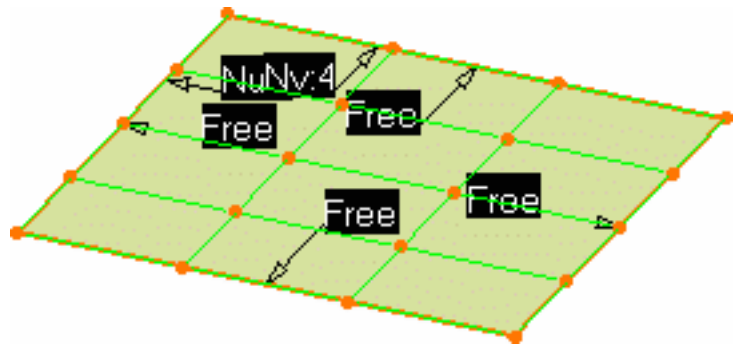

The Control Points dialog box is also displayed:

Use it to define the type of operation to be performed on the control points.

- **Support:** defines the type of translation to be applied.
- **Law:** defines the type of deformation that is to be applied when several control points have been selected.

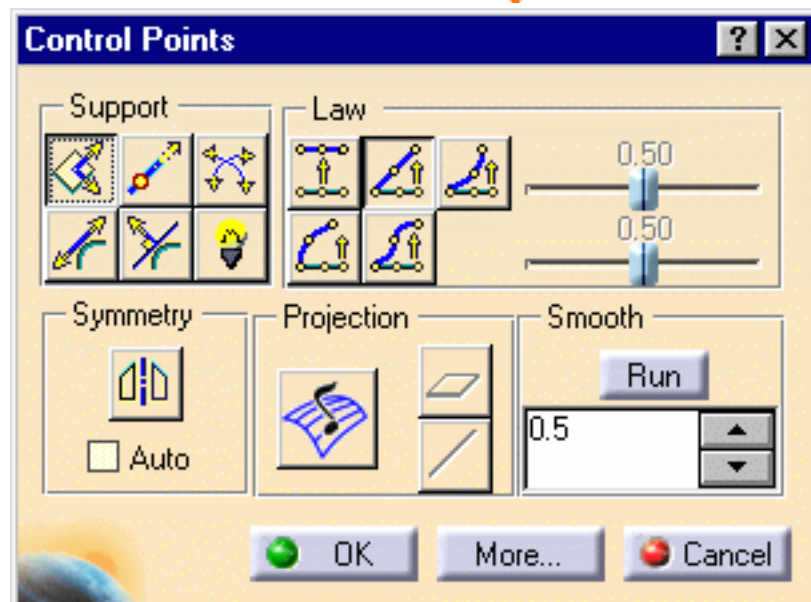

 In P1 one mode you cannot choose the support (**Translation in the plane** is selected by default) and only two laws are available:

 P1

- a. **Move selected points identically**
- b. **Stretch selected points**

3. Right-click the compass and choose the **Make YZ the Privileged plane.**

The compass is oriented likewise:

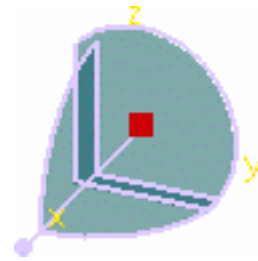

4. Move the pointer onto one of the control points or mesh lines.

Arrows automatically appear. They represent the directions in which you can perform a deformation.

5. Move onto the center mesh line and pull the bottom arrow down.

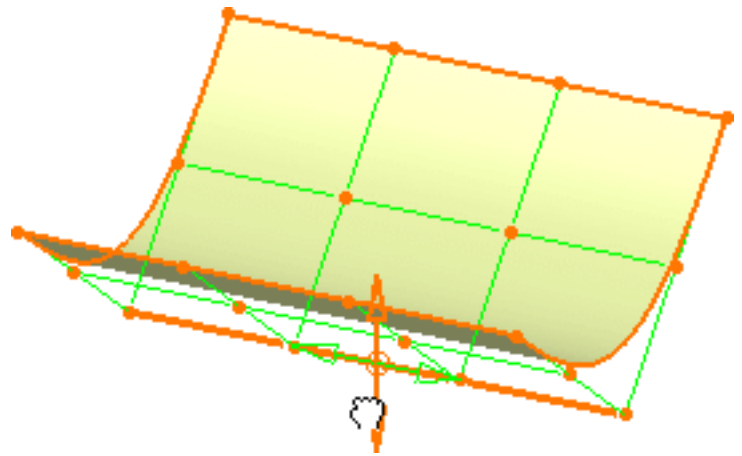

The selected control points are moved according to the translation type and law defined in the Control Points dialog box.



By default all control points and mesh lines are selected. Click a specific point to deform the surface at this point only, or select a set of points using the Ctrl-key or Shift-key while clicking (multi-selection capabilities). The same applies to mesh lines.

6. Click **OK** in the Control Points dialog box to accept the modified shape of the surface.



Creating a Second Surface



In this task you learn to blend two surfaces, that is create one surface connecting both initial surfaces, while specifying the continuity type.



1. Click the 4 Points Patch icon



in the **Surface Creation** menu to create another surface.

2. Successively click the four corner points of the first surface.

The second surface is created.

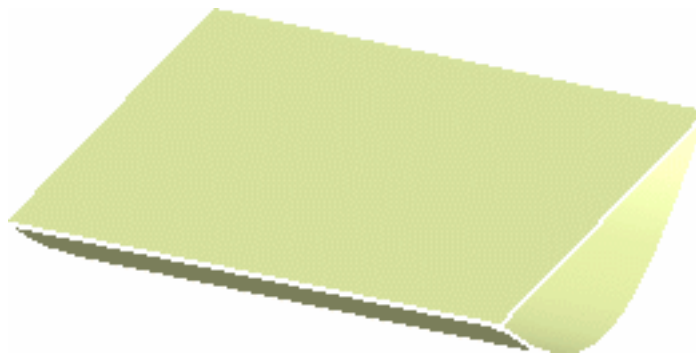
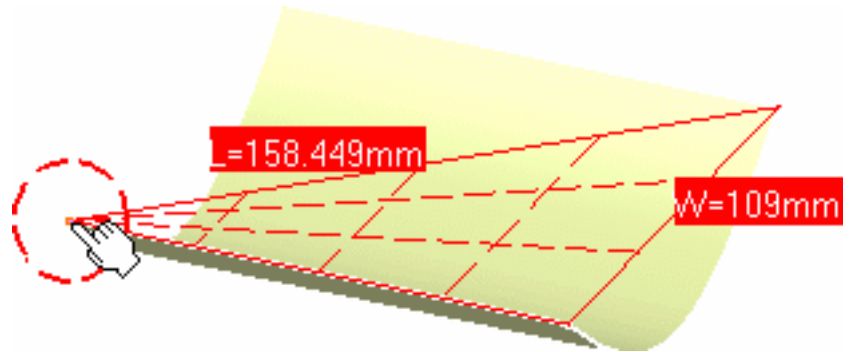

3. Select the new surface, right-click to display the contextual menu, and choose the **Properties** menu item to display the Properties dialog box.
4. From the Graphic tab, change this surface's color using the arrow in the **Color** chooser.

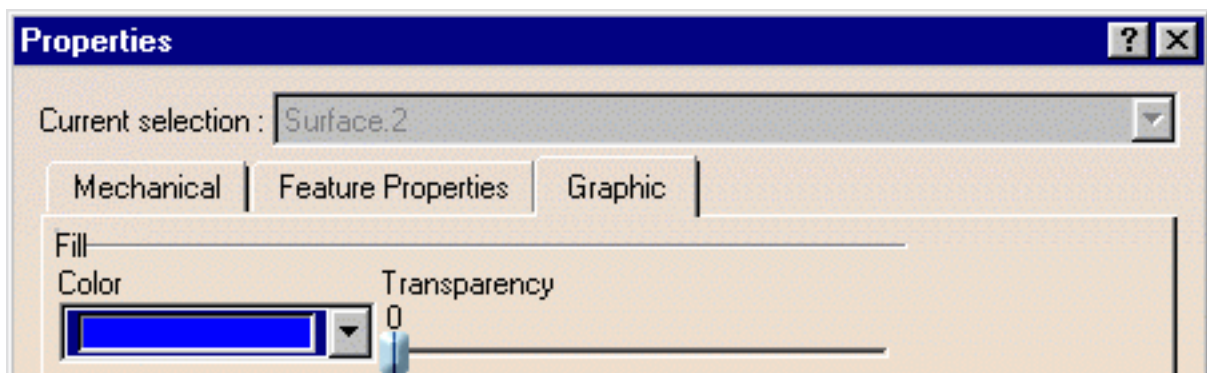

5. Click **OK** in this dialog box.
The newly created surface is clearly identifiable.

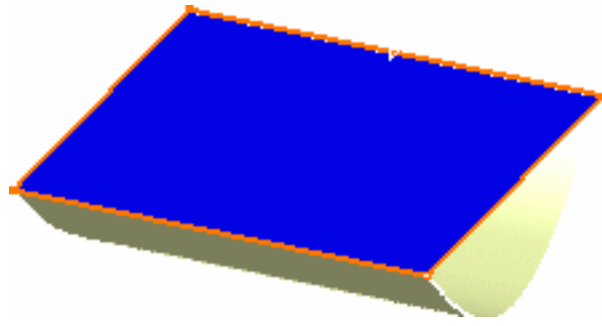

6. Move to the compass. When the pointer changes to a cross, press and hold while dragging the compass onto the new surface.

7. Move the pointer over the horizontal axis till it becomes red, and glide the surface away from the first one. Repeat this operation with gliding the surface down along the vertical axis, then grab the compass center and bring the compass over the 3-axis system at the bottom right-corner of the document. The compass is set back to its default position.

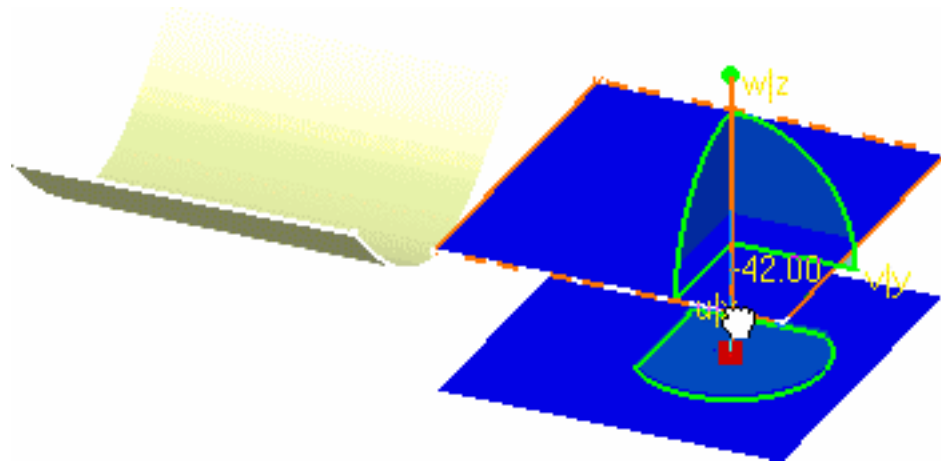

Creating a Blend Between Surfaces



In this task you learn to blend two surfaces, that is create one surface connecting both initial surfaces, while specifying the continuity type.



1. Click the **Freeform Blend Surface** icon .

The Blend Surface dialog box

is displayed.

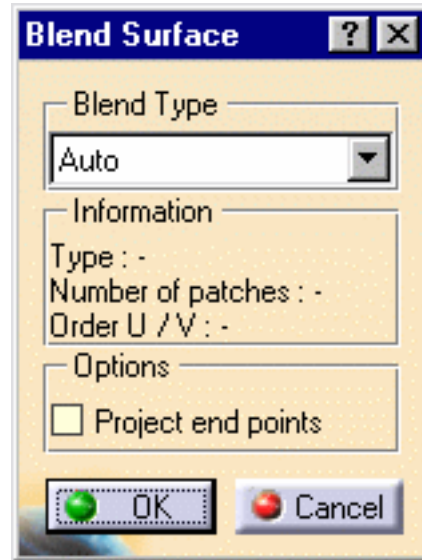

2. Select the edge of the initial surface closest to the second surface.
The boundary is highlighted.

The boundary is highlighted.

3. Select the edge of the second surface closest to the initial surface.

A blend surface is automatically computed.

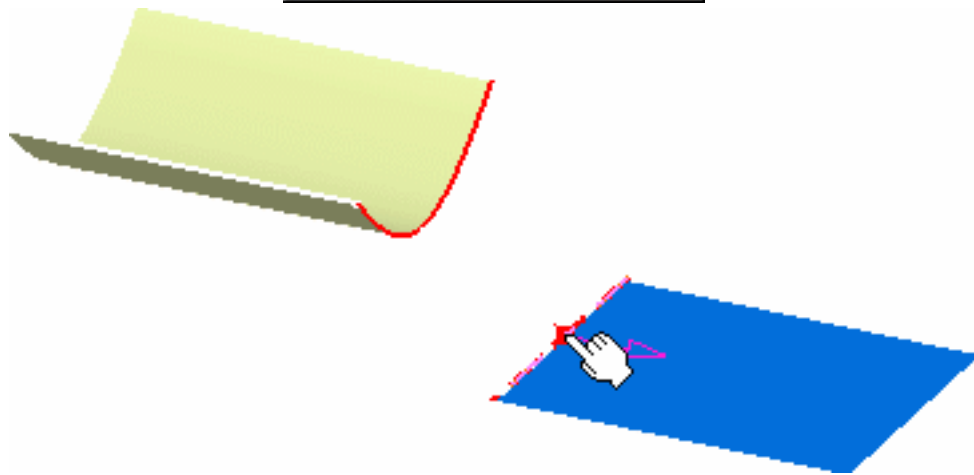

4. Click **OK** in the Blend Surface dialog box to validate the blend surface.

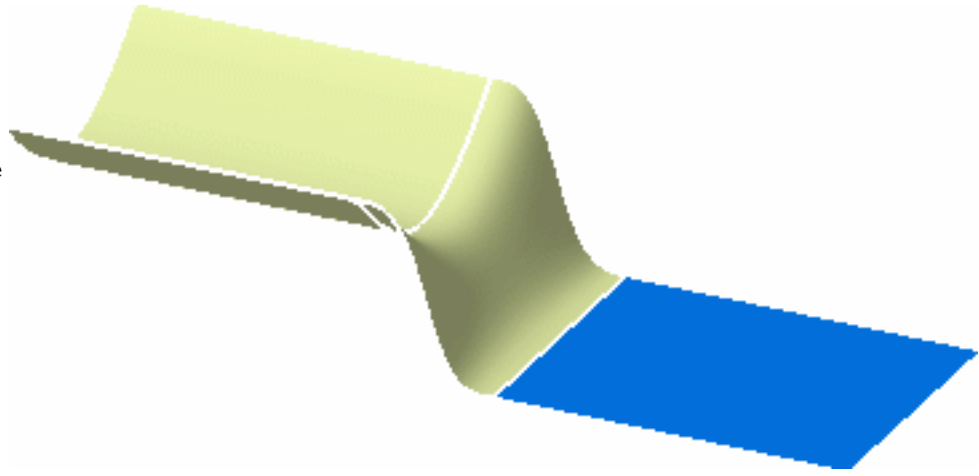



 End of the Getting Started in P1 mode.



Applying a Global Deformation



 This command is only available when using FreeStyle Optimizer.

 Now that both surfaces are linked, you want to modify all three surfaces according to a modification pattern you define in space, keeping all defined curvature continuities.

 **1.** Press and hold the Ctrl-key, then successively select all three surfaces.

2. Click the **Global Deformation** icon .

The 3D compass is displayed along with the Global Deformation dialog box into which you can specify deformation options: using an intermediate patch or an axis use.

In this case, use the default option: **Intermediate surface use**.

3. Click **Run** in the Global Deformation dialog box to accept the deformation parameter definition. The Control Points dialog box displays.

A patch with control points and mesh lines is displayed. It represents the planar patch, defined in the plane indicated by the compass, equivalent to the same bounding box as the selected surfaces.

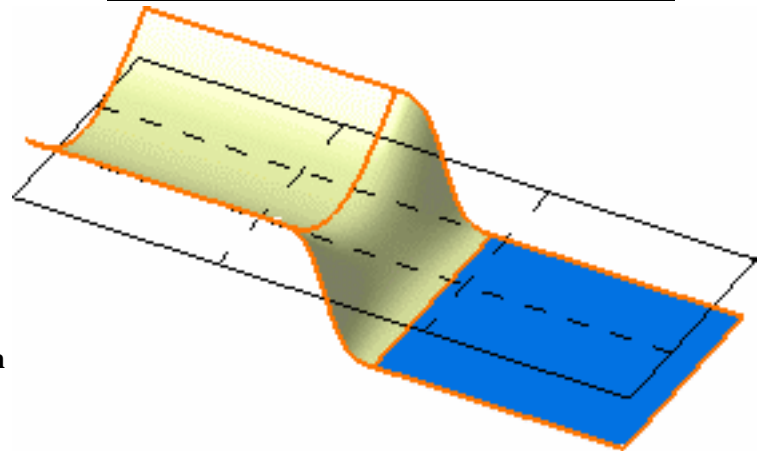
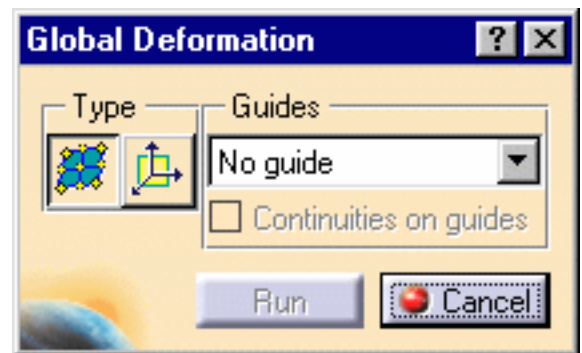

4. Use the control points and the mesh lines of the planar patch to deform it. The space transformation is defined between the initial patch and the deformed patch.

All surfaces are automatically and dynamically deformed according to this intermediate patch deformation.

5. Do not change the options and click **OK** in the dialog box.

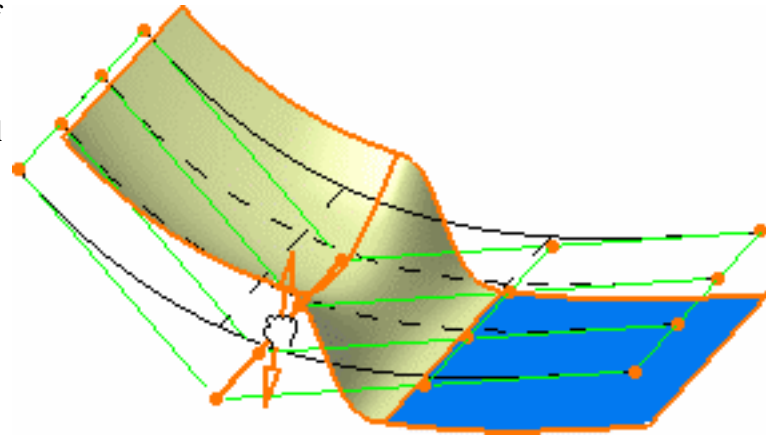

The final deformed surface looks like this.

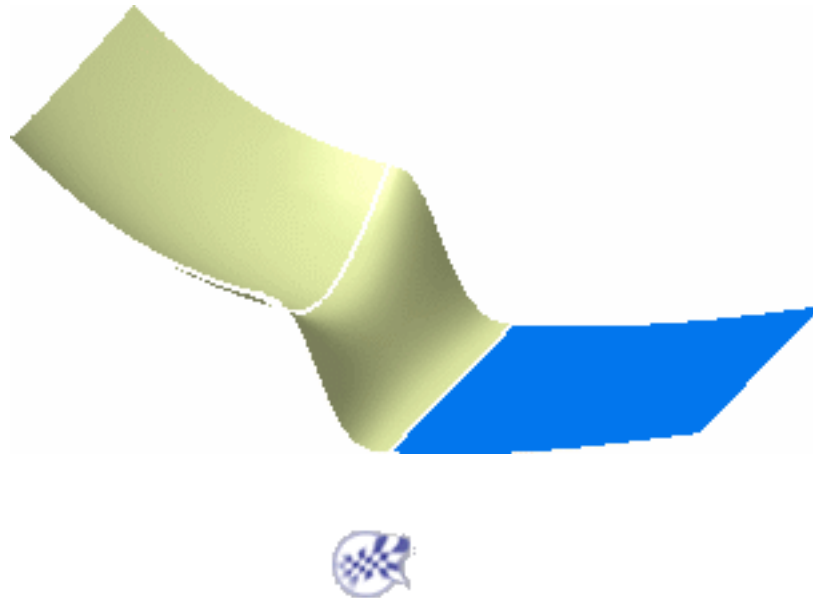

Basic Tasks

- Opening a New CATPart Document
- Importing and Exporting Files
- Creating and Managing Curves
- Creating and Managing Surfaces
- Analyzing Curves and Surfaces
- Generic Tools

Opening a New CATPart Document



This task shows how to open a new CATPart document and activate the FreeStyle Shaper workbench.



1. Select the **File** -> **New** commands (or click the New  icon).

The **New** dialog box is displayed, allowing you to choose the type of the document you need.

2. Select **Part** in the **List of Types** field and click **OK**.
3. Choose **Shape** -> **FreeStyle** from the **Start** menu.

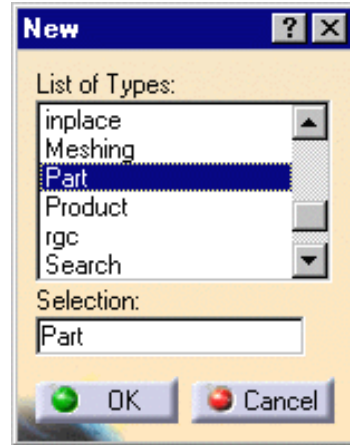

The FreeStyle Shaper workbench is loaded and a CATPart document is opened.

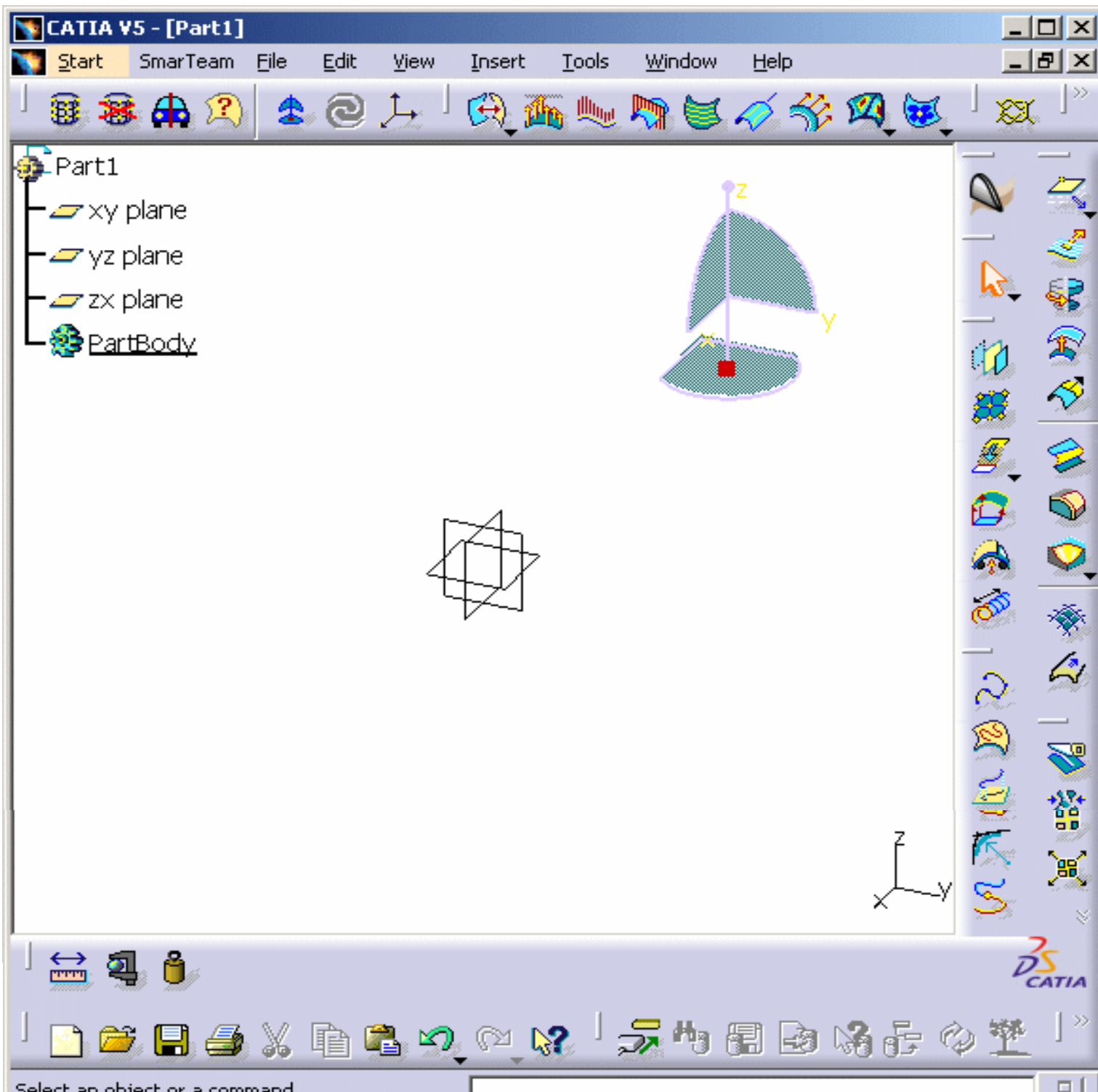

The FreeStyle Shaper workbench document is made of:

- the specification tree and the geometry area in the main window
- specific toolbars (geometry creation and modification toolbars, analysis toolbar)
- a number of contextual commands available in the specification tree and in the geometry. Remember that these commands can also be accessed from the menu bar.

The specification tree is a unique specification-driven and generative tool, which captures and reuses process specifications, ultimately accelerating the design process. It lets you concentrate the design effort on establishing the proper design specifications, while leaving it to the system to compute or update the resulting geometry when required. This specification tree can be customized using the **Tools -> Options** menu item, **Tree** tab.



- If you wish to use the whole screen space for the geometry, remove the specification tree clicking off the **View -> Specifications** menu item or pressing F3.
- You could also directly choose **FreeStyle** from the **Start** menu. It would automatically open a new CATPart document.



Importing and Exporting Files

CATIA Version 5 includes unique two-way interoperability with CATIA Version 4 data, thus allowing CATIA Version 5 to benefit from the breadth of the CATIA Solutions Version 4 portfolio.

CATIA Version 5 data can be loaded and processed in a CATIA Version 4 session. Similarly, CATIA Version 4 data can be read in a CATIA Version 5 session and converted to a CATIA Version 5 format for further edition.

Refer to the CATIA V4 Integration User's Guide for further details on how CATIA Version 4 and Version 5 interoperate.

3D data exchange and more specifically surfaces exchange between CATIA Version 5 and other CAD systems can be done through Initial Graphics Exchange Specification (IGES) format.

These exchanges are documented in the *Interfaces User's Guide (Importing and Exporting External Files)*, as they are not specific to the FreeStyle Shaper workbench, but rather to the .CATPart document type.

Therefore, refer to this chapter for a description of the specific surface elements that can be imported from or exported to the IGES Standard.

Creating and Managing Curves

This chapter deals with curve creation and management using the FreeStyle Shaper workbench.



See also the [FreeStyle Dashboard](#) tools as they affect the curve creation and modification.



Create associative 3D curves: specify the curve creation mode (passing through specific points, specifying the curve degree and smoothing the curve through points, or defining the curve control points), and click in space to indicate the curve definition points.



Creating Associative 3D Curves on a Scan of Cloud: select one or several scans on clouds, specify the curve creation mode and click in space to indicate the curve definition points.



Create free form curves on surfaces: select a surface, specify the curve creation mode (interpolation or smoothing in relation to the selected points), click definition points on the surface, double-click to end the curve.



Project curves: select a curve, the surface on which it is to be projected and specify projection parameters



Create blend curves: select two curves, activate their options display and use the contextual menu on the displayed text to modify the continuities and tension, manipulate the control points to define the blending point.



Create a styling corner: select two curves, set the radius value.



Match curves: select two curves, activate their options display and use the contextual menu on the displayed text to modify the continuities and tension, manipulate the control points to define the matching point.



Edit curves using control points: select a curve, set the deformation options, pull on the control points in specific directions



Smooth curves: select a curve or points on a curve, set the smoothing weight and click Run.



Extrapolate curves: select a curve, specify the extrapolation mode, and enter the extension value.



Extend curves: select a curve, specify the extension mode, and enter the extension value.



Trim curves: select a curve, or point on a curve, and specify the breaking options



Concatenate curves: select a multi-cell curve and set the tolerance value



Fragment curves: break a multi-arc curve into several mono-arc curves



Approximate/segment procedural curves: select a curve, specify the approximation tolerance, and resulting curve maximum orders and/or segments.

Creating Associative 3D Curves



This task explains how to create a 3D curve that is associative meaning you can add or delete points (whether control points or passing points) both at creation time or when editing.

These curves can be created in space or lie on a geometrical element, or both. When the curve lie on a geometrical element and the later is modified, the curve is updated automatically, provided you choose the **Automatic** update option in **Tools -> Options -> Mechanical Design -> Assembly Design -> General** tab.

- [Selecting 3D points](#)
- [Editing](#)
- [Keeping a point](#)
- [Imposing a Tangency Constraint](#)
- [Imposing a Curvature Constraint](#)
- [Setting as Arc Limit](#)
- [Removing a Point](#)
- [Constraining a Point](#)



Open a new .CATPart document.



1. Click the **3D Curve** icon .

The 3D curve dialog box is displayed.

2. Choose the curve creation type.

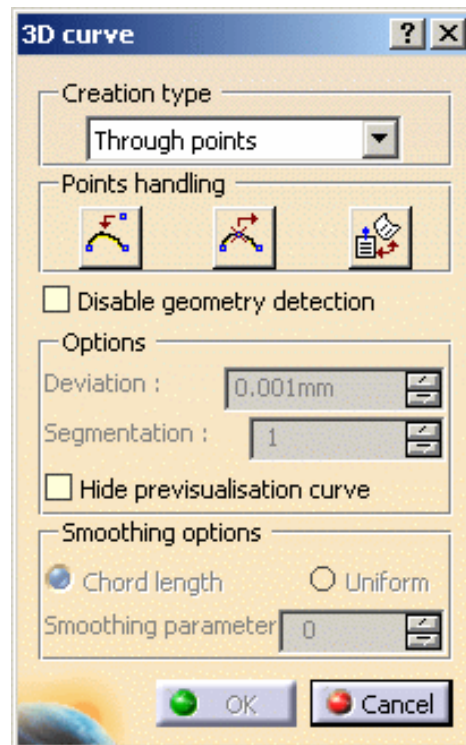

Whatever the chosen type, the curve is previewed in dotted line as you move the pointer.

- **Through points:** the resulting curve is a multi-arc curve passing through each selected point.

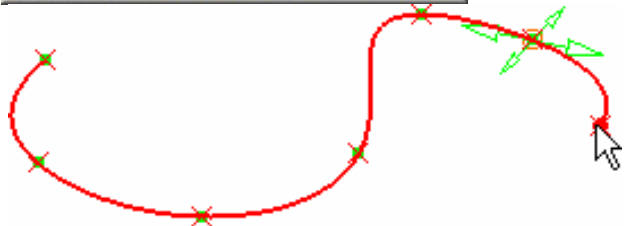

- **Control points:** the points you click are the control points of the resulting curve

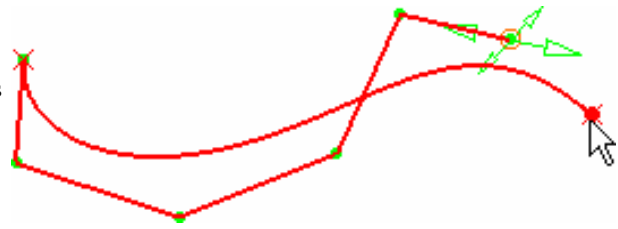

- **Near points:** the resulting curve is a single-arc, with a set degree and smoothed through the selected points.

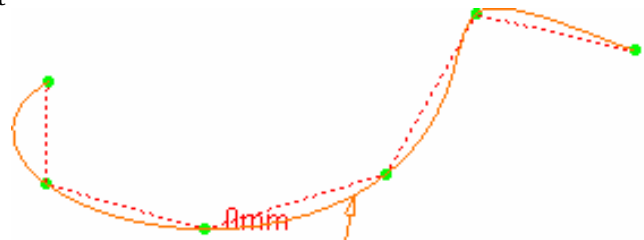

You can edit the order by right-clicking the displayed text (displayed using the U, V Orders icon



from the FreeStyle Dashboard or the **Order** option from **Tools -> Options** menu, **Shape -> FreeStyle -> General** tab), and choosing a new order value.

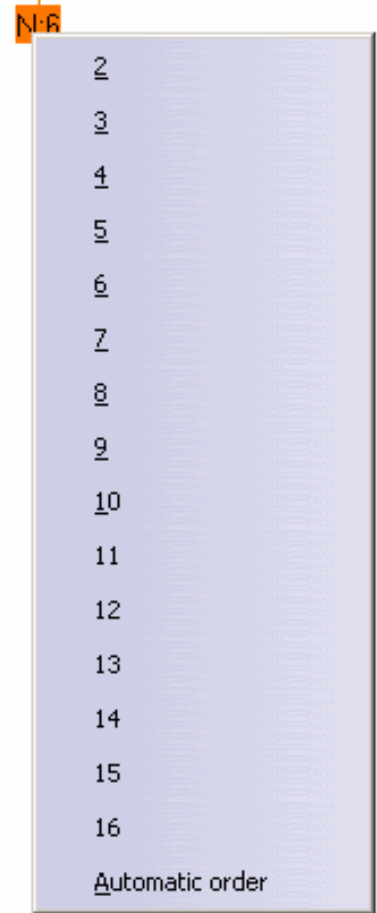

The **Automatic order** option enables you to automatically compute an order that will respect at best all the curve constraints.

The computed value is displayed near the Auto tag.

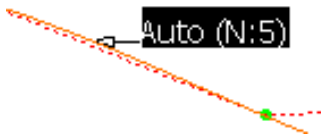

- The **Deviation** option enables the user to set the maximum deviation between the curve and the construction points.

The result is a set degree through the selected points.

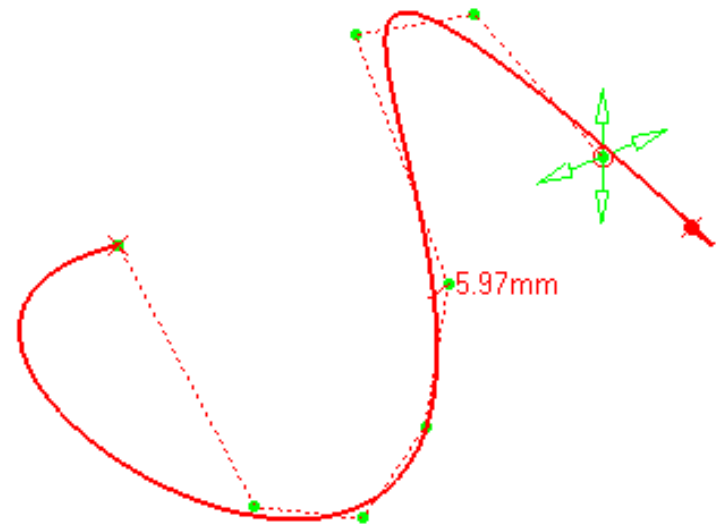

- The **Segmentation** option enables the user to set the maximum number of arc limits. These arcs are construction points and are inserted into the curve automatically. The minimum value is set to 1.



- Smoothing options are now available to parameterize the curve:

- **Chord Length** (default parameterization)
Smoothing parameter = 0

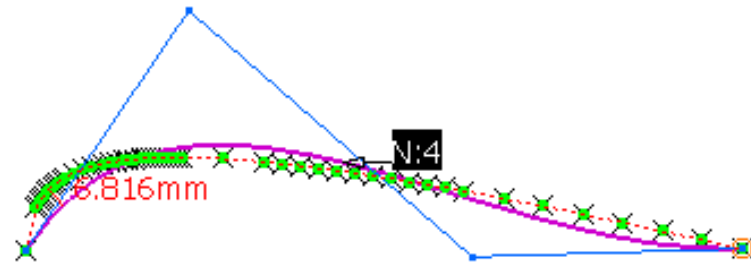

- **Uniform**
Smoothing parameter = 0

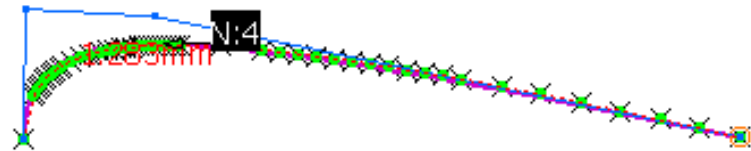

- **Smoothing parameter**: enable a better control points distribution of the smoothed curve.

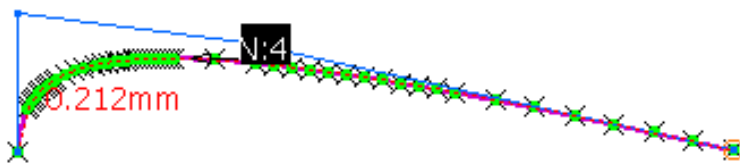

Smoothing parameter = 50

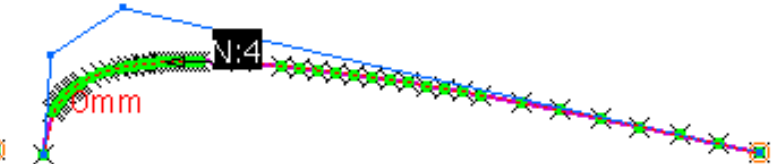

Smoothing parameter = 130



Deviation, Segmentation, and Smoothing options are only available for the Near Points creation type.

3. Move the pointer over a point.

A manipulator is displayed allowing you to modify point location as you create the curve. By default, this manipulator is on the last created point.

A **contextual menu** proposes several options to construct the 3D curve.



Right-click on the manipulator to display the contextual menu. From then on you can choose the **Edit** item to display the Tuner dialog box and enter space coordinates for the selected point, or choose the **Impose Tangency** item to set a **tangency constraint** on the curve at this point.

4. Click the **Insert a point** icon  within the dialog box.

The curve freezes.

5. Click the segment, between two existing points where you wish to add a new point and click the point location.

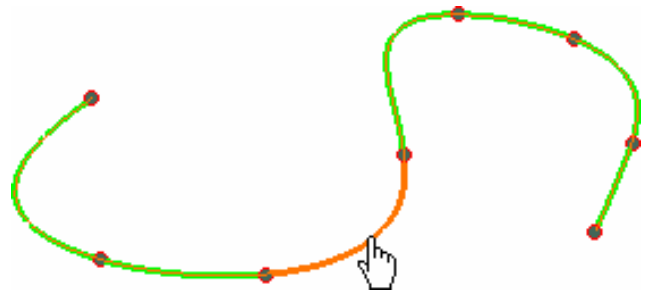

Once the point has been created, you are back to the edition capabilities on the curve.

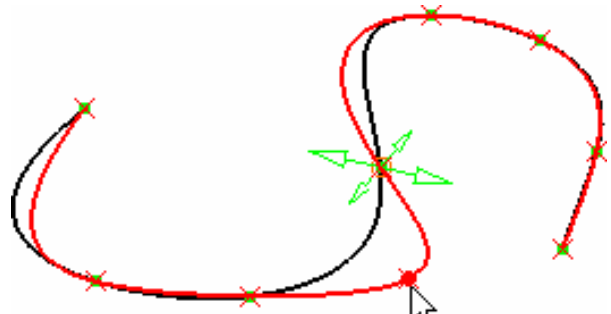

6. Click the **Remove a point** icon  within the dialog box, and select one of the existing points.

The curve is recomputed immediately without the selected point.



7. Click the **Free or constrain a point** icon  within the dialog box, then select the point.

- If the point is a point in space (free), move the pointer close to the point or a wire to which it should be linked. You can then move the pointer over a geometric element and:

- move the point to the indicated point by clicking
- press and hold the Control key (Ctrl) to project this point onto this element according to the shortest distance from the point initial location.



- If the point was lying on another point or a wire (curve, line, spline, and so forth), it is freed from its constraint onto this element, and can be moved to any new location in space.



i You can snap a point onto a surface using the **Free or constrain a point** icon. The point will be lying onto the surface, but not constrained. It can be moved using the manipulators.

8. Click OK to create the curve.

A 3DCurve.xxx appears in the specification tree.

- Use the F5 key to move the manipulators into a different plane of the compass. See Managing the Compass.
- You cannot add a point past the end points. To do this, you need to add a point before the end point, move the new point where the end point lies, then move the end point to a new location.
- The creation plane for each free point is defined according to the current plane/compass orientation on the previous point. Therefore you can change creation planes within the same curve, by setting a new current plane/compass orientation on several points.
- Check the **Disable geometry detection** button, when you need to create a point close to a geometric element yet without constraining it onto the existing geometry.
- Check the **Hide previsualisation curve** to hide the previsualisation curve you are creating.

Selecting 3D points

It is possible to select a scan of cloud either in the specification tree or directly in the geometry.

The Select all points contextual menu is available within the 3D curve action only, i.e. it is not available when you select the scan before entering the action but appears when the 3D Curve dialog box is open.

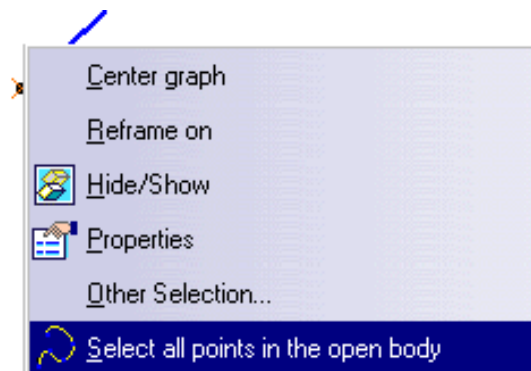
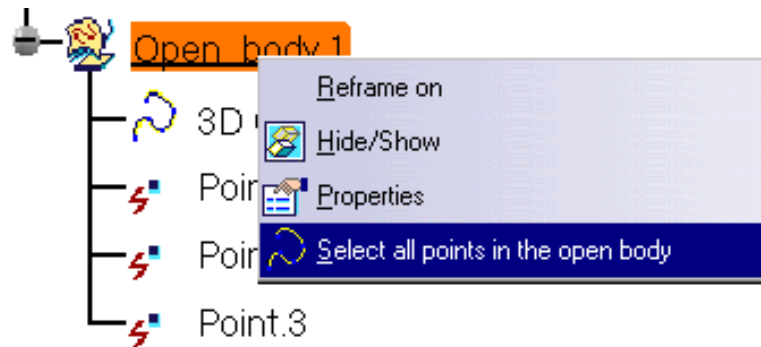

- In the specification tree:
 - select the geometrical set just by clicking it, or
 - right-click the geometrical set and choose Select all points in the geometrical set from the contextual menu, or
 - select a point in the geometrical set, right-click it and choose Select all points in the geometrical set from the contextual menu.
- In the geometry: select a point, right-click it and choose Select all points in the geometrical set from the contextual menu.

Contextual Options

Double-click your curve, right-click on the manipulator to display the contextual menu.

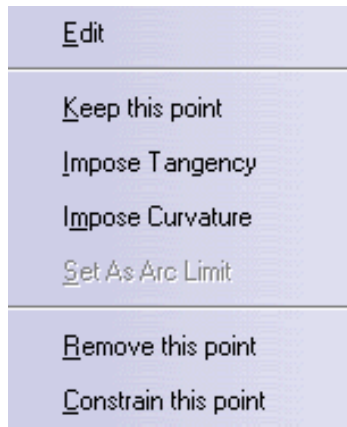

According to the creation type, the following options are available:

	Through Points	Control Points	Near points
Edit	X	X	X
Keep this point	X	X	X
Impose Tangency	X		X
Impose Curvature	X		X
Set as Arc Limit			X
Remove this point	X	X	X
Constrain this point	X	X	X

Editing



1. Right-click any of the manipulators, and choose the Edit contextual menu to display the Tuner dialog box. This option allows you to redefine the tangency position, and its vector's step.

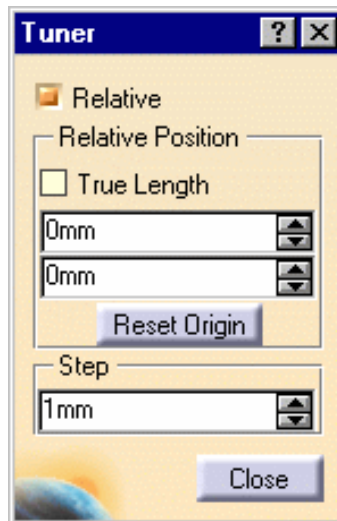
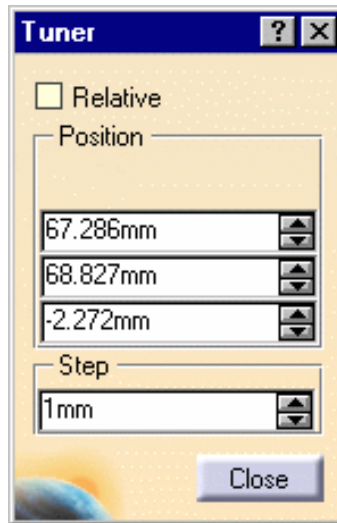

The **Relative** check box enables you to redefine the tangency relative position, and its vector's step. The **Reset Origin** button allows you to reset the origin of the relative position.

Keeping a point



1. Right-click an existing point and choose the Keep this point menu item to create a point at this location.
A Point.xxx appears in the specification tree.
You can create a Point.xxx either on each control point or on the selected control points.

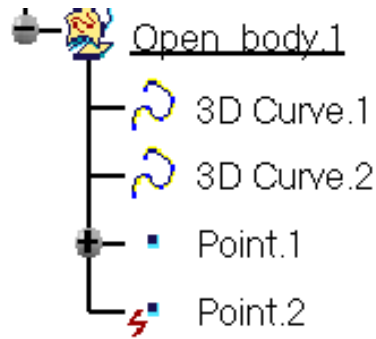

Imposing a Tangency Constraint Automatic Constraint

- When a curve is created in **Through points** or **Near points** mode, and its first point is constrained on any point of another curve, the new curve automatically is tangent to the curve on which its first point is constrained. As soon as the curve's second point is created, the imposed tangency is displayed on the new curve.
To deactivate the default option, uncheck the **Impose Tangency** contextual menu on the tangency vector.



Tangency Constraint on Points

When creating a 3D curve, you may want to impose tangency constraints on specific points of the curve. Then if you move the point at which a tangency constraint has been set, the curve will be recomputed to retain this tangency constraint at the point's new location.

Depending on the creation mode, you can impose this constraints on a limited number of points:

- In **Through points** mode: tangency can be imposed on any point
- In **Near points** mode: tangency can be imposed independently on each end points only
- In **Control points** mode: no tangency constraint can be imposed (end points can be constrained on other elements as described in [step 7](#) above. See also [Constraining a Control Points Curve](#)).

Here is how to do it:



Open the [3DCurve1.CATPart](#) document.



1. Move the pointer over an existing point, double-click it (the 3D curve dialog box appears), then right-click and choose the Impose Tangency menu item.

Two sets of manipulators are displayed:

- two arrows representing the normed directions (vectors) of the tangency
- circles representing manipulators for this vector

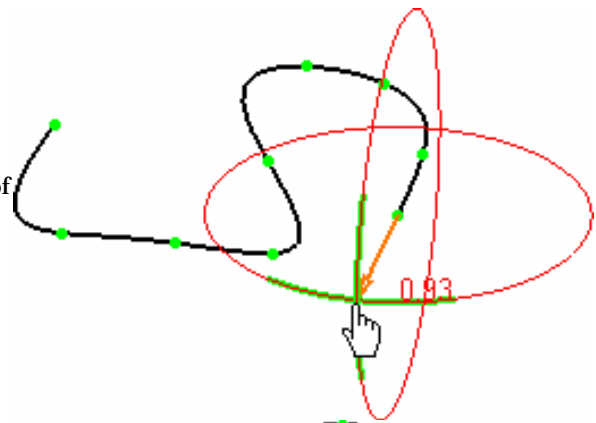

You can also modify the tangency constraint by:

- pulling the arrow
- gliding the circles
- double-clicking the arrow to invert the tangency direction

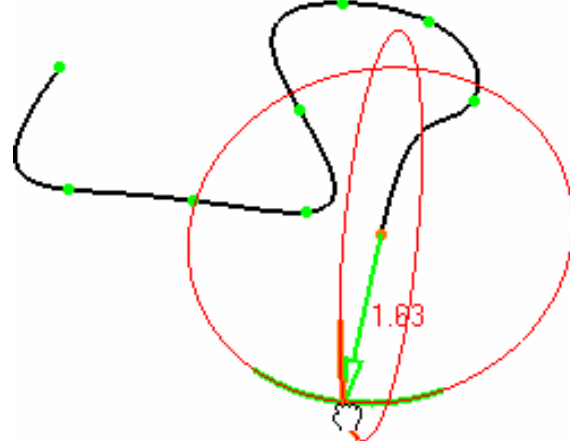

You can set the tangency length by clicking on the arrow then dragging the mouse.

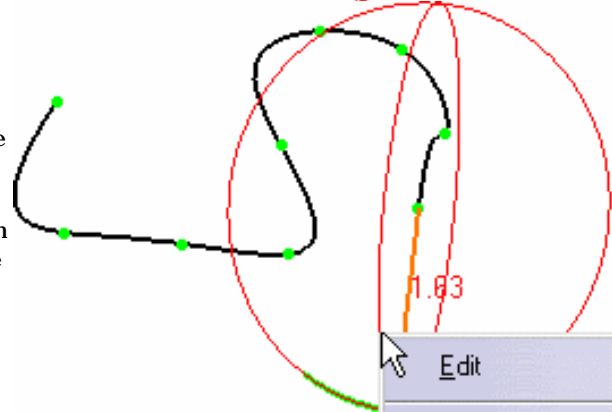

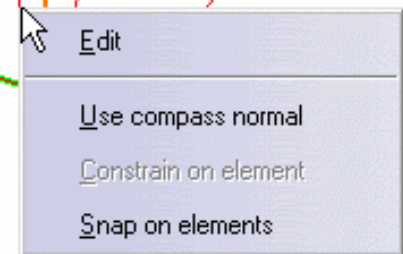

Right-clicking on any of the manipulators, you can also choose to define the constraint according to an external element:

- **Use current plane orientation (P1)/Use compass normal (P2):** the tangency constraint is defined in relation to the normal to the current plane, possibly defined by the normal to the compass main plane. When several points are constrained on the compass, all are modified if the compass settings are changed. When this option is checked, the direction cannot be modified directly using the vector manipulator, but only using the compass.

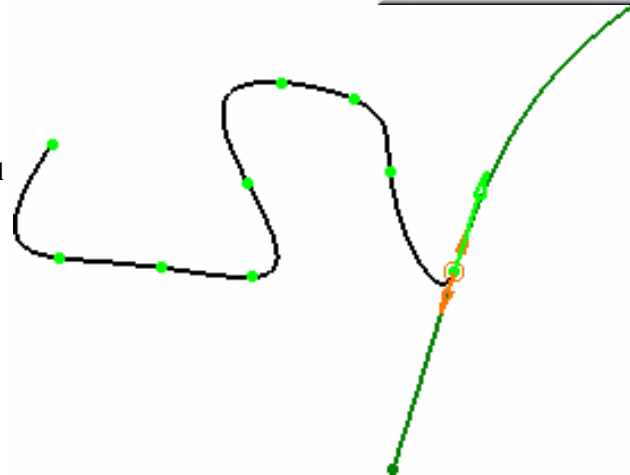

- **Constrain on element:** available only when a point is already constrained on a curve. The curve being created/modified becomes constraint in tangency or curvature to the constraining curve at this point.
 - Tangency constraint: in this case you can only modify the vector's norm using the **Edit** contextual menu, and no longer the vector's direction, the latter being defined by the constraining curve. Click the arrow to invert the tangency direction if needed.
 - Curvature constraint: in this case you neither modify the vector's norm using the **Edit** contextual menu, nor the vector's direction, the latter being defined by the constraining curve.



 By default, when the tangency vector is constrained onto another curve, its initial direction is retained.

- **Snap on elements:** the vector's direction is defined by an external element. Grabbing a manipulators, you drag the pointer over a curve, and the curve becomes tangent to the curve detected by the pointer.

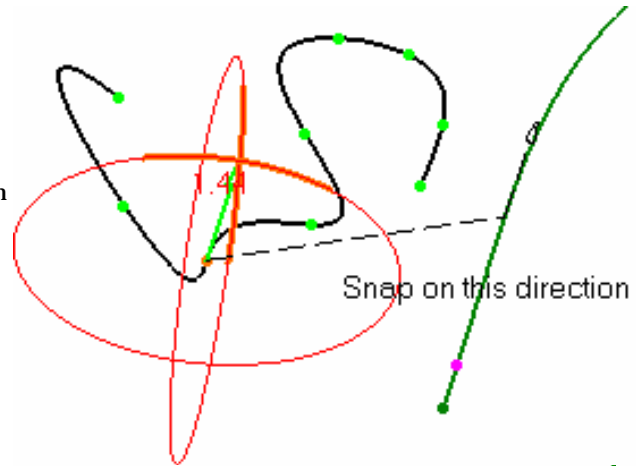

If the pointer is over a point the direction is computed as the line going from the constrained point and the detected point.
If the pointer is over a plane, the tangency is defined by the normal to this plane.

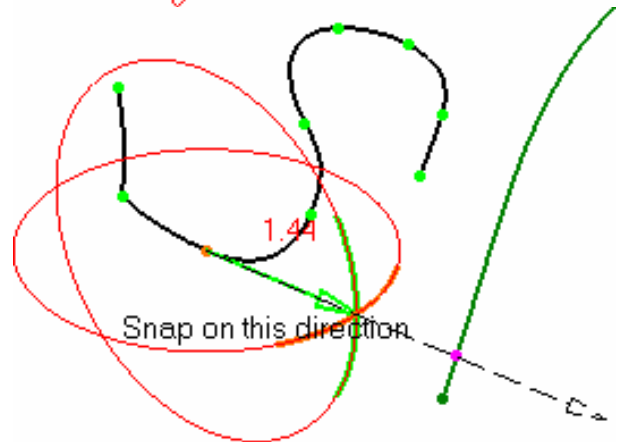

- When snapping on an element, use the Control (Ctrl) key to obtain an exact snap, taking into account both the detected element and the vector's norm.
- Use the Shift key as a shortcut to activate/de-activate the **Snap on elements option** when passing the pointer over geometric elements.

Once you are satisfied with the tangency constraint you imposed, simply release the manipulator and move the pointer around to recover the curve preview indicating that you are ready to create a new point.

Control Points Curve Constraint

Even though you cannot impose a tangency constraint on a curve created in **Control points** mode, you can constrain its end points on another curve, as described in [step 7](#) above.

When setting a constraint on an end point, a text is displayed indicating the type of continuity between the two curves.

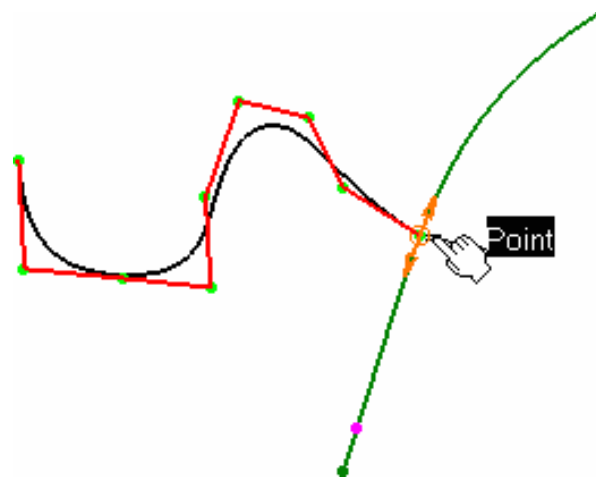

 Right-click the text to display the contextual menu from which you can choose another continuity type: tangency, or curvature.

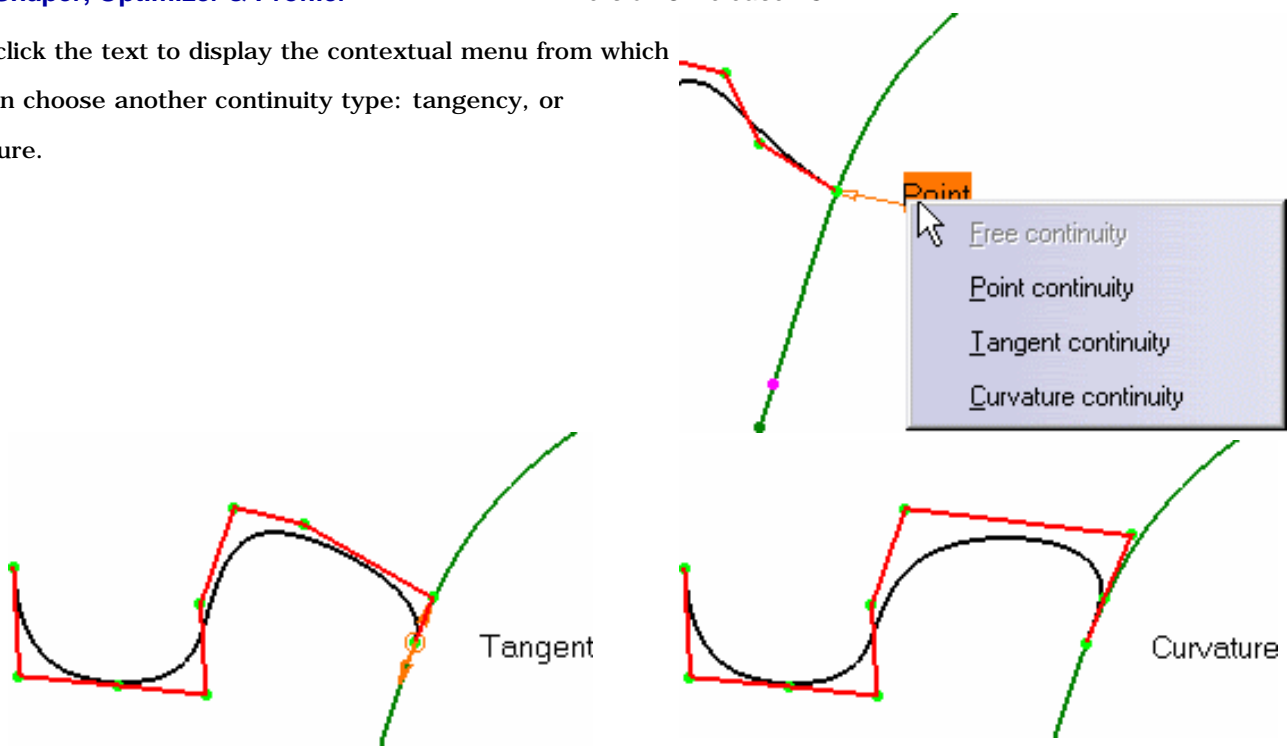

Note that:

- in **Point continuity**, only the selected point is constrained
- in **Tangent continuity**, the selected point and the next one are constrained
- in **Curvature continuity**, the selected point and the next two points are constrained

This means that these second and third points will be modified if you move the constrained point along the constraining element, using the manipulators. However, you cannot constrain these points, because they are considered as already constrained. If you try to do so, a warning message is displayed. Nevertheless, you can add/remove points directly after the constrained end point, and the system resets the points as second and third points to be affected by the constraint, where applicable.

 A **Continuity** warning is displayed when trying to move the manipulators in a direction that is not compatible with the set constraint.

Imposing a Curvature Constraint

 Right-click an existing point and choose the **Impose Curvature** menu item. An arrow representing the curvature direction (vector) is displayed. Modifying the vector direction modifies the curvature direction.

The direction of the curvature is constrained in the plane defined as normal to the tangent vector.

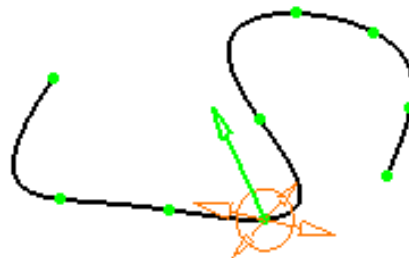



- To impose a curvature continuity, you must ensure that a tangency continuity already exists.
- This option is only available for the **Through points** and **Near Points** creation type.



Setting as Arc Limit

 Right-click an existing point and choose the **Set As Arc Limit** menu item to start/stop an arc limit on this point. The curve will pass through this point.

 This option is only available for the **Near points** creation type.

 You can use standard shortcuts (Ctrl and Shift keys) to select, multi-select, and de-select any combination of control points on these curves.

 Available capabilities from the Dashboard, and/or specified through the FreeStyle Settings, are: [datum creation](#), temporary analysis, auto detection (except for Snap on Control Point option), attenuation, and furtive display.

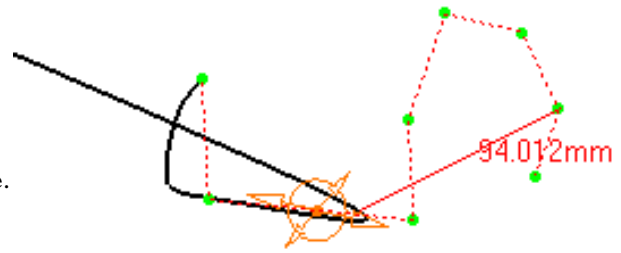

Creating Associative 3D Curves on a Scan of Cloud

 This task explains how to create a 3D curve on a scan of cloud:

- either before entering the 3D curve action. In that case, you can select only one scan,
- or after entering the 3D curve action. In that case, you can select one or several scans.
- either graphically. In that case, use the contextual menu **Select all points** to create a 3D curve on all the points of the scan,
- or from the specification tree. In that case all points of the scan are taken into account even if you do not activate the **Select all points** menu.

 Open the [ScanOnCloud1.CATPart](#) document.

1. Click the **3D Curve** icon



The 3D curve dialog box is displayed.

2. Choose the curve creation type.

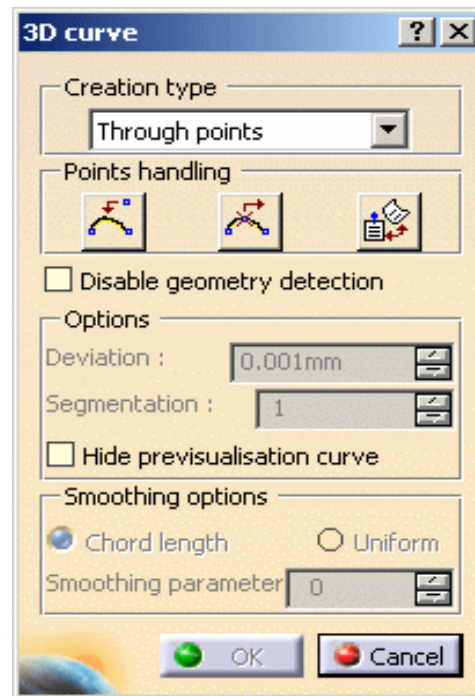

Whatever the chosen type, the curve is previewed in dotted line as you move the pointer.

- **Through points:** the resulting curve is a multi-arc curve passing through each selected point.

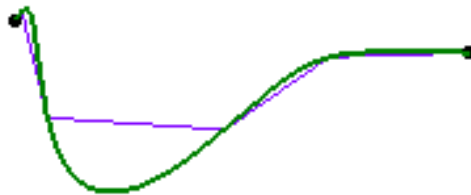

- **Control points:** the points you click are the control points of the resulting curve



- **Near points:** the resulting curve is a single-arc, with a set degree and smoothed through the selected points.

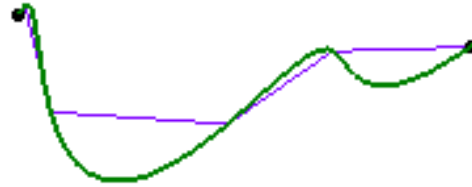

3. Click OK to create the curve.

A 3DCurve.xxx appears in the specification tree.



4. Double-click your curve, right-click on the manipulator to display the contextual menu.

Please refer to the [Creating Associative 3D Curves](#) to get the corresponding information.

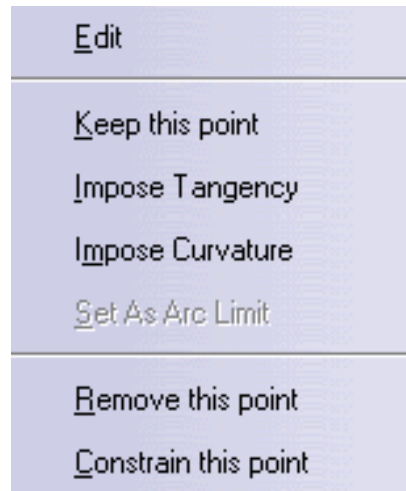

It is now possible to select a scan on cloud **before** entering the 3D curve creation dialog box. To do so, click the Scan on Cloud in the specification tree and click the 3D Curve icon.

Selecting a scan of cloud

It is possible to select a scan of cloud either in the specification tree or directly in the cloud from the contextual menu:

The Select all points contextual menu is available within the 3D curve action only, i.e. it is not available when you select the scan before entering the action but appears when the 3D Curve dialog box is open.

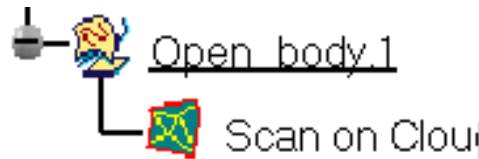

- Right-click the Scan on Cloud.xxx in the specification tree and select **Select all points**.

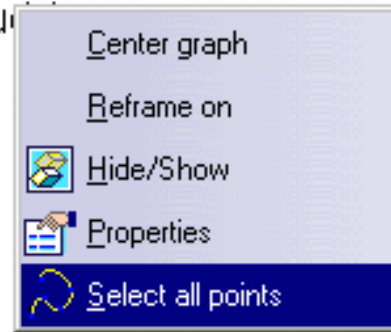

- Right-click the cloud and select **Select all points**.

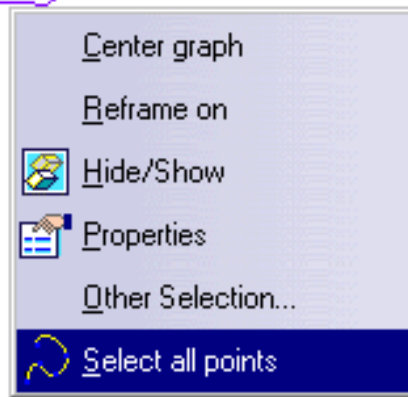

Here is an example with Through Points



Only scans of the type "scan on cloud" can be selected since other types of scans might contain too many points.

- Use the F5 key to move the manipulators into a different plane of the compass. See [Managing the Compass](#).
- The creation plane for each free point is defined according to the current plane/compass orientation on the previous point. Therefore you can change creation planes within the same curve, by setting a new current plane/compass orientation on several points.
- Check the **Disable geometry detection** button, when you need to create a point close to a geometric element yet without constraining it onto the existing geometry.
- Check the **Hide previsualisation curve** to hide the previsualisation curve you are creating.



For further information on the proposed Options, please refer to [Creating Associative 3D Curves](#).



You can use standard shortcuts (Ctrl and Shift keys) to select, multi-select, and de-select any combination of control points on these curves.



Available capabilities from the Dashboard, and/or specified through the FreeStyle Settings, are: [datum creation](#), temporary analysis, auto detection (except for Snap on Control Point option), attenuation, and furtive display.



Creating Free Form Curves on Surfaces

 This task explains how to create trimming curves on a surface.

Two types of curves are available for creation: freeform curves passing through all points you click, or isoparametric curves.

These curves must lie on the surface, but do not need to divide it.



Open any document containing a surface from the samples directory, or the [CurveOnSurface1.CATPart](#) document.



1. Click the **Curve on Surface** icon .

2. Select the surface on which the curve is to be created.

The Options dialog box is displayed letting you choose the curve type: an isoparametric curve, or a user-defined curve (**Point by point**).

Point by Point

If you choose the **Point by point** creation type, you need to define the curve creation mode: by interpolation or smoothing.

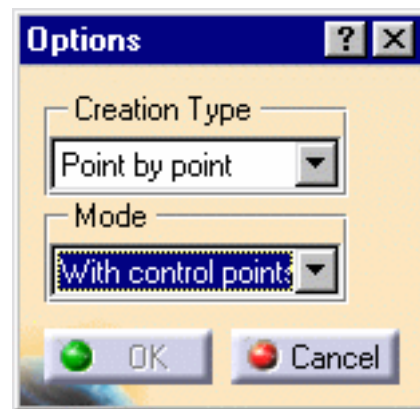

- If you choose to use the **Through Points** mode, the resulting curve is a multi-arc parametric curve passing through each selected point.
- If you choose the **With control points** mode, the points you click are the control points of the resulting parametric curve, as if you were using the editing capabilities (see [Editing Curves Using Control Points](#)).
This is the default value.
- If you choose the **Near Points** mode, the resulting curve is a single-arc parametric curve, with a set degree and smoothed through the selected points.

1. Choose a mode and click anywhere on the selected surface.

In the illustration, the Auto detection mode is active to **Snap On Edge** icon ( from the Dashboard), therefore clicking anywhere on the surface lets us define a point on its edge.

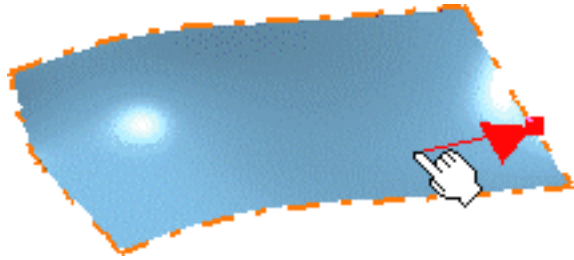

A dot is displayed identifying the starting point location on the surface.

2. Click as many locations as you wish the curve to go through.

Dots are displayed where you clicked, and the curve is previewed as you move the pointer around.

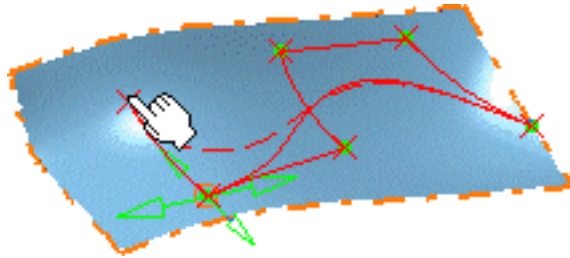

You can modify the shape of the curve at any time while it is being created.

For example, using the manipulators on the control points, you can move the pointer above any of the creation points and pull on the manipulators up to the surface edges.

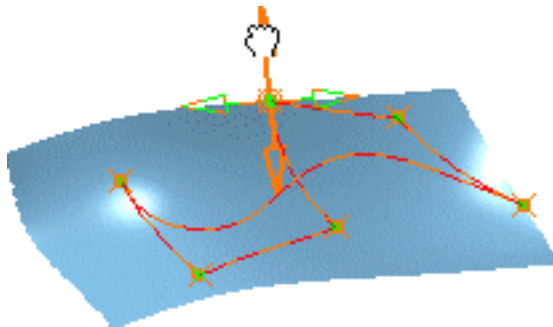

P2 Capabilities are available from the [contextual menu](#) when right-clicking a contact point.

3. Double-click to create the end point of the curve the surface, or click **OK**.

The curve end point can be anywhere on a surface or on an edge.

The curve has been created on the selected surface, following its shape.



The surface can now be used for other purposes, such as trimming the surface, for example.

Click the **Break** icon  and select an area delimited by the curve to trim the initial surface (see [Redefining Surface Limits](#)).



- Any surface can be used, whether planar or previously deformed.
- If you choose the **Near Point** option, check the **Order** option fr

Isoparametric

- **Manual selection:** you can create as many isoparametric curves as necessary, in both U and V directions, while being in the command.

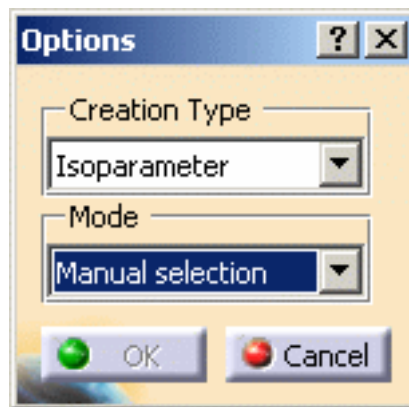

1. Run the mouse on the surface and click to create the curve.

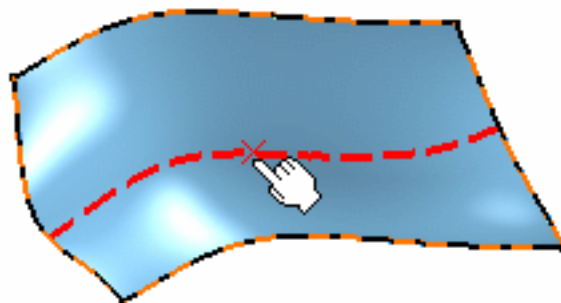

2. Still in the command, perform the same operation to create the second curve.

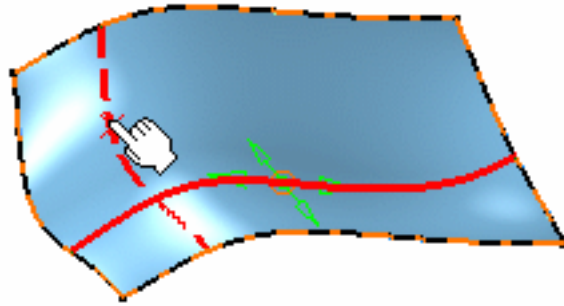

- Each created curve can be independently modified using the 3D manipulators.
- Capabilities are available from the **contextual menu** when right-clicking a contact point. You can select the **Invert Parameter** option to inverse the direction of the curve.

3. Click OK.

The curves have been created on the selected surface.

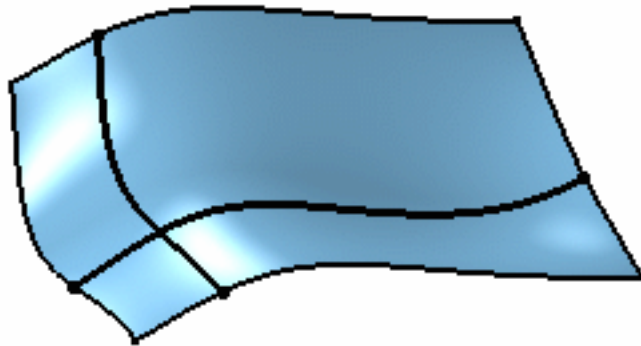

- **Automatic selection:** you can create as many isoparametric curves as necessary, in both U and V directions, while being in the command.



1. Define the value for U and V directions.
2. Click the surface to preview the created curves.

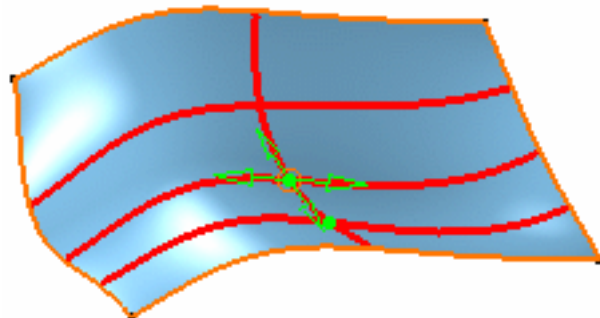

- Each created curve can be independently modified using the 3D manipulators.
 - Capabilities are available from the **contextual menu** when right-clicking a contact point. You can select the **Invert Parameter** option to inverse the direction of the curve.
3. Click OK.

The curves have been created on the selected surface.

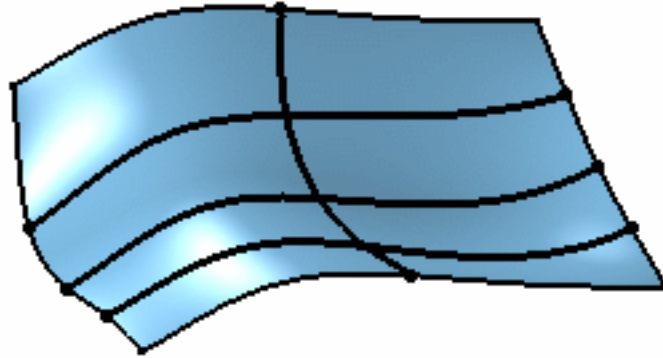

Creating a tangent curve:

- a.** Use the **With control points** option and click the first two points on the surface edge (parametric line).

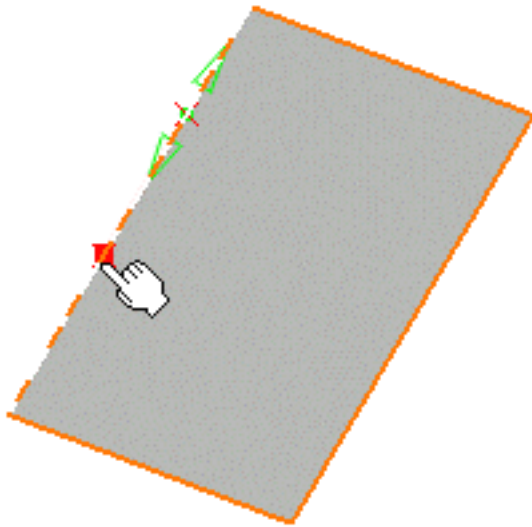

- b.** Continue creating the curve as usual

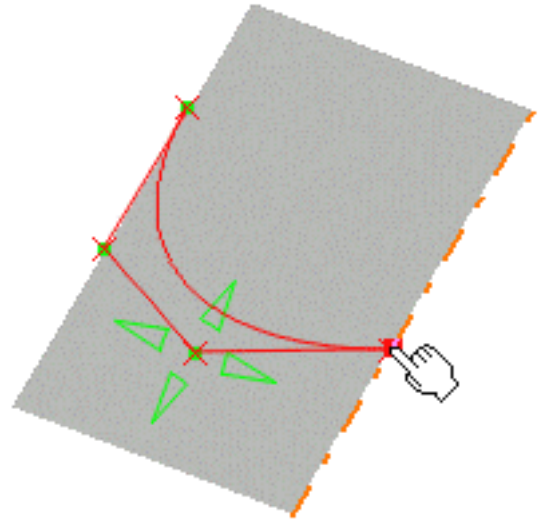

c. if you wish to make it tangent on both sides of the surface, proceed by clicking two points on the other edge

d. finish as usual, by clicking the last point on the surface edge.

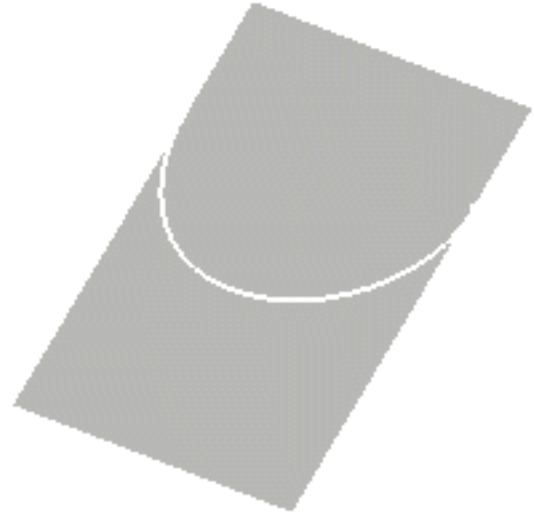
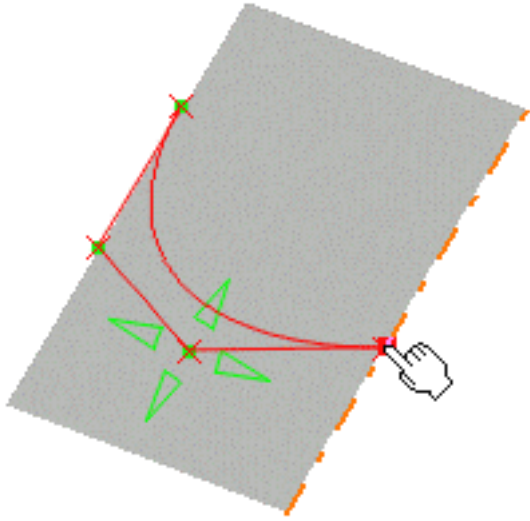

This is especially useful when breaking a surface. The surface edge presents a tangency continuity.

The resulting curves will always lie on the surface, even if you modify them using the control points capability after creation time.

P2

To facilitate the edge detection, for example, use the remote [auto detection](#) capability.

i

Available capabilities from the Dashboard, and/or specified through the [FreeStyle Settings](#), are: [datum creation](#), [auto detection](#), and [contact points](#).

P2



Projecting Curves



 This task explains how to project curves on surfaces.

 Open the [ProjectCurve1.CATPart](#) document.

 **1.** Select a curve.

2. Click the **Project Curve** icon .

The Projection dialog box is displayed.

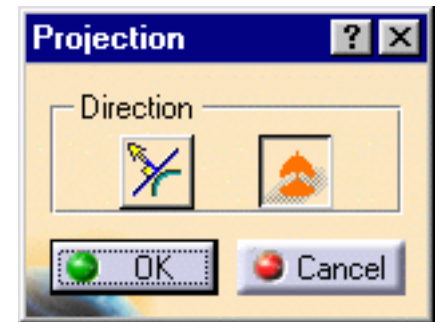

3. Choose the projection orientation from the Projection dialog box:

- **Projection Normal to the Surface**
- **Projection According to the Compass**

4. Press the Ctrl key and select the surface or set of surfaces on which the curve should be projected.

The projected curves are displayed, in dashed green, on the target surface along some information:

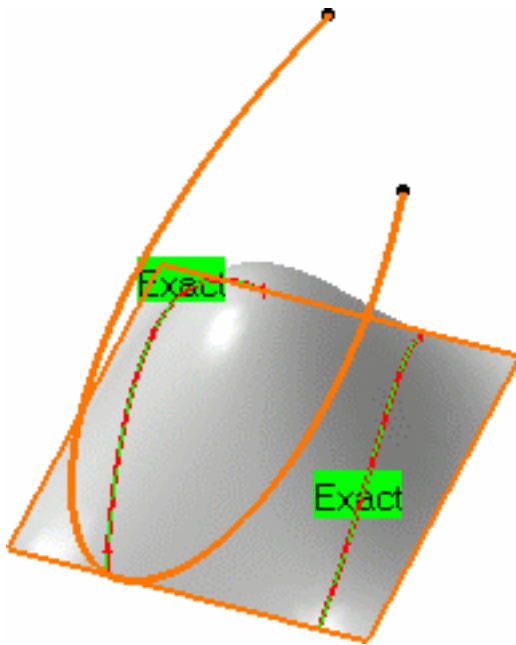

Projection according to the compass orientation

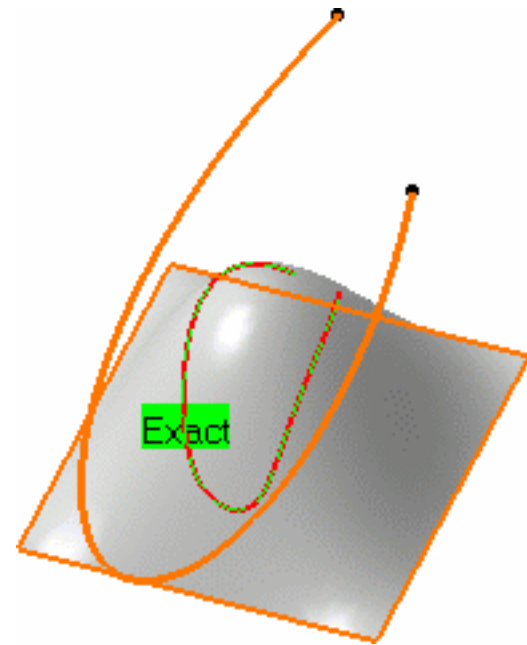

Projection according to the normal to the surface

The projected curves are BSplines lying on the surface.

The **Converter Wizard** is automatically used to process the resulting curve and generate either a 2D NUPBS (Non Uniform Polynomial B-Spline) curve identified by the **Exact** text, or a 3D NUPBS curve (identified by **Cv** text).

If you wish to further control the projected curve, right-click the displayed text and choose the **Edit** contextual menu. The **Converter Wizard** is then explicitly launched allowing you to control the new curve creation.

For example, in the case of a 2D curve you may wish to generate a single segment curve by checking both the **Segmentation** and **Single** button in the Converter Wizard, then clicking OK.

5. Click **OK** in the Projection dialog box to create the projected curves.

If you chose the projection according to the compass orientation, two curves are created on the surface, and show up in the specification tree as two different elements.



- When you project a curve on two surfaces, there may be no tangency continuity.

- Use the **Furtive Display** icon  to view the control points on the projected curve (in blue).

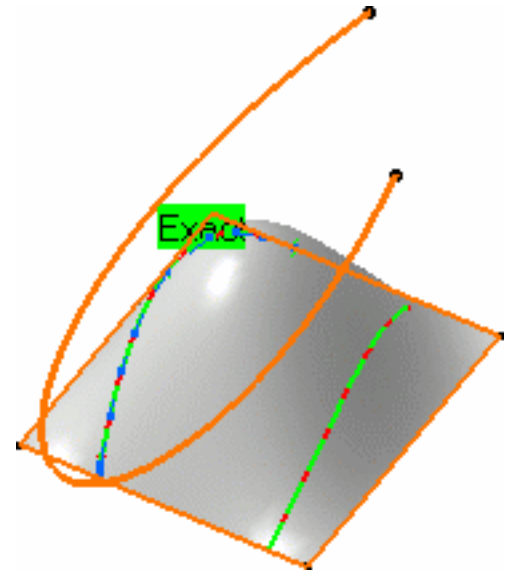

- Check the **Display Information** option from the Converter Wizard's dialog box to the resulting curve's order and number of segments.
- The element's topology (for example a relimited curve or surface) is taken into account for the projection.
- Multi-selection of curves is allowed.
- Multi-cell curves can be selected: the resulting projected curve will also be a multi-cell curve.



Available capabilities from the Dashboard are: [datum creation](#), and [keep original](#).



Creating Blend Curves



This task explains how to create blend curves.

Blending means that a connecting curve will be created between two selected curves, taking certain continuity, position and tension constraints into account.



Open the [BlendCurve1.CATPart](#) document.



1. Select two curves.

2. Click the **FreeStyle Blend**

Curve icon .

The Blend Curve dialog box opens.



3. Select the second curve, in case you have not previously selected it.

The blend curve is automatically previewed. By default it connects the curves at their end points closest to the selected points.

4. Make sure the **Continuity** icon



is active in the Dashboard and right-click onto the identifier to edit the continuity constraint, using the contextual menu.

The default continuity type is

Tangent.

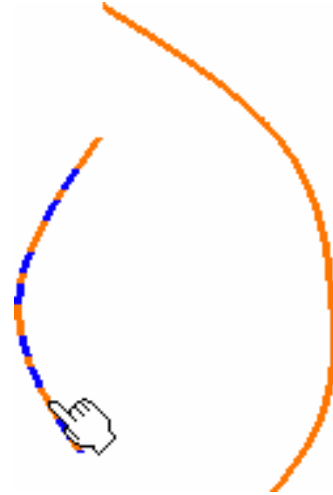

You can do the same on the other end point.

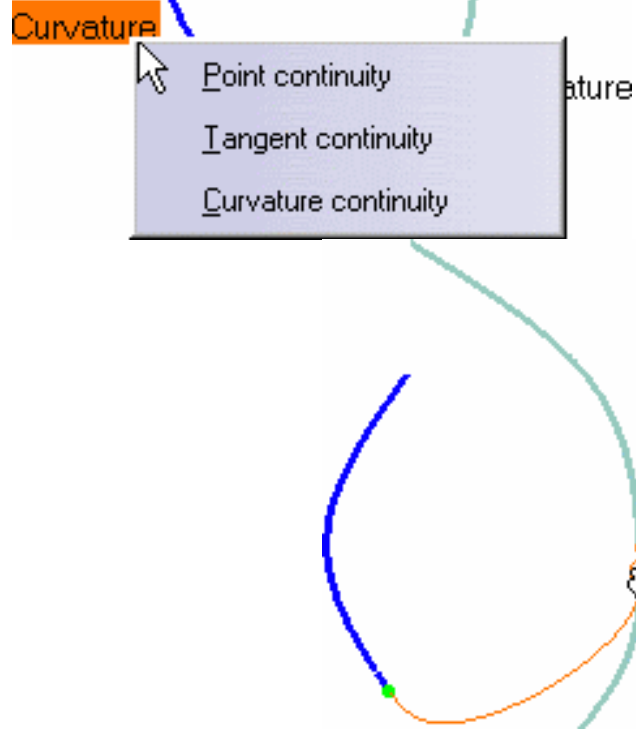

5. Make sure the **Contact Points**

icon  is active in the Dashboard, to display the contact points on the blend curve end-point.

P2 Capabilities are available from the **contextual menu** when right-clicking a contact point.

6. Move the pointer close to the contact point and drag the manipulator to modify the blend curve connection to the initial curves.

P2 **7.** Still from the Dashboard, make sure the **Tensions** icon  is active, and modify the tension by sliding the displayed value along the green segment.

This segment represents the direction and limits of the blend curve tangent at its end points.

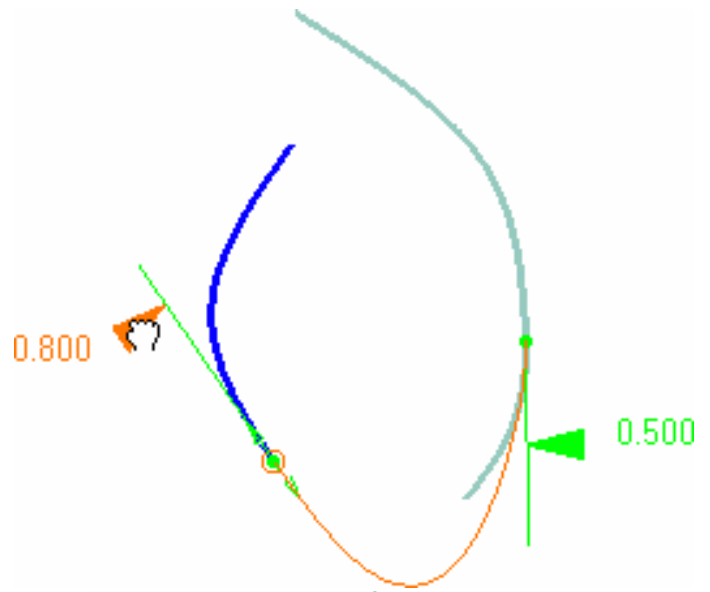

- 8. You can also edit the value, or invert the tension direction, using the contextual menu on the value.

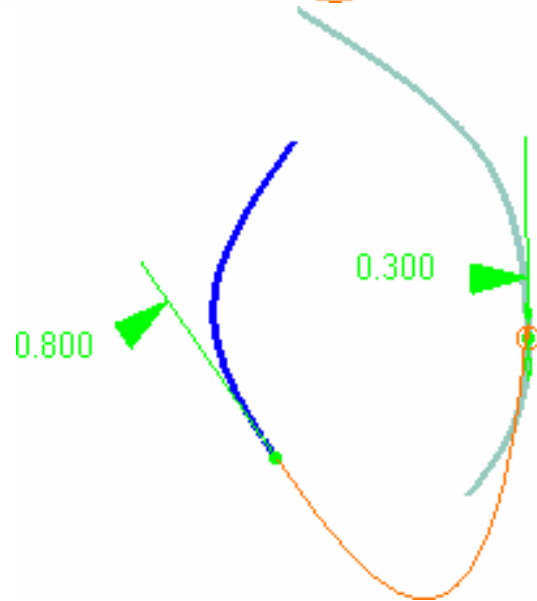

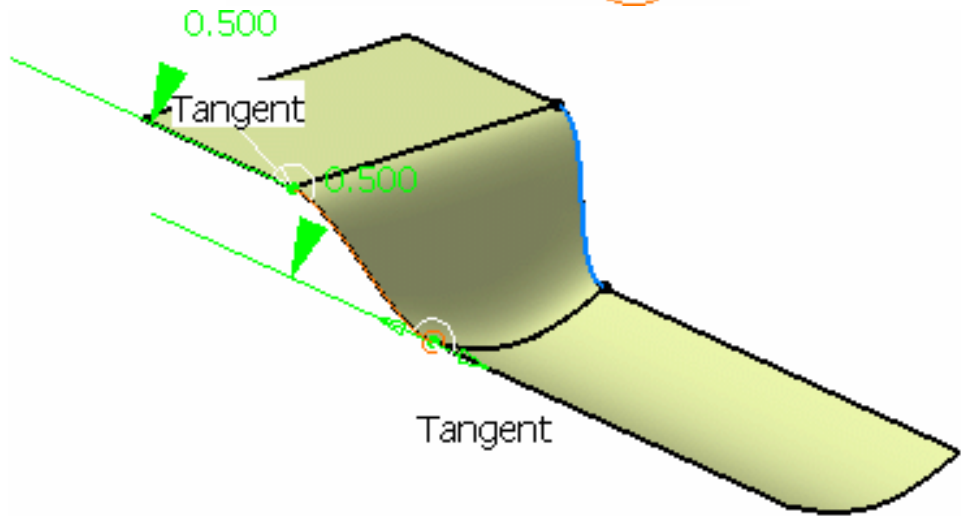

 Tensions are now homogenized between blend surfaces and blend curves, so that the borders of a blend surface have the same shape as the blend curves, providing they are built on the same supports.

 This homogenization is only possible with an approximated blend surface.

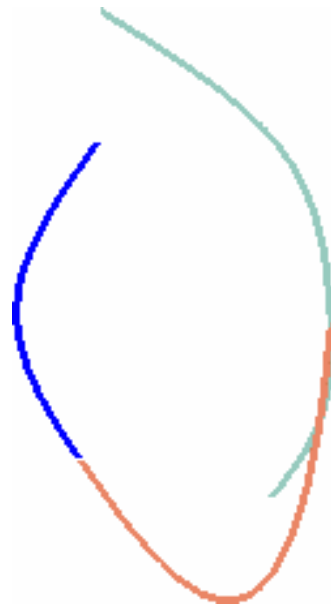

9. Once you are satisfied with the new curve, click **OK** in the Blend Options dialog box.
The blend curve is computed .



-  The curve resulting from the blend remains selected by default. If you wish to perform analyses, make sure you select the other curves using the Ctrl-key.
-  Available capabilities from the Dashboard, and/or specified through the [FreeStyle Settings](#), are: [datum creation](#), [auto detection](#) (Snap On Vertex option only), [attenuation](#), [continuity](#), [contact points](#), [tensions](#), and [furtive display](#).



Creating Styling Corners

P2



This task explains how to create a styling corner, that is a connecting curve of a given radius between two other **planar** curves.

Styling corners are especially useful to create good quality surfaces based on a curve net, as described in [Creating a Net Surface](#) (available with the FreeStyle Profiler product only).



Open the [StylingCorner1.CATPart](#) document.



1. Click the **Styling Corner** icon .

The Styling Corner dialog box is displayed.

2. Select the two curves to be connected by a styling corner.
3. Key in a radius value.

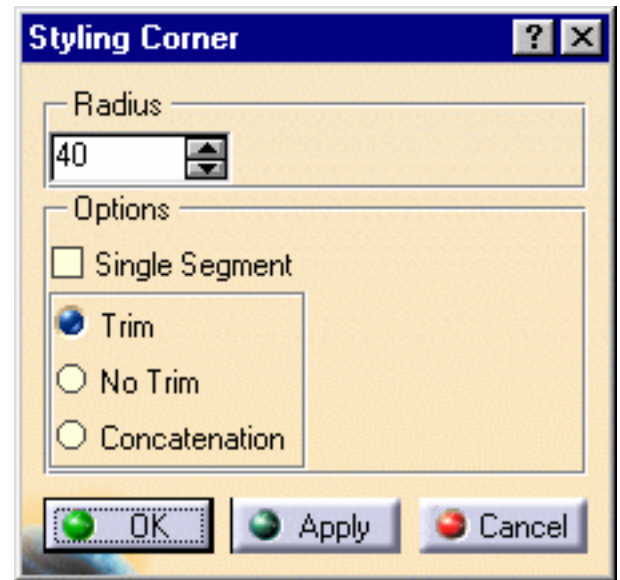

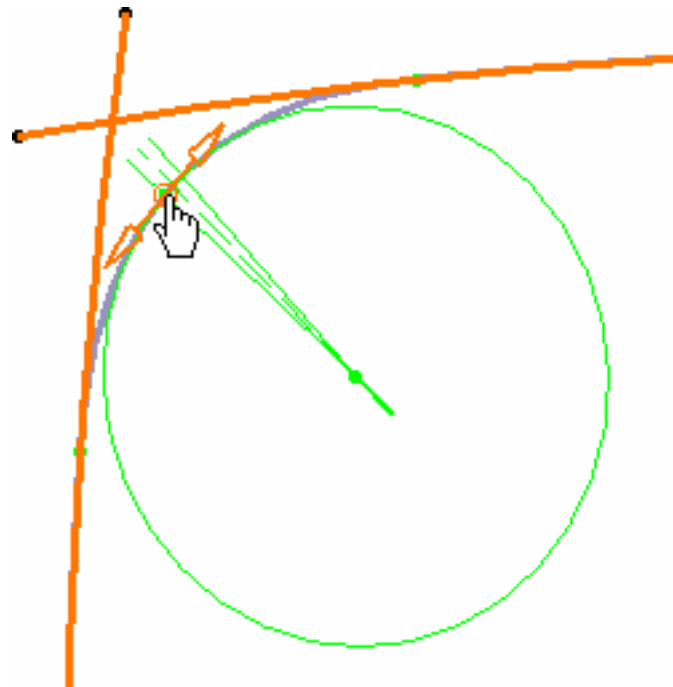

4. Click Apply.

The corner is previewed, with manipulators, at the circle center, the constant radius limit (the segment between the two solid radius lines), and at the contact points, provided this option is active in the dashboard.



 Capabilities are available from the [contextual menu](#) when right-clicking a contact point.

 It may be interesting to perform a [curvature analysis](#) clicking the **Porcupine Curvature Analysis** icon  to visualize the resulting corner's curvature, and possibly modify it using the corner's manipulators.

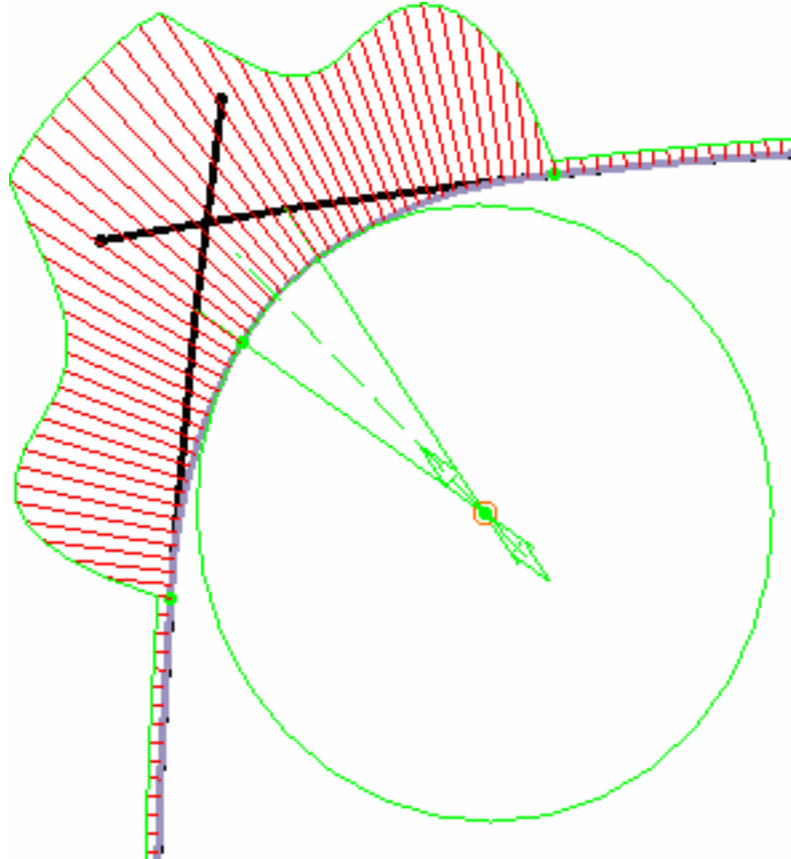

In this case, it may be useful to smooth the curvature at the contact points and reduce the constant radius area:

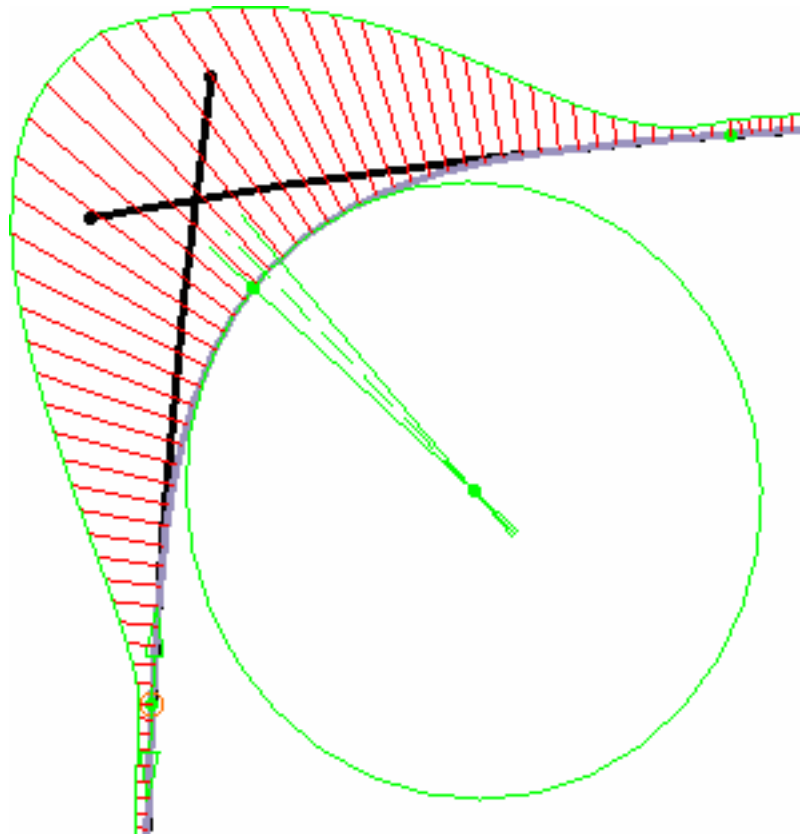

5. Modify the options as needed:

- the **Radius** value in the editable field
- the **Single Segment** option to impose a limited number of control points for the corner curve, thus resulting in a single arc curve.

In this case, the generative circle is not displayed, only contact points are, provided the **Contact Points** option is active in the dashboard.

Depending on the radius value, there may be several solutions. In this case, you are prompted to select one of the proposed solutions.

The concatenation mode (see below) is not available with this mode.

- the resulting curve type:

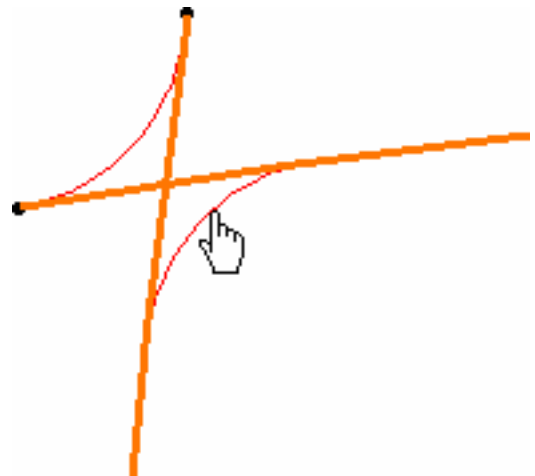

- a. **Trim:** to create a three-cell curve limited to the initial curves endpoints. You can display their control points independently if you use the **Control Points** icon  (it creates another independent curve corresponding to the selected cell). Initial curves are duplicated and trimmed at the contact points with the corner segment.

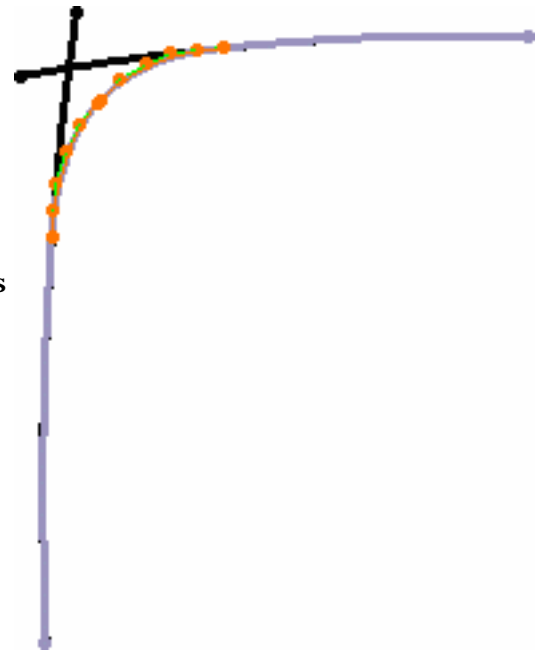

- b. **No Trim:** to create the corner arc only limited at the intersection with the initial curves. Initial curves are not modified.

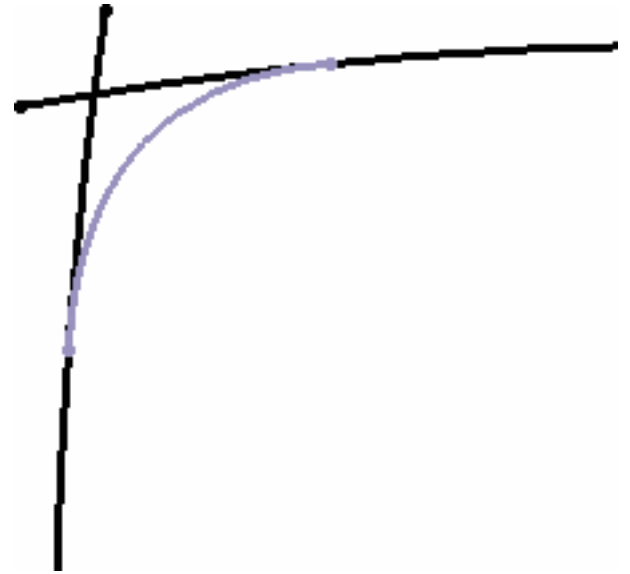

- c. **Concatenation:** to create a mono-cell curve limited to the initial curves endpoints. You can display its control points independently if you use the **Control Points** icon  (it creates another independent curve corresponding to the whole curve). Initial curves are duplicated, trimmed at the contact points with the corner segment, and concatenated with the latter.



6. Click OK to create the styling corner.



A useful application of this command is to create a set of styling corners based on intersecting curves, then create an associate net surface based on these styling corners. You can then modify the initial set of curves and the surface automatically is recomputed.



Matching Curves



This task explains how to match a curve with another curve, a point on curve or a 3D point..



Open the [MatchCurve1.CATPart](#) document.



1. Select the curve you wish to match to another curve.

2. Click the **Match Curve** icon .

The Match Curve dialog box is displayed.

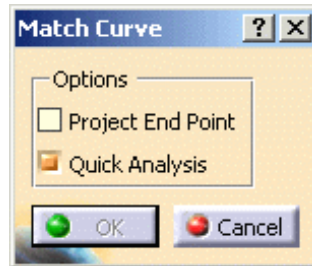

3. Select the second element for the match curve to be joined to. It can either be:

1. a curve
2. a point on curve with history
3. a datum point on curve
4. a 3D point
5. a vertex

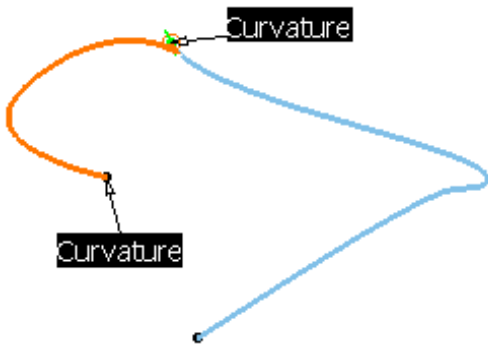

1. Match between a curve and another curve

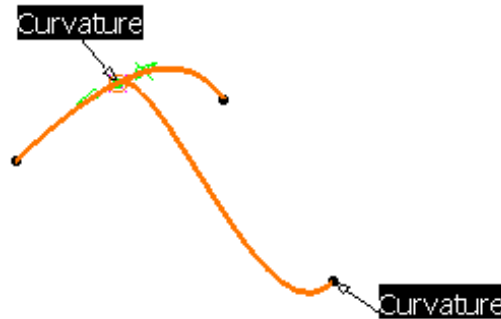

2. Match between a curve and a point on curve with history

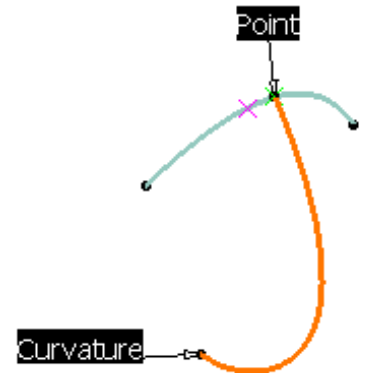

3. Match between a curve and a datum point on curve



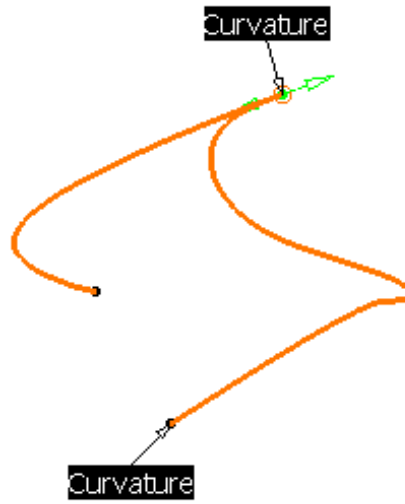

4. Match between a curve and a 3D point

5. Match between a curve and a vertex

- If a curve is selected as the second element, all continuities can be applied (point, tangent, and curvature continuities)
- If a curve or a point on curve with history is selected as the second element, a point or curvature continuity can be applied.
- If a datum point on curve, a 3D point, a vertex is selected as the second element, a point continuity will be applied.

If the second element to match (a point on curve with history, or a vertex) lies one more than one support, the  appears. Please refer to [Selecting a Support](#) for further information.

The first curve is automatically modified so as to be connected to the second element while taking the continuity type into account.

The number displayed on the first curve (Nx) corresponds to number of control points on that curve.

-  • The **Project End Point** option allows a linear projection of the minimum distance between two curves by projecting the initial curve onto the target curve.



- The **Quick Analysis** option enables to perform a violation diagnosis of the curve matching. The original degree is kept (it is no more automatically increased). Several parameters are taken into account between the two curves:
 - distance
 - continuity degree
 - curvature difference

4. Click Ok in the Match Curve dialog box to create the matched curve as it is previewed.

If a continuity type leads to some inconsistencies regarding the curve's original degree, a warning message is issued.

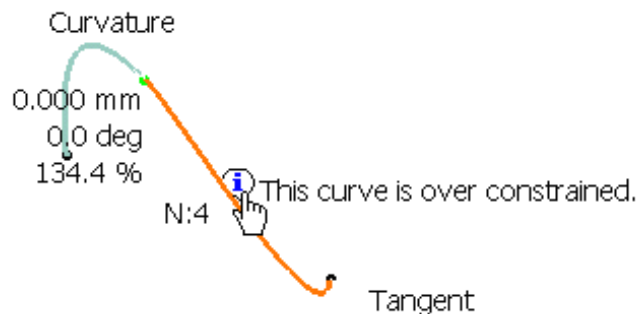

Make sure the **U, V orders** icon  is active in the Dashboard so that the numbers of control points are displayed.

In order to reach the correct degree (0 or 180 degree) and percentage (0%), you can either:

- increase the number of control points by clicking the number (the value is increased by one) or by selecting a number from the contextual menu, or

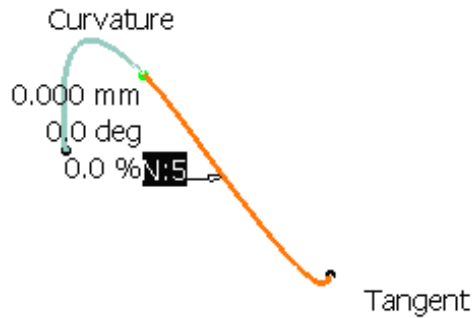

- modify the continuity type by clicking it (it is displayed sequentially) or by selecting a type from the contextual menu.

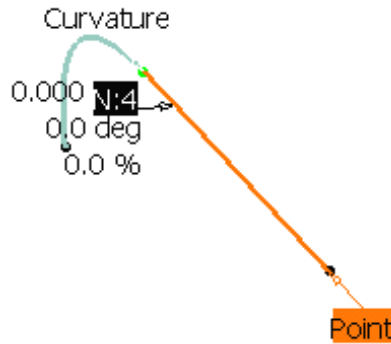

Working with the FreeStyle Dashboard

1. Make sure the **Continuity** icon  is active in the Dashboard and, right-click onto the identifier to edit the continuity constraint, using the contextual menu.

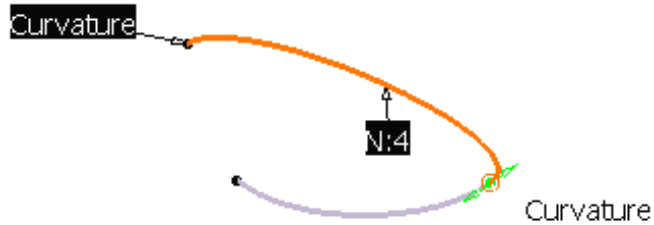

You can choose from the point, tangency or curvature continuity type to be taken into account.

2. Still from the Dashboard, make sure the **Tensions** icon  is active, and modify the tension by sliding the displayed value along the green segment.

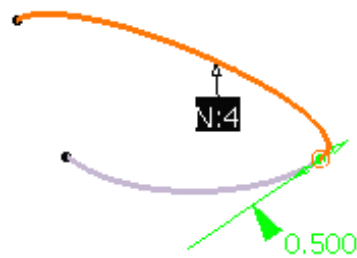

This segment represents the direction and limits of the match curve tangent at its end-points.

3. Make sure the **Contact Points** icon  is active in the Dashboard, to display the point manipulators and to move the points along the curve, thus interactively redefining the connection location.

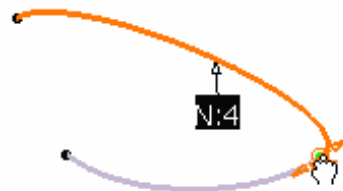

4. Click OK in the Match Curve dialog box to create the matched curve as it is previewed.



P2

5. When working in P2 mode, click the **Break Surface or Curve** icon  and select the curve to be broken.

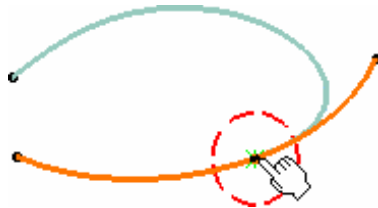

6. Select the side to be removed.



7. Click OK in the Break Options dialog box.



A new split curve is created replacing the initial one.

💡

The curve resulting from the match remains selected by default. If you wish to perform analyses, make sure you select the other curve using the Control key.

P2

Available capabilities from the Dashboard, and/or specified through the [FreeStyle Settings](#), are: [datum creation](#), [auto detection](#) (Snap On Vertex option only), [attenuation](#), [continuity](#), [contact points](#), [tensions](#), and [furtive display](#).



Editing Curves Using Control Points

 This task explains how to modify a curve using its control points.

 Open the [EditControlPoints1.CATPart](#) document.

 1. Select the curve you wish to edit.

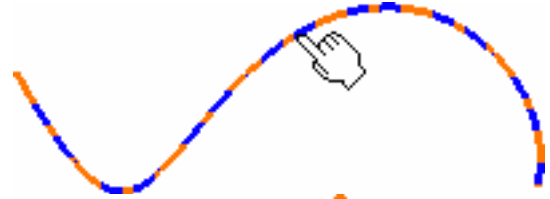

2. Click the **Control Points** icon .

Control points and lines are displayed, along with the 3D compass and the curve degree.

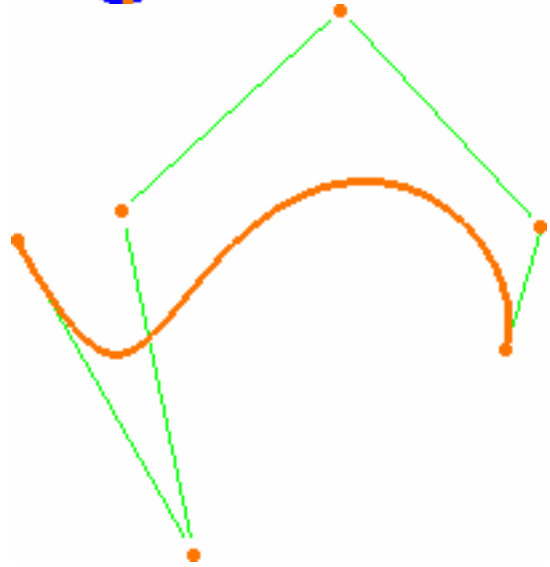

-  • If you select a curve that has been created outside the FreeStyle workbench, and the curve is not a NUPBS curve (Non-Uniform Polynomial B-Spline), the [Converter Wizard](#) will be automatically displayed when the curve cannot be exactly converted. This allows you to control the conversion tolerance. However, when a curve can be exactly converted, such as a spline, or line for example, the Converter Wizard is not displayed, the conversion is done automatically and a message is issued. In this case, the **Exact** text is displayed on the element for information.
- Planes and lines are used to quickly orientate the compass in the control points command. Therefore if you select a plane or a line, it will modify the compass orientation.
- By default all control points and mesh lines are selected. Click a specific point to deform the surface at this point only, or select a set of points using the Ctrl-key or Shift-key while clicking (multi-selection capabilities). The same applies to mesh lines.

3. Move the pointer over a point or a line.

Arrows are displayed according to the **Support** and **Law** options active in the Control Points dialog box.

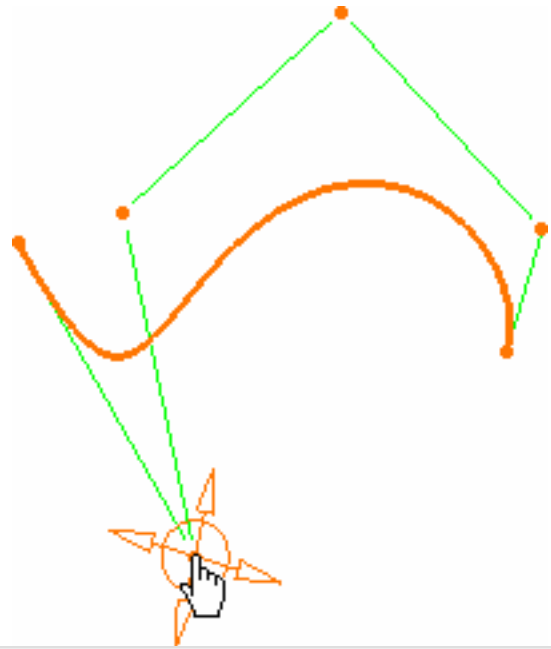

- **Support** defines the type of translation to be applied
- **Law** defines the type of deformation that is to be applied when several control points have been selected.

For further information on supports and laws, refer to [How to Use the Support and Law Options?](#)

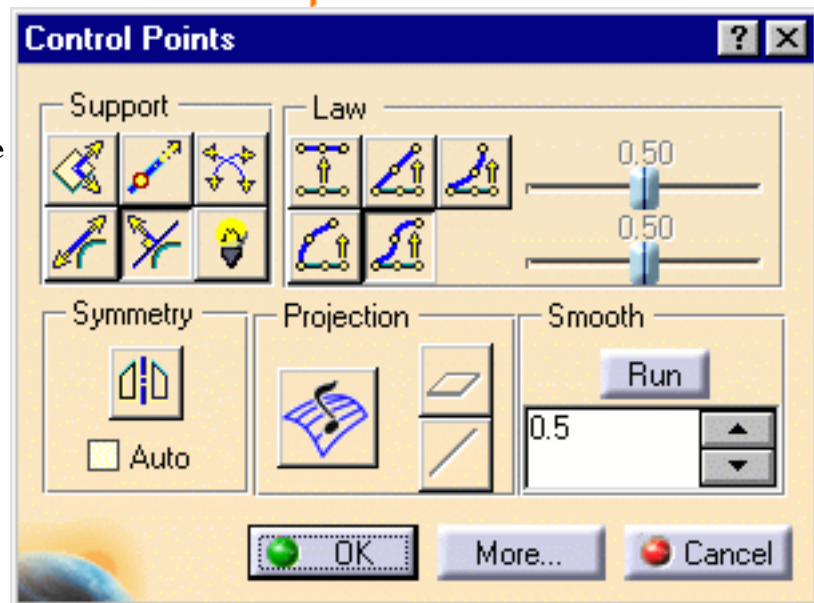



In P1 mode, you can modify curves according to two laws only:

1. **Move selected points identically**
2. **Stretch selected points**

You cannot specify a Support.

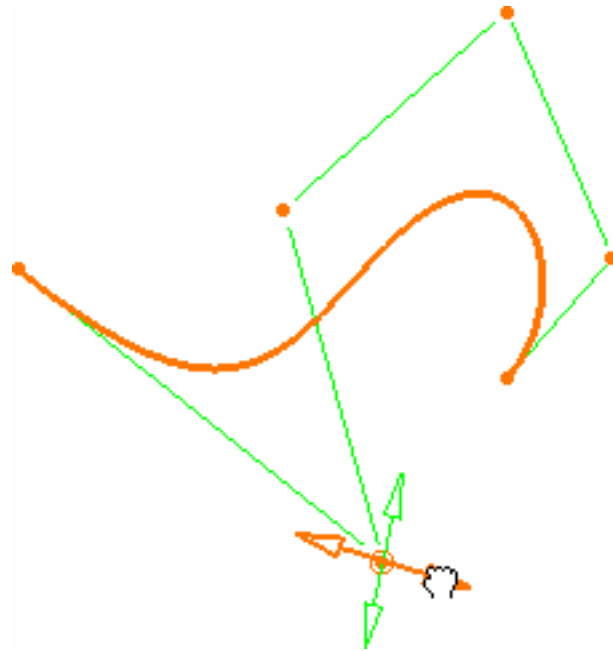
4. Pull on the arrow matching the direction in which you want to deform the curve.



5. Use the Dashboard to display the order number directly on the curve, using the **U, V Orders**  icon.

The value is displayed on the curve.

6. Use the contextual menu to choose the order number for the curve.

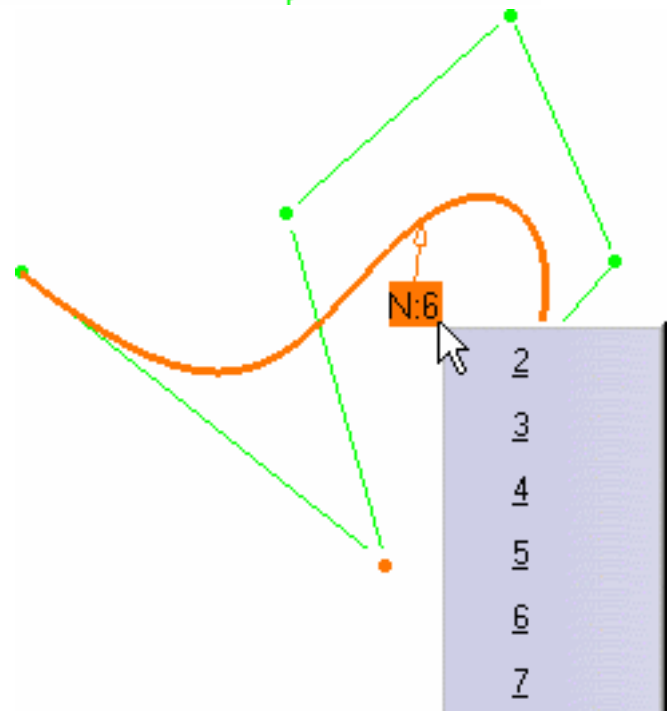

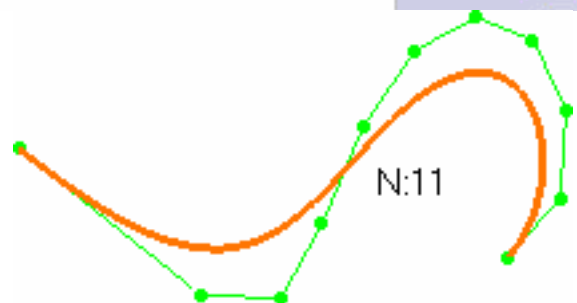

If you increase the order number to 11, the result is:



7. Click **OK** in the Control Points dialog box to validate the modifications.



- Use the Control Points dialog box to modify the curve according to certain predefined laws.
- To display the order number and continuity type directly on the curve, use the Dashboard's the **Continuity**  and **U, V Orders**  icons (P2) or the specified settings (using the **Tools** -> **Options** -> **Shape** -> **FreeStyle** -> **General** tab) (P1).

You can edit these by right-clicking the displayed text, and choosing a new order number, or continuity type.

When selecting several curves, if a **continuity constraint** exists, the continuity tag displayed is set by default to the same continuity imposed by the constraint.

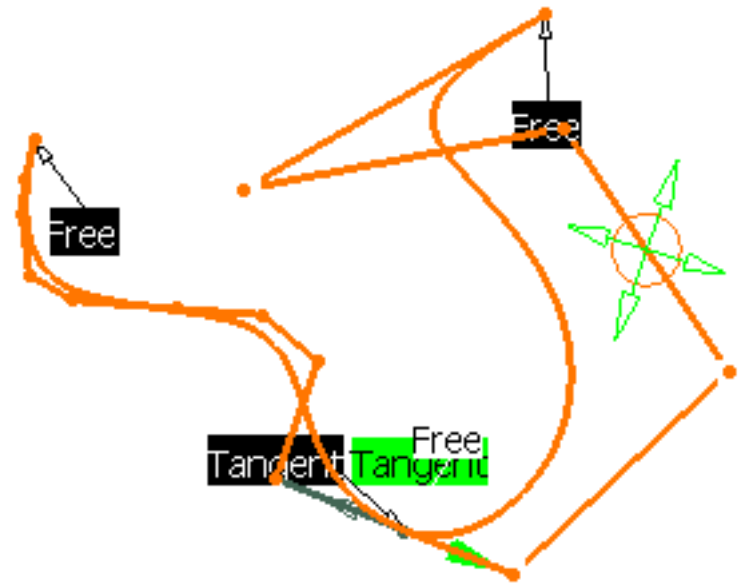



Use the **Manipulators** (arrows) to modify the curve as it is created. In P2 mode, the following manipulation options are available:

- To fine-tune the manipulators, use the **attenuation** capability from the Dashboard. It lets you define the ratio between the mouse displacement and the actual displacement of the manipulator. This attenuation factor is saved in the CATIA settings.
- To snap a point onto external geometry, use the **auto detection** capability from the Dashboard.
- To perform a quick analysis of the mesh line inflection, choose the **Inflections** checkbox.



The following options are available in P2 mode only:

- Further modification options are available from the **More...** button of the Control Points dialog box:
 - Freezing of the selected points (no other can be selected) and of the Support option
 - Dynamic display of the initial curve and of the delta as you pull on the control points
 - Global selection/de-selection of control points using the **Select All**  and **De-Select All**  icons, without having to click the geometry

 The Projection, [Smooth](#), and [Symmetry](#) capabilities are only available with the FreeStyle Optimizer product.

-  • Capabilities are available:
- from the [contextual menu](#) when right-clicking a control point,
 - from the FreeStyle Dashboard,
 - specified through the [FreeStyle Settings](#), are: [datum creation](#), [keep original](#), [auto detection](#), and [attenuation](#).
- To have further information about how to smooth curves, see [Smoothing Curves](#).



Smoothing Curves



This command is only available with the FreeStyle Optimizer.

This task explains how to smooth curves.

Open the [SmoothCurve1.CATPart](#) document.

1. Select the curve to be smoothed.

2. Click the **Control Points** icon



Control points are displayed on the curve, and the Control Points dialog box appears.

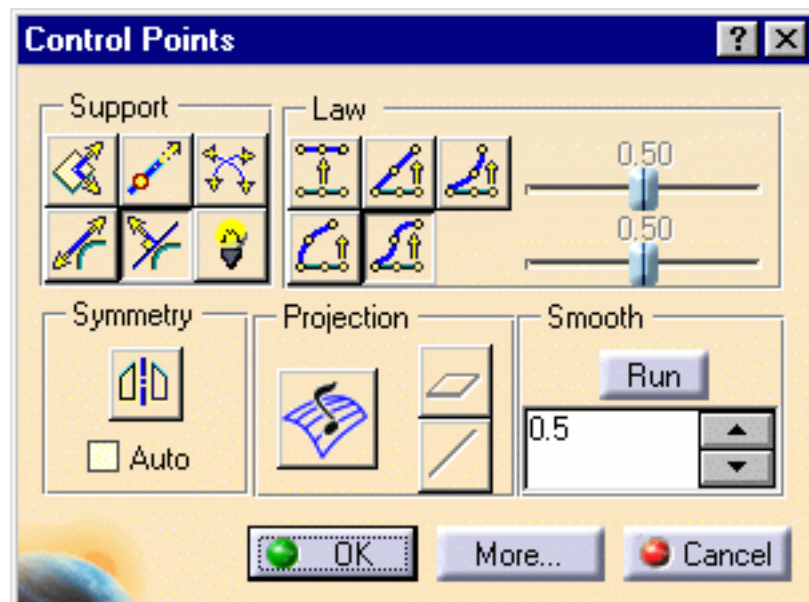

3. Define the smooth weight using the slider, and click **Run**.

The curve is smoothed according to the value.

4. Click again to repeat the smoothing operation.



- Once you are satisfied with the smoothed curve obtained, click **OK** in the **Control Points** dialog box.



 You do not need to select the whole curve. You can locally smooth the curve. Simply use the multi-selection capabilities:

- Press and hold down the Shift-key and click on a first point. Still maintaining the Shift-key down, click another point of the curve. All points selected between the two selected points are selected as well, and the curve is smoothed in this area only.

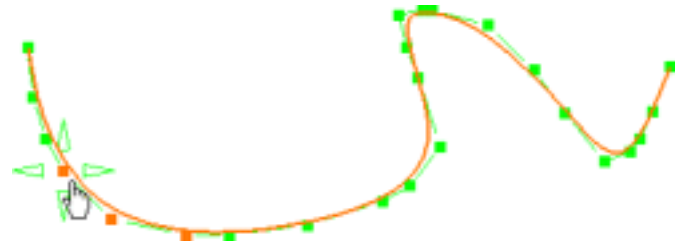
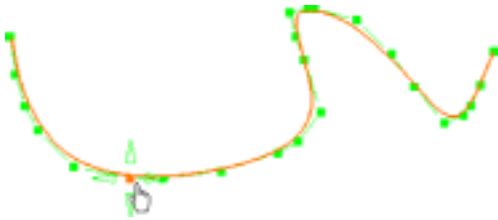

- Click a first point, press and hold down the Ctrl-key, then move on to the other points to be selected. Only the explicitly selected points are highlighted, and smoothing is performed on these points only.



 Capabilities are available:

- from the [contextual menu](#) when right-clicking a control point,
- from the FreeStyle Dashboard,
- specified through the [FreeStyle Settings](#), are: [datum creation](#), [auto detection](#), and [attenuation](#).



Extrapolating Curves



This task explains how to modify a curve, or surface boundary, by extrapolation, that is by modification of its length. It can be a positive or negative extrapolation meaning that you can actually lengthen or shorten the curve.



Open the [Extend1.CATPart](#) document.



1. Select the curve to be extrapolated.

It will be extrapolated on the end-point side closest to the selection point.

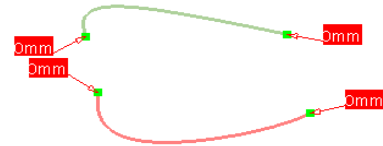

2. Click the **Styling Extrapolate** icon .

The Extrapolation dialog box is displayed.

Only the **Tangential** extrapolation type is available for curves.

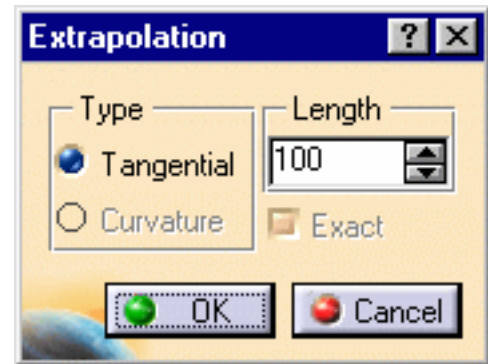

3. Click the **Tangential** option:

The curve is extrapolated taking into account the keyed in length (expressed in model units).

Here we keyed in 100.

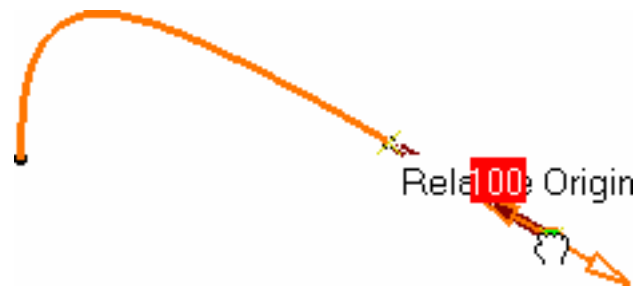

If you key in a negative value, the resulting curve is created in the other direction.



5. Click **OK** to create the extrapolated curve.



- You can also use the manipulators to interactively modify the value.
- The curvilinear length of the extrapolation is displayed.
- Capabilities are available from:
 - the [contextual menu](#) when right-clicking an end point.
 - the dashboard are: [datum creation](#), [auto detection](#), [attenuation](#).



Extending Curves

This task explains how to lengthen a curve by extension, that is by modification of its length. Two extension modes are available. In one case, it is a positive parametric extension, or it can be an extension by addition of segments to the curve.

Open the [Extend1.CATPart](#) document.

1. Select the curve(s) to be extended.

Multi-selection of curves is now possible.

2. Click the **Extend** icon



Manipulators are displayed on the curve.

The Extend dialog box is displayed.

Two working modes are available:

If you go over a curve's extremity with the mouse, the manipulator becomes the master manipulator, meaning it is active at that extremity.

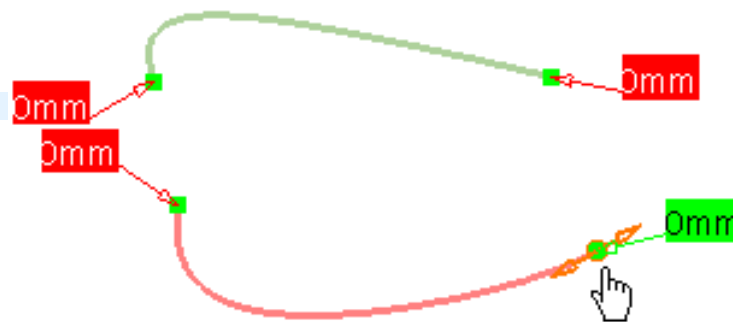
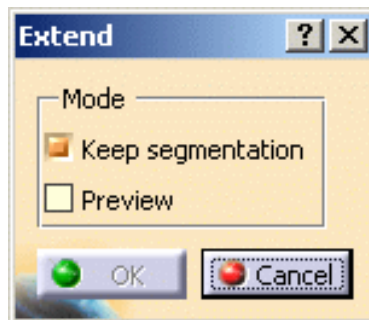
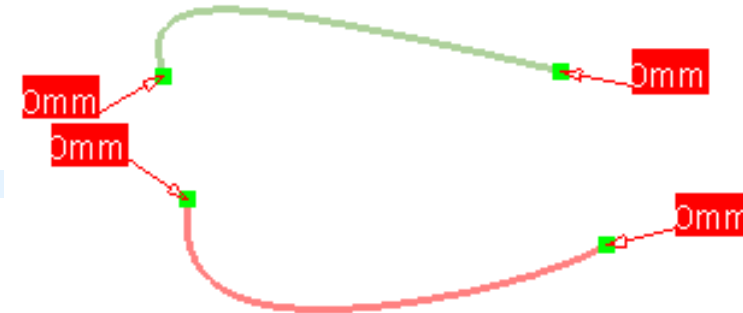

3. Use the manipulators to extend the curve on both sides.

- With the **Keep segmentation** option checked: use the manipulator to define the curve extension. When the value is positive, the last segment (defined by the arc limits) is made longer.

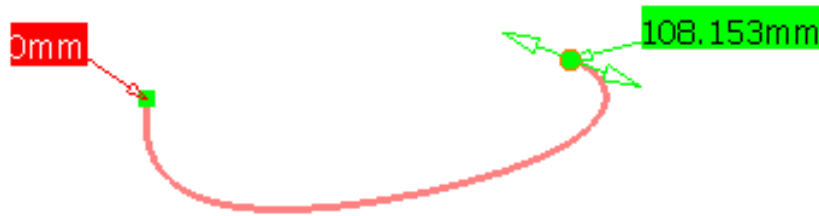

The distance tag displays the absolute curve distance from the extremity of the original curve.

- With the **Keep segmentation** option unchecked: the curve is extended taking the curvature continuity of the last segment into account. This means that only this last segment can be extended.

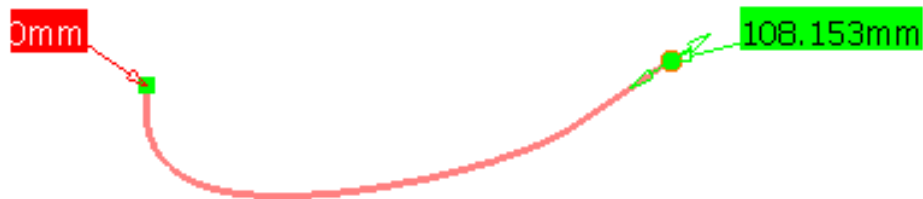

 If you change the mode, the new curve is computed from the original curve, not from the curve previously computed..

4. Click **OK** to create the extended curve.



Extending Curves Using Absolute and Relative Distance Modes

1. Right-click the distance tag which displays the absolute curve distance.
2. Choose the **Edit** item in the contextual menu.

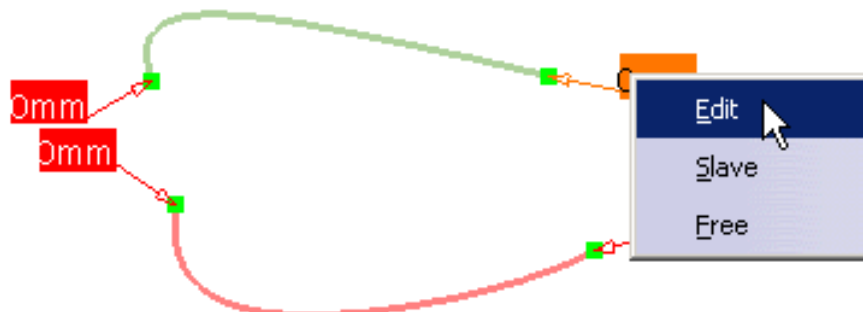

The Edit Box dialog box is displayed.
The manipulator becomes active and the distance tag is symbolized in green.

3. Enter the extension value.

Here we chose 100mm.

4. Click Close to apply the new value.

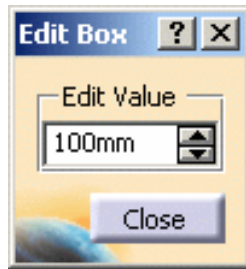

This value is always positive.



5. Again, right-click the distance tag.

6. Choose the **Slave** item in the contextual menu.

This option enables to apply the delta curve extension to the master manipulator **and** the slave manipulator.

A  symbol appears near the slave manipulator and its distance tag is symbolized in yellow.

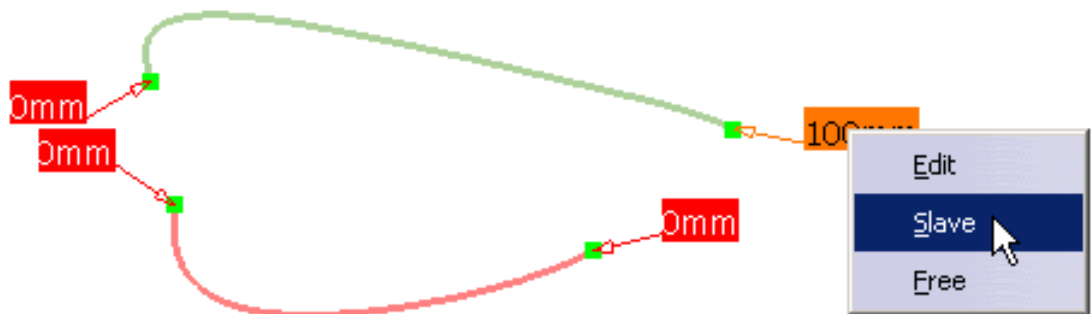

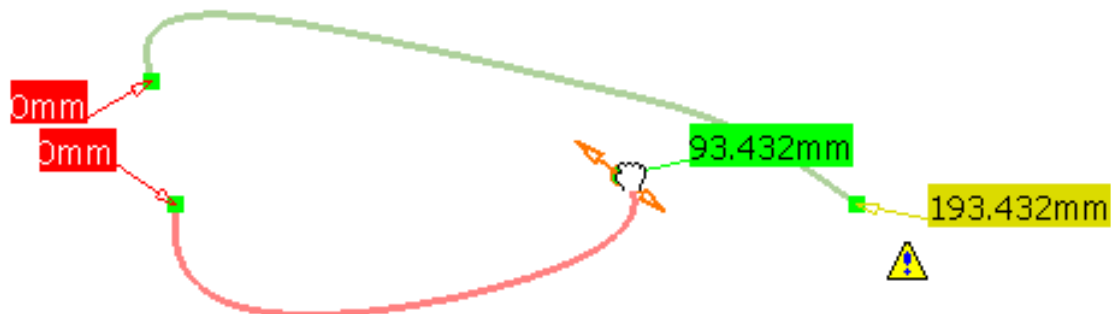

7. Now use the manipulators to extend the second curve.

You can see that both curves are extended with the same delta (93.432mm). The slave manipulator





"follows" the master
manipulator.

 If you go over the distance tag of the slave manipulator with the mouse, it becomes active again.

-  You can also access these contextual menu items by clicking the distance tag and moving sequentially from one option to the other (Edit, then Slave, then Free).
- The **Free** option enables to free the slave manipulator.

 You can extend a trimmed 3D or 2D curve: the parameterization of the original curve is used, then the extension is calculated. When extending a 2D curve, a 3D cell is added. Therefore the extended curve is made of two or more cells.

 The **Edit** and **Keep this point** options are also available from the [contextual menu](#) when right-clicking the manipulator.

 Capability are available from the Dashboard: [datum creation](#) and [keep original](#).





Trimming Curves



 This task explains how to trim curves by one or more curves or points.

 Open the [Break2.CATPart](#) document.

 **1.** Click the **Break** icon .

The FreeStyle Break dialog box is displayed as well as the Break Report panel and the [Tools Palette](#).

2. Choose the Break type by clicking on the icons on the left.

Three types are available:

- [Curves by points](#)
- [Curves by curves](#)
- [Surfaces by curves](#) (please refer to the corresponding chapter)

Breaking Curves by Points

In the Selection page, the **Cut (0)** text is highlighted.



1. Select one or more curves to be trimmed.

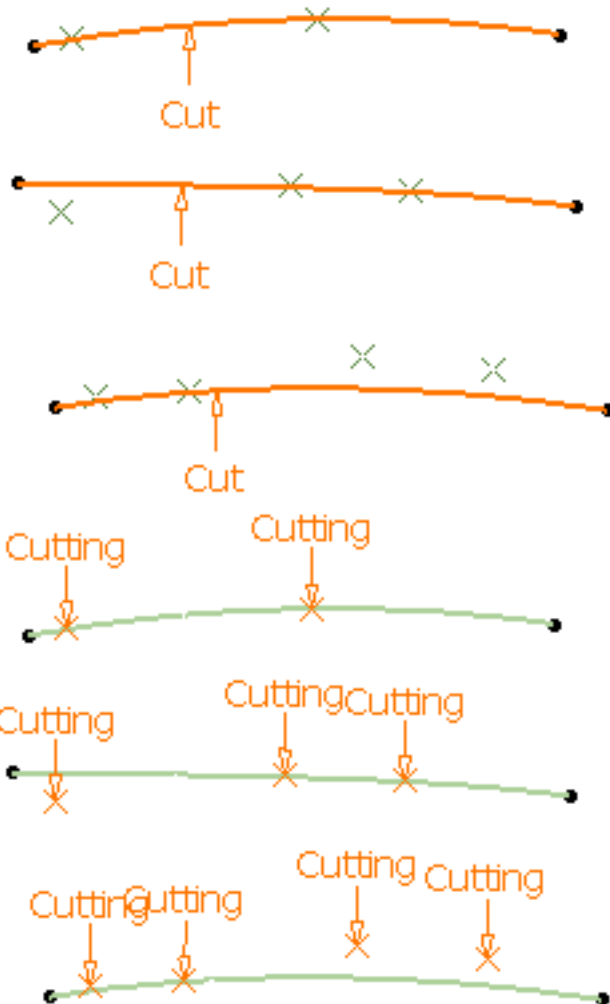

2. Click the **Cutting** (0) text and select one or more cutting points.

3. Click Apply.
By default, all elements are kept.

The Break Report panel displays all the information regarding the cutting elements.

It lists:

- the cutting elements that can be used for the Break (marked by a green tip). If you click on the text, the corresponding curve is highlighted in green in the 3D geometry.
- the cutting elements that cannot be used for the Break (marked by the condition to be applied so that they can be used: projection, etc). If you click on the text, the corresponding curve is highlighted in red in the 3D geometry.
 - If there is no selection of cutting elements, an error message is issued and the Break Report panel informs you that no element is selected.
 - If a red cross is displayed, it means that the problem cannot be managed by the system.

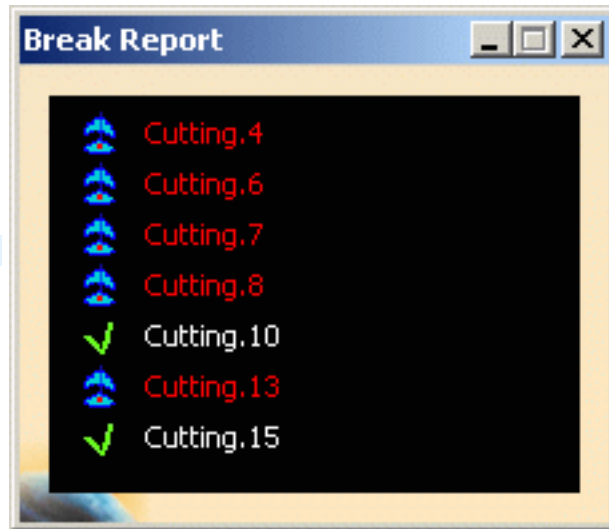

 This panel can also be opened via the Display tab.

- Click the parts of the curves you do not want to keep: they appear dotted in the 3D geometry.

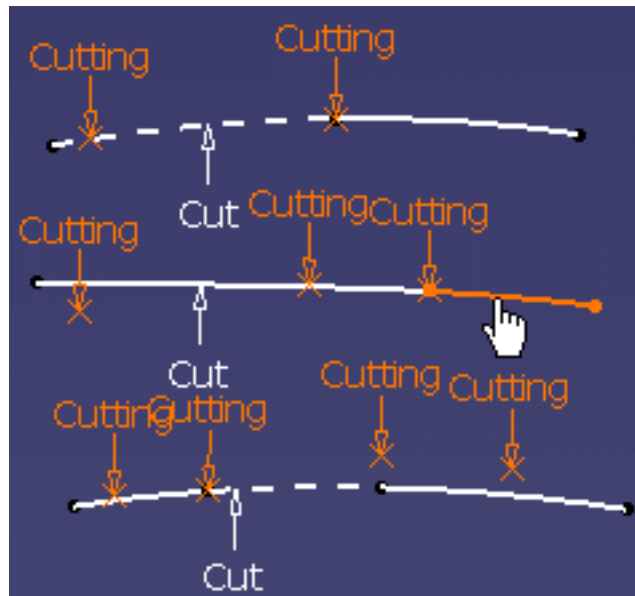

A contextual menu is available on the each part of the surface.

- Keep all:** all parts of the all curves are kept
- Keep all but this:** all parts of all curves are kept except the selected one
- Remove all but this:** all parts of all curves are removed except the selected one

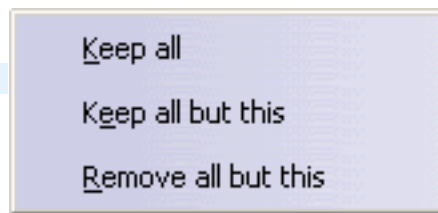

- Click the <<**Settings** text to access advanced settings.

The following options can be activated by clicking on the icons.

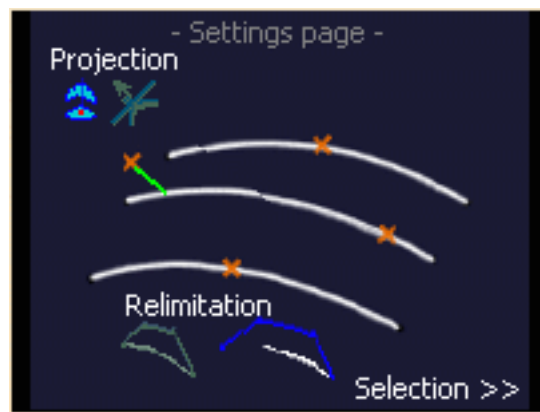

Projection

- **no projection:** click the **Projection** text to make the projection optional. As a consequence, the points that do not lie on the trimmed curves will not be projected onto the surface.

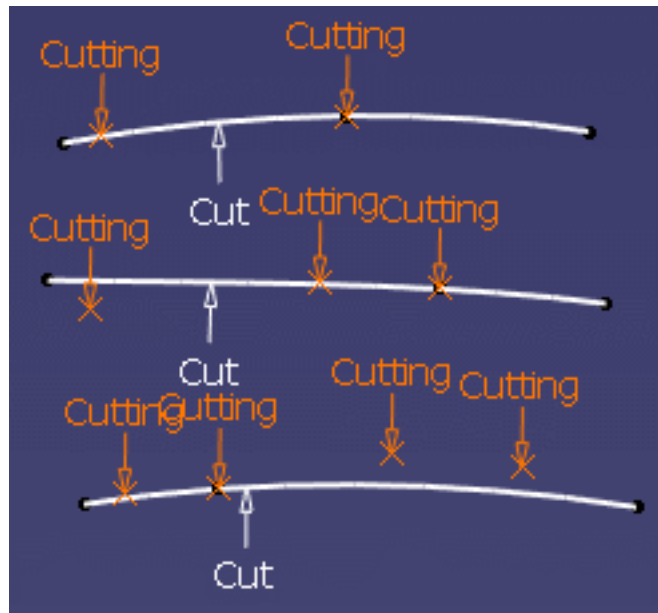

If certain points do not lie on the trimmed curves, they will be projected (pseudo-intersections) onto the curves according to the direction set in the Break dialog box, that is:

- **Compass:** click the compass icon so that the projection is normal to the compass.

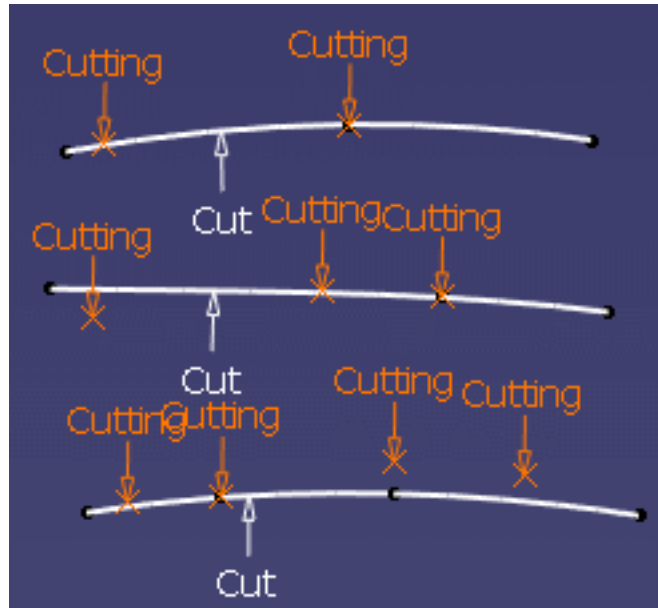

- **Normal:** click the normal icon so that the projection is normal to the element.

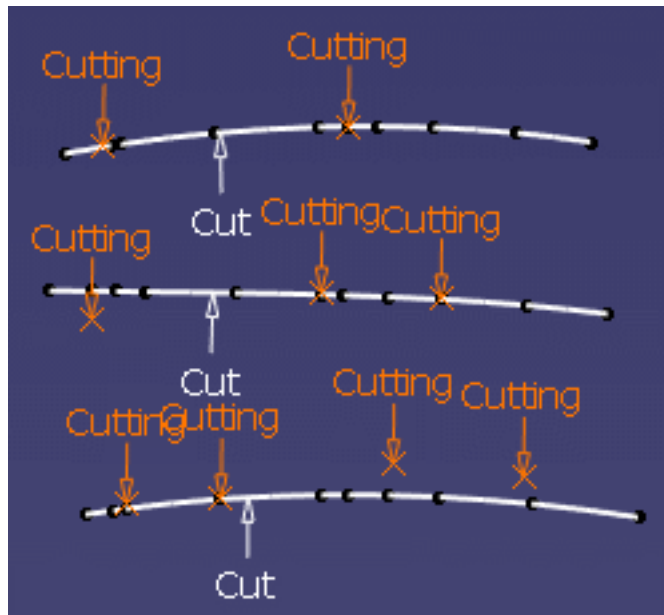

Relimitation

- Keep mesh:** click the Keep mesh icon so that the curves are topologically relimited and the control points of the initial curves are kept. Here is an example with a projection normal to the compass.

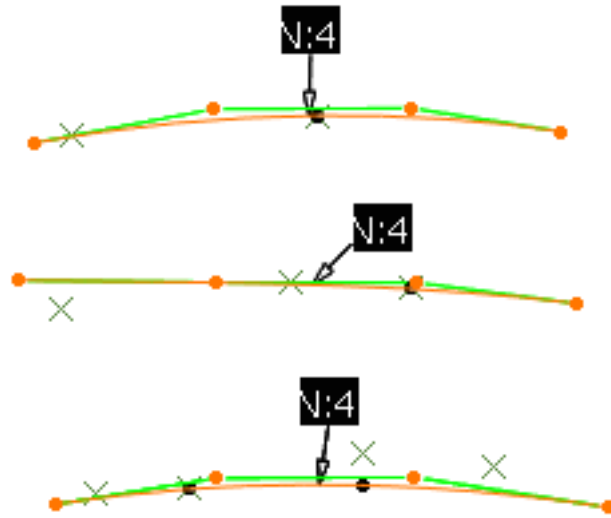

- Shorten mesh:** click the Shorten mesh icon so that the curves are geometrically relimited and the control points of the resulting curves are kept. Here is an example with a projection normal to the compass.

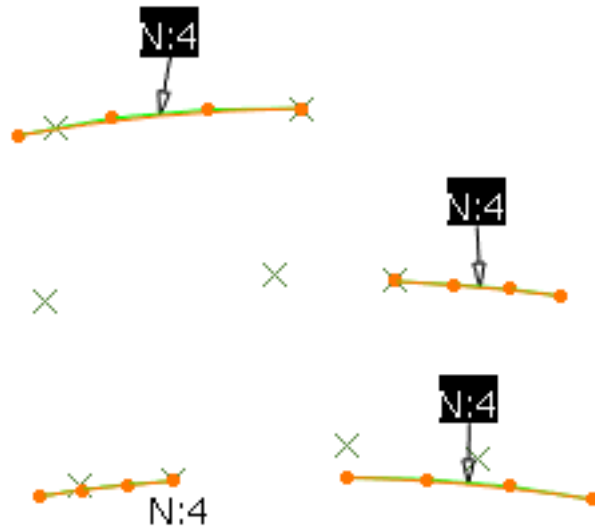



Breaking Curves by Curves

In the Selection page, the **Cut (0)** text is highlighted.



1. Select one or more curves to be trimmed.

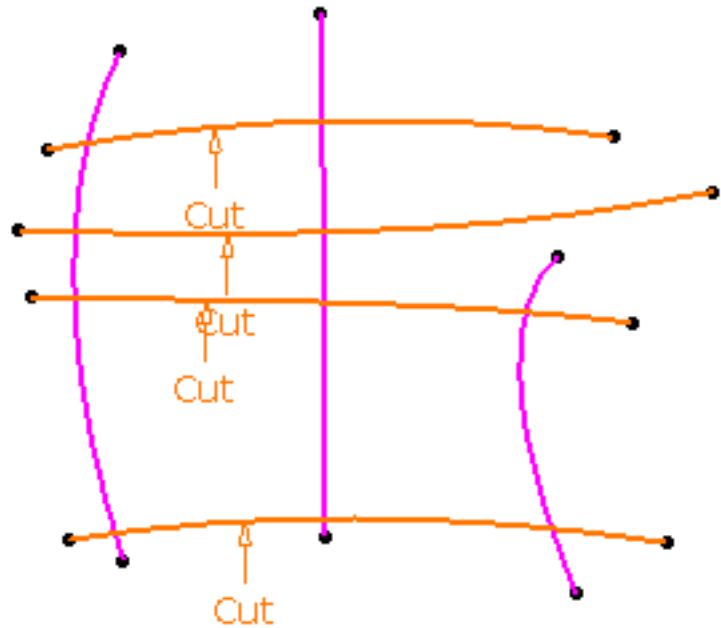

2. Click the **Cutting** (0) text and select one or more cutting curves.

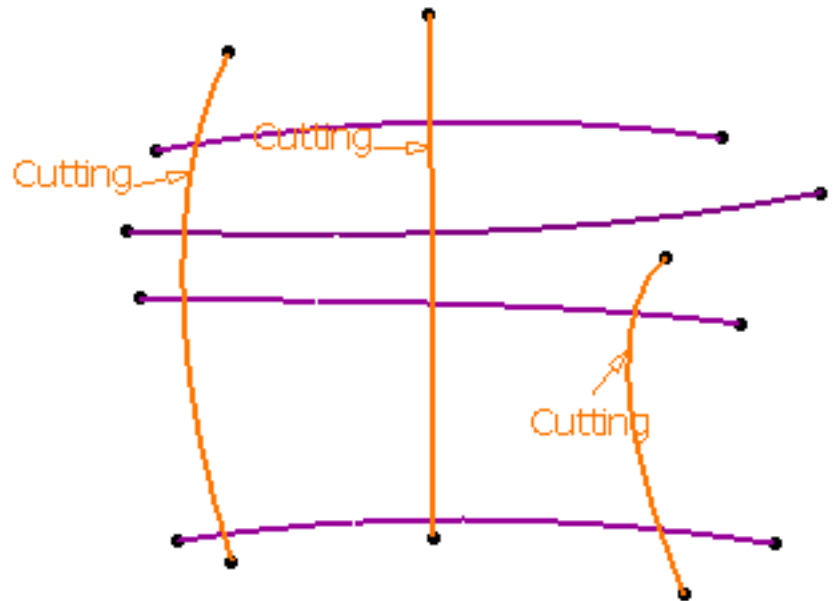

3. Click Apply.

By default, all elements are kept.





The Break Report panel displays all the information regarding the cutting elements.

It lists:

- the cutting elements that can be used for the Break (marked by a green tip). If you click on the text, the corresponding curve is highlighted in green in the 3D geometry.
- the cutting elements that cannot be used for the Break (marked by the condition to be applied so that they can be used: projection, extrapolation, etc). If you click on the text, the corresponding curve is highlighted in red in the 3D geometry.
 - In case of an extrapolation problem, the side of the curve to be extrapolated is circled in red.

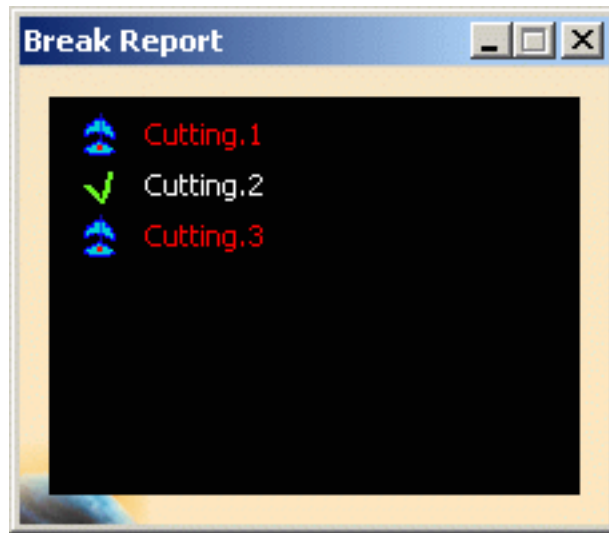
- If there is no selection of cutting elements, an error message is issued and the Break Report panel informs you that no element is selected.
- If a red cross is displayed, it means that the problem cannot be managed by the system.



 This panel can also be opened via the Display tab.

2. Click the parts of the curves you do not want to keep: they appear dotted in the 3D geometry.

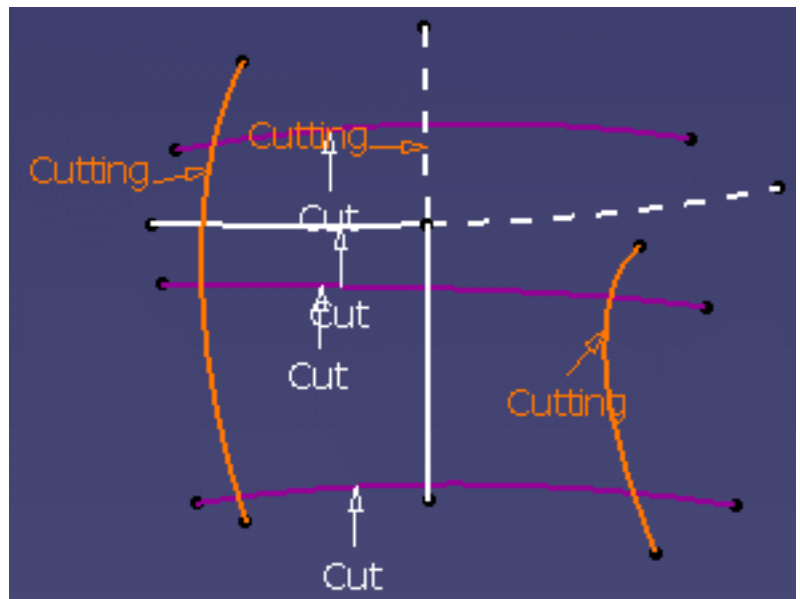

 You can now cut the cutting elements.

 A contextual menu is available on the each part of the surface.

- **Keep all:** all parts of the surface are kept
- **Keep all but this:** all parts of the surface are kept except the selected one
- **Remove all but this:** all parts of the surface are removed except the selected one

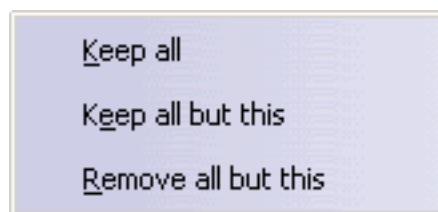

3. Click the <<**Settings** text to access advanced settings.
The following options can be activated by clicking on the icons.

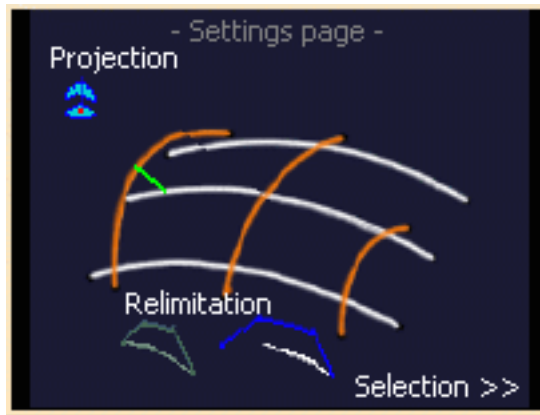

Projection

If certain points do not lie on the trimmed curves, they will be projected onto the surface according to the direction set in the Break dialog box, that is:

Compass: click the compass icon so that the projection is normal to the compass

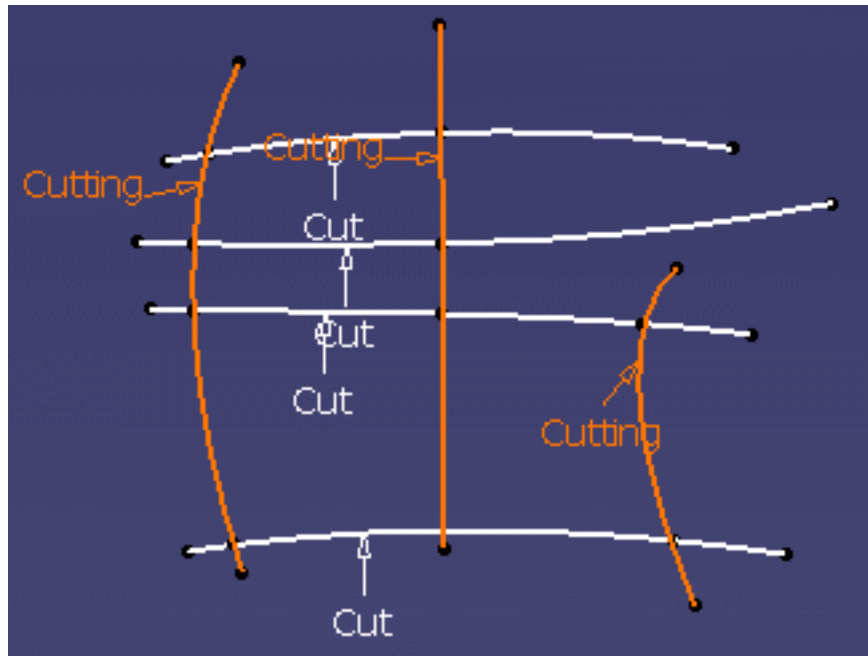

Relimitation

- **Keep mesh:** the curve is topologically relimited and the control points of the initial curve are kept.

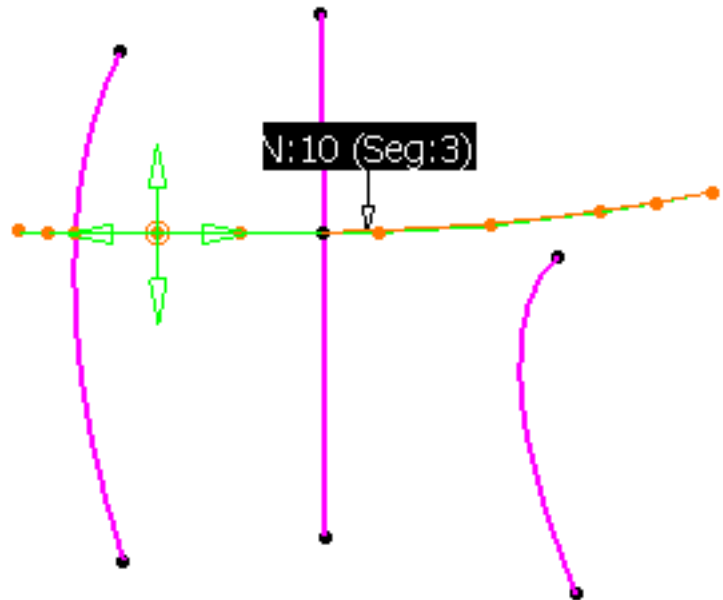

- **Shorten mesh:** the curve is geometrically relimited and the control points of the resulting curve are kept.

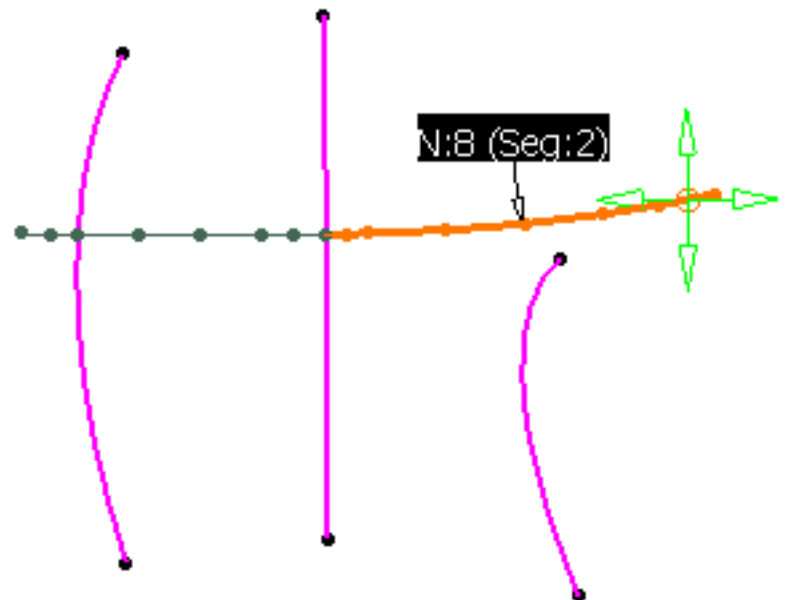

3. Click OK to trim the curves.



- Click the **Display**>> text to manage the display of the 3D icons and the Break Report panel.
- Available capabilities from the Dashboard are: [datum creation](#), [keep original](#), [insert in a new geometrical set](#), and [temporary analysis](#).



Concatenating Curves



This task explains how to concatenate a 3D multi-cell mono-domain FreeStyle curve or separate contiguous curves into a mono-cell curve.

The resulting curve is a curvature continuous curve (C2).



Open the [Concatenate1.CATPart](#) document.

This document contains a two Join-type elements, and a set of connex curves, each identified by different colors.



1. Click the **Concatenate** icon .

The Concatenate dialog box is displayed.

2. Set the tolerance value.

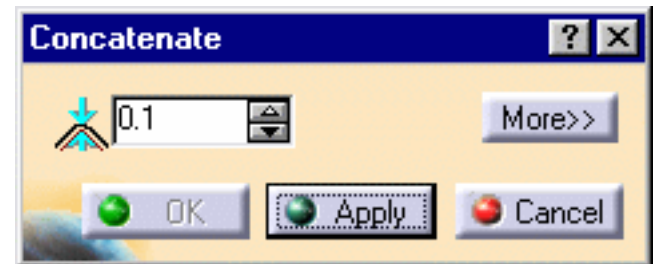

This value defines the maximum parametric deviation allowed between the selected elements and the resulting curve when concatenating.

The Maximum deviation value displayed in the dialog box (see step 4) is computed as the standard distance analysis and therefore is not necessarily the minimum tolerance value to be set in order to concatenate the curves.

Would the tolerance value you entered not be adequate, a message is issued prompting you to increase it. However, to help you, the minimum tolerance value necessary to obtain a result is then automatically displayed.

If you are using the [Auto Update Tolerance](#) mode, the minimum tolerance value is automatically modified; therefore no message is issued.

3. Select the curves you wish to concatenate and click **Apply**.

Here we selected Join.2 from the specification tree, and set the tolerance value to 1.6.

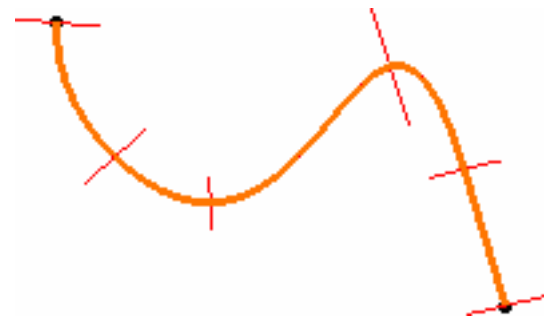

A single curve is previewed, with its segment limits, provided the tolerance is compatible. If not, no concatenated curve is previewed, and the OK button is grayed.

4. Click **More>>** in the dialog box.

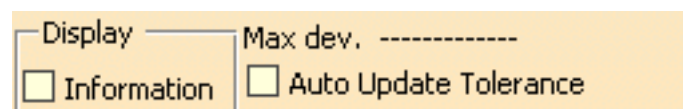

5. Check the Information option.

The corresponding information is displayed on the resulting curve, that is:

- **N**: number of control points
- **o**: the curve order
- **s**: the number of segments in the curve
- the maximum deviation

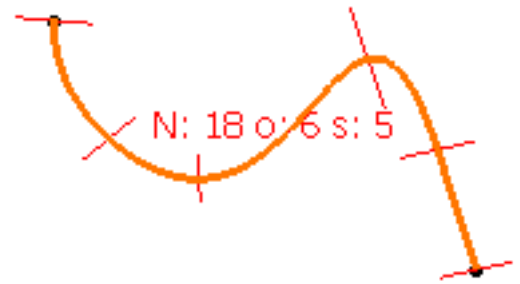

In case you did not check the Information button, the maximum deviation is also indicated in the dialog box.

6. Check the Auto Update Tolerance option to automatically update the tolerance value in case the value you set is too low.

The minimum value to enable the concatenation is displayed and the concatenation is performed.

7. Click OK in the Concatenate dialog box.

A curve is created, the result of the concatenation of the elements making up the initial Join.



- If no resulting curve is displayed once you have clicked **Apply**, increase the tolerance value.

- Multi-selection is available using the **Control** Key, i.e. you can select several Join elements for example, and each one will generate a concatenated curve. (Join.1 in green is still visible behind Curve.19, but you can notice the deviation due to the discontinuity of the initial element.)

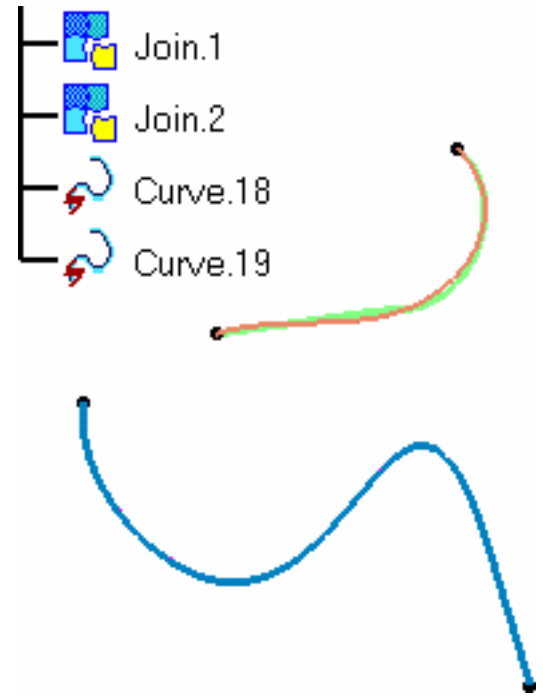

- Similarly, you can select several contiguous curves using the Control key, or a trap, to generate a single curve. If the selected curves are not connex (if there is a gap between two curves), the **Apply** button is grayed, and you cannot create the concatenated curve.

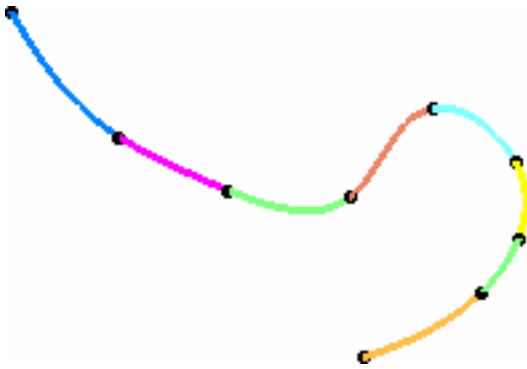

Set of independent connex curves



Resulting concatenated curve

- If the selected elements present a curvature discontinuity (as illustrated below), you will need to increase the tolerance value accordingly. In this case too, the maximum deviation will increase considerably.

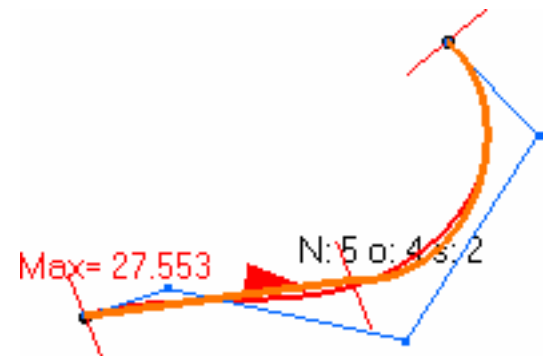
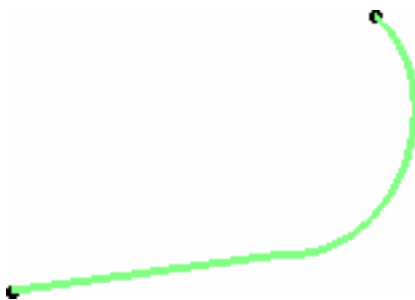

Initial element presenting a discontinuity

Deviation onto a discontinuous element

- Use the Converter Wizard prior to selecting non 3D NUPBS multi-cells curves for concatenation.



Available capabilities from the Dashboard are: [datum creation](#), [keep original](#) and [furtive display](#).



Fragmenting Curves



In this task you will learn how to fragment multi-arc bodies into mono-arc bodies.



Open the [FragmentCurve1.CATPart](#) document.



1. Select the curve.
2. Click the **Fragmentation** icon  in the Shape Modification toolbar.

The selected curve is previewed with separators indicating the limits of each arc, thus allowing the pre-visualization of the resulting curves.

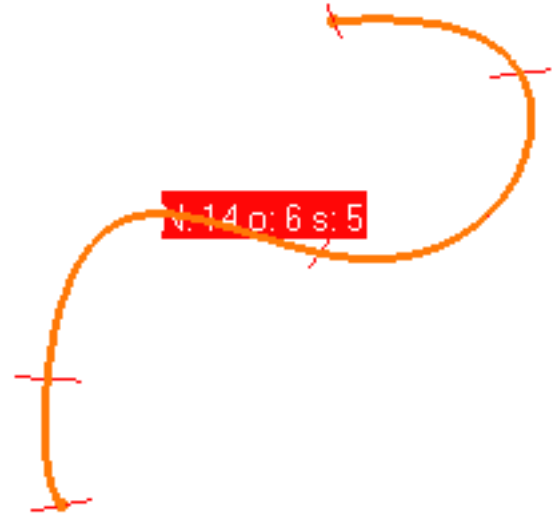

The Fragmentation dialog box is displayed.
The Type frame does not apply for curves.

3. Click the **Keep original** icon  from the Dashboard if you want to keep the initial curve when fragmenting the body.

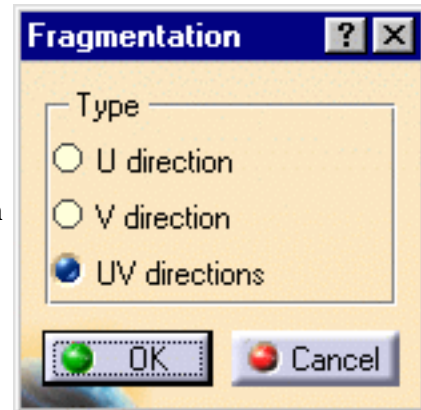

4. Click **OK**.

The curve is fragmented in as many curves as there were arcs in the initial curve. This means that independent curves are created.

In the example, we assigned a different color to each of the resulting mono-arc curves.

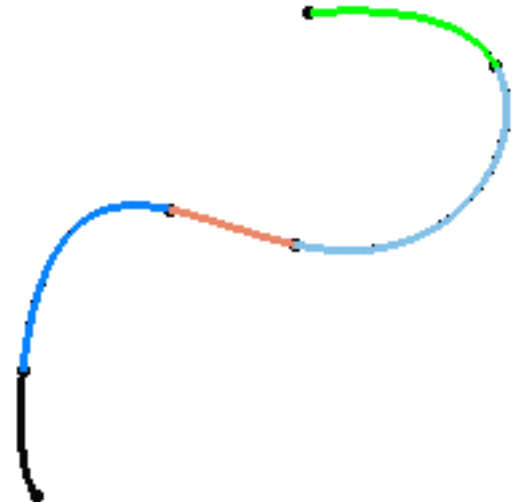



- Multi-selection is available.
- This function enables you to fragment surfaces as well, see [Fragmenting Surfaces](#).



Available capabilities from the Dashboard are: [datum creation](#), [keep original](#), and [furtive display](#).



Approximating/Segmenting Procedural Curves



In this task you will learn how to convert any curve, created using other products but FreeStyle, into a NUPBS (Non Uniform Polynomial B-Spline) curve, and to modify the number of arcs (segments) onto any curve, including these created using FreeStyle products.

This approximation is automatically performed when you try to edit a curve using control points. In this case:

- when an exact conversion can be performed, it is done automatically, and the Converter Wizard is not displayed. This is often the case with splines and lines.
- when the exact conversion cannot be performed, as for ellipses, hyperbolas, parabolas, and so forth, the converter Wizard is displayed allowing you to define the approximation tolerance.



Open the [Approximate1.CATPart](#) document.



1. Select the curve to be approximated.

2. Click the **Converter Wizard** icon .

The **Converter Wizard** dialog box is displayed allowing you to define the approximation according to a tolerance.

You need to set the values for the different options:

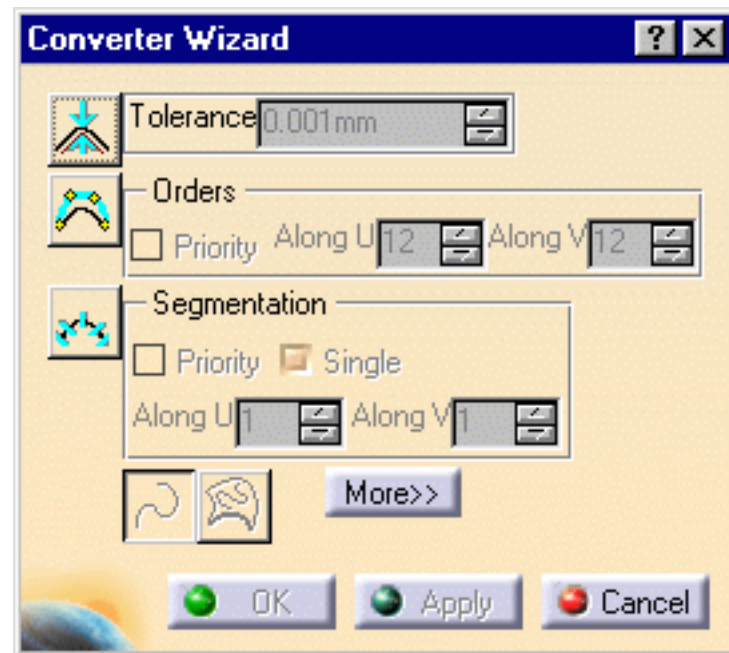

- **Tolerance:** that is the deviation tolerance from the initial curve. On the geometry, a red text is displayed if the tolerance is not respected, that changes to green when the new element is within the specified tolerance.
- **Orders:** that is the maximum allowed order along the U direction for each curve segment. This value must be greater than or equal to 2 along U, when the segmentation options are grayed (one segment only). Otherwise, it must be greater than 4 included (when there are several segments). The maximum value allowed per segment is defined by the [Max order](#) field in the FreeStyle Settings and must be less than or equal to 16.



In P1 mode, the **Max order** is set to 16 and cannot be modified.

- **Segmentation:** that is the maximum allowed segments along the U direction.
If **Single** is checked, a mono-segment curve is created.

When one of these options is inactive, the system automatically optimizes this option's parameters to comply with the other options' values.

Furthermore, two buttons offer other capabilities:

1. **3D conversion:** to convert a curve on surface into a 3D curve
2. **2D conversion:** to retain the 2D of a curve on surface

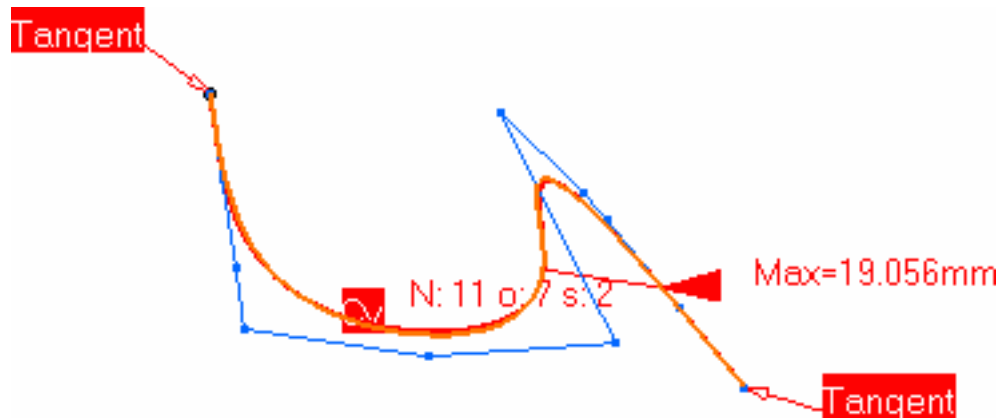

Depending on the type of the initial element, a text is displayed indicating what approximation needs to be performed:

- **CV:** the initial curve is not a NUPBS and needs to be approximated using the Converter Wizard parameters
- **EXACT:** the initial curve can be converted in exact mode (no parameter needs to be set)
- **Seg:** the initial curve already is a NUPBS



Provided the **Continuity** icon  is active from the Dashboard, and at least one conversion option is active (**Tolerance**, **Orders**, or **Segmentation**, i.e. you are not in exact conversion mode), a continuity constraint can be imposed identically on both curve end points.



Two continuity types are available: tangent or curvature continuity. By default, it is tangent, and you can change it either by using the contextual menu or by clicking the text in the geometry.

3. Click **More>>** to display more options:
 - Check the **Information** option to display further information on the element:
 - **Max**: the maximum deviation in relation to the initial element
 - **N**: number of control points
 - **o**: the curve order
 - **s**: the number of segments in the curve
 - Check the **Control Points** option to display the curve's control points.
 - Check the **Auto Apply** button to dynamically update the resulting curve.

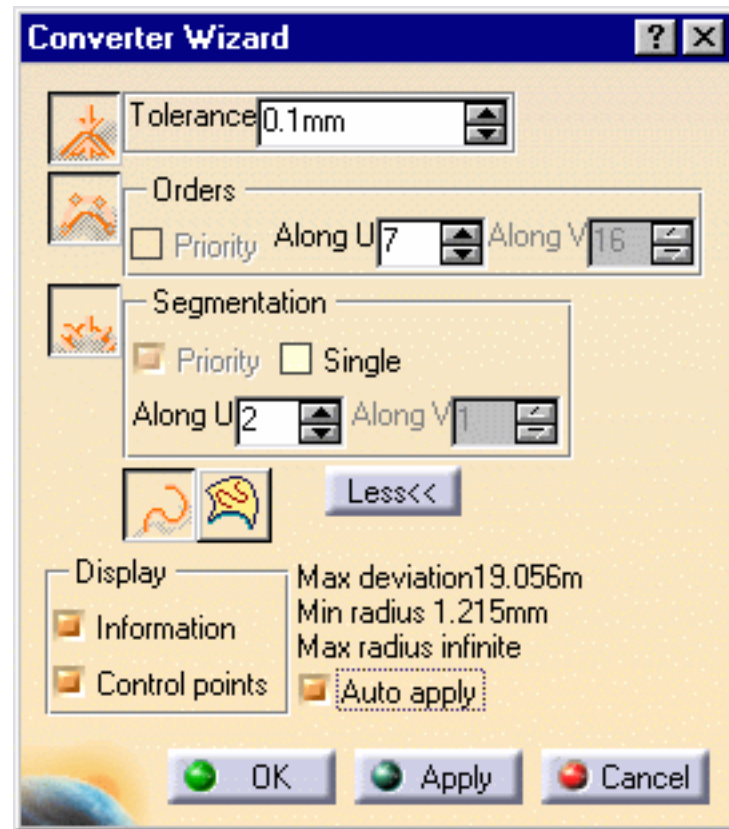

Furthermore, the maximum deviation, minimum and maximum radius values are displayed in the Converter Wizard for information

4. Click **OK**.

The curve modification is taken into account.



- Multi-selection of curves is available.
- You can mix the approximation of curves and surfaces.
- The **Priority** check button indicates which of the Orders or Segmentation parameter is taking precedence over the other one.
- Use the Exact conversion mode (no parameter needs to be set) on a NUPBS element to display the number of control points, curve order, and number of segments in the curve. Note that in this case, the initial element is duplicated.



To convert a multi-cells curve, select it from the specification tree. If selected in the geometry, you might be selecting only one cell instead of the whole curve.



Available capabilities from the Dashboard, and/or specified through the [FreeStyle Settings](#), are: [datum creation](#), [keep original](#) (depending on the selected element), [continuity](#), and [furtive display](#).



Creating and Managing Surfaces

This chapter deals with surface creation and management using the FreeStyle Shaper workbench.



See also the [FreeStyle Dashboard](#) tools as they affect the curve creation and modification.



Create planar patches: use the compass to define the creation plane, click two points.



Create a surface from three points: click two points, drag the pointer and click a third point.



Create a surface from four points: click at least three points on existing geometry and a fourth point.



Create a surface on an existing surface: select a surface, click a point, drag the pointer over the surface and click another point still on the surface.



Create revolution surfaces: select a profile, a rotation axis, and define the angular limits of the revolution surface.



Edit surfaces using control points: select a surface, set the deformation options, pull on the control points and mesh lines in specific directions.



Edit a surface boundary: select a surface boundary and edit it using its control points.



Extrude a surface: select a curve, set the extrusion direction and value.



Offset surfaces: select a surface, specify the offset type (simple or variable), the offset value and constraints to be taken into account when offsetting (deviation tolerance, maximum orders, etc.).



Extrapolate a surface: select a surface boundary, specify the extrapolation type and value.



Create blend surfaces: click an edge on two surfaces, set the display options allowing the modifications of continuities and tensions, manipulate the coupling points defining the blend.



Create an ACA Fillet: click the icon and select two edges.



Create filling surfaces: select contiguous surface boundaries forming a closed contour, or close it by clicking OK.



Create associative filling surfaces: select contiguous surface boundaries forming a closed contour, or close it by clicking OK.



Manipulate surfaces: select a surface, drag and drop the compass onto it, move the surface along the compass axes.



Rotate a surface: select a surface, drag and drop the compass onto it, select, hold and glide on one of the compass' arc of circle



Match surfaces: select a surface edge and a boundary on another surface, specify the matching parameters using manipulators on coupling and control points, and the contextual menu to set continuities and tensions.



Multi-side matching: successively select a surface edge and its target curve on another surface, specify the matching parameters, and use the contextual menu to set continuities or surface order.



Extend a surface: select a surface boundary, specify the extension type and value.



Smooth surfaces: select a surface, set the smoothing weight and click Run.



Redefine surface limits: click the icon and select the part of the surface to be removed.



Restore a surface: select the surface to be restored and click the icon.



Concatenate surfaces: select a two-cell surface, or two separate surfaces, and set the tolerance value.



Fragment surfaces: select a surface and specify the breaking options.



Disassemble elements: select a multi-cell element, and choose the disassembling mode.



Approximate/segment procedural surfaces: select a surface, specify the approximation tolerance, and the resulting surface maximum orders and/or segments



Copy geometric parameters: select the template curve and select the target curves.



Create a Continuity Constraint: click the Continuity Constraint icon and select the elements to be connected.

Creating Planar Surfaces

 This task explains how to create planar patches, that is planar surfaces.

 Open a new .CATPart document.

 **1.** Click the **Planar Patch** icon .

The 3D compass is displayed in the document and looks like this:

The solid planes of the 3D compass indicate in what plane any action is to be performed.

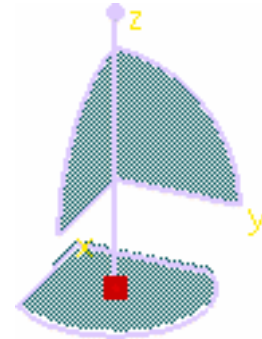



By default the creation plane is the XY plane. However, you can right-click the compass to display other options:

- a. **Make XZ the Privileged Plane:** elements are created in the XZ plane
- b. **Make YZ the Privileged Plane:** elements are created in the YZ plane
- c. **Make Privileged Plane Most Visible:** the plane in which elements are created is the plane seen most.

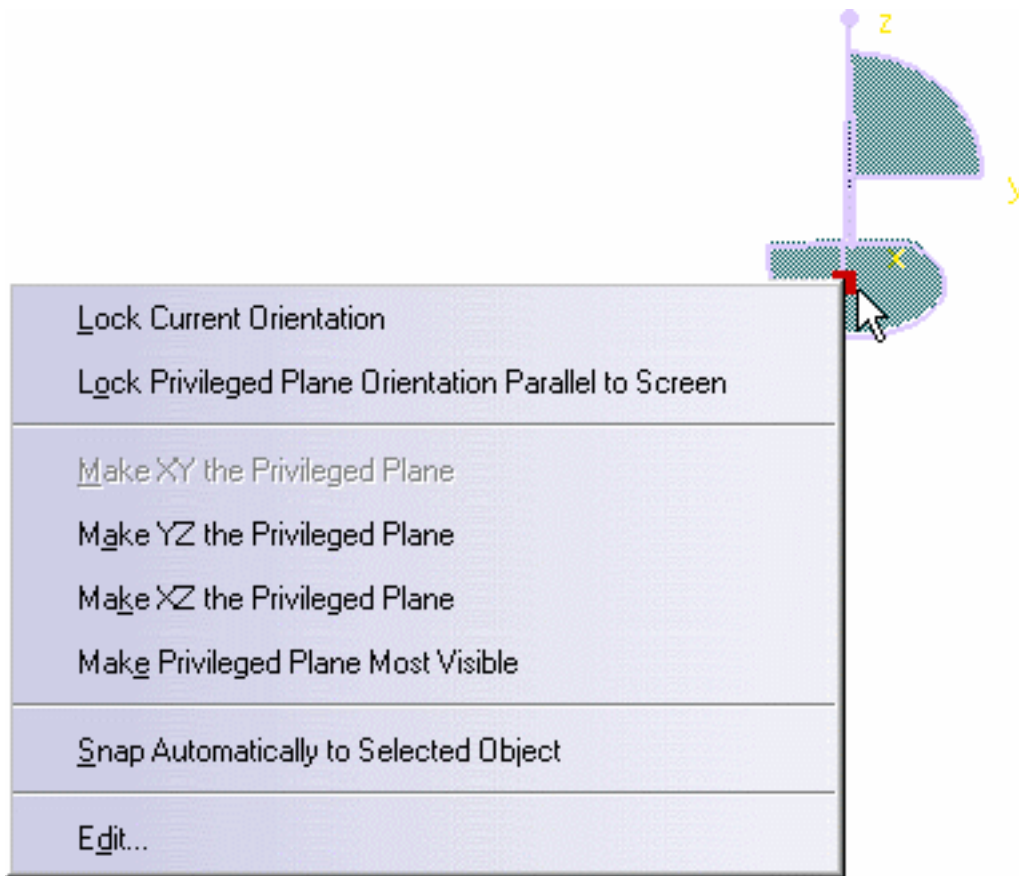
Keep the default working mode.



i The surface is created in the current active plane as defined using the Current plane orientation toolbar containing the **Flip to UV or XY** , **Flip to VW or YZ**  or **Flip to WU or XZ**  icons. To find out more about the compass, see [Moving Objects Using the 3D Compass](#).

2. Click anywhere in the window.

An outline appears and evolves as you move the pointer in the main window. Two values are displayed indicating the length and width of the patch.

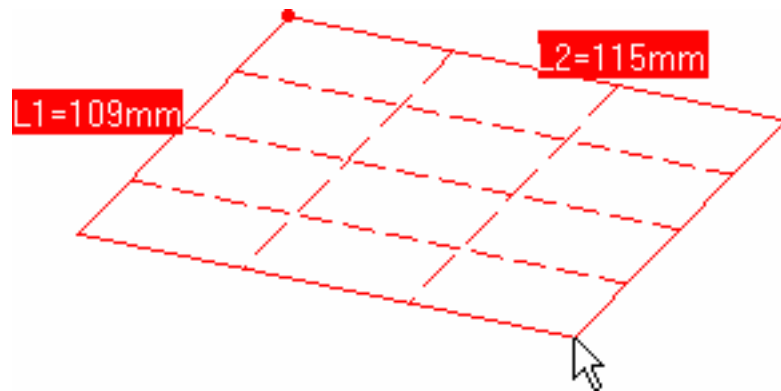

If you call the function when a plane is selected, the surface is created in the selected plane otherwise it is created as described in the following cases.

- If the 3D compass is in the model, the surface is created in the plane defined by the base.
- If the 3D compass is in the upper-right corner of the screen, the surface is created in the plane parallel to the compass base and passing through:
 - the origin of the model if the first point selected is in space
 - the first point selected on geometry

3. Right-click and choose Edit dimensions.

If you do not explicitly enter the dimensions of the surface, simply click again when you have reached the adequate size.

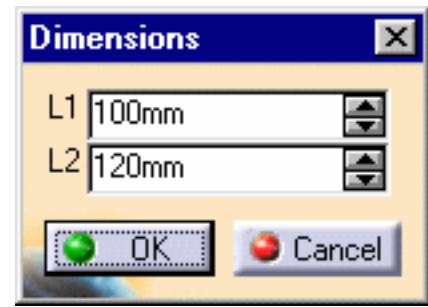

The planar patch is created.



- Once the first point is defined, right-click anywhere, and choose the **Edit Orders** menu item, to edit the surface degree (in U and V) using the Orders dialog box just like you edited the dimensions.

- Using the Ctrl-key, the planar patch is centered around the point corresponding to the initial click, otherwise, by default, this point corresponds to one corner or the patch.

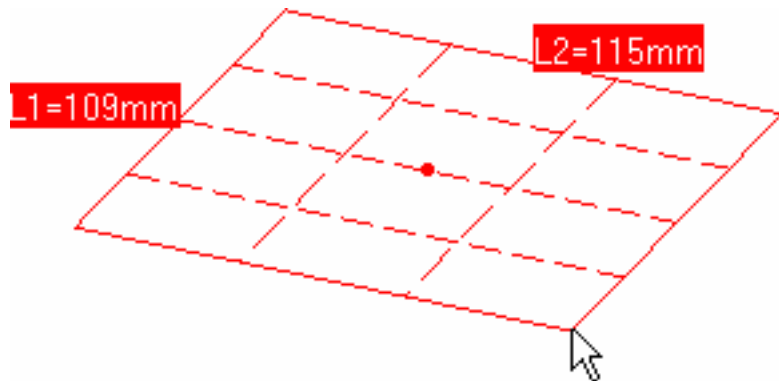

Available capabilities from the Dashboard are: [datum creation](#), and [auto detection](#).



Creating a Surface from Three Points



This task explains how to create surfaces by clicking three points in pre-existing geometry or space.



Open a new .CATPart document.



1. Click the **3-Point Patch** icon  in the Surface Creation toolbar.

2. Successively click two points in space, or on already existing geometry, to define the first direction of the patch.

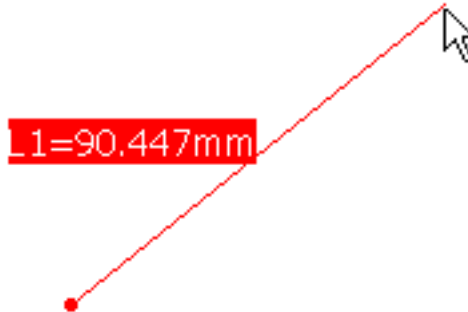



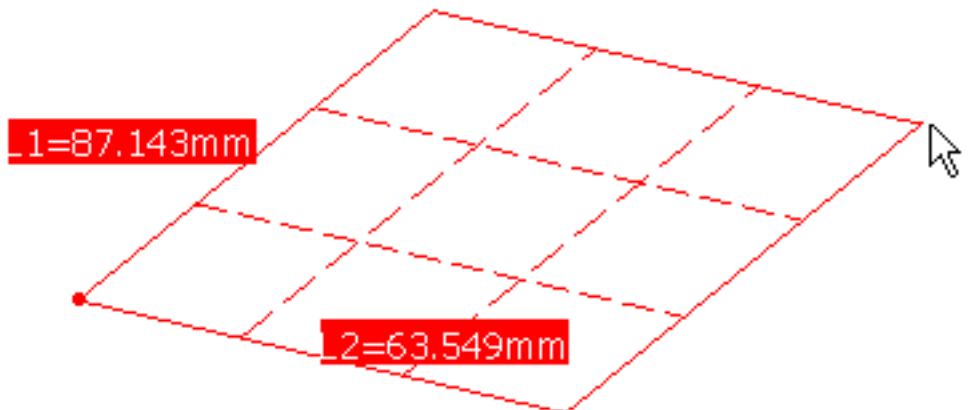

A line is displayed to show the direction, and a text indicates the length of the segment.

3. Drag the pointer.

A planar patch is pre-visualized and evolves as the pointer moves in space: the first two points making up the direction, the second length of this same patch being given by the distance between the first line and the normal projection from the pointer location onto the privileged plane containing the first point.



You can also right-click, and choose the **Edit Dimensions** menu item, to display the Dimensions dialog box that allows you to define exactly the second length of the patch.

 The surface is created in the current active plane as defined using the **Current plane orientation** toolbar containing the **Flip to UV or XY** , **Flip to VW or YZ**  or **Flip to WU or XZ**  icons.

4. Click a third point to define the second direction of the patch as well as its area. The planar patch is created.

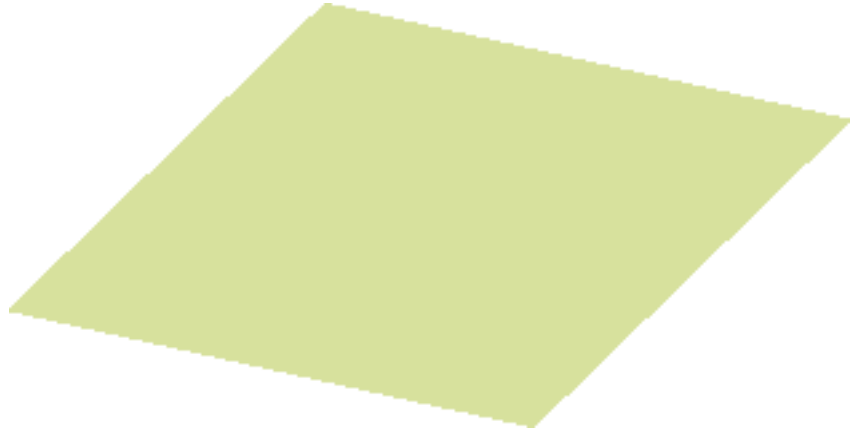

-  Right-click and choose the **Edit Orders** menu item to edit the surface orders (U and V) at any time during the creation.
- Use the Ctrl-key to create a patch symmetrically on each side of the segment defined by the first two points.

 Available capabilities from the Dashboard are: [datum creation](#), and [auto detection](#).





Creating a Surface from Four Points



This task explains how to create surfaces by clicking four points in pre-existing geometry and space.



Open the [FourPointsPatch1.CATPart](#) document.



1. Click the **4-Point Patch** icon  in the Surface Creation toolbar.

2. Click one of the curves.

You can click anywhere on any curve, at the intersection of curves, or on any other element.

3. Successively click two other points on the pre-existing geometry. An outline is previewed, representing the surface as it is defined.

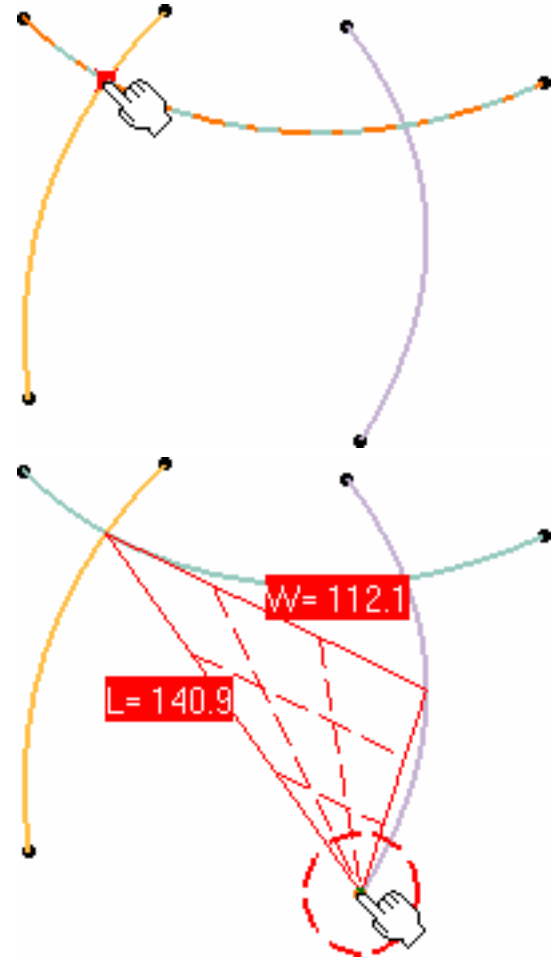

4. Click anywhere in the document to create the last point used in the surface definition.

If you click in space, the patch is a planar patch that belongs to the plane defined by the first three points.

If you click the fourth point on existing geometry, the resulting surface will not necessarily be planar.

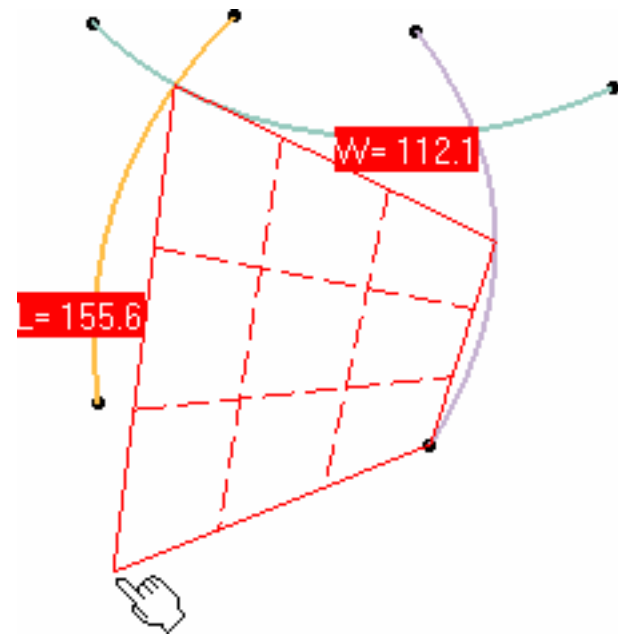

5. Once all four points have been clicked, the corresponding surface is automatically created.

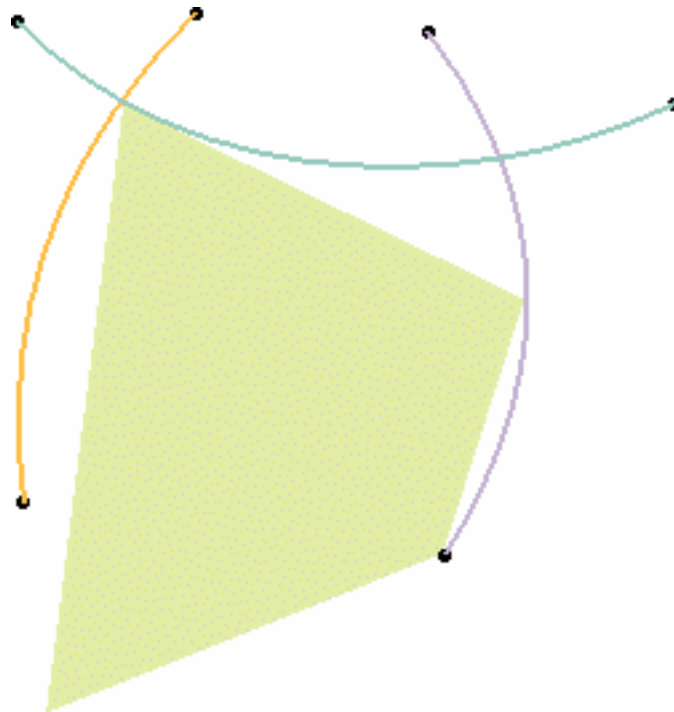

- Right-click and choose the **Edit Orders** menu item to edit the surface orders (U and V) at any time during the creation.



- Available capabilities from the Dashboard are: [datum creation](#), and [auto detection](#).



Creating a Surface on an Existing Surface



This task explains how to create a surface on an existing surface. The newly created surface will lie on the initial one.



Open the [SurfOnSurf1.CATPart](#) document.



1. Select an existing surface.
2. Click the **Geometry Extraction** icon .
3. Click on the surface, where you would like a corner of the new surface to be located.
If you press the Ctrl-key while clicking, the surface is created symmetrically in relation to the initial surface center.
4. Drag to generate a rubberband matching the new surface.
5. Click once you are satisfied with the new surface as visualized.

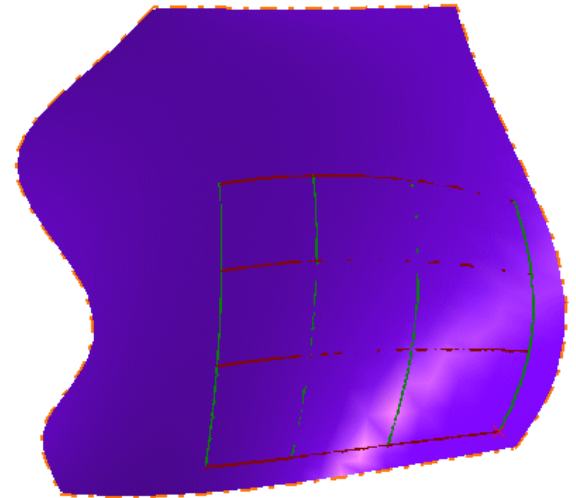
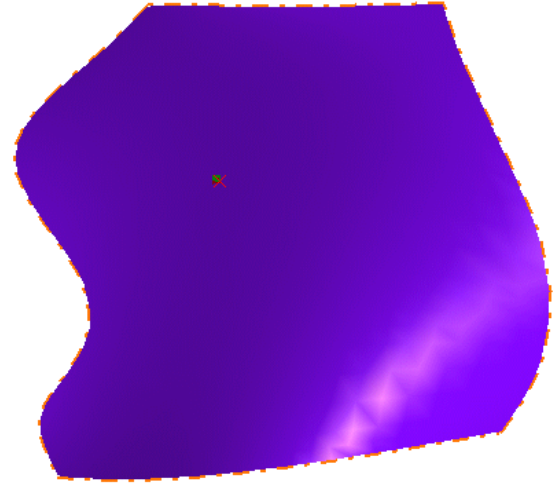

6. A surface is created lying exactly on the initial surface:

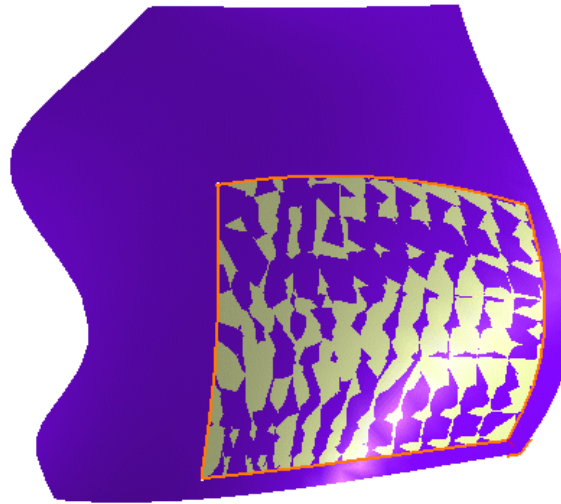

- As opposed to the creation of planar patches, you cannot define the surface orders (U and V) prior to or while creating the surface. The resulting surface orders are identical to those of the initial surface. However, these values can later be edited (see [Editing Surfaces Using Control Points](#)).
- These surfaces, as any other surfaces, can be edited using the control points.
- If you move the pointer to the edge of the initial surface, the new one will automatically snap on the initial boundary.
- Similarly, you can create curves on an already existing curve. Using the Ctrl-key will then create a curve symmetrically in relation to the initial curve center.
- See [Creating Curves on Surfaces](#) to find how to use the remote auto detection capability.



Only the [datum creation](#) capability is available from the Dashboard.



Creating Revolution Surfaces



This task shows how to create a surface by revolving a planar profile about an axis.



Open the [Revolution1.CATPart](#) document.

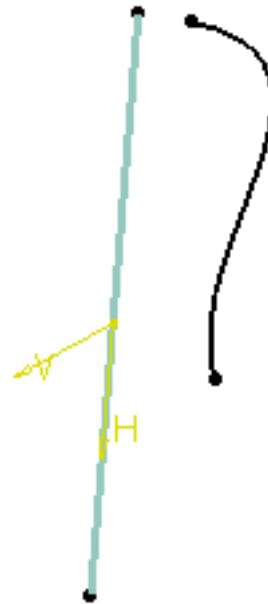

1. Click the **Revolve** icon .

The Revolution Surface Definition dialog box appears.

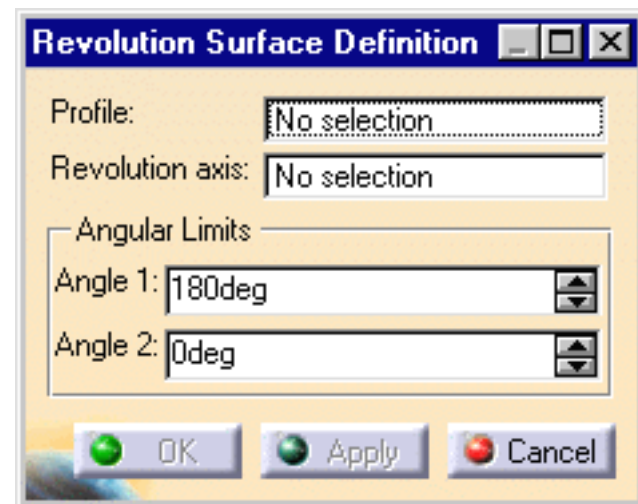

2. Select the **Profile** and a line indicating the desired **Revolution axis**.
3. Enter angle values or use the graphic manipulators to define the angular limits of the revolution surface.

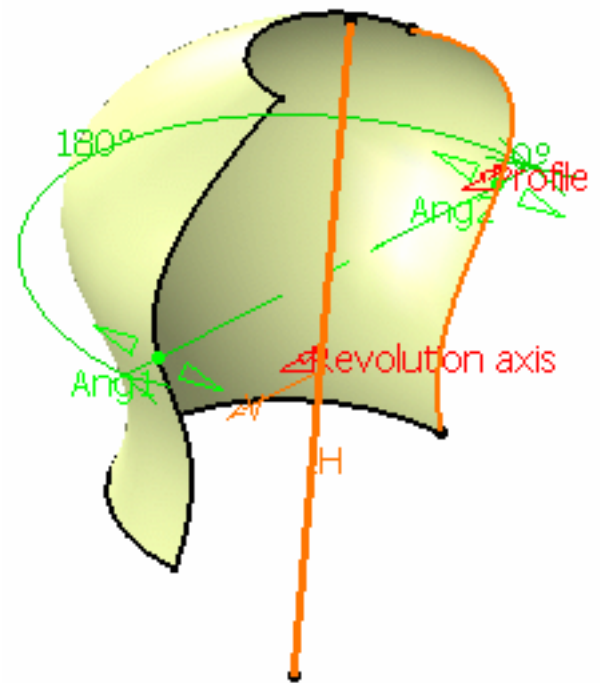

4. Click **OK** to create the surface.

The surface (identified as Revolute.xxx) is added to the specification tree.

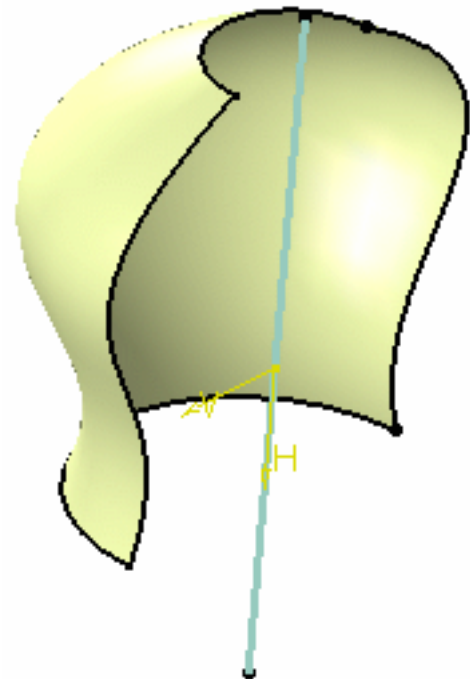

- There must be no intersection between the axis and the profile. However, if the result is topologically consistent, the surface will still be created.
- If the profile is a sketch containing an axis, the latter is selected by default as the revolution axis. You can select another revolution axis simply by selecting a new line.

Parameters can be edited in the 3D geometry. To have further information, please refer to the [Editing Parameters](#) chapter.



Editing Surfaces Using Control Points

 This task explains how to modify a surface using control points and mesh lines.

 Open the [EditControlPoints1.CATPart](#) document.

 **1.** Select the surface.

 It will be duplicated if the **Keep Original** icon is active in the FreeStyle Dashboard.

2. Click the **Control Points** icon .

The 3D compass is displayed showing the privileged plane in which you are working when you are manipulating the surface.

If you select a surface that has been created outside the FreeStyle workbench, and the surface is not based on a NUPBS (Non-Uniform Polynomial B-Spline), the [Converter Wizard](#) will be automatically displayed when the surface cannot be exactly converted. This allows you to control the conversion tolerance.

However, when a surface can be exactly converted, the Converter Wizard is not displayed, the conversion is done automatically and an information message is issued.

As soon as you clicked the icon, control points and mesh lines are displayed. They are used to manually pull on the surface so as to deform it.

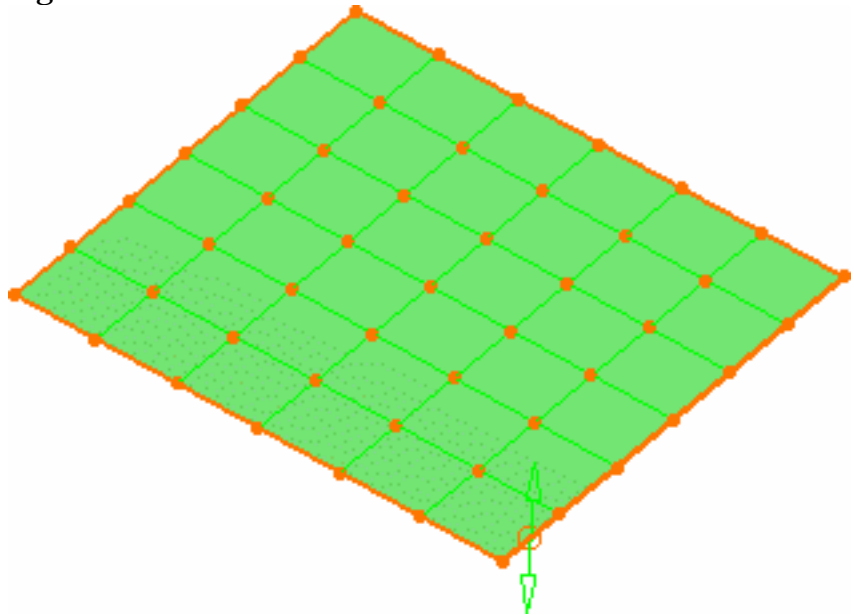

 Planes and lines are used to quickly orientate the compass in the control points command. Therefore if you select a plane or a line, it will modify the compass orientation.

The **Control Points** dialog box is displayed:

Use it to define the type of operation to be performed on the control points.

- **Support** defines the type of translation to be applied
- **Law** defines the type of deformation that is to be applied when several control points have been selected.

For further information on supports and laws, refer to [How to Use the Support and Law Options?](#)

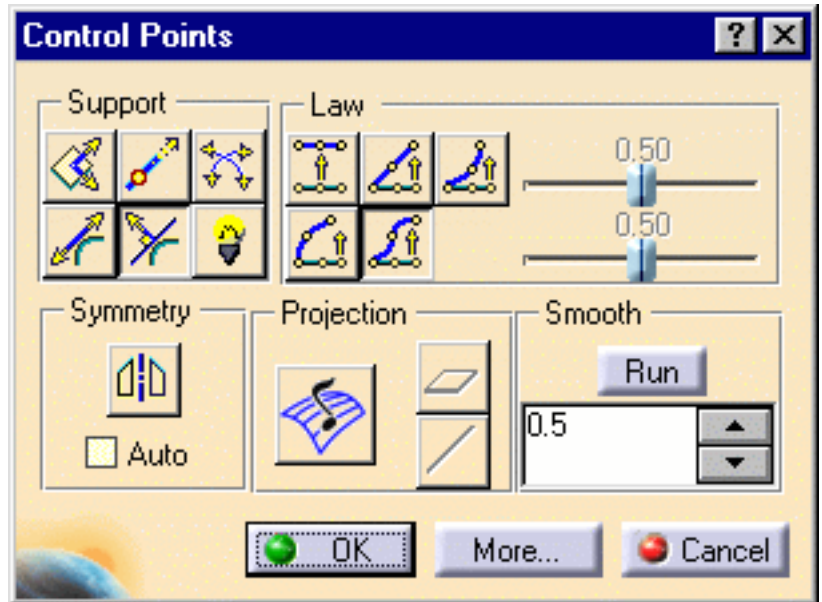

Here, choose the **Translation along the normal to the surface** and **Bell** law options.

In P1 mode, you can modify curves according to two laws only:

1. **Move selected points identically**
2. **Stretch selected points**

You cannot specify a Support.

3. Move the pointer onto one of the control points or mesh lines.

Manipulators automatically appear. They represent the directions in which you can perform a deformation.

4. Pull on the arrow matching the direction in which you want to deform the surface.

The surface follows the shape indicated by the mesh line or control point.

You can activate other support and law options and continue deforming the surface.

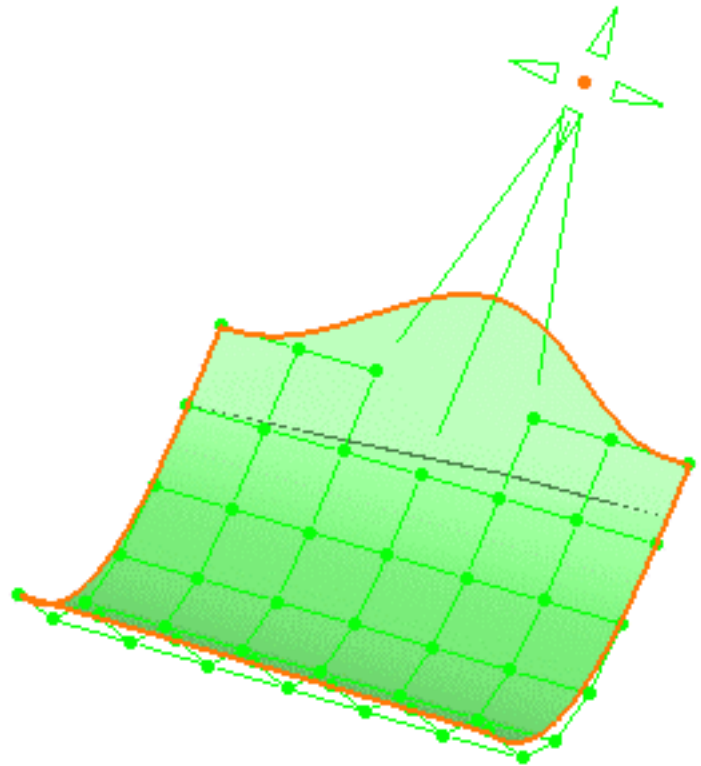



 By default all control points and mesh lines are selected. Click a specific point to deform the surface at this point only, or select a set of points using the Ctrl-key or Shift-key while clicking (multi-selection capabilities). The same applies to mesh lines.

5. Click **More...** in the Control Points dialog box.

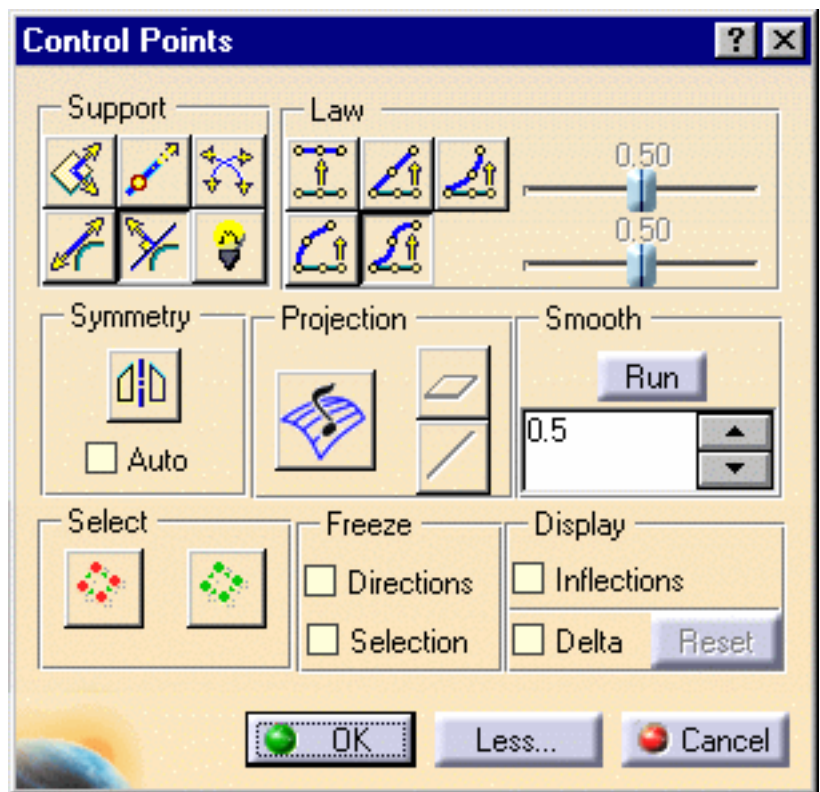
Further modification options are available:



- Selecting all control points  or de-selecting them all  at a time without clicking in the geometry.

- Using the **Harmonize** icon  you smoothly propagate the control points organization over the surface. It is especially useful when the boundary mesh lines have been constrained within a given plane for example.

- Freezing of directions or of the selected points (no other can be selected) and the modification can be performed only according to the allowed directions, i.e. some modifications may no longer be possible
- Dynamic display of the initial surface and of the delta as you pull on the control points.

The initial surface is represented by black solid lines (external edges) and dotted lines (inner isoparametric curves).

The maximum deviation is given for information.

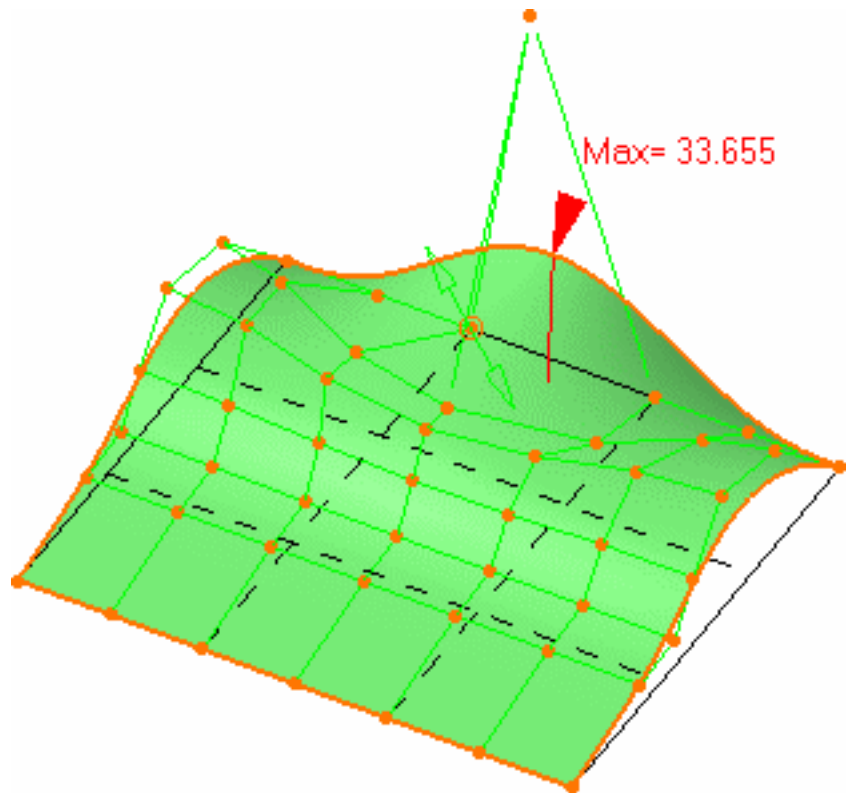

- Smoothing (refer to [Smoothing Surfaces](#)).



To display the order number and continuity type directly on the surface, use the



Dashboard's the **Continuity**  and **U, V**

Orders  icons (P2) or the specified settings (using the **Tools** -> **Options** -> **Shape** -> **FreeStyle** menu) (P1).

You can edit these by right-clicking the displayed text, and choosing a new order number, or continuity type.

Available continuity types are: Free, Point, Tangent and Curvature.

The continuity type affects how the surface border is evolving when the whole surface is modified.

A warning message can be displayed on the geometry when the chosen continuity and the chosen Support and Law do not comply.

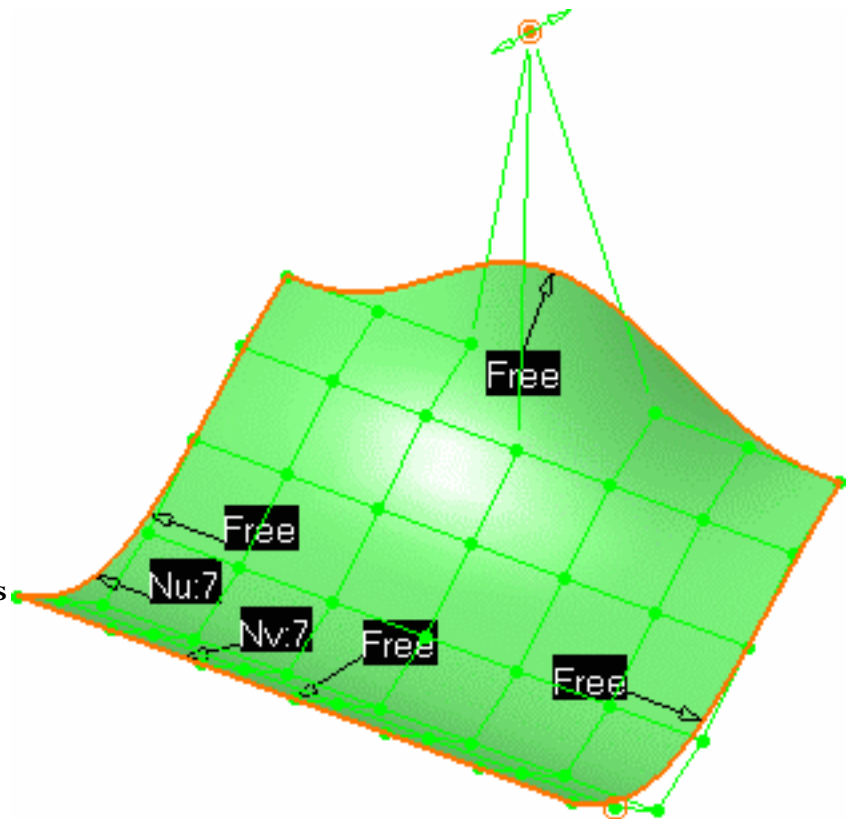

When selecting several surfaces, if a **continuity constraint** exists, the continuity tag displayed is set by default to the same continuity imposed by the constraint.

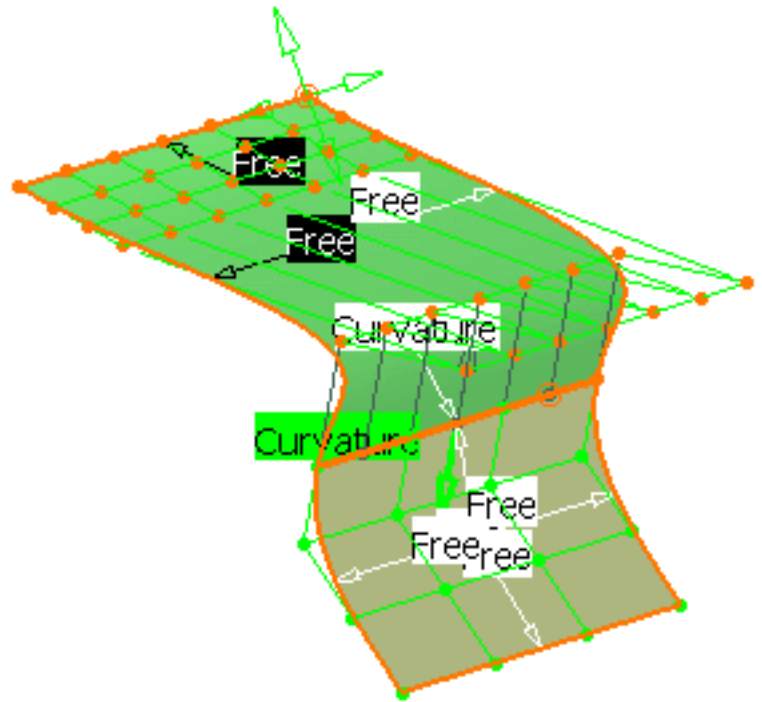

6. Click **OK** in the Control Points dialog box to validate the modifications.

The surface is modified.

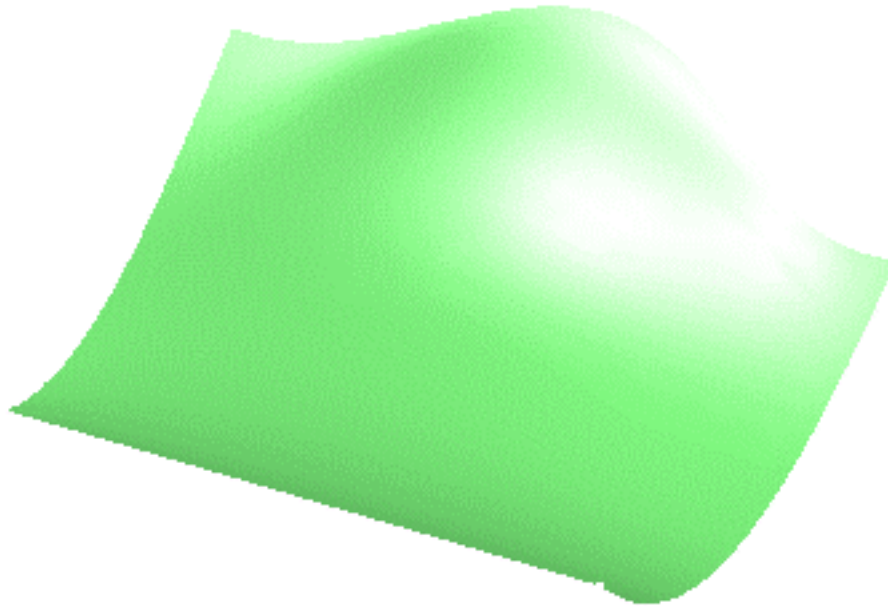

- Click any specific point, or mesh line to deform the surface at this element only. By default, selected points are displayed in red, and are green when deselected.

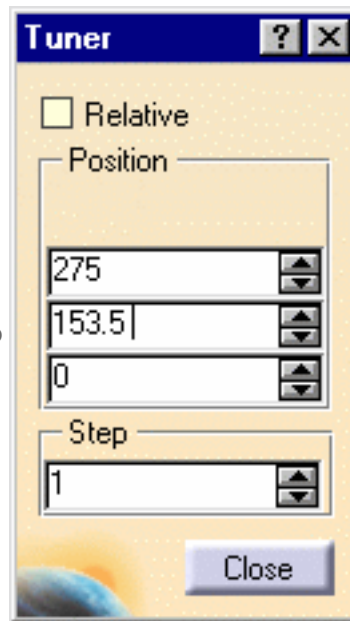

- Deformation can also be done using the **Tuner** dialog box displayed using the **Edit** contextual commands on control points or mesh lines. With this dialog box you can:
 - specify the exact position of the control point in space
 - define a step value by which a control point/mesh line moves (**Step** field).
 Once the value has been defined in the Tuner dialog box, press and hold the Shift key then click one of the manipulator's arrow to move the selected control point by the defined step value.



P2 Use the **Manipulators** (arrows) to modify the surface. In P2 mode, the following manipulation options are available:

- To fine-tune the manipulators, use the **attenuation** capability from the Dashboard. It lets you define the ratio between the mouse displacement and the actual displacement of the manipulator. This attenuation factor is saved in the CATIA settings.
- To snap a point onto external geometry, use the **auto detection** capability from the Dashboard.
- To perform a quick analysis of the mesh line inflection, choose the **Inflections** checkbox.
- You cannot move unselected points unless no point is selected.

P2 The following options are available in P2 mode only:

- Further modification options are available from the **More...** button of the Control Points dialog box:
 - Freezing of the selected points (no other can be selected) and of the Support option
 - Dynamic display of the initial curve and of the delta as you pull on the control points
 - Global selection/de-selection of control points using the **Select All**  and **De-Select All**  icons as shortcuts to select/release all control points of the selected elements,, without having to click the geometry.
- The **Freeze**, **Select All**, and **De-Select All** capabilities are also available on the contextual menu displayed when right-clicking a control point, and depending on the geometry, with the following capabilities:
 - Project on the plane
 - Project on the normal
 - Harmonize

Note that using the contextual menu on an element, when several element have been selected, applies the chosen capability on this element only, and not on the whole selection. However, if you apply the same capability from the Control Points dialog box, a given all the selected elements will be affected.

- The **Enable local plane detection**



icon allows you to find whether certain control points and mesh lines are aligned within a specific plane.

In this case, text are displayed along U and V indicating where the detection is active.

Right-click these texts to choose to retain, or not, the planar organization of control points in one direction.

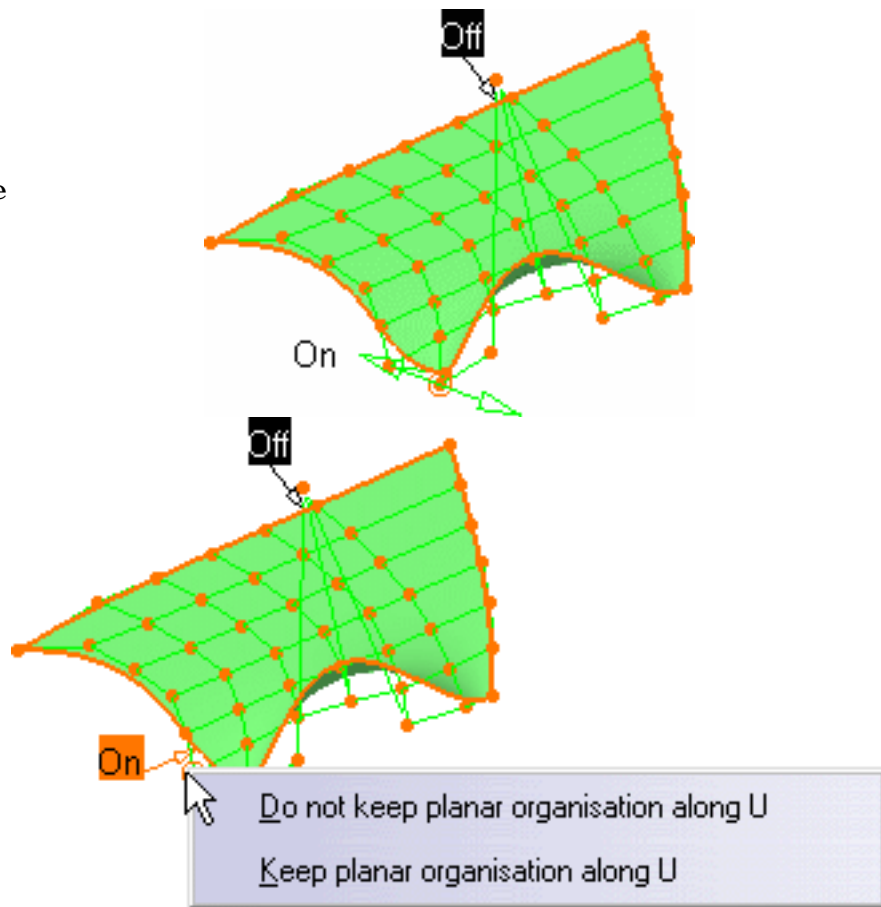

- **Projection:** Use this capability to project selected points according to the local 3D compass either in the current plane or according to the normal to the current plane:

1. Bring the 3D compass onto the surface
2. Select a mesh line or a subset or control points (you can also select all points but in this case the whole surface is projected according to the compass)

3. Click the **Projection** icon



- Select a mesh line and the compass plane, and click one of the following icons:

-  : the points are projected along the compass plane

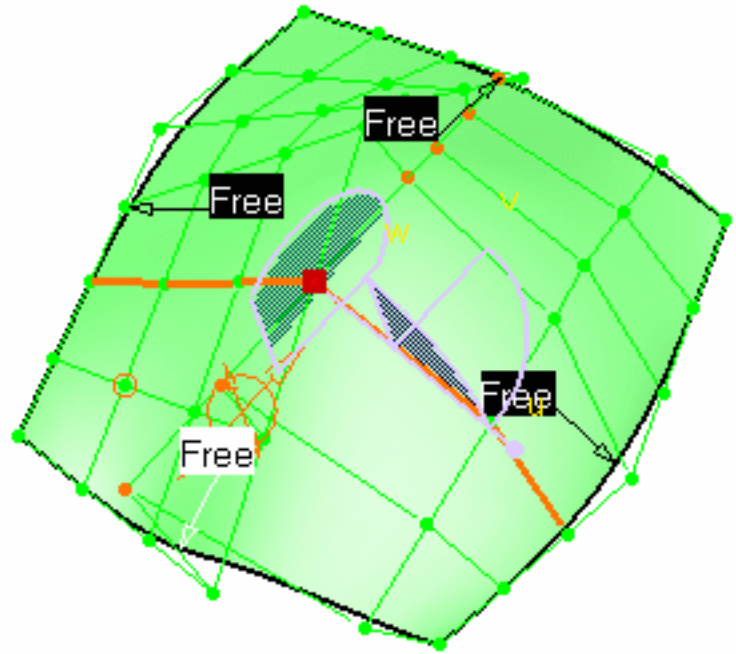

-  : the points are projected along the normal to the current plane.

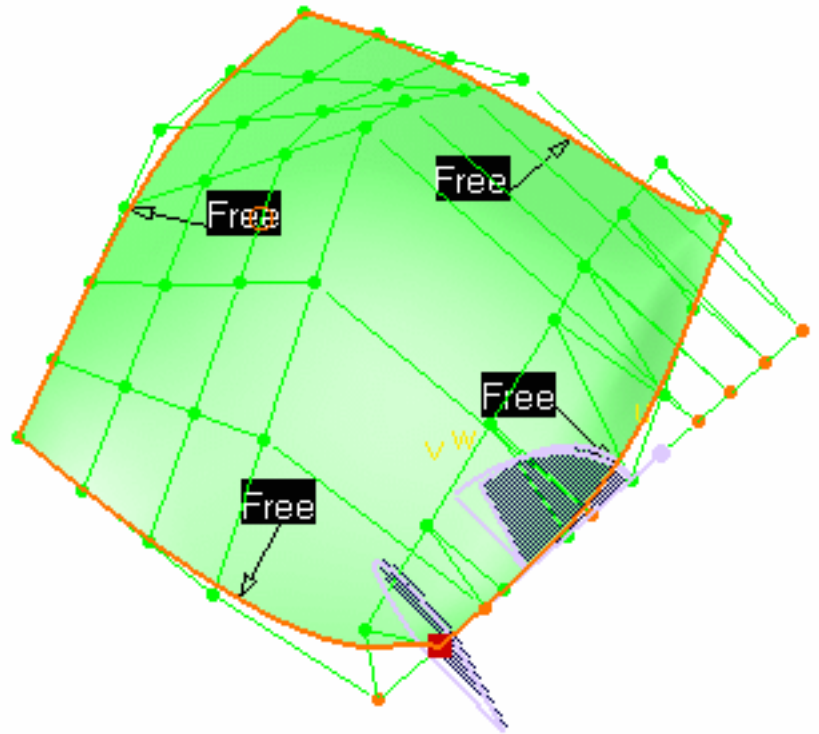

- Click the **Symmetry** icon to perform a symmetrical modification in relation to the current plane.

You can choose to use the current plane (by clicking OK in the dialog box), or to define a new plane as the current plane (by clicking Cancel first, then creating a new plane).

If you choose the current plane, you can modify its location using the manipulator, prior to confirming its use in the dialog box.

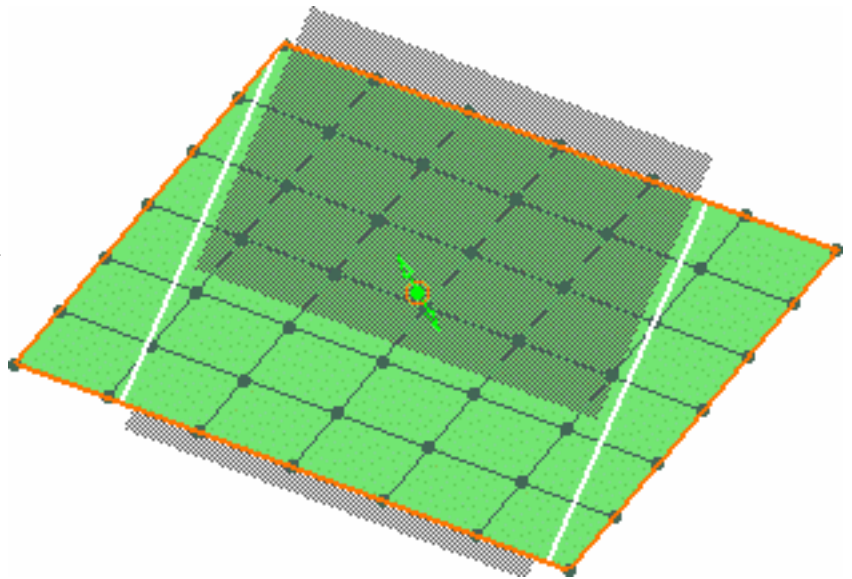

Use the F5 key to display the quick compass orientation toolbar and move the manipulators into a different plane of the compass. See [Managing the Compass](#).



- Use the F6 key to "quickly" orientate the compass :
 - along an axis, by selecting either:
 - an existing plane,
 - a mesh line, or
 - two control points
 - in a plane, by selecting either:
 - a local plane,
 - two mesh lines, or
 - three control points

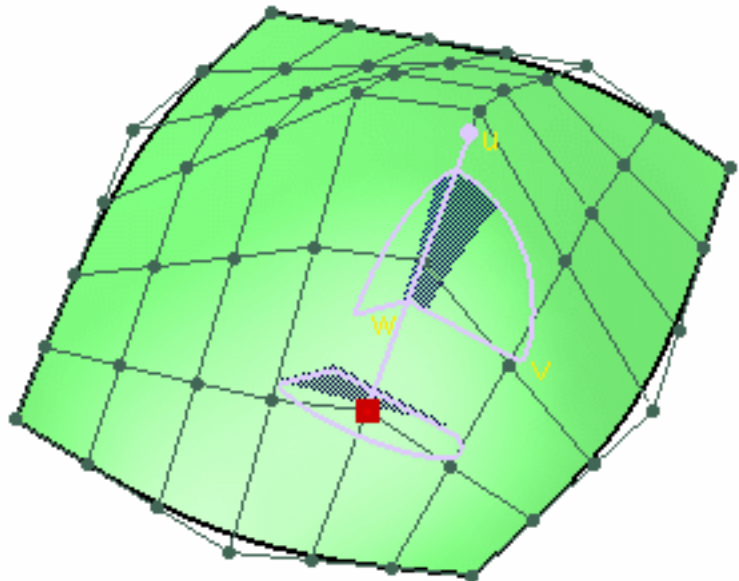

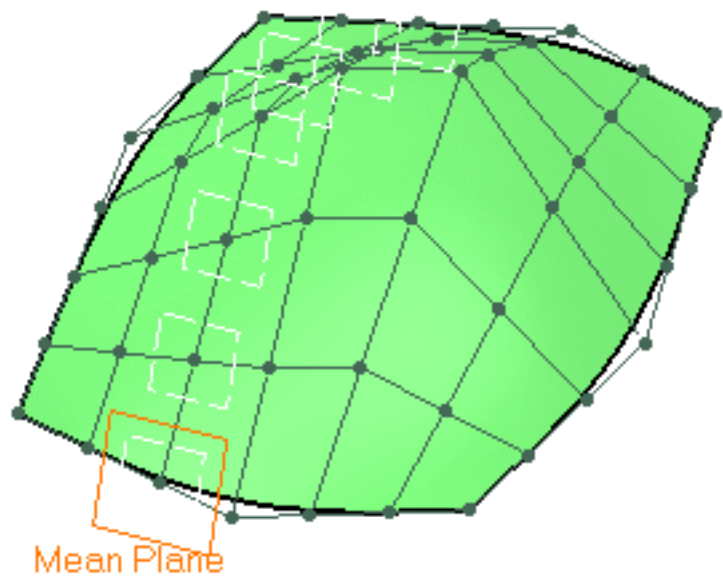

When you click this key, the control points are deactivated.

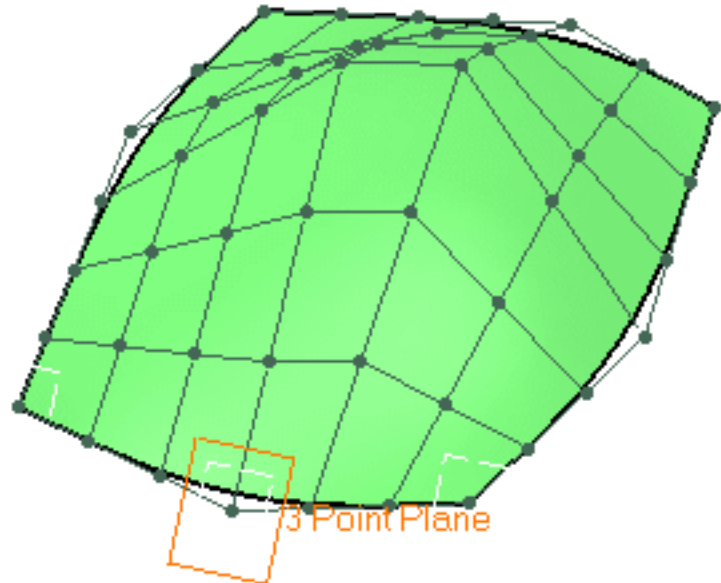

- Press both F6 and Control keys to create either a Mean Plane or a 3 Point Plane plane using control points in order to project them:
 - **Mean Plane**: select a mesh line

- **3 Point Plane:** select a point, the two extreme points are automatically defined



 Capabilities are available:

- from the [contextual menu](#) when right-clicking a control point,
- from the Dashboard,
- specified through the [FreeStyle Settings](#), are: [datum creation](#), [keep original](#), [auto detection](#), [attenuation](#), [continuities](#) and [orders](#)

 The **Harmonize** and **Local Detection** capabilities are only available with the FreeStyle Optimizer product.



Editing a Surface Boundary



This task explains how to modify a surface boundary as created in [Creating Free Form Curves on Surfaces](#) using its control points.



Open the [CurveOnSurface2.CATPart](#) document.



1. Select the surface boundary you wish to edit.

2. Click the **Control Points** icon .

Control points and lines are displayed along that boundary.

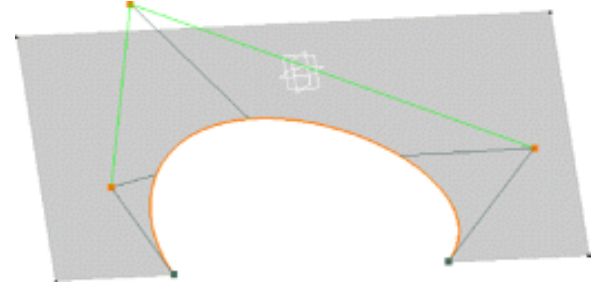

By default all control points are selected. Click a specific point to deform the boundary at this point only, or select a set of points using the Ctrl-key or Shift-key while clicking (multi-selection capabilities).

3. Modify the boundary pulling on its control points or the mesh line.

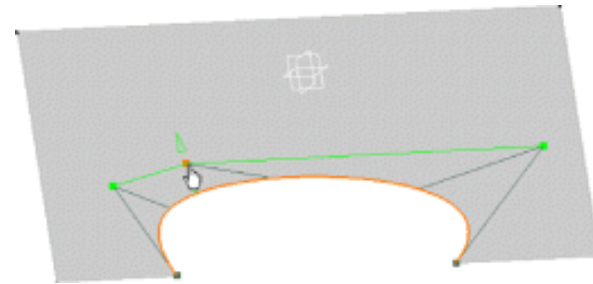

4. Click **OK** in the Control Points dialog box.

The boundary is modified.

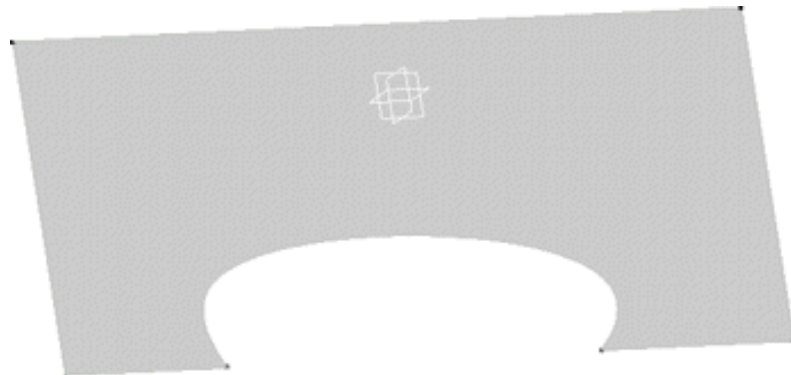



Only the boundary and its control points are modified. Any other boundary of the surface is not affected by these modifications.

See also [Editing Curves Using Control Points](#).



Capabilities are available:

from the [contextual menu](#) when right-clicking a control point,

from the Dashboard,

specified through the [FreeStyle Settings](#), are: [datum creation](#), [auto detection](#), [attenuation](#), [continuities](#) and [orders](#).



Extruding Surfaces

In this task you will learn how to create a surface by extrusion from a curve. This can be any type of curve, such as planar curves, 3D curves, surface edges, or curves on surfaces.

Open the [Extrude1.CATPart](#) document.

1. Click the **Extrude Surface** icon .

2. Select the curve from which you want to extrude a surface.



A manipulator is also displayed on the curve, oriented according to the 3D compass.

The Extrude Options dialog box is displayed:

- the **Normal to the curve** icon is the default icon and indicates the direction orthogonal to the curve plane
- the **Compass direction** icon enables you to manipulate elements using the 3D compass
- the **Length** field indicates the extrusion length
- the **Display corners** check button, allows the visualization of manipulators at the curve extremities

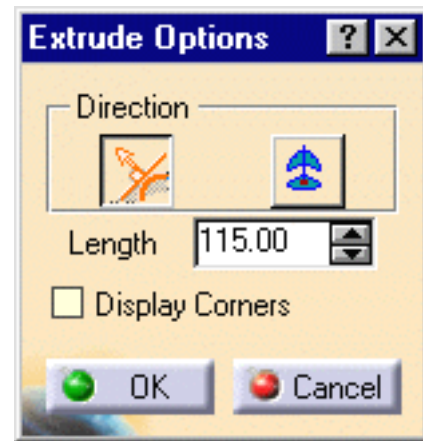

All the parameters entered in this dialog box are retained when the box is closed.

3. Click the manipulator on the curve and drag the pointer to extrude the surface in the given direction.

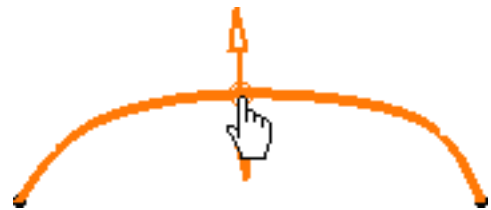

P2 Capabilities are available from the [contextual menu](#) when right-clicking the manipulator.

When you press the Ctrl-key while dragging the pointer, you can perform a symmetry.

The previewed extruded surface is dynamically displayed as you drag.

The segment number and the degree of the resulting surface are displayed:

- a full line indicates the segment limit
- a dashed line indicates the surface order

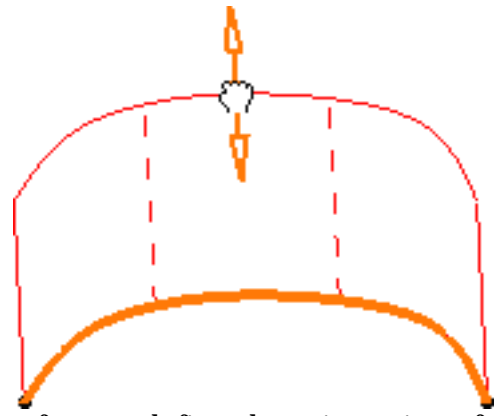

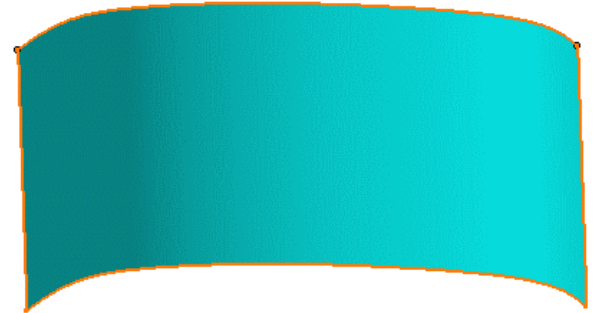

 You can move back and forth between the compass and the surface to define the orientation after having extruded the surface, as long as you have not performed the final step.

4. Click **OK** to create the surface.

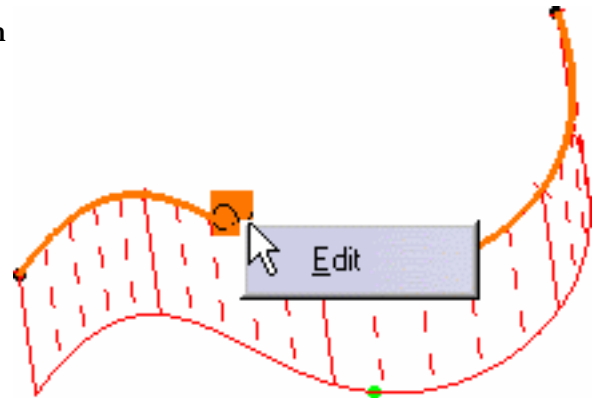

 • When the selected curve is not a 3D NUPBS (Non Uniform Polynomial B-Spline) curve, the **Cv** text is displayed. Right-click the **Cv** text and choose the **Edit** contextual menu to access the **Converter Wizard** allowing you to control the curve (order and segment number) on which the new surface is based.



- Check the **Furtive Display** icon  to visualize the initial curve control points as you are extruding it.

 • You can select the edges of the surface to extrude either by:

- clicking on them in the 3D geometry
- using the selection trap (all the edges will be selected)
- clicking the surface in the specification tree (all the edges will be selected)

• Available capabilities from the Dashboard are: [datum creation](#), [auto detection](#) (**Snap On Vertex** and **Snap On Cpt** options only), [attenuation](#), and [furtive display](#).



P2



This task explains how to create an offset surface, based on an existing surface.



Open the [Offset1.CATPart](#) document.



1. Select a surface, or a set of surfaces.

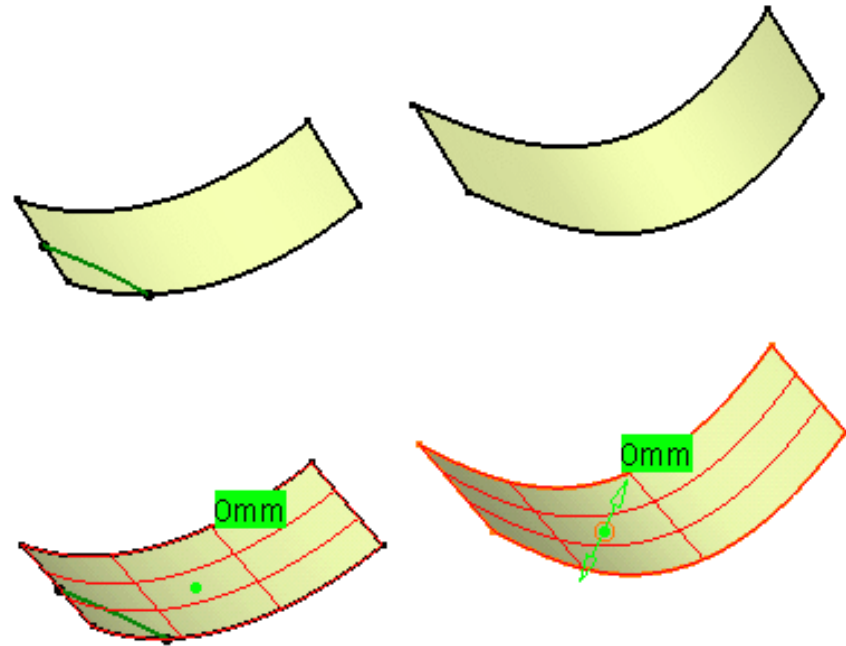

2. Click the **Offset** icon .

The offset surface is automatically visualized as a meshed surface.

3. Choose the options you wish from the Offset Surface dialog box:

- the offset **type**: a **simple** offset creates a surface which points are all at the same distance from the initial surface, whereas a **variable** offset lets you set the offset distance at each corner point of the surface.
- the **limits**, that is constraints to be taken into account when computing the offset surface. You can specify whether it should comply with a given **tolerance**, or it should have a maximum **order** in U and V. The resulting surface will lie within these constraints.

- **Display**, that is the elements to be displayed on the geometry.

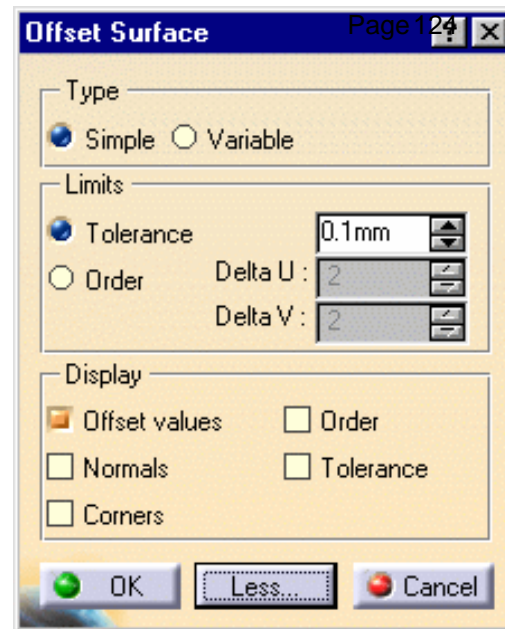

i When you click the **More...** button: the type of information to be displayed on the offset surface before it actually is created. This information is useful to let you fine-tune the offset specifications.

- **Offset values:** the distance between any point of the initial surface and the resulting surface.
- **Normals:** identifying the direction of the initial surface. Click on the arrow to invert the offset.
- **Order:** the order value in U and V
- **Tolerance:** the exact tolerance deviation
- **Corners:** displays or hides the manipulators at the four corner points (only in **Simple** mode) to make **Snap on Geometry** possible. When you are in **Variable** mode, the **Corners** option is checked: if you pull the central manipulator, all manipulators are temporarily linked to each other, basically they have the same behavior as regular control points.

4. By default the Edit dialog box is displayed. If not, right-click the offset value box on the surface to display it, and enter the offset value.

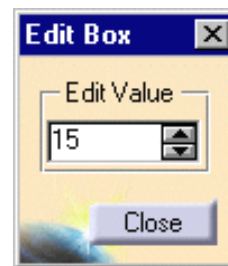

5. Click **Close** to validate the offset value.

You can also move the pointer over one of the corner points, and directly pull on the displayed manipulators. The offset value is dynamically modified.

6. Click OK in the Offset Surface dialog box to create the offset surface.

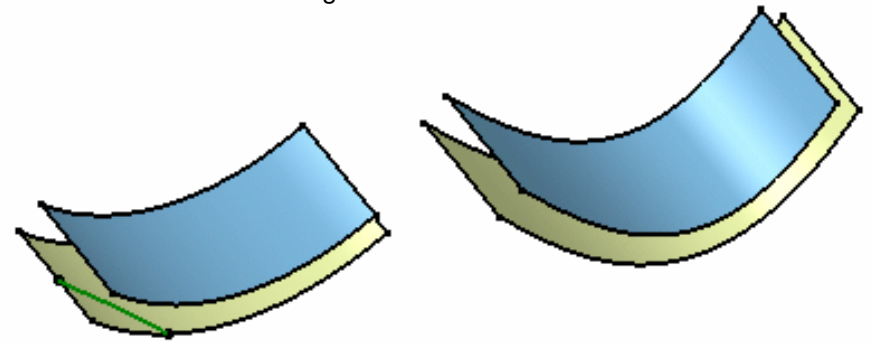

You can also select a point either in the 3D or in the specification tree to impose the offset value. The value will be set as well as the distance corresponding to the normal projection of the input point onto the surfaces.

Use this point to set the offset value

63.385mm

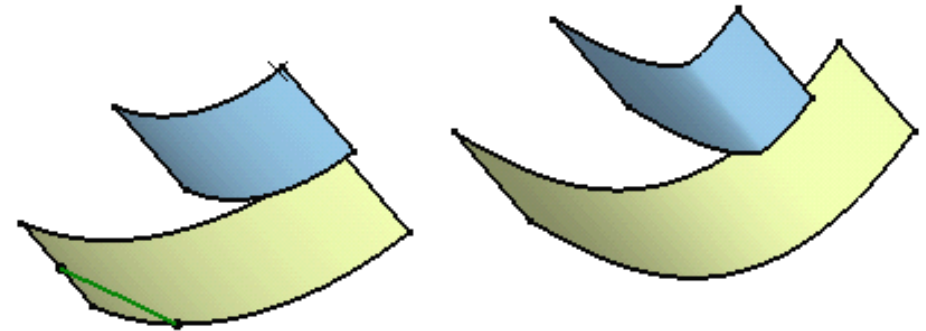
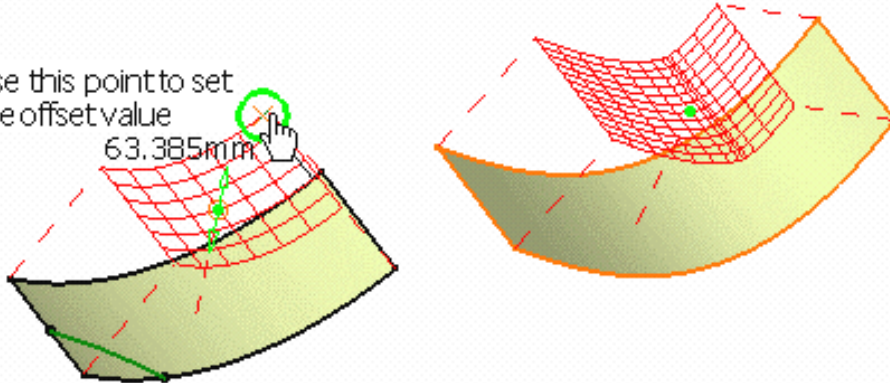

 If no projection is possible, no selection is possible and a message error is issued.

You can also create variable offset:

- Click **Variable** in the Offset Surface dialog box.
- You can modify the delta in order. This means that the maximum order number of the offset surface will not exceed the initial surface order number plus the indicated value.

Offset values are displayed at each corner of the surface.

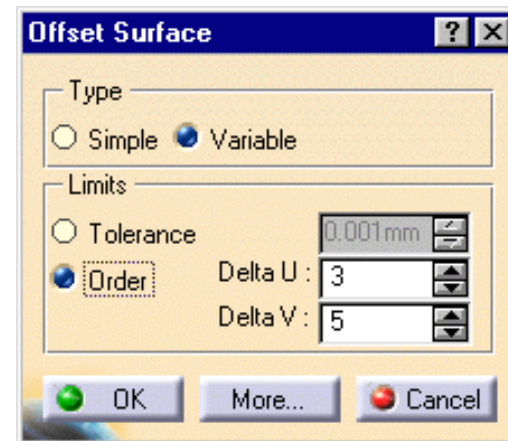

15mm

15mm

15mm

15mm

15mm

15mm

40mm

15mm

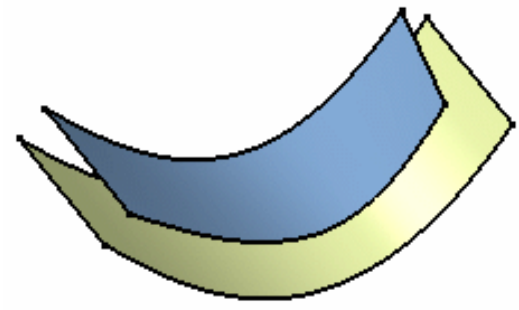

- d. Right-click another offset value and using the Edit dialog box, change this value.
Here we modified two values from 15 to 40.

- e. Click **OK** in the Offset Surface dialog box.
The offset surface is created.



- The same method applies when offsetting a set of surfaces. As all surfaces may not present the same orientation, check the **Normals** option from the Offset Surface dialog box and right-click arrows: a contextual menu displays on each arrow and enables you to **Reverse** or **Adjust all**.

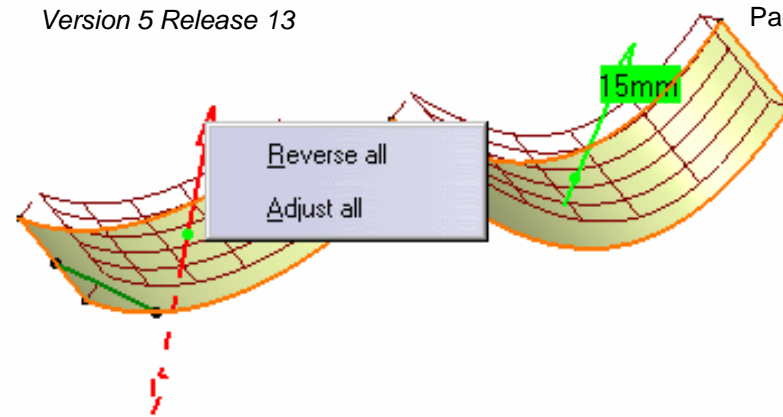

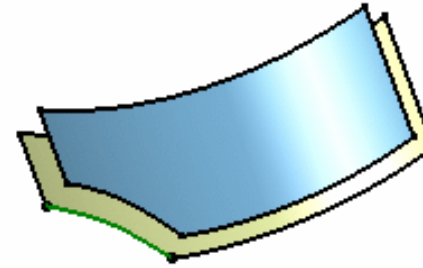
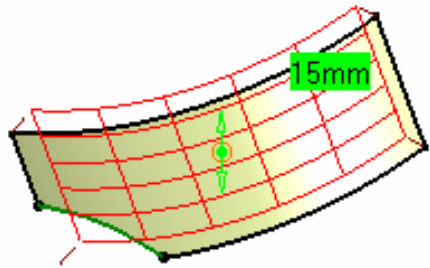

- If the offset is performed on a surface relimited using the break command, the result is a relimited surface, even though the pre-visualization presents the initial (not relimited surface):

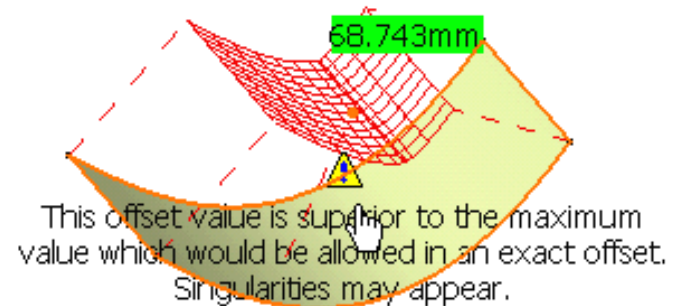

- If the offset value is superior to the maximum value, an error message is issued. Nevertheless, you can create the offset.



 Multi-selection of surfaces is available.

 Capabilities are available from:

- the [contextual menu](#) when right-clicking the manipulator
- the Dashboard: [datum creation](#), [keep original](#), [auto detection](#), [attenuation](#), and [furtive display](#).



Extrapolating Surfaces

P2



In this task you will learn how to extrapolate a surface, that is add an extra surface to the initial one while taking continuity constraints into account.



Open the [Extend1.CATPart](#) document.



1. Select a surface boundary.

A manipulator is displayed.

2. Click the **Styling Extrapolate** icon .

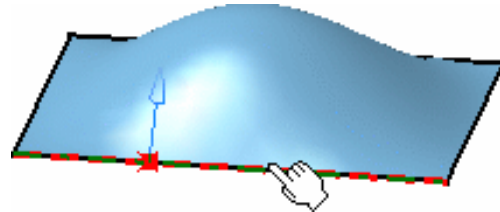

The Extrapolation dialog box is displayed. Two options are available:

- **Tangential:** the surface is extended along the tangent to the surface on the selected boundary, and of a given distance (G1 continuity).
- **Curvature:** the surface is extrapolated by the specified value, complying with the surface curvature (G2 continuity). No manipulator is displayed.

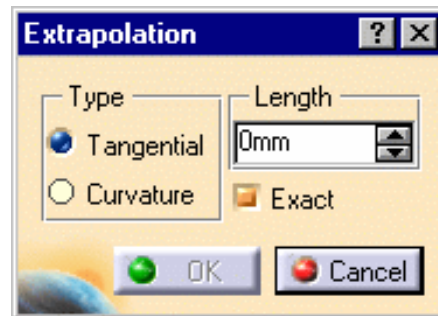

3. Click **Tangential** and pull on the manipulator till you reach 60 in the **Length** field of the Extrapolation dialog box.

The extrapolation is pre-visualized and dynamically evolves as you modify the extension length.

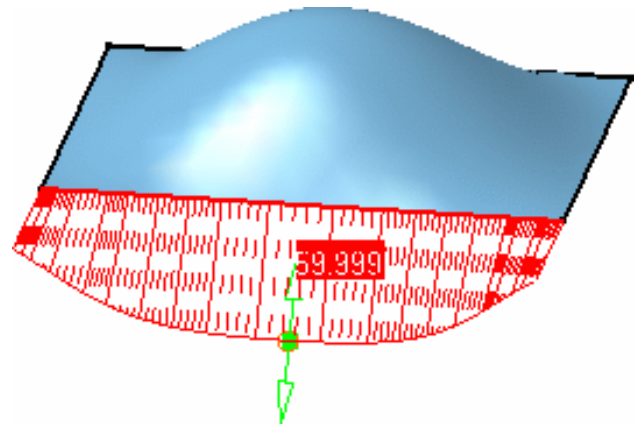

You could just as well enter the value directly in the **Length** field.

4. Click **OK**.

The extrapolated surface is created.

Here are two views of the extrapolated surface, illustrating the tangency constraint on the selected edge.

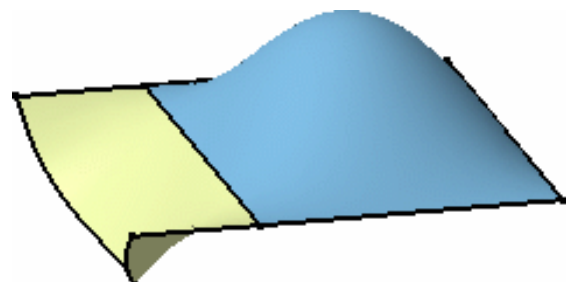
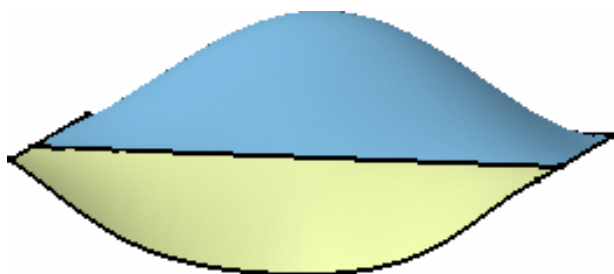

Similarly, if an edge is selected, and the **Curvature** option active, the surface is extrapolated according its initial curvature:



With Curvature option

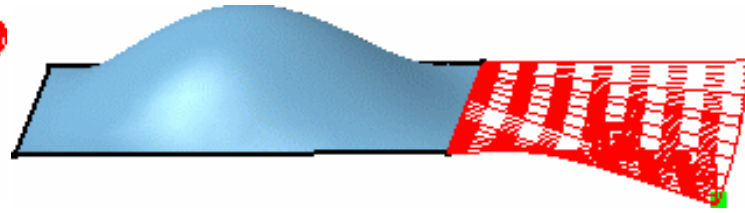

With Tangential option



- To extrapolate a set of surface boundaries, you need to select these, using the Ctrl-key, before clicking the **Extrapolate** icon .
- The curvilinear length between the middle of the selected original surface edge and the middle of the extended surface is displayed.
- Whether in **Tangential** or **Curvature** mode, check the **Exact** option if you want to switch to the exact mode. The figures below show a surface extrapolated when **Exact** mode is checked and unchecked.
 - when the **Exact** option is checked, computation is analytical and the resulting surface presents the same degree as the initial surface. Since you chose this constraint, there may be no possible result in some cases.
 - when the **Exact** option is not checked, the extrapolation is computed according to the geometric mode.

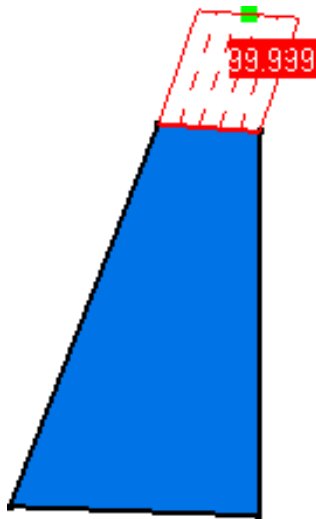

Exact mode not checked

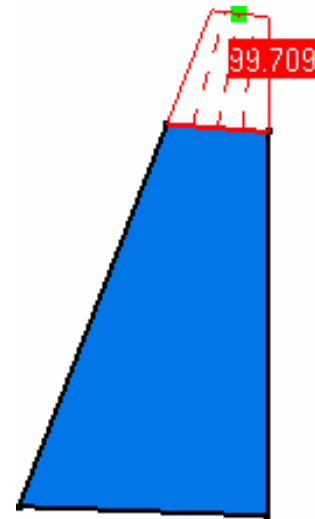

Exact mode checked



- Using the Tangential option, capabilities are available from the [contextual menu](#) when right-clicking a control point.
- Only the [datum creation](#) capability is available from the Dashboard.



 This task explains how to create a blend surface between two pre-existing surfaces.

 Open the [BlendSurface1.CATPart](#) document.

 1. Click the **FreeStyle Blend Surface** icon .

The blend surface is previewed, and the Blend Surface dialog box is displayed.

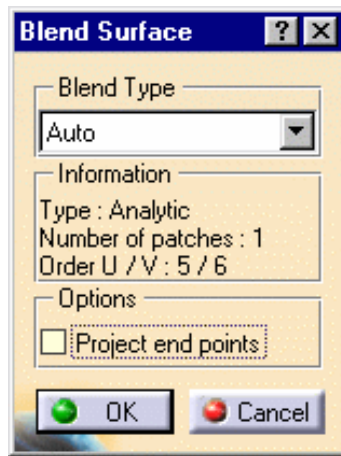

 Three modes are available to create blend surfaces:

- **Analytic**: when the selected surface edges are isoparametric curves, the blend surface is computed in exact mode, based on the selected surfaces' control points. Moreover, the blend surface presents a point, tangency and curvature continuity with the initial surfaces. When in analytic mode and **Tangency** continuity, depending on the geometry configuration, twisted surfaces may be generated. In this case, it is best to use the **Proportional** continuity, that allows the creation of the blended surface while taking the tangency continuity into account, then check the continuities if needed.
- **Approximated**: regardless of the type of the selected surface edges, the blend surface is created according to an approximation between the initial surfaces.
- **Auto**: the system optimizes the computation mode, trying first to create the blend surface in Analytic mode, then, if not possible, in Approximated mode.

 When in P1 mode, only the **Auto** mode is available.

Information on the blend surface is displayed in the Blend Surface dialog box:

- the blending type used (especially useful when working in **Auto** mode)
- the number of patches making up the surface
- the order of the blend surface along U and V

2. Move the pointer over one of the surfaces and click one of its edges.

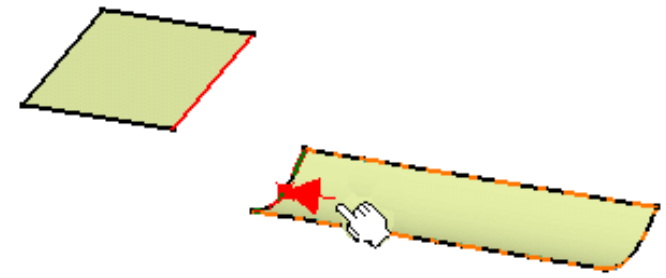
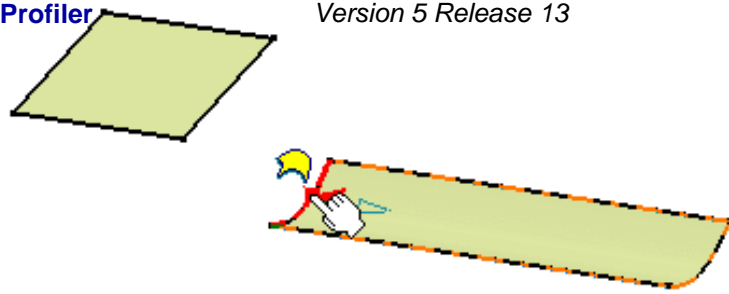

You can select edges either from outside the surface (i.e. the arrow points towards the surface) or from within the surface (i.e. the pointer is over the surface when selecting the edge)

3. Click the edge of the second surface.

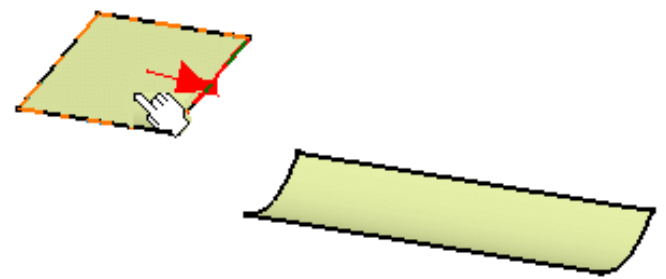
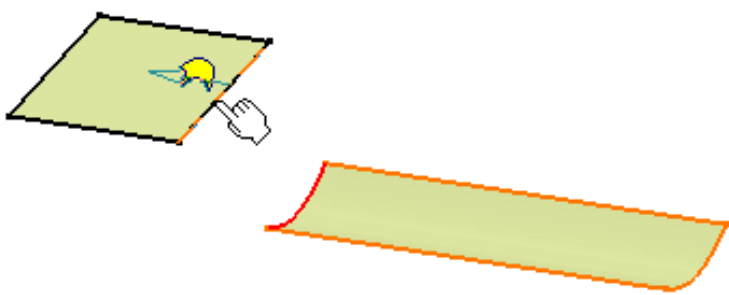

The  tag informs you that there is only one surface to be selected.

Please refer to [Selecting a Support](#) for further information.

The blend surface is previewed.

- Right-click a limit point and choose one of the options from the [contextual menu](#).



- From the Dashboard, click on the **Continuity** icon  and right-click onto the identifier to edit the continuity constraint on the boundary of the blend surface and the selected surfaces, using the contextual menu.

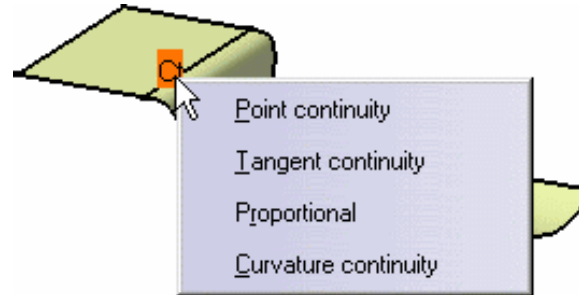

Change both continuities to Tangent.

Available continuity types are: **Point**, **Tangent**, **Proportional** and **Curvature**.

- **Point**: the surfaces share each point of their common boundary, i.e. there is no gap between the surfaces
- **Tangent**: the surfaces share a common tangent plane (i.e. normal) at each point of their connection
- **Proportional**: similarly to the **Tangent** option, surfaces share a common tangent plane (i.e. normal) at each point of their connection, but the longitudinal variation from one point to the other is smoother, as the system automatically re-distributes the control point location on the blend surface. This mode is automatically set for both limits of the blend surface.
- **Curvature**: the surfaces share a common curvature and tangent plane at each point of their connection

P2

- Still from the dashboard, click the **Tensions** icon .

The tension values are displayed on the element along with a green segment representing the direction and limits of the blend surface tangent at its middle-points. You can modify the tension values by sliding the green triangle along the direction.

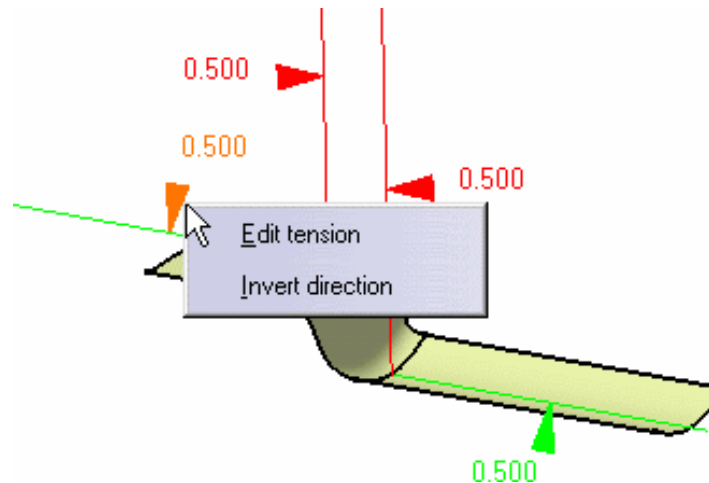

7. Right-click on the top boundary tension identifier and choose **Invert direction**.

- In the case of an approximated blend type, you can modify the local tangent and curvature parameters. You can modify the tangency between the free edges and the edges of the support surface by clicking either **Tangent** or **Normal**.
- If you move the coupling points onto the edges of the support surface, only the normal direction is kept for the free edges of the blend

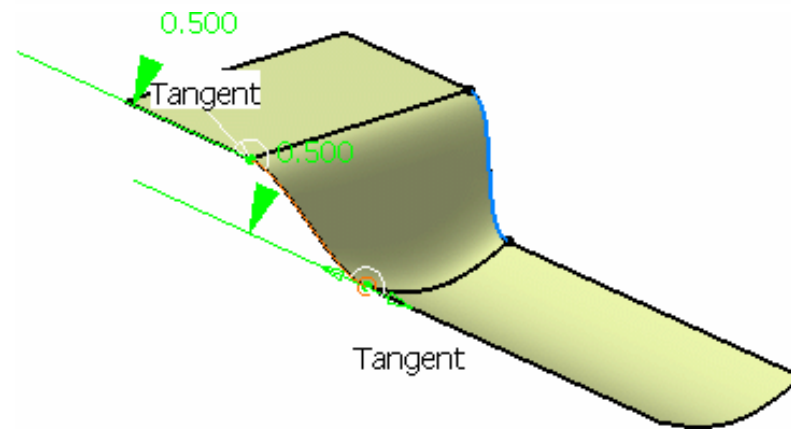
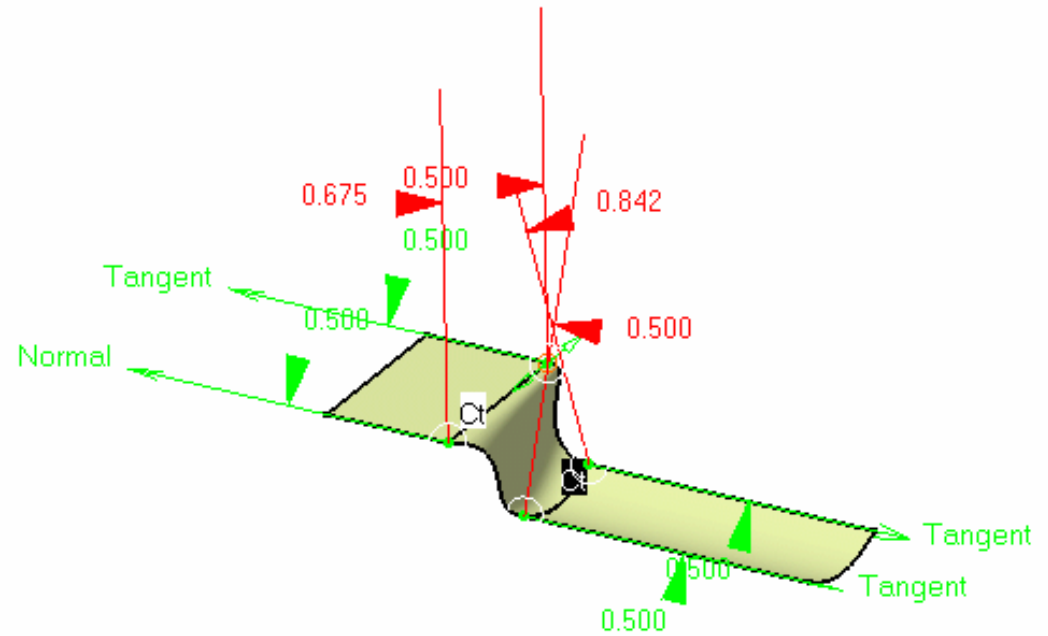
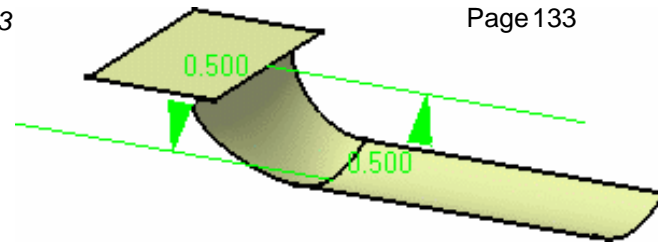

Tensions are now homogenized between blend surfaces and blend curves, so that the borders of a blend surface have the same shape as the blend curves, providing they are built on the same supports.



This homogenization is only possible with an approximated blend surface.

8. Invert the top tension to come back to the initial surface, click



to deactivate the tensions, and click the **Contact Points**



icon

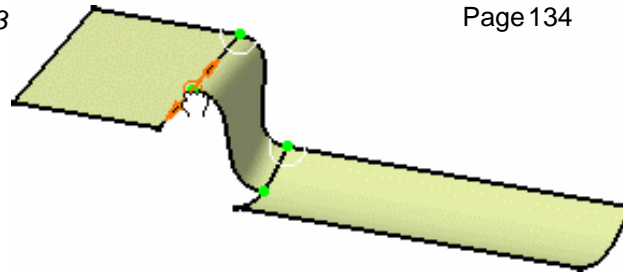

Manipulators are displayed on the connection, allowing you to interactively define the blend limits by simply sliding them along the boundaries.

You can edit the contact points by right-clicking any of them to display the contextual menu and choosing the **Edit** item. The Tuner dialog box opens to let you key in a new value, in percentage of the total boundary.

If you click on the **Furtive Display**



icon  from the dashboard, control



points of the created element are

displayed.

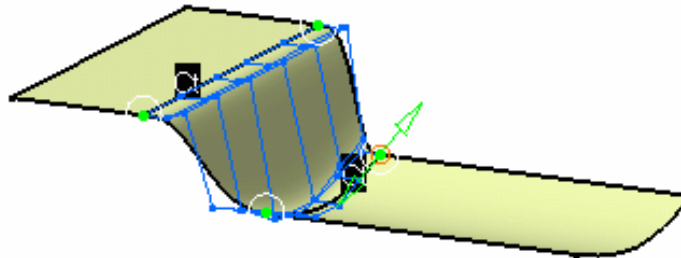

9. Click OK in the Blend Surface dialog box to create the blend surface.

It remains selected, thus allowing to immediately analyze its connection to the other surfaces, for example.

The **Project end points** option allows linear projection of the smaller edge, if selected first, onto the other surface as shown to the left. To the right is the resulting blend without the **Project end points** option.

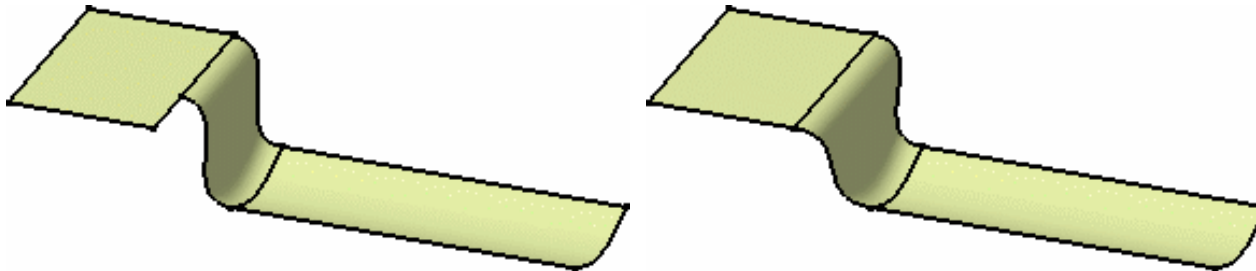

Should there be a twist between the two surfaces, the blend surface is not created. Modifying the continuity may enable the blend creation.



Available capabilities from the Dashboard, and/or specified through the [FreeStyle Settings](#), are: [datum creation](#), [continuity](#), [contact points](#), [tensions](#), and [furtive display](#).



Creating an ACA Fillet



This task explains how to create an ACA fillet surface between two given surfaces.



Open the [ACAFillet.CATPart](#) document

1. Click the **Fillet** icon .

The Fillet dialog box is displayed.

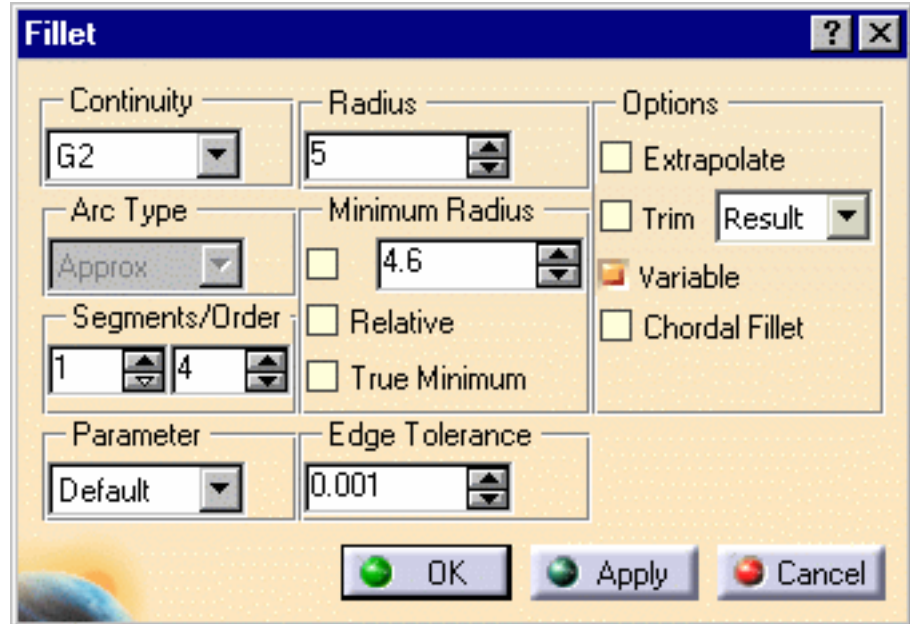

2. Select the two edges where you want to create the fillet.
Two vectors and the continuity symbol appears (G2).

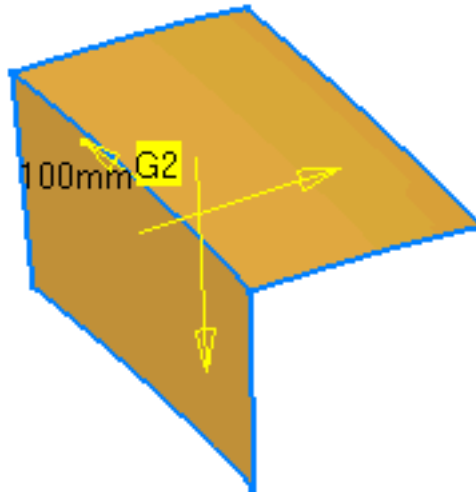

3. Click **Apply** create the fillet.

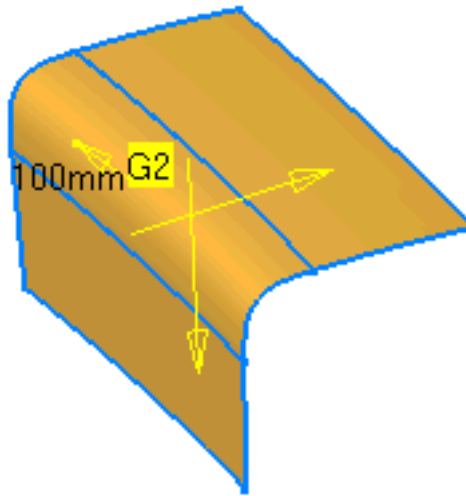

4. When you activate minimum radius, a new vector appears enabling you to change the minimum radius in the middle of the fillet.

Alternatively, you can change the value using the up and down arrows in the Minimum Radius .

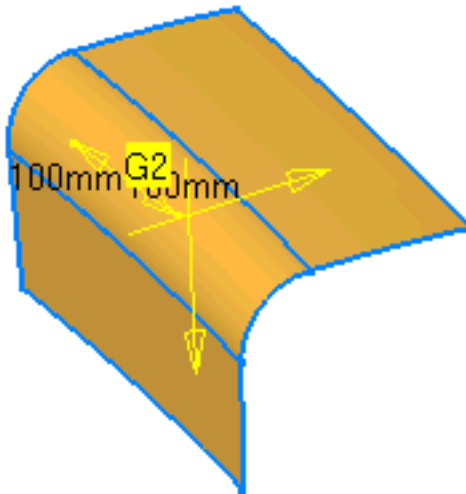

The dialog box displays several options helping you to create the fillet:

- **Continuity** : Quality of continuity between fillet and reference surfaces. (G0 - G2)
- **Segments/Order** : Order of the fillet surface in direction of common edges
- **Radius** : Fillet radius
- **Minimum Radius** : Minimum radius in the middle of the fillet (optional)
 - **Relative** : Minimum radius is relative the minimal variable radius
 - **True Minimum** (only for G2) : Minimum radius is controlled. Trace curves will be computed in dependency of G2
- **Arc Type** (only for G1)
 - **Blend** : Creates a blend surface between the traces
 - **Approx** : Creates a circular bezier approximation
 - **Exact** : Creates a rational surface with true circular sections
- **Parameter** : Different options for parameterization of the result and fillet surface

- **Default** : Internal computed best filling parameterization
 - **Patch 1** : Parameterization is taken from the 1st patch
 - **Patch 2** : Parameterization is taken from the 2nd patch
 - **Average** : Average of parameterization from patch 1 and patch 2 is taken
 - **Blend** : Traces have parameterization of their correspondent surface
- **Edge Tolerance** : Tolerance for common edge detection. If no common edge is detected, variable fillet is not possible
 - **Options**
 - **Extrapolate** - Fillet surface also on extrapolation of reference surfaces
 - **Trim** - Face trimming of reference surfaces on fillet boundaries
 - **Variable** - Activates variable radius (only possible if edge tolerance is met)
 - **Feature Modeling** - Enables shape modifications of the fillet
 - **Chordal Fillet** (only for Variable off) - Instead of the radius, the chord length of the cross-sections defines the fillet



For further information, please refer to the *CATIA Automotive Class A* documentation.



Creating Filling Surfaces

In this task you will learn how to fill the space between three surfaces.

You can fill the space between three or more elements (up to nine). The elements can be either curves or any surface type element. These elements must be contiguous in only one point.

Open the [Fill1.CATPart](#) document.

1. Click the **Fill** icon .

P2 The **Fill Options** dialog box is displayed allowing you to define the **Deformation direction** (P2 only).

This will let you deform the resulting filling surfaces according to the **Compass Direction** or **Normal to the Surface Direction**.



2. Select the boundary of the first surface.

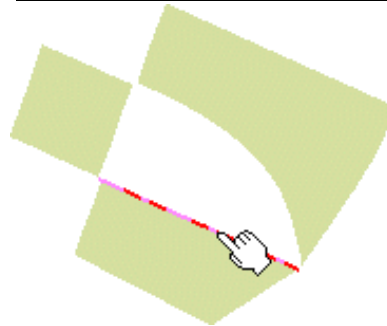

3. Select the boundary of an adjacent surface.

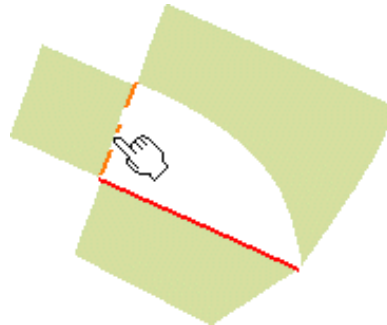

4. Select the boundary of all other surfaces, still going from one surface to its direct neighbor.

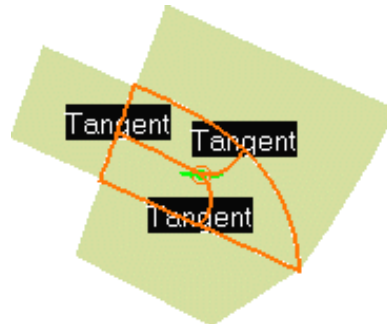

Once you have selected the last boundary contiguous to the first selected surface, the filling surfaces are created.

If you checked the **Continuities** option from the Dashboard (P2) or the [FreeStyle Settings](#), the corresponding information is displayed on the surfaces:

5. Right-click the displayed text to edit the continuities.

You can choose from Point or Tangent continuity, depending on the geometry configuration. Tangent continuity is available only when filling a closed contour.

- P2** 6. Use the manipulators at the center point (P2 only) to deform the generated surfaces. The deformation depends on the chosen icon: **Normal to the Surface Direction**, or according to the **Compass Direction**.

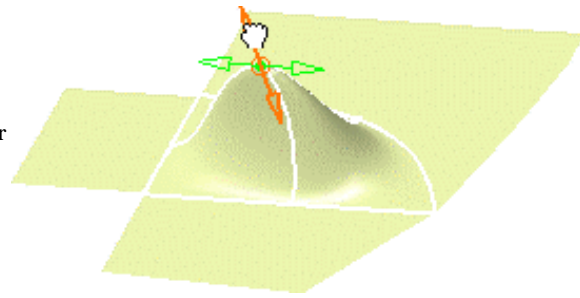

While deforming, set continuities are retained.

Capabilities are available from the [contextual menu](#) when right-clicking the manipulator.

- i** The center point is not displayed if only one filling surface is created or when four filling surfaces are generated.

7. Click OK to create the filling surfaces.

- 💡**
- You can use the graphic properties to modify the colors of the filling surfaces to better identify them. To this end, select each surface either in the geometry or in the specification tree, and call the Properties dialog box; **Graphic** tab, and modify the **Fill** color.
 - You can fill the space between different types of elements. For example, select a curve, two surfaces supporting a blend surface and the blend itself. In this case, the intersections between the selected edges on the surfaces and the blend limits are automatically detected, and the filling surface created accordingly. Furthermore, only the Point continuity is available on the curve.

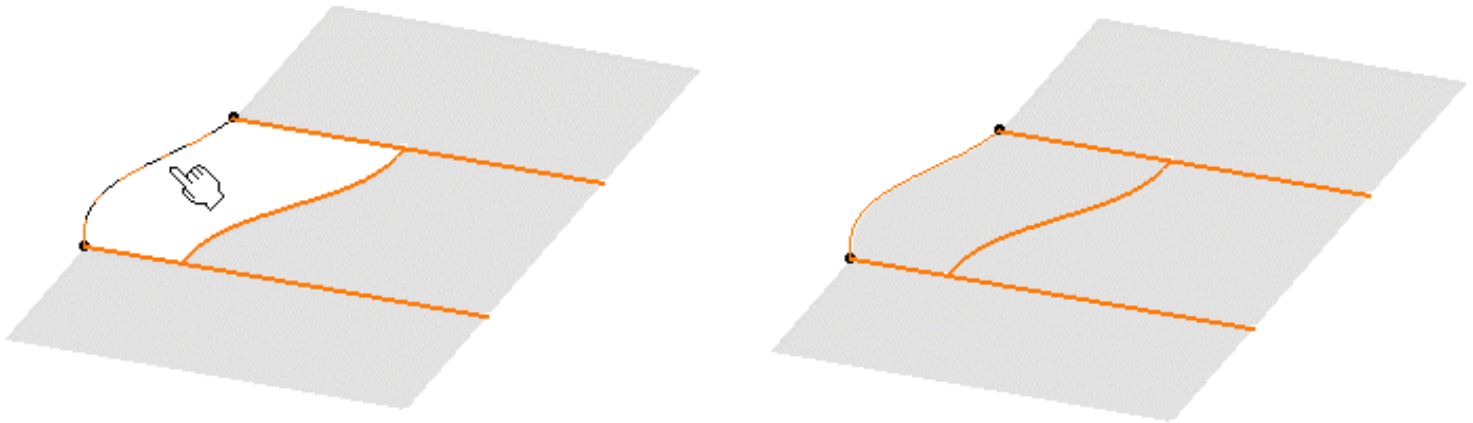

Similarly, you can fill three or more open-sided contours when composed of surface boundaries only. A temporary blend curve is created to close the contour when you click **Apply**, allowing the system to compute the filling surfaces.

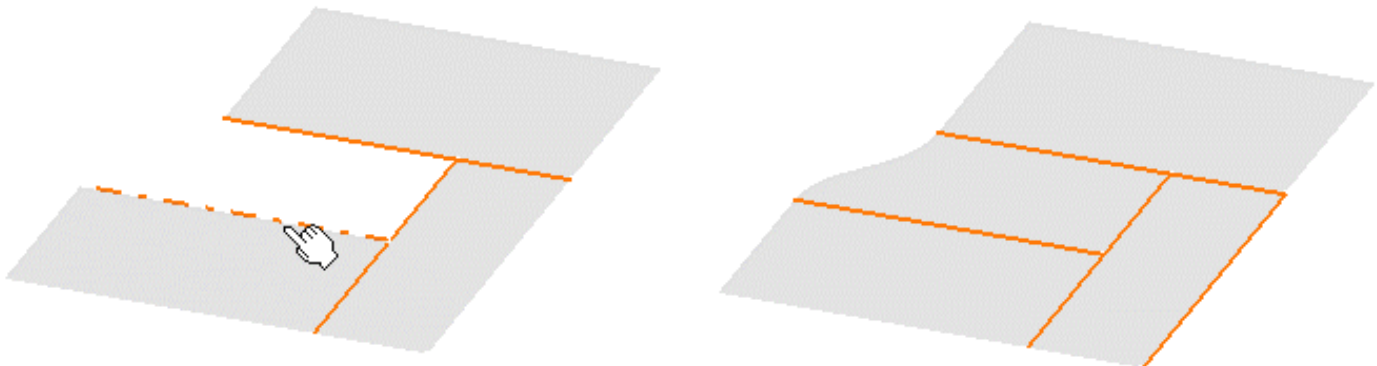

You can also fill the space between two intersecting curves, or surfaces, forming an open angle. To do this, simply select these curves or surface boundaries, then click **Apply** in the Fill Option dialog box. The system automatically creates temporary curves matching the selected ones to close a contour before filling it.

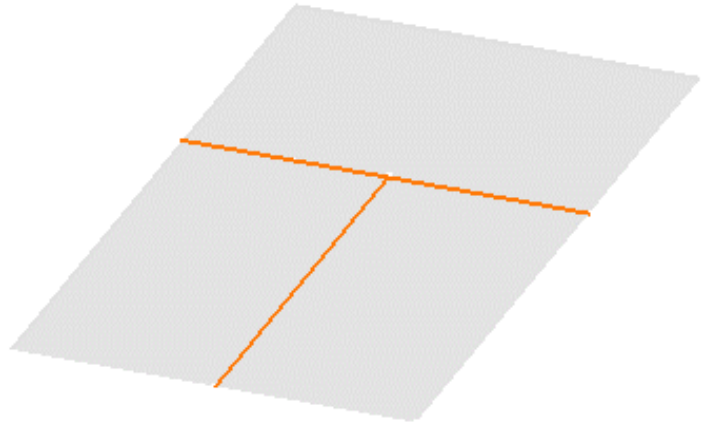
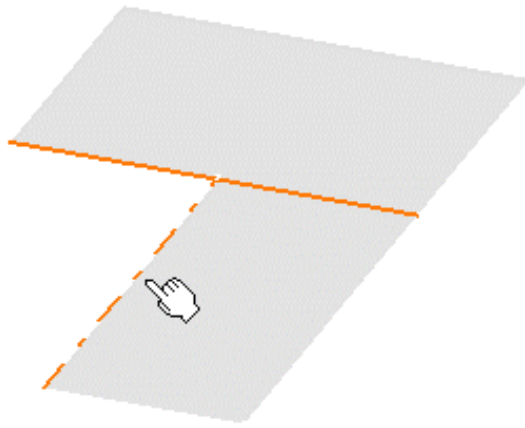

- Make sure you select contiguous surface boundaries, especially when filling the space between more than three surfaces. Do not select boundaries randomly.
- If four edges have been selected, a mono-patch surface is created. However, if three, five or more edges (up to nine) have been selected, as many surfaces are created as selected edges.
- A gap between two selected boundaries, that exceeds the set tolerance (0.01 mm) is identified for correction purposes. A text is displayed, indicating the gap value, and the fill cannot be performed. If the gap is smaller than 0.01 mm, the fill is automatically performed complying with the tolerance all around the selected edges.



- Available capabilities from the Dashboard, and/or specified through the [FreeStyle Settings](#), are: [datum creation](#), [temporary analysis](#), [auto detection](#) (Snap On Edge option only), [attenuation](#), [continuities](#) and [furtive display](#).



Creating Associative Filling Surfaces



In this task you will learn how to fill the space between three or more surfaces.

You can fill the space between three or more elements (up to nine). The elements can be either curves (only one intersection between the curves is allowed) or any surface type element. These elements must be contiguous in only one point.



Open the [Fill2.CATPart](#) document.



1. Click the **FreeStyle Fill** icon .

The Fill dialog box displays:

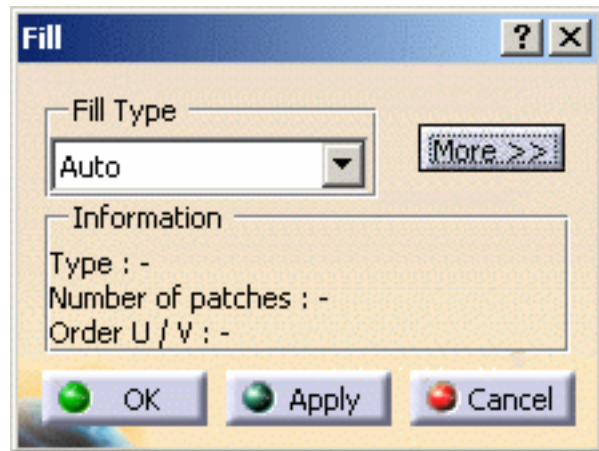

2. Choose the **Fill Type**:

- **Analytic**: one or more filling surfaces will be created, depending on the number of elements.
 - If there are four elements, one surface will be created with supporting edges as borders
 - If there are three, five or more elements, two cases can occur:
 1. several surfaces (four-side surfaces) with a barycenter point will be created: there will be as many surfaces as there are continuity changes:

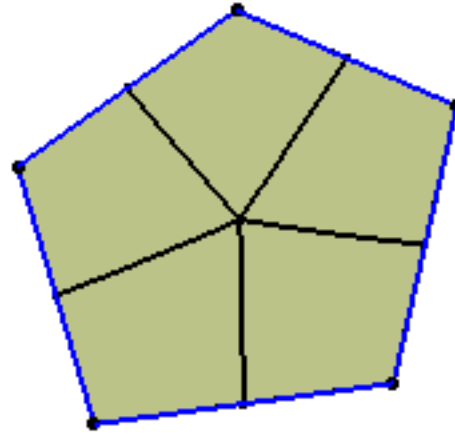
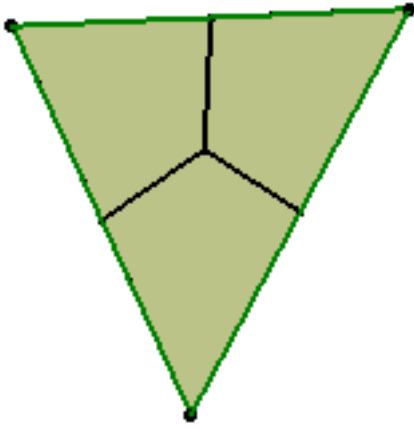

2. one or n surface(s) (four-side surfaces) will be created if a continuous continuity between the elements is respected.

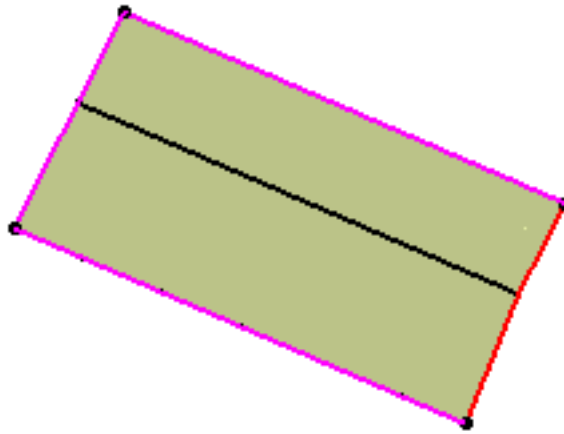

- **Power**: one filling surface is created. All continuity types are available using the contextual menu
- **Auto**: the best orders and number of patches will be chosen by the application depending on the inputs

In our example, we chose the **Auto** type.

3. Select the boundary of the first surface.

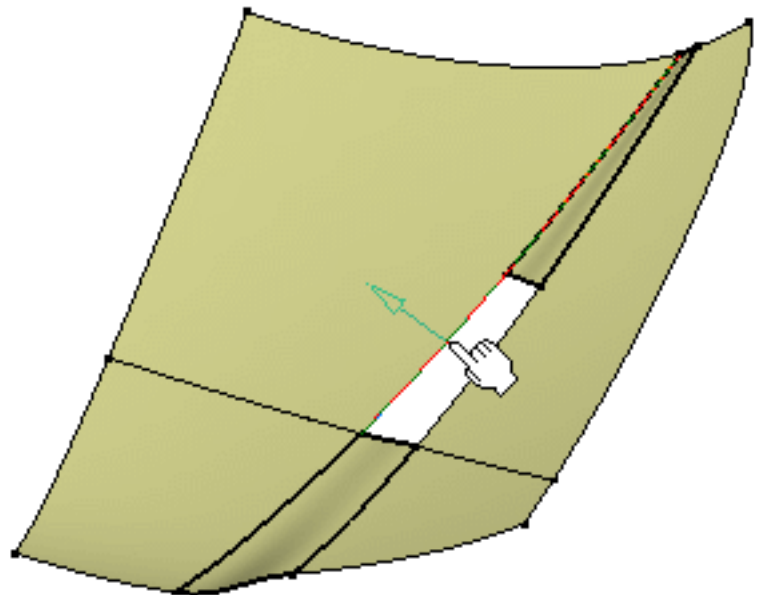

4. Select the boundary of an adjacent surface.

Information on existing gaps between supporting edges is displayed in the 3D geometry.

The maximum gap value allowed is 0.1mm.

5. Select the boundary of all other surfaces, still going from one surface to its direct neighbor.

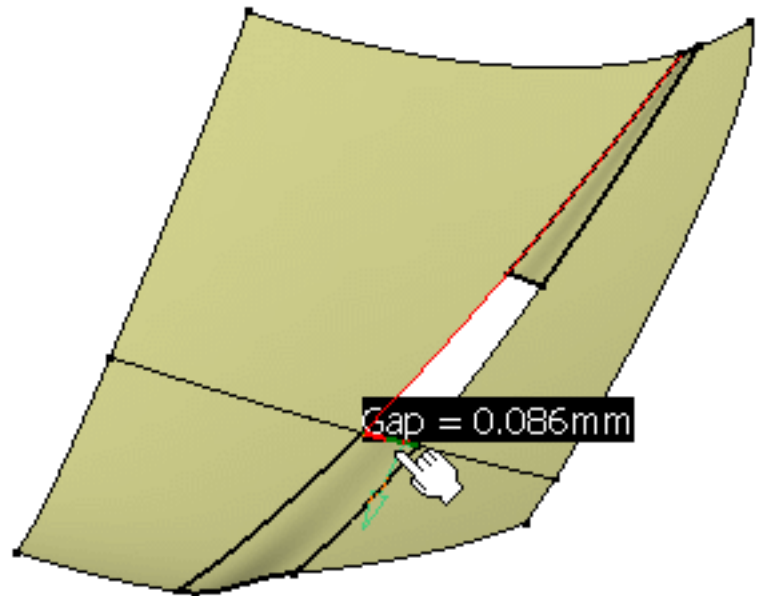

Once you have selected the last boundary contiguous to the first selected surface, the filling surface is created.

If you checked the **Continuities** option from the Dashboard (P2) or the [FreeStyle Settings](#), the corresponding information is displayed on the surface.

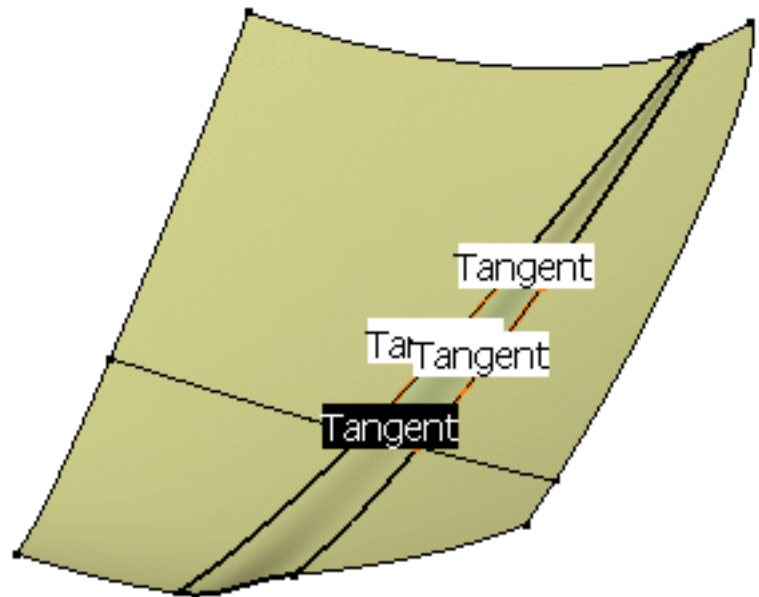

The Information frame informs the user about the resulting fill: type, number of patches, and the U/V order. Here the most appropriate type for this fill is the **Analytic** type.

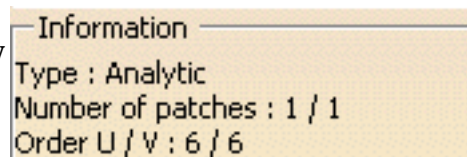

6. Check the **Furtive Display** option from the Dashboard (P2) to display the control points and visualize the **number of orders**.

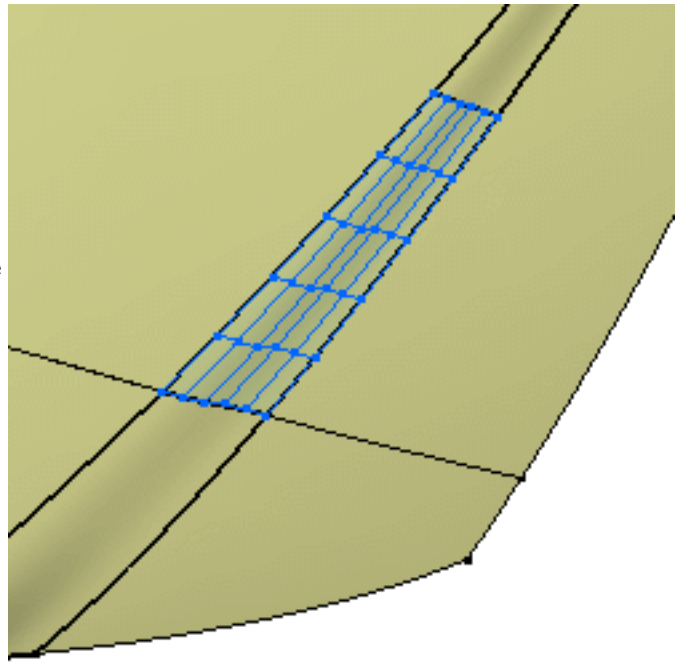

P2

7. Click More>> to display further options:

- **Limits**, that is constraints to be taken into account when computing the fill surface. You can specify whether it should comply with a given **tolerance**, or it should have a maximum **order** in U and V. The resulting surface will lie within these constraints.
 - **U/V Orders**: number of control points by patch
The minimum orders 2 / 2 for all fill types
 - **U/V Patches**
 - **Tolerance**: the maximum tolerance is 0.1. The smaller the tolerance is, the more precise the created fill surface is.

i

The Maximum Tolerance and Order are defined in **Tools -> Options -> Shape -> FreeStyle**. Please refer to the [Customizing](#) section.

If you create a fill then you decrease the order value in **Tools -> Options -> Shape -> FreeStyle**, the created fill will keep the former value. Nevertheless, if you edit the fill and decrease its order value directly in the Fill the dialog box, the new order value will be set as the maximum value, until it reaches the value defined in **Tools -> Options -> Shape -> FreeStyle**. However, if you create a new fill, the maximum order value will be the one defined in **Tools -> Options -> Shape -> FreeStyle**.

The tolerance value is comprised between 0.001 mm and 0.1 mm. May you define a higher value, the maximum value would still be 0.1 mm.

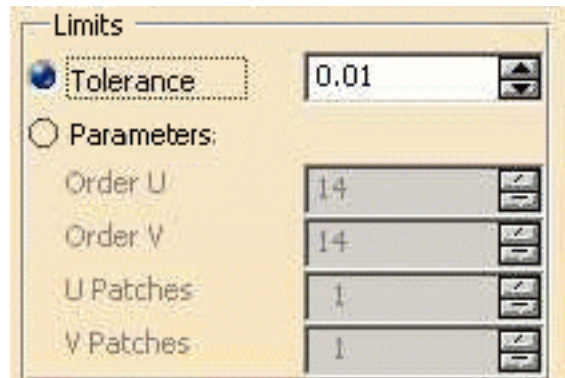

 Options in the **Limits** frame are grayed in the case of an **Analytic** type with three, five, or more input elements.

8. Right-click the displayed text to edit and modify the continuities.

You can choose from Point, Tangent or Curvature continuity, depending on the geometry configuration. Tangent continuity is available only when filling a closed contour.

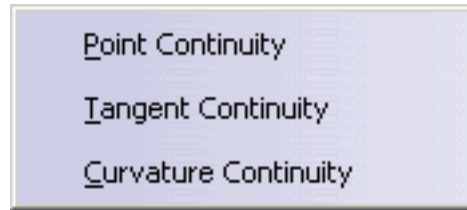

9. Click OK to create the filling surfaces.

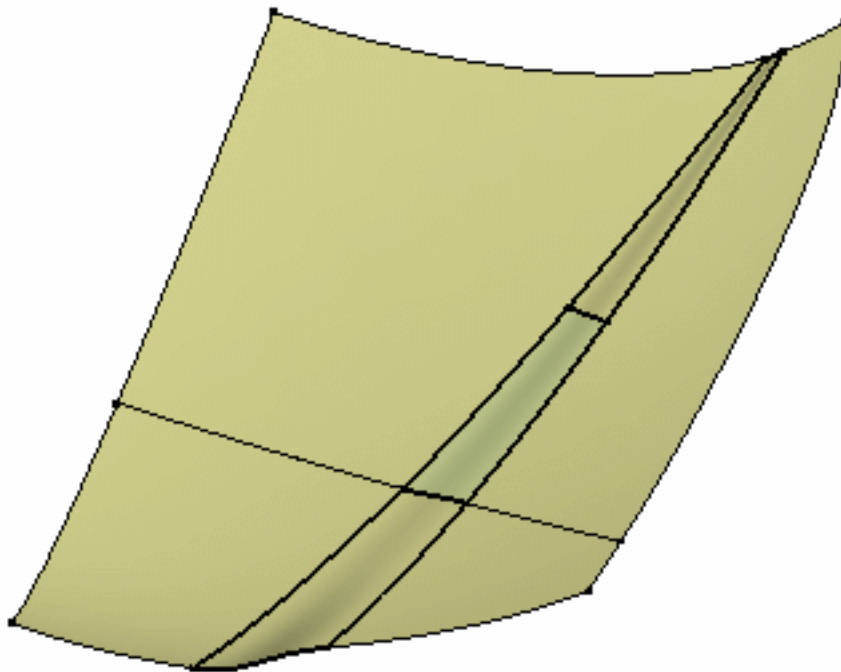

 The Constraint option you to define the **Deformation direction** (P2 only). This will let you deform the resulting filling surfaces according to the **Compass Direction** or **Normal to the Surface Direction**.

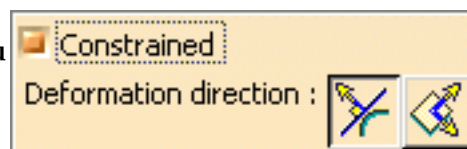



Use the manipulators at the center point (the barycenter point) to deform the generated surfaces. The deformation depends on the chosen icon: **Normal to the Surface Direction**, or according to the **Compass Direction**.

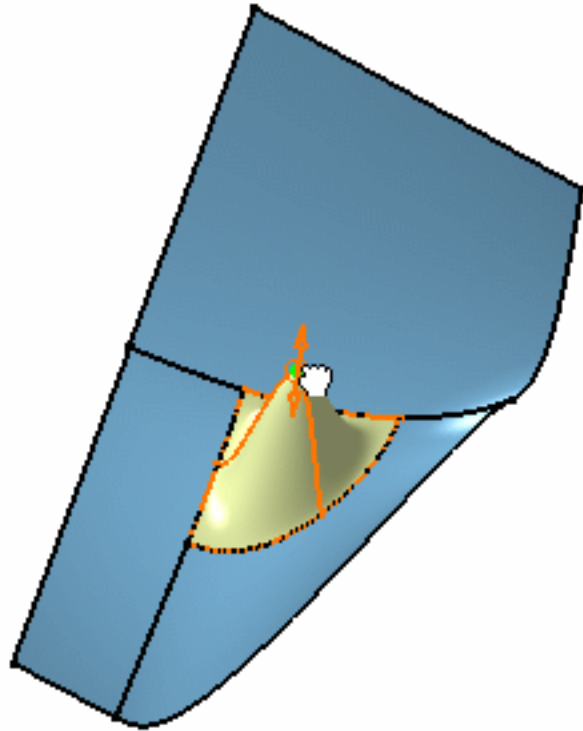

While deforming, set continuities are retained.

Capabilities are available from the [contextual menu](#) when right-clicking the manipulator.

The deformation direction after fill creation is managed by the center point frame and the point translator into 3D model. This point translator can be moved along a normal to resulting fill or on one of the compass direction. It has also the possibility to snap on any particular point.



 The Constraint option is only available with the **Analytic** type.

-  In case the selected surface lies on more than one support, the  appears. Please refer to [Selecting a Support](#) for further information.
- Please refer to the [Creating Filling Surfaces](#) chapter to have further information on the deformation direction.
- Available capabilities from the Dashboard, and/or specified through the [FreeStyle Settings](#), are: [datum creation](#), [temporary analysis](#), [auto detection](#) (Snap On Edge option only), [attenuation](#), [continuities](#) and [furtive display](#).



Manipulating Surfaces Using the Compass



This task explains how to move and translate surfaces independently from any other element in the document using the compass.



Open the [Manipulate1.CATPart](#) document.



1. Click the **Select** icon  and select the surface you wish to move.

2. Point to the compass manipulation handle (the red square located on the privileged plane at the base of the compass).

The cursor shape changes to a cross.

3. Drag and drop the compass over the surface you wish to move about.

The compass now is displayed in green.

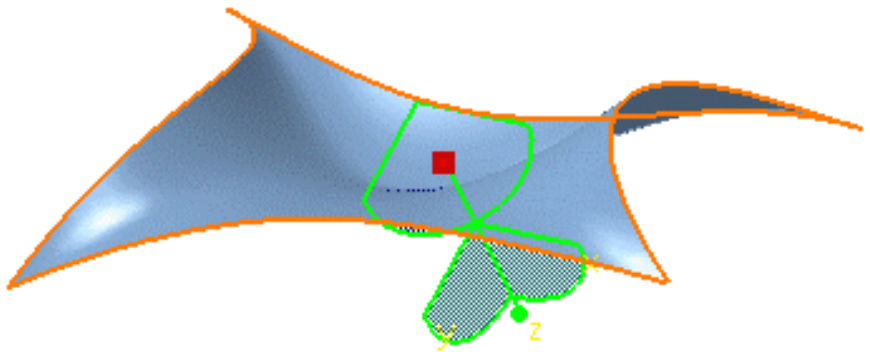

Make sure you choose to display the bounding box using the **Display manipulation bounding box** option from the **Tools -> Options -> General -> Display** dialog box, **Navigation** tab to display the whole bounding box as shown below, not just the compass over the geometry.

4. Move the pointer over any bounding box boundary, and drag the surface where you wish to move it.

5. Pull along a horizontal axis to slide the surface to the right or to the left.

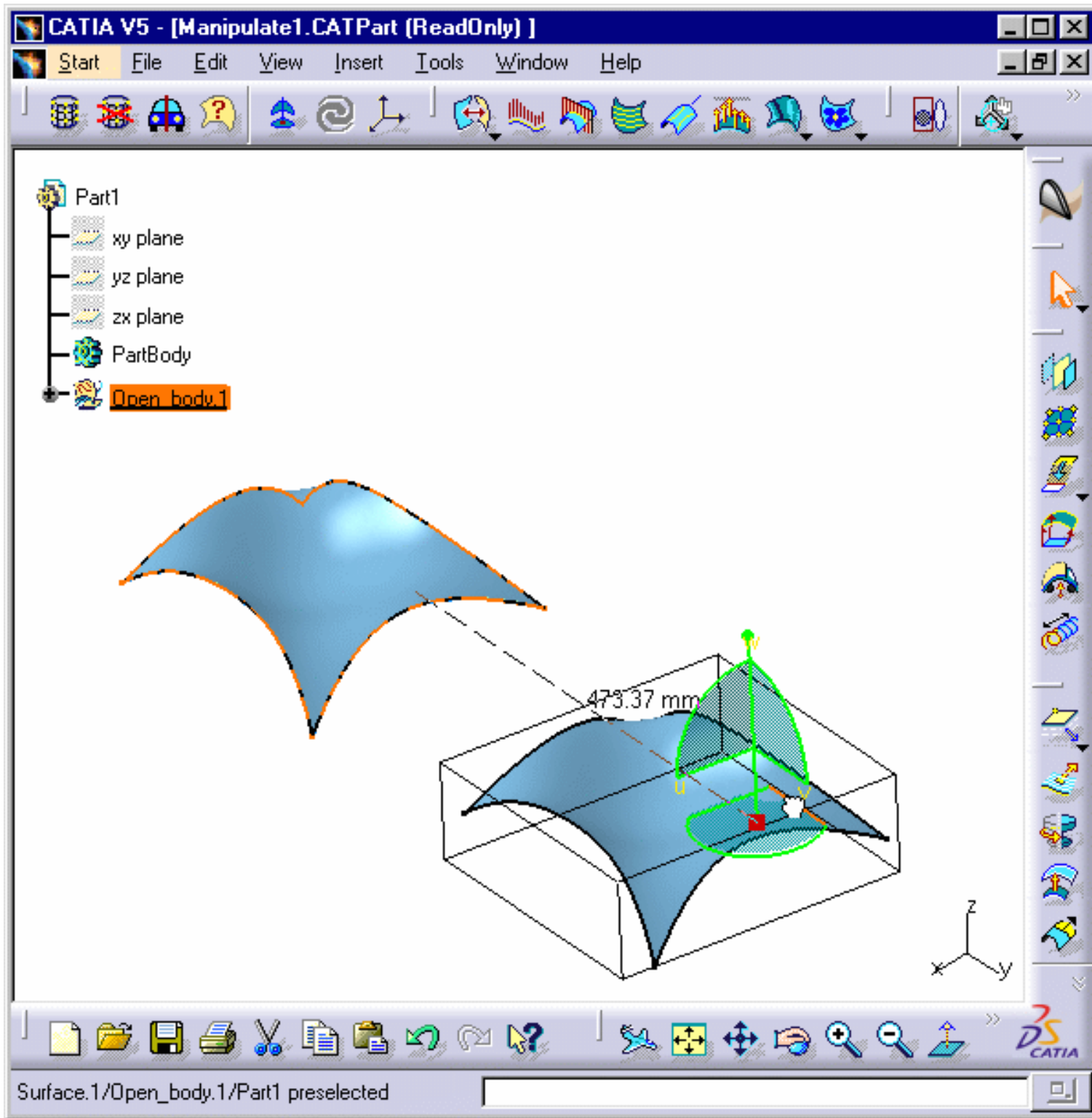

6. Similarly you can pull along a vertical axis to move the surface up or down.
The displacement distance is displayed as you move the surface around.

7. Release the mouse-key.

The surface has moved to a new location.

 For further details and general manipulation tasks refer to the *Infrastructure User's Guide: Manipulating Viewpoints Using the Mouse and Compass* and *Manipulating Objects Using the Mouse and Compass*.



Rotating a Surface Using the Compass



This task explains how to rotate surfaces independently from any other element in the document, using the compass.



Open the [Manipulate1.CATPart](#) document.



1. Select the surface you wish to move.
2. Point to the compass manipulation handle (the red square located on the privileged plane at the base of the compass).

The cursor shape changes to a cross.

3. Drag and drop the compass over the surface you wish to rotate.

The compass now is displayed in green.

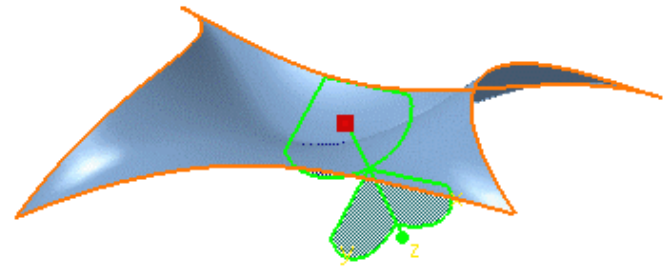

If you checked the option **Display manipulation bounding box** in the **Navigation** tab via the **Tools -> Options -> General -> Display** menu item, a box will appear around the selected surface.

4. Move the pointer over the arc of circle on the compass indicating the direction in which you want to rotate the surface.

The arc of circle is highlighted.

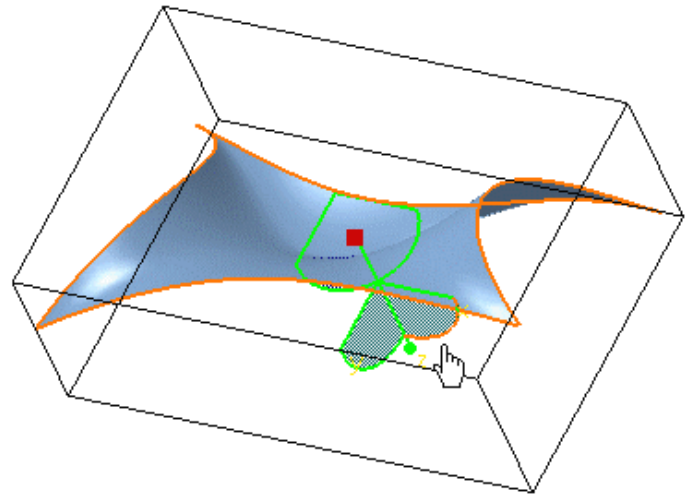

5. Drag in the desired direction.
The surface rotates within the plane indicated by the selected arc of circle.
6. Release the mouse-key.
The surface is set to the new direction.

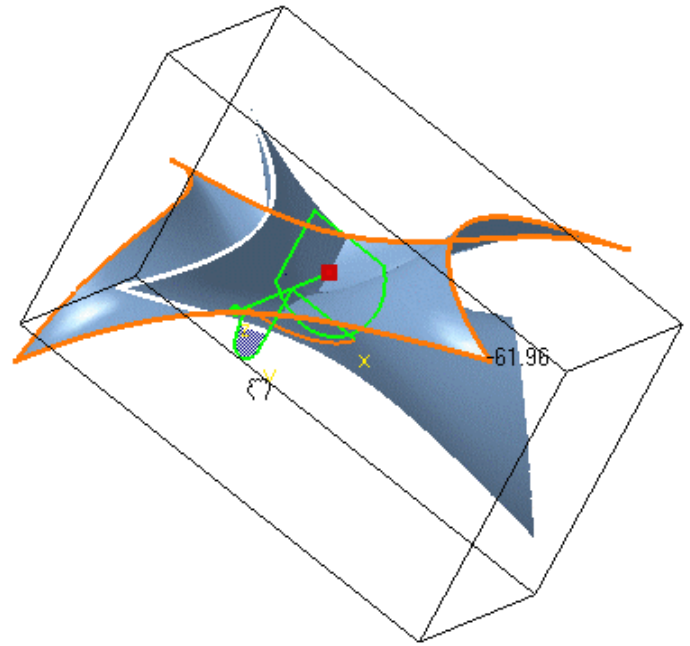

- The surface has rotated about an axis. However, this has not changed anything to any other element present in the document.
- Multi-selection, whether using a trap or the Ctrl-click, is available to rotate a set of elements.



Matching Surfaces

 In this task you will learn how to match two surfaces, or a surface to a curve, that is extend one surface to come up to the other element, specifying the continuity between the two elements.

 Some options are only available in FreeStyle Optimizer.

 Open the [MatchSurface1.CATPart](#) document.

 **1.** Click the **Match Surface** icon .

2. Select the edge of the surface to be matched.

The boundary is highlighted.

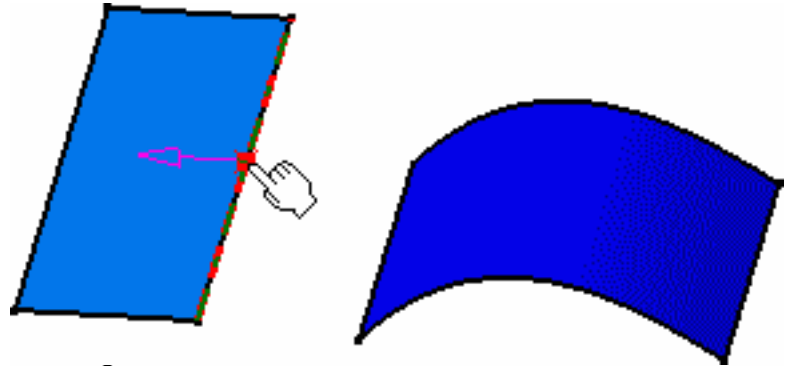

3. Move the pointer onto the second surface.

Possible boundaries for the match are highlighted as you move the pointer along.

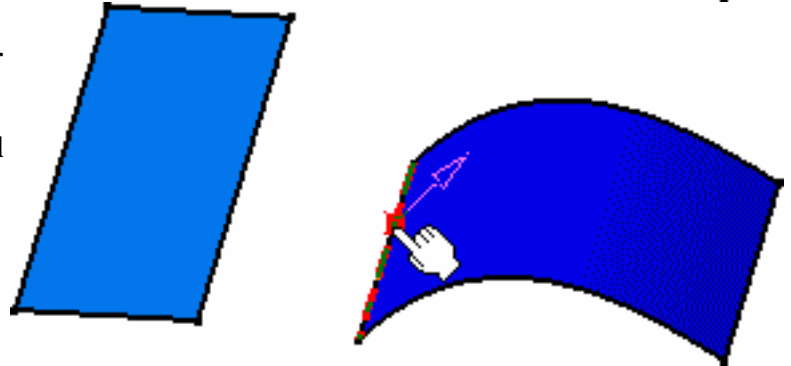

4. Click the surface when the adequate boundary is highlighted.

The match is automatically applied. The first surface is recomputed so as to be connected to the second surface.

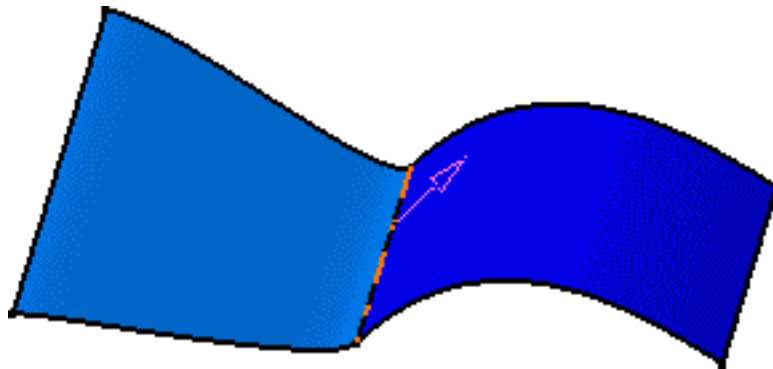

The Match Surface dialog box is displayed:

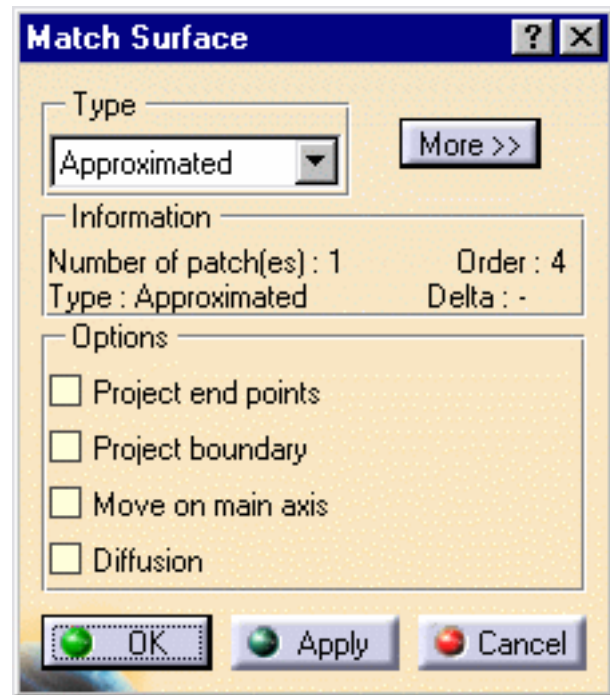

P1 In P1 mode, only the **Diffusion** option is available.

5. Define the matching type, that is computation mode, using the list:

- **Analytic:** available only when the selected curve is an isoparametric curve. The match is computed based on a mathematical formula leading to an exact location of each of the selected curve's control point. Furthermore, if both selected curves present the same number of control points, the deviation is null.

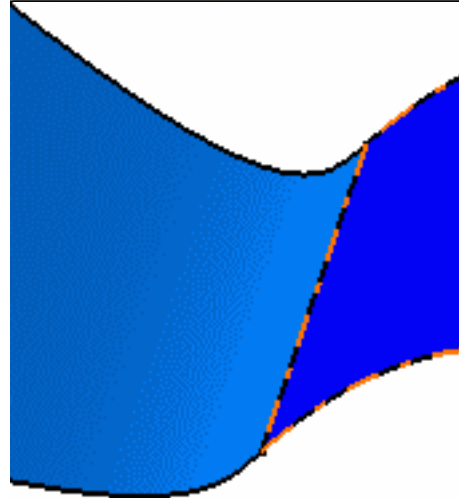

- **Approximated:** regardless of the type of the selected surface edges, the match is based on the discretization of the selected elements, and is approximated accordingly.

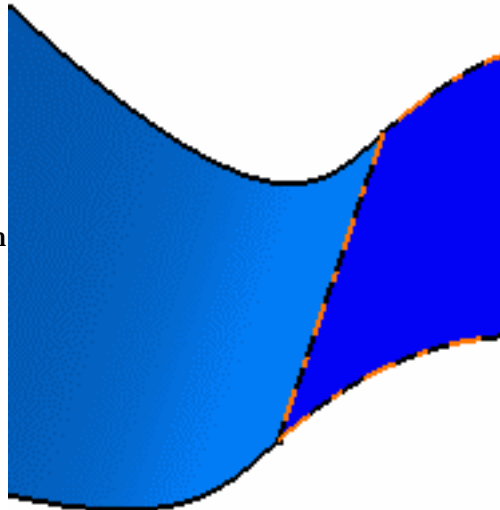

- **Auto:** the system optimizes the computation mode, trying first to create the match surface in **Analytic** mode, then, if not possible, in **Approximated** mode.

P1 When in P1 mode, only the **Auto** mode is available.

Information on the match surface is displayed in the Match Surface dialog box:

- the number of patches making up the surface
- the order of the surface to be matched
- the matching type used (especially useful when working in **Auto** mode)
- the delta from the initial surface.

6. From the Dashboard, click the **Contact**

Points icon .

Manipulators are displayed on the connection, allowing you to interactively define the match limits by simply sliding them along the target curve.

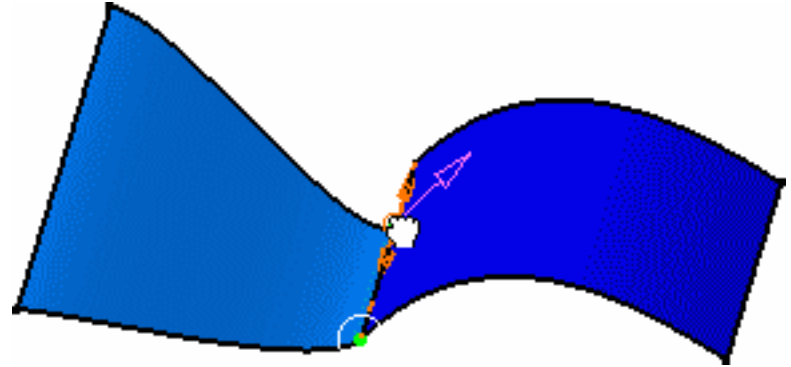

You can edit the contact points by right-clicking to display the contextual menu and choosing the **Edit** item.

You can also use the **Snap on Geometry** option. Capabilities are available from the [contextual menu](#) when right-clicking a contact point.

P2

7. Still from the Dashboard, click on the

Continuity icon  and right-click onto the identifier to edit the continuity constraint on the boundary of the match surface on the target element, using the contextual menu.

Point

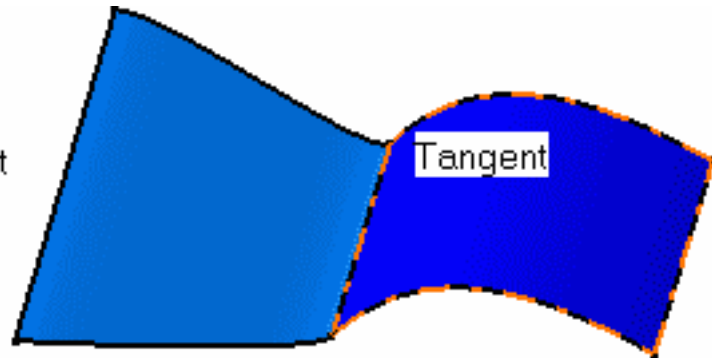

In the example, we impose a tangency constraint on the target surface. We keep a point continuity on the initial surface.

Available continuity types are: **point**, **tangent**, **curvature**, **proportional** and **free**.

- **Point**: the surfaces share each point of their common boundary, i.e. there is no gap between the surfaces.
- **Tangent**: the surfaces share a common tangent plane (i.e. normal) at each point of their connection
- **Curvature**: the surfaces share a common curvature and tangent plane at each point of their connection
- **Proportional**: similarly to the **Tangent** option, surfaces share a common tangent plane (i.e. normal) at each point of their connection, but the longitudinal variation from one point to the other is smoother, as the system automatically re-distributes the control point location on the matched surface.
This mode is automatically set for both limits of the matched surface.
- **free**: no constraint is imposed on the curve's control points.

 If a continuity type leads to some inconsistencies, a message is displayed on the surface, so that you can modify the continuity type:

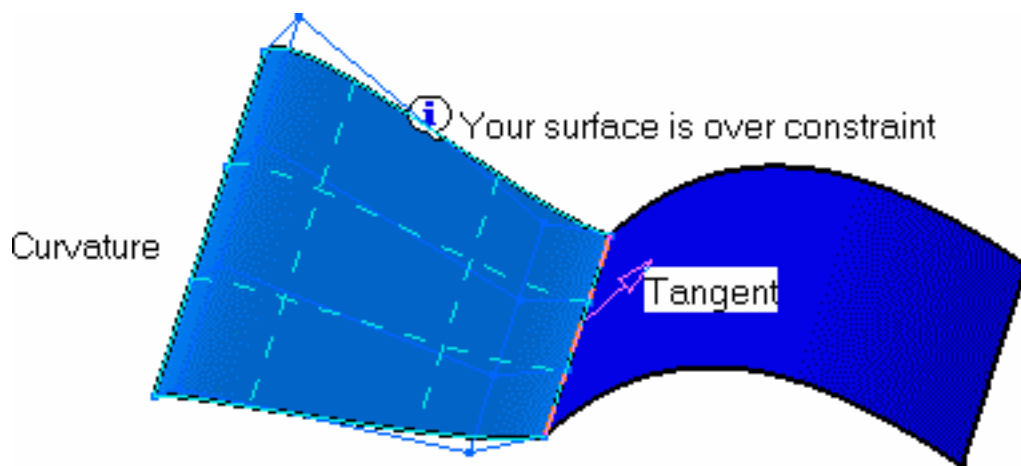



8. Still from the Dashboard, click the

Tensions icon  (P2 only).

The tension values are displayed on the element along with a green segment representing the direction and limits of the match surface tangent at its middle-points. You can modify the tension values by sliding them along the direction.

Default tensions and tangents are indicated by the **Init** string.

You can right-click the tension value to enter a new value within the 0 to 1 range, using the Tension Tuner dialog box.

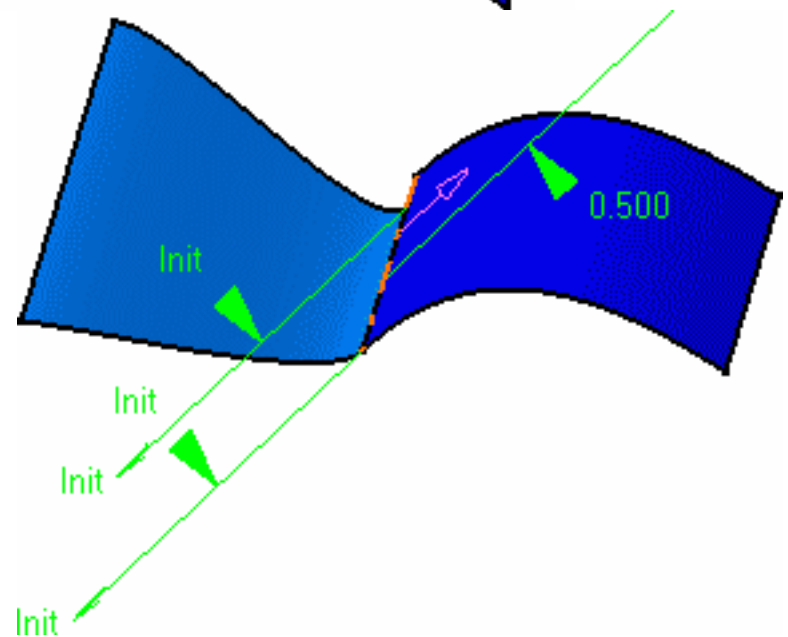

Local tangents (identified by the green arrows) are displayed as well enabling you to modify their angle and local tension.

1. Right-click the local tangent to choose from:

- a specific value you key in (User), in this case you can modify the value by right-clicking it
- the first surface tangent (Initial)
- the target element tangent (Target).

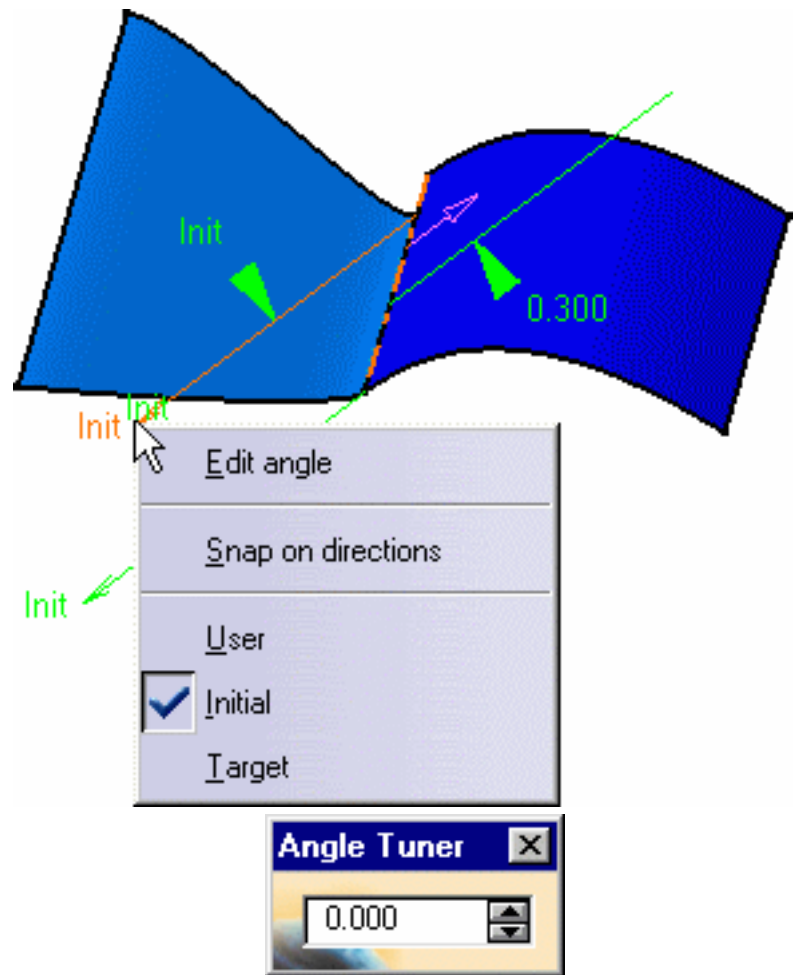

2. You can also choose the **Edit angle** contextual menu to display the Angle Tuner dialog box, allowing you to specify a given angle.

9. Click on More to display further options:

10. Check the **Quick connect checker and orders** option: depending on the type of continuity connection, three values can be displayed:

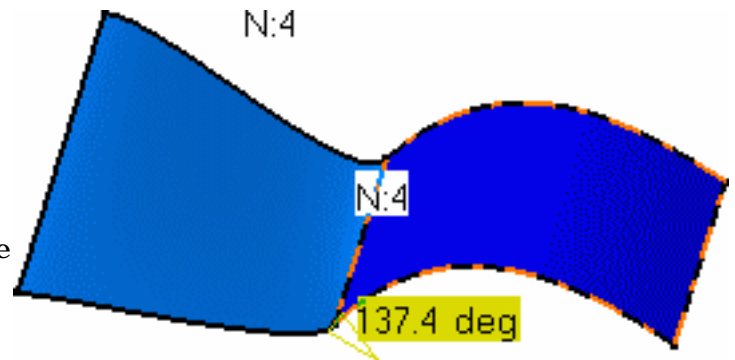



- the **distance** (mm): the maximum distance between the two elements
- the **angle** (degrees) between the tangents to the surfaces
- the surface order for each surface
- the **curvature** (%): that is the

ratio between both surface
curvatures

11. Check the **Control Points** option to display the control points and mesh lines on the surface, allowing you to dynamically modify them. Click **Run** to recompute the match surface.

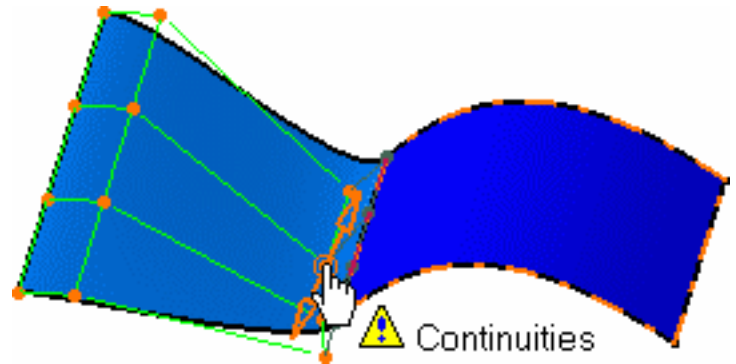
See [Editing Surfaces Using Control Points](#) to find more about available options.



 When a modification is not consistent with constraints previously set, as the choice of continuity for example, a message is displayed on the geometry. You then have the choice not to perform the modification, or to modify the constraint in order to edit freely the control points.

 When checked, the **Diffusion** option, propagates evenly any modification performed using the control points.

12. Click OK in the Match Options dialog box.

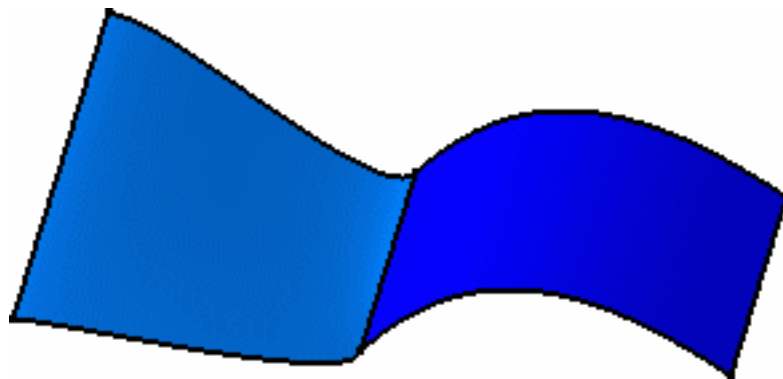

If you select a frozen surface (a surface with an history) or a non-Nurbs surface as input, a dialog box is issued warning you that an automatic conversion will be automatically performed before the matching operation:

- if an exact conversion is possible, a new Nurbs surface will replace the input one in order to perform the match. This new surface will be added in the specification tree.

- if there is a deviation or no exact conversion exists, the **Converter Wizard** panel appears allowing you to define the approximation according to a tolerance using parameters such as U, V orders, patch numbers, and deviation tolerance.

P1 The match operation does not modify the input surface, except if you modify its order:

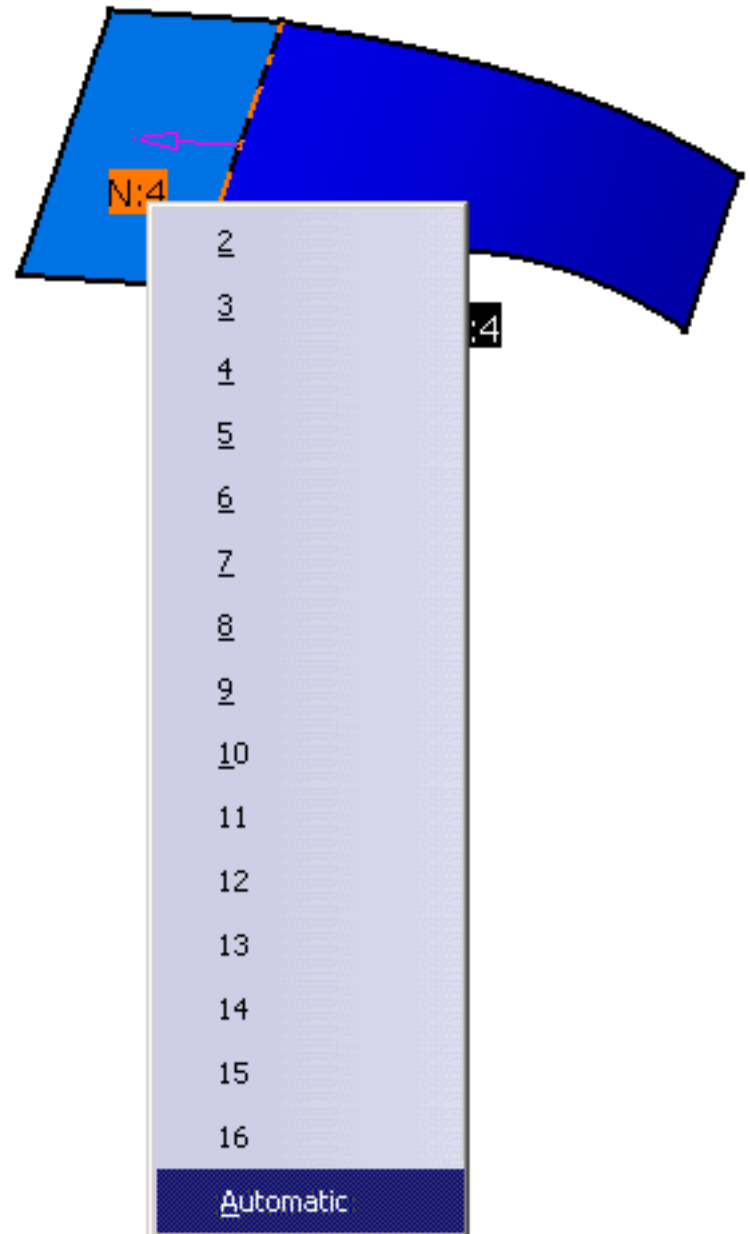

1. From the Dashboard, click the **U, V**

Orders icon .

Numbers indicate the order number of the element along the U and V directions.

2. Right-click a tag number and choose **Automatic** from the contextual menu to modify the order and the segmentation of the matching surface and reach the desired continuity constraint.



The **Keep original** option enables you to work on a copy of the input surface.



- The **Project end points** option allows linear projection of the smaller edge, if selected first, onto the smaller surface as shown to the left. To the right is the resulting match without the **Project end points** option:

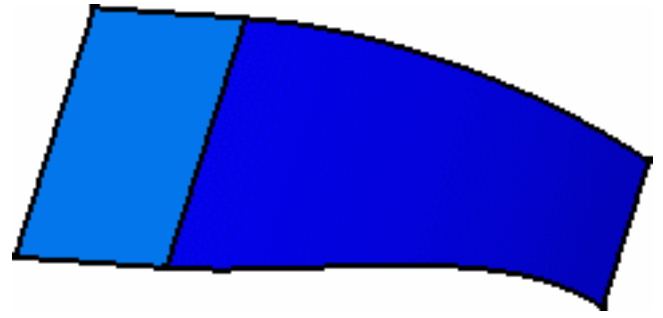
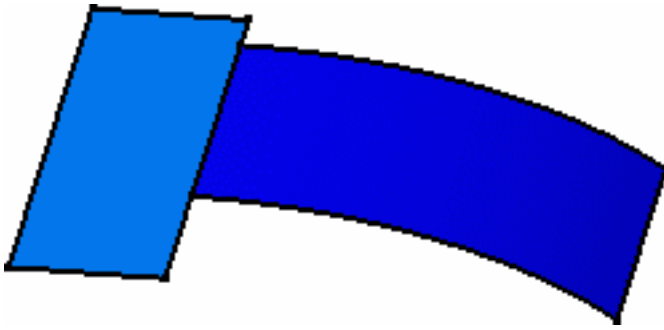

- The **Project boundary** option allows to directly project the first selected boundary onto the second surface, by selection of the surface only. (You do not need to select a boundary on the target surface.)

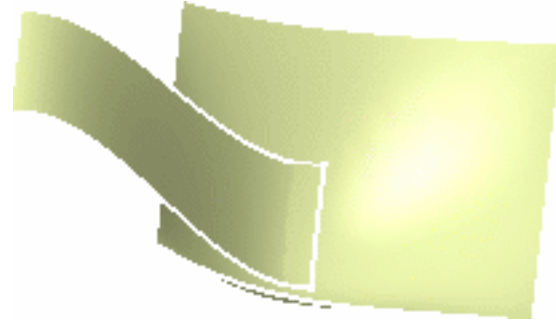

- The **Move on main axis** option constrains the matched surface so that its control points can only be moved along the compass' main axis.

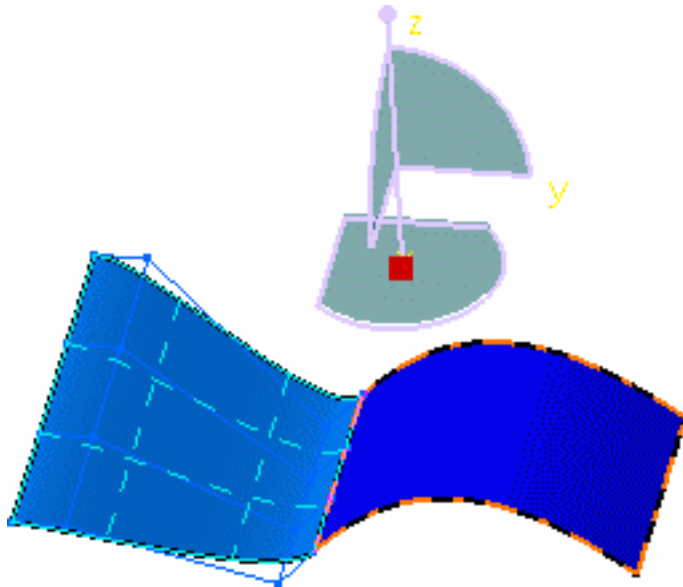

Unchecked Move on main axis option

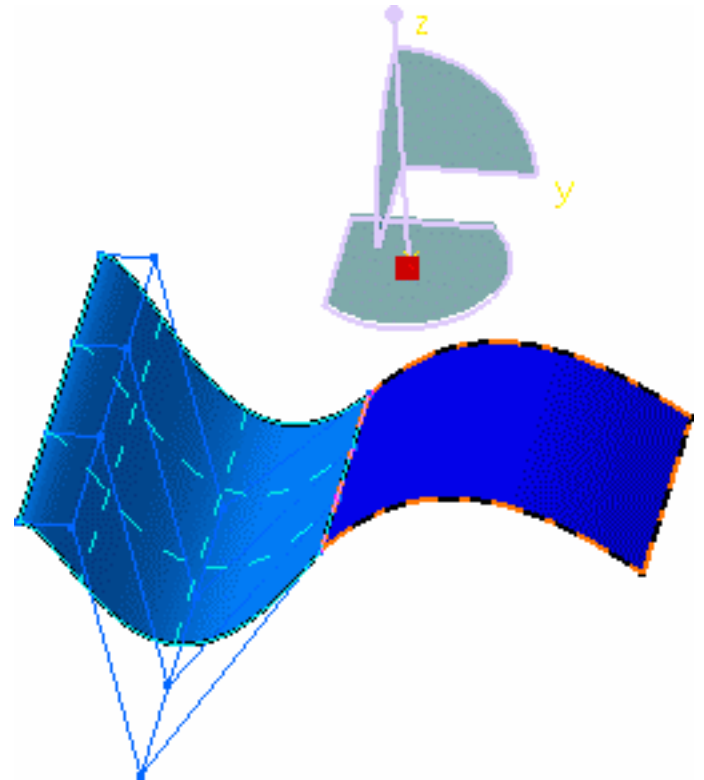

Checked Move on main axis option

 The **Move on main axis** option is only available with FreeStyle Optimizer.

 Available capabilities from the Dashboard, and/or specified through the [FreeStyle Settings](#), are: datum creation, keep original, auto detection, attenuation, continuity, contact points, tensions, and furtive display.



Multi-Side Matching



In this task you will learn how to match a mono-cell non delimited surface to at least two, and at most four, other surfaces. The source surface's edges will be deformed to match the target curves on surfaces, taking continuities into account.



Some options are only available in FreeStyle Optimizer.



Open the [MatchSurface2.CATPart](#) document.



1. Click the **Multi-Side Match Surface** icon



The Multi-side Match dialog box is displayed.

2. Set the deformation options:

- **Diffuse deformation:** if checked, the deformation is spread over the whole matched surface, not only to a limited number of control points.
- **Optimize continuities:** if checked, the deformation is done optimizing the user-defined continuities rather than according to the control points and mesh lines.

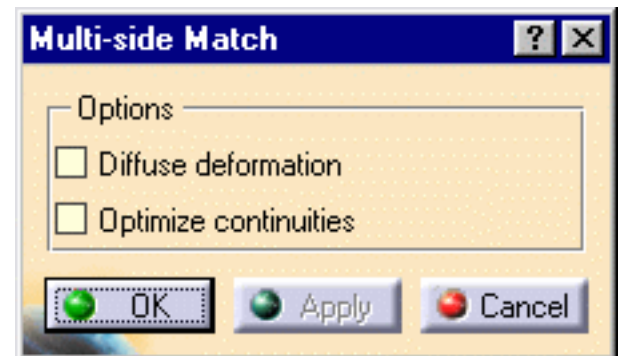

3. Select the first edge of the surface to be matched.

It is automatically detected as you move the pointer then highlighted once selected.

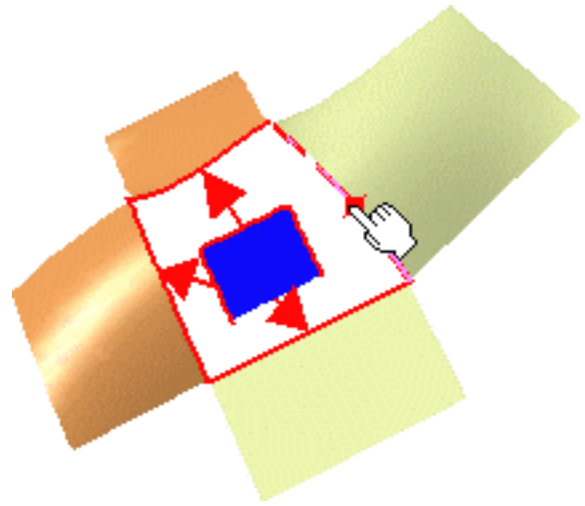

4. Select the target curve for the first selected edge.

An arrow is displayed indicating which source edge is to be matched to which target curve.

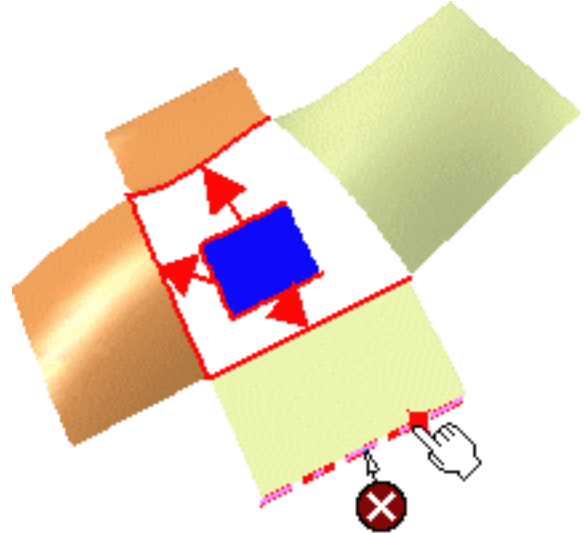

Source edges must lay on the same face

Note that in case an incorrect edge is detected, a contextual message helps you select the adequate target curve.

5. Click the **Continuity** icon  from the dashboard, to visualize texts on the geometry. Then right-click the texts to modify the continuity type (point, tangency, curvature) or to increase/decrease the edge order.

6. Continue selecting pairs of source and target curves to be matched, as needed.

7. Click Apply to visualize the matched surface.

If you already selected four source edges and four curves, the match is automatically computed.

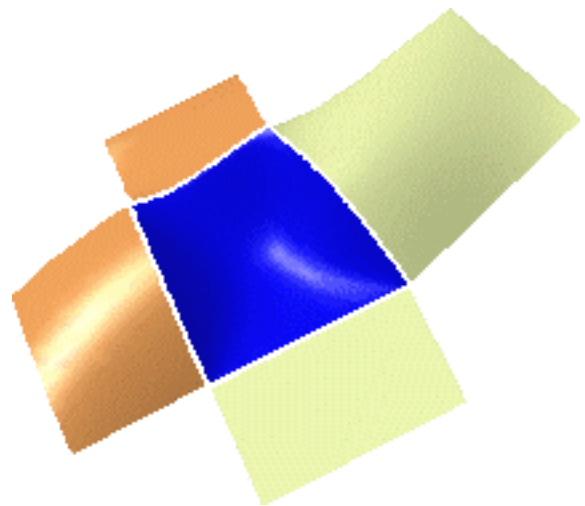

8. Click OK to create the multi-side match surface.



- All source edges must belong to the same surface.
- Only a complete surface, i.e. that has not been previously relimited, can be matched.
- Target curves necessary are surface boundaries or isoparametric curves, therefore laying on a surface. They cannot be curves created in space.
- Checking the **U, V Orders**  icon from the Dashboard, displays texts indicating the resulting surface order along U and V. Right-click these texts to choose a new order value.
- A surface can also be matched onto a relimited surface.
- The match takes into account continuities and order, but also existing geometric configurations. For example, in the example below, the two target surface overlap. In this case, the system automatically relimits the matched surface where the target surfaces overlap:



Available capabilities from the Dashboard are: [datum creation](#), [auto detection](#) (**Snap On Edge** option only), [continuity](#), and [furtive display](#) (control points are displayed on both the surface to be matched and the target surfaces).



Extending Surfaces



In this task you will learn how to extend a surface, that is make it bigger or smaller depending on which side of the manipulator you pull.



Open the [Extend1.CATPart](#) document.



1. Select a surface boundary.
A manipulator is displayed.

2. Click the **Extend** icon .

The Extend dialog box is displayed.

Two working modes are available:

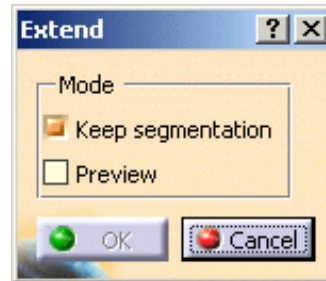
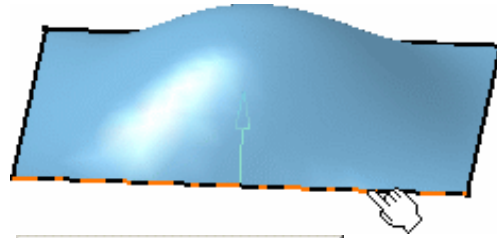

1. With the **Keep segmentation** option checked: the surface is extended according to its initial parameterization.

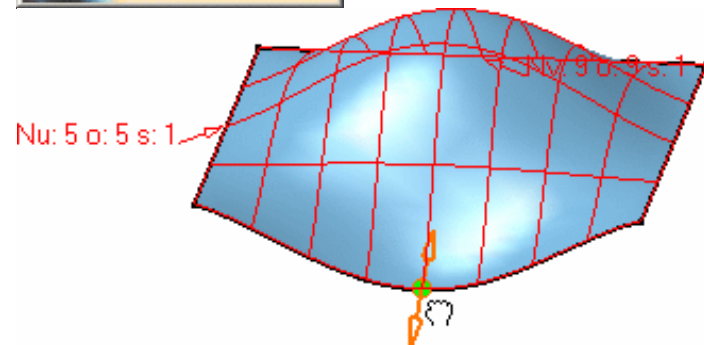

2. With the **Keep segmentation** option unchecked: the surface is extended taking the curvature continuity into account. This means that segments are added to the initial surface. In this mode, you can hold the Ctrl key down and move the manipulator to generate a symmetric extension.

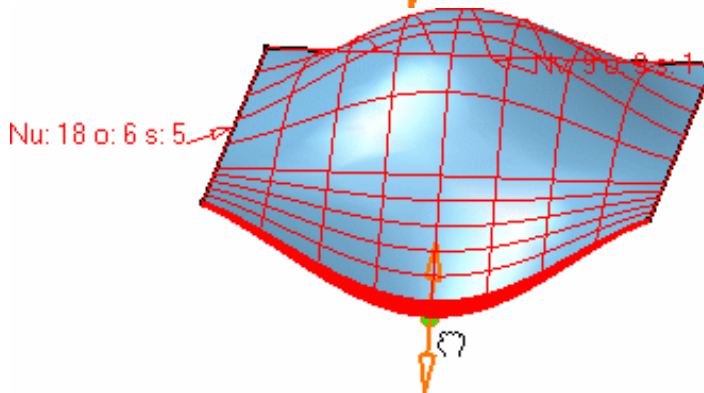

Checking the **Preview** button, you can preview the modification by a mesh, and display the surface order as well as the number of segments along both U and V directions.

The extended length value is also displayed when moving the manipulator.

The surface is then updated when you release the mouse. The extended length value remains.

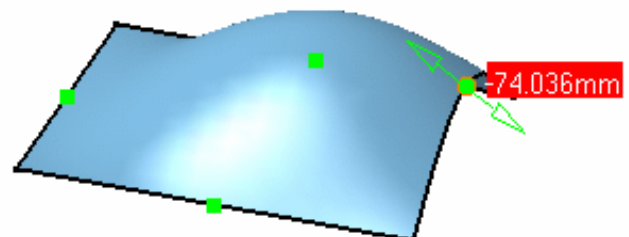
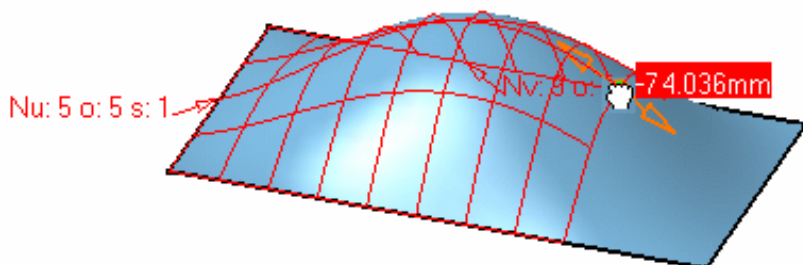

3. Click **OK**.

The extended surface is created.



- You can also define a step value to extend the surface:
 - When the manipulators are displayed, right-click one of them and choose the **Edit** contextual menu.

The Tuner dialog box is displayed, in which you can key the extension step value.

- Move the pointer back over the manipulator, and pressing and holding the Shift key, click the manipulator.

The surface is extended by the set step value and the length value is displayed.

Depending on the manipulator's arrow that is clicked and the keyed in value (negative values are allowed) the surface is extended in one direction or the other. Note however that when the **Keep Segmentation** mode is unchecked, the surface can only be extended and not shortened.

The **Keep this point** capability is also available from the [contextual menu](#).

P2 Capability are available from the Dashboard: [datum creation](#) and [keep original](#).

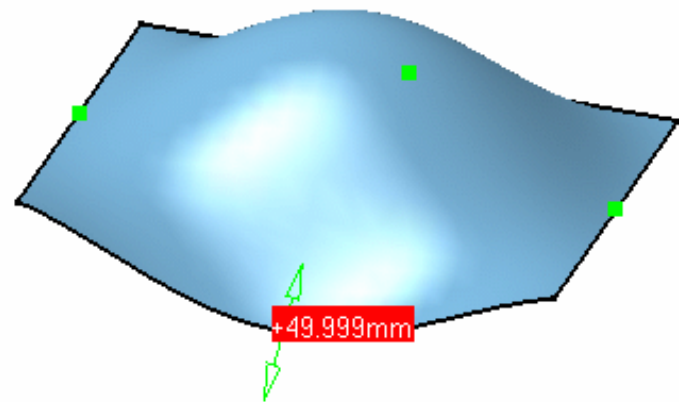
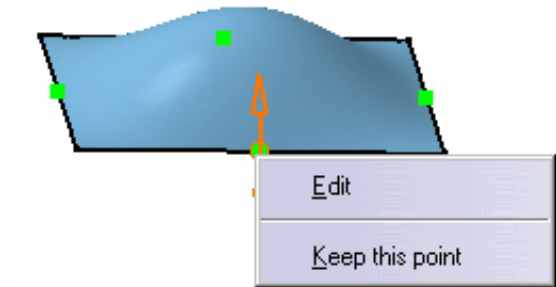

Smoothing Surfaces



In this task you will learn how to smooth a surface.



Open the [Smooth1.CATPart](#) document.



1. Select the surface to be smoothed.

2. Click the **Control Points** icon .

Control points are displayed on the surface, and the **Control Points** dialog box appears.

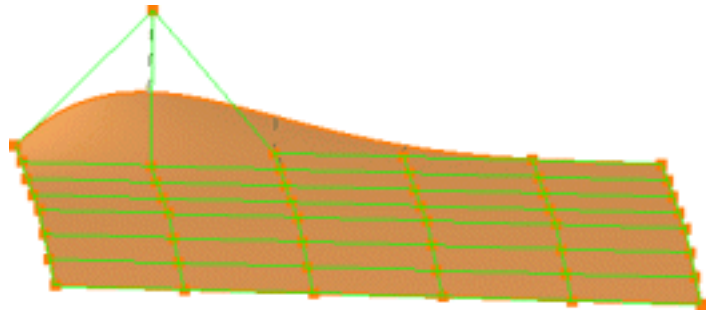

3. Define the smooth weight, and click **Run**.

The surface is smoothed according to the value.

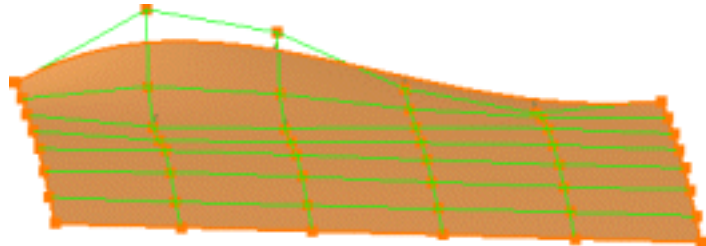

4. Click again to repeat the smoothing operation if needed.

5. Once you are satisfied with the smoothed surface obtained, click **OK** in the **Control Points** dialog box.



You do not need to select the whole surface. You can choose at which point, or mesh line, the surface should be smoothed. Simply use the multi-selection capabilities:

- Press and hold down the Shift-key and click a first point. Still maintaining the Shift key down, click another point of the curve. All points selected between the two selected points are selected as well, and the surface is smoothed in this area only.
- Click a first point, press and hold down the Ctrl-key, then move on to the other points to be selected. Only the explicitly selected points are highlighted, and smoothing is performed on these points only.



Capabilities are available:

- from the [contextual menu](#) when right-clicking a control point
- from the Dashboard are: [datum creation](#), [auto detection](#), and [attenuation](#).



Redefining Surfaces Limits

P2



This task shows how to redefine the limits of one or more surfaces by splitting it along one or more curves.



Open the [Break1.CATPart](#) document.



1. Click the **Break** icon .

The FreeStyle Break dialog box is displayed as well as the [Break Report panel](#) and the [Tools Palette](#).

2. Choose the Break type by clicking on the icons on the left.

Three types are available:

- [Curves by points](#)
- [Curves by curves](#)
- [Surfaces by curves \(as in our scenario\)](#)



In the Selection page, the **Cut (0)** text is highlighted.

3. Select the surface(s) to be cut.

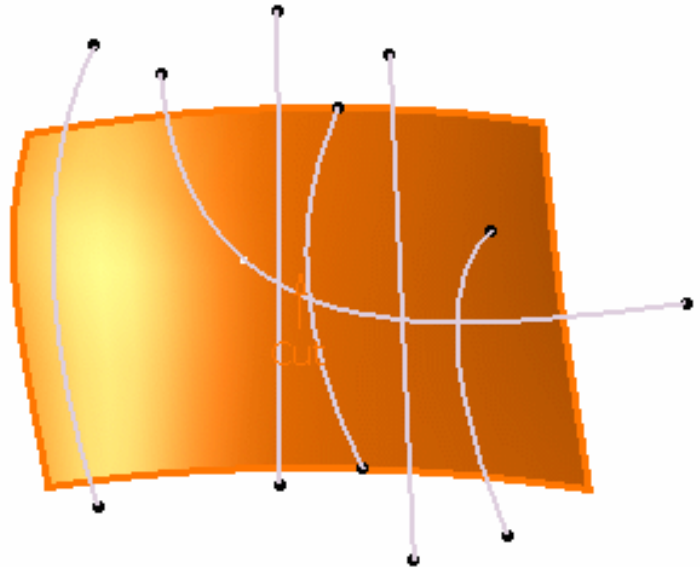

- Click the **Cutting** (0) text and select the cutting curve(s).

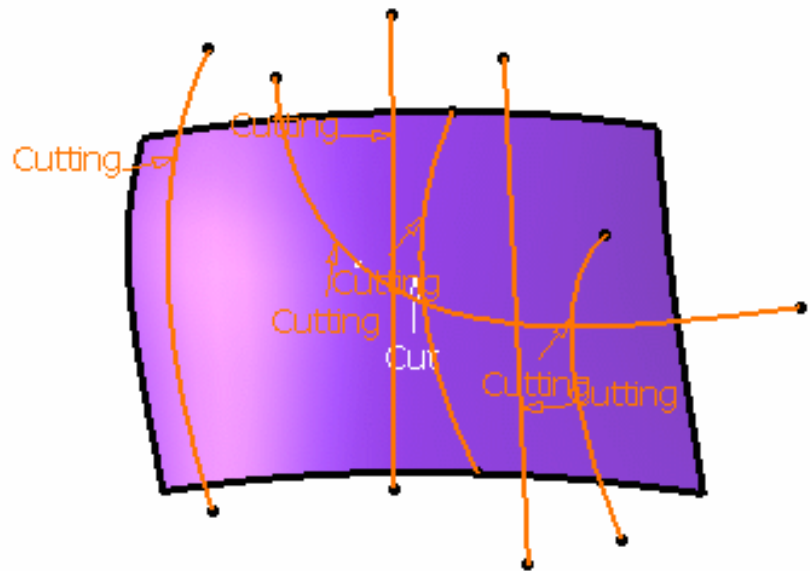

- Click Apply.

By default, all elements are kept.



The Break Report panel displays all the information regarding the cutting elements. It lists:

- the cutting elements that can be used for the Break (marked by a green tip). If you click on the text, the corresponding curve is highlighted in green in the 3D geometry.
- the cutting elements that cannot be used for the Break (marked by the condition to be applied so that they can be used: projection, extrapolation, etc). If you click on the text, the corresponding curve is highlighted in red in the 3D geometry.
 - In case of an extrapolation problem, the side of the curve to be extrapolated is circled in red.
 - If there is no selection of cutting elements, an error message is issued and the Break Report panel informs you that no element is selected.
 - If a red cross is displayed, it means that the problem cannot be managed by the system.

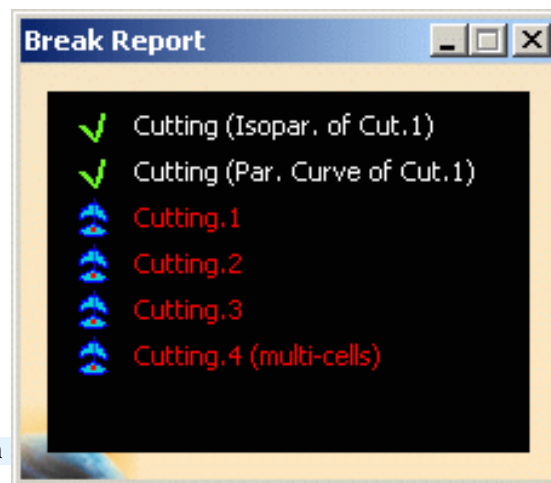

 This panel can also be opened via the Display tab.

- Click the parts of the surface that you do not want to keep.

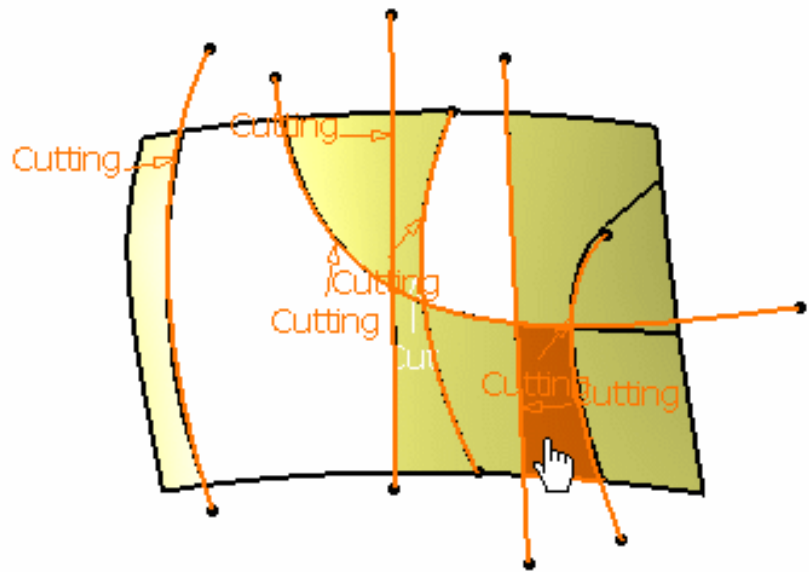

 A contextual menu is available on the each part of the surface.

- Keep all:** all parts of the surface are kept
- Keep all but this:** all parts of the surface are kept except the selected one
- Remove all but this:** all parts of the surface are removed except the selected one

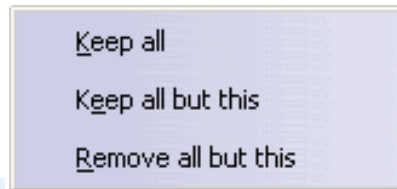

- Click the <<**Settings** text to access advanced settings.

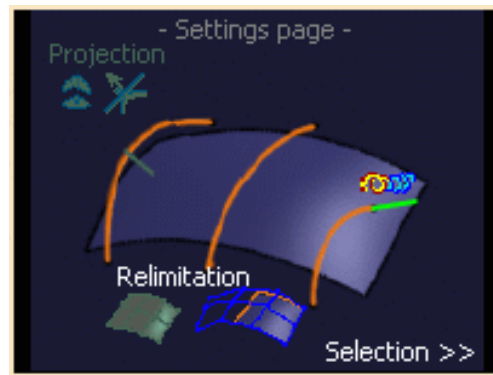

Projection

- **no projection:** click the **Projection** text to make the projection optional.

As a consequence, the points that do not lie on the trimmed curves will not be projected onto the surface.

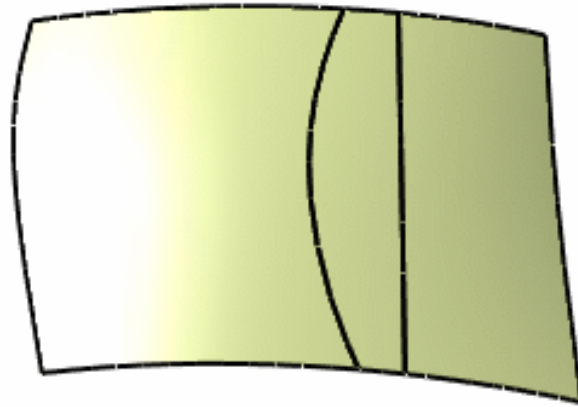

If certain curves do not lie on the surface, they are projected (pseudo-intersections) onto it according to the direction set in the Break dialog box:

- **Compass:** click the compass icon so that the projection is normal to the compass

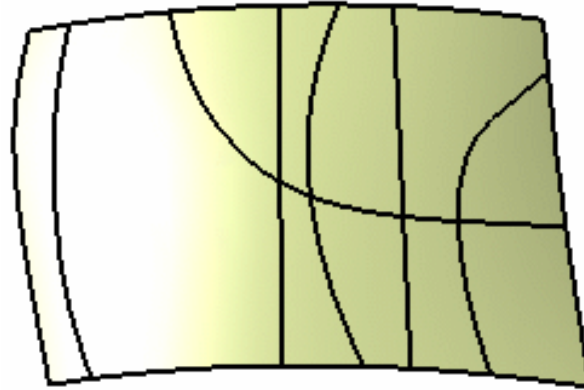

- **Normal:** click the normal icon so that the projection is normal to the element

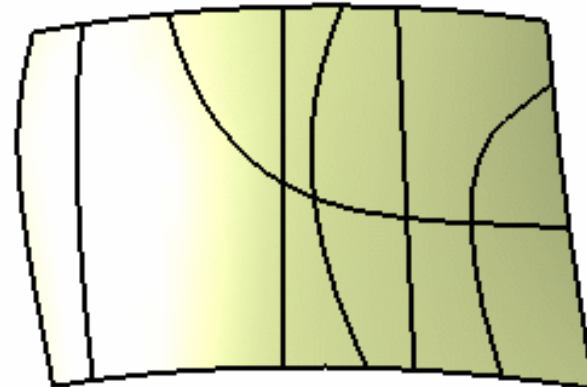

Relimitation

- **Shorten mesh:** curves are not relimited and their limits are redefined. New curves are created.

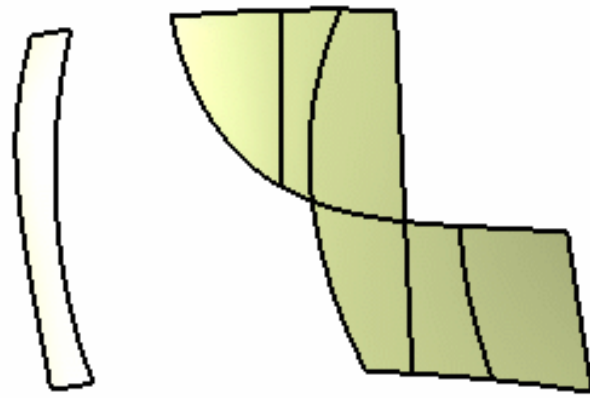
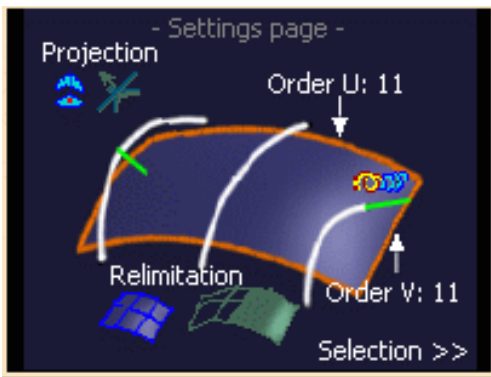

- The maximum degree variation allowed for each patch of the new surface as compared to patches of the initial surface can be modified. Click the **U Order** and the **V Order** text to edit and modify the values (besides is an example with U and V values set to 8)

The U and V order maximum values are set with the [Max Order](#) option of the FreeStyle settings.

- Only 4 edge-patches are created.
- **Keep mesh:** curves are relimited and the control points of each initial surface is kept.

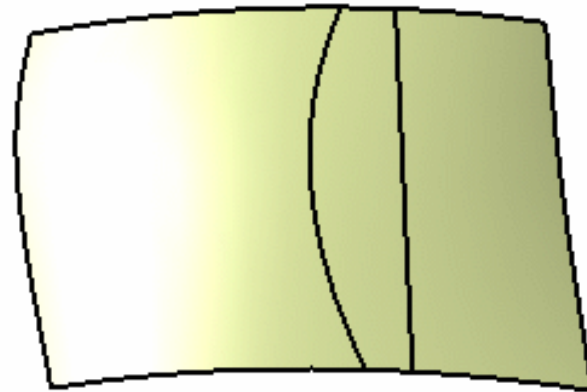
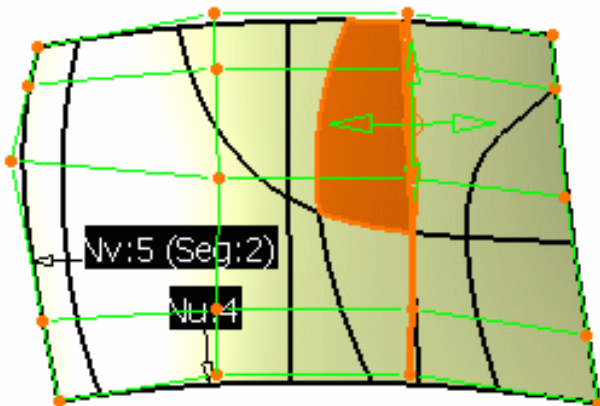

Extrapolation

Click the **Extrapolation** icon  if you want the automatic tangency extrapolation of the cutting curves to be optional.

As a consequence, one edge is added.

The control points of each initial surface is kept.

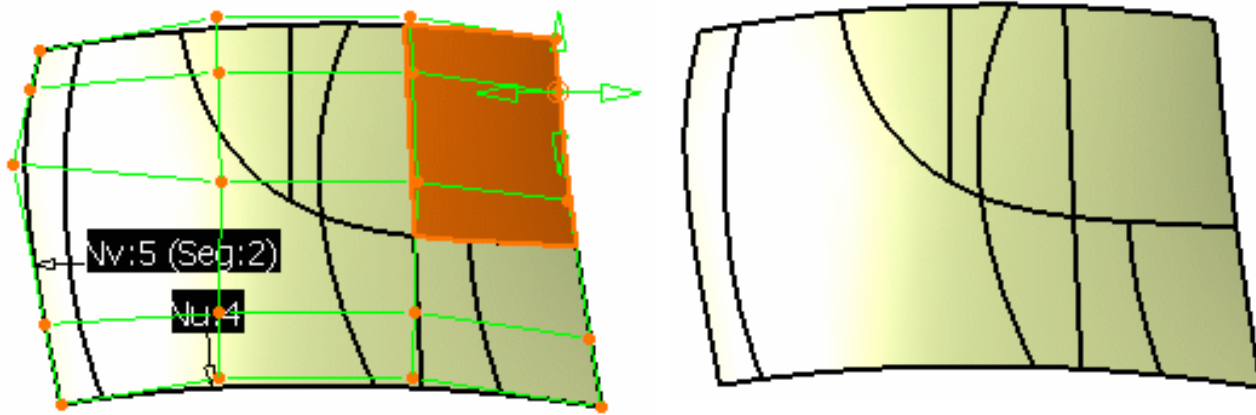

8. Click OK to create the break surface.



- Click the **Display>>** text to manage the display of the 3D icons and the Break Report panel.
- Available capabilities from the Dashboard are: [datum creation](#), [keep original](#), [insert in a new geometrical set](#), and [temporary analysis](#).



Restoring a Surface



In this task you will learn how to restore the limits of a surface or a curve when it has been split using the **Break Surface or Curve**  icon (see Splitting Geometry for the Generative Shape Design workbench).



Open the [Untrim1.CATPart](#) document.



1. Click the **Untrim** icon



in the **Operations** toolbar.

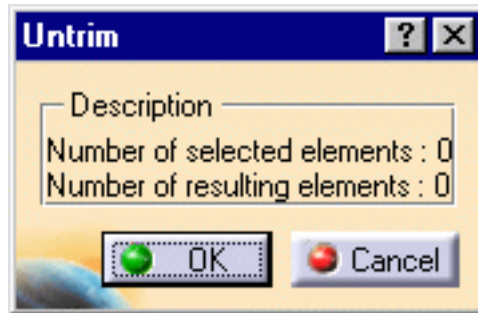

The Untrim dialog box is displayed.

2. Select the surface which limits should be restored.

The dialog box is updated accordingly.

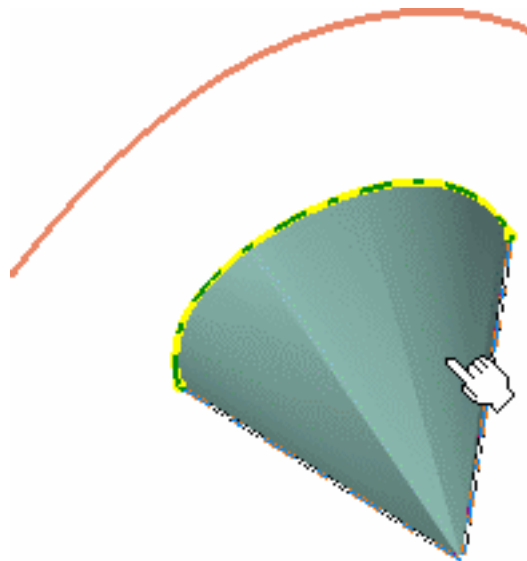

3. Click OK in the dialog box.

A progression bar is displayed, while the surface is restored. It automatically disappears once the operation is complete (progression at 100%).

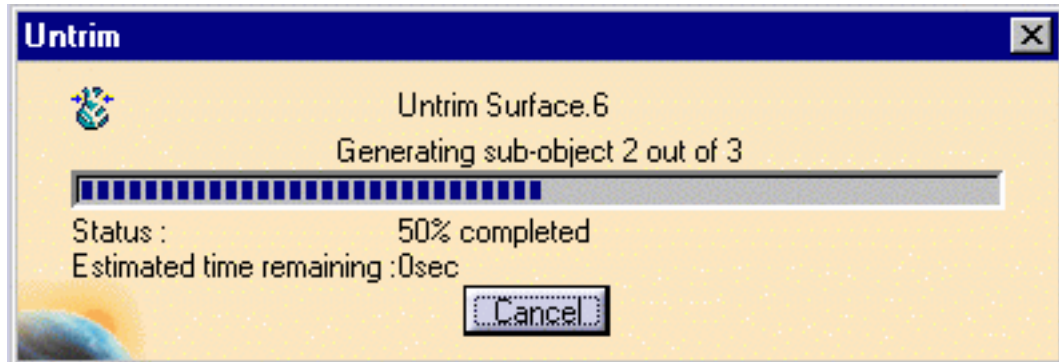

The initial surface is automatically restored.

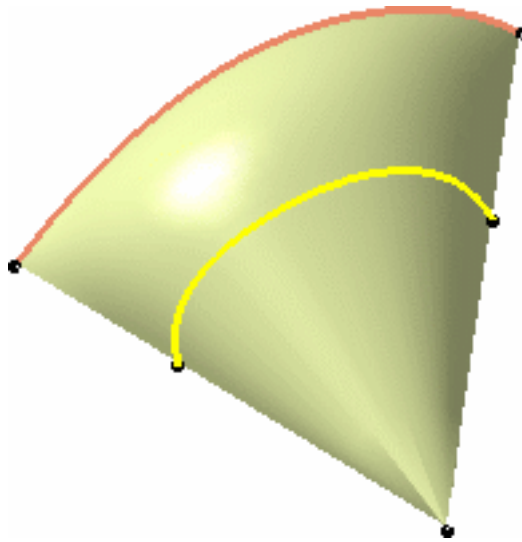

The restored surface or curve is identified as Surface Untrim.xxx or Curve Untrim.xxx.

You can perform a local untrim on faces. Three modes of selection are available:

- selection of the face: the initial surface is restored

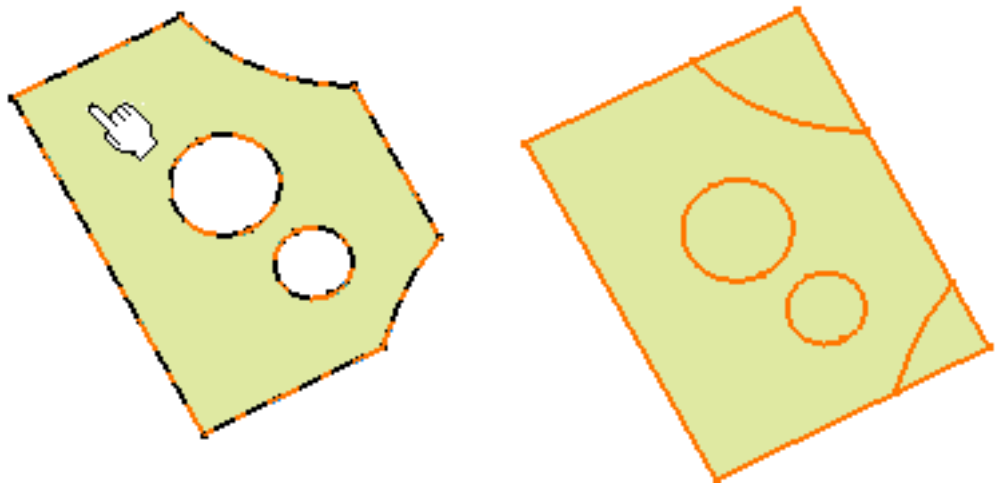

- selection of an inner loop:
only this loop is restored

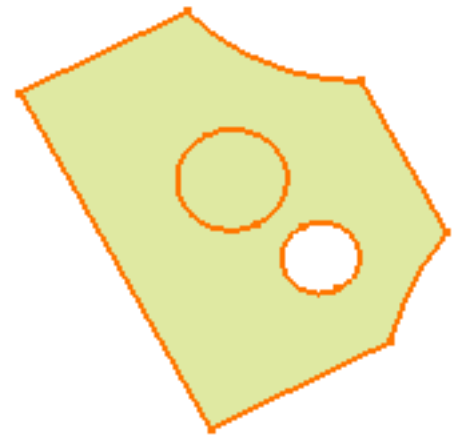
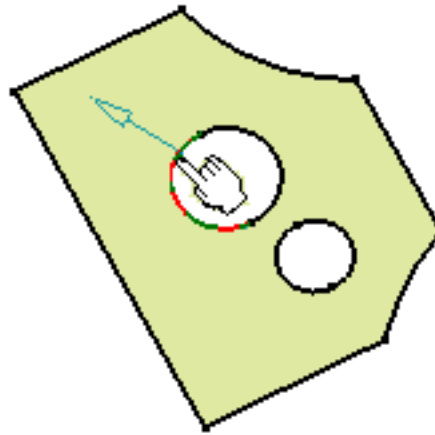

- selection of the outer loop:
only this loop is restored

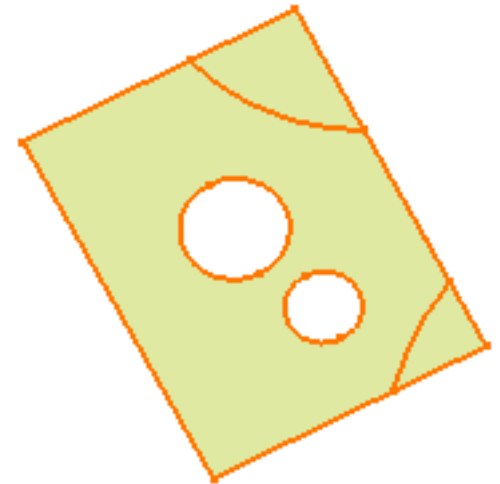
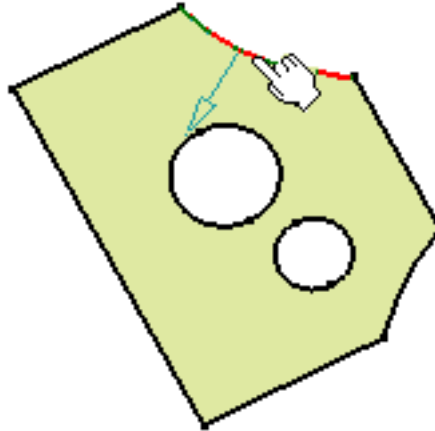

- If the surface has been trimmed several times, it is the initial surface which is restored. To partially untrim the surface, you need to use the **Undo** command right after the trim.
- If the surface to be restored is closed (in the case of a cylinder) or infinite (in the case of an extrude), the limits of the untrim feature will be the bounding boxes of the initial surface. Therefore, the initial surface and the untrim surface may be identical.
- You can individually select a vertex or a boundary from the restored surface or curve.
- Multi-selection is available and allows to create several untrim features in one step. All untrim features will appear in the specification tree.
- The [datum creation](#) capability is available from the Dashboard.



Concatenating Surfaces



This task explains how to concatenate a two-cell mono-domain FreeStyle surface or two separate contiguous surfaces into a mono-cell surface.

The resulting surface is a curvature continuous surface (C2).



Open the [Concatenate2.CATPart](#) document.

This document contains a set of connex surfaces.



1. Click the **Concatenate** icon .

The Concatenate dialog box is displayed.

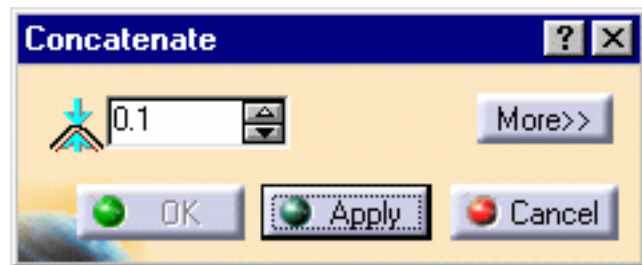

2. Set the tolerance value.

This value defines the maximum parametric deviation allowed between the selected elements and the resulting curve when concatenating.

The Maximum deviation value displayed in the dialog box (see step 5) is computed as the standard distance analysis and therefore is not necessarily the minimum tolerance value to be set in order to concatenate the curves.

3. Select the surfaces you wish to concatenate and click **Apply**.

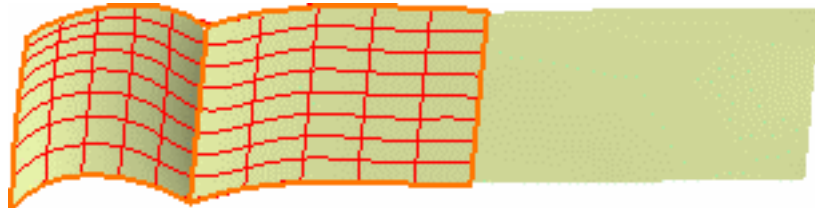

A single surface is previewed, with its segment limits in both U and V, provided the tolerance is compatible. If not, a message is issued prompting you to increase the tolerance value.

The minimum tolerance value necessary to obtain a result displays as well.

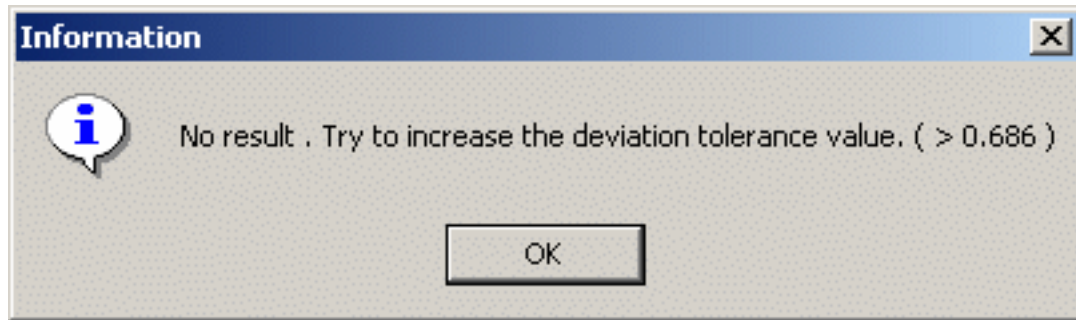

4. Change the tolerance value so that it is compatible to create a single surface.

5. Click **More>>** in the dialog box.

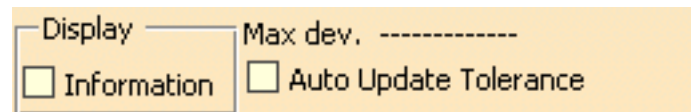

6. Check the **Information** option.

The corresponding information is displayed on the resulting surface, that is:

- **Nu/Nv**: number of control points in U and V
- **o**: the curve order
- **s**: the number of segments in the curve
- the maximum deviation

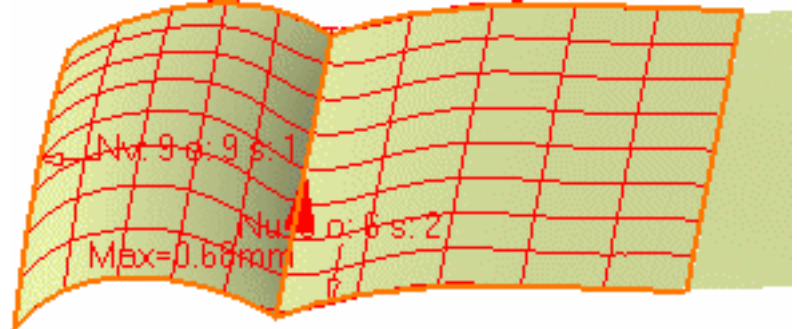

 In case you did not check the Information button, the maximum deviation is also displayed in the dialog box.

7. Check the **Auto Update Tolerance** button to automatically update the tolerance value in case the value you set is too low.

A minimum result to enable the concatenation is displayed and the concatenation is performed.



No message is issued prompting you to increase the tolerance value as the minimum value is set automatically.

8. Click OK in the Concatenate dialog box.

A surface is created, the result of the concatenation of the initially selected elements (we changed its color to blue for easier identification). This surface is C2 continuous.



- Only two cells, whether in the same element (join for example) or in separate elements (two different cells) can be concatenated at a time. To concatenate more, you need to concatenate the first two cells, then the resulting concatenated surface with another cell, and so forth.

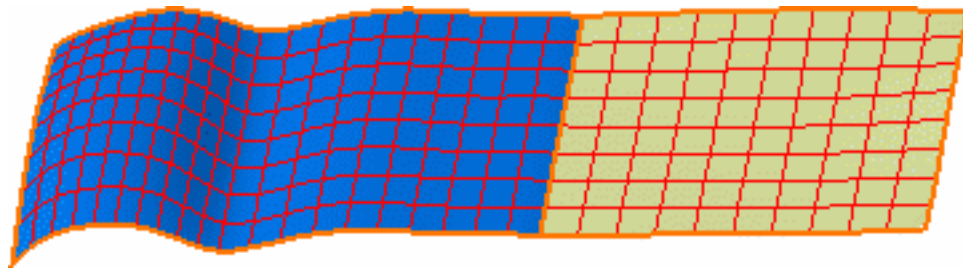

- If the selected surfaces are not connex (if there is an important gap between the two surfaces) the **Apply** button is grayed, and you cannot create the concatenated surface.
- If the selected elements present a curvature discontinuity you will need to increase the tolerance value accordingly.
In this case too, the maximum deviation will increase considerably.



Available capabilities from the Dashboard are: [datum creation](#), [keep original](#), and [furtive display](#).



Fragmenting Surfaces



In this task you will learn how to fragment multi-segment bodies into mono-segment bodies.



Open the [FragmentSurface1.CATPart](#) document.



1. Select the surface.

2. Click the **Fragmentation** icon  in the Shape Modification toolbar.

The selected surface shows the limits of each segment in solid lines, allowing the pre-visualization of the resulting surfaces.

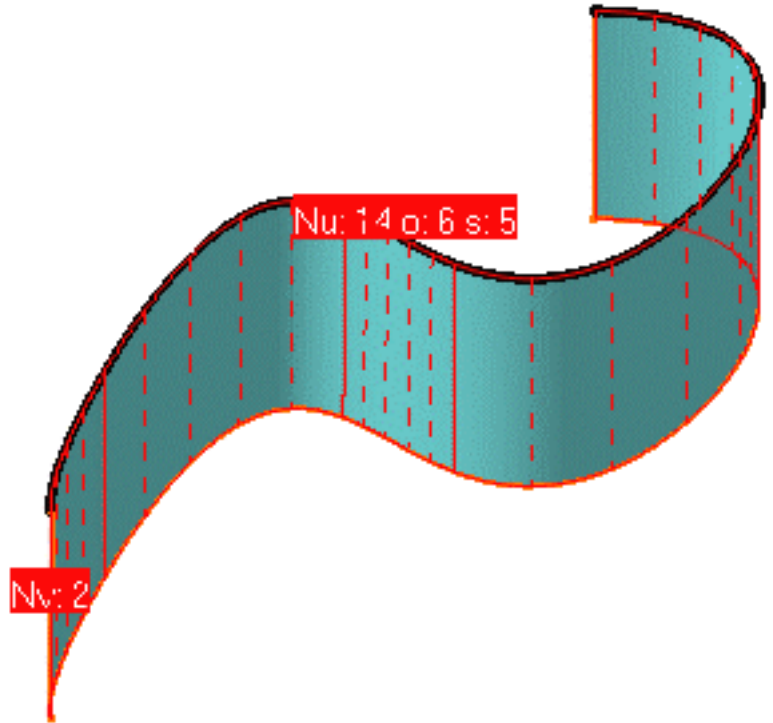

The Fragmentation dialog box is displayed.

3. Choose the breaking options:

You can decide to break the surface along U, along V or in both U and V directions.

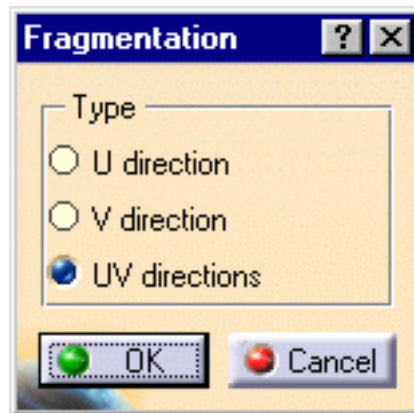

4. Click the **Keep original** icon  from the Dashboard if you want to keep the initial surface when fragmenting the body.

5. Click OK.

The surface is fragmented in as many surfaces as there were segments in the initial surface. This means that independent surfaces are created.

In the example, we assigned a different color to each of the resulting mono-segment surfaces.



- Multi-selection is available.
- This function enables you to fragment curves as well (see [Fragmenting Curves](#)).



Available capabilities from the Dashboard are: [datum creation](#), [keep original](#).



Disassembling Elements



In this task you will learn how to disassemble multi-cell bodies into mono-cell, or mono-domain bodies, whether curves or surfaces.



Open the [Disassembling1.CATPart](#) document, or any document containing a multi-cell body.



1. Select the element to be disassembled.

You can select only an edge of a surface, the system recognizes the whole element to be disassembled.



Here we selected the join made of three elements, each made of several cells.

2. Click the **Disassemble** icon  in the Shape Modification toolbar.

The Disassemble dialog box is displayed.

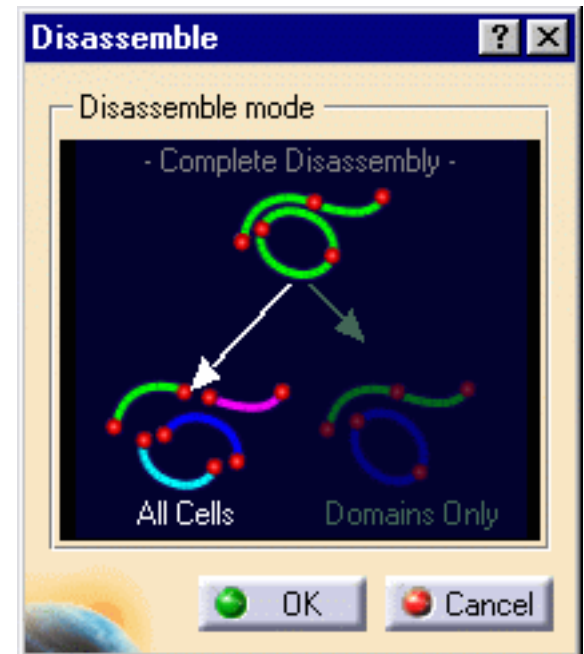

3. Choose the disassembling mode:

- **All Cells:** all cells are disassembled, i.e. for all the selected element, a separate curve is created for each cell.
- **Domains Only:** elements are partially disassembled, i.e. each element is kept as a whole if its cells are connex, but is not decomposed in separate cells. A resulting element can be made of several cells.

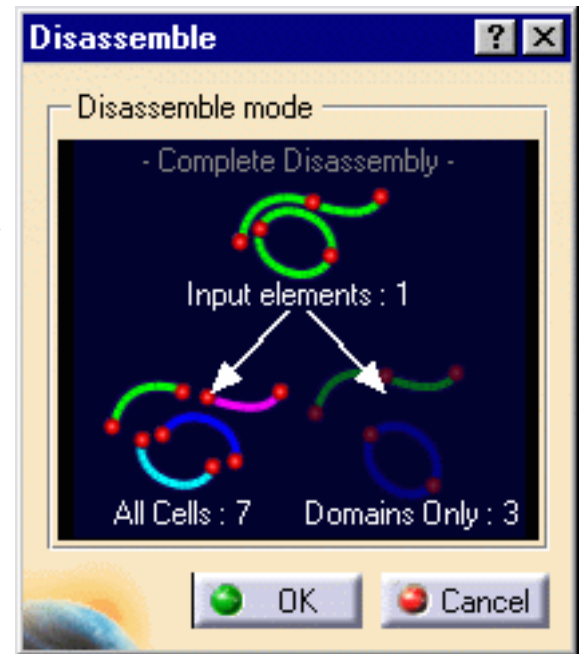

The number of selected elements, and the number of elements to be created according to the disassembling mode are displayed within the Disassemble dialog box.

In the illustrations, we have colored the resulting curves for better identification.

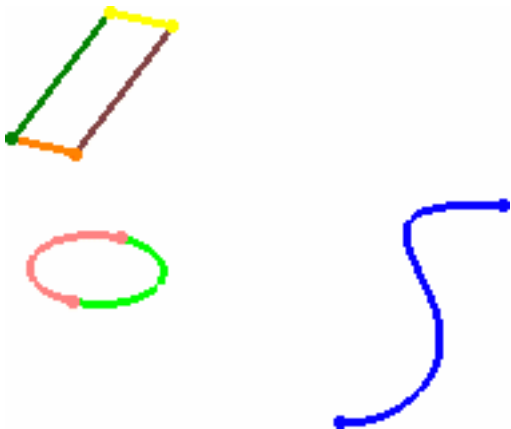

*Results when disassembling all cells
(seven curves are created)*

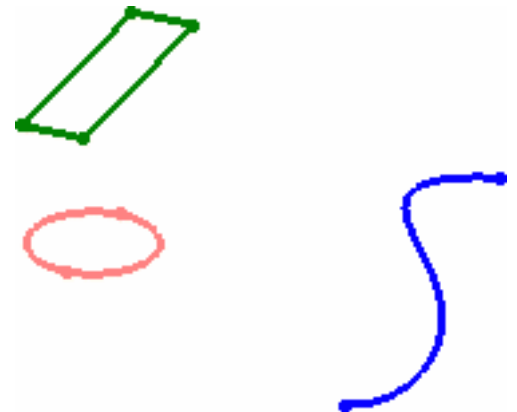

*Results when disassembling domains only
(three curves are created)*

If you wish to create the disassembled elements in a new geometrical set instead of the current geometrical set, click the **Insert In a New Geometrical Set**  icon from the FreeStyle Dashboard.

4. Click OK in the dialog box.

In case of a multi-selection, a progression bar appears, displaying the name of the element being disassembled.

It automatically disappears once the operation is complete (progression at 100%).

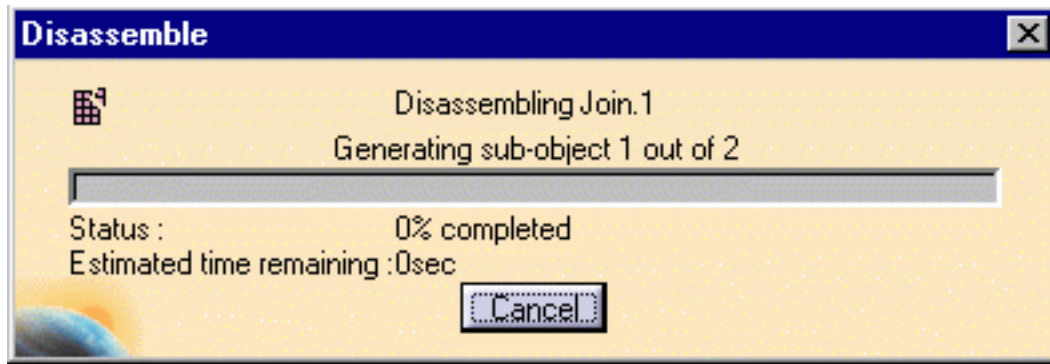

The selected element is disassembled, that is to say independent elements are created, that can be manipulated independently.



Multi-selection is available.



Capabilities available from the FreeStyle Dashboard are [datum creation](#) and [insert in a new geometrical set](#).



Approximating/Segmenting Procedural Surfaces



In this task you will learn how to convert any surface, created using other products but FreeStyle, into a NUPBS (Non Uniform Polynomial B-Spline) surface, and to modify the number of patches (segments) onto any surface, including these created using FreeStyle products.

This approximation is automatically performed when you try to edit a surface using control points. In this case:

- when an exact conversion can be performed, it is done automatically, and the Converter Wizard is not displayed.
- when the exact conversion cannot be performed, the converter Wizard is displayed allowing you to define the approximation tolerance.



Open the [Approximate1.CATPart](#) document.



1. Select the surface to be approximated or segmented.
2. Click the **Converter Wizard** icon



The **Converter Wizard** dialog box is displayed allowing you to define the approximation according to a tolerance.

You need to set the values for the different options:

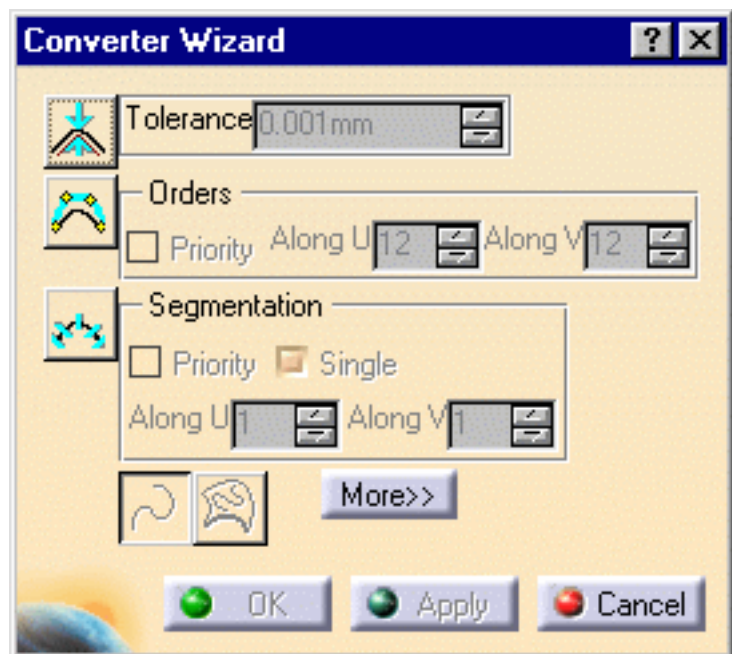

- **Tolerance:** that is the deviation tolerance from the initial surface. On the geometry, a red text is displayed if the tolerance is not respected, that changes to green when the new element is within the specified tolerance.
- **Order:** that is the maximum allowed order along the U and V directions for each surface patch. This value must be greater than or equal to 2, in a given direction, when the segmentation options are grayed. Otherwise, it must be greater than or equal to 4. The maximum value allowed per patch is defined by the [Max order](#) field in the FreeStyle Settings and must be less than or equal to 16.



In P1 mode, the **Max order** is set to 16 and cannot be modified.

- **Segmentation:** that is the maximum allowed segments along the U and V directions.
If **Single** is checked, a mono-segment surface is created.

When one of these options is inactive, the system automatically optimizes this option's parameters to comply with the other options' values.

On the selected surfaces, segments are delimited by the solid lines.

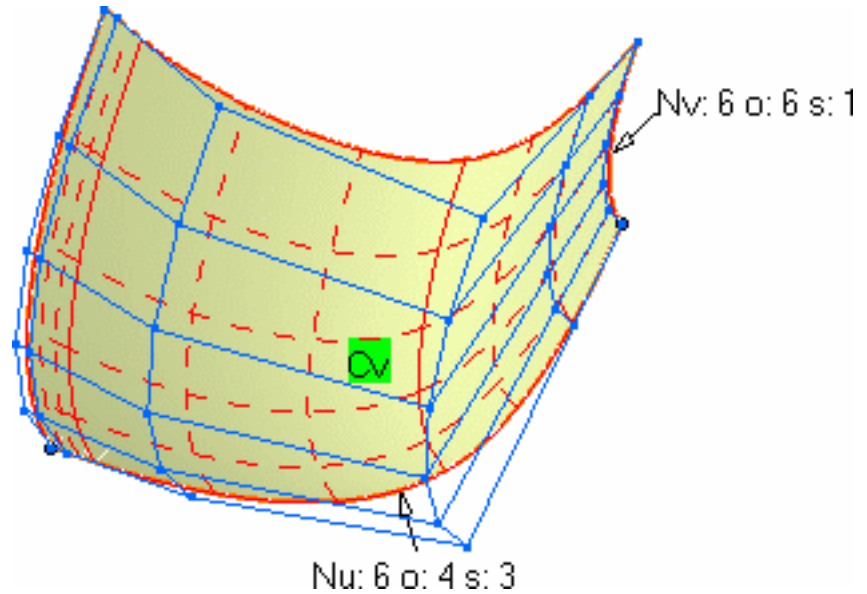

Depending on the type of the initial element, a text is displayed indicating what approximation needs to be performed:

- **CV:** the initial surface is not a NUPBS and needs to be approximated using the Converter Wizard parameters
- **EXACT:** the initial surface can be converted in exact mode (no parameter needs to be set)
- **Seg:** the initial surface already is a NUPBS

Provided the **Continuity** icon  is active from the Dashboard, and at least one conversion option is active (**Tolerance**, **Orders**, or **Segmentation**), a continuity constraint can be imposed identically on the selected surfaces.

- Continuities constraints are applied on the bounding box UV of each cell. Therefore, boundaries are isoparametrics to the selected surfaces.
- One type of continuity can be imposed for each cell of an element; in case of multi-cell elements, every cell has the same continuity constraint.
- Use the contextual menu to select another continuity (point, tangent, or curvature continuity) or click the text in the geometry to display the others sequentially.

If the continuity is certain to be respected (if the order value is sufficient and there is no segmentation constraint), the continuity tags are displayed in green.

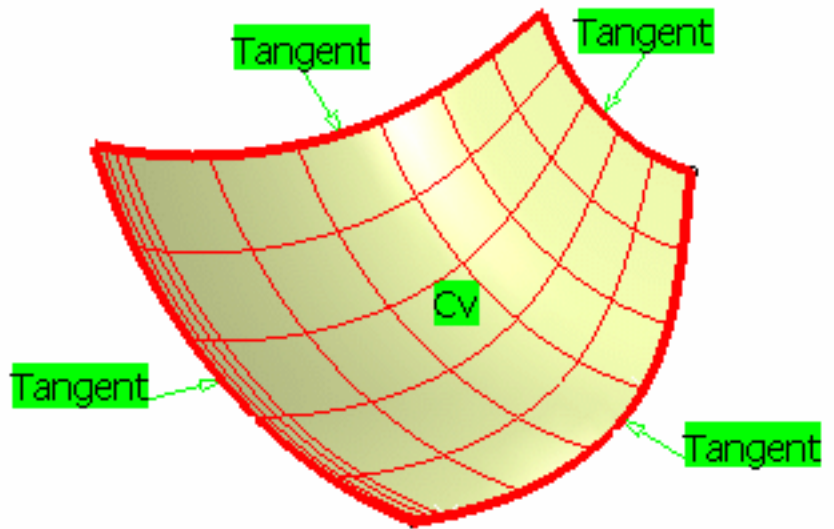

If the continuity constraint may be not respected, a warning is issued and the continuity tags are displayed with the update needed color (here in red) defined in **Tools -> Options -> Visualization**.

Note that this warning is displayed for information purpose and does not check whether the continuity will be respected or not.

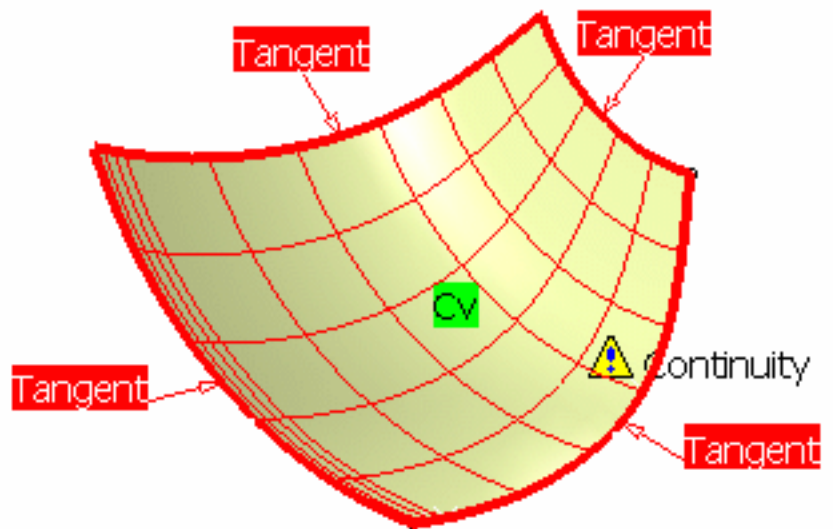

3. Click **More>>** to display more options :

- Check the **Information** option to display further information on the element:
 - **Max**: the maximum deviation in relation to the initial element
 - **Nu/Nv**: number of control points in U and V
 - **o**: the surface order
 - **s**: the number of segments in the surface
- Check the **Control Points** option to display the surface's control points.

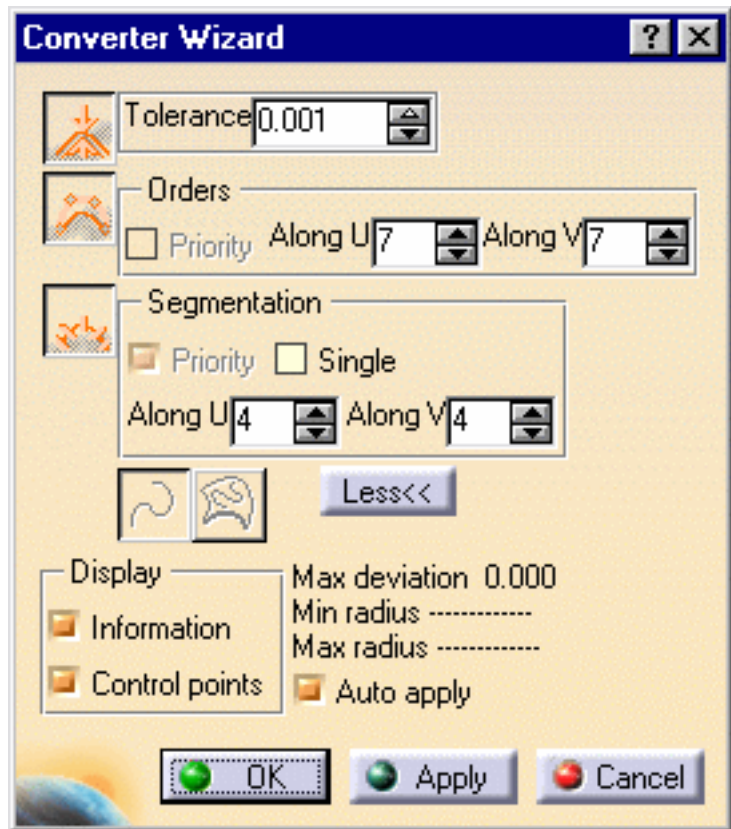

- Check the **Auto apply** button to dynamically update the resulting surface.

4. Click **OK**.

The surface modification is taken into account.



- Surface multi-selection is available.
- You can mix the approximation of curves and surfaces.
- The **3D conversion** and **2D** icons are grayed as they are useful only for curve conversion.
- The **Priority** check button indicates which of the Orders or Segmentation parameter is taking precedence over the other one.
- Use the **Exact** conversion mode (no parameter needs to be set) on a NUPBS element to display the number of control points, curve order, and number of segments in the curve. Note that in this case, the initial element is duplicated.



Available capabilities from the Dashboard are: [datum creation](#), [keep original](#) (depending on the selected element), [continuities](#), and [furtive display](#).



Copying Geometric Parameters

 This task shows you how to copy the geometric parameters of a curve on one or several curves.

 Open the [CopyParameters1.CATPart](#) document.

Make sure the [furtive display](#) is active from the FreeStyle Dashboard.

 **1. Click the Copy Geometric Parameters icon** .

The Copy Geometric Parameters dialog box displays.

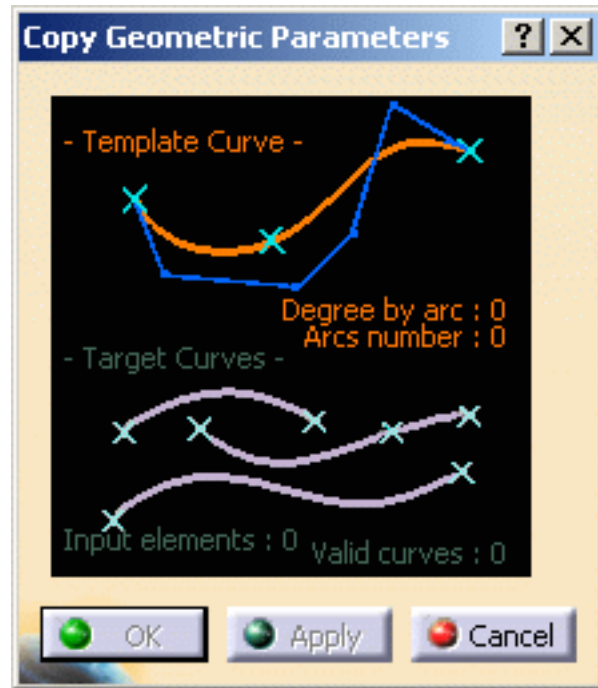

2. Select the curve that will be used as the template curve.

Control points and segmentation parameters display on the curve.

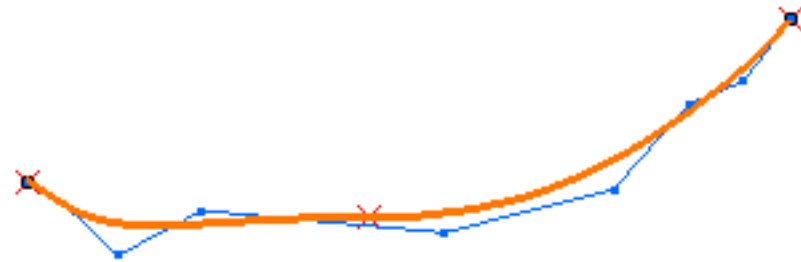

3. Select one or more target curves.

Control points and segmentation parameters also display: you can see that they are different from those of the target curve.

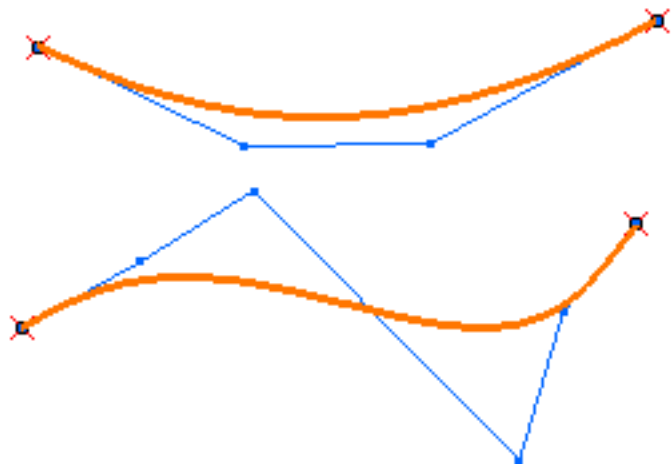

- Click **Apply** to copy the parameters of the template curve on the target curves.

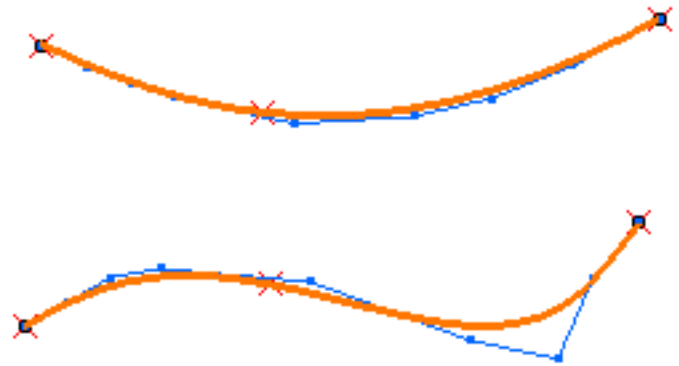

The Copy Geometric Parameters dialog box updates:

For the template curve, it shows:

- **Degree by arc:** number of control points
- **Arcs number:** number of segments

For the target curves, it shows:

- **Input elements:** number of selected elements
- **Valid curves:** number of curves taken into account

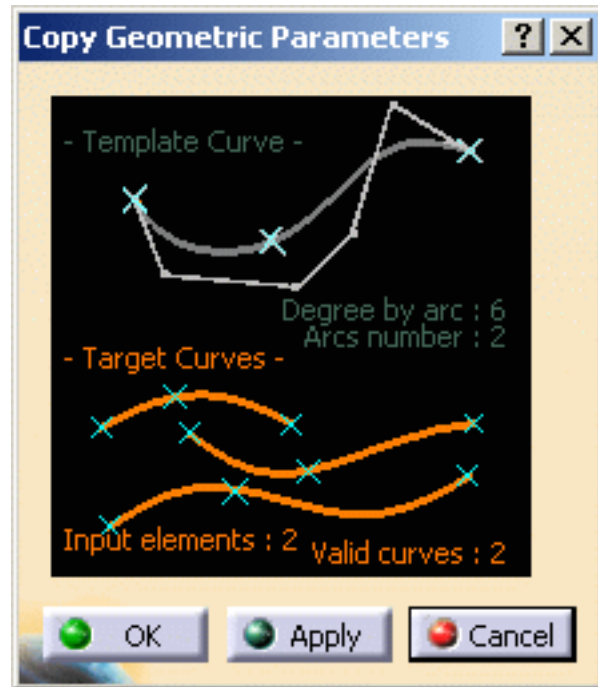

- Click **OK**.

 While in the command, you can change the template curve still keeping the selected target curves: simply click the Template Curve area in the Copy Geometric Parameters dialog box, select the curve, and click Apply to copy the parameters.

 Only datum and 3D datum curves can be used.

 Capabilities available from the FreeStyle Dashboard are [insert in a new geometrical set](#) and [furtive display](#).



Creating a Continuity Constraint



This task shows you how to create a FreeStyle continuity constraint, that is to connect two or more surfaces or curves and apply a constraint.



Open the [Constraint1.CATPart](#) document.



Make sure the **Constraints** option is checked in **Tools -> Options -> Infrastructure -> Part Infrastructure -> Display** tab, so that you are able to see the constraints in the specification tree.



1. Click the **Continuity**

Constraint icon



The Continuity constraint dialog box displays.

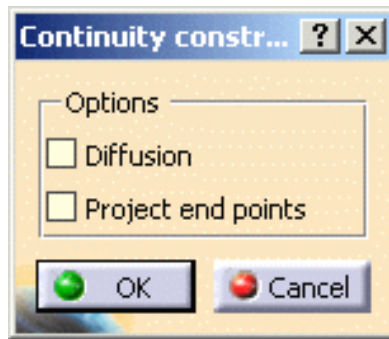

2. Select the edge of the surface to be matched.

The boundary is highlighted.

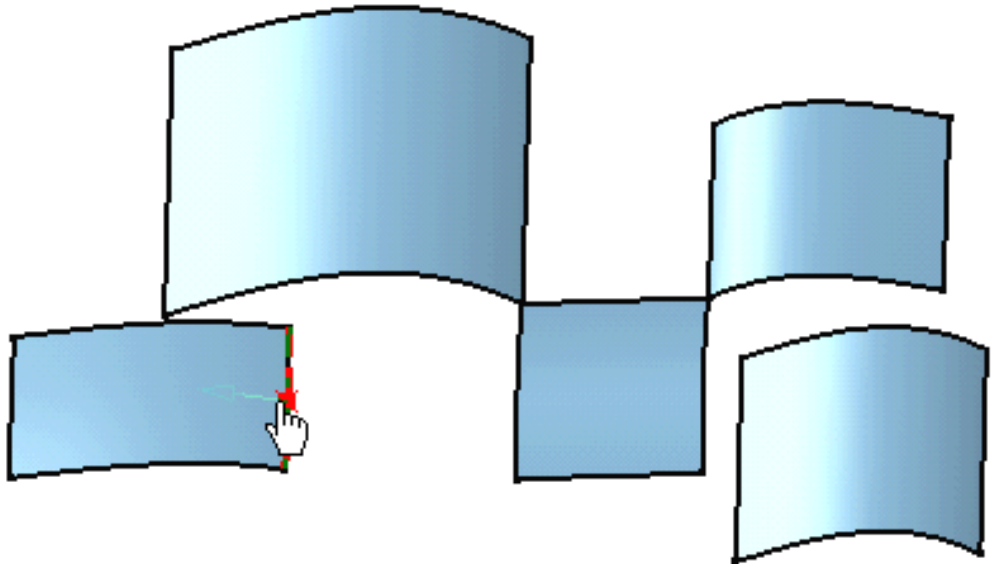

3. Move the pointer onto the second surface.

4. Click the surface when the adequate boundary is highlighted.

5. Perform this operation onto several surfaces.

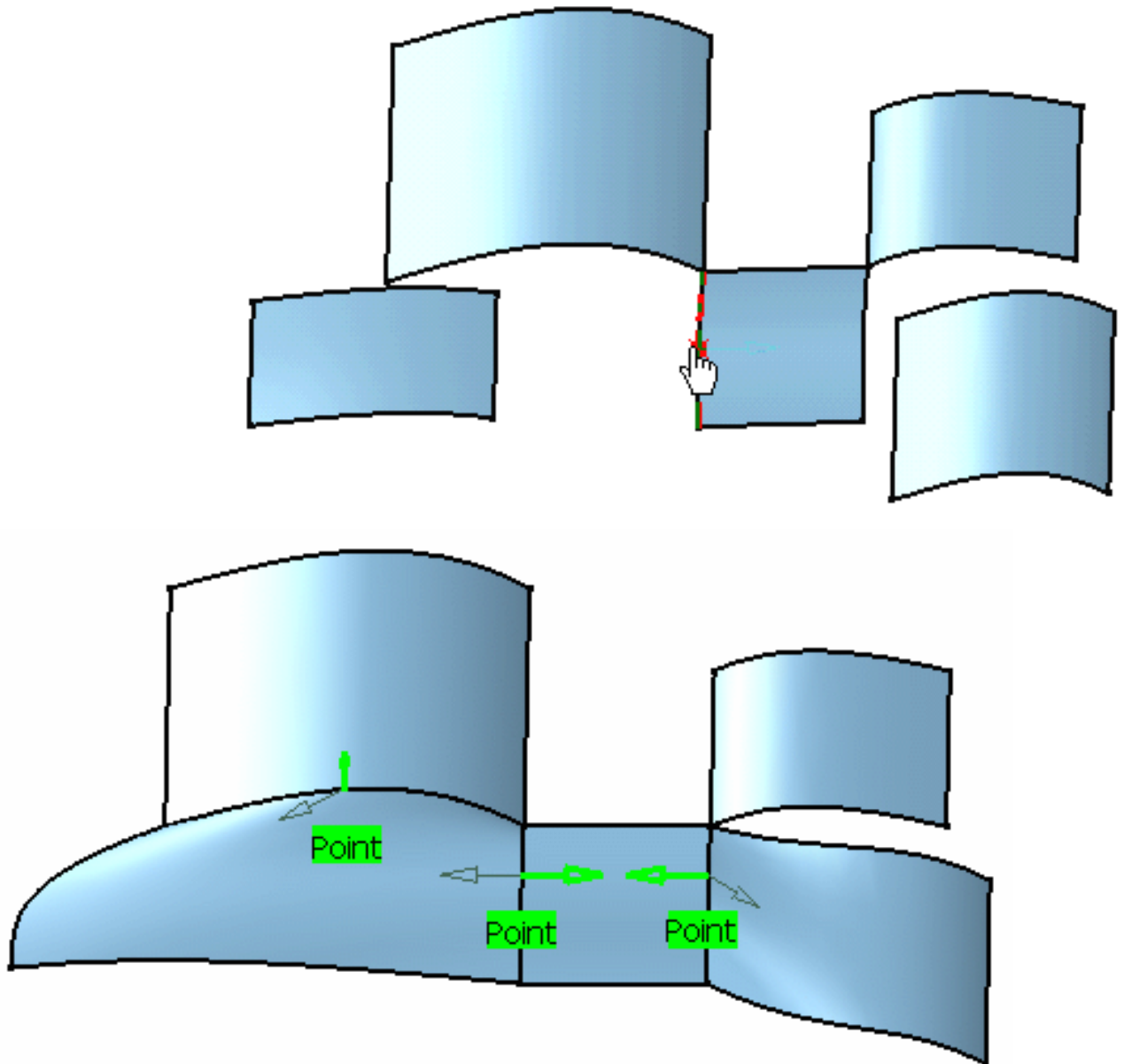

6. Right-click the continuity type to display the contextual menu: you are able to modify the chosen type.

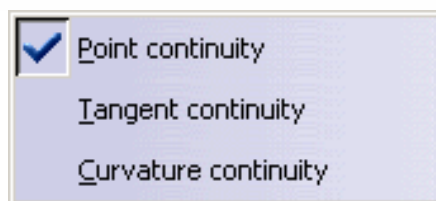

Two options are available from the dialog box. May you want to use them, you need to select them before selecting the surfaces or curves.

- **Diffusion**: the **Diffusion** option propagates evenly any modification performed using the control points
- **Project end points**: The **Project end points** option allows linear projection of the smaller edge, if selected first, onto the smaller surface.

7. Click the green arrow to reverse the direction of the constraint and modify the continuity.
8. Click the text in the geometry to modify the constraint sequentially or use the contextual menu and select the constraint.

The continuity constraint feature appears in the specification tree, under the Constraints node.

9. Check the **Control Points** option to display the control points and mesh lines on the surface, allowing you to dynamically modify them.

See [Editing Surfaces Using Control Points](#) to find more about available options.

The source surface deforms so that the neighbouring constraints are automatically updated..

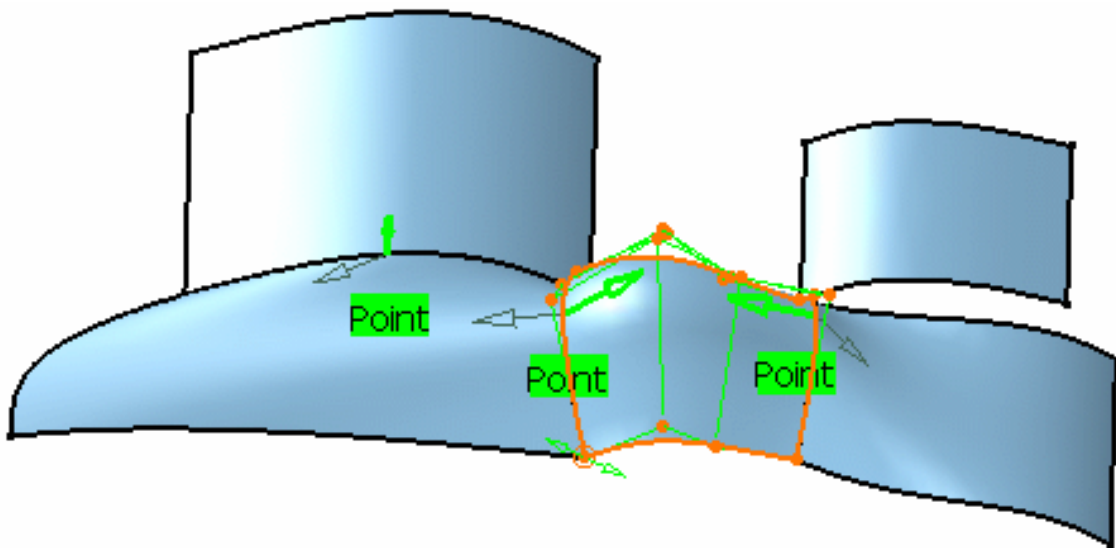

- You can create as many constraints as there are elements.
- You can deactivate the constraints using the Deactivate contextual menu.
- Constraints created using this command are very similar to the constraints created in the Part Design and the Sketcher workbenches: they are compatible and are solved using a variational approach.

1. In Part Design, select a vertex and a point, click the **Constraints defined in a dialog box** icon and set a Distance constraint.

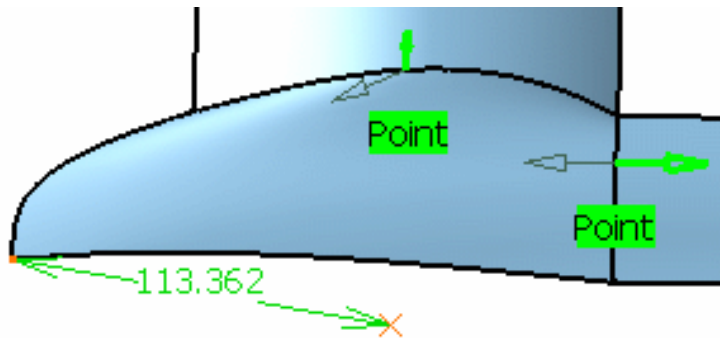

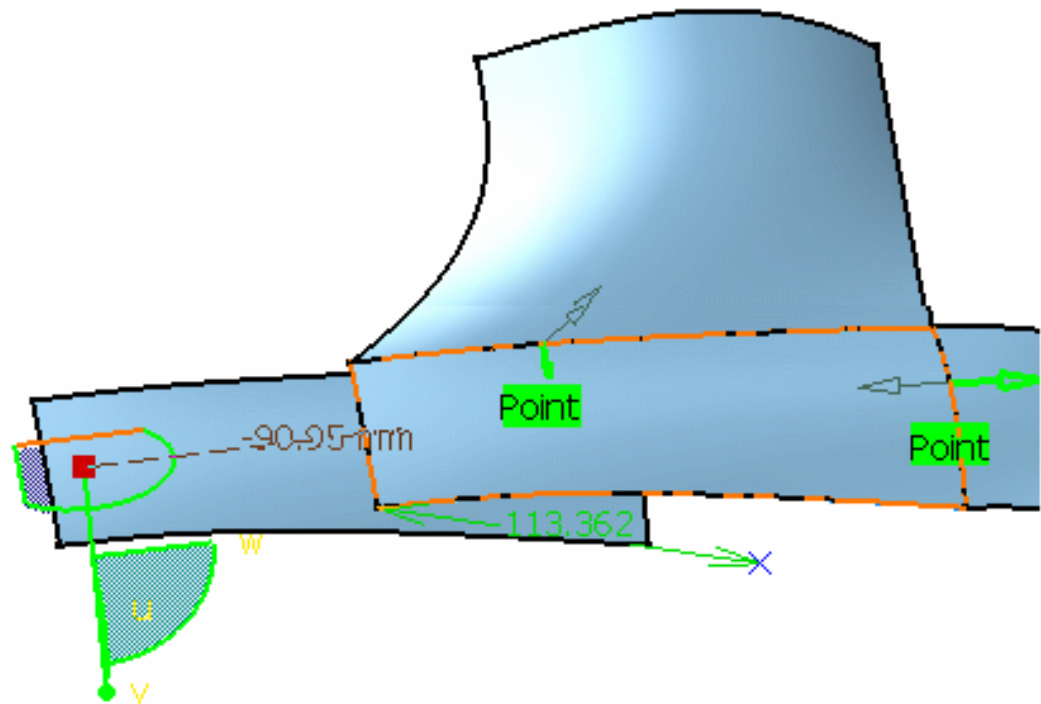

2. Back in FreeStyle, using the **Quick Compass Orientation** toolbar, click the **In Model or on Perch** icon  to switch the compass from the perch to the selected surface.
3. Use the compass to move the surface.

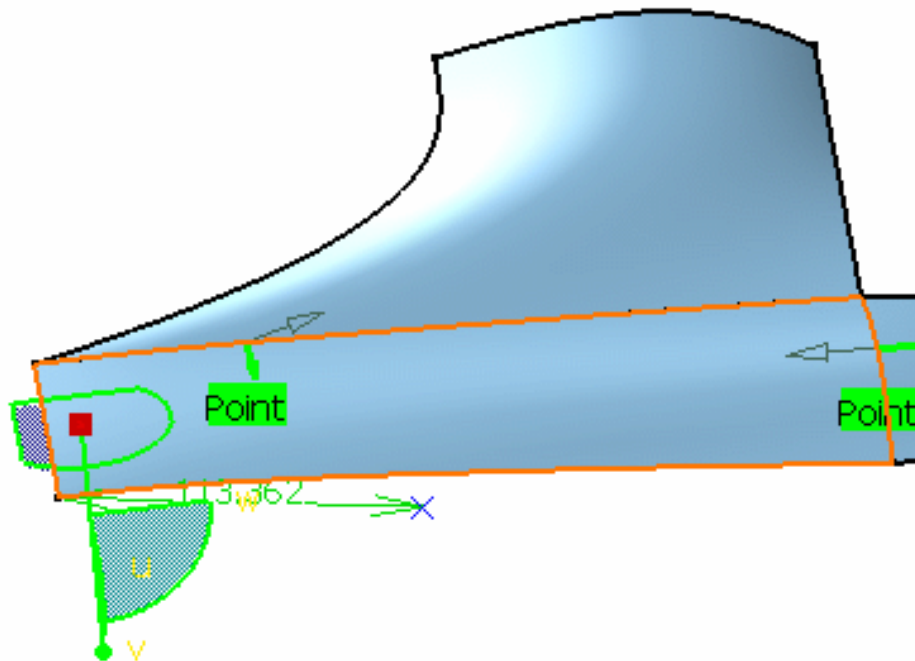

All the constraints are updated accordingly.



-  If you wish to delete a constraint, you need to delete it in the specification tree, under the Constraints node.
-  Refer to the Constraints chapter in the *Part Design* documentation and to the Setting Constraints chapter in the *Sketcher* documentation to have further information.
-  Constraints can only be set on **datum** elements.



This chapter deals with curve and surface analysis. Within the FreeStyle Shaper, analyses are elements that need to be explicitly deleted if you do not wish to keep them.

The FreeStyle Dashboard tools do not affect the analyses.

Most analyses are permanent in P2 mode only, i.e. they are retained in the specification tree for later edition and on the geometry till you reset or delete them, whereas in P1 mode, they are present at a time, but not retained when exiting the command.



Check connections between surfaces: select two surfaces, specify the type of analysis (distance, tangency, curvature) and set the analysis parameters.



Check connections between curves: select two curves, specify the type of analysis (distance, tangency, curvature) and set the analysis parameters.



Analyze the distance between two sets of elements: select a surface and a target element, specify the analysis mode, type, and display parameters.



Use dynamic cutting planes: select a surface, specify the cutting planes orientation, numbers, spacing, etc.



Analyze using highlight lines: select a surface, and specify the highlight type.



Perform a curvature analysis: select a curve or surface boundary, specify the curvature comb parameters (spikes number and length, orientation, etc.).



Perform a surfacic curvature analysis: select a surface and specify the display parameters.



Perform a draft analysis: select a surface and specify the display parameters.



Map an environment on a surface: choose the mapping to be reflected onto every element.



Analyze using isophotes: specify the isophotes number, thickness, color, and position.



Analyze using highlights: click the ACA Highlight icon and define stripes or grid lines density, thickness and sharpness.

Checking Connections Between Surfaces

P2



This task shows how to analyze how two surfaces are connected, following a blend, match, or fill operation for example.

Three types of analyses are available.

- **Distance:** the values are expressed in millimeters
- **Tangency:** the values are expressed in degrees
- **Curvature:** the values are expressed in percentage.



Open the [ConnectChecker1.CATPart](#) document.



1. Select both surfaces to be analyzed.

2. Click the **Connect Checker** icon



in the Shape Analysis toolbar.

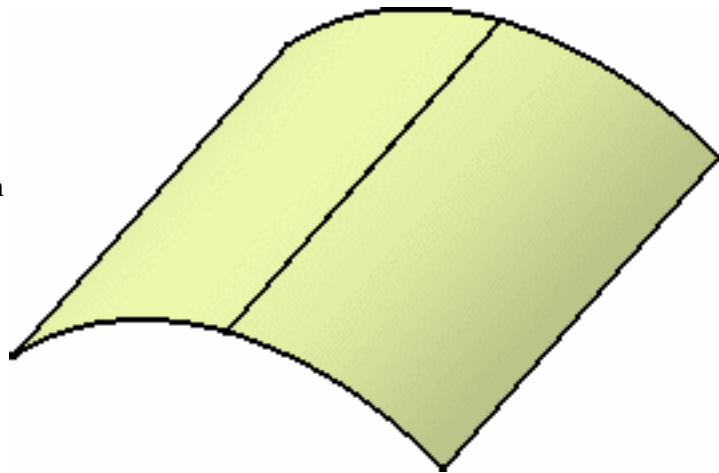

The Connect Checker dialog box is displayed as well as another dialog box showing the color scale and identifying the maximum and minimum values for the analysis type.

The **Auto Min Max** button enables to automatically update the minimum and maximum values (and consequently all values between) each time they are modified.

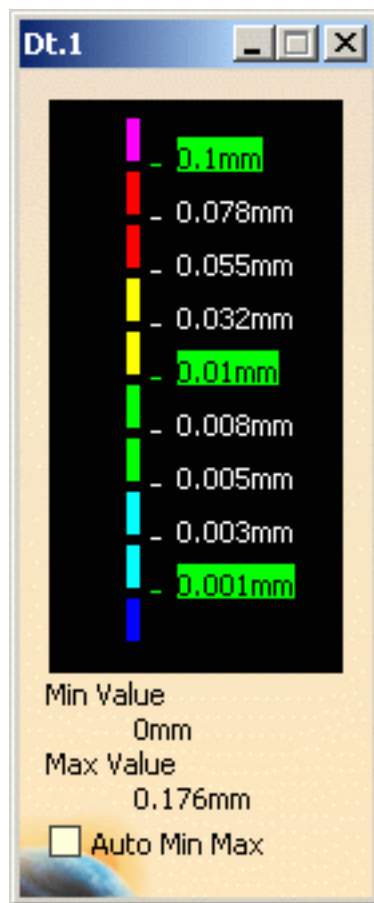
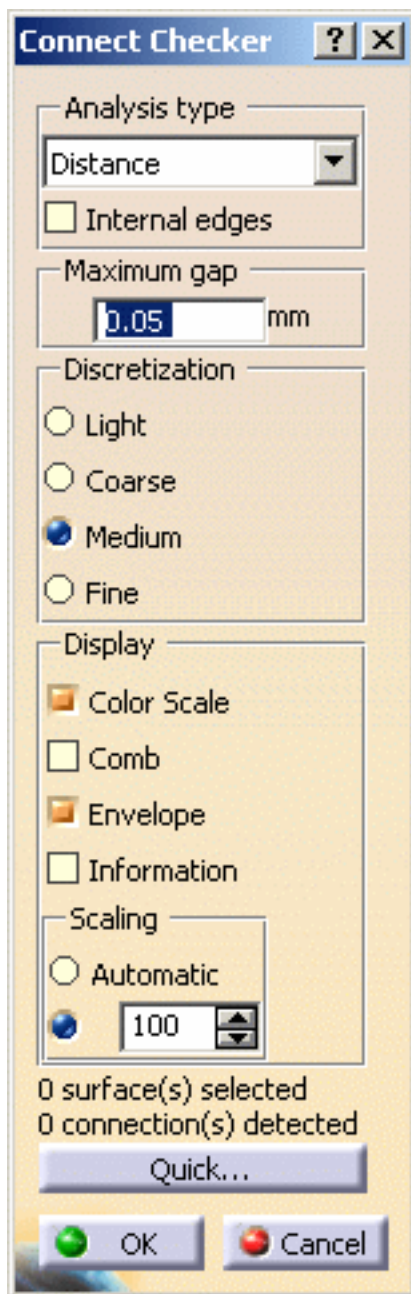

Check the Internal edges option if you want to analyze the internal connections. By default, the check box is unchecked.

3. Choose the analysis type to be performed: **Distance**, **Tangency** or **Curvature**.
4. Set the **Maximum gap** above which no analysis will be performed. All elements apart from a greater value than specified in this field are considered as not being connected, therefore do not need to be analyzed.

Be careful not to set a **Maximum gap** greater than the size of the smallest surface present in the document.

5. Check the analysis results on the geometry.

Here we are analyzing the distance between the surfaces. Each color section indicates on the geometry the distance between the surfaces.

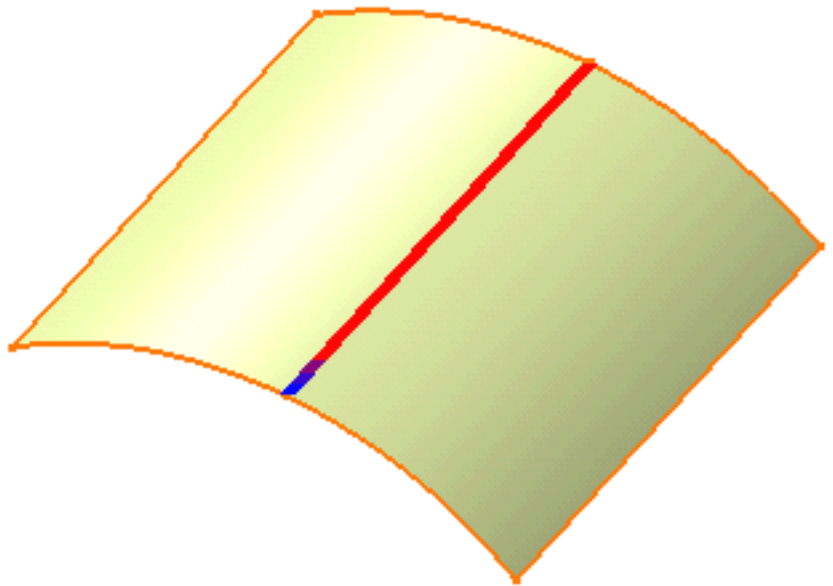

From the Connect Checker dialog box, you can choose a number of visualization and computation options:

- the **comb**: that is the spikes corresponding to the distance in each point
- the **envelope**: that is the curve connecting all spikes together
- **Information**: that is the minimum and maximum values

Finally, the scaling option lets you define the visualization of the comb. In automatic mode the comb size is zoom-independent and always visible on the screen, otherwise you can define a coefficient multiplying the comb exact value.

6. Check the **Information** button:

Two texts are displayed on the geometry localizing the minimum and maximum values of the analysis as given in the Connect Checker dialog box.

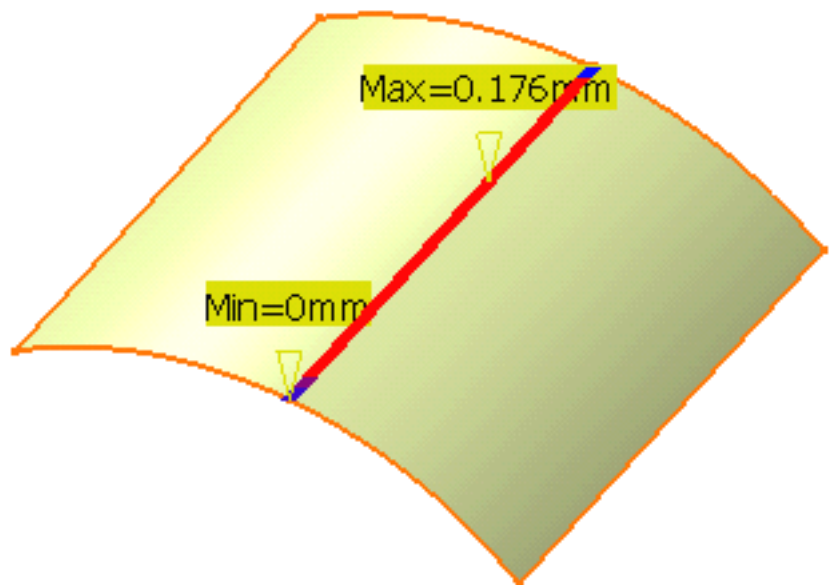

You can also choose the discretization, that is the numbers of spikes in the comb (check the **Comb** option to see the difference). The number of spikes corresponds to the number of points used for the computation:



- **Light:** 5 spikes are displayed.

This mode enables to obtain consistent results with the visualization of sharp edges. An edge is considered as sharp if its tangency deviation is higher than 0.5 degree. To only detect tangency deviations on sharp edges, specify a deviation of 0.5 degree minimum.

To visualize sharp edges, make sure the **View -> Render Style -> Shading with Edges and Hidden Edges** option is checked.

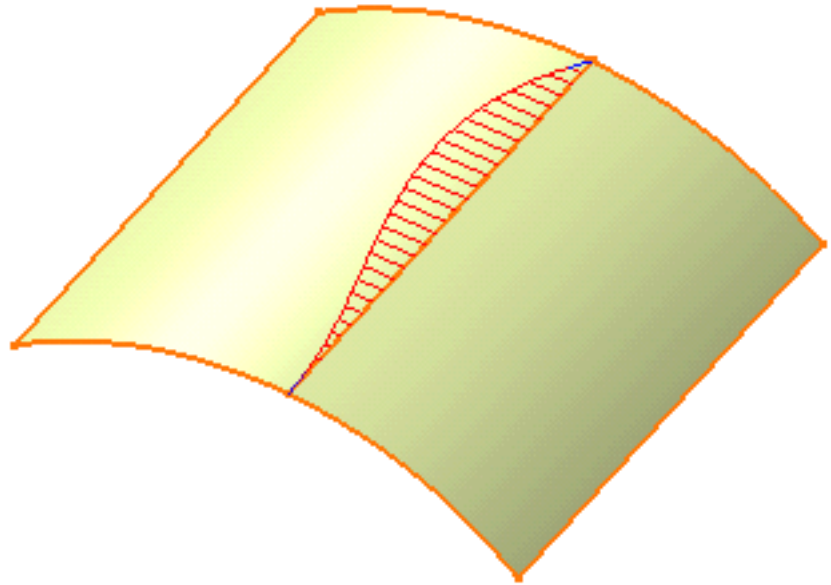

- **Coarse:** 15 spikes are displayed
- **Medium:** 30 spikes are displayed
- **Fine:** 45 spikes are displayed



The Full result is only available with the Generative Shape Design 2 product.

The number of selected elements and the number of detected connections are displayed below the color range.

7. Click the **Quick...** button to obtain a simplified analysis taking into account tolerances (either distance, tangency, or curvature).

The comb is no longer displayed.

The Connect Checker dialog box changes to this dialog box.

You can use the check button to switch from one analysis type to another.

The **Maximum gap** and information are retained from the full analysis.

The maximum deviation value is also displayed on the geometry.

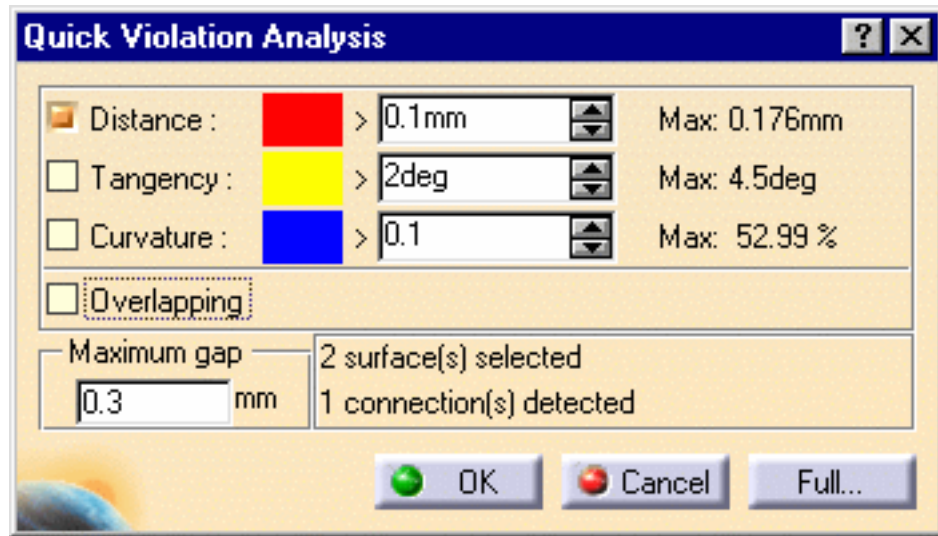

You can check the **Overlapping** button to highlight where, on the common boundary, the two surfaces overlap. In this case the other analysis types are deactivated.

P1 In P1 mode, only the quick analysis is available.

8. Use the spinners to define the deviation tolerances.

For example, the red area indicates all points that are distant of more than 0.1 mm.

The maximum deviation values on the current geometry are displayed to the right of the dialog box.

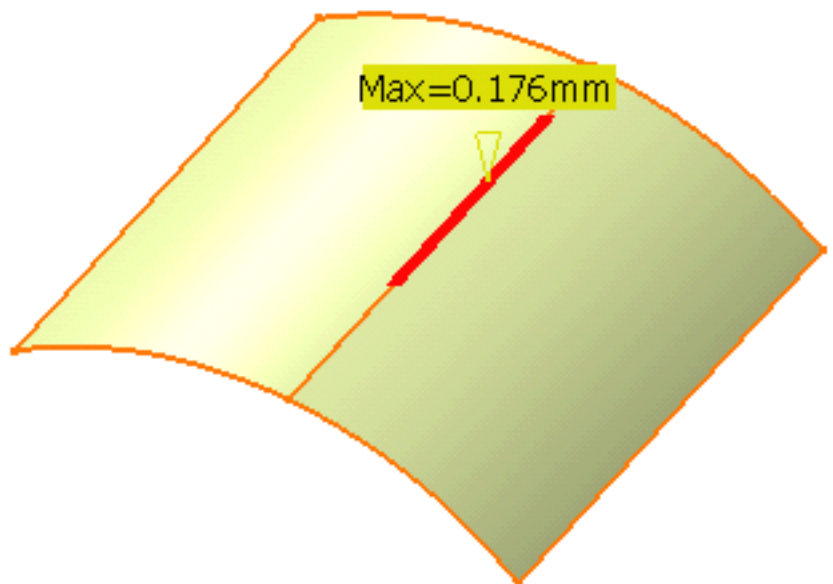

9. Click **OK** to create the analysis.

The analysis (identified as Surface Connection Analysis.x) is added to the specification tree (P2 only).

This allows the automatic update of the analysis when you modify any of the surfaces, using the control points for example.

If you do not wish to create the analysis, simply click **Cancel**.



- You can edit the color range in both dialog boxes by double-clicking the color range manipulators (Connect Checker) or color areas (Quick Violation Analysis) to display the **Color** chooser.
- If you wish to edit the Connection Analysis, simply double-click it from the specification tree.
- If you no longer need the Connection Analysis, right-click **Connection Analysis** in the specification tree, and choose **Delete**.
- The curvature difference is calculated with the following formula:

$$\frac{(|C2 - C1|)}{((|C1 + C2|) / 2)}$$

The result of this formula is between 0% et 200%.

- You can analyze internal edges of a surfacic element, such as a Join for example, by selecting only one of the initial elements:

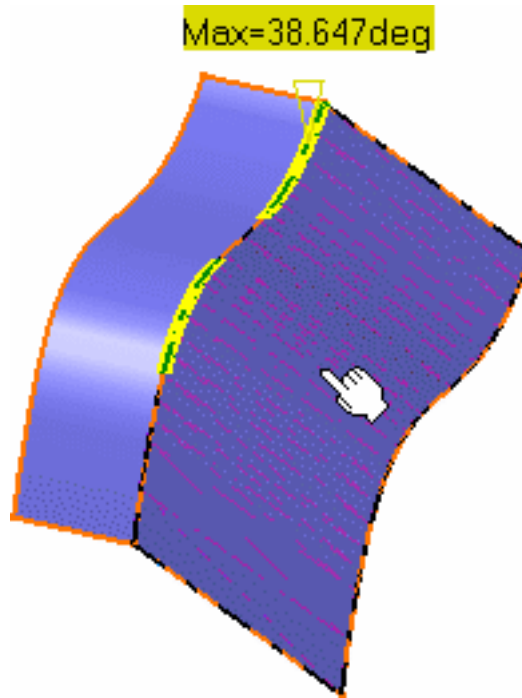

- You can create an analysis on an entire geometrical set simply by selecting it in the specification tree.



Checking Connections Between Curves



This task shows how to analyze how two curves are connected, following a blend, or match operation for example.

Four types of analyses are available.

- **Distance:** the values are expressed in millimeters
- **Tangency:** the values are expressed in degrees
- **Curvature:** the values are expressed in percentage
- **Overlapping:** the system detects overlapping curves



Open the [ConnectChecker2.CATPart](#) document.



1. Select both curves to be analyzed.

2. Click the **Curve Connect**

Checker icon  in the Shape Analysis toolbar.

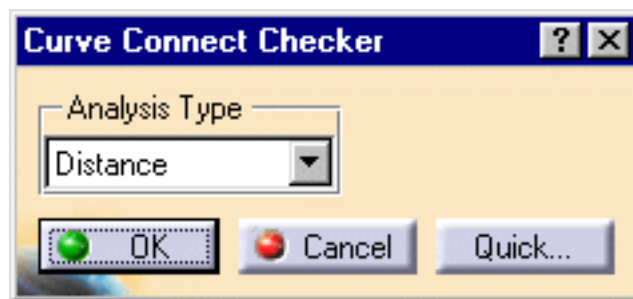

The Connect Checker dialog box is displayed. At the same time a text is displayed on the geometry, indicating the value of the connection deviation.

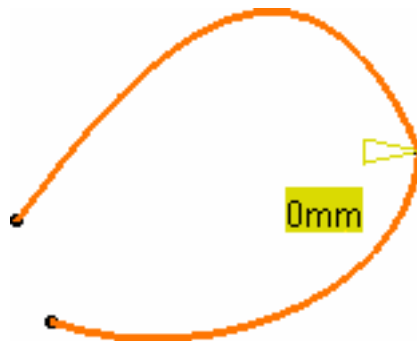

You can choose the type of analysis to be performed using the combo: distance, tangency or curvature.



In P1 mode, only this mode is available (no quick mode available).



P2 This step is P2 only for Wireframe and Surface.

3. Press the Quick button.

The dialog box changes along with the text on the geometry..

With our example, the text in the geometry disappears because the distance between the two curves is smaller than the set Distance value.

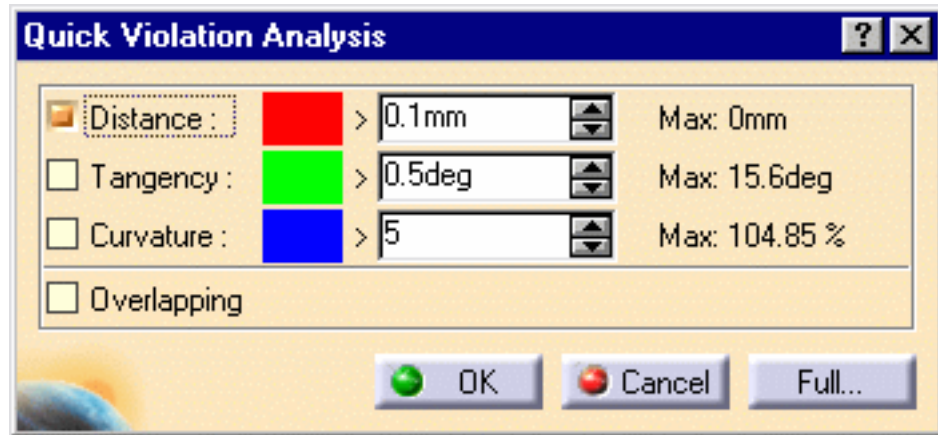

4. Check the **Tangency** button:

A text is displayed on a green background (as defined by default for the Tangency criterion) to indicate that the Tangency criterion is not respected, because the first text displayed is the one for which the set tolerance is not complied with. You can then increase the Tangency value, or modify the geometry to comply with your needs.

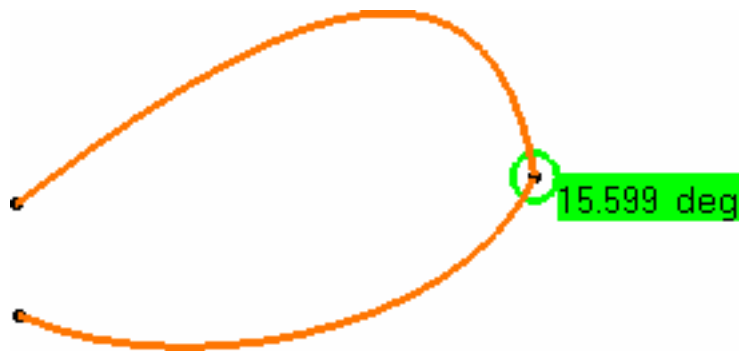

5. Similarly, if you check the **Curvature** value, the displayed text indicates that the curvature between the two analyzed curves is greater than the set value.

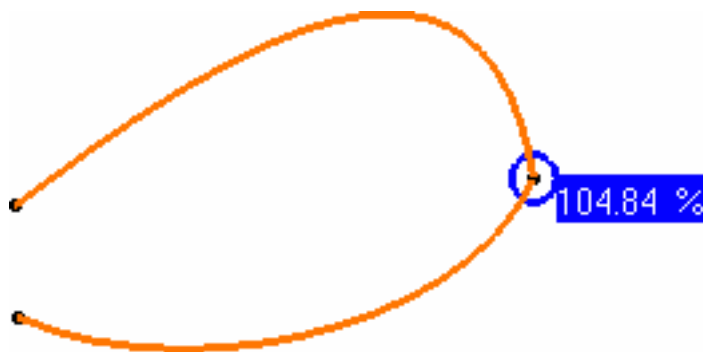

6. Modify the tolerance values, or the geometry to comply with the tolerances.

For example, if you modify the Tangency value to set it to 16 degrees, the geometry instantly reflects the compliance with the new value.

 The maximum deviation values on the current geometry are displayed to the right of the dialog box.

7. Click **OK** to create the analysis.

The analysis (identified as Curve Connection Analysis.x) is added to the specification tree.

This allows the automatic update of the analysis when you modify any of the curves, using the control points for example (see Editing Curves Using Control Points).

If you do not wish to create the analysis, simply click **Cancel**.

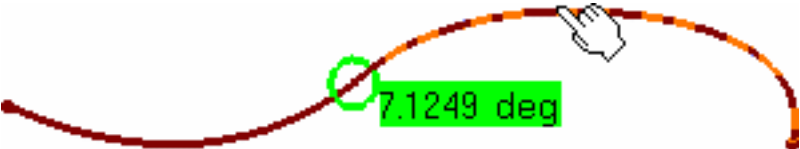
-  Double-click the Curve Connection Analysis from the specification tree to edit it.
- You can analyze internal edges of an element, such as a Join for example, by selecting only one of the initial elements:
 
- Use the **Overlapping** mode to highlight where, on the common boundary, the two curves overlap. When the **Overlapping** button is checked, other analysis types are deactivated. In Full mode, a text is displayed indicating whether the curves overlap.

 The **Overlapping** mode is not available with the Wireframe and Surface product.

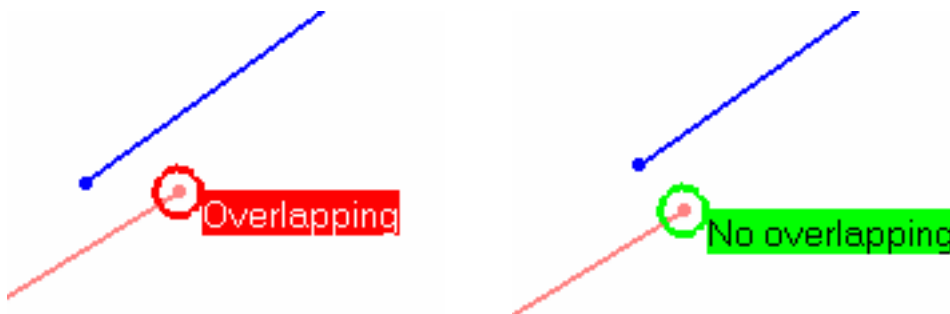

- The curve connection checking analysis is permanent in P2 mode only, i.e. it is retained in the specification tree for later edition and on the geometry till you reset or delete it, whereas in P1 mode, it is present at a time, but not retained when exiting the command.



Performing a Curvature Analysis



This task shows how to analyze the curvature of curves, or surface boundaries.



Open the [Analysis1.CATPart](#) document.

When analyzing surface boundaries:

- if you select the surface, the analysis is performed on all its boundaries
- if you select a specific boundary, the analysis is performed only on this boundary.

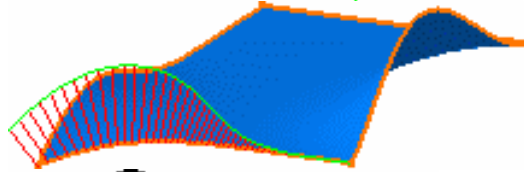
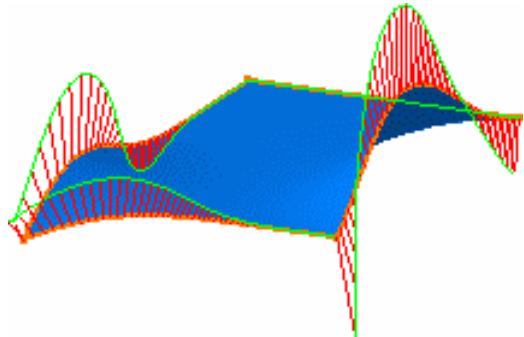

1. Click the **Porcupine Curvature Analysis** icon



2. Select the curve.

Automatically the curvature comb is displayed on the selected curve:

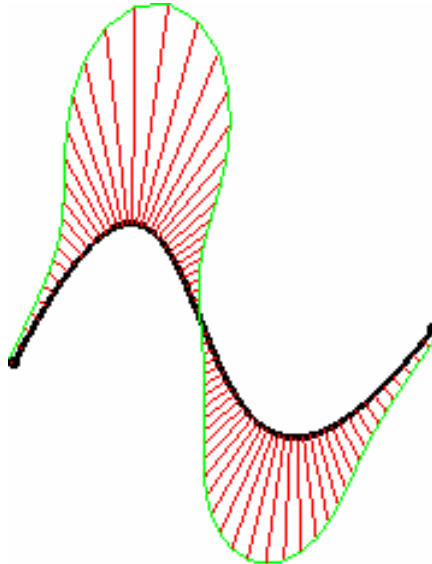

3. Define the analysis parameters in the Curvature Analysis dialog box.

- Use the **Project on Plane** checkbox to analyze the projected curve in the selected plane referenced by the compass.
- If you uncheck the **Project On Plane** option, the analysis is performed according to the curve orientation. This is the default option.

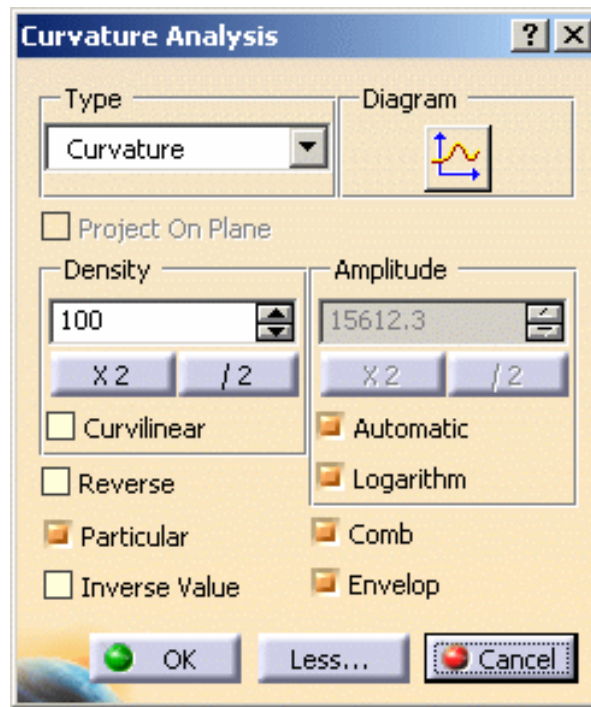

4. Use the spinners to adjust the number of strikes and modify the density.

5. You can also decide to halve the number of spikes in the comb clicking as many times as wished the **/2** button.

This option is particularly useful when the geometry is too dense to be read but the resulting curve may not be smooth enough for your analysis needs.

You could just as well double the number of spikes using the **X2** button.

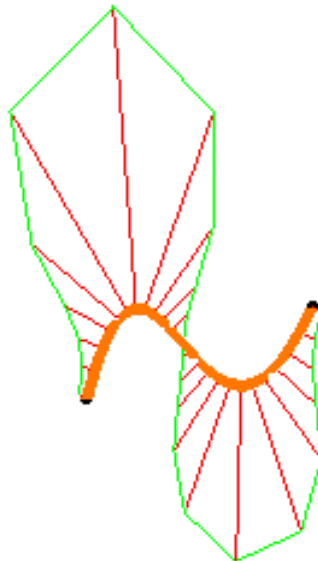

6. Similarly, click the $/2$ button to fine-tune the amplitude (size) of the spikes, and re-compute the analysis curve accordingly.

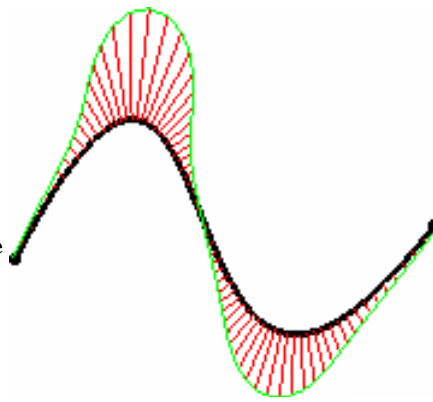

7. Click **Curvilinear** to switch from the Parametric discretization mode to the Curvilinear analysis. You will get something like this:

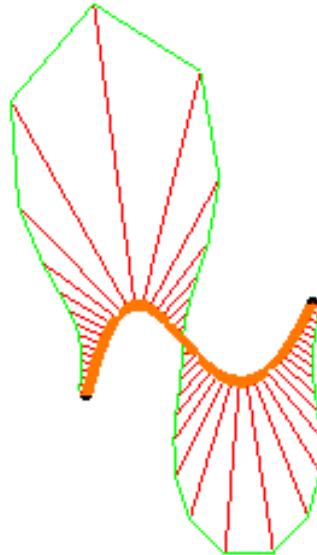

8. Check the **Automatic** option optimizes the spikes length so that even when zooming in or out, the spikes are always visible.

9. Check the **Logarithm** option to display the logarithmic values in the 3D geometry.

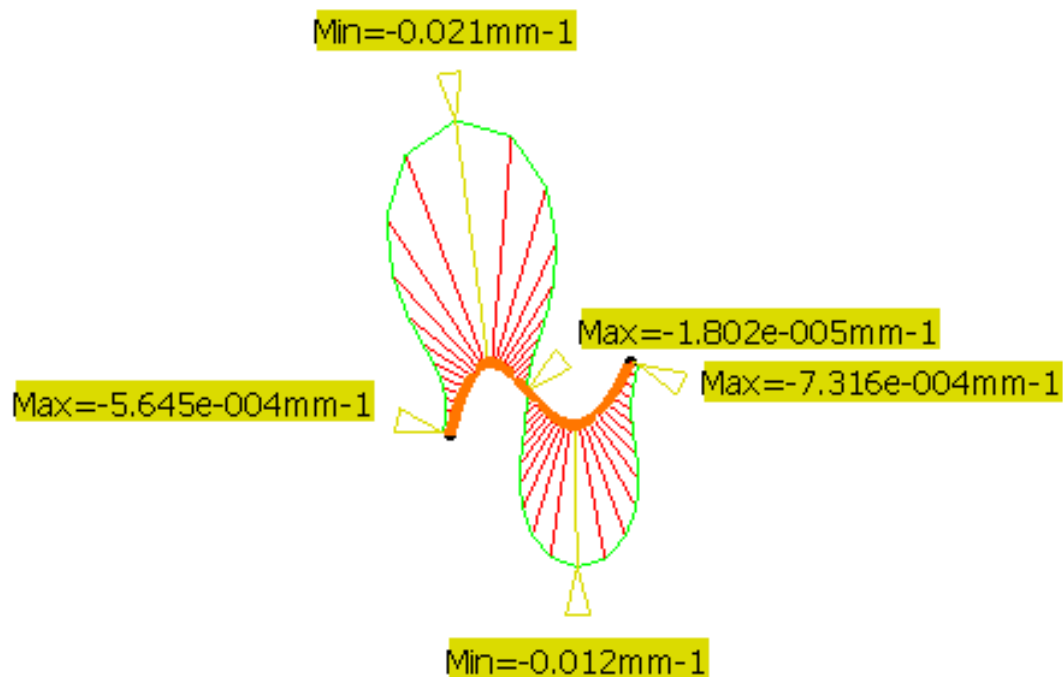

Displaying these values does not modify the analysis.

10. Click **Reverse**, you will get something like this:

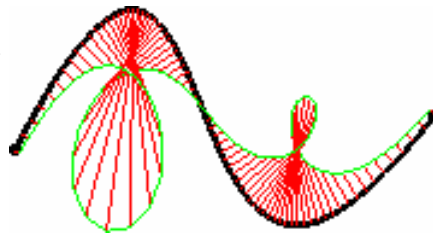

That is the analysis opposite to what was initially displayed. This is useful when from the current viewpoint, you do not know how the curve is oriented.

11. Use the **Particular** checkbox to display at anytime the minimum and the maximum points.

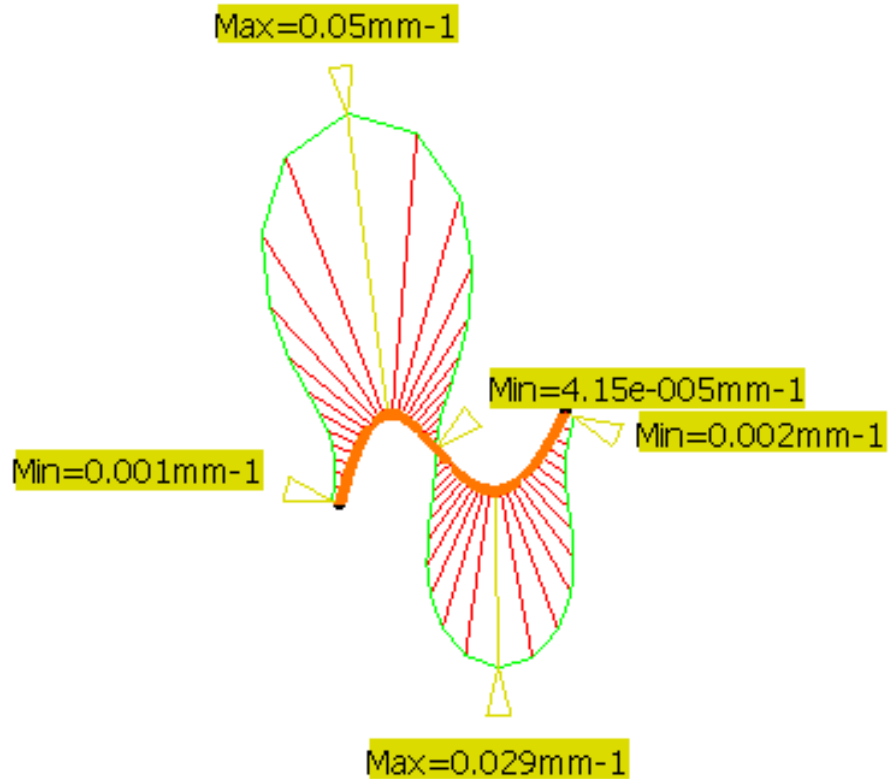

i Inflection points are displayed only if the **Project on Plane** and **Particular** checkboxes are checked.

12. The **Inverse Value** checkbox displays the inverse value in **Radius**, if **Curvature** option is selected, or in **Curvature**, if **Radius** option is selected.

- You can right-click on any of the spikes and select **Keep this Point** to keep the current point at this location. A Point.xxx appears in the specification tree. If you check the **Particular** option, you have more options:
 - **Keep all inflection points**
 - **Keep local minimum**
(corresponds to the absolute minimum under the running point)

- **Keep local maximum**
(corresponds to the absolute maximum under running point)
- **Keep global minimum** (in case there are two curves, the point will be found on one or other of the curves)
- **Keep global maximum** (in case there are two curves, the point will be found on one or other of the curves)

Keep this point
 Keep all inflection points
 Keep local minimum
 Keep local maximum
 Keep global minimum
 Keep global maximum

P2 This option is only available in P2 mode in FreeStyle Shaper, Optimizer, and Profiler.

13. Finally, click the  icon to display the curvature graph:

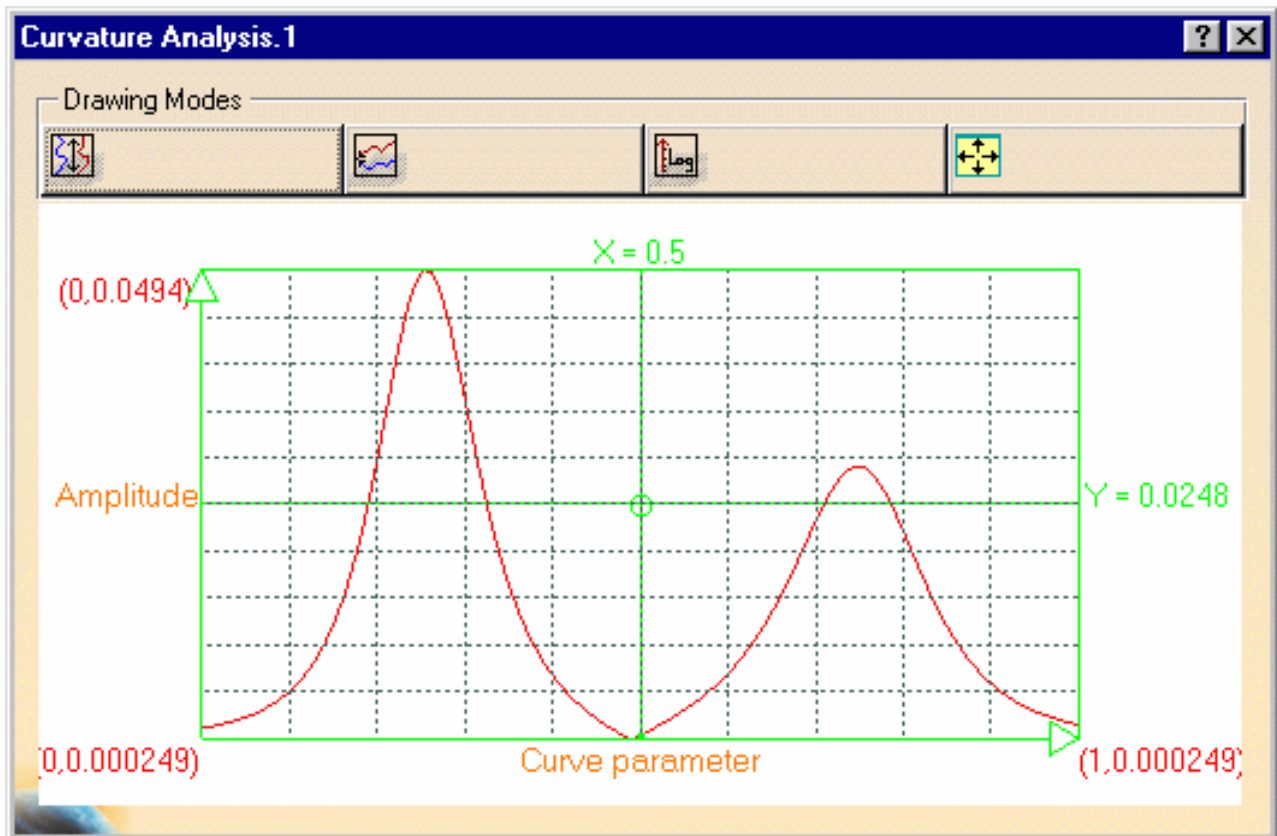

The curvature profile and amplitude of the analyzed curve is represented in this diagram.

i When analyzing a surface or several curves, i.e. when there are several curvature analyses on elements that are not necessarily of the same size for example, you can use different options to view the analyses.

For example, when analyzing a surface, by default you obtain this diagram, where the curves color match the ones on the geometry.

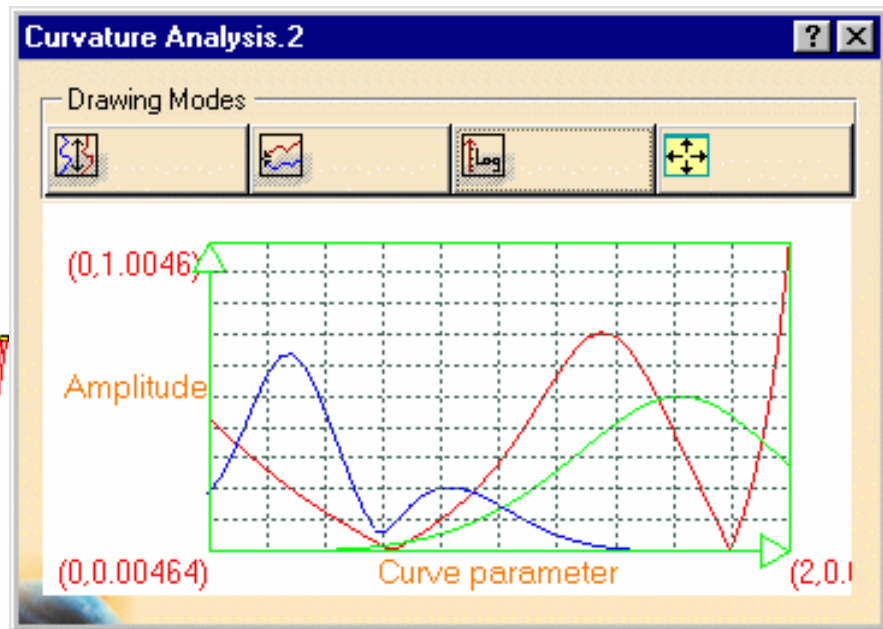
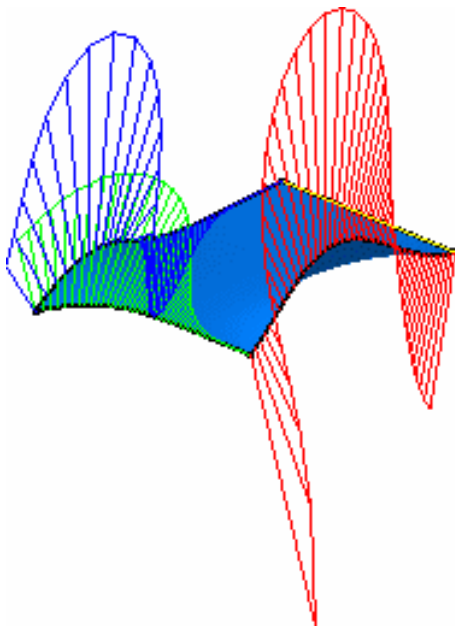

- **Same vertical length** : all curves are displayed according to the same vertical length, regardless of the scale

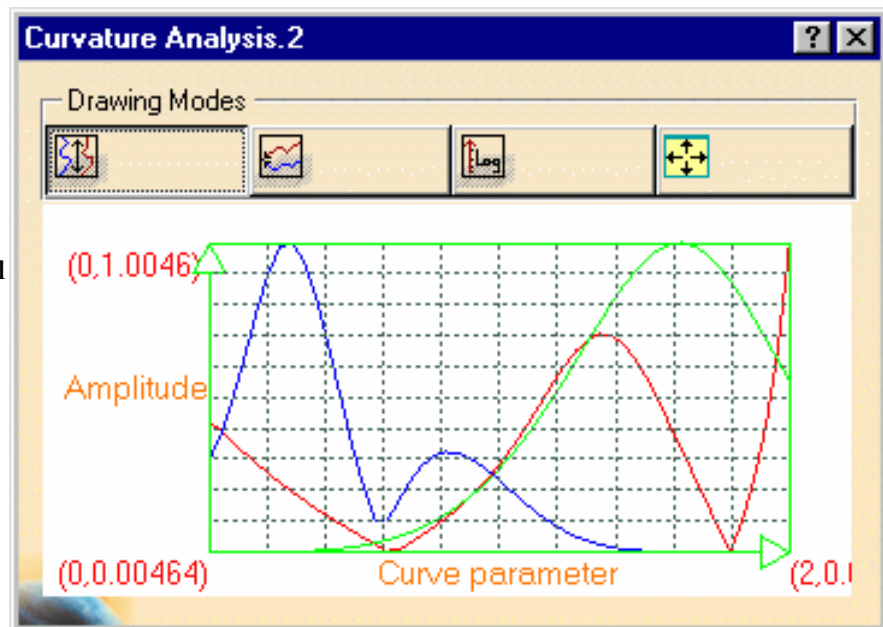

- **Same origin** : all curves are displayed according to a common origin point on the **Amplitude** scale

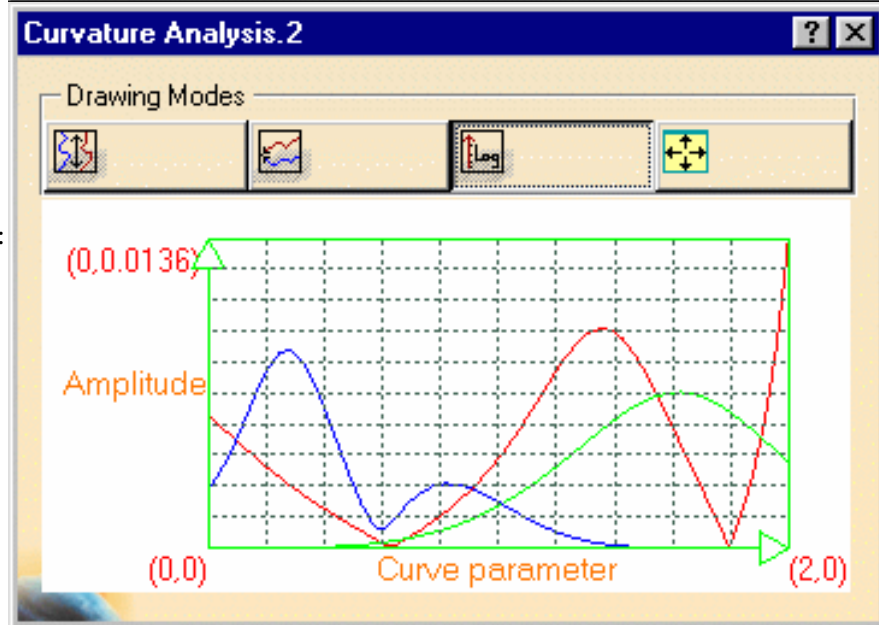
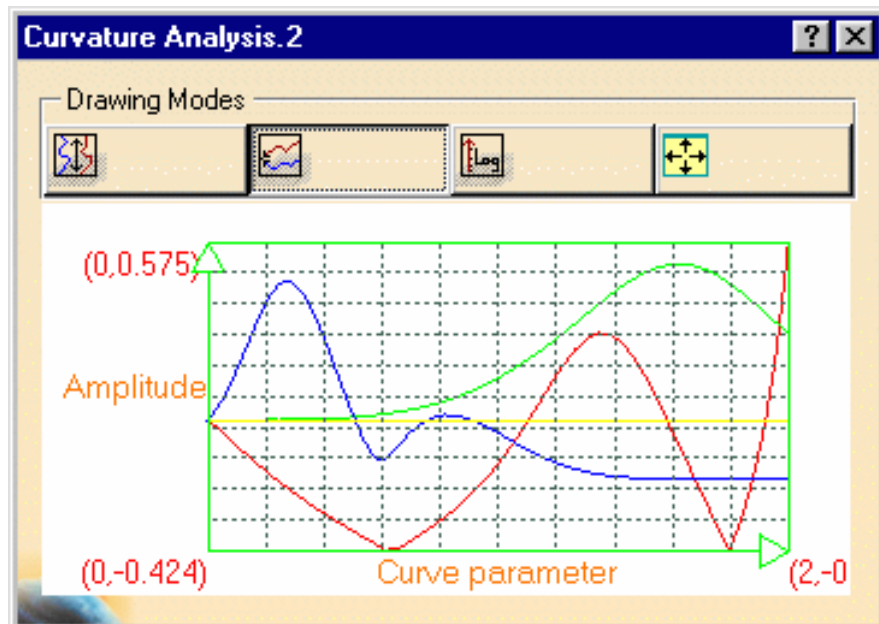

- **Vertical logarithm scale** : all curves are displayed according to a logarithm scale for the **Amplitude**, and a linear scale for the **Curve parameter**.

Depending on the chosen option, values displayed in the diagram are updated.

The last icon  is used to reframe the diagram within the window, as you may move and zoom it within the window.

14. Right-click a curve and choose one of the following options from the contextual menu:

- **Remove**: removes the curve
- **Drop marker**: adds Points.xxx in the specification tree
- **Change color**: displays the Color selector dialog box that enables you to change the

Remove
Drop marker
Change color

color of the curve.

15. Slide the pointer over the diagram to display the amplitude at a given point of the curve.

You can slide the pointer over the diagram and the 3D analysis.

Click the x in the top right corner to close the diagram.

16. Click OK in the Curvature Analysis dialog box once you are satisfied with the performed analysis.

The analysis (identified as Curvature Analysis.x) is added to the specification tree.



In case of clipping, you may want to temporarily modify the Depth Effects' **Far** and **Near Limits**. See Setting Depth Effects in *CATIA Infrastructure User Guide*.



Analyzing Distances Between Two Sets of Elements

 This task shows how to analyze the distance between any two geometric elements, or between two sets of elements.

 Open the [DistanceAnalysis1.CATPart](#) document.

 **1.** Select an element, or set of elements.

2. Click the **Distance Analysis** icon  in the Shape Analysis toolbar.

The Distance dialog box is displayed.

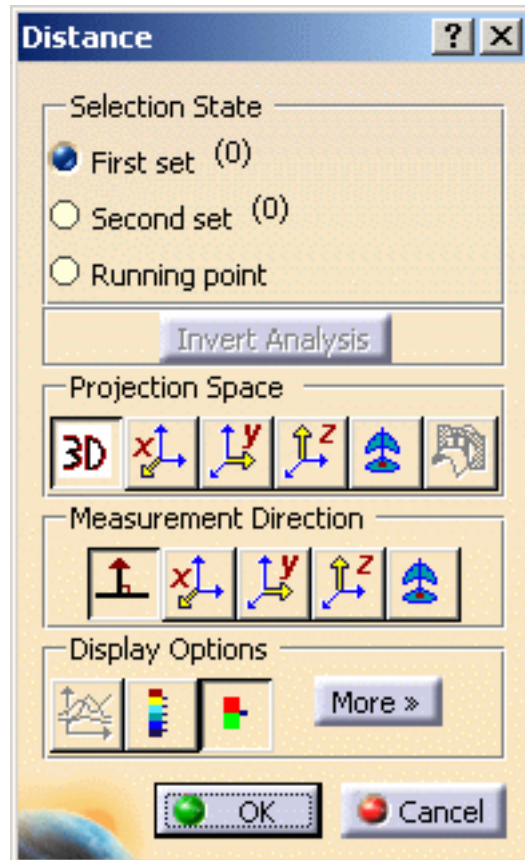

3. Click **Second set** and select a second element, or set.

The distance analysis is computed.

Each color identifies all discretization points located at a distance between two values, as defined in the Color Scale dialog box.

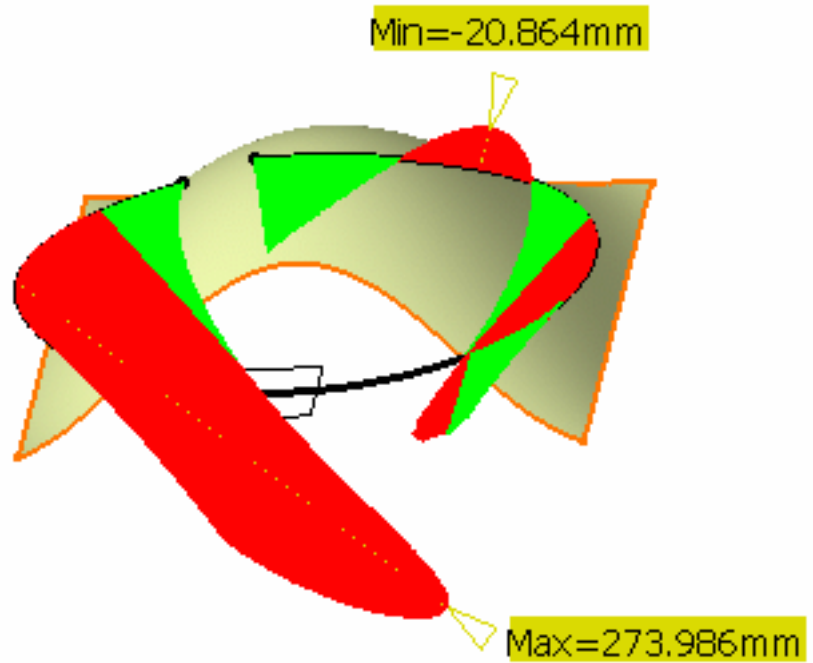

- i
 - When computing the distance between two curves, there is no negative values possible as opposed to when analyzing the distance between a surface and another element. Indeed, surfaces present an orientation in all three space directions whereas, in the case of planar curves for example, only two directions are defined. Therefore the distance is always expressed with a positive value when analyzing the distance between two curves.
 - The element which dimension is the smallest (0 for points, 1 for curves, 2 for surfaces for example) is automatically discretized, if needed. When selecting a set of element, the system compares the greatest dimension of all elements in each set, and discretizes the one with the smallest dimension.
 - Use the **Invert Analysis** button to invert the computation direction.

In some cases, when inverting the computation direction does not make sense, when one of the elements is a plane for example, the **Invert Analysis** button is grayed.

- If you check the **Running point** option, you need to move the pointer over the discretized element to display more precise distance value between the point below the pointer and the other set of elements. The projection is visualized and the value is displayed in the geometry area.

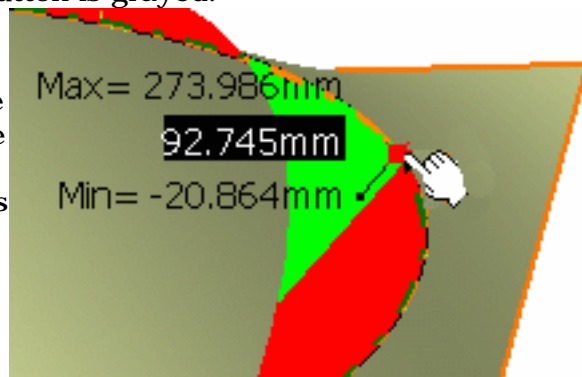

Note that the analyzed point is not necessarily a discretized point in this case. This is obvious when a low discretization value is set, as shown here.

Two analysis modes are available, with corresponding color ramps, provided the **Color scale** checkbox is checked.

a. Full (P2 only): activated by the **Full color range**  icon, it provides a complete

P2

analysis based on the chosen color range. This allows you to see exactly how the evolution of the distance is performed on the selected element.

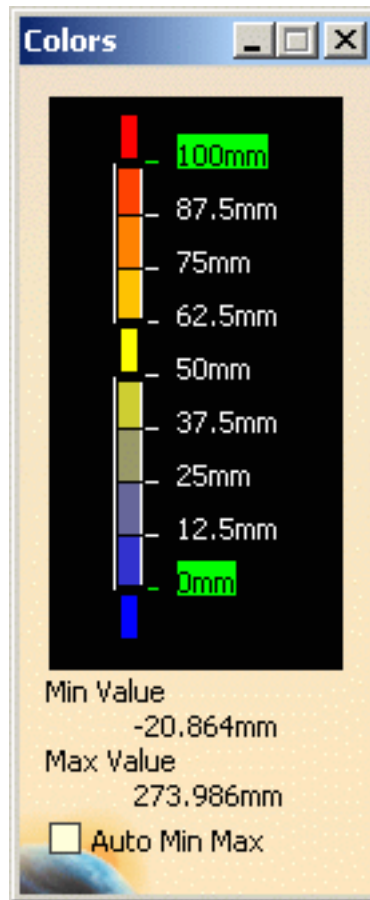

b. Limited: activated by the **Limited color range** , it provides a simplified analysis, with only three values and four colors.

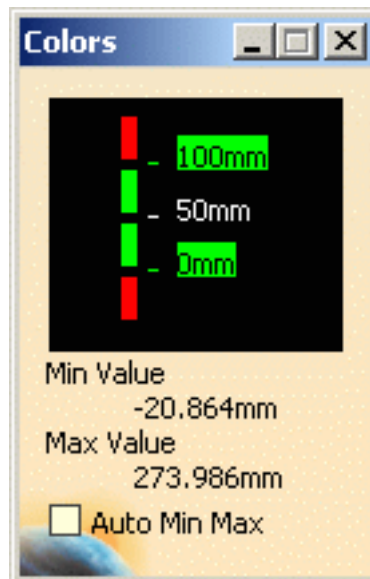

Whichever mode you choose the use of the color scale is identical: it lets you define colors in relation to distance values.

You can define each of the values and color blocks, therefore attributing a color to all elements which distance falls into to given values.

- The **Auto Min Max** button enables to automatically update the minimum and maximum values (and consequently all values between) each time they are modified.

- You can right-click on a color in the color scale to display the contextual menu:



- **Edit**: it allows you to modify the values in the color range to highlight specific areas of the selected surface. The Color dialog box is displayed allowing the user to modify the color range.

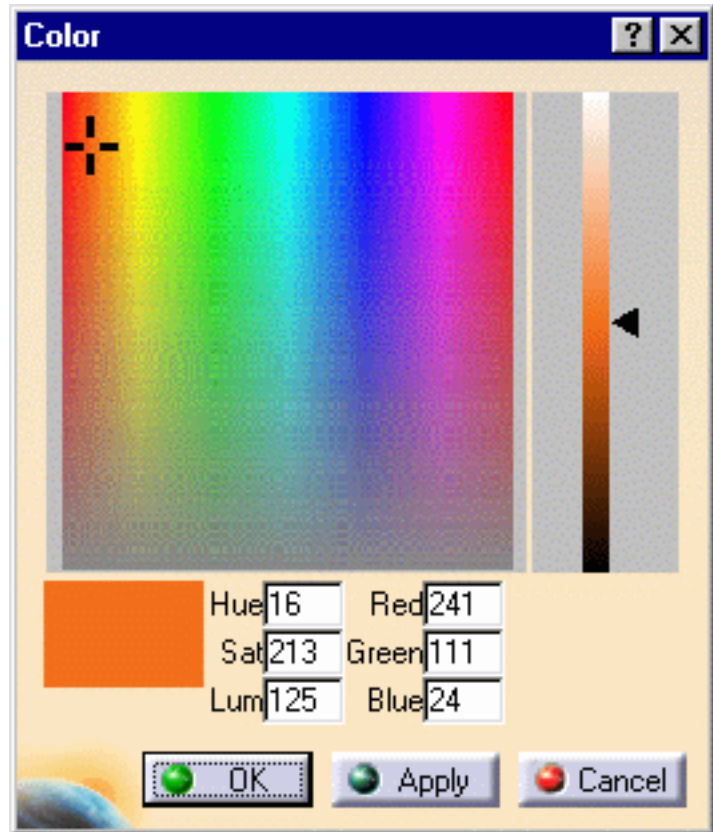

- **Unfreeze**: it allows you to perform a linear interpolation between non defined colors. The unfreezed values are no longer highlighted in green.

- **No Color**: it can be used to simplify the analysis, because it limits the number of displayed colors in the color scale. In this case, the selected color is hidden, and the section of the analysis on which that color was applied takes on the neighboring color.

- You can also right-click on the value to display the contextual menu:

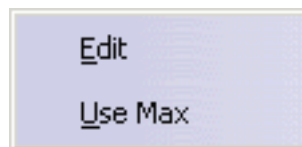

- **Edit**: it allows you to modify the edition values. The Value Edition dialog box is displayed: enter a new value (negative values are allowed) to redefine the color scale, or use the slider to position the distance value within the allowed range, and click OK.

The value is then frozen, and displayed in a green rectangle.

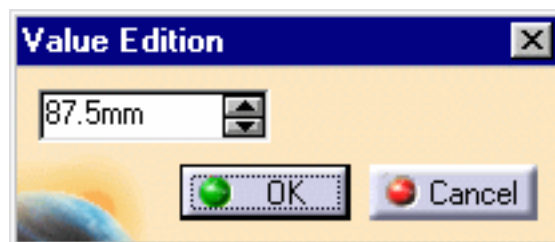

- **Use Max/Use Min** : it allows you to evenly distribute the color/value interpolation between the current limit values, on the top/bottom values respectively, rather than keeping it within default values that may not correspond to the scale of the geometry being analyzed. Therefore, these limit values are set at a given time, and when the geometry is modified after setting them, these limit values are not dynamically updated.

For now only the linear interpolation is allowed, meaning that between two set (or frozen) colors/values, the distribution is done progressively and evenly.

 The color scale settings (colors and values) are saved when exiting the command, meaning the same values will be set next time you edit a given distance analysis capability. However, new settings are available with each new distance analysis.

5. Set the distance analysis type (we checked the **Auto Scale** button and unchecked the **Min/Max values** button):

Projection Space





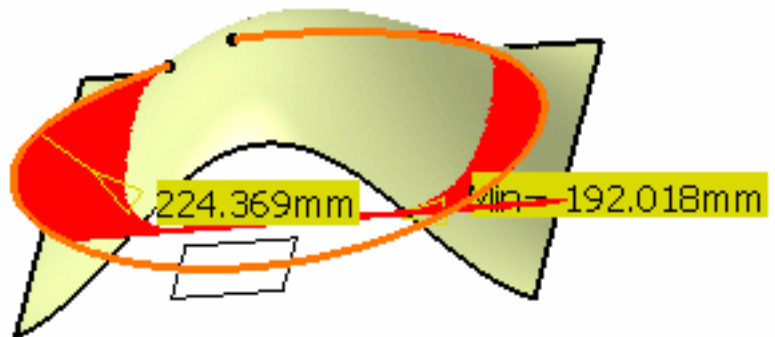

The **Projection Space** area helps you define the preprocessing of the input elements used for the computation.

 This frame is only available when analyzing distances between curves.

- **3D**  : elements are not modified and the computation is done between the initial elements.



- Projection according to the **X** , **Y** , or **Z**  axis: the computation is done between the projection of selected elements.
- Projection according to the **compass** current orientation  : the computation is done between the projection of selected elements.

- **Planar distance**  : the distance is computed between a curve and the intersection of the plane containing that curve.

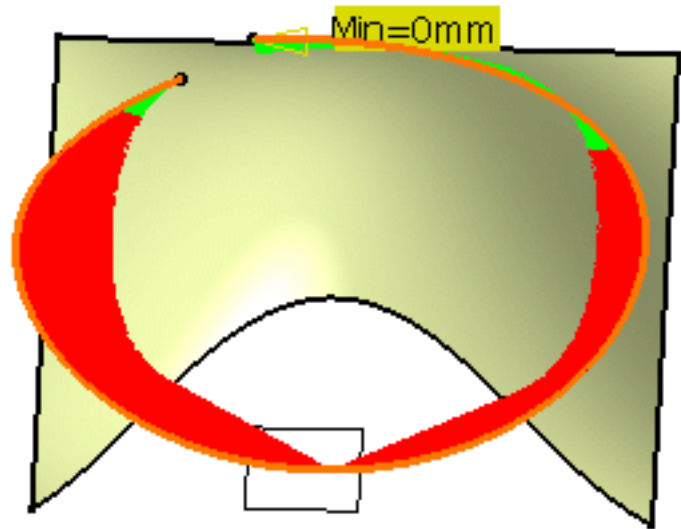





Measurement Direction

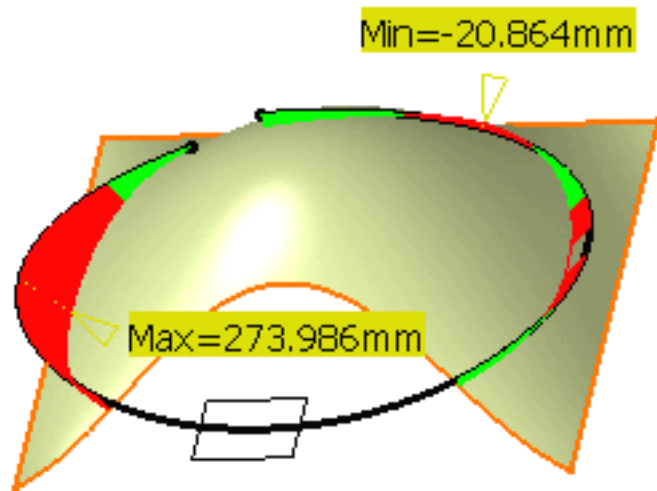

The Measurement Direction area provides options to define how set the direction used for the distance computation.

- **Normal distance**  : the distance is computed according to the normal to the other set of elements.



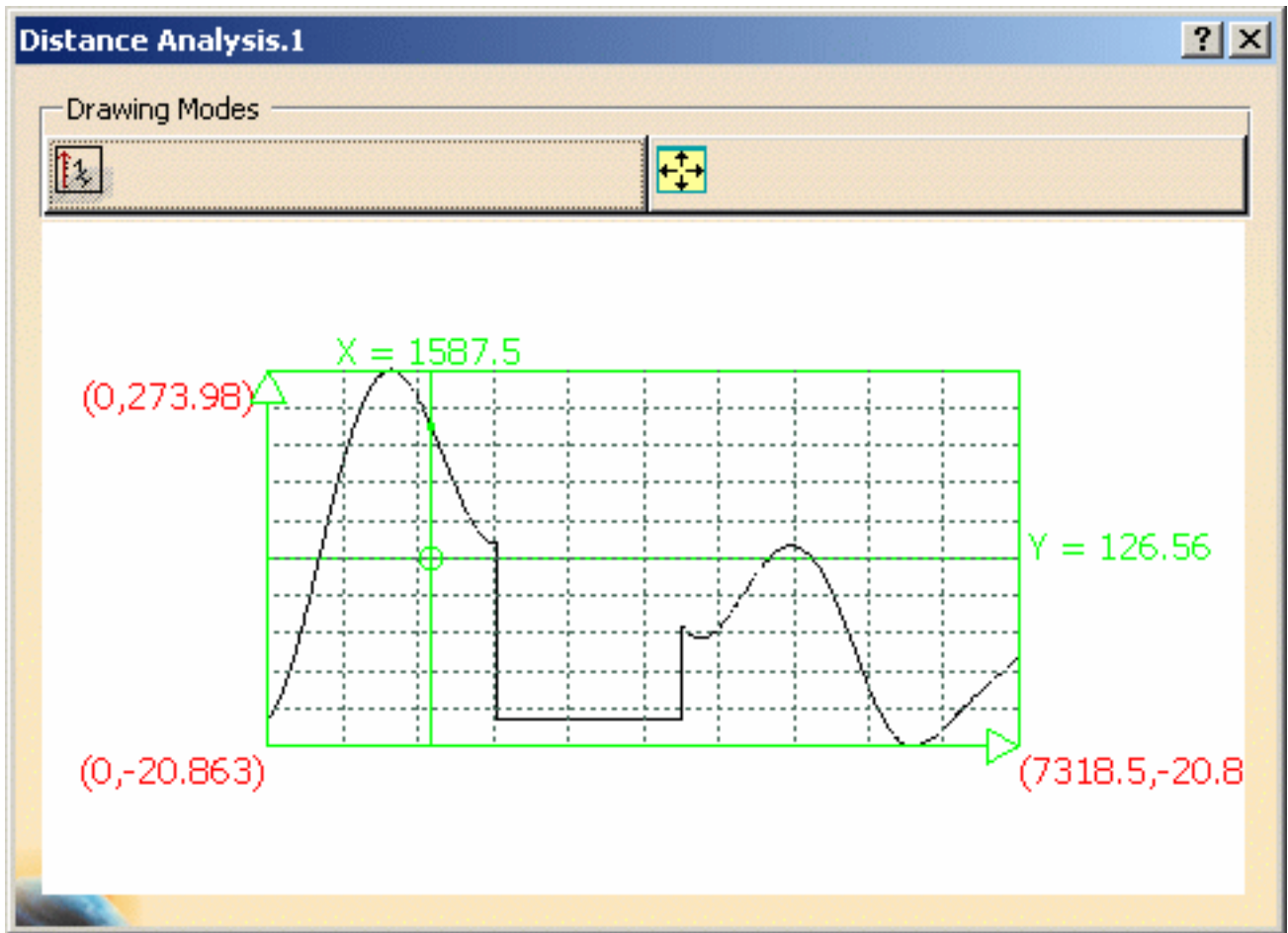

- Direction according to the **X** , **Y** , or **Z**  axis.
- Direction according to the **compass** current orientation .

6. Click the  icon to display the 2D diagram distance analysis window. The latter allows to visualize the distance evolution.



Drawing modes:

- **Vertical Inverse Scale**  : to draw the curves in a linear horizontal scale and and inverse vertical scale.
- **Reframe**  : to reframe the frame

7. Click **More>>** in the Distance dialog box to see, and choose further display and discretization options:

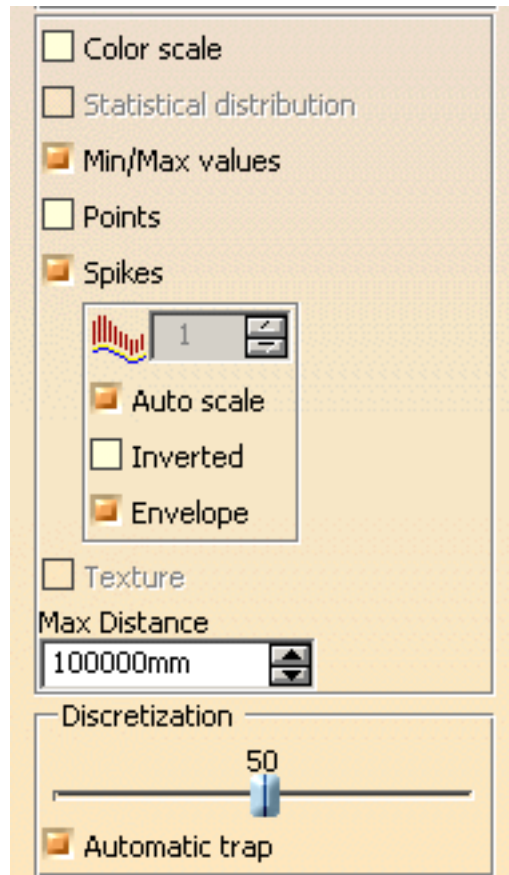

- **Color scale:** to display the [Color Scale](#) dialog box whether the full or the limited color range.

- **Statistical distribution:** to display the percentage of points between two values.



This option is only available if the **Color Scale** checkbox is checked.

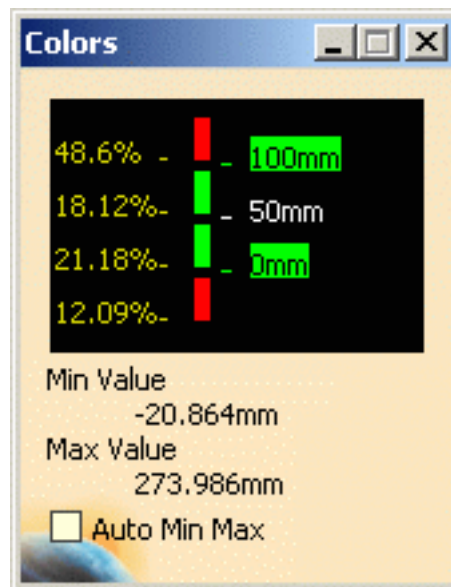

Min=-20.864mm

- **Min/Max values:** to display the minimum and maximum distance values and locations on the geometry.

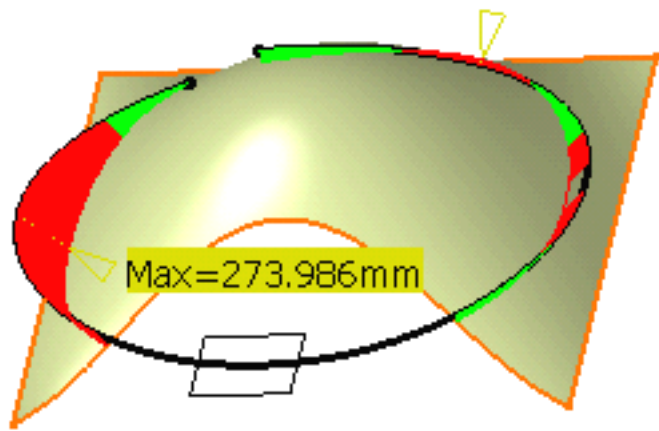

- **Points:** to see the distance analysis in the shape of points only on the geometry (The **Spikes** button is unchecked)

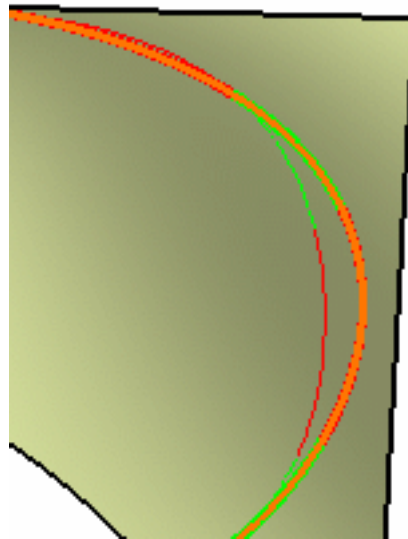

- **Spikes:** to see the distance analysis in the shape of spikes on the geometry. You can further choose to:
 - set a ratio for the spike size
 - choose an automatic optimized spike size (**Auto scale**)
 - invert the spike visualization on the geometry
 - display the envelope, that is the curve connecting all spikes together



- Use the **Texture** option to check the analysis using color distribution.



- This option is only available with surfacic elements in at least one set, providing this set is discretized. The distance is computed from this discretized set to the other set. The texture mapping is computed on the discretized surface. It is not advised to use it with planar surfaces or ruled surfaces.
- **Statistical distribution, Min/Max values, and Points** cannot be visualized when using the Texture option.
- The visualization mode should be set to **Shading with Texture and Edges**, and the discretization option should be set to a maximum (in *CATIA Infrastructure User Guide*, see Improving Performances, the **3D Accuracy -> Fixed** option should be set to 0.01). Check the **Materials** option in the **View -> Render Style -> Customize View** command to be able to see the analysis results on the selected element. Otherwise a warning is issued.

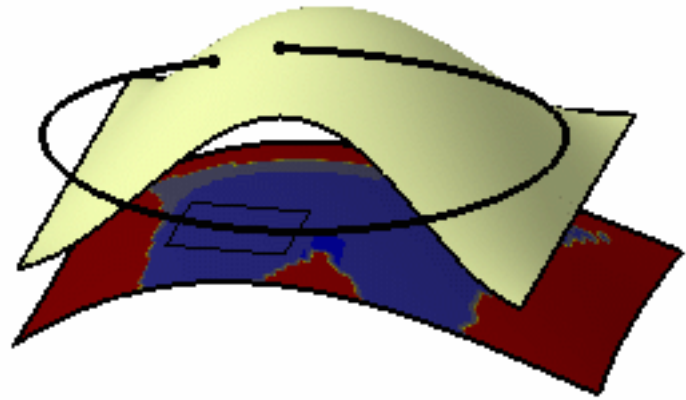

- Use the **Max Distance** option to relimit the distance: for example, set the value to 150mm. The maximum value is displayed accordingly on the geometry.

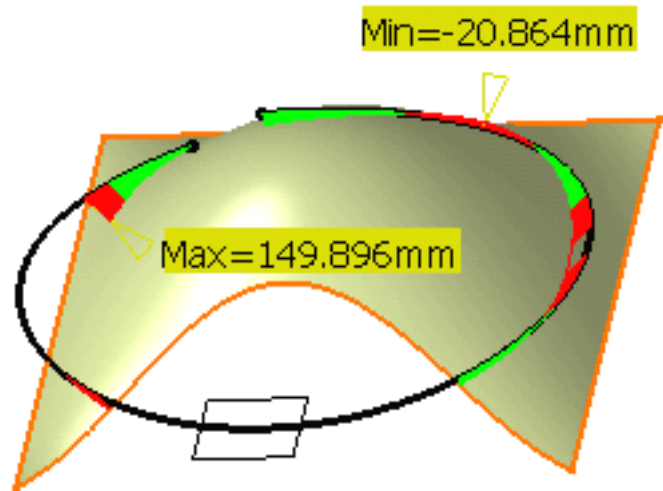

- Use the **Discretization** option to reduce or increase the number of points of the second set of elements taken into account when computing the distance.
- **Automatic trap**: to delimit the second set of points to be taken into account for the computation, in the case of a large cloud of points, thus improving the performances. Be careful when using the **Automatic trap** option with certain cloud configurations, such as spiralling clouds of points for example, as the automatic trap may remove too many points to generate consistent results. In this case, it is best to deactivate the check button.

8. Click **OK** to exit the analysis while retaining it.

The analysis (identified as Distance Analysis.x) is added to the specification tree.

-  • Even though you exit the analysis, the color scale is retained till you explicitly close it. This is like a shortcut allowing you to modify one of the analyzed elements, which leads to a dynamic update of the distance analysis, while viewing the set values/colors at all times and without having to edit the distance analysis.
- When analyzing clouds of points, in normal projection type, the distances are computed as the normal projection of each point of the first cloud onto the triangle made by the three points closest to that projection onto the second cloud.
As it is a projection, using the Invert Analysis button does not necessarily give symmetrical results.
- When you select the geometrical set as an input in the specification tree, all the elements included in this geometrical set are automatically selected too.

 The auto detection capability is available from the FreeStyle Dashboard.



Using Dynamic Cutting Planes



This task shows how to analyze a surface using parallel cutting planes. The intersection of the planes with the surface is represented by curves on the surface. From these curves, you can visualize the porcupine analysis. This analysis is dynamic, meaning that you can interactively modified a number or parameters to fine-tune the analysis.



Open the [CuttingPlane1.CATPart](#) document.



1. Select the surfaces to be analyzed.

2. Click the **Cutting Planes** icon  in the Shape Analysis toolbar.

A reference plane is displayed along with the default number of cutting planes, and the corresponding projected lines onto the selected surface.

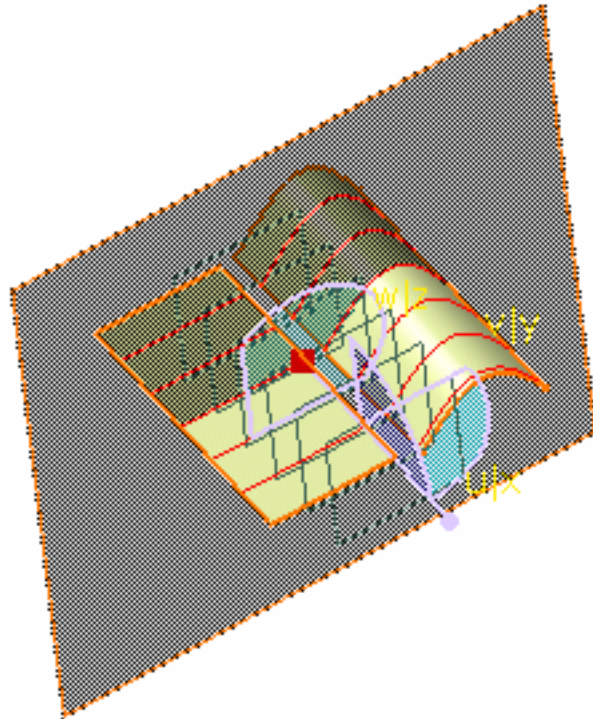

The Cutting Plane dialog box is displayed.

You can define analysis parameters from this dialog box, that is:

- The plane in which the analysis is to be performed, using the three icons (**Parallel Planes**, **Planes perpendicular to curves**, **Independent planes**)
- The boundaries of the set of planes (available in **Parallel Planes** mode only):
 - **Automatic**: the analysis is performed based on all selected surfaces bounding boxes. The cutting planes are evenly distributed within this area, one being necessarily located on the reference plane if the **Step** option is active.

- **Manual:** the analyzed area is defined by the **Start** and **End** values.

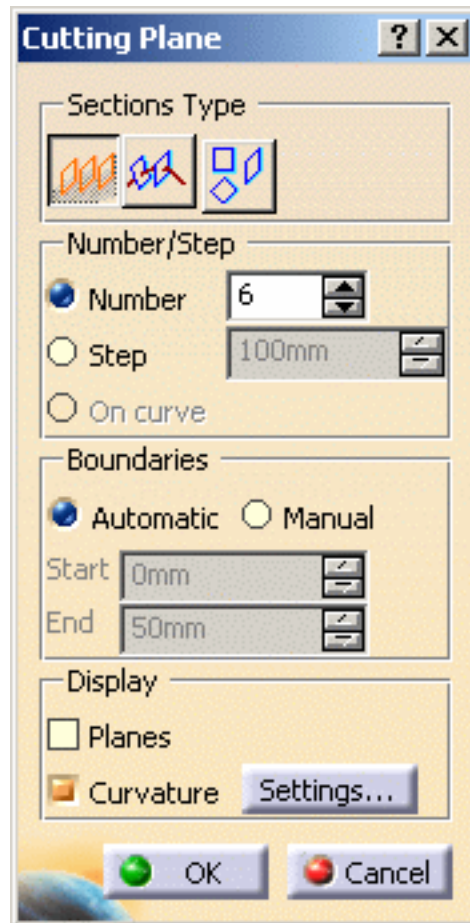

- **Number/Step:** choose whether you have a set number of planes or a distance (step) between two planes. In the latter case, the number of planes depends on the size of the analyzed area. This option is only available in **Parallel Planes** and **Planes perpendicular to curves** mode.
- **Start/End:** in manual mode, defines the distance at which the first (start) and last (end) cutting planes are located on the reference plane axis.

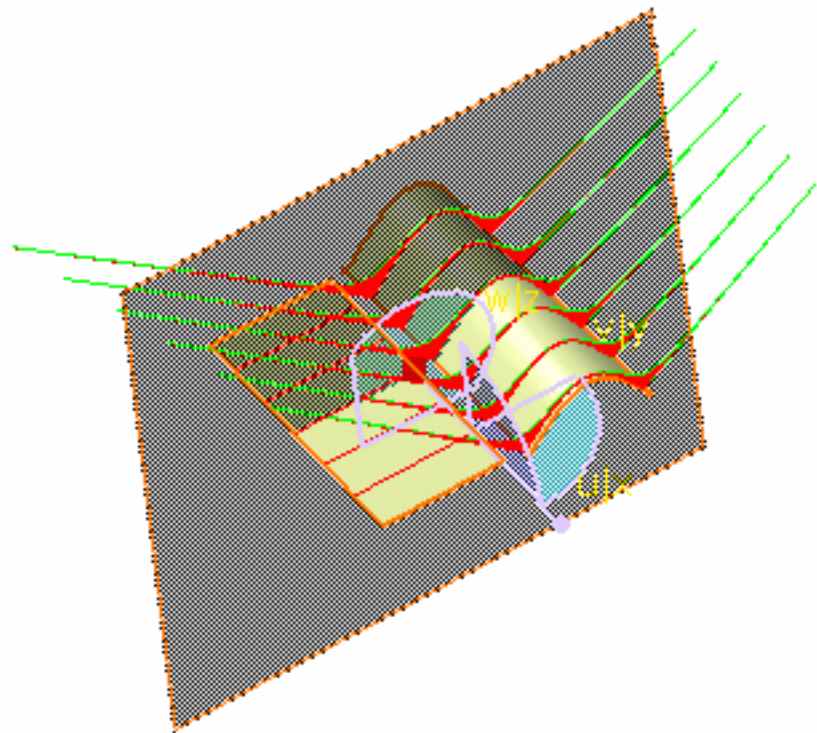

- Options facilitating the analysis reading:

1. Activates/hides the representation of the cutting planes
2. Activates the display of the curvature comb (**Curvature** option)

If you click the **Settings** button, the Curvature Analysis dialog box is displayed.

The result is similar to using the Porcupine curvature analysis, except that it displays spikes for each intersection curve. See [Performing a Curvature Analysis](#).

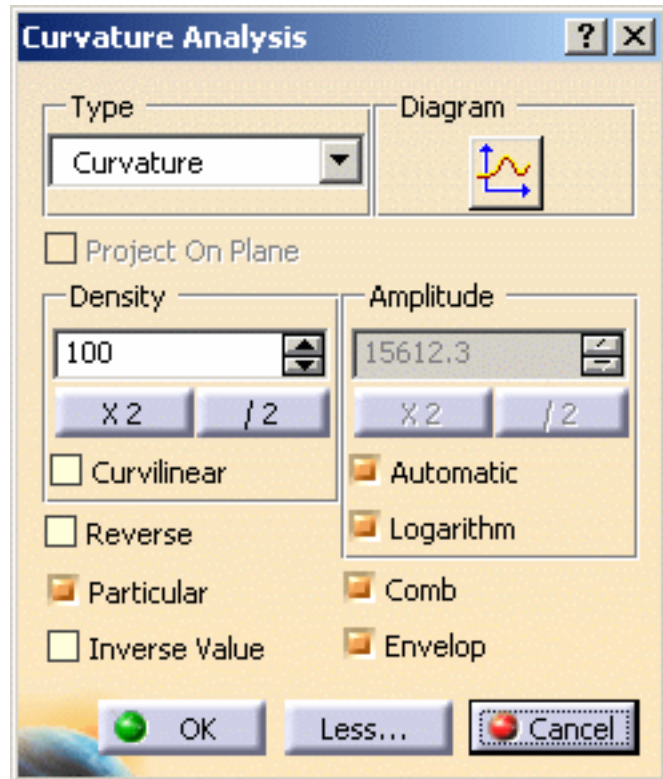

3. Click the **Parallel planes** icon .

The compass moves to the reference plane center, and from then you can manipulate the reference plane.

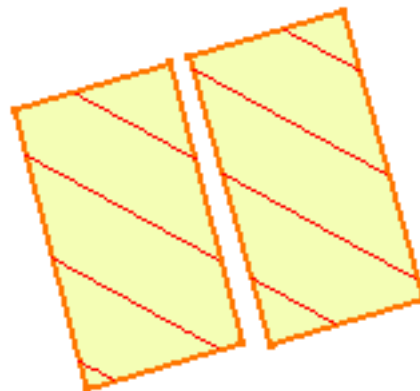

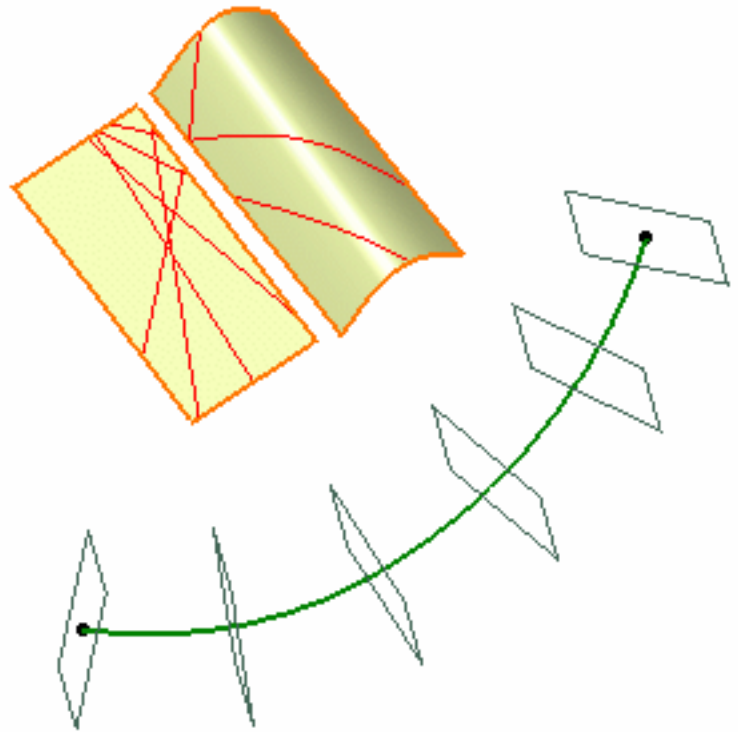

If you want to perform an analysis in planes perpendicular to curves, select a curve and click the **Planes perpendicular to curves**  icon.

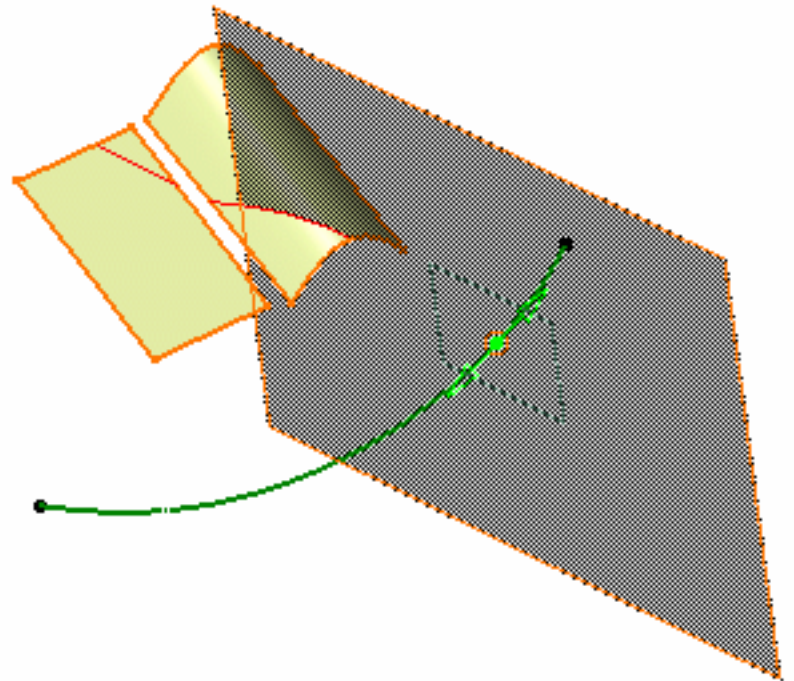

Using the **Planes perpendicular to curves** type, you can check the **On curve** option in the Number/Step area to create perpendicular planes.

1. Select a reference curve
2. Check the **On curve** option



 You can create several planes: right-click the reference plane and select **Keep this plane** from the contextual menu. Planes are added to the specification tree.

This option is only available with the **Planes perpendicular to curves** type.

If you want to perform an analysis in independent planes, click the

Independent planes  icon.

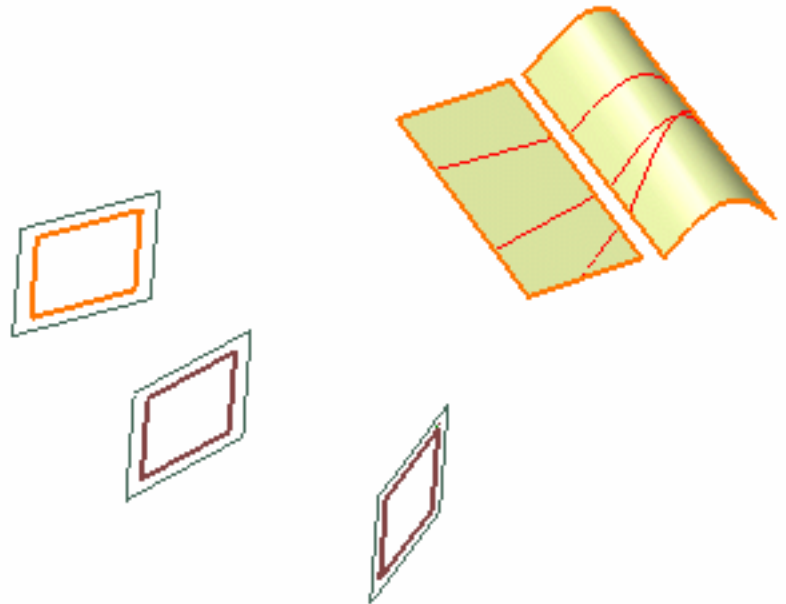

You can use the contextual menu on the **Independent planes** icon to create the a plane.

Each created plane is added to the current list of planes used for the analysis.

See [Stacking Commands](#).

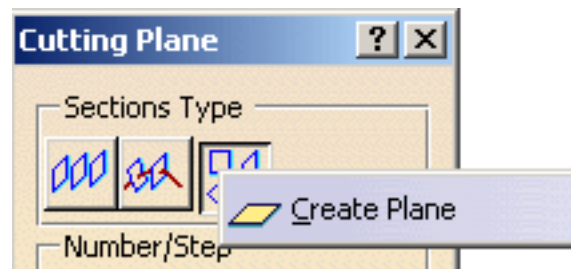

4. Activate the **Manual** mode, set the **Step** value to 30, and the **Start** value to -150 and **End** value to 150.
The planes are automatically relocated.

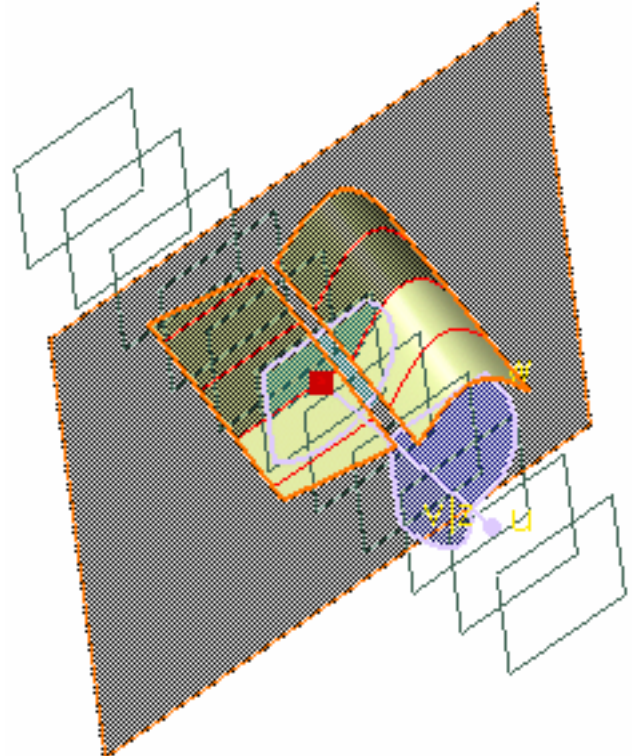

5. Click **OK** in the Cutting Plane dialog box, when you have finished the analysis.

The analysis (identified as Cutting Plane Analysis.x) is added to the specification tree.



- Click **OK** to interrupt the function while keeping the analysis on the surface, so that it is dynamically updated when deforming the surface.
- Click **Cancel** to interrupt the function and remove the analysis.
- Right-click the intersection curves to actually create the curve on the analyzed surface. You can choose to create only the curve over which the pointer is (**Keep this intersection curve** option) or to "drop" all curves onto the element (**Keep all intersection curves** option).



The Keep this point option is also available from the [contextual menu](#).



Analyzing Using Highlight Lines

 This task shows you how to create and visualize curves on surfaces in order to analyze the surface shape and curvature variations.

 Open the [HighlightLines1.CATPart](#) document.

 1. Click the **Highlight Lines Analysis** icon .

The Highlight Lines dialog box displays.

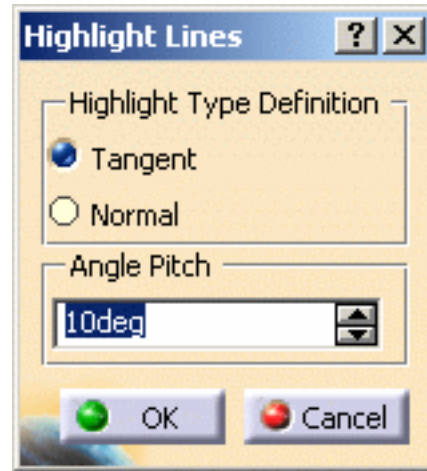

2. Select one or more surfaces to be analyzed.

3. Select the highlight type:

- **Tangent:** the compass plane intersects the surface at a given point. Then the tangent to this intersection is calculated. Therefore, the angle should be computed between the first direction of the compass and the tangent to the intersection.

The tangent in each point of the created line is defined through rotations of the angle pitch.

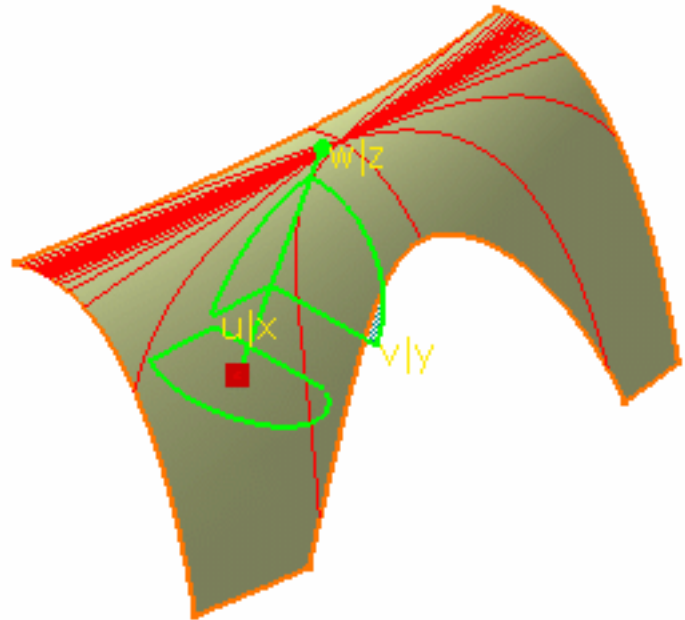

- **Normal:** the angle should be computed between the Z compass direction and the normal to the surface.

The normal to the surface in each point of the created line has the same angle pitch in a specified direction.

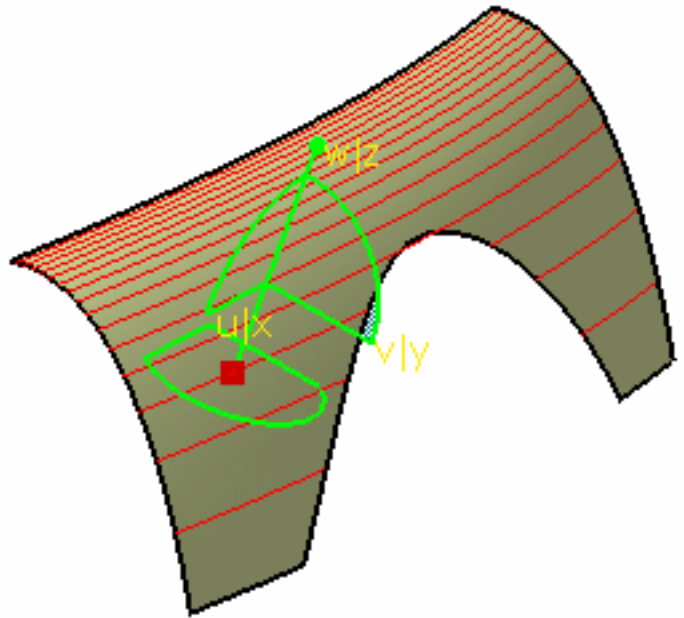

 You can right-click a line to convert it into a curve. Two options are available from the contextual menu:

- **Keep this highlight line**
- **Keep all highlight lines**

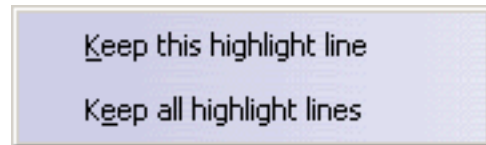

The created curve(s) appears in the specification tree as a datum element.

4. Key in an angle, representing the value between the selected direction and the normal or tangent to the surface.
5. Click OK when you have finished the analysis.

The analysis (identified as Highlight Lines Analysis.x) is added to the specification tree.



Performing a Surfacic Curvature Analysis



- This command is not available with the Generative Shape Design 1 product.
- Used in Part Design workbench, this command requires the **P2** configuration mode.



This task shows how to analyze the mapping curvature of a surface.



Open the [SurfacicAnalysis1.CATPart](#) document.

- The visualization mode should be set to **Shading With Edges** in the **View -> Render Style** command
- The discretization option should be set to a maximum: in **Tools -> Options -> Display -> Performances**, set the **3D Accuracy -> Fixed** option to 0.01.
- Check the **Materials** option in the **View -> Render Style -> Customize View** command to be able to see the analysis results on the selected element. Otherwise a warning is issued.
- Uncheck the **Highlight faces and edges** option in **Tools -> Options -> Display -> Navigation** to disable the highlight of the geometry selection.



- Select a surface.
- Click the **Surfacic Curvature Analysis** icon  in the Shape Analysis toolbar.

The Surfacic curvature dialog box is displayed, and the analysis is visible on the selected element. It gives information on the display (color scale), the draft direction and the direction values.

The Surfacic Curvature.1 dialog box showing the color scale and identifying the maximum and minimum values for the analysis is displayed too.

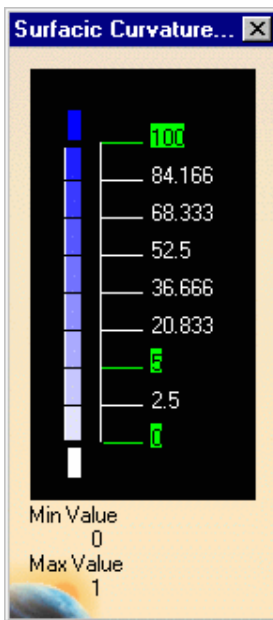
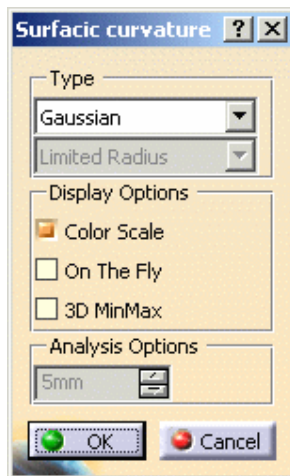

- You can right-click on a color in the color scale to display the contextual menu:

Edit
Unfreeze
No Color

- **Edit**: it allows you to modify the values in the color range to highlight specific areas of the selected surface. The Color dialog box is displayed allowing the user to modify the color range.

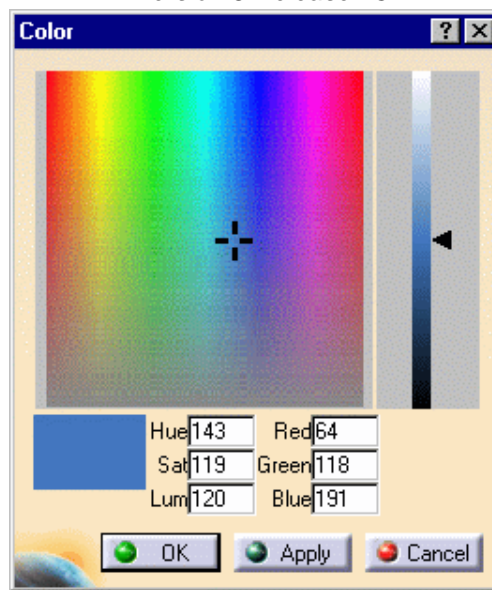

- **Unfreeze**: it allows you to perform a linear interpolation between non defined colors. The unfrozen values are no longer highlighted in green.

- **No Color**: it can be used to simplify the analysis, because it limits the number of displayed colors in the color scale. In this case, the selected color is hidden, and the section of the analysis on which that color was applied takes on the neighboring color.

- You can also right-click on the value to display the contextual menu:



- **Edit**: it allows you to modify the edition values. The Value Edition dialog box is displayed: enter a new value (negative values are allowed) to redefine the color scale, or use the slider to position the distance value within the allowed range, and click OK. The value is then frozen, and displayed in a green rectangle.

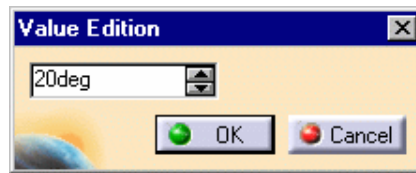

- **Use Max/Use Min**: it allows you to evenly distribute the color/value interpolation between the current limit values, on the top/bottom values respectively, rather than keeping it within default values that may not correspond to the scale of the geometry being analyzed. Therefore, these limit values are set at a given time, and when the geometry is modified after setting them, these limit values are not dynamically updated.

- **Interpolation**: by default the interpolation is linear

Type

- Select the type analysis:

In the following examples, we defined **minimum and maximum values** and used the **on the fly** option.

- Gaussian**

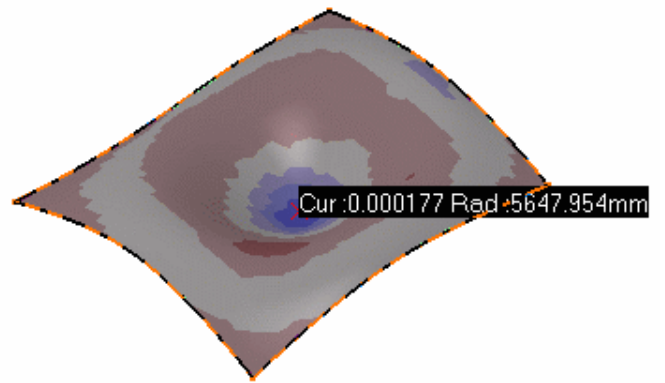
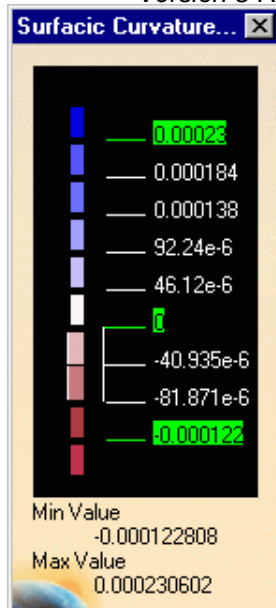

- **Minimum:** to display the minimum curvature value

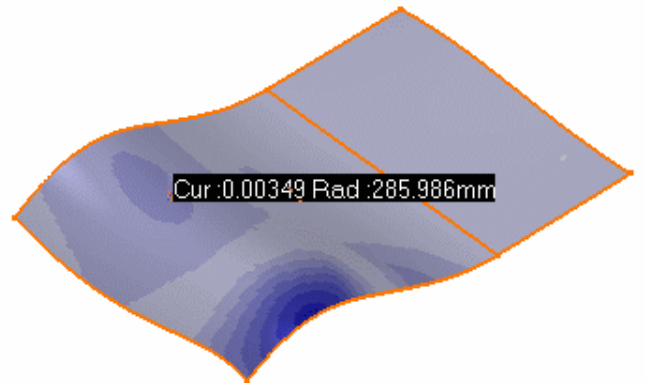
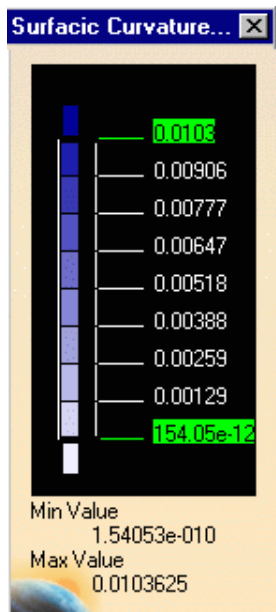

- **Maximum:** to display the maximum curvature value

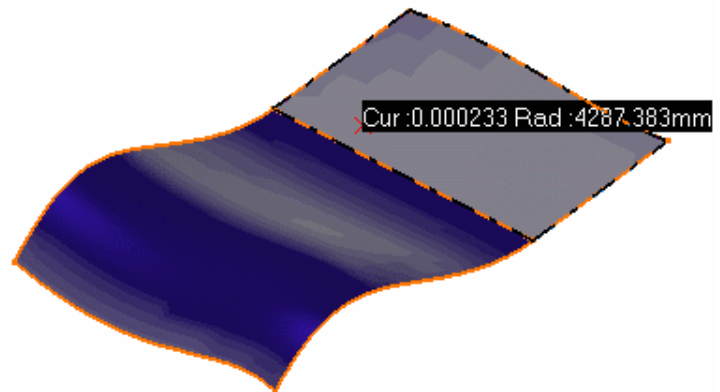
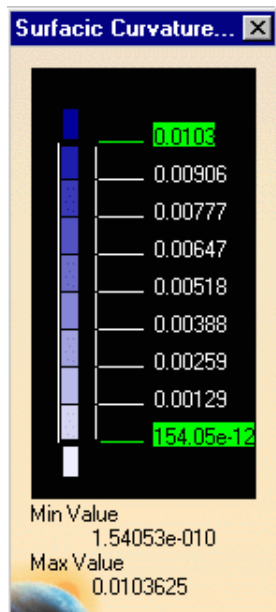

- **Limited:** the quick mode is displayed and the **Limited Radius** type is selected.

In the Surfacic curvature dialog box, you are able to modify the radius value using the up and down arrows. The value is automatically updated in the color scale.

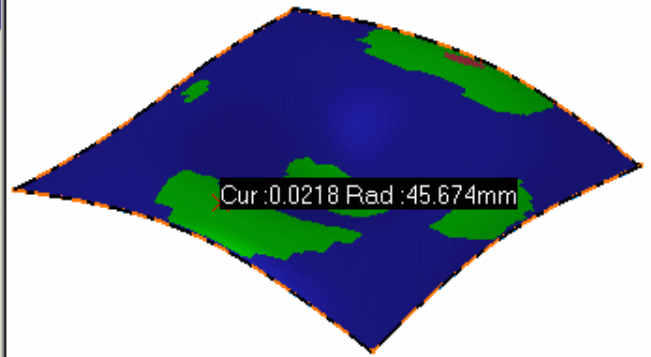
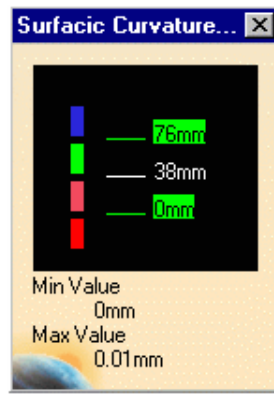

This value is expressed in the same unit as set in the **Tools -> Options -> General -> Parameters -> Units** tab, **Length** parameter.

- **Inflection Area:** enables to identify the curvature orientation:
 - In green: the areas where the minimum and maximum curvatures present the same orientation
 - In blue: the areas where the minimum and maximum curvatures present opposite orientation

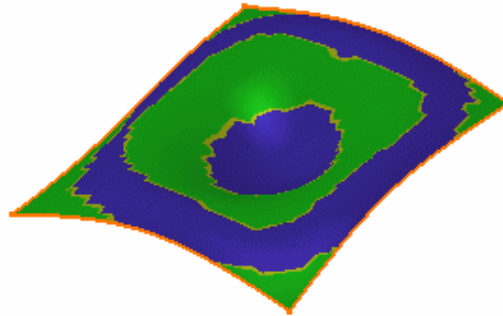
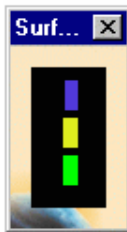

See also Creating Inflection Lines. Note that these inflection lines are always created within the green area, i.e. when the curvature orientation is changing.

Display options

- Uncheck the **Color Scale** checkbox to remove the Surfacic Curvature Analysis.1 dialog box.
- Activate the **On the fly** checkbox and move the pointer over the surface.
This option enables to perform a local analysis.
The Curvature and Radius values are displayed under the pointer. As you move the pointer over the surface, the display is dynamically updated.

The values are expressed in the units set in using the **Tools -> Options -> General -> Parameters -> Units** tab.

The displayed values may vary from the information displayed as the **Use Max / Use Min** values, as it is the precise value at a given point (where the pointer is) and does not depend on the set discretization.

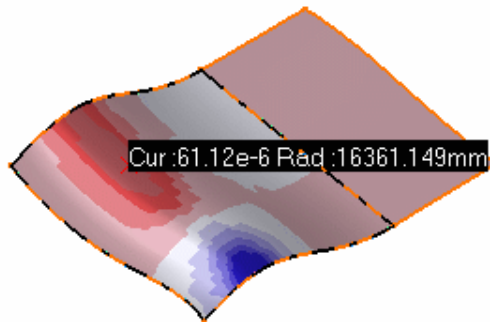

The **On the fly** analysis can only be performed on the elements of the current part.

Right-click a point to display the contextual menu. It allows you to :

- keep the point at this location (under the pointer)
- keep the point corresponding to the minimum value
- keep the point corresponding to the maximum value

A Point.xxx appears in the specification tree.

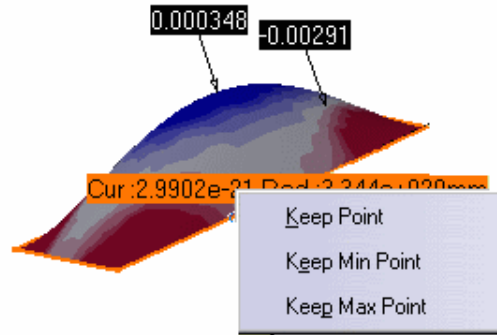
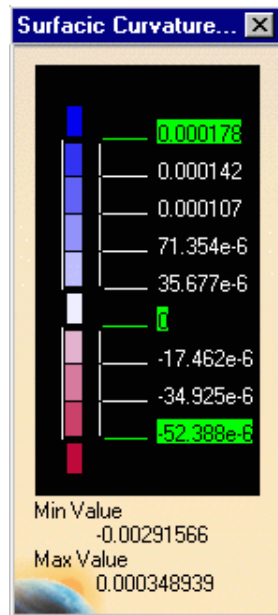

P1

In P1 mode, this contextual menu is not available.

- Activate the **3D MinMax** checkbox to locate the minimum and maximum values for the selected analysis type.

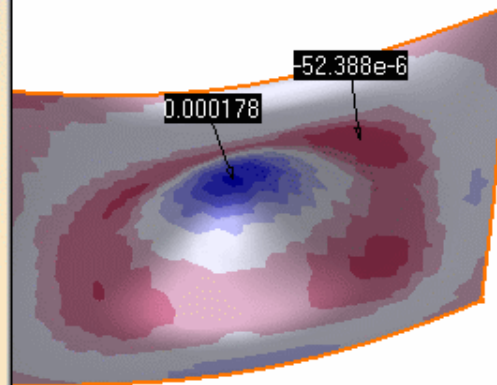
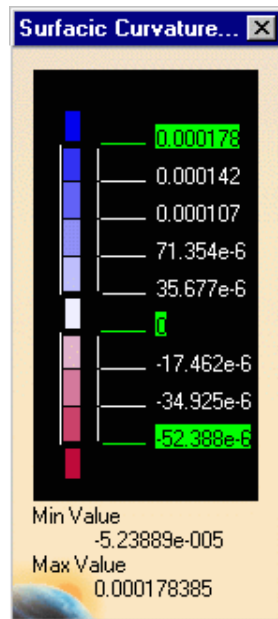

Analysis options

- The radius mode is only available for the **Limited** type analysis.
- 4. Once you have finished analyzing the surface, click **OK** in the Surfacic Curvature Analysis dialog box.

The analysis (identified as Surfacic Curvature Analysis.x) is added to the specification tree.

P1

This capability is not available in P1 mode.

- You can display the control points by clicking the  icon, still viewing the surfacic curvature analysis. This allows you to check the impact of any modification on the surface.
Here are examples using the 3D MinMax capability.

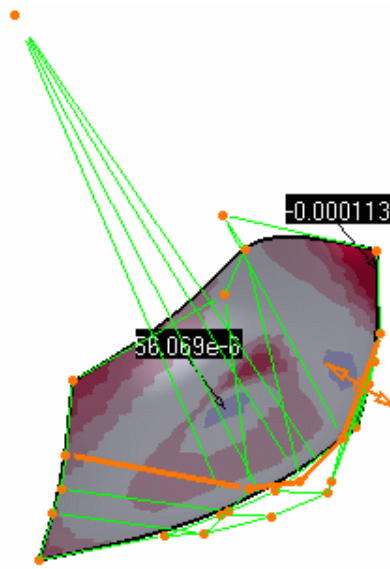
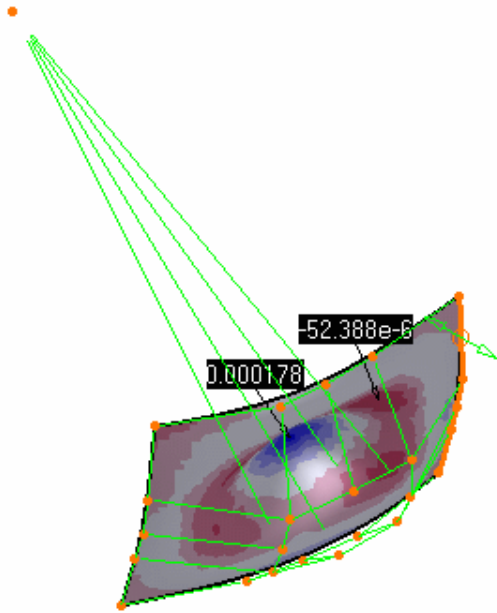

If you double-click the Surfacic Curvature Analysis.xxx in the specification tree, the Minimum and Maximum values are updated in the Surfacic Curvature.1 analysis but not in the color scale.

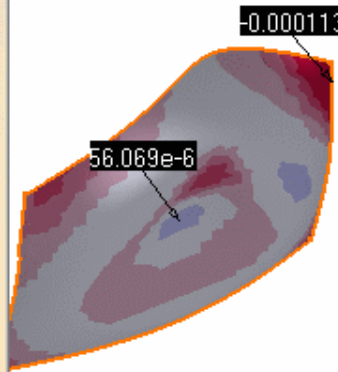
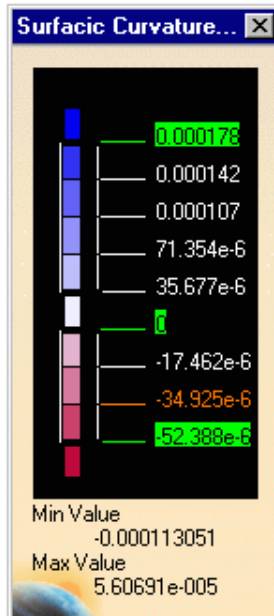

To update the values in the color scale, right-click the minimum value and the maximum value and select respectively Use Min / Use max from the contextual menu.

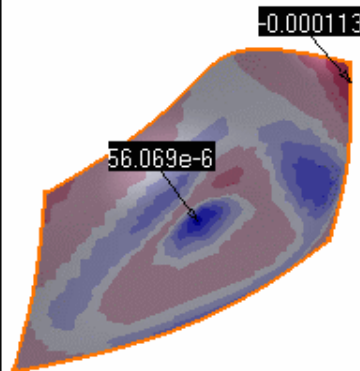
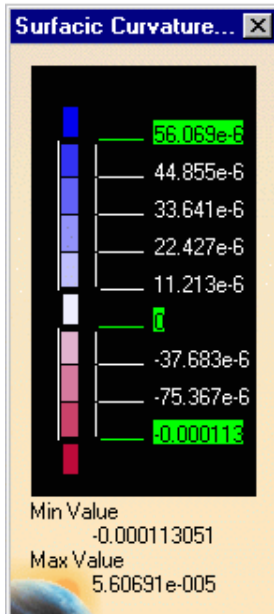





- Surfacic curvature analyses can be performed on a set of surfaces.
- If an element belongs to an analysis, it cannot be selected simultaneously for another analysis, you need to remove the current analysis by deselecting the element to be able to use it again.
- In some cases, even though the rendering style is properly set, it may happen that the analysis results are not visible. Check that the geometry is up-to-date, or perform an update on the involved geometric element(s).
- The analysis results depend of the current object. May you want to change the scope of analysis, use the Define in Work object contextual command.



Performing a Draft Analysis

 • This command is not available with the Generative Shape Design 1 product.

• Used in Part Design workbench, this command requires the  configuration mode.

 This task shows how to analyze the draft angle on a surface.
The Draft Analysis command enables you to detect if the part you drafted will be easily removed.

This type of analysis is performed based on color ranges identifying zones on the analyzed element where the deviation from the draft direction at any point, corresponds to specified values.

These values are expressed in the unit as specified in **Tools -> Options -> General -> Parameters -> Unit** tab.

You can modify them by clicking on their corresponding arrow or by entering a value directly in the field.

 Open the [DraftAnalysis1.CATPart](#) document.

- The visualization mode should be set to **Shading With Edges** in the **View -> Render Style** command
- The discretization option should be set to a maximum: in **Tools -> Options -> Display -> Performances**, set the **3D Accuracy -> Fixed** option to 0.01.
- Check the **Materials** option in the **View -> Render Style -> Customize View** command to be able to see the analysis results on the selected element. Otherwise a warning is issued.
- Uncheck the **Highlight faces and edges** option in **Tools -> Options -> Display -> Navigation** to disable the highlight of the geometry selection.

 **1.** Select a surface.

It is highlighted.

2. Click the **Draft Analysis** icon  in the

Shape Analysis toolbar.

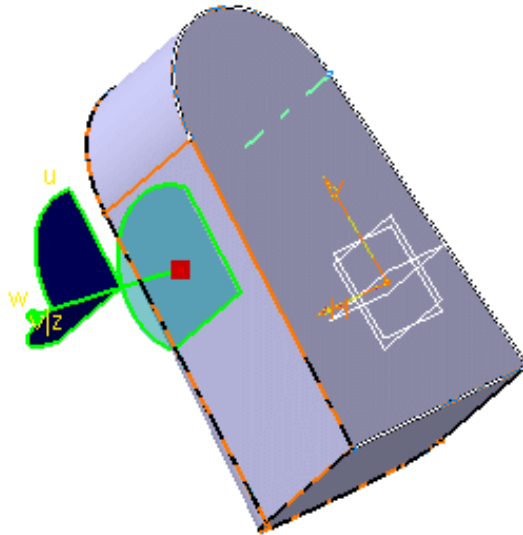

The Draft Analysis dialog box is displayed. It gives information on the display (color scale), the draft direction and the direction values.

The Draft Analysis.1 dialog box showing the color scale and identifying the maximum and minimum values for the analysis is displayed too.

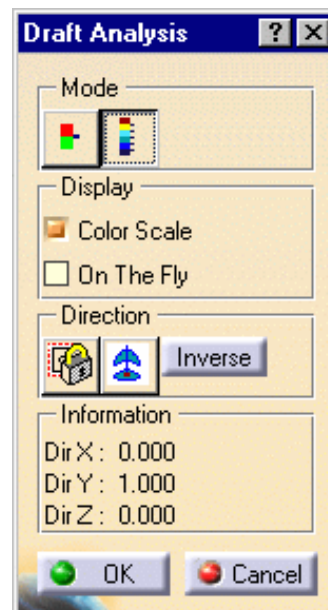

Mode option

i The mode option lets you choose between a quick and a full analysis mode. These two modes are completely independent. The default mode is the quick mode. It simplifies the analysis in that it displays only three color ranges.

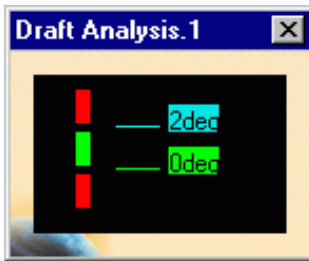

Quick mode



Full mode

P1 In P1 mode, only the quick mode is available.

- You can double-click a color and modify the values in the color range to highlight specific areas of the selected surface. The Color dialog box is displayed allowing the user to modify the color range.

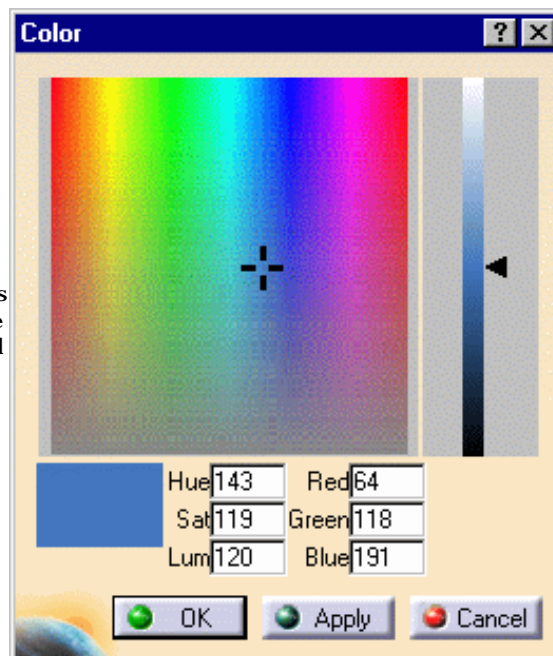

- You can also double-click a value and modify the edition values. The Value Edition dialog box is displayed: enter a new value (negative values are allowed) to redefine the color scale, or use the slider to position the distance value within the allowed range, and click OK. The value is then frozen, and displayed in a green rectangle.

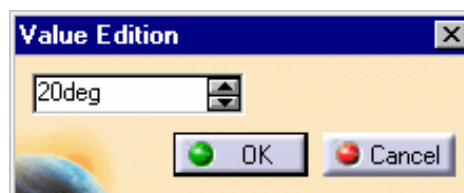

Display option

- Uncheck the **Color Scale** checkbox to remove the Draft Analysis.1 dialog box.

i This dialog box only appears in edition mode.

- Activate the **On the fly** checkbox and move the pointer over the surface.

This option enables you to perform a local analysis.

Arrows are displayed under the pointer, identifying the normal to the surface at the pointer location (green arrow), the draft direction (red arrow), and the tangent (blue arrow). As you move the pointer over the surface, the display is dynamically updated.

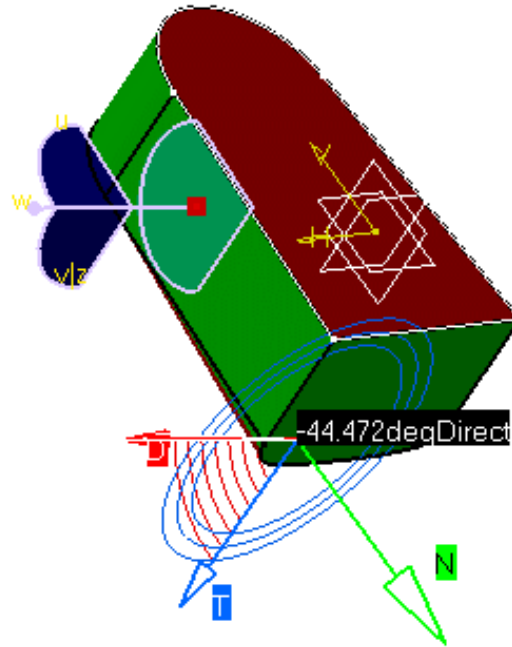

Furthermore, circles are displayed indicating the plane tangent to the surface at this point. The displayed value indicates the angle between the draft direction and the tangent to the surface at the current point. It is expressed in the units set in using the **Tools -> Options -> General -> Parameters -> Units** tab.

 The **On the fly** analysis can only be performed on the elements of the current part.

 Note that you can activate the **On the fly** option even when not visualizing the materials. It gives you the tangent plane and the deviation value.

- Click the **Inverse** button to automatically reverse the draft direction:

When several elements are selected for analysis, the draft direction is inverted for each element when the button is clicked.

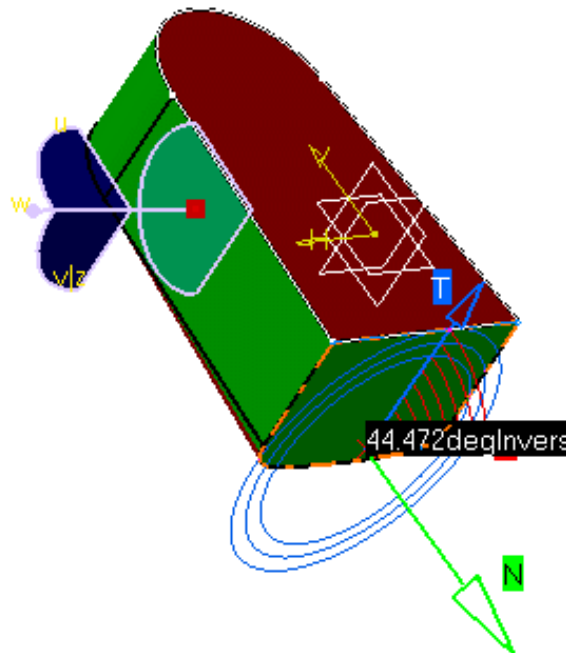

 In case of an obviously inconsistent result, do not forget to invert locally the normal direction via the **Inverse** button.

The manipulator on the draft direction allows you to materialize the cone showing the angle around the direction.

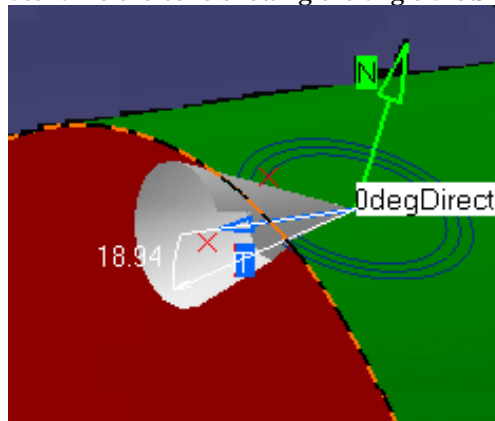
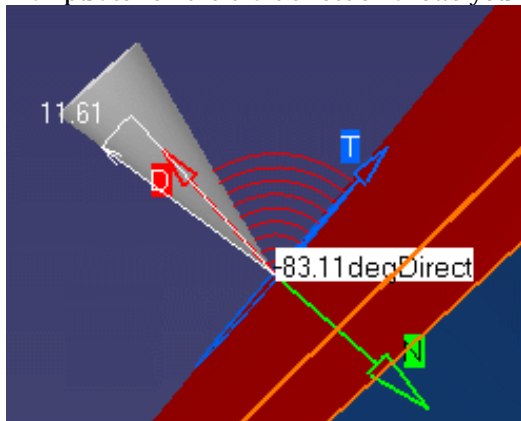

Direction in the cone

Direction out of the cone

- Right-click the cone angle to display the Angle Tuner dialog box. When you modify the angle using the up and down arrows, the value is automatically updated in the color scale and in the geometry.



 Please note that you cannot modify the angle below the minimum value or beyond the maximum value.

Full mode

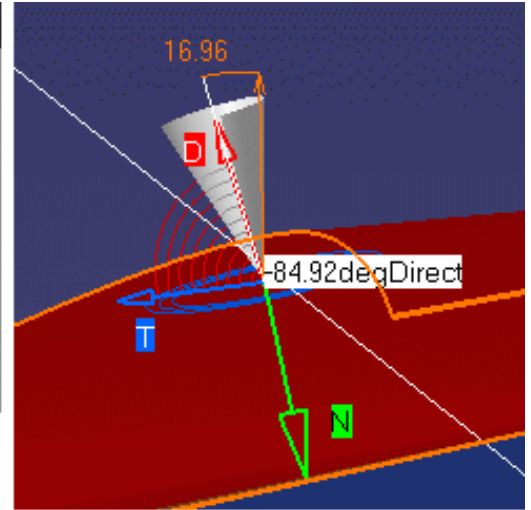
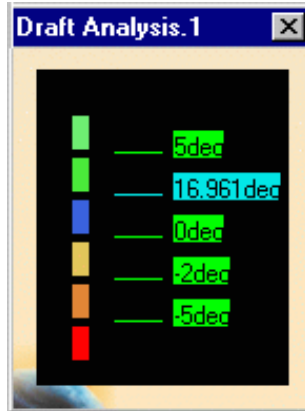

Quick mode

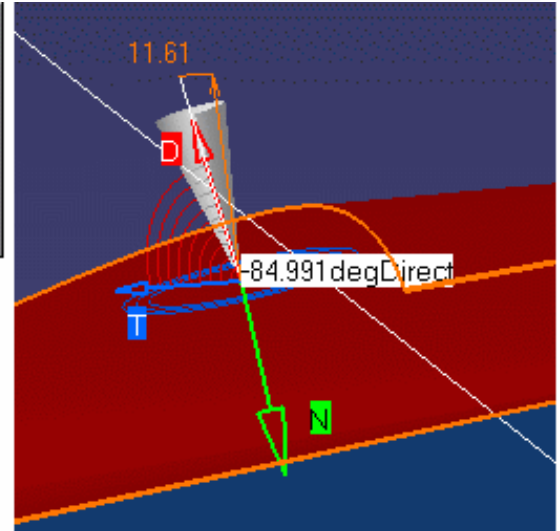
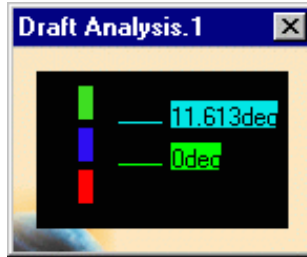

- Right-click the Direction vector to display the contextual menu.

It allows you to:

- hide / show the cone
 - hide / show the angle
 - hide / show the tangent
 - lock / unlock the analysis position
 - keep the point at this location
- A Point.xxx appears in the specification tree.

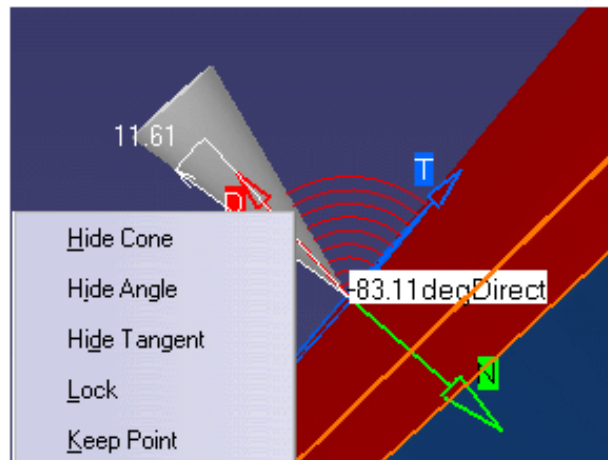

P1 In P1 mode, the Keep Point option is not available.

Direction

By default the analysis is locked, meaning it is done according to a specified direction: the compass w axis. In P1 mode, the default analysis direction is the general document axis-system's z axis.

- Click the **Locked direction** icon , and select a direction (a line, a plane or planar face which normal is used), or use the compass manipulators, when available.

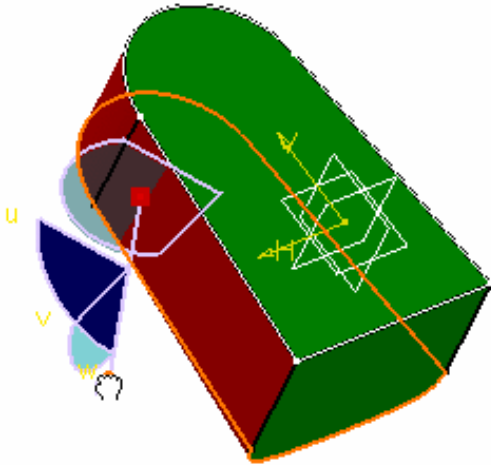

Using the compass manipulators

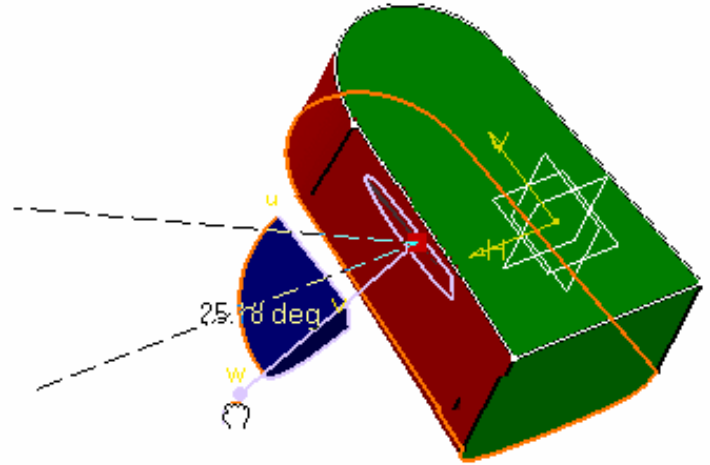

Selecting a specific direction

- Click the **Compass** icon  to define the new current draft direction.

The compass lets you define the pulling direction that will be used from removing the part.

i You can display the control points by clicking the **Control Points**  icon, yet the draft analysis is still visible, then allowing you to check the impact of any modification to the surface on the draft analysis.

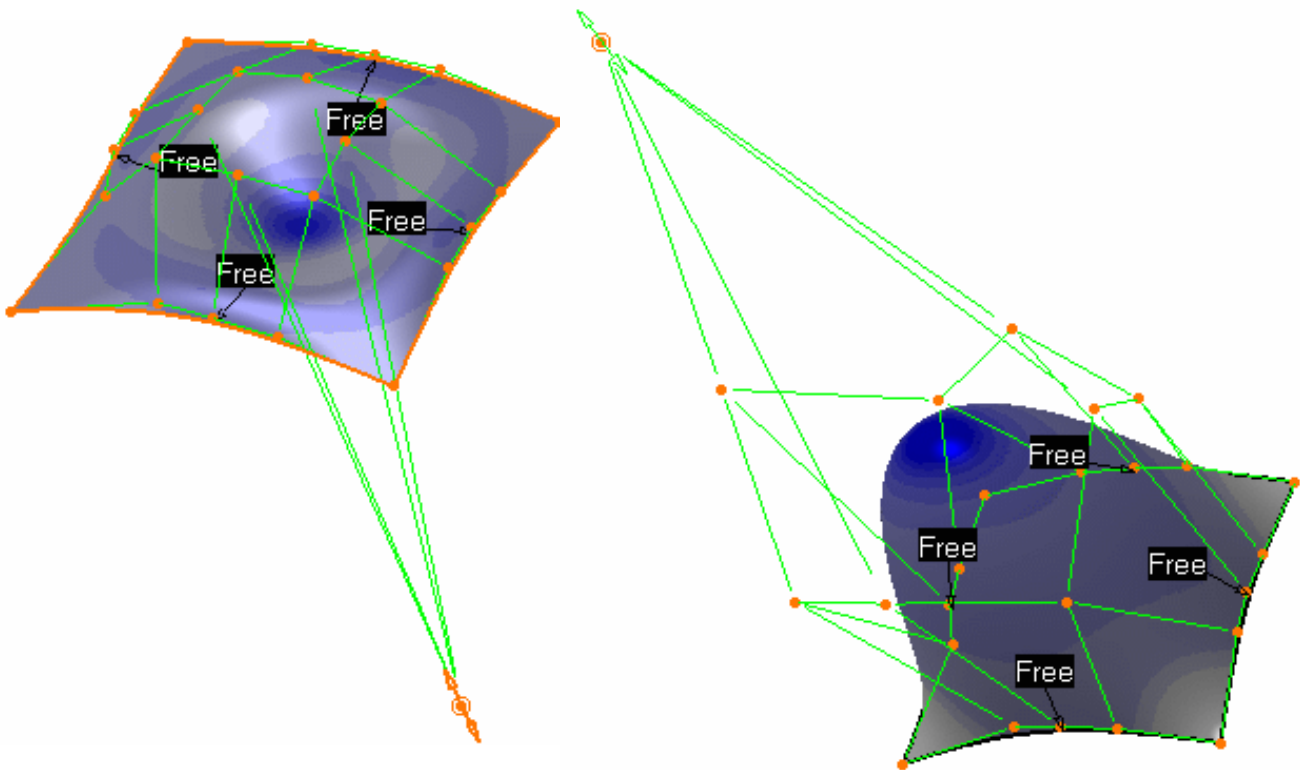

3. Once you have finished analyzing the surface, click **OK** in the Draft Analysis dialog box.

The analysis (identified as Draft Analysis.x) is added to the specification tree.

P1 This capability is not available in P1 mode.



- i** • Note that settings are saved when exiting the command, and redisplayed when you select the **Draft Analysis** icon again.
- Be careful, when selecting the direction, not to deselect the analyzed element.
- A draft analysis can be performed just as well on a set of surfaces.
- If an element belongs to an analysis, it cannot be selected simultaneously for another analysis, you need to remove the current analysis by deselecting the element to be able to use it again.
- In some cases, even though the rendering style is properly set, it may happen that the analysis results are not visible. Check that the geometry is up-to-date, or perform an update on the involved geometric element(s).
- The analysis results depend of the current object. May you want to change the scope of analysis, use the Define in Work object contextual command.



Mapping an Environment on a Surface

 This task explains how to map a sample environment onto a surface generated using the FreeStyle Shaper.

 Open the [Analysis1.CATPart](#) document.

 **1.** Click the **Environment Mapping** icon  in the Shape Analysis toolbar.

The Environment Mapping dialog box is displayed:

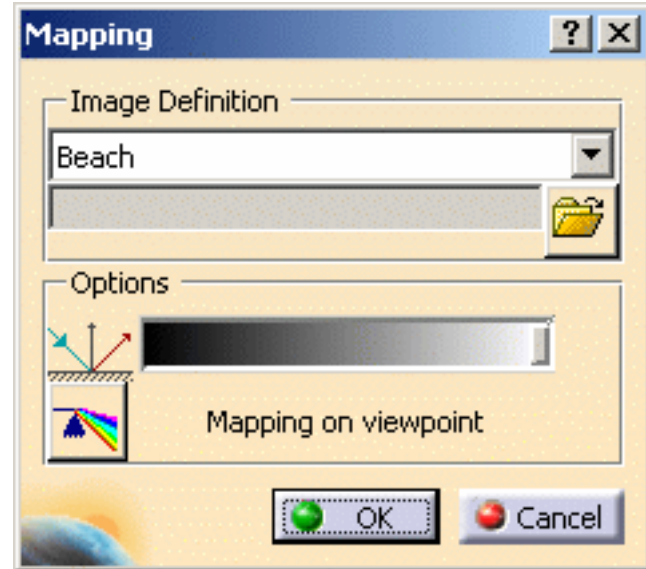

2. Define the type of mapping to be applied using the drop-down list.

You can also import an image file (of type .jpg, .bmp, .rgb) using the **Browse** icon .

3. Select one or more surfaces and apply different image definitions.

4. Set the reflectivity coefficient which defines the transparency of the texture using the slider.

The preview area lets you fine-tune these parameters.

5. Click OK.

 You can click the  icon to perform a global analysis.

The analysis (identified as Environment Mapping Analysis.x) is added to the specification tree. The surfaces automatically reflect your mapping definition. It could look like this:

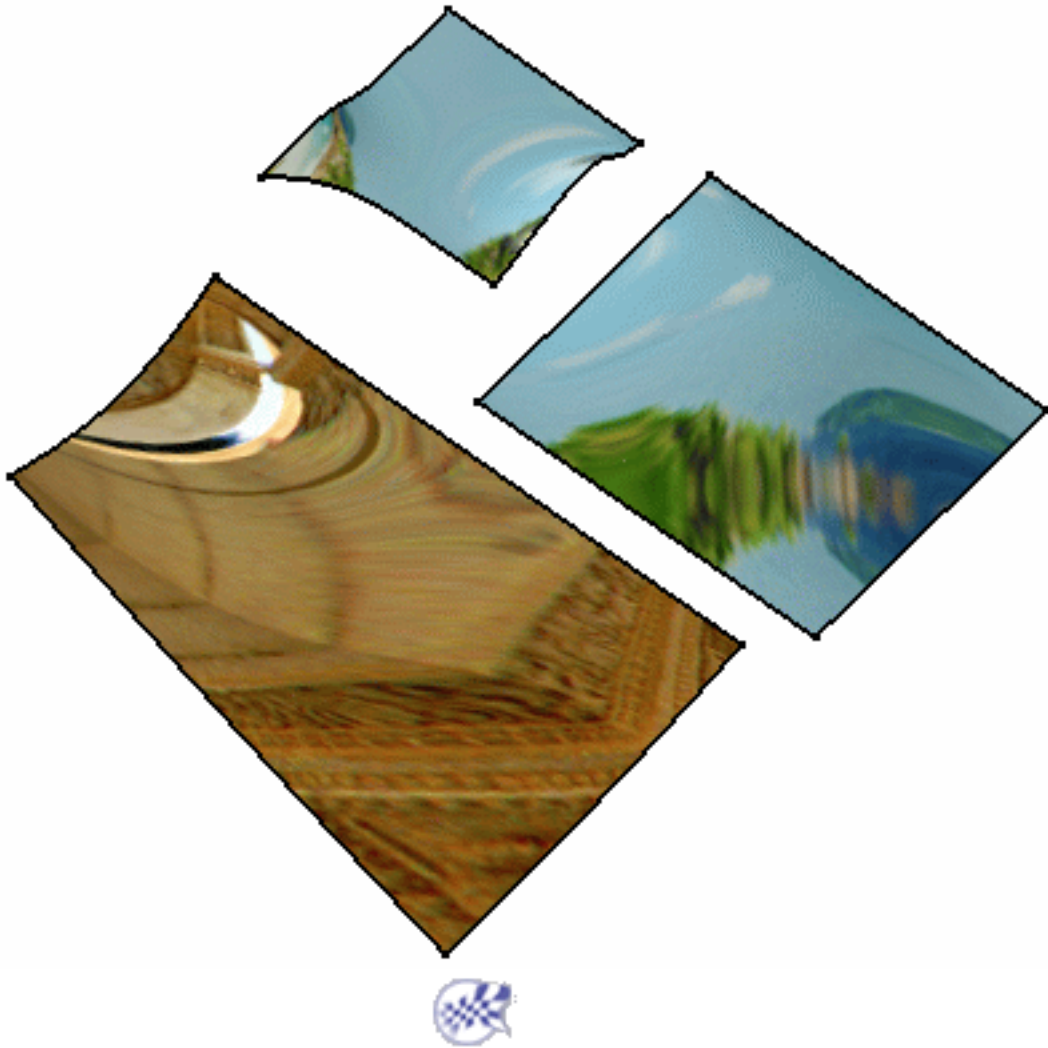

Analyzing Using Isophotes



This task explains how to apply isophotes on a surface.

Isophotes are variable black stripes applied to the surface and used for analysis purposes. It is a tool for the analysis of the element state.



Open the [IsophotesMapping1.CATPart](#) document.

The discretization option should be set to a maximum (in *CATIA Infrastructure User Guide*, see Performance: the **3D Accuracy** -> **Fixed** option should be set to 0.01).

Check the **Materials** option in the **View** -> **Render Style** -> **Customize View** command to be able to see the analysis results on the selected element. Otherwise a warning is issued.



1. Click the **Isophotes Analysis** icon  in the Shape Analysis toolbar.

The Isophote Analysis dialog box is displayed.

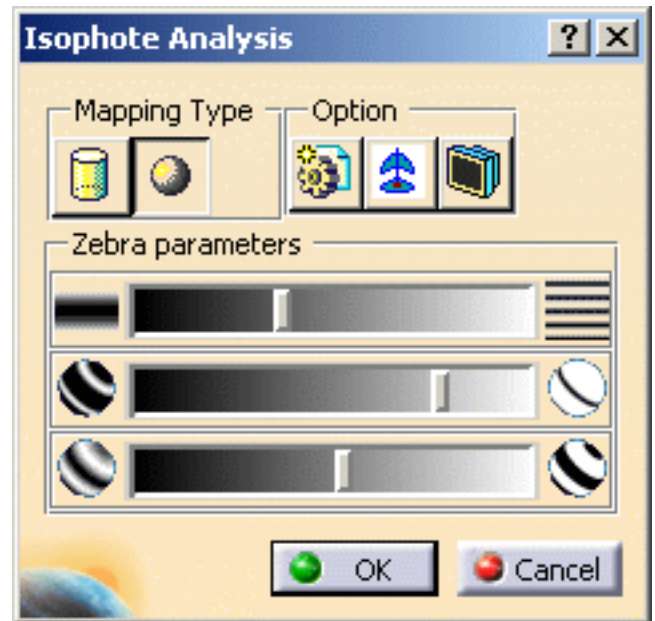

2. Select one or more surfaces to be analyzed.



The analysis results depend of the current object. May you want to change the scope of analysis, use the Define in Work object contextual command.

3. Define the mapping type:

- **Cylindrical mode**



- **Spherical mode**

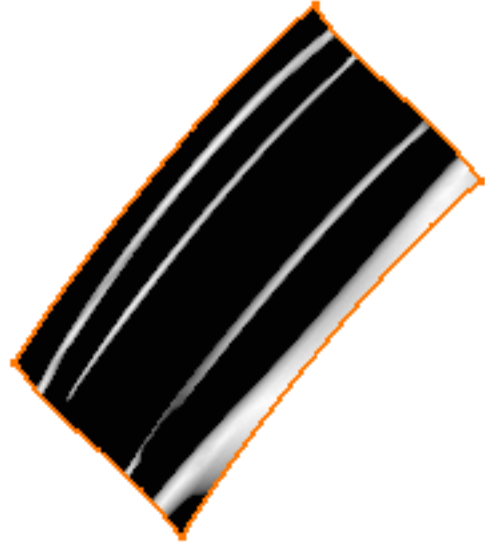

4. Define the options:

- **Global** : lets you analyse the whole part.

Uncheck this icon to perform the analysis element by element.



It is advised to use the **Global** mode for a global selection rather than using a trap.

- **Compass**  : flips the compass to the model and lets you move the compass in the 3D geometry to define the orientation.

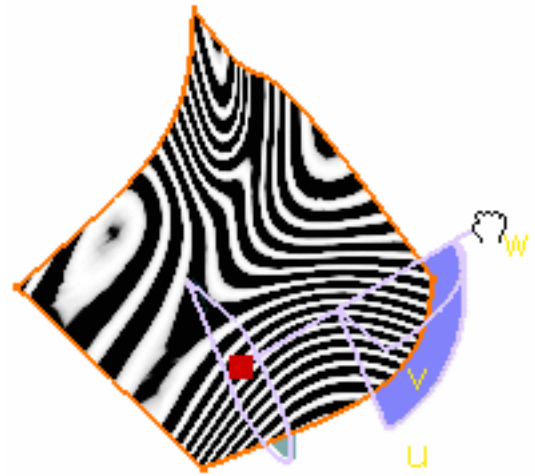

- **View**  : lets you use the screen definition to define the orientation. Stripes are recalculated each time you move the mouse.

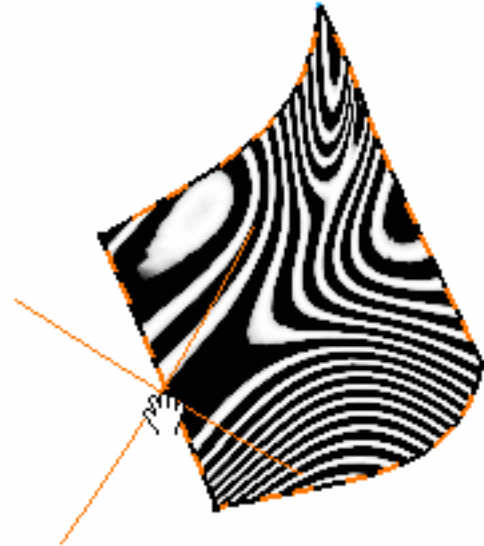

5. Define the analysis parameters using sliders:

- number of stripes



Few stripes

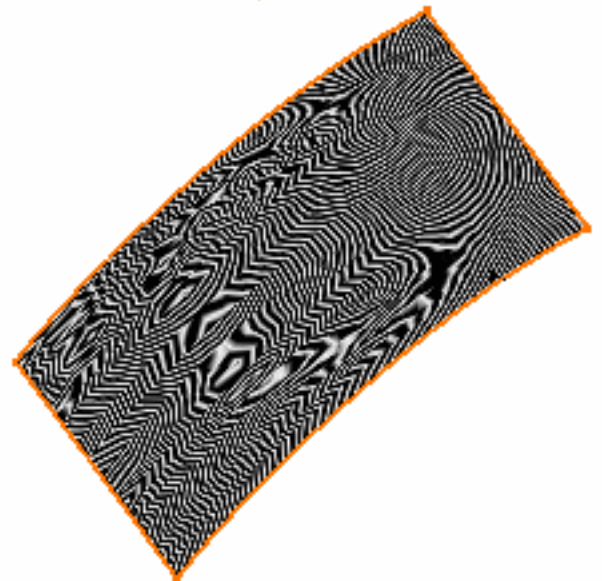

Many stripes

- width



Black thick stripes



Black thin stripes

- color transition

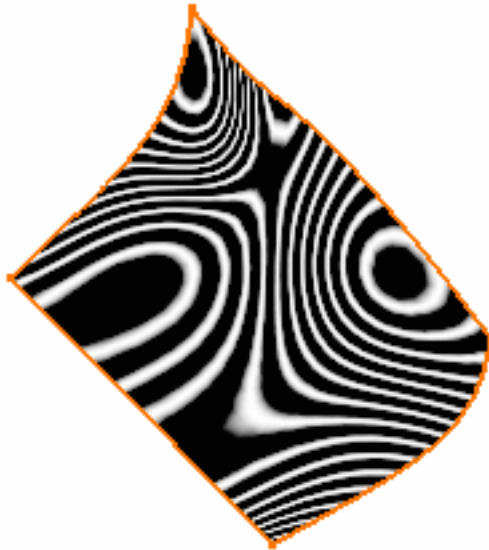

Sharp color transition



Smooth color transition

The preview area is directly applied on the 3D screen and lets you fine-tune these parameters.

6. Click OK when you have finished the analysis.

The analysis (identified as Isophotes Mapping Analysis.x) is added to the specification tree.

The surface automatically reflects your mapping definition. It could look like this:



Analyzing Using Highlights



This task shows how to perform an analysis of the surfaces quality of shaded highlights.

It analyses the angle between surface normals and a predefined direction. Dependent on the angle, it sets the color at this surface position. All positions with the same angle between surface normal and predefined direction get the same shading color. If the angle is 90 degrees, the resulting stripe is the silhouette line related to the predefined direction.



Open the [Highlights1.CATPart](#) document.



Make sure the Shading and Material visualization options are active by selecting the **Customize View** icon  in the View mode toolbar.



1. Click the **Highlight** icon .

The Highlights dialog box displays.

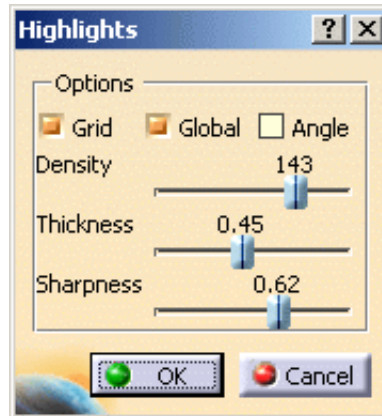

You do not need to select the part in the specification tree as the analysis works globally on the part.

2. Define the display options:

- **Grid:** two predefined directions define a grid of stripes (not necessarily perpendicular) on the surface. The plane tool u and v direction, are used as predefined directions in grid mode. If you uncheck the Grid options, it switches to the Stripes mode: the plane tool normal is the predefined direction.
- **Global:** the whole part is highlighted.
- **Angle:** highlights are distributed per angle.
- **Density:** defines the number of stripes or grid lines.
- **Thickness:** defines the thickness of stripes or grid lines.
- **Sharpness:** defines the sharpness of stripes or grid lines (soft or hard color transition).

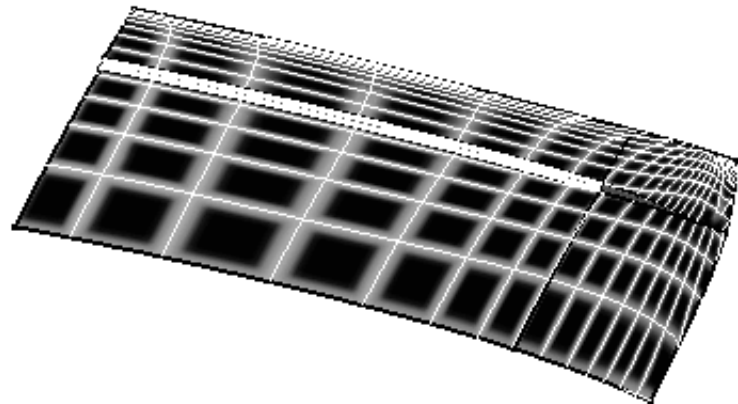
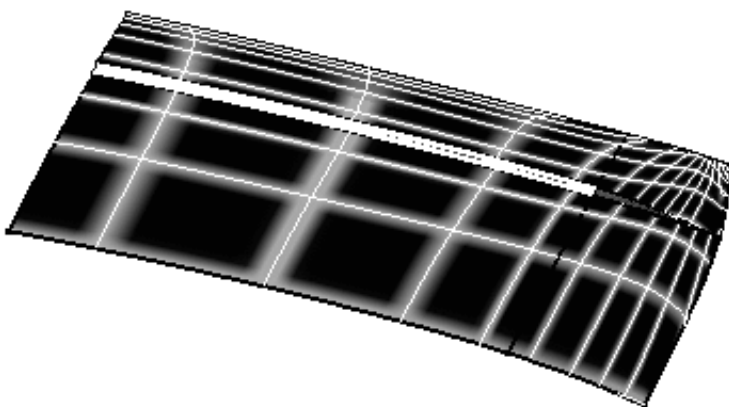

Here is an example the following values

Grid and Global

Density=50

Thickness=0.30

Sharpness=0.80

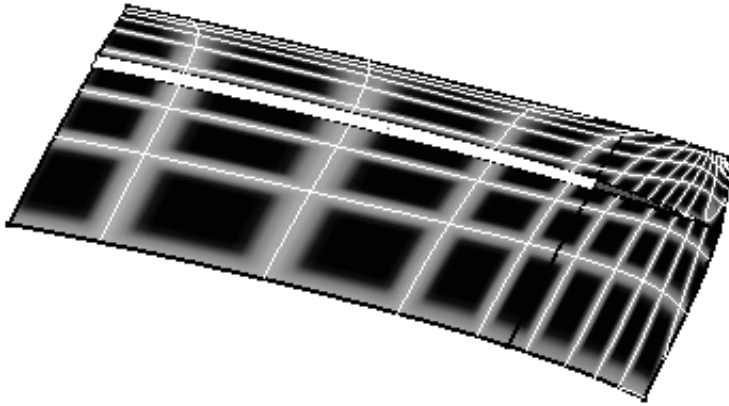

Here is an example the following values

Grid and Global

Density=80

Thickness=0.70

Sharpness=0.30

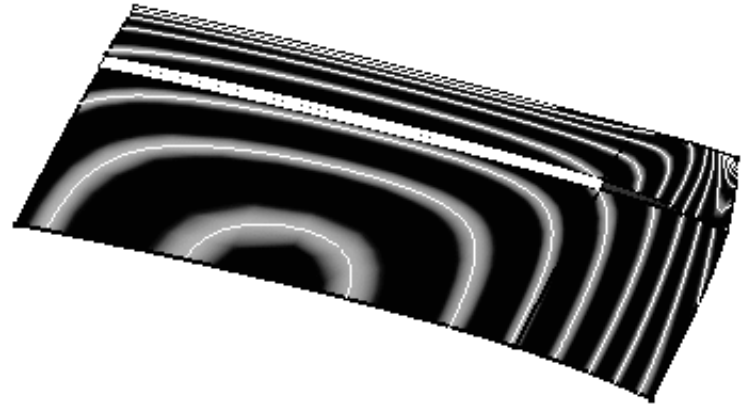

Here is an example the following values

Grid, Global, and Angle

Density=80

Thickness=0.70

Sharpness=0.30

3. Right-click the plane tool to display the Highlights Properties.

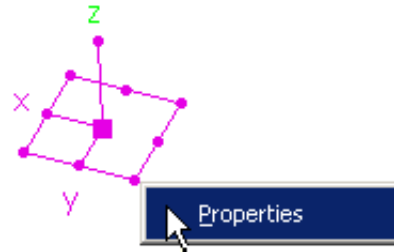

- Define the snap mode to snap tool position and optionally orientation on geometry
 - Off: no snap mode
 - Vertex: the plane tool snaps on a vertex. Dependent on the vertex (surface corner, 3D curve endpoint), the direction is adapted to the surface normal or curve tangent
 - Curve: the plane tool snaps on a curve or surface edge. As a result in stripes mode the silhouette line of the plane tool normal crosses the edge at the plane tool origin
 - Surface: the plane tool snaps on a surface and adapts the surface normal. As a result in grid mode the silhouette line of the plane tool u direction and the silhouette line of the plane tool v direction are crossing at the plane tool origin
- Define the rotation mode of the 3D tool:
 - **Dynamic**: normal dynamic rotation mode
 - **Discrete**: the rotation of the tool snaps to certain relative grid angles.
 - **Grid**: the rotation of the tool snaps to certain absolute grid angles.

- **Static:** the rotation is activated by a mouse click on the corresponding rotation handle of the tool. The grid value defines the specific rotation angle
- Define the rotation value by entering a value or using the spinners
- Define the numerical feedback of the 3D tool:
 - **Distance 3D:** direct distance between the start position of the translation and the current position
 - **Distance XYZ:** distance shown in x, y and z components of the current coordinate system
 - **Coordinates:** absolute position of the tool in the model coordinate system

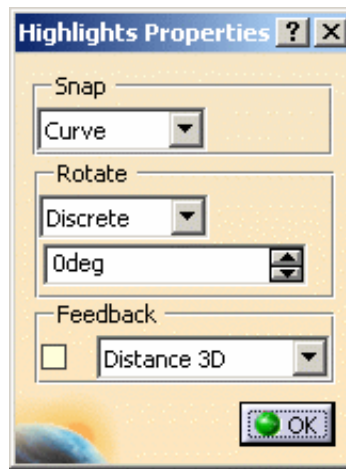



4. Click OK to create the analysis.

 For further information, please refer to the *CATIA Automotive Class A* documentation.



Generic Tools

This chapter deals with generic tools available in FreeStyle Shaper. These tools are available from the [FreeStyle Dashboard](#), the [Generic Tools](#), and the [Tools](#) toolbars:

  **Display dress-up options:** set the display options then apply or remove the visualization options on selected elements.

 **Display information on elements:** click the icon and select any element.

 **Display a part symmetrically:** select a part, and a mirror plane.

Analyze using parameterization: select the **Tools -> Parameterization Analysis...** command and define a filter for your query.

 **Manage the compass:** click the adequate icon in the displayed toolbar to define the compass orientation.

Use Manipulators: select a manipulator, move it close to geometry to detect another point to be used for projection or snap onto it, using auto-detection capabilities.

 **Create an axis system:** click the icon, and enter coordinates or select geometry to define the three axes.

 **Stretch view analysis tool:** set the stretching ratio.

 **Manipulate views:** click the adequate icon to freeze viewpoint manipulations.

 **Define views:** drag and drop the compass and click the icon to define the viewpoint.

 **Create datums:** click the icon to deactivate the History mode.

 **Perform symmetry on geometry:** select an element, then a point, line, or plane as reference element.

 **Keep the initial element:** click the icon and use another command to create/modify an element. The operation is performed on a copy of the original element.

 **Insert in a new geometrical set:** select this mode once you enter a command to create the result of the operation in a new geometrical set.

 **Create a temporary analysis:** select this mode once you enter a command in order to get a feedback on the connection quality.

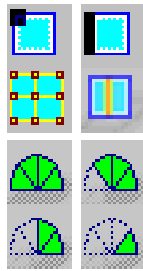

Auto-detection: specify the search type and set the auto-detection parameters.

Attenuate displacement: choose the attenuation value for the manipulators' step.



Display continuities on an element: select the element and click the icon to display a text indicating the continuity type on the element.



Display contact points on an element: select the element and click the icon to display the contact points and their manipulators on the element.



Display the tension on an element: select the element and click the icon to display the tension vector and value on the element.



Display orders along U or V: select the element and click the icon to display the order number along U and/or V



Display control points temporarily: click the icon to display control points on selected elements while another command is running.



Insert geometrical sets: select the branch where the new geometrical set should be inserted and choose the **Insert -> Geometrical Set** menu command.



Manage ordered geometrical sets: select the branch where the new linear geometrical set should be inserted and choose the **Insert -> Ordered Geometrical Set** menu command.

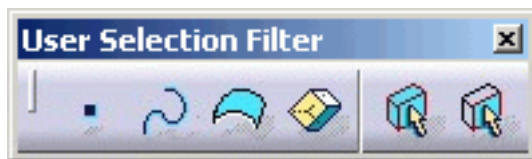

Select using a filter: select an object, and use the Selection Filter toolbar to manage element types and modes.

Select a Support: select a point, a curve, or a surface and right-click the pictographic tag to choose the support.

Select Using multi-output: select several elements, click **OK**. The Multi Output feature appears in the specification tree, grouping elements

Edit and keep a point: right-click a point, select **Edit** and/or **Keep this point** from the contextual menu.

Setting FreeStyle Visualization Options



 This task shows you how to display or hide permanent control points and curve/surface segments on FreeStyle Shaper elements for analyses purposes.

 Open the [VisuOptions1.CATPart](#) document, or any .CATPart document containing FreeStyle elements.

 **1.** Click the **Apply Dress-Up** icon .

The Dress-Up Options dialog box is displayed.

2. Set the type of visualization you want to apply to geometric elements.

You can choose:

- to display, or not, control points
- the control points type
- to display, or not, segments.

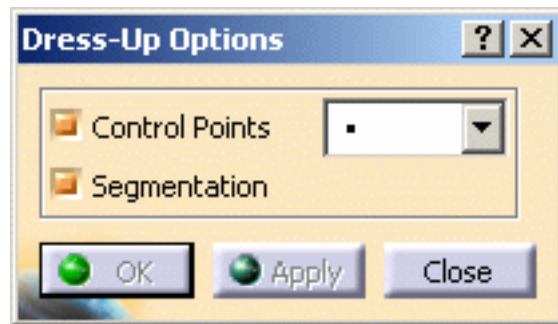

The **Isoparametrics by patch** is inactive but provides information on the number of isoparametric curves (dotted lines) per surface patch (delimited by solid lines).

3. Select the element on which you wish to display the control points.

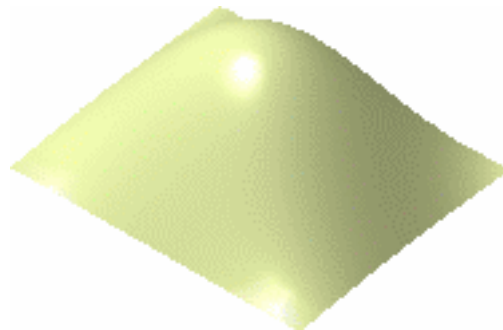

4. Click **Apply.**

The control points and mesh lines are displayed on the selected element.

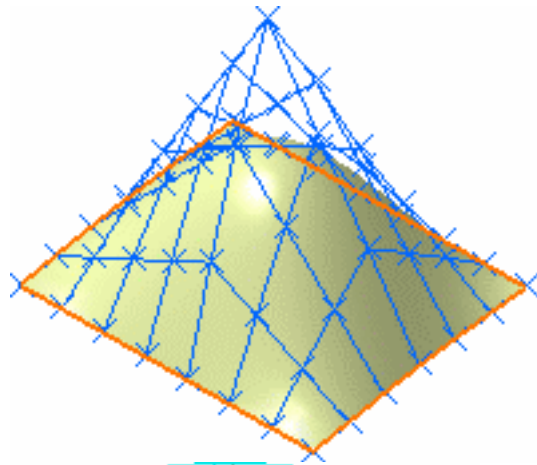

- 5. Activate the **Segmentation** option, uncheck the **Control Points**, then click **Apply**.**

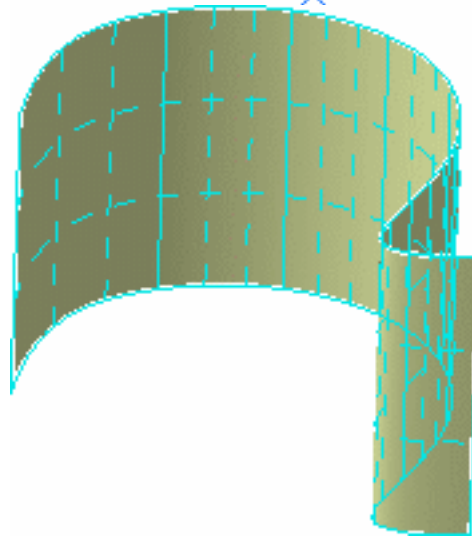

Contextual options

- a. When selecting an arc limit of a curve:
It enables you to either keep the arc limit you right-clicked or all the arc's limits.
- **Keep this arc limit:** a 3D point appears in datum mode in the specification tree
 - **Keep all arc's limits:** all the 3D points used to create the 3D curve appear in datum mode in the specification tree





- b. When selecting the patches limits of a surface:
- **Keep all patches limits:** all the 3D curves used to create the patch limit appear in datum mode in the specification tree.

Note: only patches limits are created. Therefore patches limits do not necessarily correspond to surfaces limits (in the case of trimmed surfaces for instance).

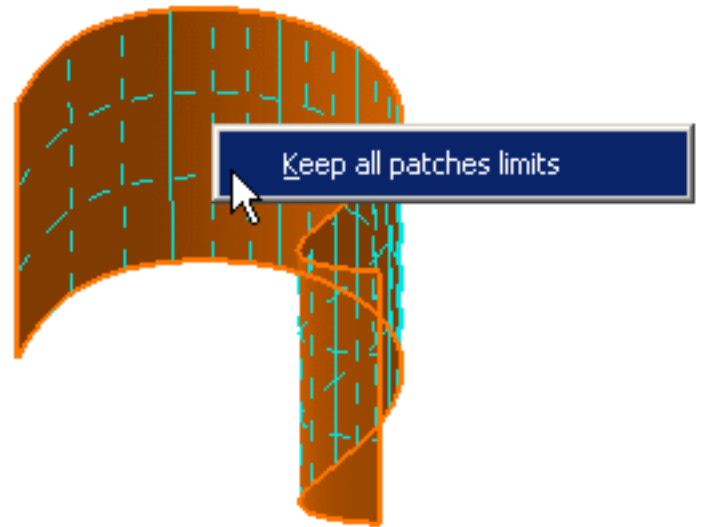

If you wish to create the 3D points or curves in a new geometrical set instead of the current geometrical set, click the **Insert In a New Geometrical Set**  icon from the FreeStyle Dashboard. As the 3D points and curves are created in a private body, its content cannot be modified: you cannot delete or add elements.

As long as the icon is active, a new geometrical set is created each time you run the Dress-Up command.

6. Click OK.

The visualization options are as defined by the user and remain on the selected elements till you click the **Remove Visualization Options** icon , or till you modify them using the Dress-Up Options dialog box again.



The visualization options are applied globally to the document, meaning that you can apply different options to several elements, but if you save, close then open the document again, the **options defined last** will be applied to all the elements on which visualization options have been set.



- No modification is possible on the control points, as opposed to using the **Control Points** icon  as described in [Editing Surfaces Using Control Points](#) or [Editing Curves Using Control Points](#).
- Multi-selection applies with these display capabilities:

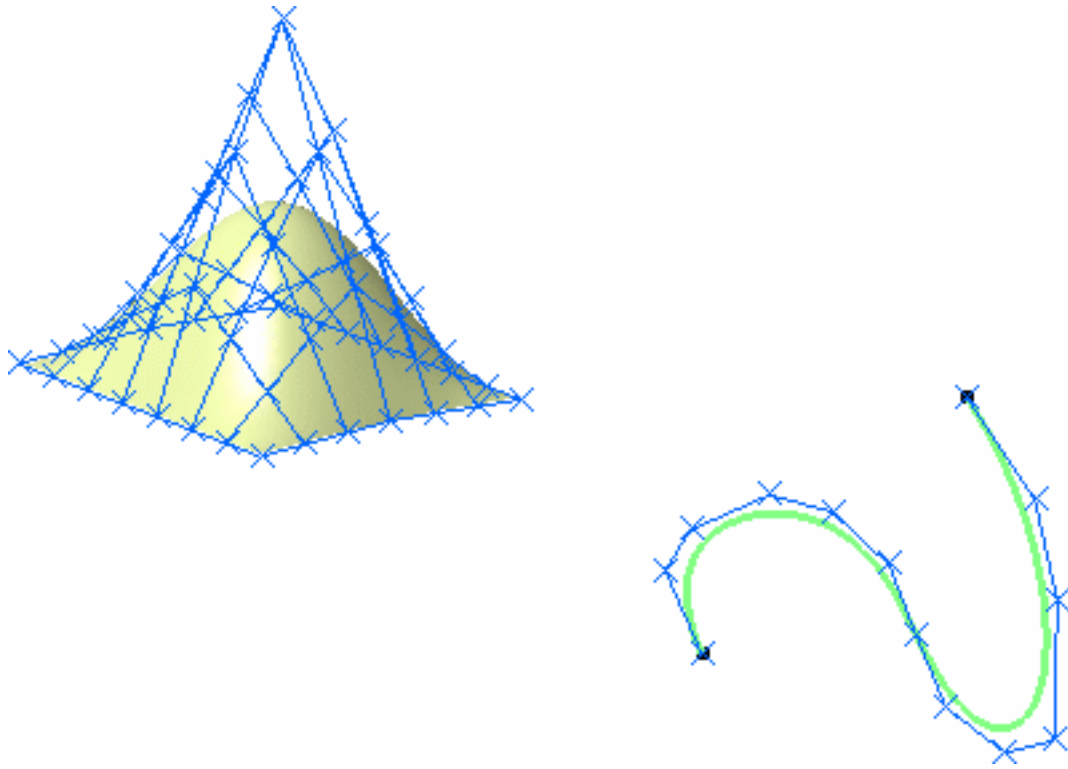

 Capabilities available from the FreeStyle Dashboard are [datum creation](#) and [insert in a new geometrical set](#).



Displaying Geometric Information On Elements



This task shows you how to display or hide geometric information on geometrical elements, such as any curve, or surface, either as a stand-alone element, or taking part in the composition of another element (intersection curve, cylinder axis, face of a pad, and so forth).

Only geometry of topological cells is analyzed, therefore elements such as Cloud of points, for example, are not analyzed.



Open the [GeometricInformation1.CATPart](#) document, or any .CATPart document containing geometrical elements.



1. Click the **Geometric Information** icon .

2. Select the element for which you want to display information either in the geometric area or in the specification tree.

The Geometric Analysis dialog box is displayed.

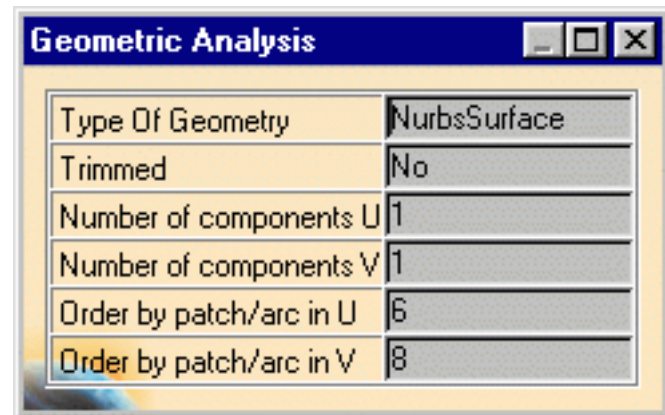

Information, such as:



- the element type (Nurbs surface or curve, Pline, planes, etc.)
- whether the element has been trimmed, or not
- the number of segments (components) in both U & V direction (where applicable)
- the order of the element in both U & V direction (where applicable)

is displayed in the dialog box.

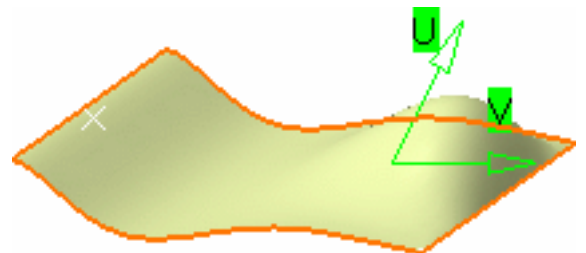
Moreover, a vector representing the element's orientation (U for a curve, and U & V for a surface) is displayed on the geometrical element itself.



 In the case of a 3D curve created using the Control Points type, the maximum order is 6.

-  • Uncheck the **Geometric Information** icon  to exit the command, or simply click another icon.
- You cannot select an element from the specification tree as the selected element might be too complex (i.e. be composed of more than one cell) and the system cannot determine which element is to be analyzed.

- You can stack this command on top of the current command, i.e. that you editing an element using its control points, you can activate the **Geometric Information** icon. The current command is frozen, and when you exit the information command, you are back into the initial command.

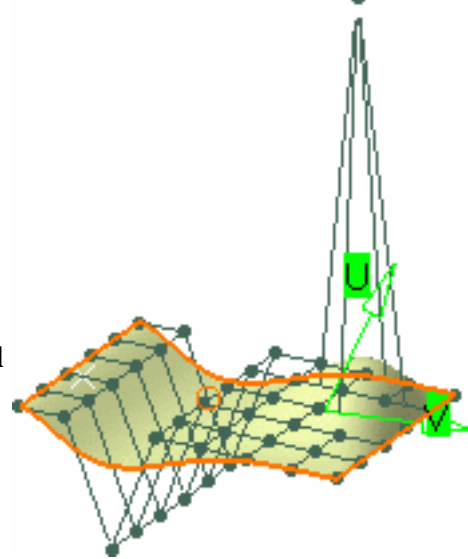

 The geometry type is categorized as follows:

Displayed Type	What is it ?
NupbsCurve	Non Rational NURBS Curve
NupbsSurface	Non Rational NURBS Surface
NurbsCurve	Rational NURBS Curve
NurbsSurface	Rational NURBS Surface
PNupbs	Parametric non rational curve on a surface
PNurbs	Rational parametric curve
PSpline	Parametric curve on a surface
PLine	Isoparametric curve on a surface
Line	Line or line segment
Plane	Plane or planar face
Cylinder	Cylinder
Helix	Helix
FilletSurface	Procedural Fillet surface
SweepSurface	Procedural Sweep surface
Tabulated Cylinder	Procedural Extrude surface
IntCurve	Intersection curve, that is resulting from the intersection of two surfaces
MergedCurve	The aggregate of two curves with different limits or parameterizations



Displaying a Part Symmetrically



This task shows you how to visualize a part symmetrically in relation to a plane, in a product context. This allows you to work on half of the geometry only, therefore with a smaller document size-wise, but to view the final element as a whole.



Open the [Product_to_symmetrize.CATProduct](#) document.



1. Expand the tree down to the Part5, then double-click it.

The Part5.CATPart now can be edited within the FreeStyle Shaper workbench.

2. Click the **Visual Symmetry**  icon.

3. Select the Part to be mirrored from the specification tree.

4. Select the mirror plane.
It can be a plane or any planar face that the system recognizes as a plane (a planar face of a pad, for example, and so forth).

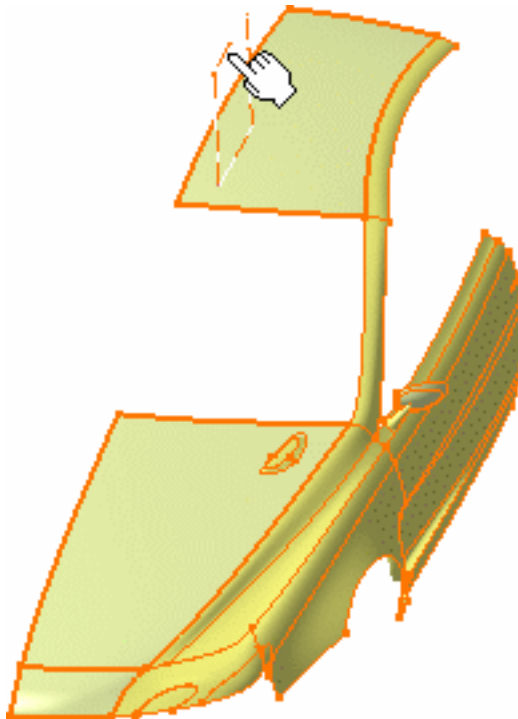

A part, symmetrical in relation to the selected plane, is displayed.

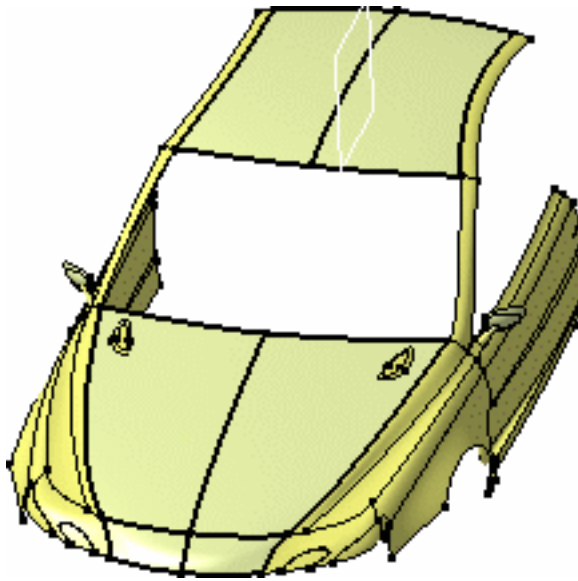

The part is also duplicated in the specification tree. However, even though it will be saved within the document, this part cannot be edited as geometry. It is modified only as the result of modifications performed on the initial part:

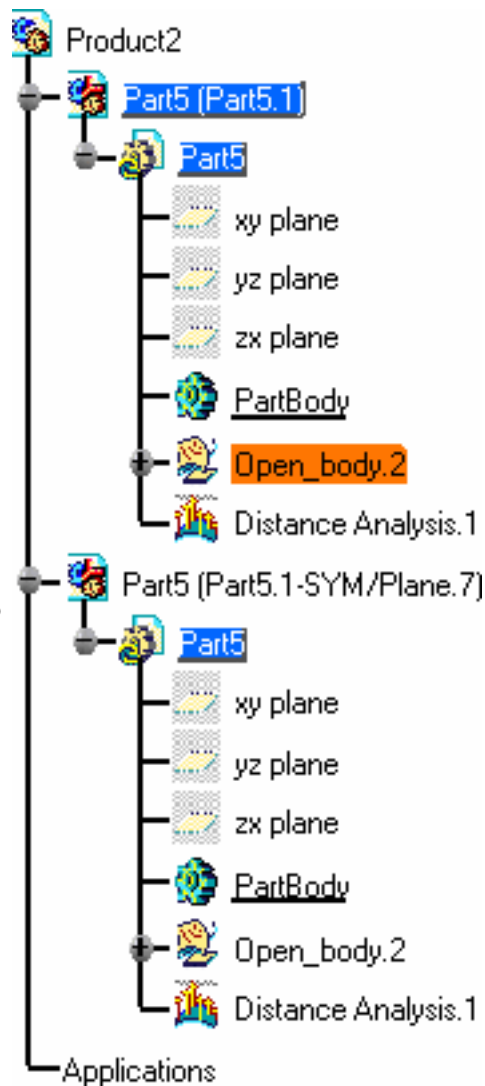

Indeed you are not even allowed to select the mirrored elements in the geometry.

If you select a mirrored element in the specification tree, you will note that the highlighted geometry belongs to the initial part.

5. Click the **Control Points** icon .

The Control Points dialog box is displayed.

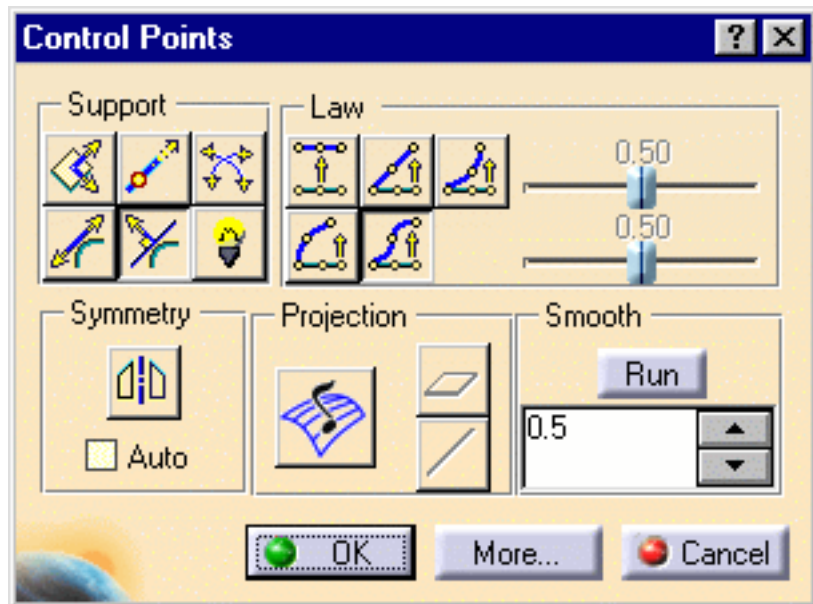

6. Choose the adequate options and modify the initial part as needed.

The mirrored part reflects exactly the modifications imposed on the initial part.

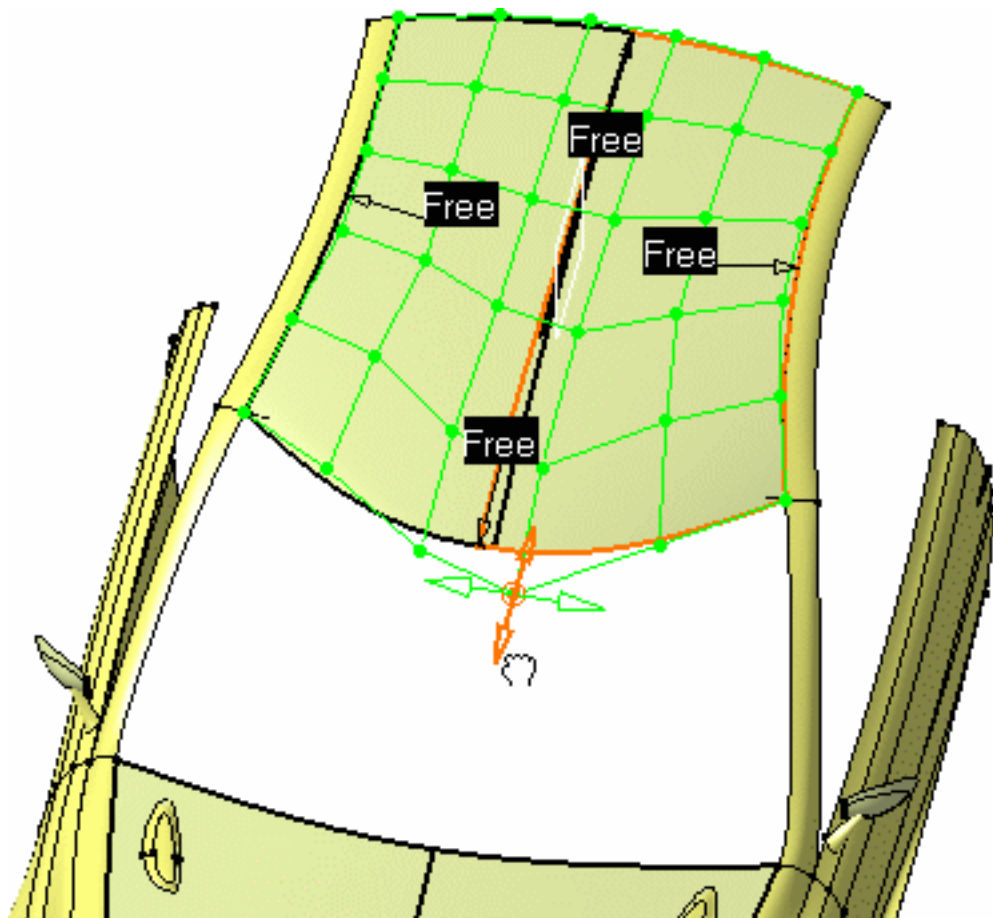

7. Click OK in the Control Points dialog box.

You can then save and close the .CATPart and .CATProduct documents. The mirrored part is retained, and is present when you open these documents again.



Analyzing Using Parameterization

 This task enables to analyze the CATPart structure and shows how to isolate specific features within a part. This is particularly useful when managing power copies, for example.

 Open the [Parameterization1.CATPart](#) document.

1. Select **Tools** -> **Parameterization Analysis...**

The Parameterization Analysis dialog box displays.

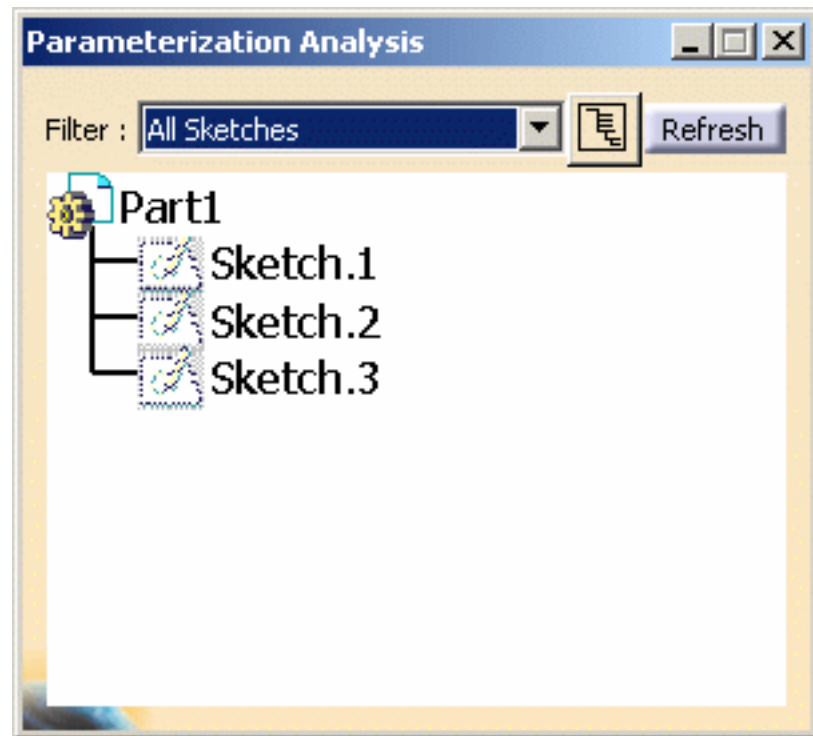

2. Use the Filter combo and choose to display Root Features.

The query is launched and the viewer automatically updates.

Deactivated features as well as datum features are displayed.

However, if you want to display deactivated features only, select the Inactivated Features filter. Similarly, select the Isolated Features filter to display both deactivated and datum features.

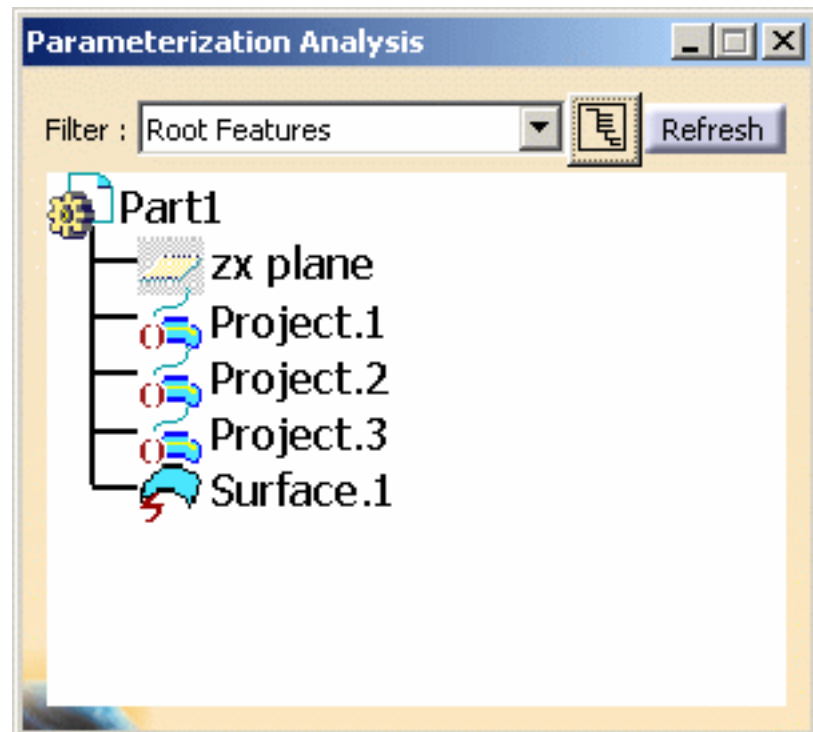

3. Click the **Display Body Structure** icon



to display the graph keeping the tree structure.

Each feature is displayed within its own body.

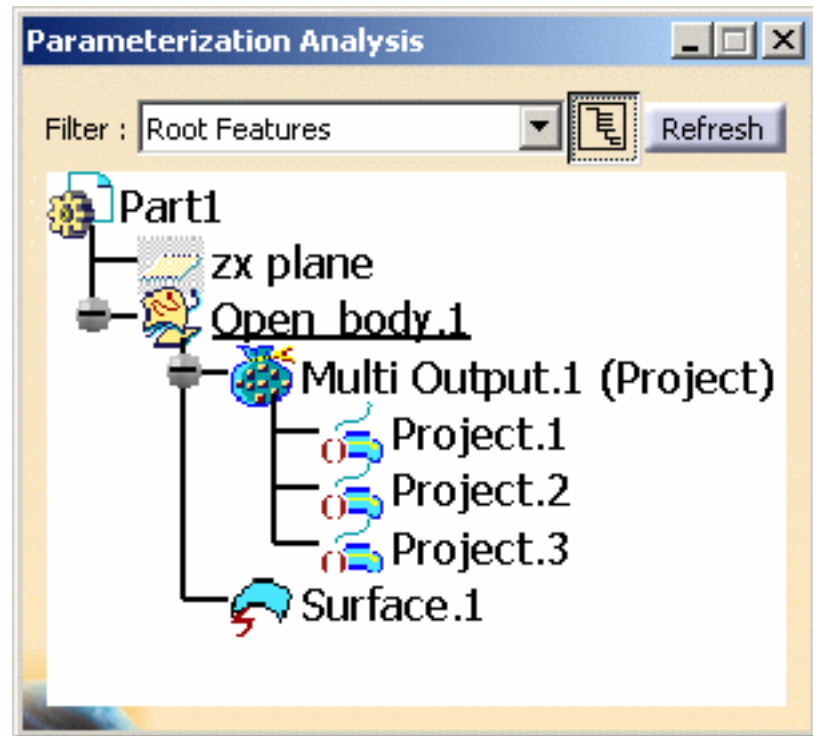

- Features displayed in the viewer can be used in the same way as in the specification tree: double-click a feature to edit it, or use the contextual menu to reframe on or display its properties, for example.
- The viewer can still be open while performing other operations.
Available filters are:
 - All Sketches
 - Over-constrained sketches
 - Fully-constrained sketches
 - Under-constrained sketches
 - Inconsistent sketches
 - External references
 - Inactivated features
 - Root features
 - Leaf features
 - Isolated features
 - Feature in error
 - Waiting for update features
 - Features with stop update
 - Features with active stop update
 - Knowledge formulas, Rules, and Checks



Managing the Compass

 This task shows you how to quickly manage the compass orientation.

 Create a planar surface.

 Press F5 or click the **Quick Compass Orientation** icon  .



The Quick compass orientation toolbar is displayed.

Here are summarized the main features of its eight icons:





- Click the **Flip to UV or XY**  , **Flip to VW or YZ**  or **Flip to WU or XZ**  icon to switch the compass base to the three planes of its trihedron.

If the compass is "in" the main axes of the model, the icons indicate X, Y and Z otherwise U, V and W.

- Click the **Most Seen Plane** icon  to activate and deactivate the **Most Seen Plane** mode.
- Click the **Set Compass Orientation** icon  or press F6 to orientate the compass by selecting either an existing plane or three points (via the Autodetection command). The point selection is based on Autodetection parameters.



 Please refer to the chapter called Editing Curves Using Control Points documentation to orientate the compass using control points.

- Click the **Reset Compass to XYZ** icon  or press F7 to reset the compass parallel to the main axes (X, Y and Z) of the model.
This option is not active when the compass is already set according to the axes.
- Click the **In Model or on Perch** icon  to switch the compass from the perch to the model or vice versa.
The origin is kept in the model until the toolbar remains open.
- Click the **Create Compass Plane** icon  or press F8 to drop the compass plane, that is to create a plane corresponding to the compass basis.
This icon is activated only when the compass is in the model.

These four shortcuts (F5, F6, F7 and F8) are effective only when the Quick compass orientation toolbar is displayed. Therefore when you first hit one of the keys, the toolbar is displayed and the shortcuts are effective from then on.

The Quick compass orientation toolbar remains active until you close it by clicking the cross in the upper-right corner or, if you have activated it with the icon, by clicking the icon again.



By default, elements are created in the current active plane as defined using the Current plane orientation toolbar containing the **Flip to UV or XY** , **Flip to VW or YZ**  or **Flip to WU or XZ**  icons.



Using Manipulators



When working with the FreeStyle workbench a number of manipulators are displayed, allowing you to modify the shape of curves and surfaces. These manipulators are displayed as green dots with two to four arrows, depending on whether they are constrained in a given plane or allowed to move freely in space, respectively.

When using the Control Points capability ( icon) the points are constrained according to the chosen **Support** and **Law** options (see [Editing Curves Using Control Points](#) and [Editing Surfaces Using Control Points](#)).



Open the [Manipulate2.CATPart](#) document.



1. Select both surfaces.
2. Click the **Control Points** icon .
3. Click the **Snap on Ctrl points** in the Dashboard.
4. On the blue surface select only one control point.
All other points turn to green and the selected point is highlighted.

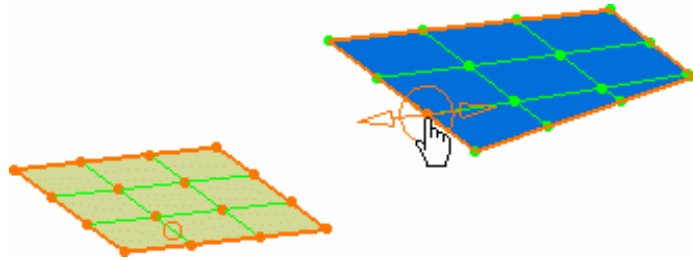

5. Move this point close to the other surface.

As the pointer nears a control point onto the other surface, the **Use this point** text is displayed, and the point on the second surface is identified by a dotted circle.

If you release the mouse button then, the selected point on the blue surface is located at the orthogonal projection to the point detected on the second surface, onto the support as defined in the dialog box. This projected location is identified by a red circle connected to the detected point on the second surface by a dotted line.

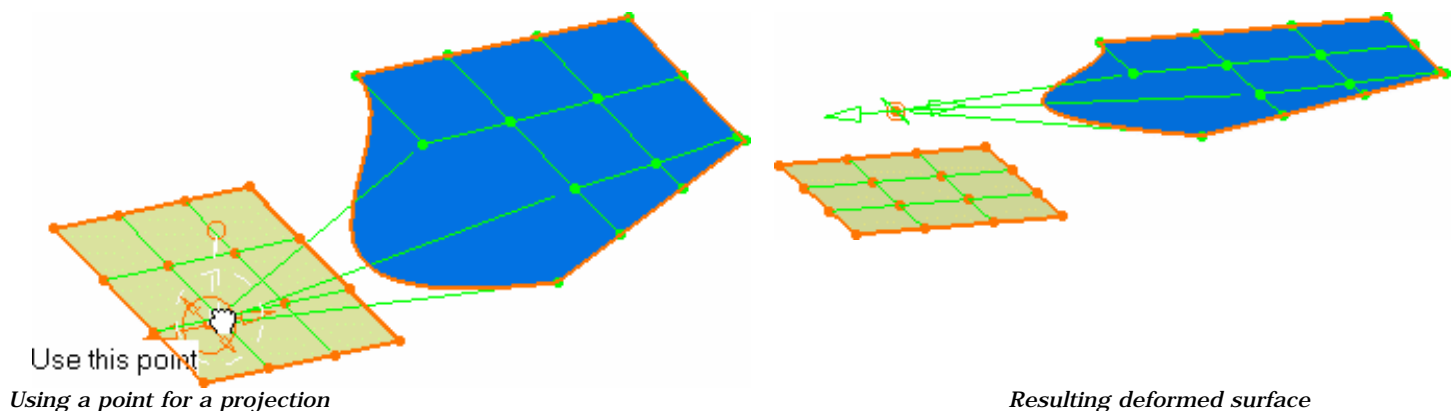

i An alternative method consists in selecting the first (yellow) surface first, clicking the Control points icon, then selecting the second (blue) surface. In this case, the first surface's control points turn gray and remain frozen. This is especially useful when using the **Move selected points identically** option from the Control Points dialog box, and in P1 mode.

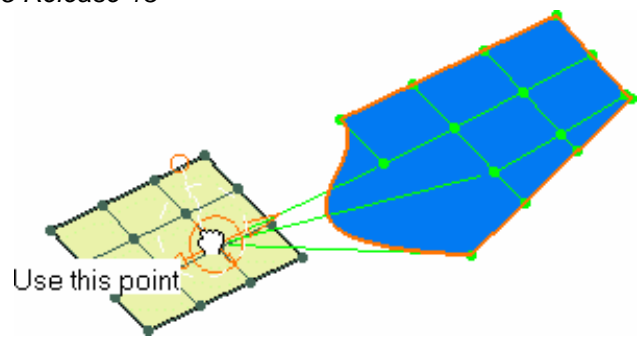

P2 6. Press the Control key: the text changes to **Snap on this point**.

In this case, the selected point is moved exactly to the location of the point on the second surface identified as the point to be snapped to, as if they were merged.

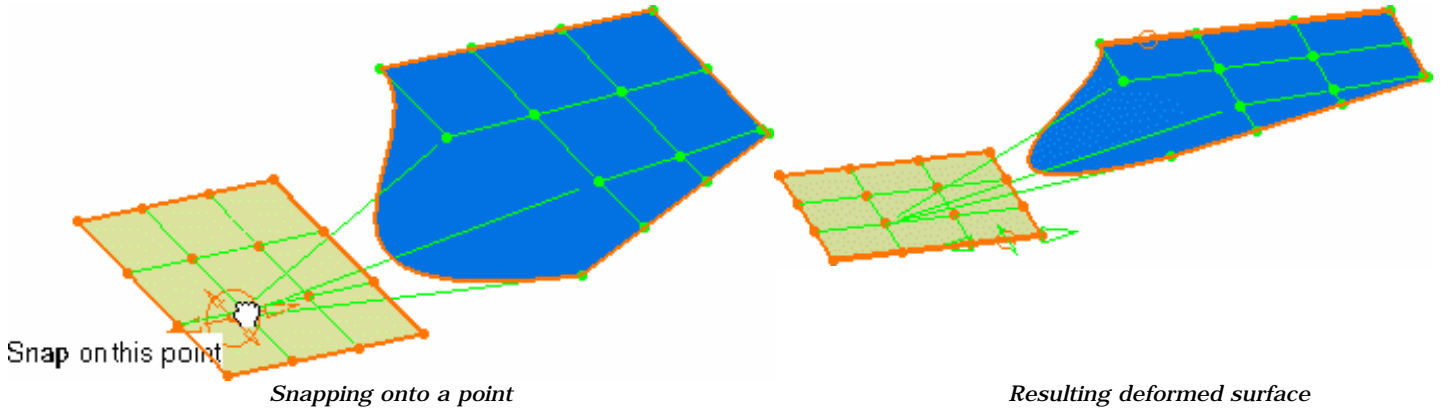

The snap onto a point is possible only when the selected point is not constrained onto a specific element. For example, when matching the two surfaces, the manipulators are only allowed to move, and snap on points, along the other surface's edges. Using a point or snapping onto it is identical, as the manipulators are constrained on the surface's edge:

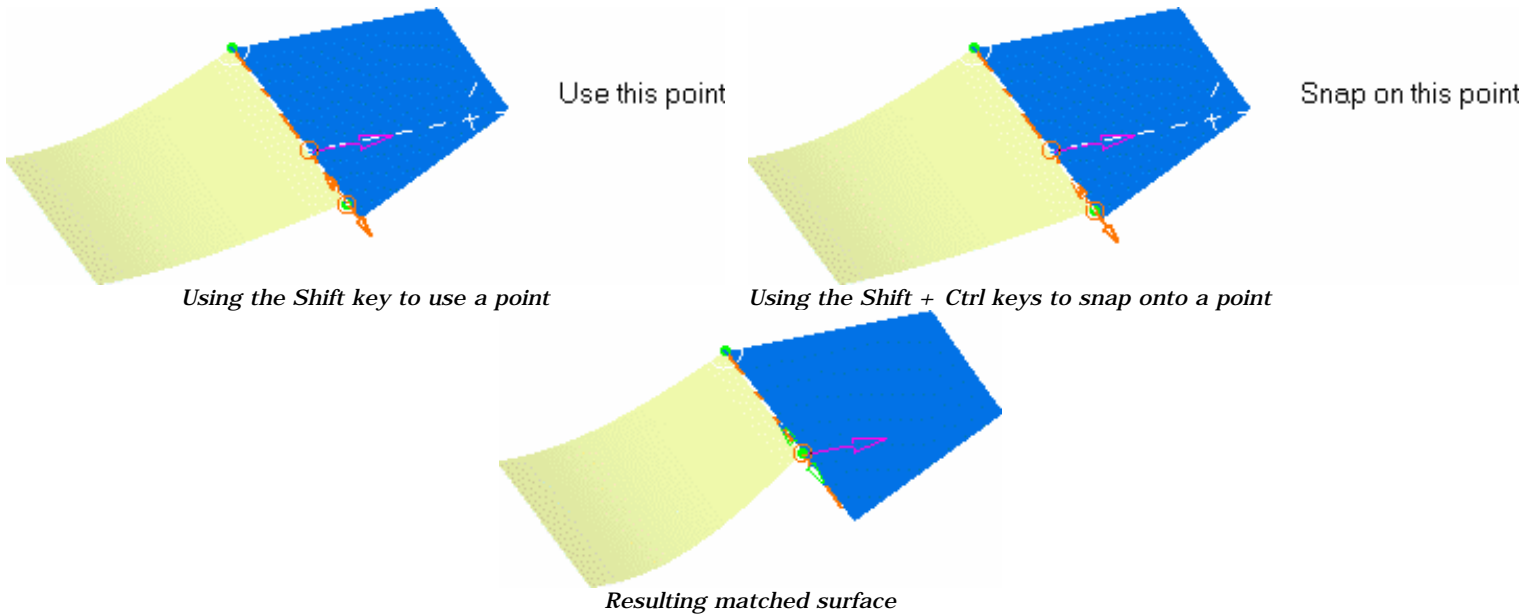

Capabilities are also available from the contextual menu when right-clicking a control point, and depending on the geometry, with the following capabilities:

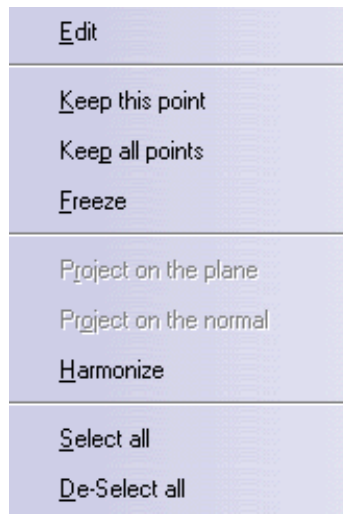

a. **Edit**: the Tuner dialog box is displayed, letting you

-specify the exact position of the control point in space

- define a step value by which a control point/mesh line moves (**Step** field).

Once the value has been defined in the Tuner dialog box, press and hold the Shift key then click one of the manipulator's arrow to move the selected control point by the defined step value.

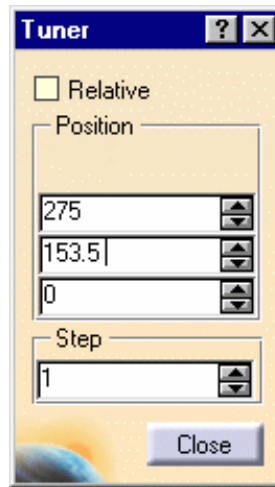

b. **Keep this point**: allows you to keep the current point at its location.

A Point.xxx appears in the specification tree

c. **Keep all points**: allows you to keep all the control points
All the points appear in the specification tree

d. **Freeze**: enables to set control points inactive according to the defined constraint.

e. **Project on the plane**

f. **Project on the normal**

g. **Harmonize**

h. **Select All**: enables to select all control points

i. **De-Select All**: enables to de-select all control points



Note that using the contextual menu on an element, when several element have been selected, applies the chosen capability on this element only, and not on the whole selection. However, if you apply the same capability from the Control Points dialog box, a given all the selected elements will be affected.



- Use the F5 key to move the manipulators into a different plane of the compass, when they are not constrained within a given direction. See [Managing the Compass](#).
- Use the Shift key to activate/deactivate temporarily the [auto-detection](#) capability on the point you are currently trying to snap, or not, to another element.
When no auto-detection mode is active, manipulators will be snapped onto corners or onto another manipulator.



Snapping is available in P2 mode only.



Defining an Axis System



This task explains how to define a new three-axis system locally. There are two ways of defining it: either by selecting geometry or by entering coordinates.



Open the [PowerCopyStart1.CATPart](#) document.



1. Select the **Insert -> Axis System** command or click the **Axis System** icon .

The Axis System Definition dialog box is displayed.

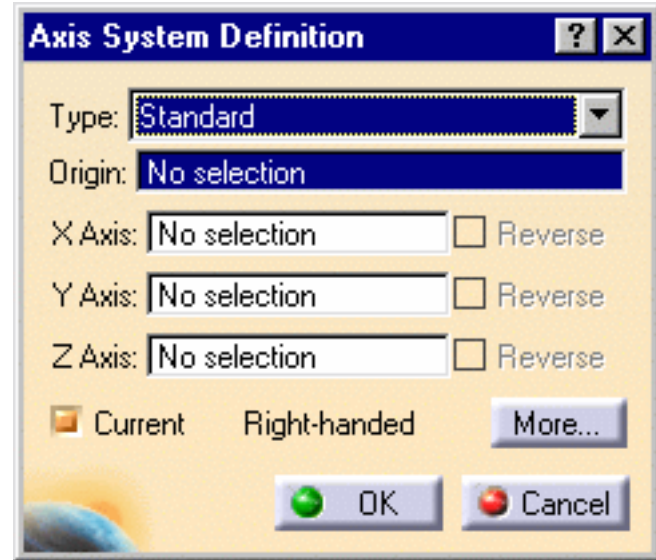

An axis system is composed of an origin point and three orthogonal axes. It can be **right or left-handed**. This information is displayed within the Axis System Definition dialog box. You can choose from different types of axis system:

- **Standard:** defined by a point of origin and three orthogonal directions (by default the current directions of the compass)

Here only the point was selected and nothing specified for the axes.

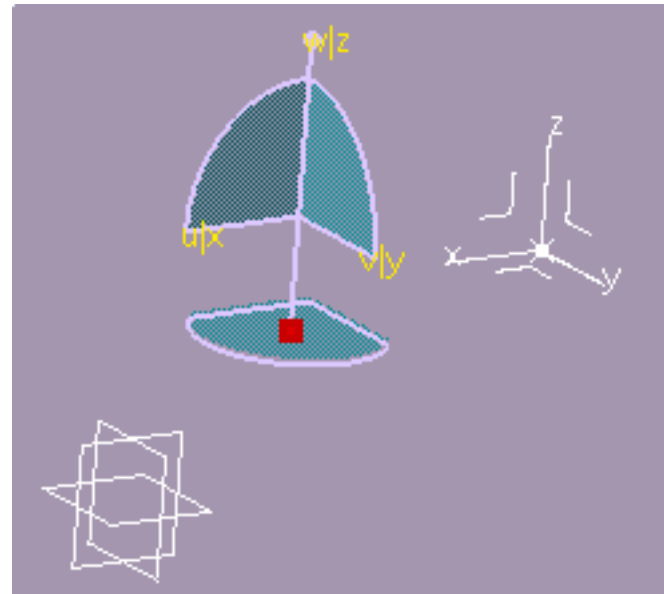

- Axis rotation: defined as a standard axis system and a angle computed from a selected reference

Here the Y axis was set to the standard axis system Y axis, and a 15 degrees angle was set in relation to an edge parallel to the X axis.

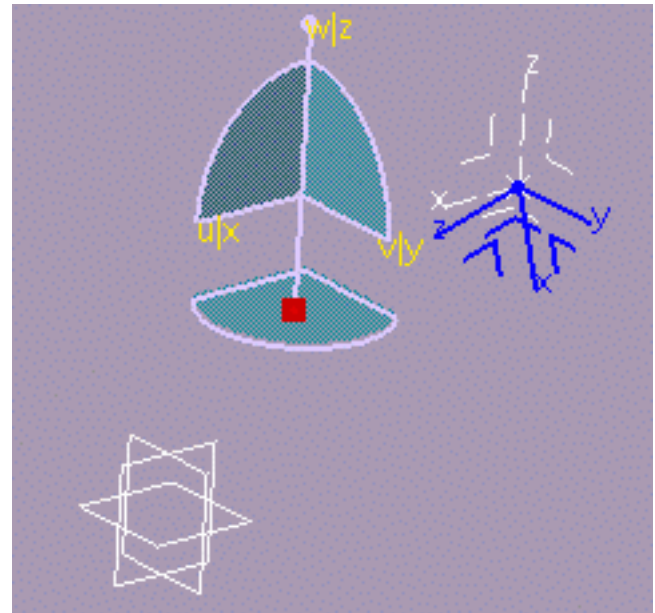

- Euler angles: defined by three angle values computed from the initial X, Y, and Z directions

Here, the **Angle 2** and **Angle 3** were set to 30 degrees.

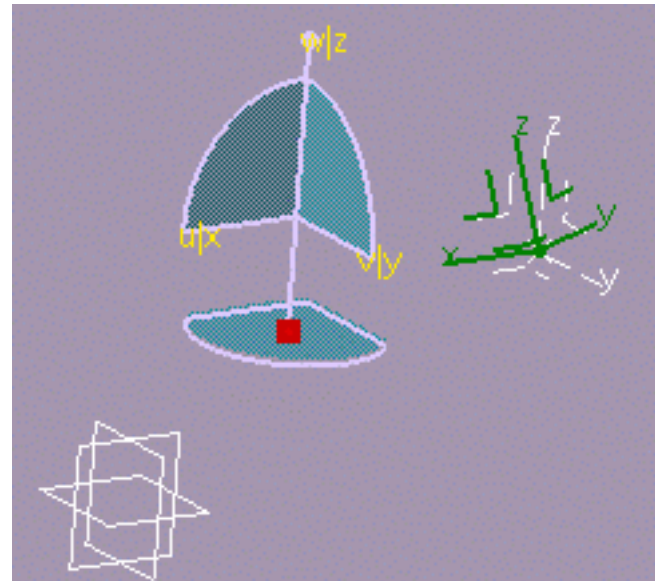

2. Select the point as shown to position the origin of the axis system you wish to create. The application then computes the remaining coordinates. Both computed axes are then parallel to those of the current system. The axis system looks like this:

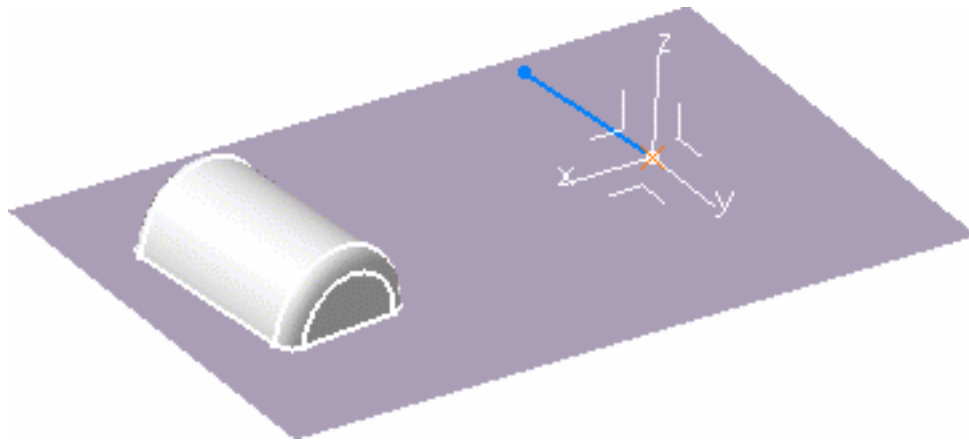

3. If you are not satisfied with x axis, for instance click the X axis field and select a line to define a new direction for x axis.

The x axis becomes colinear with this line.

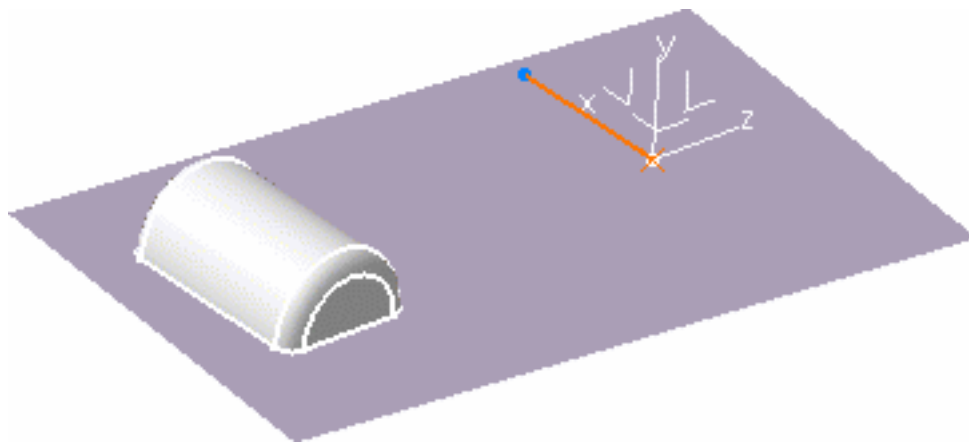

- It can be a **line** created along the surface edge, for example, using the Create **Line** contextual menu on the selection field, and selecting two surface vertices. Similarly you can create **Points**, and **Planes**.
- You can also select the **Rotation** contextual menu, and enter an angle value in the X Axis Rotation dialog box.

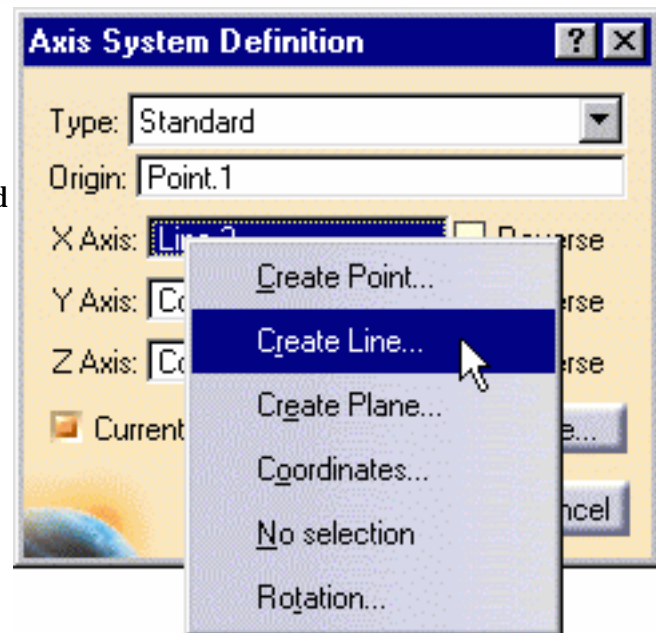

4. Click the y axis in the geometry to reverse it.

Checking the **Reverse** button next to the **Y Axis** field reverses its direction too.

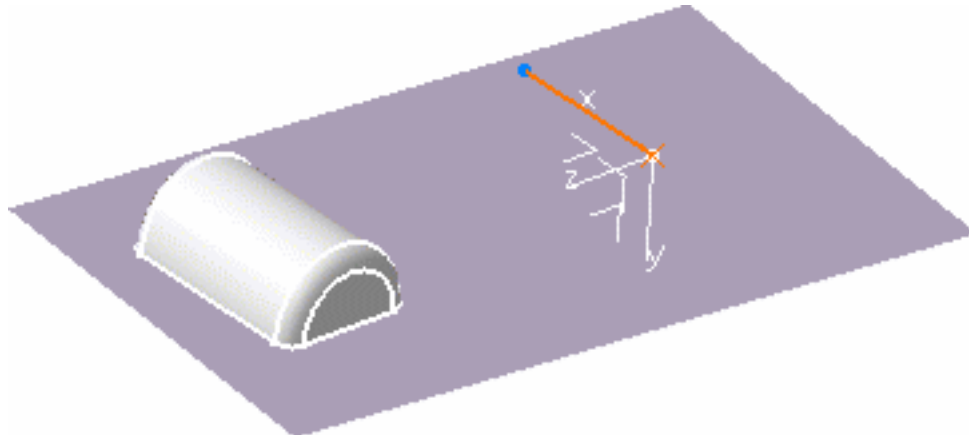

5. You can also define axes through coordinates.

Right-click the Z Axis field and select the **Coordinates** contextual command. The Z Axis dialog box appears.

6. Key in $X = -1$, retain the Y and Z coordinates, and click Close.

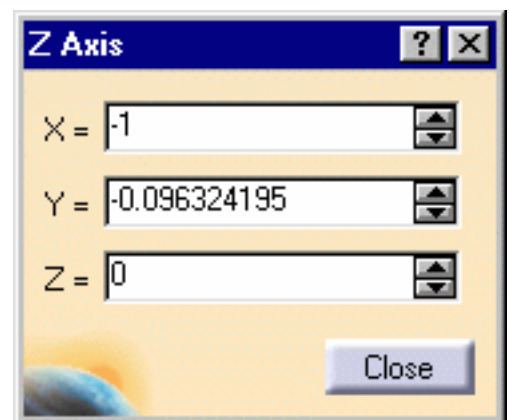

The axis system is modified accordingly, and is now **left-handed**.

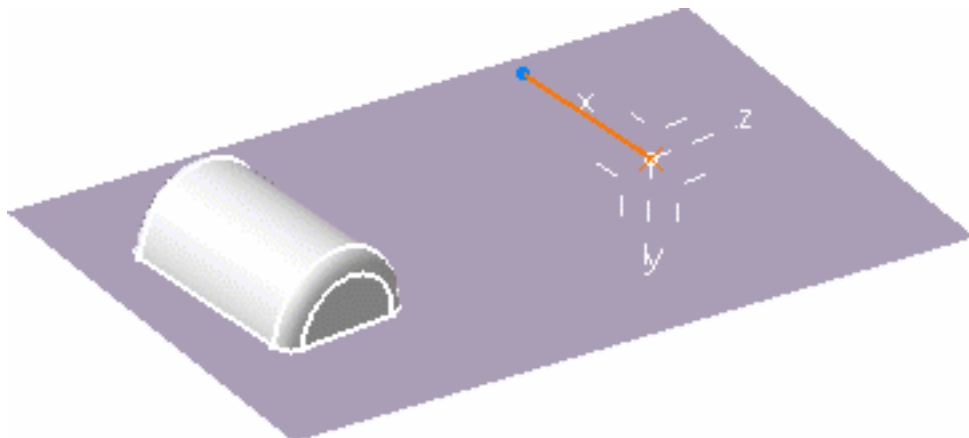

7. Click More to display the More... dialog box.

The first row contains the coordinates of the origin point. The coordinates of X axis are displayed in the second row. The coordinates of Y and Z axis are displayed in the third and fourth row respectively.

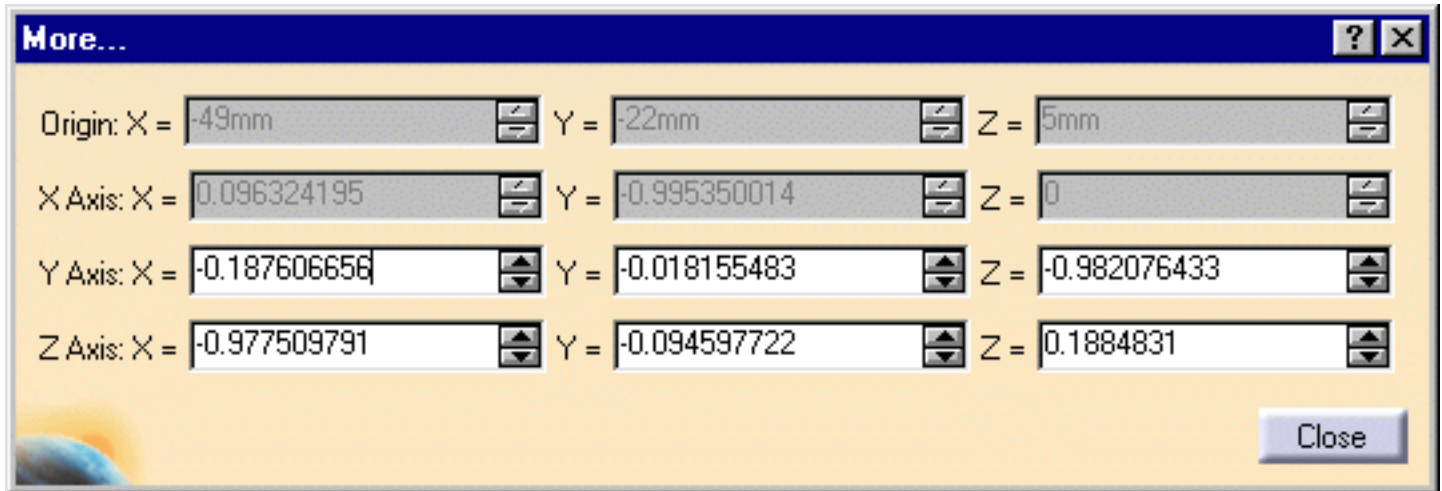

As you are defining your axis system, the application detects if its axes are orthogonal or not. Inconsistencies are revealed via the Update diagnosis dialog box.

8. Uncheck the Current option if you do not want to set your axis as the reference. The absolute axis at the bottom right of the document then becomes the current axis system.

9. Click OK.

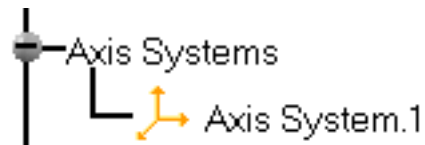

The axis system is created. It is displayed in the specification tree.

When it is set as current, it is highlighted as shown aside.

Local axes are fixed. If you wish to constrain them, you need to isolate them (using **Isolate** contextual command) before setting constraints otherwise you would obtain over-constrained systems.



The display mode of the axes is different depending on whether the three-axis system is right-handed or left-handed and current or not.

THREE-AXIS SYSTEM	CURRENT	AXIS DISPLAY MODE
right-handed	yes	solid
right-handed	no	dashed
left-handed	yes	dotted
left-handed	no	dot-dashed



Right-click Axis System.1 from the specification tree and select the **Axis System.1 object -> Set as current** contextual command. Axis System.1 is now current. You can then select one of its plane, to define a sketch plane for example.

Editing an Axis System

You can edit your axis system by double-clicking it and entering new values in the dialog box that appears. You can also use the compass to edit your axis system.

Note also that editing the geometrical elements selected for defining the axes or the origin point affects the definition of the axis system accordingly.

Right-clicking Axis System.X object in the specification tree lets you access the following contextual commands:

- **Definition...**: redefines the axis system
- **Isolate**: sets the axis system apart from the geometry
- **Set as Current/Set as not Current**: defines whether the axis system is the reference or not.



P2

 This command is only available with the FreeStyle Optimizer.

 This task shows how to use the stretch view tool prior while analyzing a FreeStyle element.

Stretching means distorting the space view, without affecting the element itself. It is especially useful to examine precisely the curvature of an element from different viewpoints and with specific angles.

This stretching is done according to a ratio between the Y and X axes (Y/X) taking the screen as a reference into the active window.

 Open the [Stretch1.CATPart](#) document.

To make it more explicit, we choose to open two windows (**Window -> New Window**) and to display them horizontally (**Window -> Tile Horizontally**).

 **1.** Select a surface and click  to display the control points on the surface in both windows.

The Control Points dialog box is displayed.

2. Click the **Stretch View** icon .

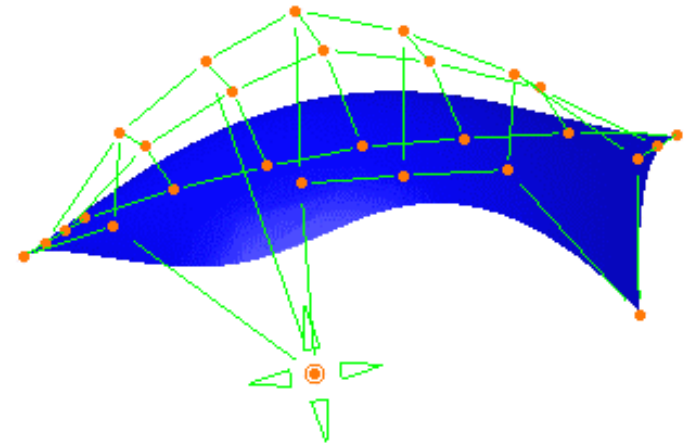

The control points are grayed out, meaning you cannot use them for geometry modifications, and the Stretch View dialog box is displayed:



3. Modify the value in the Stretch View dialog box.

With a value of 0.5, the geometry looks like this:

With a value of 1.5, the geometry looks like this:

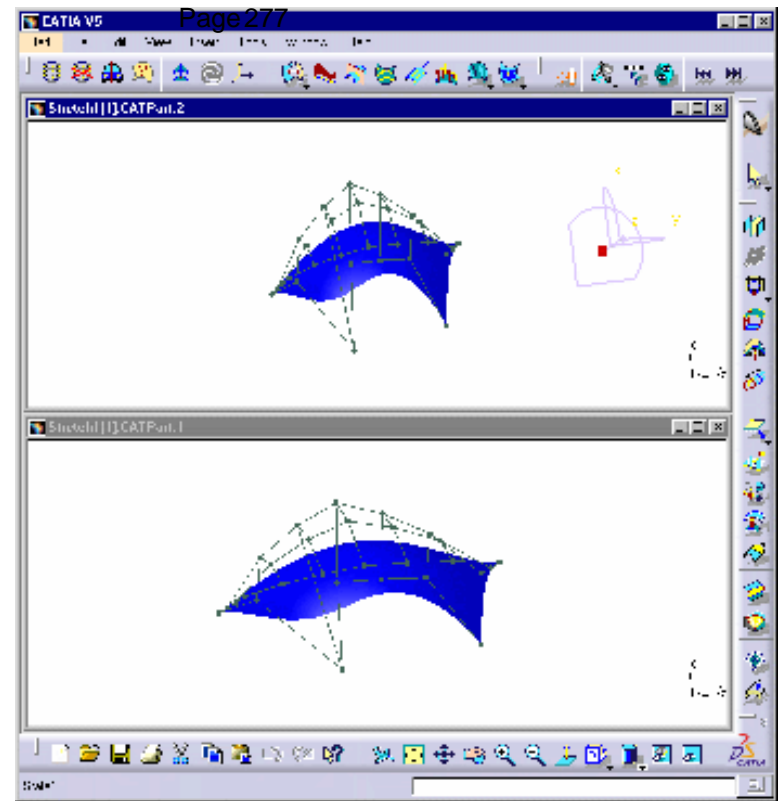
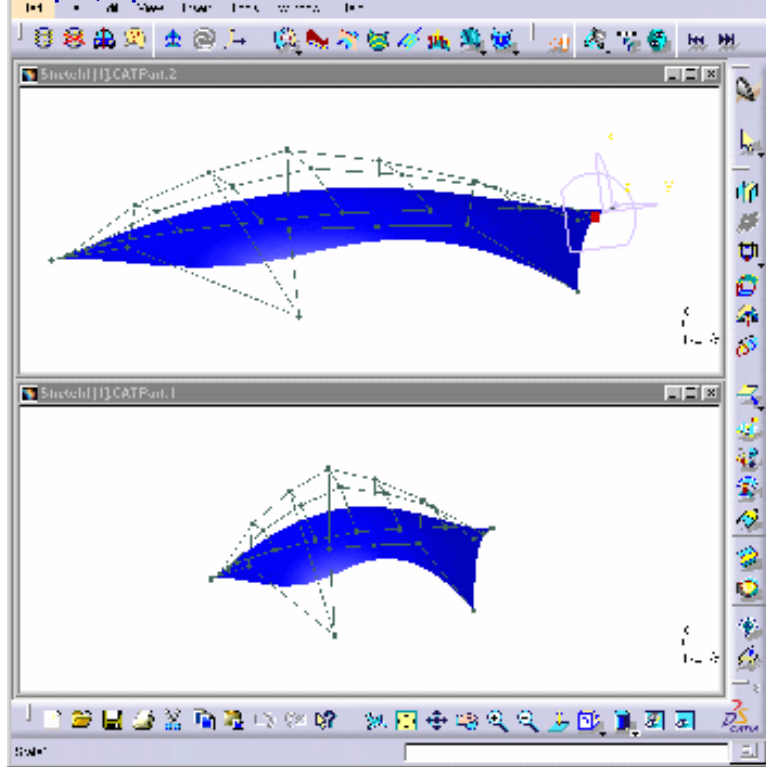

4. Click Reset.

The default value is taken into account (1.00). The view no longer is stretched.

You could also stretch a specific area of the screen, using a trap.

The center of the trap (cross) becomes the center of the screen.
Using the Ctrl-key, the trap center will be located where you click first.

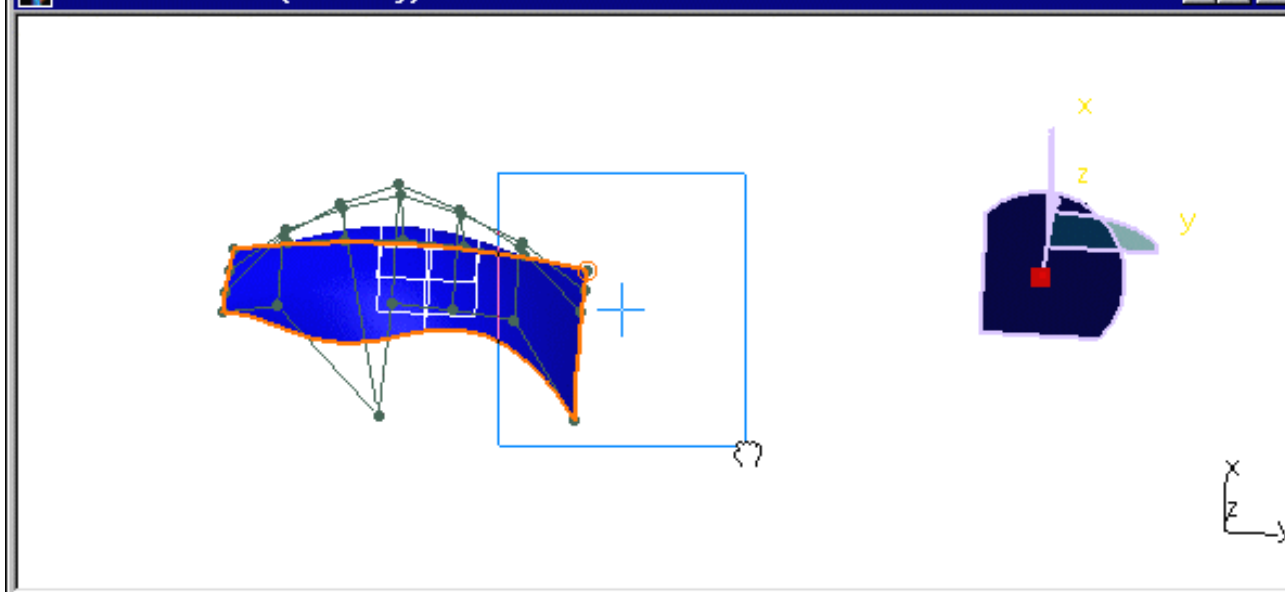

The resulting stretch looks like this:

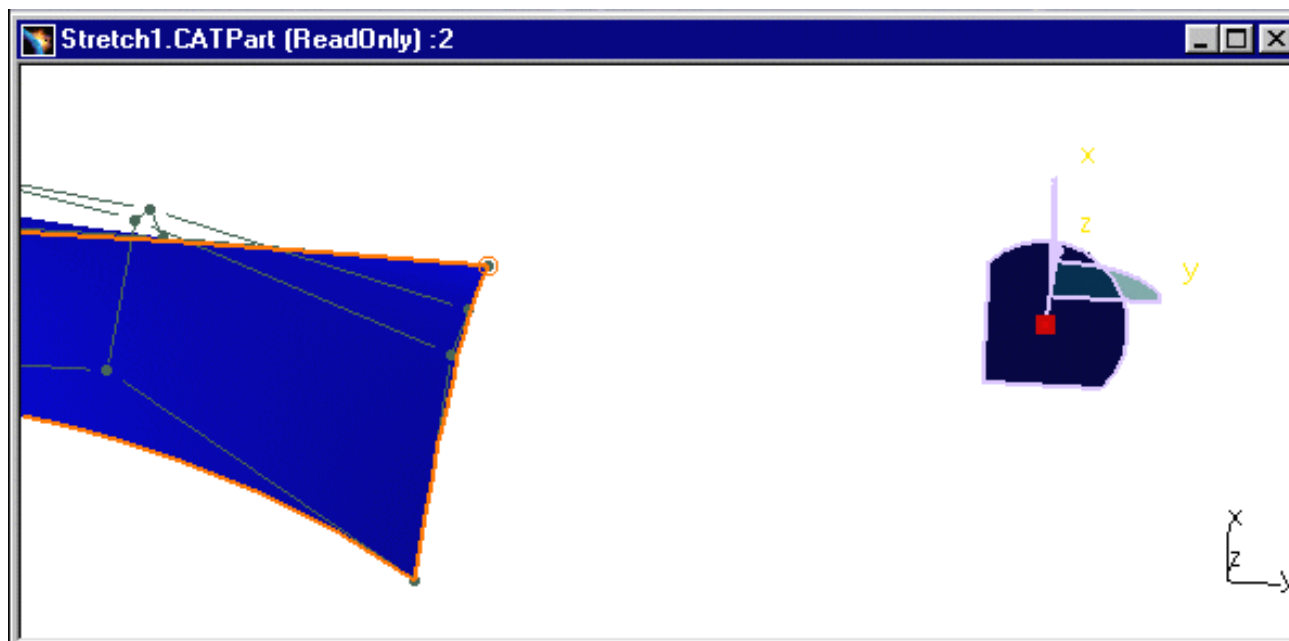

5. Click Close, the views remains, and you can continue to deform the surface as you wish, using the control points.



- Whatever the stretch options you choose, you can continue to use any other FreeStyle Shaper or Optimizer capability. For example, you could apply the Curvature analysis. To the left the curvature analysis with no stretch, and to the right, the stretched curvature analysis.

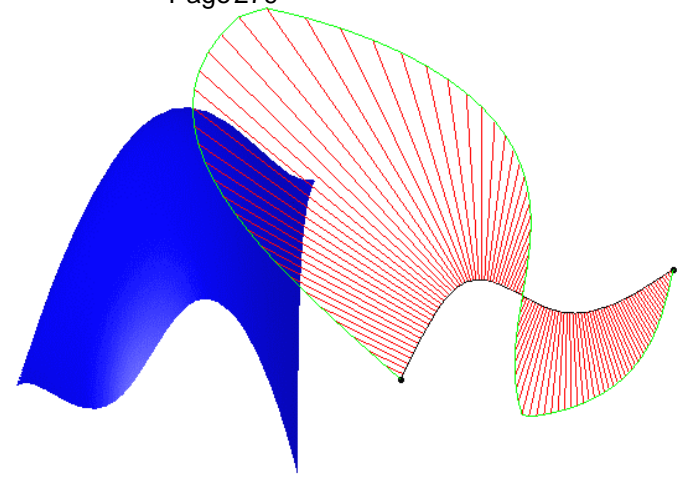
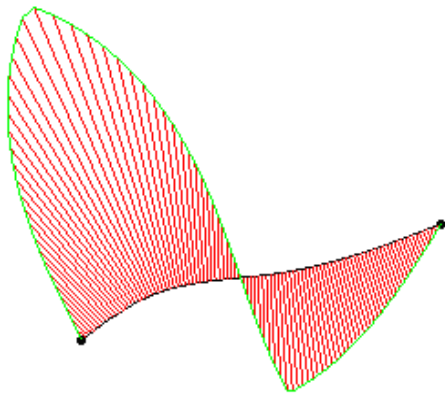
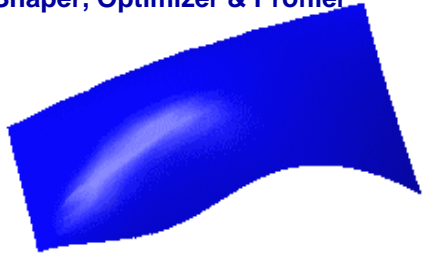



- Even though the stretch is performed in reference to your screen (X is the horizontal axis and Y the vertical one), you can still manipulate the geometric elements as usual. You can rotate, move elements and so forth.



Manipulating Views

P2

 This command is only available with the FreeStyle Optimizer.

 By default, the Standard View Manipulation  is active. In this mode, the four main manipulations, used to define the 3D viewpoint, are available.

1. translation
2. zoom (in or out)
3. rotation
4. focusing on a specific point (double-click on mouse key 2).

This task shows you how to constrain views, in order to set a specific viewpoint.

Open the [ManipulateViews1.CATPart](#) document.

When opening the document, you should see something like this:

1. Press and hold key 2 then 1 of the mouse, and drag to rotate freely in space.

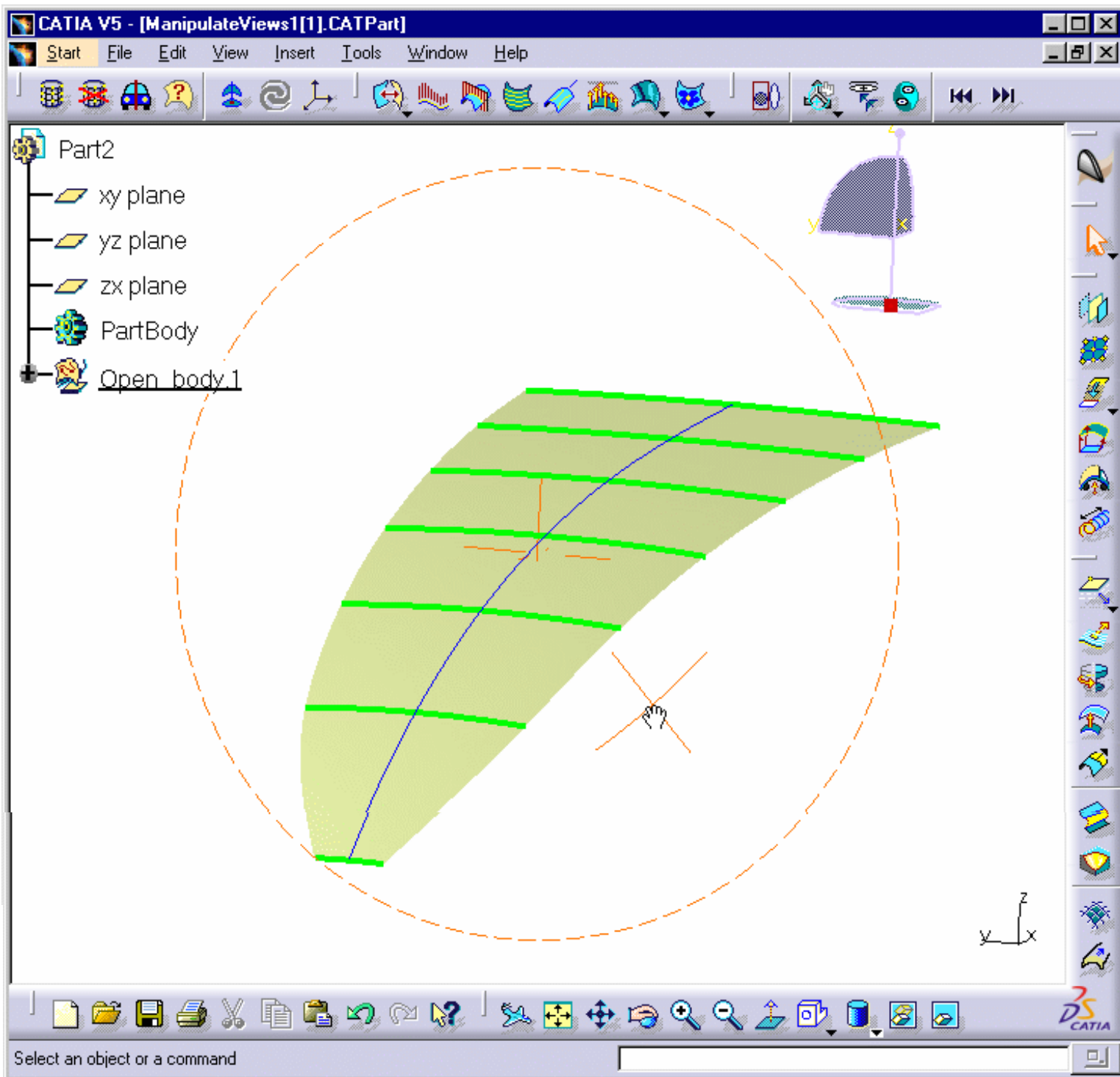

2. Display the whole Manipulating Mode toolbar (under the  icon).

3. Click the **Rotation About Z Screen Axis**  icon.



Still holding both mouse keys, you can now only rotate about the Z screen axis.

If you release key 1, but still hold key 2, you are able to zoom as usual.

4. To redefine the tuning, refer to the [FreeStyle settings](#) and the [Setting the Manipulators Attenuation Factor](#) chapters. The tuning defines the movement amplitude, i.e. if you decrease the value, movement will seem slower.

This is especially useful when working in Stretch view mode.



This attenuation step definition is also affected by the **Tuning** value defined in the general

5. Similarly you can click the **Rotation About X Screen Axis**  or **Rotation About Y Screen Axis**  icon to rotate around the screen X or Y axis respectively.

6. If you click the **Zoom And Translate**  icon.

No rotation whatsoever is allowed.



- Simply click the Standard View Manipulation  icon to reset the default options.
- Still holding down mouse keys 1 and 2, use keyboard shortcuts to manipulate views according to pre-set steps:
 - 90° around the Z screen axis, using the Up/Down keys
 - 90° around the X screen axis, using the up and down arrows
 - 90° around the Y screen axis, using the right and left arrows
- Similarly, using the right and left arrows, you can zoom in and out.
- When changing viewpoints, you may wish to come back to a preceding viewpoint. To do this, simply click  to move backward or  to move forward in the viewpoints.



Defining Views

P2

 This command is only available with the FreeStyle Optimizer

 This task shows you how to rapidly define a viewpoint, using the compass on the geometry.

 Open the [ManipulateViews1.CATPart](#) document.

1. Drag the compass onto the exact point of geometry, that you want to see.

This also defines the viewing direction.

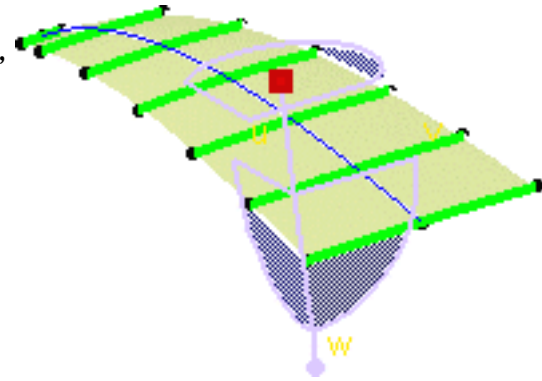

2. Click the **Interactive Viewpoint Definition**  icon.

The viewpoint changes immediately. You now watch the geometry from above the compass, at the point where you dropped that compass.

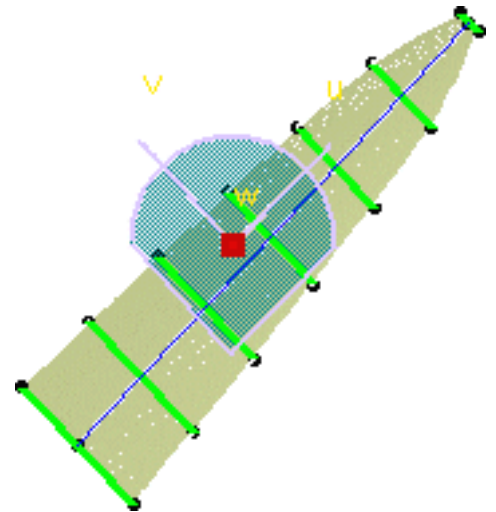



3. Click the **Reverse Viewpoint**  icon.

The viewpoint changes immediately. You now can see the geometry from under the compass, at the point where you dropped that compass.

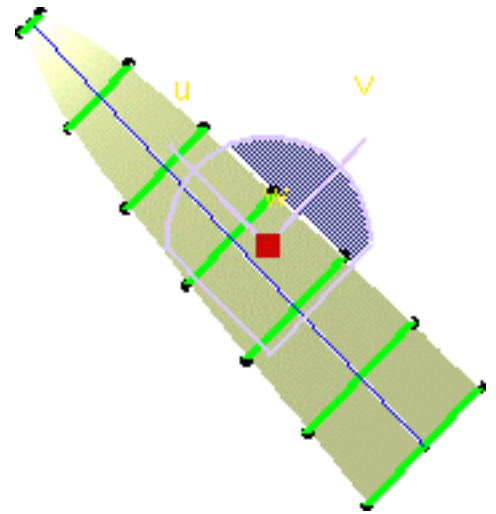
4. Click again if you want to reverse it again.



When changing viewpoints, you may wish to come back to a preceding viewpoint. To do this, simply click  to move backward or  to move forward in the viewpoints.



Creating Datums



This task shows how to create geometry with the History mode deactivated.

In this case, when you create an element, there are no links to the other entities that were used to create that element.



1. Click the **Create Datum** icon  to deactivate the History mode.

It will remain deactivated until you click on the icon again.

If you double-click this icon, the Datum mode is permanent. You only have to click again the icon to deactivate the mode.

A click on the icon activates the Datum mode for the current or the next command.



The History mode (active or inactive) will remain fixed from one session to another: it is in fact a setting.



Performing a Symmetry on Geometry

P2 This functionality is P2 for FreeStyle Shaper, Optimizer, and Profiler.

This task shows you how to transform geometry by means of a symmetry operation.

Open the [Transform1.CATPart](#) document.

1. Click the **Symmetry** icon .

The Symmetry Definition dialog box appears as well as the Tools Palette.

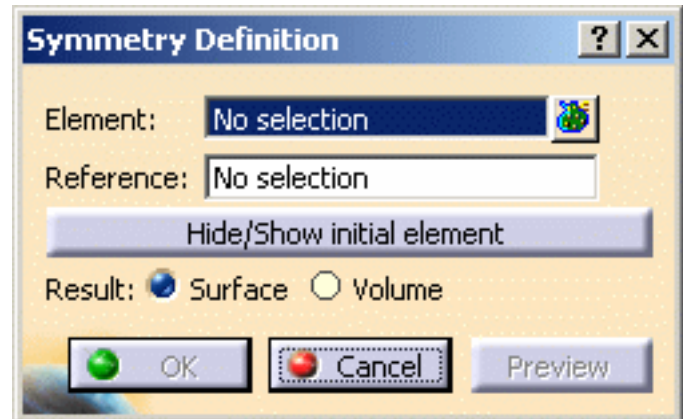

2. Select the **Element** to be transformed by symmetry.

3. Select a point, line or plane as **Reference** element.

The figure below illustrates the resulting symmetry when the line is used as reference element.

The figure below illustrates the resulting symmetry when the point is used as reference element.

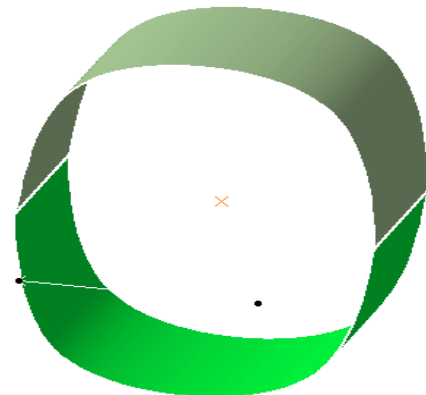

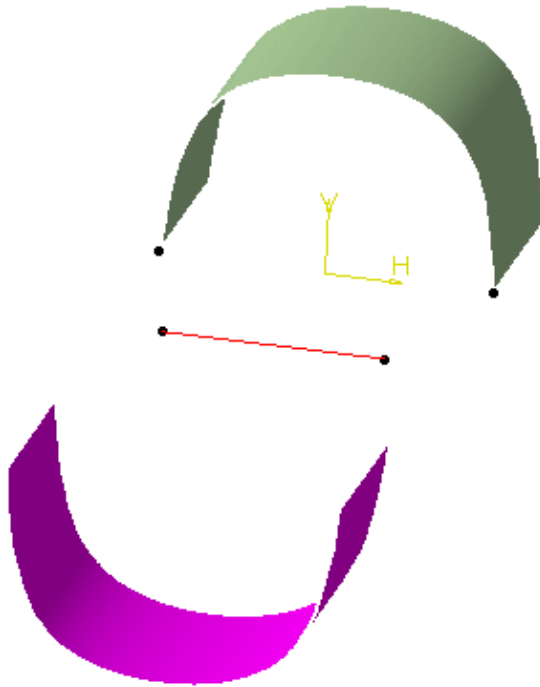

4. Click **OK** to create the symmetrical element.

The element (identified as Symmetry.xxx) is added to the specification tree.



- Use the **Hide/Show initial element** button to hide or show the original element for the translation.



- Choose whether you want the result of the transformation to be a surface or a volume by switching to either **Surface** or **Volume** option. This switch only concerns volumes since the transformation of a surface can only be a surface. Thus in case of multi-selection of volumes and surfaces, the switch only affect volumes.

To have further information about volumes, please refer to the corresponding chapter.





The following capabilities are available: [Stacking Commands](#) and [Selecting Using Multi-Output](#).



Keeping the Initial Element

P2

 This task shows you how to retain an element on which you are performing an operation. When this command is active, as soon as you perform an action in which you create or modify geometry, in fact, you are working on a copy of the initial element.

 Open the [Offset1.CATPart](#) document, or any .CATPart document containing FreeStyle elements.

1. Select a surface and click the **Offset** icon



for example.

The Offset dialog box is displayed.

The offset surface is automatically visualized as a meshed surface.

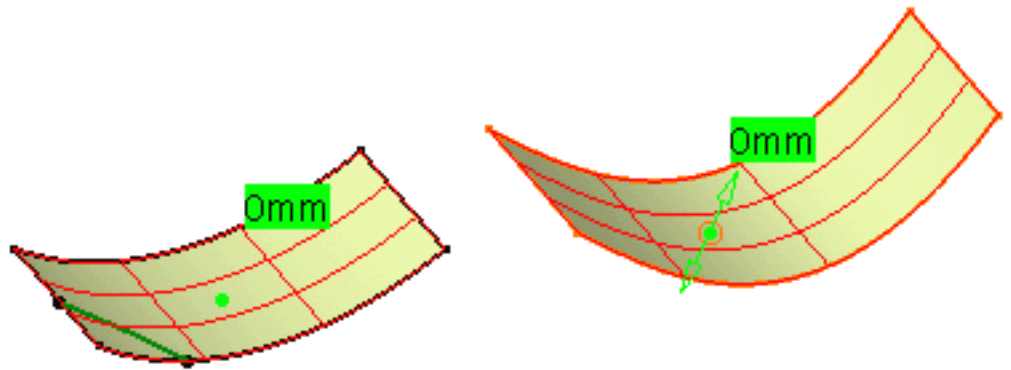

2. Click the **Keep Original** icon  from the FreeStyle Dashboard.

3. Click OK in the current command.

The initial element remains unchanged and a new element is created.

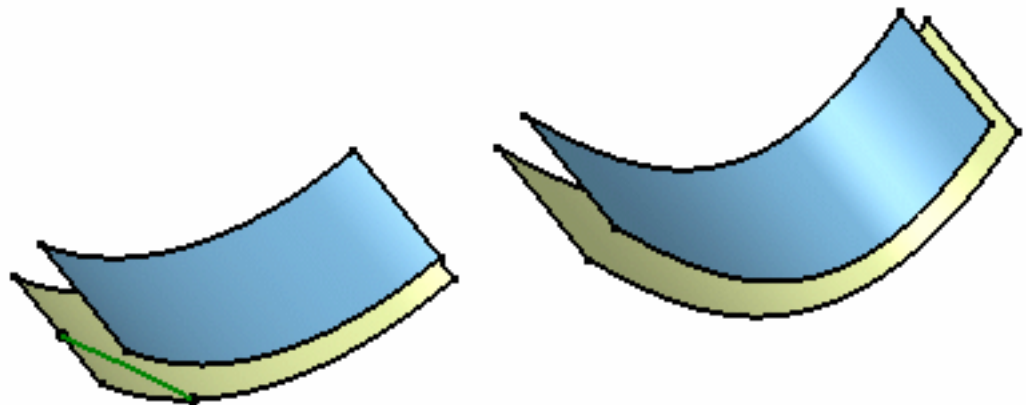

Had you not clicked on the **Keep Original**

icon , the initial element would have been replaced by the newly created element.

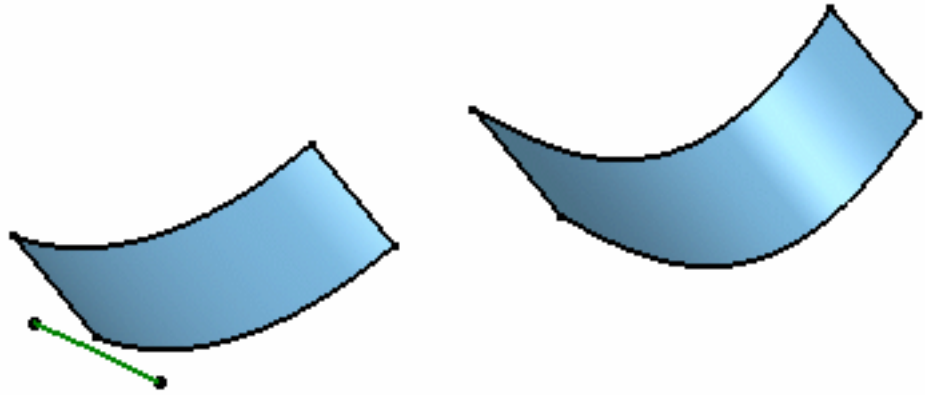

 The Keep original icon remains active once you click OK, providing it was active while performing the command (and vice-versa).



Inserting in a New Geometrical Set

 This task shows how to insert the result of an operation in a new geometrical set.

 It is only available with the Break (**Curve** and **Surface**), **Disassemble**, **Copy Geometric Parameters**, and **Dress-Up** commands.

Let's take an example with the Break Surface command.

 Open the **Break1.CATPart** document.

1. Click the **Break** icon .

The FreeStyle Break dialog box displays.

2. Choose the **Surfaces by curves** break type.



3. Click the **Insert in a new geometrical set** icon  in the FreeStyle Dashboard.

4. Select the surface to be cut.

5. Select the cutting curve(s).

6. Click OK.

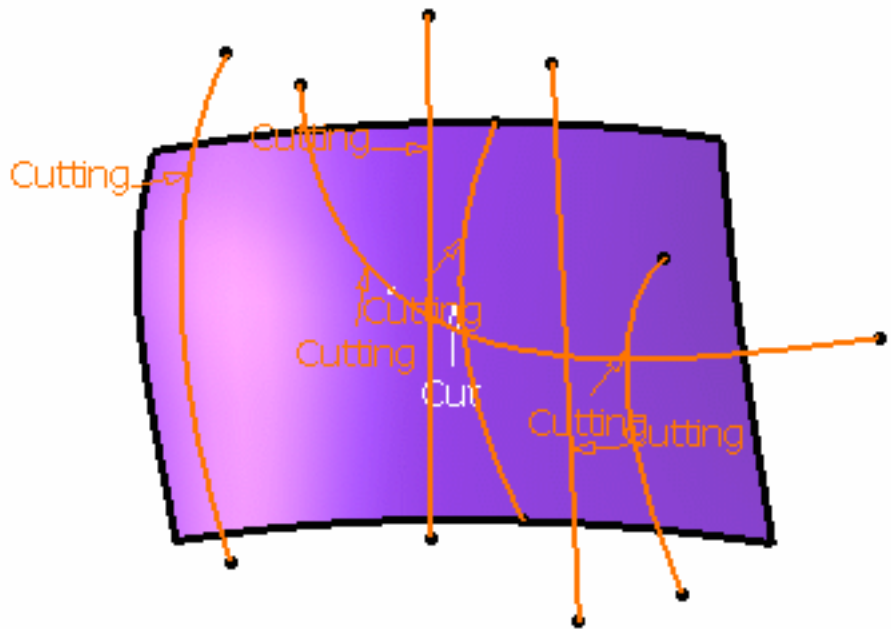

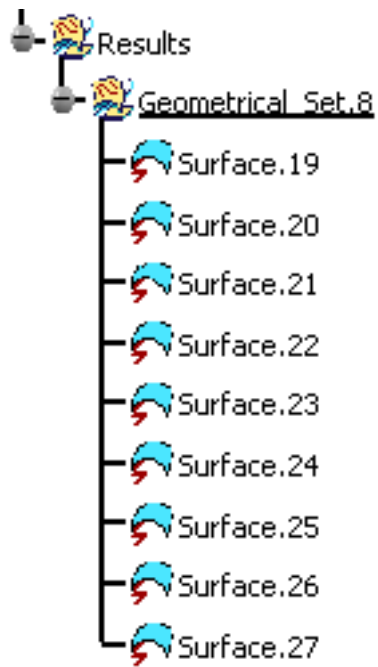



All the created surfaces resulting from the break are displayed in a new geometrical set in the specification tree.

 For further information about the Break command, please refer to the following chapters: [Redefining Surfaces Limits](#) and [Trimming Curves](#).



Creating a Temporary Analysis

 This task shows how to create a temporary analysis during the creation process of a feature.

 This command is only available with the **3D curve**, **Fill**, **Net** and **Sweep** commands.

Let's take an example with the 3D curve command.

 Open a new .CATPart document.

1. Click the **3D**

Curve icon



The 3D curve

dialog box is

displayed.

2. Choose the

Through

points type.

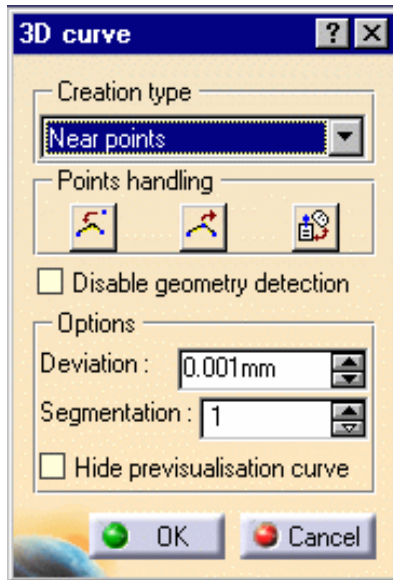

3. Select the

points.

4. Click the

Temporary

Analysis

mode icon



in the

FreeStyle

Dashboard.

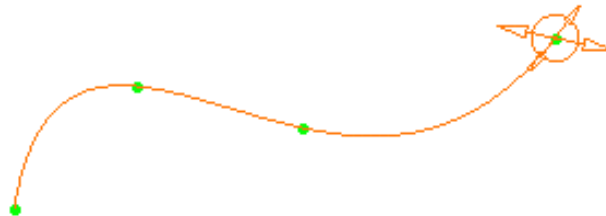

5. Select the

analysis of

your choice in

the Shape

Analysis

toolbar. In our

example, we

chose the

Porcupine

Curvature

Analysis.

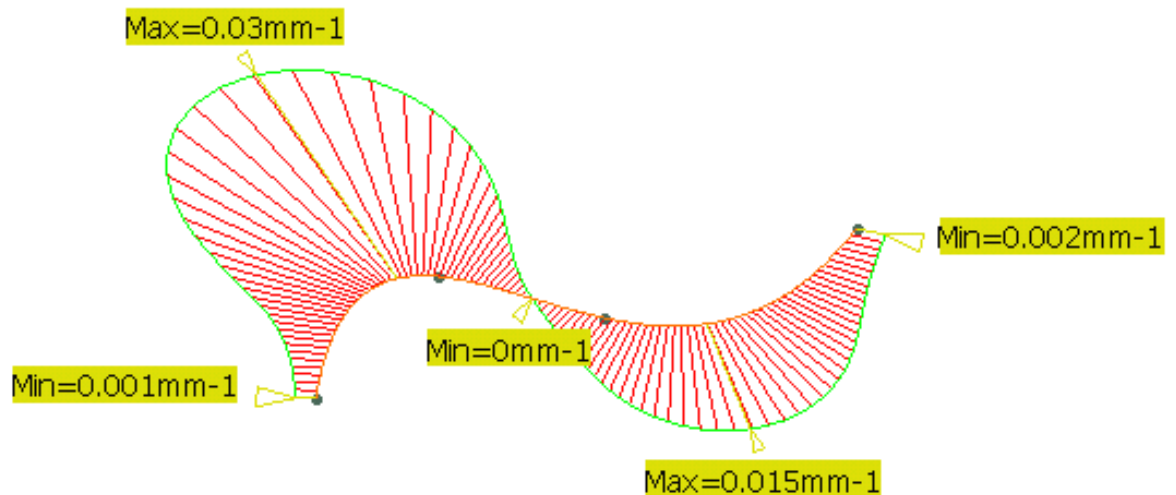

6. Click OK in the Curvature Analysis dialog box.
7. Select another point in the 3D curve command. The temporary analysis is updated accordingly.

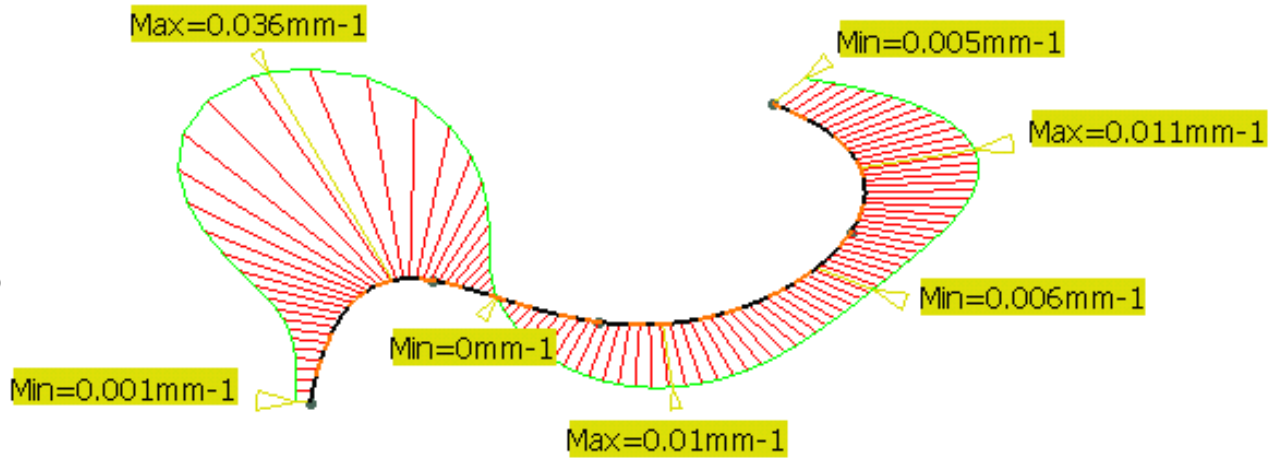

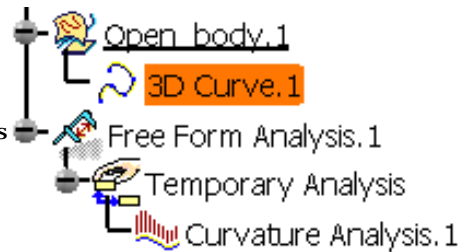

 You must activate the temporary analysis mode before running any analysis. Otherwise, a persistent FreeStyle analysis will be performed.

The Temporary Analysis node is displayed in the specification tree and the associated analysis (here Curvature Analysis.1) appears below.

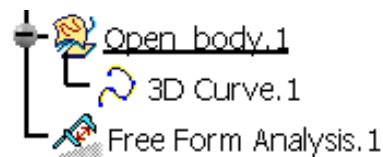

The analysis is not persistent. Thus when you click OK in the 3D curve dialog box to create the curve, the Temporary Analysis node disappears from the specification tree.



 You can perform several analyses while in the Temporary Analysis command: all of them will appear in the specification tree under the Free Form Analysis node.







Auto-detection



The Auto-detection tool enable you to perform a remote point selection which is especially useful for selecting on the fly point on geometry. This is also useful to position the compass at a specific location on an element, to define the local axis-system.



1. Choose one of the four detection types from the FreeStyle Dashboard:

- Click the **Snap On Vertex** icon  to detect the closest corner of the selected element.
- Click the **Snap On Edge** icon  to detect the closest border (edge) of the selected element.
- Click the **Snap On Cpt** icon  to detect the closest control point on the selected element.
- Click the **Snap On Segment** icon  to detect the the closest segment of the selected element

2. Move the pointer close to the geometric element you wish to snap to.

The specified element (corner, border, control point or segment) is automatically detected and selected.



- When checking the **Search Dressing** option from the **Tools -> Options -> Shape -> FreeStyle** tab, and the **Snap On Cpt** icon  the system automatically displays the control points on the geometry detected below the pointer, provided a command is running.

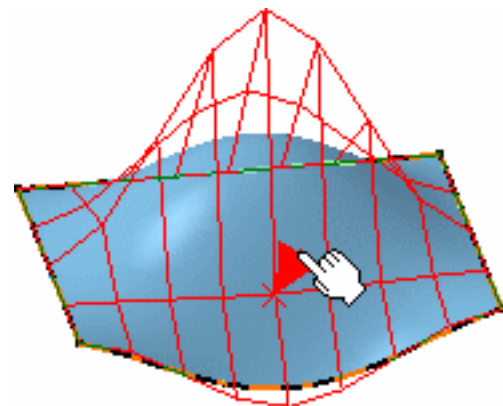

If this **Search Dressing** option has not been checked, yet the **Snap On Cpt** option is active, the auto-detection still is available, but the control points are not displayed.

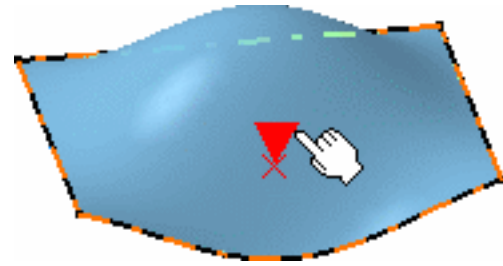

- Use the Shift key to activate/deactivate temporarily the auto-detection capability on the point you are currently trying to snap, or not, to another element.



Setting the Manipulators Attenuation Factor

P2







This task shows you how to set the attenuation value for the manipulator's displacement. The attenuation lets you define the ratio between the mouse displacement and the actual displacement of the manipulator in the geometry. This attenuation factor is saved in the application's settings, and is defined in the [FreeStyle Settings](#).



Open any .CATPart document containing FreeStyle elements.



1. Choose one of the four attenuation ratio from the FreeStyle Dashboard:

- Click the **No Attenuation** icon  to use the attenuation value as set in the [FreeStyle General Settings](#) (default value)
- Click the **Slow** icon  to use the square default attenuation value
- Click the **Medium** icon  to use the cubic default attenuation value
- Click the **High** icon  to use the 10^4 default attenuation value



Each attenuation value equals the previous value (in the dashboard) multiplied by the default value.



Displaying Manipulators On Elements



This task shows you how to display manipulators on elements and how to modify their values. Three types of manipulators can be displayed on a given element, whether the selected or the resulting element:

1. [continuity](#)
2. [contact points](#)
3. [tension](#) (P2 only)
4. U and V [orders](#)

These manipulators are displayed either by using the Dashboard (P2 only) as illustrated in this task, or by checking the adequate option in **Tools -> Options -> Shape -> FreeStyle**. Once they are displayed, their behavior is identical regardless of the chosen interface style.

Displaying Continuity



Open the [MatchSurface1.CATPart](#) document.



1. Click the **Match Surface** icon  and select the two edges to be matched (see [Matching Surfaces](#)).

2. Click the **Continuity** icon



from the Dashboard.

Texts indicating the continuity type wherever available are displayed.

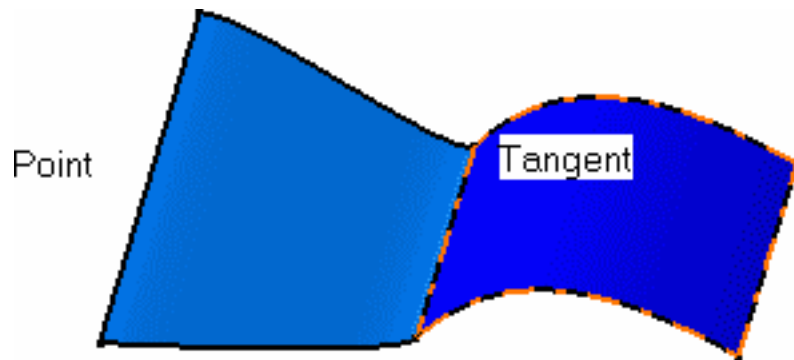

3. Right-click on a text to display the contextual menu, and choose the **Curvature continuity** item.

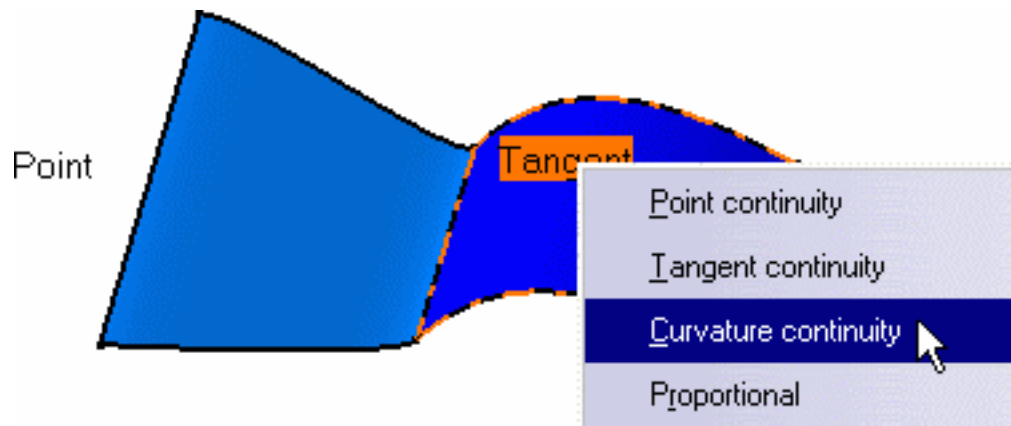

- i** You can also simply click the text. It will automatically change to the next type. Click as many times as needed to go down to the desired continuity type. Shift-clicking goes up in the list.

The text changes to **Curvature** and the elements are updated in accordance.

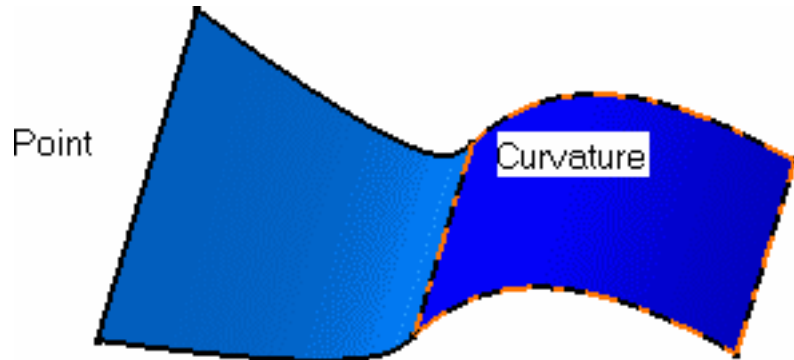

- i** In some cases the chosen type of continuity is not compatible with the geometry or the modification. In that case, a warning is displayed directly onto the geometry at the location where the inconsistency arises. You can then change the continuity, or modify the geometry itself.

A forbidden sign  may even be displayed and the system will prevent you from modifying the element in a specific direction, if it does not make sense geometrically speaking.

Displaying Contact Points

- i** Open the [BlendSurface1.CATPart](#) document.

- i** **1.** Click the **Blend Surface** icon , and select an edge on each surface.

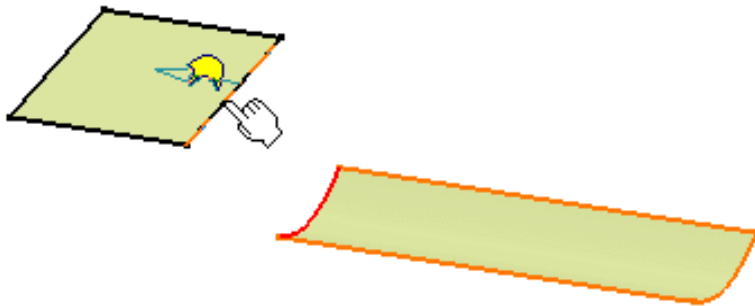

The blend surface is computed.

2. Click the Contact Points

icon  from the dashboard.

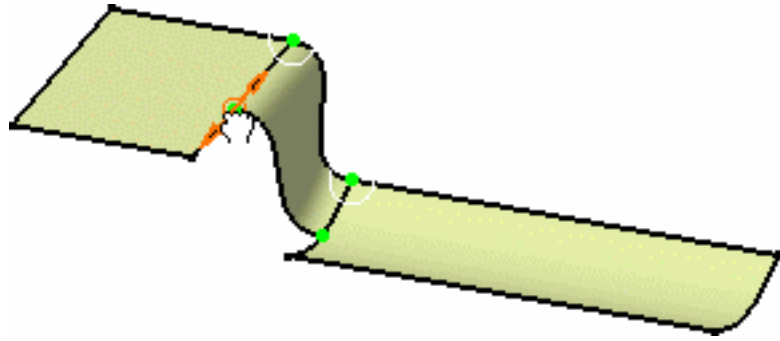

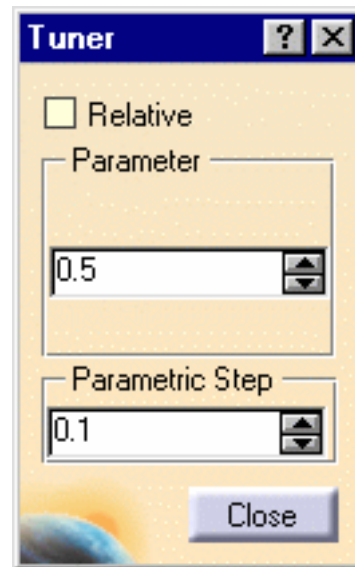

Manipulators are displayed on the connection, allowing you to interactively define the blend limits by simply sliding them along the boundaries.

You can edit the contact points by right-clicking any of them to display the contextual menu and choosing the **Edit** item. The Tuner dialog box opens to let you key in a new value, in percentage of the total boundary.



Displaying Tensions (P2 only)

 Open the [BlendCurve1.CATPart](#) document.

 **1. Select two curves and click the Blend Curve icon** .

The blend curve is previewed.

2. Click the **Tensions** icon



from the Dashboard.

Green segments representing the direction and limits tension are displayed.

You can modify the tension by sliding the displayed value along the green segment.

You can also edit the value, or invert the tension direction, using the contextual menu on the value.

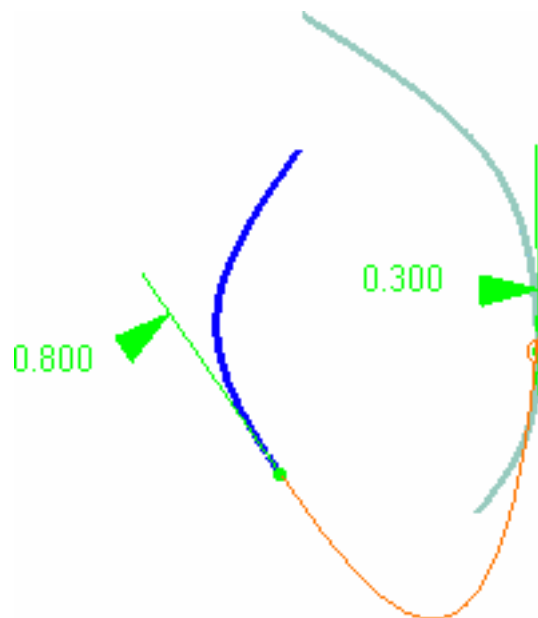
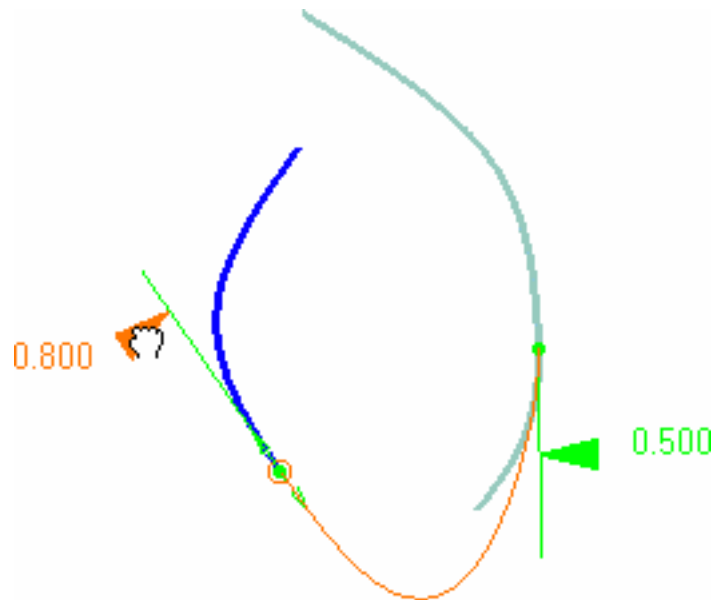

Displaying U, V Orders



Open the [MatchSurface1.CATPart](#) document.



1. Click the **Match Surface** icon  and select the two edges to be matched (see [Matching Surfaces](#)).

2. Click the **U, V Orders** icon



from the Dashboard.

Numbers are displayed on the geometry, indicating the order number of the element along the U and V directions.

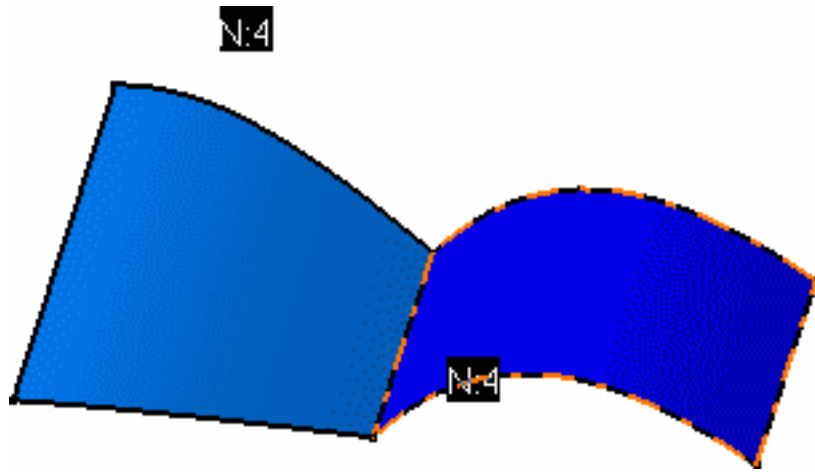

3. Right-click on a text to choose another order value

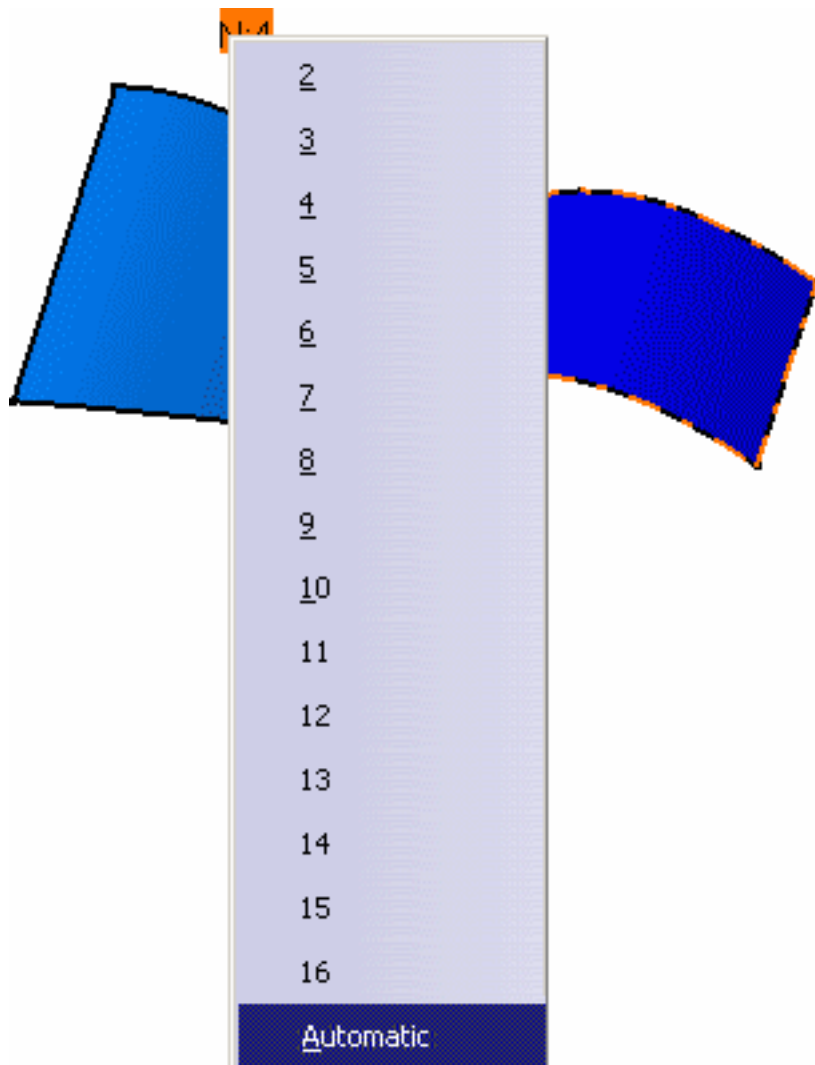

You can also simply click the text. It will automatically change to the next digit down the list. Shift-clicking goes up in the list.

The Automatic option enables you to modify the order and the segmentation of the matching surface so that the continuity is respected.

The surface order is instantly modified, but you will see it only when using the Control Points icon for example:

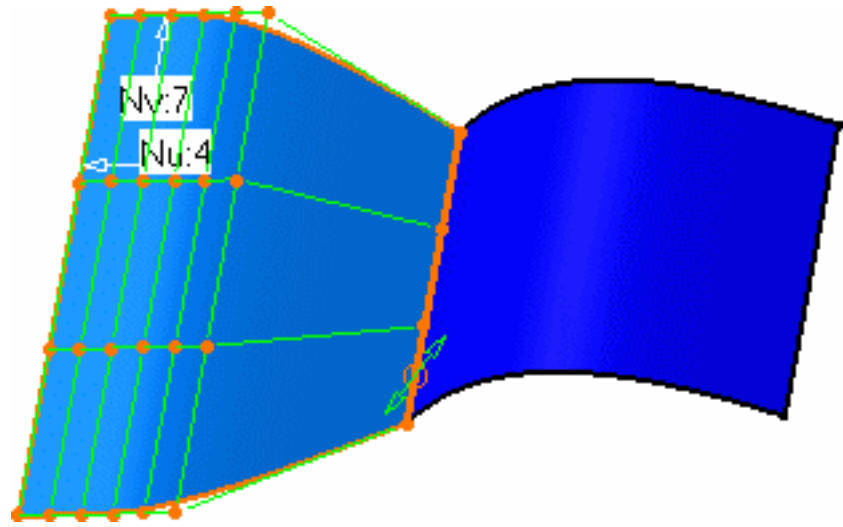

 For curves, only the order along U is displayed.



Displaying Control Points Temporarily



This task shows you how to temporarily display control points geometry while in a FreeStyle command. Once you exit this command, the control points are removed as opposed to those displayed using the permanent visualization options (see [Setting FreeStyle Visualization Options](#)).



Open the [MatchCurve1.CATPart](#) document, or any .CATPart document containing FreeStyle elements.



1. Check the **Control Points** option in the **Display** area of the **Tools -> Options -> Shape -> FreeStyle -> General tab** or click the **Furtive Display** icon  from the Dashboard (P2 only).

2. Click the **Match Curve** icon .

3. Successively select two curves.

The first curve is automatically modified so as to be connected to the second curve.

Control points are displayed in blue on the matched curve.

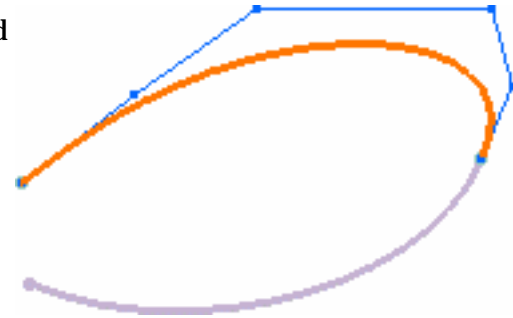

4. Click OK in the current command.





Multi-selection is available, meaning that if several elements are involved in the current command, if there were two curves to be projected for example when using the **Project Curve** icon  the control points are displayed on all the resulting elements.



Inserting Geometrical Sets

 This task shows how to insert a new geometrical set entity in the specification tree.

 Open the [ConnectChecker2.CATPart](#) document, or any .CATPart document already containing at least one geometrical set and geometric elements.

 **1.** In the specification tree, using the **Define in Work Object** contextual command, select the element at which level you want the new geometrical set to be inserted. This element defines the father location for the insertion of the new geometrical set.

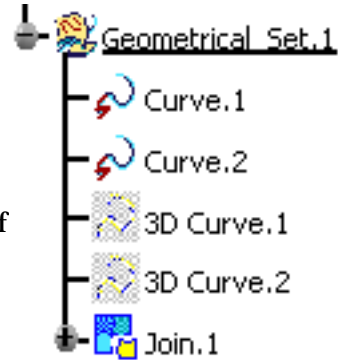

2. Select the **Insert -> Geometrical Set** menu command.

The Insert Geometrical Set dialog box is displayed.

The Features list displays the elements to be contained in the new geometrical set.

3. Enter the name of the new geometrical set.

4. Select additional entities that are to be included in the new geometrical set.

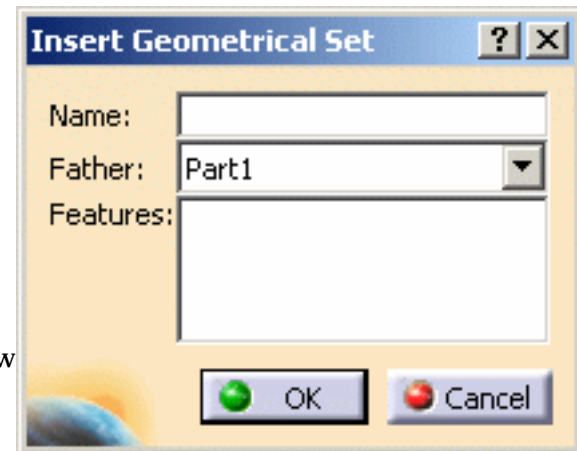

 If all selected entities belong to the same geometrical set, the father of the new geometrical set is automatically set to the father of these entities.

5. Click OK to create the geometrical set at the desired location.

The result is immediate. CATIA displays this new Geometrical_Set.x, incrementing its name in relation to the pre-existing bodies, in the specification tree. It is created after the last current geometrical set and is underlined, indicating that it is the active geometrical set.

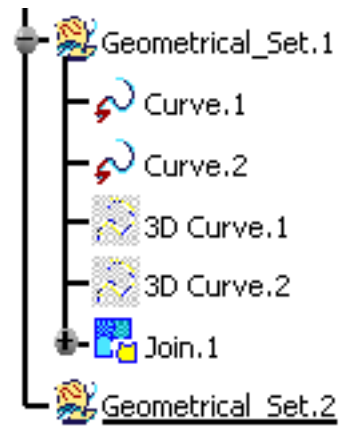

6. Use the **Geometrical_Set2.object -> Change Geometrical Set...** contextual command on the newly created geometrical set.
7. Select the Geometrical_Set.1 in the specification tree, then click OK in the **Change Body** dialog box.

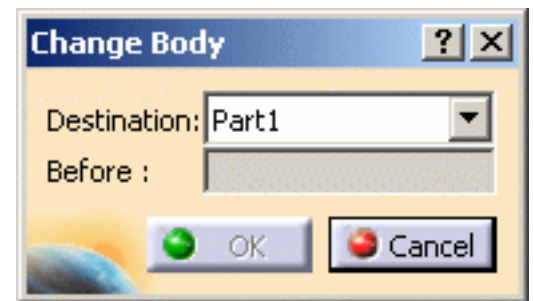

The selected geometrical set has been moved last in the initial Geometrical_Set.1 and is still active.

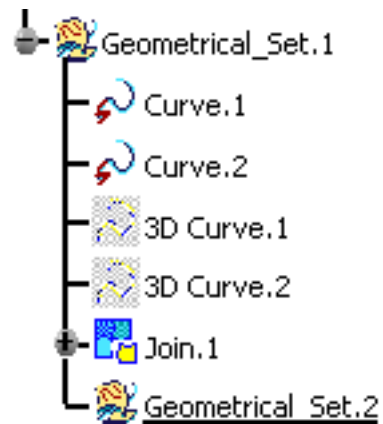

Selecting a Support



This task shows you how to select a support in the case several supports are detected; for example the internal edge of a join, or a curve resulting from an intersection.

If a cell of the selected element relies on more than one support, you can choose the support you need.

It is available with the following functionalities:

- [Blend surfaces](#)
- [Match curves](#)
- [Fill Surfaces](#)
- [Net Surface](#)
- [Styling Sweep](#)

Let's take two examples using the Blend functionality:

- [Creating a blend between a surface and a join](#)
- [Creating a blend between two joined entities](#)

In both cases, the number of generated faces will be equal to the number of joined edges.



Open the [Multi-Supports1.CATPart](#) document.



Creating a blend between a surface and a join

1. Click the **FreeStyle Blend Surface** icon .

The blend surface is previewed, and the Blend Surface dialog box is displayed.

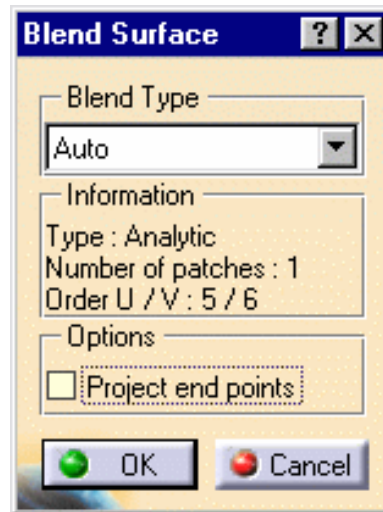

2. Move the pointer over the edge of a surface and click on it.

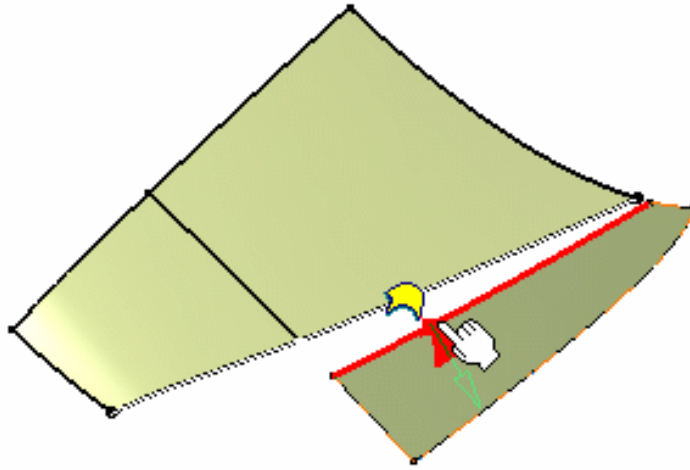

3. Move the pointer over the edge of the second surface and click on it.

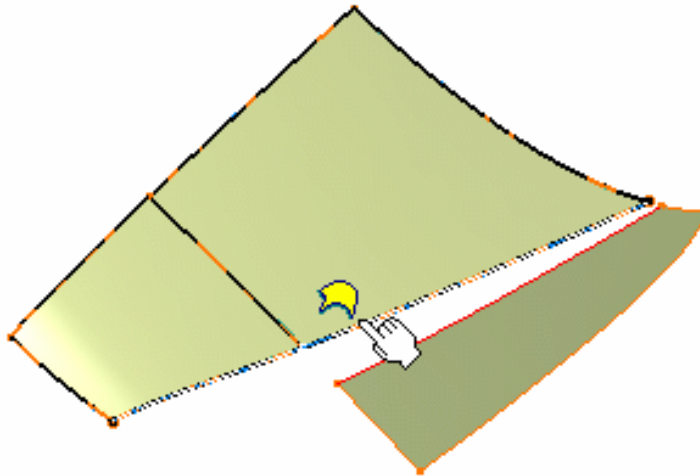

The information tag is displayed to inform you that only one surface can be selected for the blend operation.

The blend surface is previewed.

4. Click Cancel in the Blend Surface dialog box.

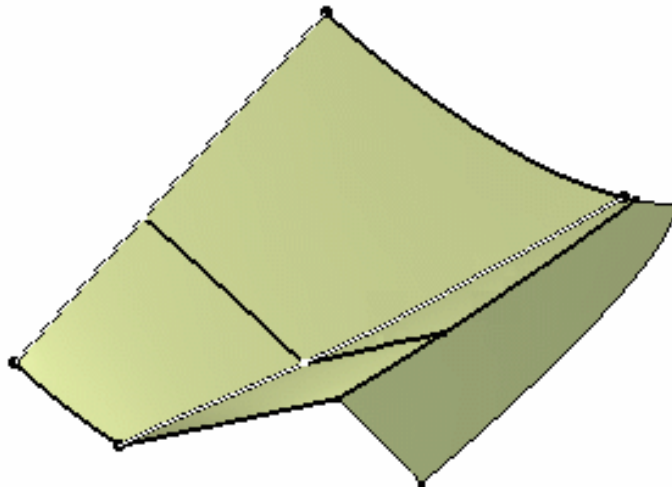

5. Hide the Boundary.1 curve: right-click it in the specification tree and choose Hide/Show from the contextual menu.
6. Perform steps 1 and 2 again.

7. Move the pointer over the edge of the second surface.

An information tag  is displayed informing you that two or more surfaces can be selected.

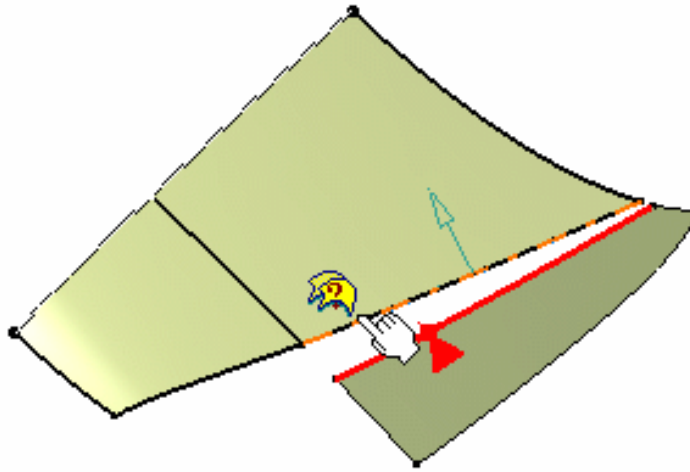

8. Right-click the tag to display the number of solutions and choose which support to keep for the blend operation.

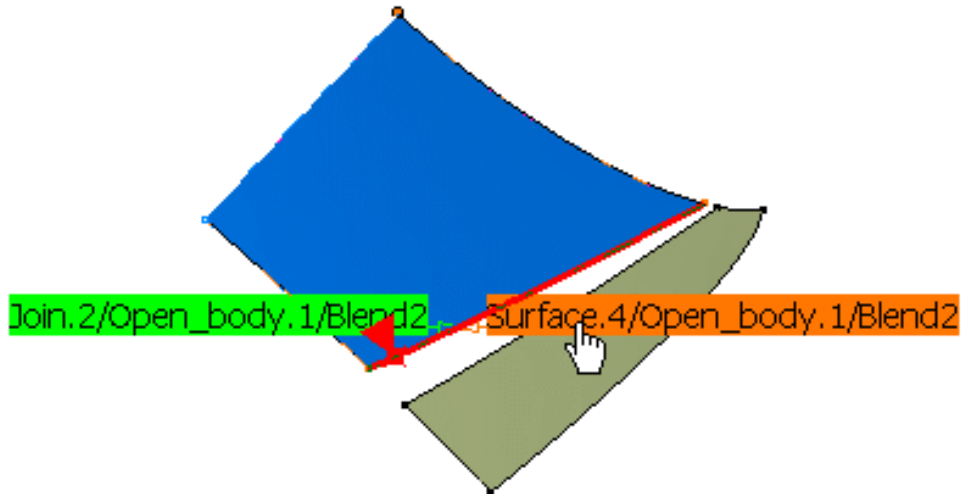

The blend surface is previewed.

9. Click OK in the Blend Surface dialog box to create the blend surface.

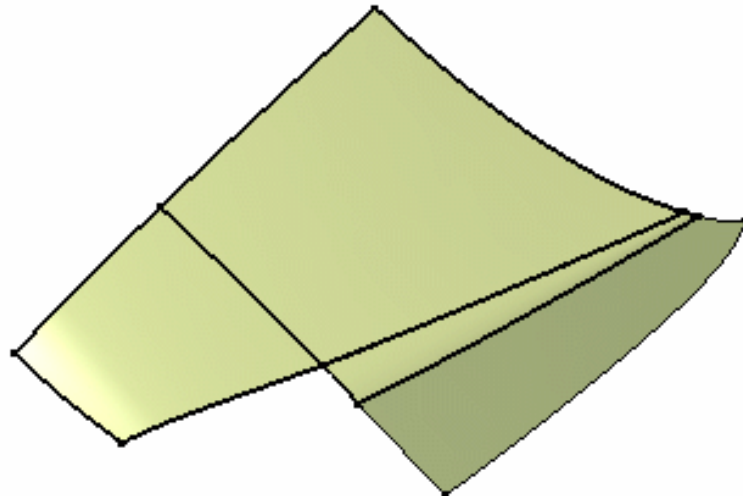

Creating a blend between two joined entities

1. Click the **FreeStyle Blend Surface** icon .

The blend surface is previewed, and the Blend Surface dialog box is displayed.

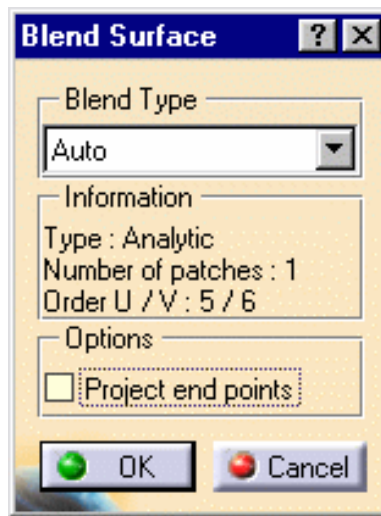

2. Move the pointer over a curve and click on it.

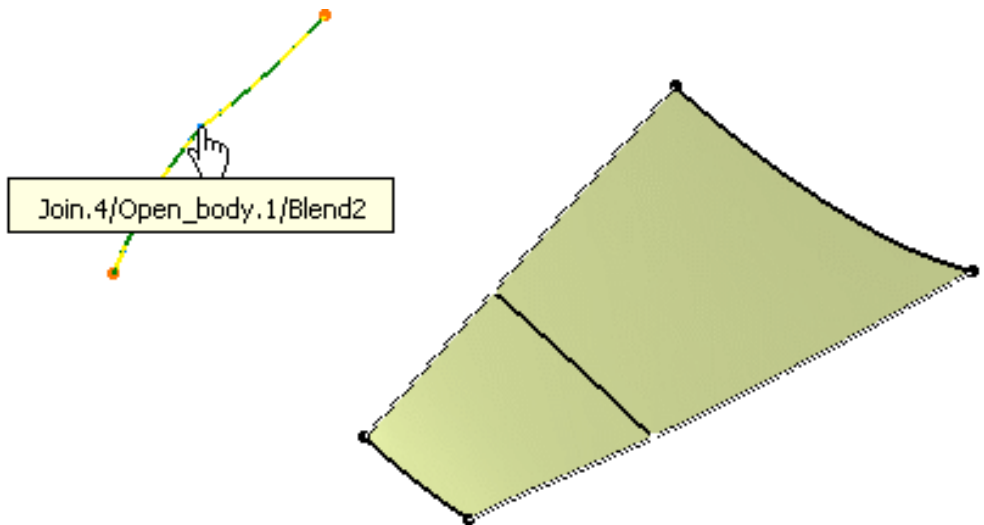

3. Move the pointer over the edge of a surface and click on it.

An information tag  is displayed informing you that only the selected surface only relies on one support.

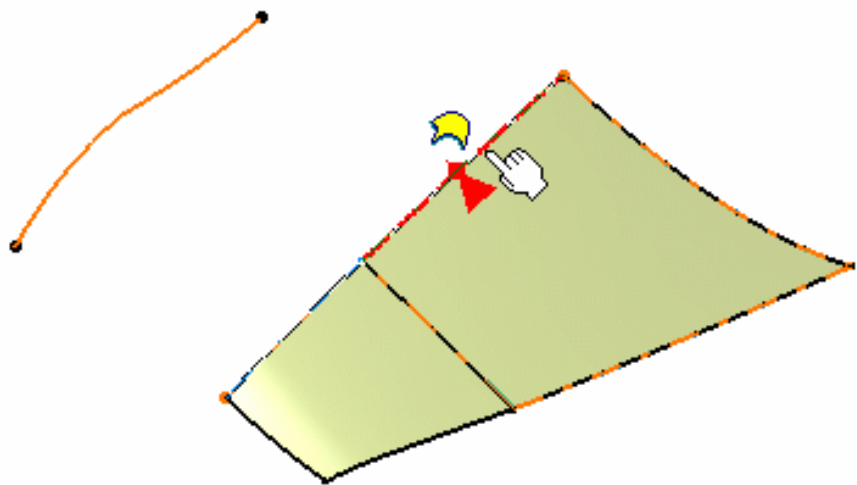

The blend surface is previewed.

4. Click OK in the Blend Surface dialog box to create the blend surface.

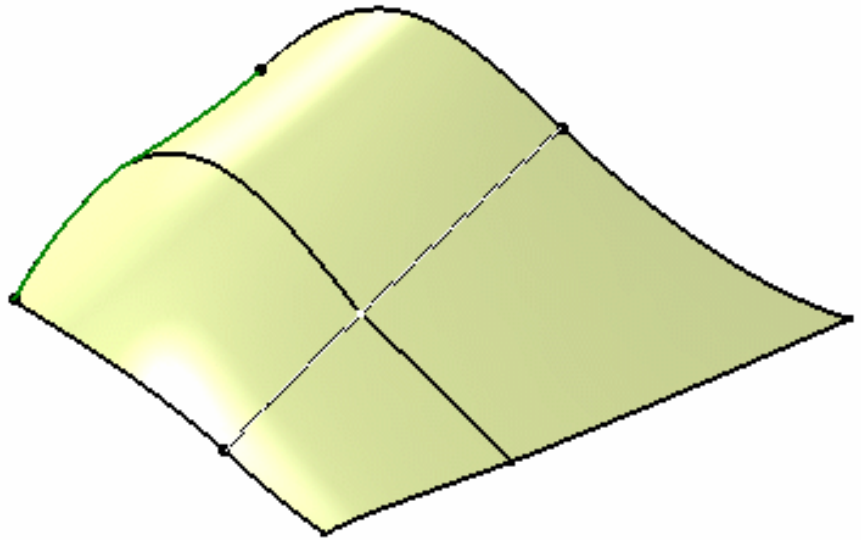

The **User Selection Filter** toolbar is available with this functionality.

In the above example, had you deselected the Feature Element Filter mode, the Blend Surface would have been created between a surface and a 3D curve (and not between Join.1 and Join.2)

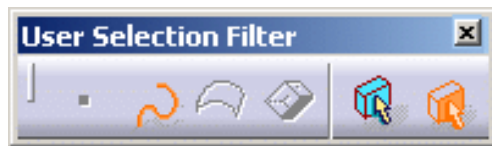
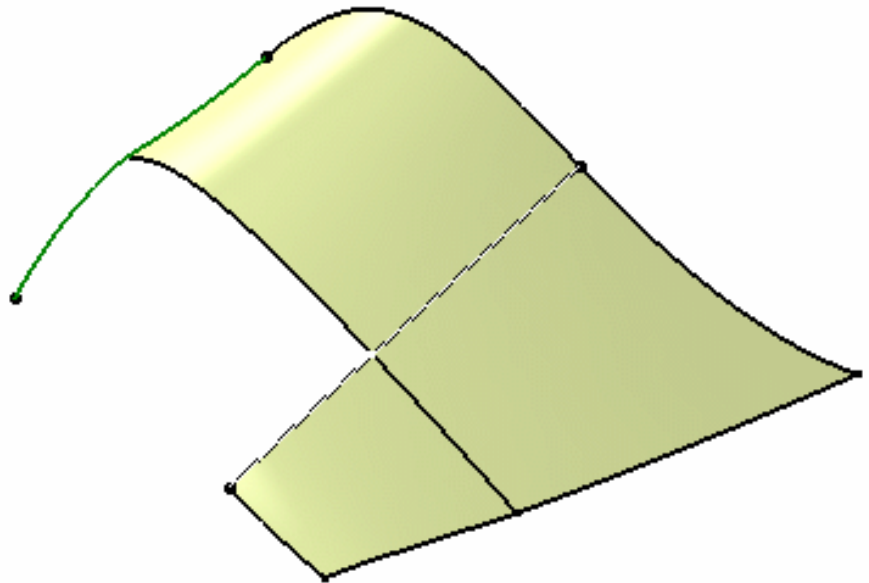

Editing and Keeping a Point



This task shows you how to edit a point and keep it at its location.



1. Move the pointer to a point (control point, contact point or limit point for example), right-click to display the contextual menu.



2. Choose the **Edit** item.

The Tuner dialog box is displayed, letting you specify the exact position of the point in space and define a step value by which a control point/mesh line moves (**Step** field).

Once the value has been defined in the Tuner dialog box, press and hold the Shift key then click one of the manipulator's arrow to move the selected point by the defined step value.

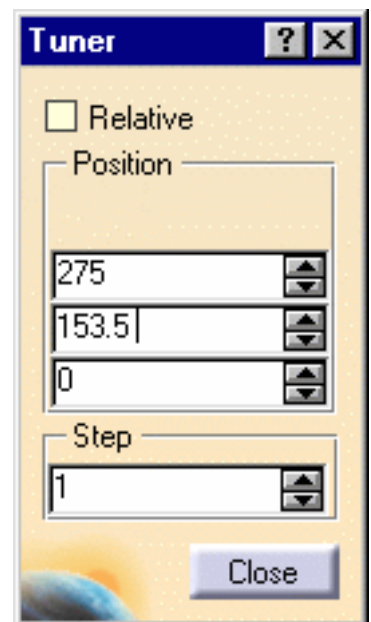

Checking the **Relative** option enables you to display the relative mode and specify the relative position of the point depending on its origin as shown in the model.

This option is not available for all functionalities.

3. Choose the **Keep this point** item to create a point at this location.

A Point.xxx appears in the specification tree.

You can create a Point.xxx either on each control point or on the selected control points.



- Negative values are allowed.
- This contextual menu is available each time manipulators are displayed in the geometry.



Advanced Tasks

Using FreeStyle Optimizer

Interoperability Between the FreeStyle Shaper & Optimizer

Using FreeStyle Profiler

Interoperability with Part Design

Interoperability with Wireframe

Using the FreeStyle Optimizer



The FreeStyle Optimizer offers complementary capabilities to the FreeStyle Shaper. It is used on the same type of elements yet taking the design capabilities one step further.



Fit a curve to a cloud of points: select the curve to be deformed and the target element, specify the fitting parameters and, if needed, the continuity constraints using the contextual menu, click **Fit** then OK.



Fit a surface to a cloud of points: Select the surface to be deformed and the target element, specify the fitting parameters and, if needed, the edge constraints using the contextual menu, click **Fit** then OK.



Globally deform a surface: Select a set of surfaces, if needed select the guiding curve, click **Run**, specify the deformation type and use the control points and mesh lines to deform the surface.



Analyze reflect curves: Select a surface, specify the neons grid parameters (number, spacing, position, viewpoint.), manipulate the grid to analyze its reflection on the selected surface.



Analyze inflection lines: select a surface, set the compass orientation and click the icon to visualize inflection lines

Fitting a Curve to a Cloud of Points

P2

 This command is only available with the FreeStyle Optimizer.

 This task explains how to fit a curve to a cloud of points.

 Open the [FitCurve1.CATPart](#) document.

 **1.** Select the curve you wish to deform by fitting it to the geometry.

2. Click the **Fit to Geometry** icon .

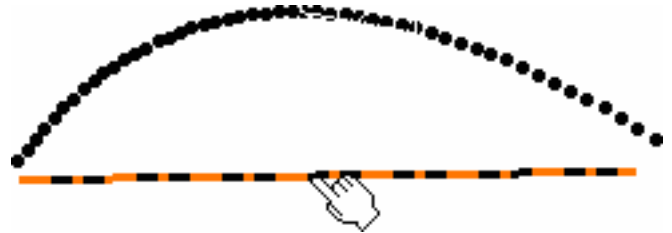

The Fit To Geometry dialog box is displayed.

3. Select the target element, that is the element to which the curve should fit.
Here, select the cloud of points.

4. Define the fitting parameters in the **Fitting** area of the Fit to Geometry dialog box.

You need to specify the **Curve tension** , and

Allowed smoothing  that have to be taken into account when modifying the curve to fit the existing geometry.

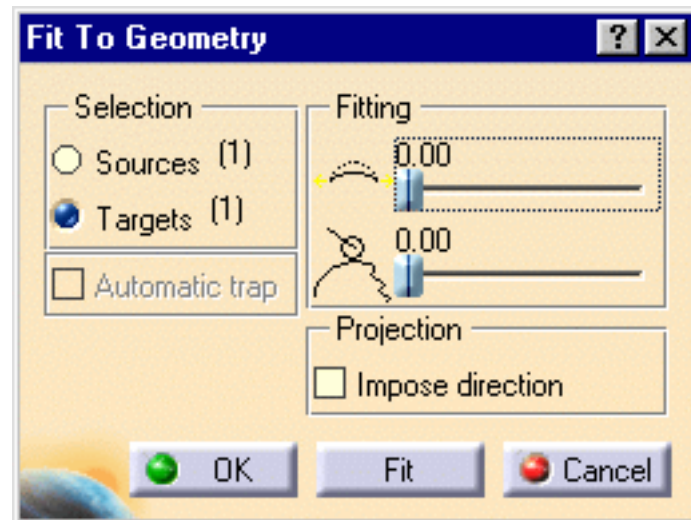

5. Use the contextual menu on the **Free** text to impose boundary continuity constraints: **Free**, **Point**, **Tangent** or **Curvature**.

This can be set for each end-point of the initial curve.

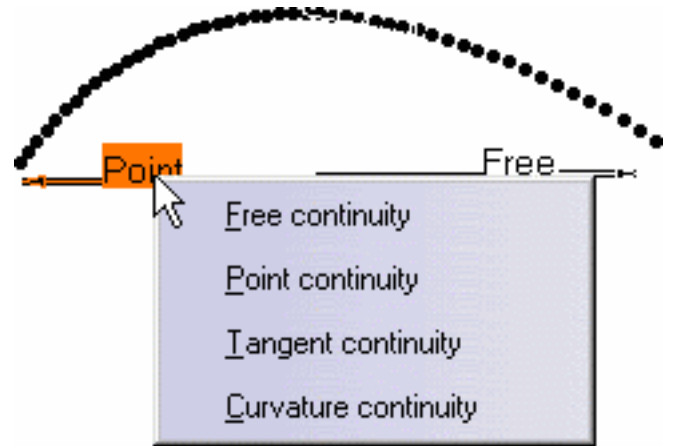

6. Click **Fit** to accept the definition, once all parameters have been defined.

The curve is modified so as to fit as best the selected geometry, while taking the fitting parameters into account.



7. Click **OK** in the Fit to Geometry dialog box to accept the new curve as fitted to the cloud of points.



- Use the Ctrl key to select several curves to be fitted at a time.
- You can iterate and click **Fit** several times. This lets you fine-tune the fit.
- Use the **Automatic trap** option to reduce the number of points to be taken into account when the target element is a Cloud of Points containing many points.



Available capabilities from the dashboard are: [datum creation](#), [continuities](#) and [orders](#).



Fitting a Surface to a Cloud of Points

P2

 This command is only available with the FreeStyle Optimizer.

 This task explains how to fit a surface to a cloud of points.

 Open the [FitSurface1.CATPart](#) document.

 **1.** Click the **Fit to Geometry** icon .

The Fit To Geometry dialog box is displayed.

2. Select the surface, or set of surfaces, you wish to deform by fitting them to the cloud of points.

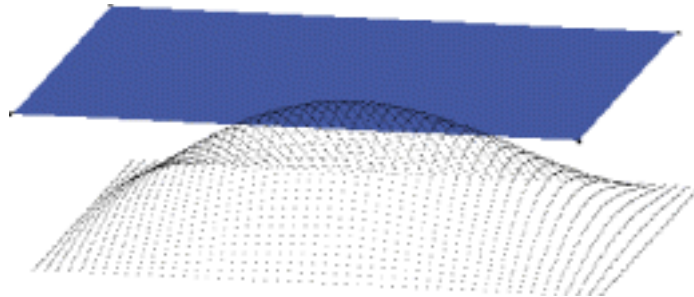

3. Right-click the **Free** text on which you want to impose edge constraints.

You can choose from four constraint types:

- **Free:** no constraint is imposed on this boundary
- **Point:** the resulting surface will still pass through the boundary of the initial surface
- **Tangent:** the edge of the resulting surface will be tangent to the initial surface at the selected boundary
- **Curvature:** the resulting surface will be continuous in curvature with the initial surface at the selected boundary.



4. Define the deformation parameters from the Fit to Geometry dialog box:
 - **Tension:** indicates which tension coefficient is applied
 - **Smoothing:** defines the smoothing coefficient to be applied.

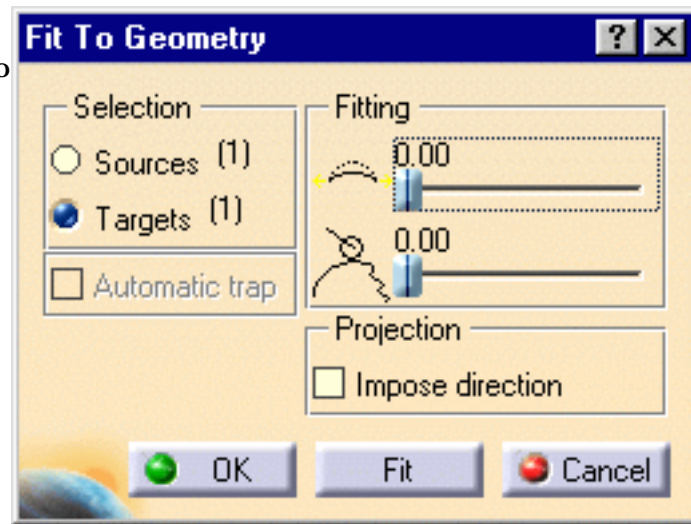



5. Click **Targets** and select the target element in the geometry.
6. Click **Fit**, the surface is projected onto the target geometry.

You can repeat the operation and deform the surface step-by-step.

7. When the results are satisfying, click **OK** in the Fit to Geometry dialog box.

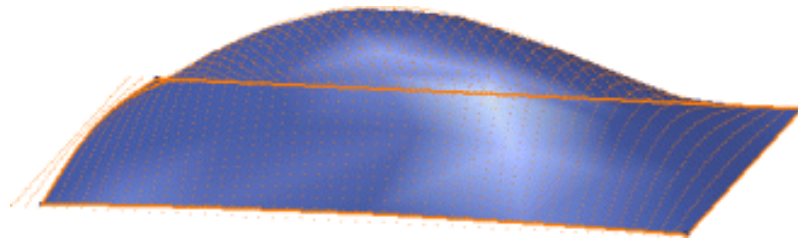
The new surface fits the pre-existing cloud of points.



-  Using this item you can fit a surface to a cloud of points just as well as you can fit it to any other type of pre-existing geometry.
-  You can also choose to impose a direction when fitting the surface to the cloud of points meaning that the surface will be projected according to cloud of points, as shown to the left below, and no longer according to the normals to the initial surface, as shown to the right.

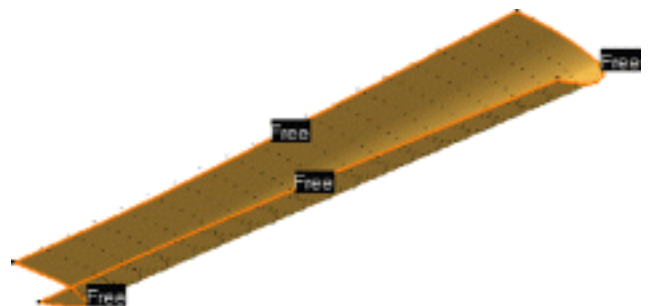
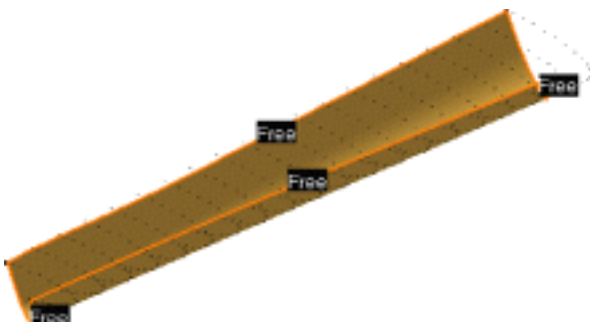

- You can iterate and click **Fit** several times. This lets you fine-tune the fit.
- Use the **Automatic trap** option to reduce the number of points to be taken into account when the target element is a Cloud of Points containing many points.

 Available capabilities from the dashboard are: [datum creation](#), [continuities](#) and [orders](#).



Globally Deforming Surfaces

P2

 This command is only available with the FreeStyle Optimizer.

 This task explains how to deform a set of surfaces in one operation.

 Open the [GlobalDeformation1.CATPart](#) document.

 **1.** Select the surfaces to be deformed, using the Control key for multi-selection.

2. Click the **Global Deformation** icon .

The Global Deformation dialog box appears, into which you can specify deformation options: using an intermediate patch or a user-defined axis.

In this case, use the default option: intermediate patch (**Intermediate surface use** icon).

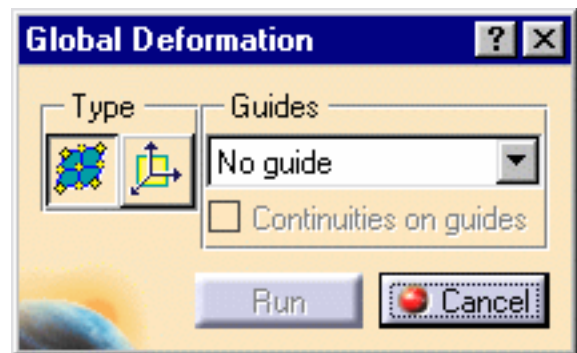

3. Click **Run** in the Global Deformation dialog box.

A transparent patch with control points and mesh lines is displayed. It represents the intermediate surface bounding box.

The Control Points dialog box is displayed.

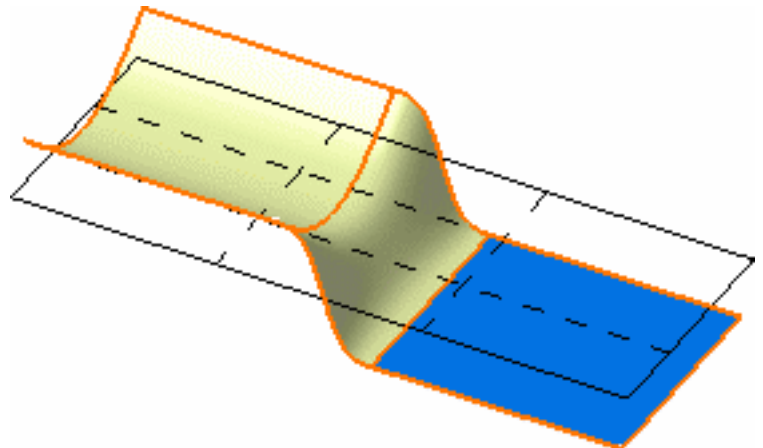

Use it to define the type of operation to be performed on the control points.

- **Support** defines the type of translation to be applied
- **Law** defines the type of deformation that is to be applied when several control points have been selected.

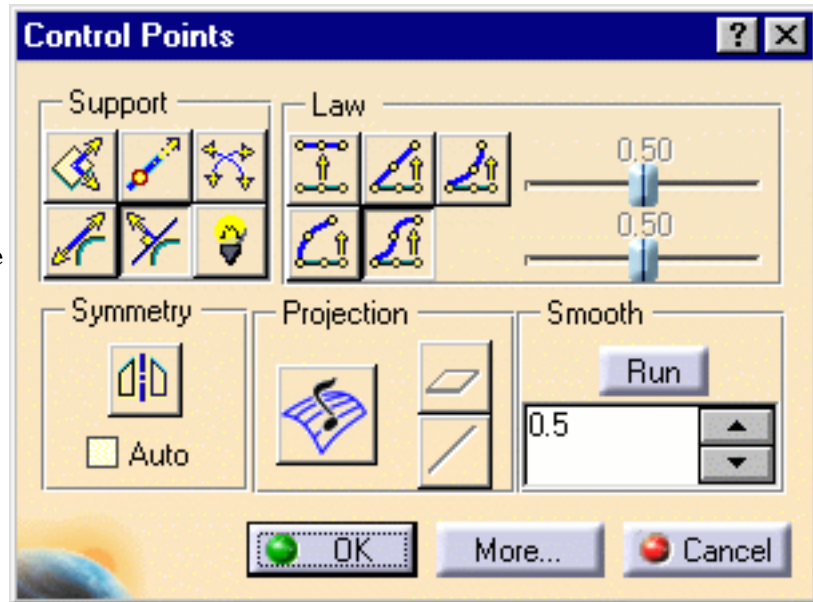

4. Use the control points and the mesh lines of the planar patch to deform it. The space transformation is defined between the initial patch and the deformed patch.

All surfaces are automatically and dynamically deformed according to this intermediate patch deformation.

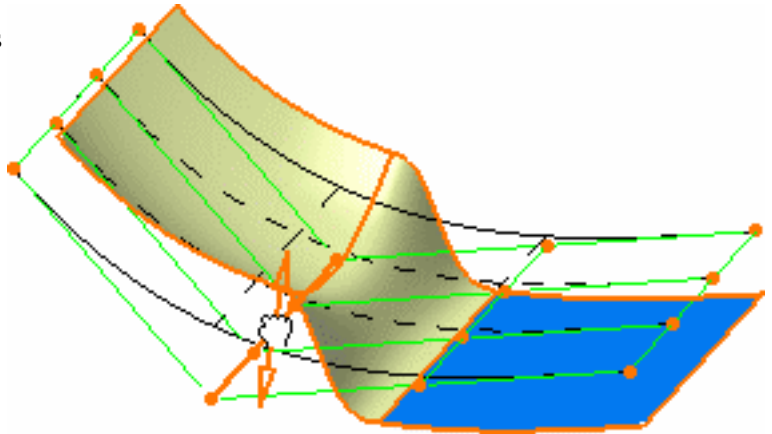

The final deformed surface looks like this.

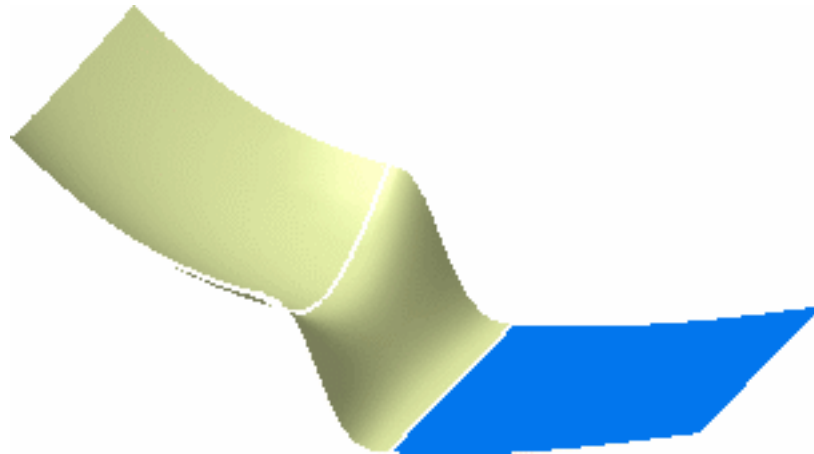



Open the [GlobalDeformation2.CATPart](#) document, select the surfaces to be deformed, and click the **Global Deformation** icon .

- If you choose the **1 guide** option, you then need to:

1. Click **Run** in the Global Deformation dialog box.
2. Select a guiding surface (here the blue surface).

The Control Points dialog box is displayed. Use the control points and mesh lines to deform the surface.

3. Click **OK** in the Control Points dialog box.

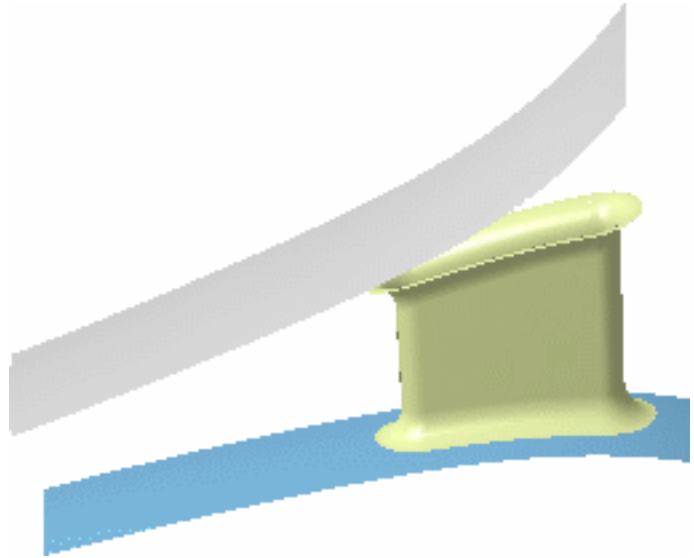

The deformation is performed along the selected guide.

- If you choose the **2 guides** option:

1. Click **Run** in the Global Deformation dialog box.
2. Select two guiding surfaces.

The Control Points dialog box is displayed. Use the control points and mesh lines to deform the surface.

3. Click **OK** in the Control Points dialog box.

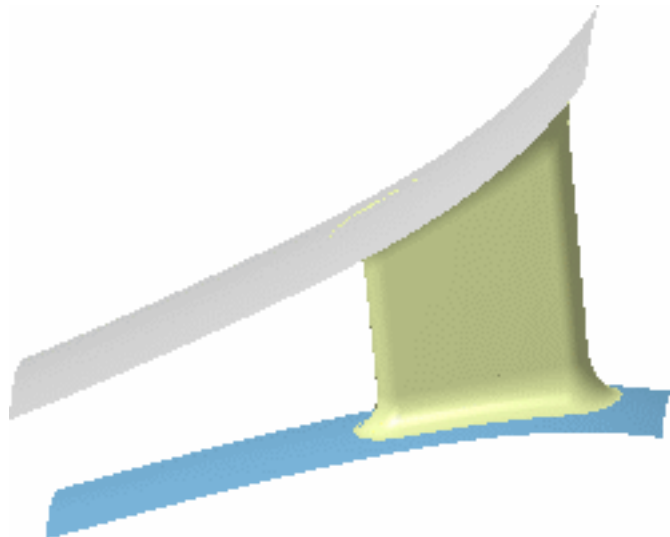

The deformation is performed along both selected guides.

- If you check the **Continuities on guide** option, the system globally deforms the surfaces while retaining the continuities on the selected guide. In our example, the top surface is selected as guide, and the **Continuities on guide** is checked.

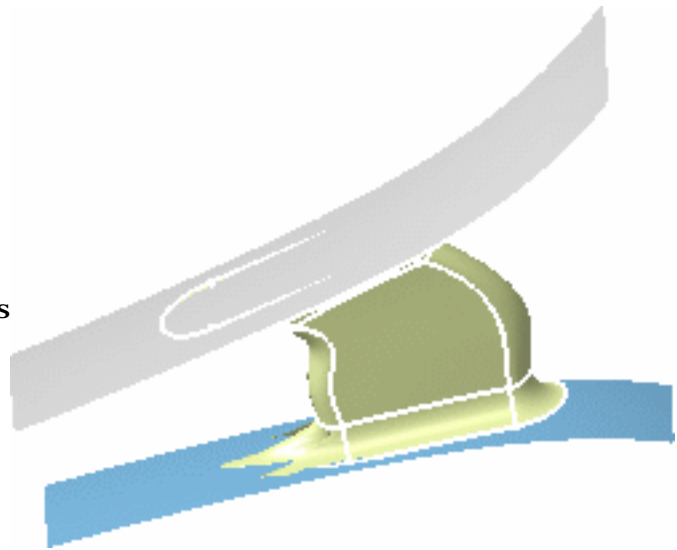

- When globally deforming re-limited surfaces, i.e. surfaces which **limits have been redefined**, make sure that you check the continuities between faces. Indeed, depending on the geometrical configuration, it may happen that the set continuities are lost when deforming.
- Available capabilities from the dashboard are: **datum creation**, **auto detection**, **attenuation**, **continuity**, **orders**, and

 **keep original.**



Analyzing Reflect Curves

P2

 This command is only available with the FreeStyle Optimizer.

 This task explains how to apply reflect curves onto a surface for analysis purposes.

 Open the [Manipulate1.CATPart](#) document.

 **1.** Select one or more surface(s).

2. Click the **Reflection Lines** icon .

The compass automatically is positioned above the surface and a grid of neons is displayed. Each neon is represented by a red line. It is an endless neon, and reflect lines are displayed in red over the surfaces.

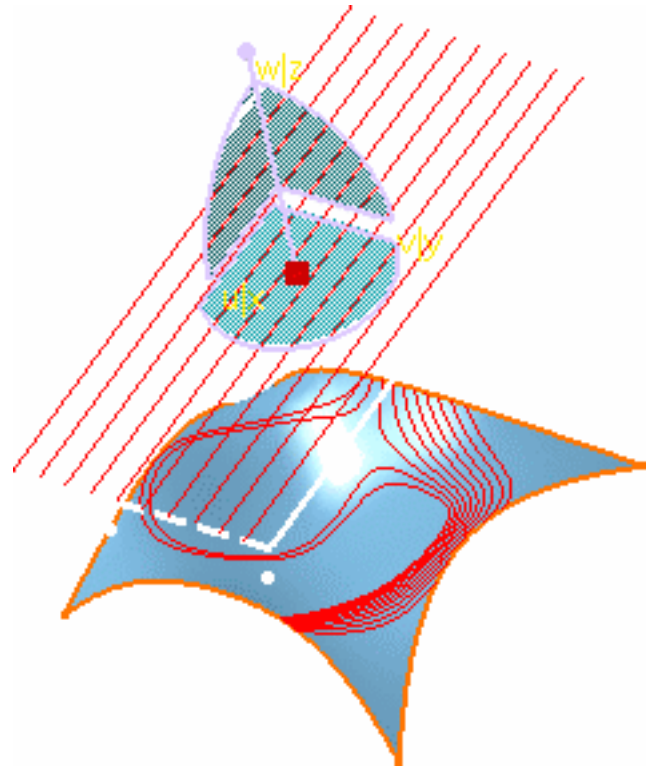

The Reflection Lines dialog box is displayed from which you can define a number of parameters:

- The number of **Neons** and the spacing between any two neons.
- The position: this option automatically calculates the position of the neon grid (according to the surfaces).
- The viewpoint:
 - according to the current 3D viewer: reflect lines are re-computed according to the new viewpoint when you are using standard viewing manipulators.
 - according to the user-defined viewpoint reflect lines do not move, when you are using standard viewing manipulators, but you can [move the eye](#).

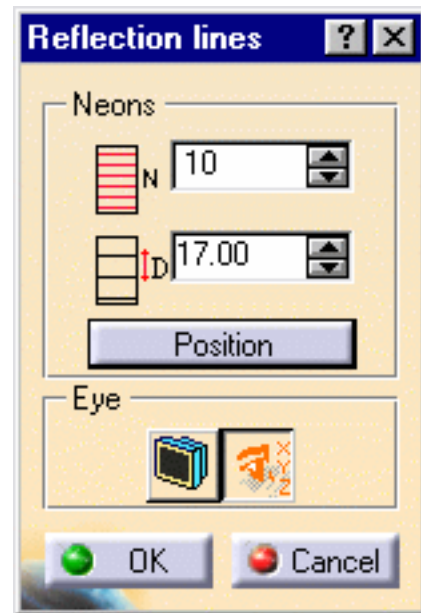

3. Move the grid using either the standard compass manipulators, or the grid manipulators to display a rotation direction and an axis.
4. Click the dot and still holding the mouse-key down, slide the pointer about the rotation axis.

Reflect lines on the surface evolve as you modify the position of the grid of neons, allowing you to analyze the reflection onto the surface.

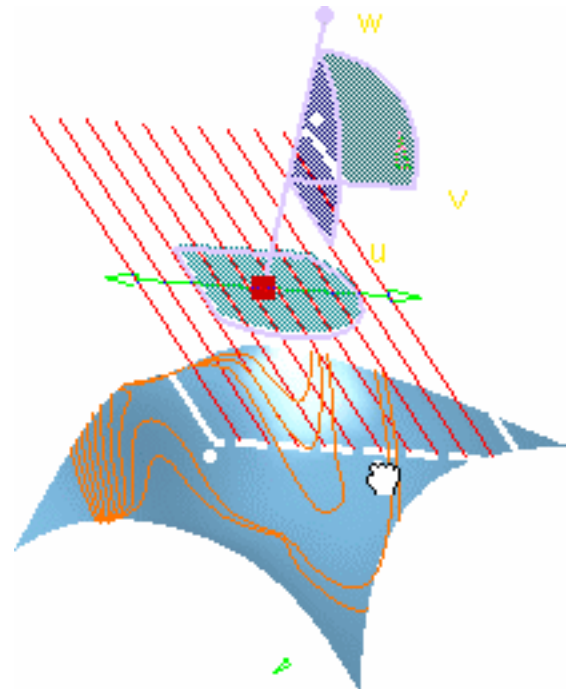

Use the **Edit angle step** contextual menu on the grid manipulators to allow the rotation of the grid by a value defined within the Step dialog box. In this case, clicking one of the grid manipulators rotates the grid by the set value. Press and hold the Shift key to rotate in the opposite direction.

5. Once you are satisfied with your analysis, simply click **OK** in the Reflection dialog box.



- You can select and deselect the analyzed surfaces, while applying the analysis. The reflect lines will appear or disappear respectively.
- When you select the geometrical set as an input in the specification tree, all the elements included in this geometrical set are automatically selected too.
- When you click the User-defined Eye icon , a dot is displayed (you need to zoom out to locate it) defining the eye and its position.
The reflect lines are frozen according to that direction, meaning that you can move the geometry around while keeping the reflect lines static according to that viewpoint.
You can move the eye using manipulators, or using the **Edit** contextual menu to precisely define its location.
- You can drop reflect lines onto the analyzed element. To do this, simply choose the **Keep this reflection line** or **Keep all reflection lines** from the contextual menu displayed when right-clicking either a reflection line itself or one of the grid neons.
A curve corresponding to the reflection line is created.
- A Reflect Lines Analysis is created in the specification tree. You can therefore create several such analyses on different set of surfaces or on the same set of surfaces but using a different viewpoint.
- As reflect line analyses are objects as such, they can be edited using the contextual menu in the specification tree.
You can transfer a reflect line analysis from an element to another, for example. To do this:
 - Double-click the reflect line analysis from the specification tree
 - Select the surface on which you wish to apply the analysis. Reflect lines are displayed on that surface provided the grid orientation is adequate.
 - Select the surface on which the analysis existed, to remove it.
 - Click OK in the Reflection dialog box



Available capabilities from the dashboard are: [datum creation](#), [auto detection](#), and [attenuation](#).



Creating Inflection Lines

P2



This task shows how to create inflection lines on a surface for analysis purposes.

Inflection lines are curves which curvature value necessarily is 0.

The system detects, within the planes parallel to the one defined by the compass, all points of the surface at which the curvature value is null, meaning that in these points, the curvature orientation is changing, and links them together into curves.



Open the [InflectionLine1.CATPart](#) document.

It contains a surface on which a cutting plane Analysis has been performed.



1. Drag and Drop the compass onto the zx plane.

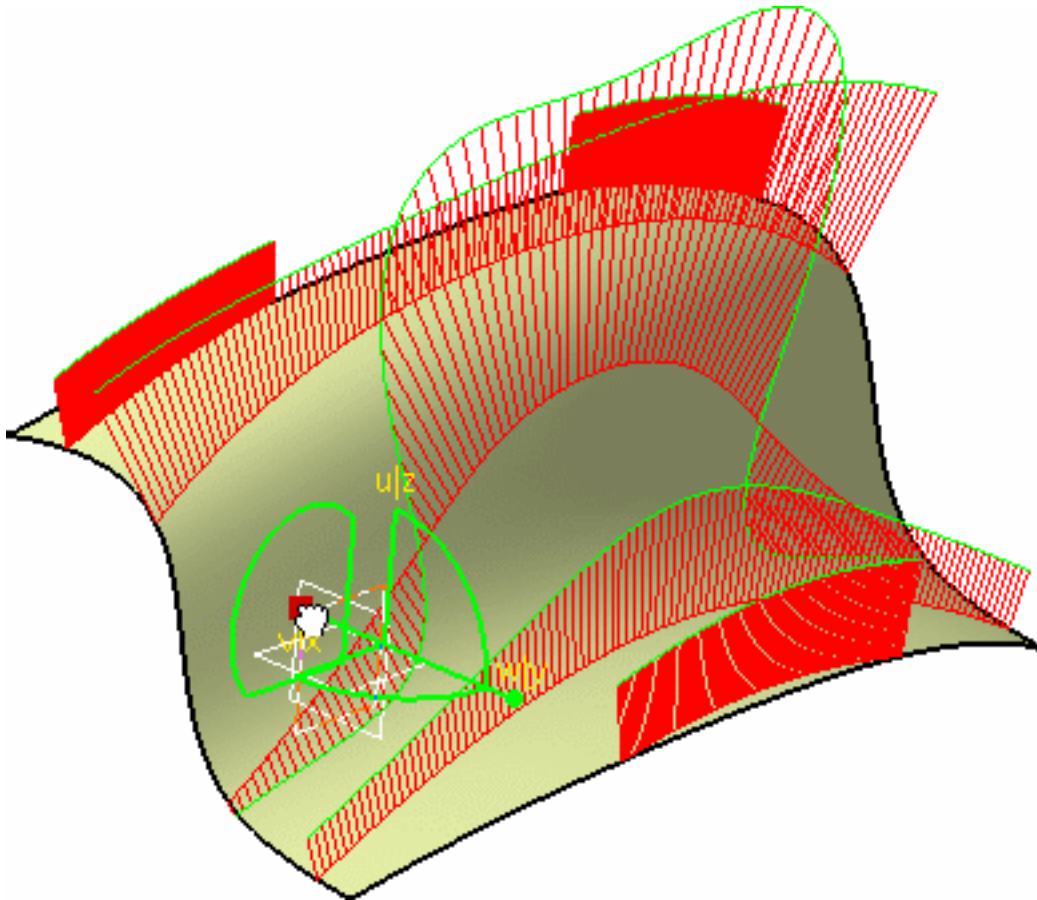

2. Select the surface to be analyzed.

3. Click the **Inflection Line** icon  in the Shape Analysis toolbar.

The compass is automatically positioned on the selected element, and the Inflection lines dialog box is displayed.

4. Define the plane used to compute the inflection lines on the surface:

- the compass base plane (**Compass Plane**)
- the surface parametric directions (**Parametric**)

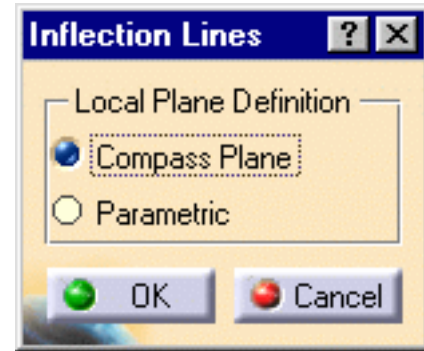

Once the local plane is defined, inflection lines are automatically displayed on the surface.

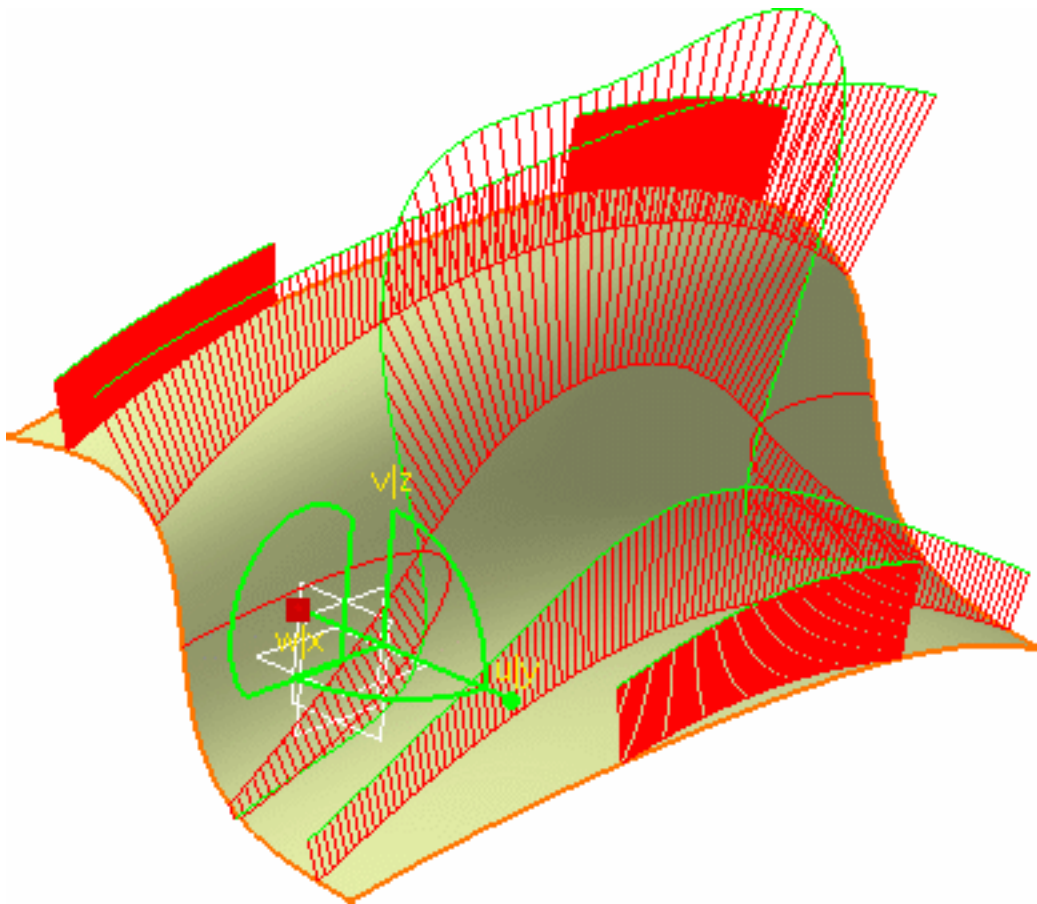

5. Hide the Cutting Plane analysis, using the Hide/Show icon  for example, to see the inflection lines better.

6. Grab the compass by its tip (w) and drag it along.

The compass base plane's orientation being modified, the inflection lines are updated accordingly:

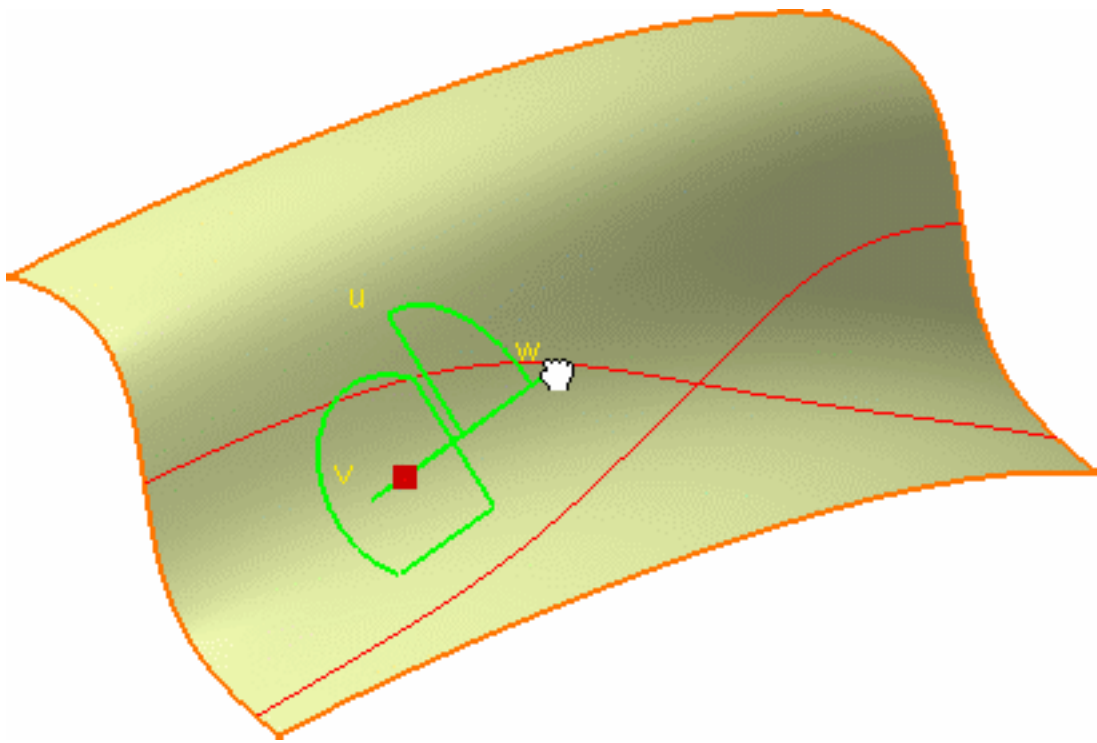

7. Click **OK** in the Inflection Line dialog box to create the analysis as an element in the specification tree.

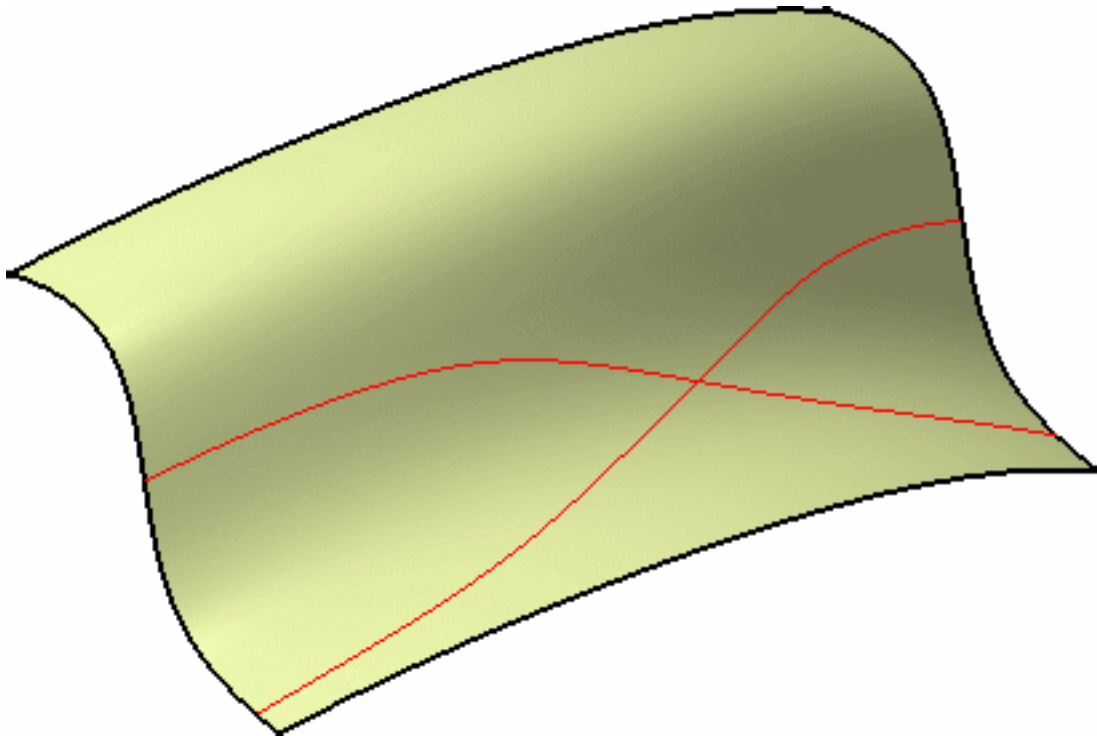



- Creating and retaining inflection lines on a surface is especially useful to determine at which points the curvature of the intersection between the cutting planes and the surface is null.
- Used in conjunction with the **Inflection area** option of the Surfacic Curvature Analysis command, you can notice that these lines always are created within the blue.
- When you select the geometrical set as an input in the specification tree, all the elements included in this geometrical set are automatically selected too.



Interoperability Between the FreeStyle Shaper and Optimizer



The following scenario illustrates, in an industrial environment, how to work with the FreeStyle Shaper and Optimizer specific commands. This scenario is performed in P2 mode, because some of the capabilities used throughout the scenario are available with the P2 configuration only (all FreeStyle Optimizer capabilities for example)

Creating Four-Points Patches
Deforming the Surface Limits
Fitting the Surface to a Cloud of Points
Analyzing the Surface
Smoothing the Surface
Extracting the Surface



This scenario is accomplished in ten minutes. It consists in creating the surface corresponding to the roof of a car.

The resulting roof surface will look like this:

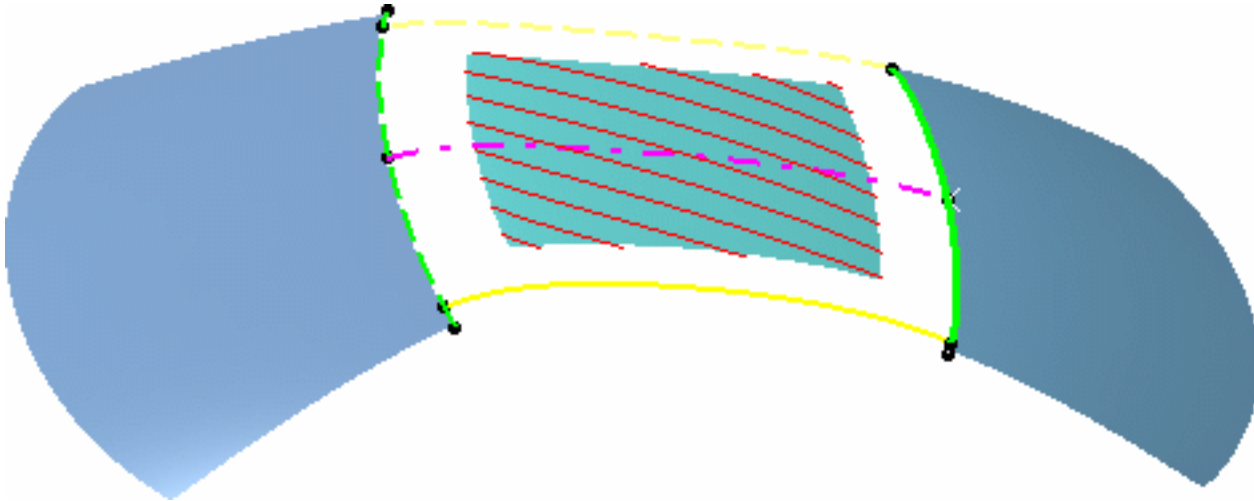



Creating Four-Points Patches



 This task explains how to create a pad from a sketch in the Part Design Workbench.

 Open the [RoofStart.CATPart](#) document. It contains windshields of the car, style curves limiting these (windshield boundaries) style curves, onto which the roof should be mapped, and curvature analyses applied onto each of these styling curves.
You can hide the Reflect Line Analysis for the moment.

 **1.** Check the **Snap On Vertex**  icon from the FreeStyle Dashboard to snap onto the closest corner when moving the pointer close to the geometry

2. Click the **Four-Point Patch** icon  .

3. Click the four style curve end-points (yellow styling D curves) as limits to the roof patch.
Because the [auto detection](#) capability has been activated, the end point are easily detected.

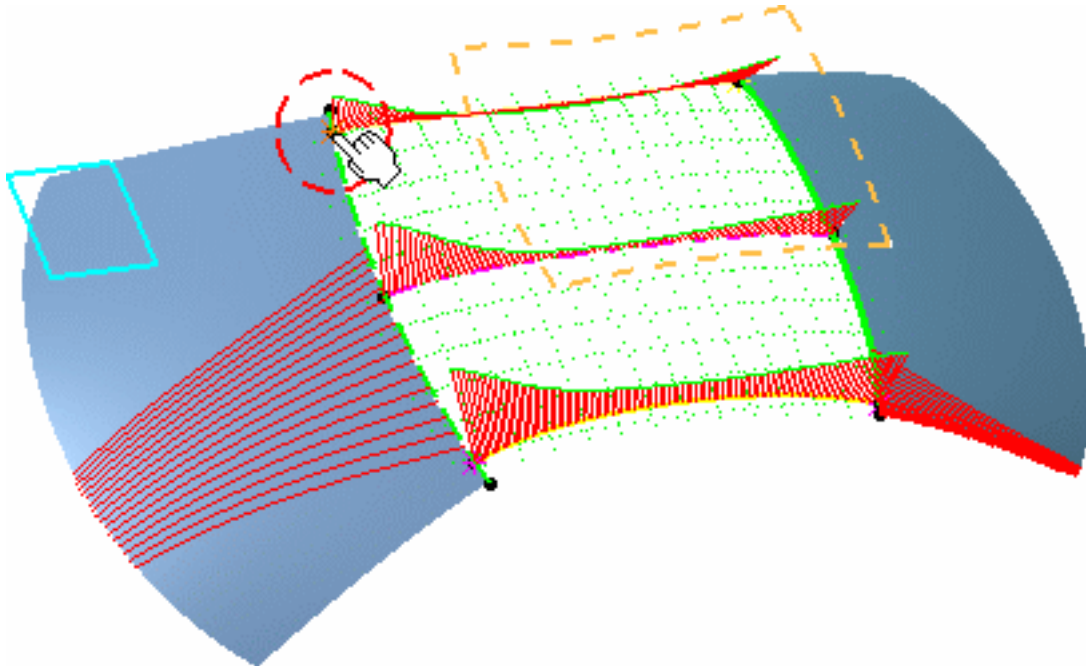

The patch is created.

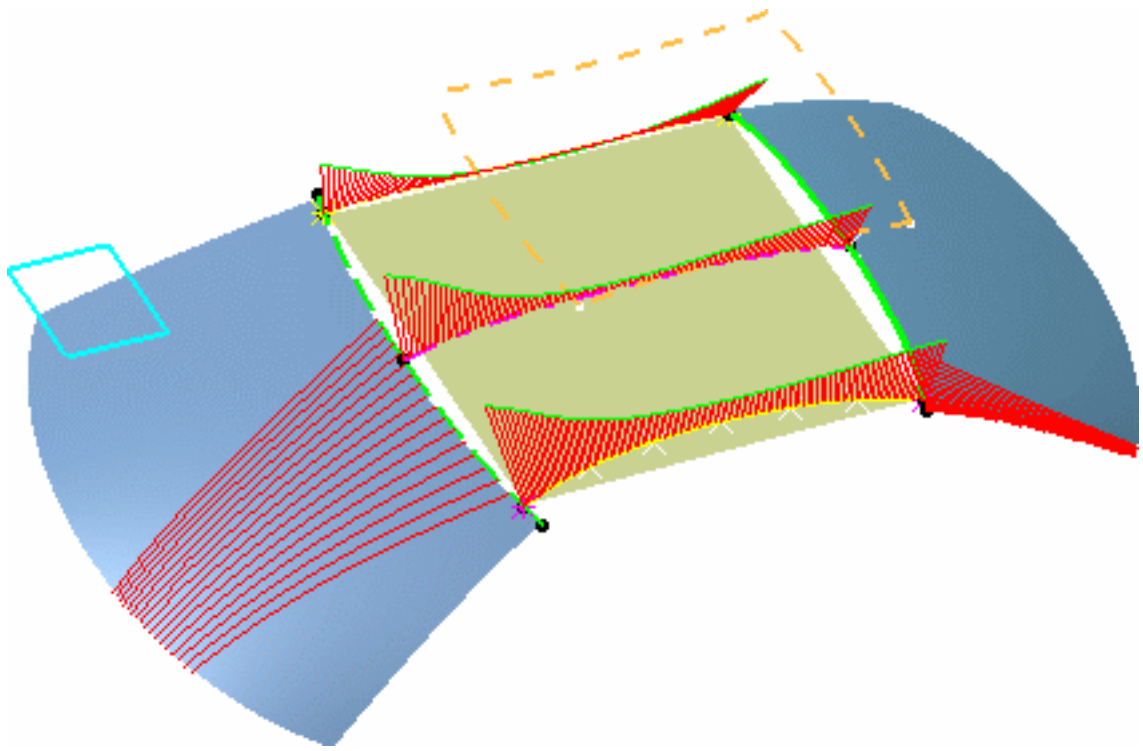

Deforming The Surface Limits



This task explains how to modify the surface limits within a given plane (in 2D) to get them to coincide with the already existing geometry.





The RoofStart.CATPart document still is open from the previous task.

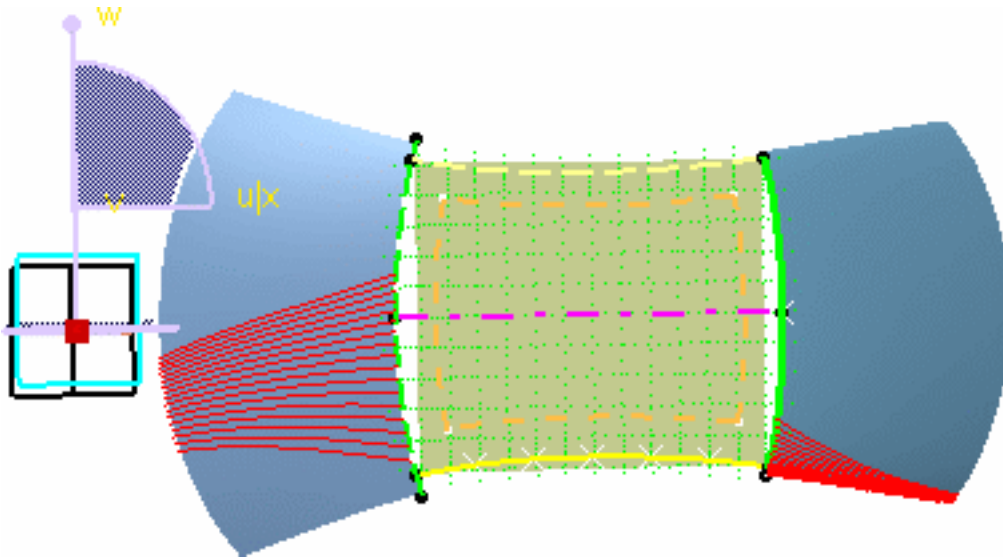

1. Hide the three Curvature Analyses, using the **Show/Hide** contextual menu from the specification tree.
2. Drag the compass by its base and drop it to position it, normal to the ZX reference plane.
3. Choose the **Top View** icon  from the View toolbar.

This will allow you to position the symmetry plane according to the current plane.



4. Select the surface you just created and click the **Control Points** icon .

The Control Points dialog box is displayed.

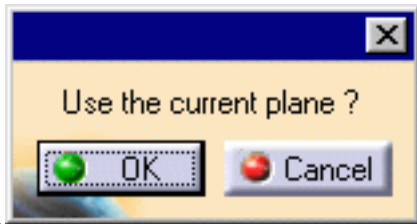

5. Click the **Symmetry** icon  from the Control Points dialog box.

A message is issued asking whether you want to use the current plane, that is the one you defined above, as the symmetry plane



6. Click **OK**.

7. Choose the following deformation options from the dialog box:

- Support: **Translation along mesh lines** 
- Law: **Move selected points using a convex law** 

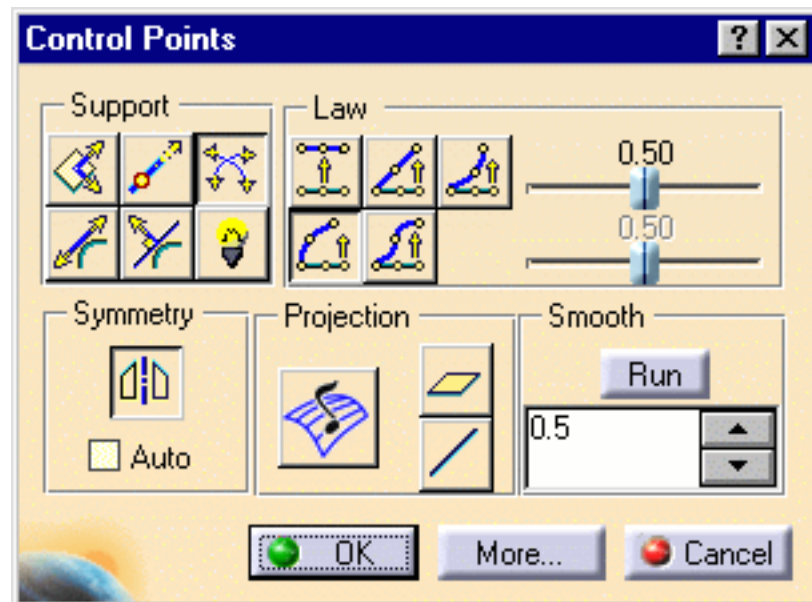

8. Click the top front control point, then press and hold the Shift key then click the bottom front control point.
The whole front mesh line is selected.
9. Use the manipulators on one of the corner control points to bring it closer to the orange reference curve.

The mesh line takes the global shape of the reference curve, even though it does not match it perfectly yet.

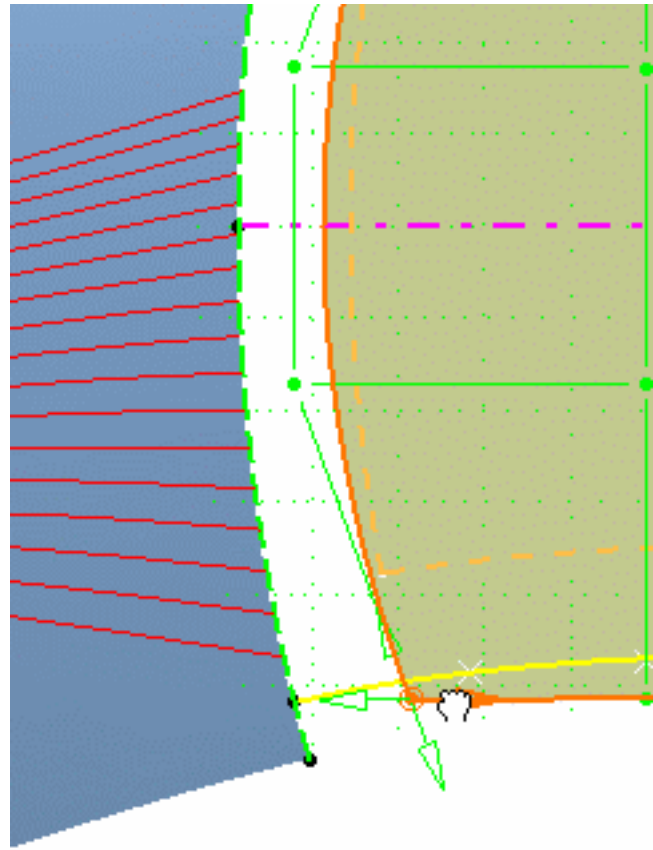

10. Repeat this operation with the rear mesh line and reference curve.

11. From the Control Points dialog box, select new options:

- Support: **Translation along local tangents**



- Law: **Move selected points identically**



12. Select the front mesh line and drag it towards the reference curve so that it is superimposed. Repeat this step with the rear mesh line and reference curve.

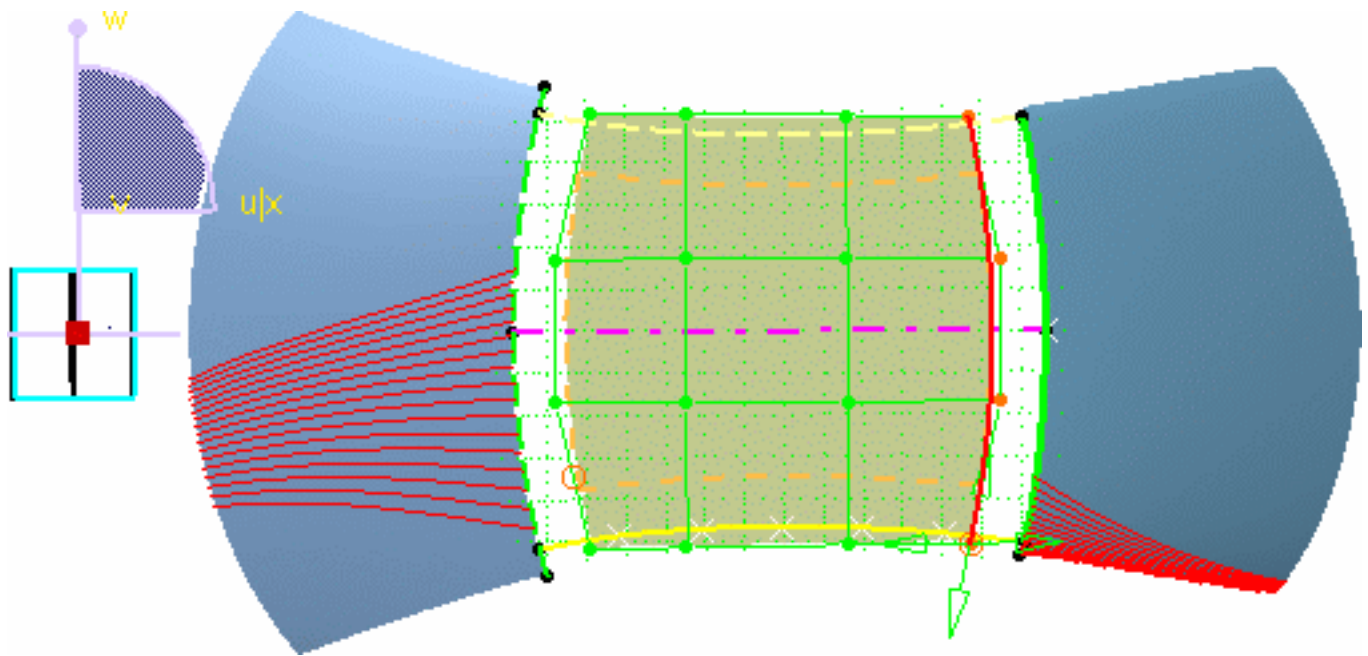

13. Select one of the side mesh lines and bring it closer to the orange reference curve till the patch corner reaches the curve's end points.

You need to iterate on the front and rear mesh lines, using the same options to reach a satisfying level of superimposition.

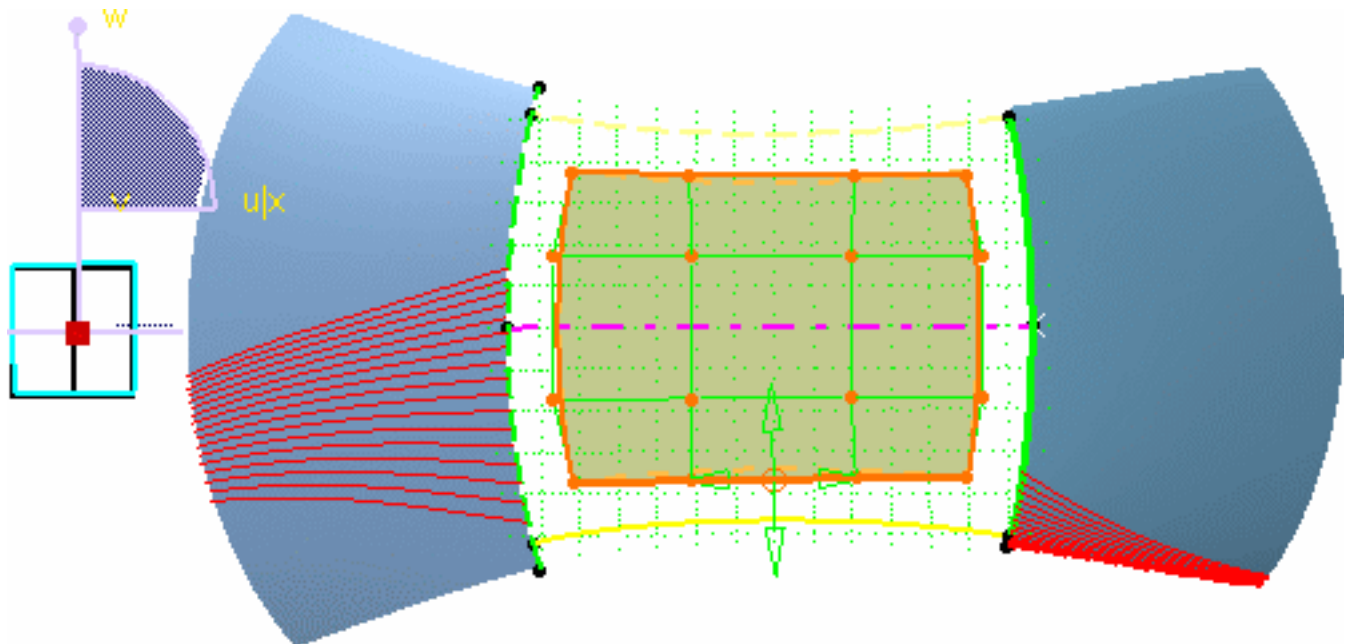

For further tuning you need to zoom in and move single control points.

- 14.** Select each patch corner point and move it exactly onto the reference corner point.
You need to move them along both X and Y.
- 15.** Move each side control points to superimpose the patch boundaries and reference curves.
You need to move them along the Y direction only.
- 16.** Move the inner control points 2 by 2, using the Shift key, to move them closer to the patch center.

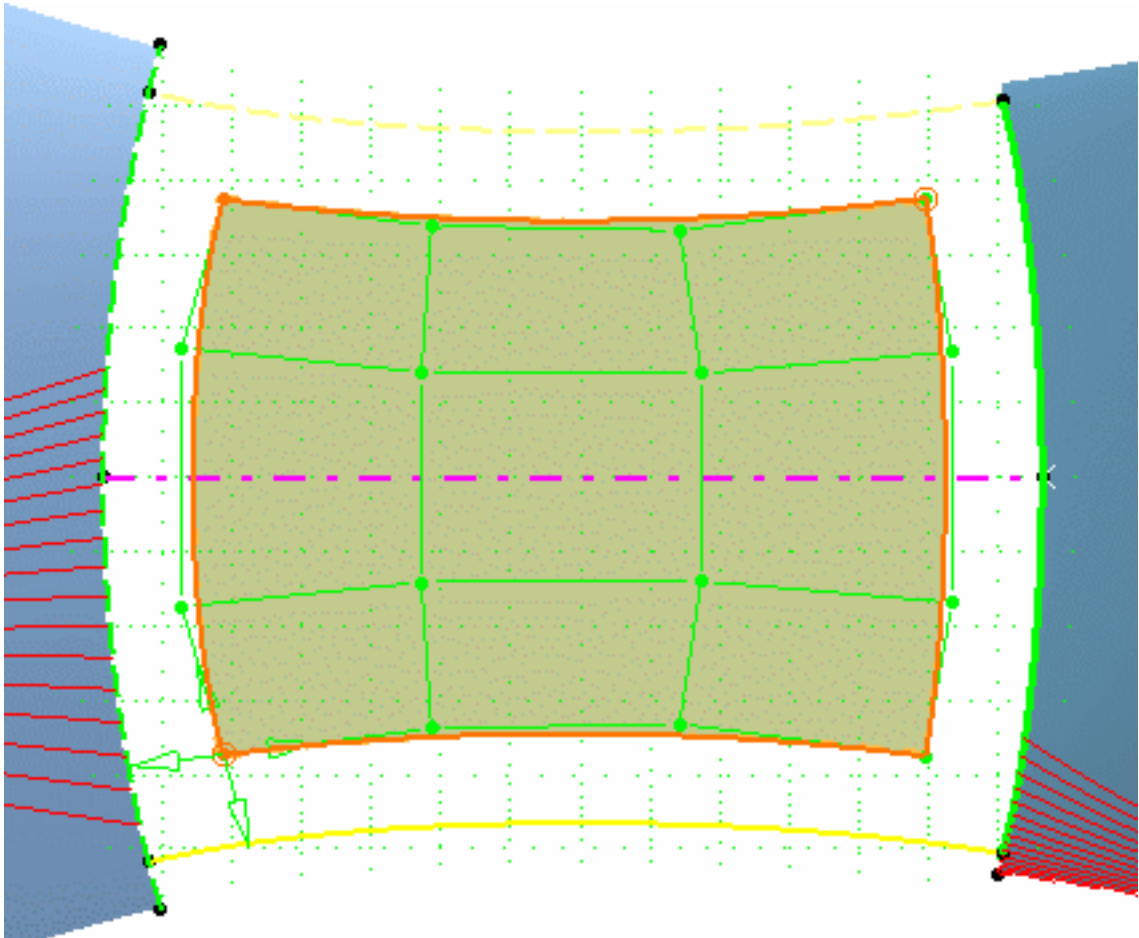

The patch now has the shape given by the reference curves.





Fitting The Surface To a Cloud of Points



 This task explains how to fit the deformed surface to an existing cloud of points.

 The RoofStart.CATPart document still is open from the previous task.

 **1.** Reset the compass to the default position using the  and  icons.

2. Select the roof patch as the source element.

3. Click the **Fit to Geometry** icon .

The Fit To Geometry dialog box is displayed and texts indicating the fitting constraints are displayed on the surface boundaries provided the **Continuity** icon  is active in the Dashboard.

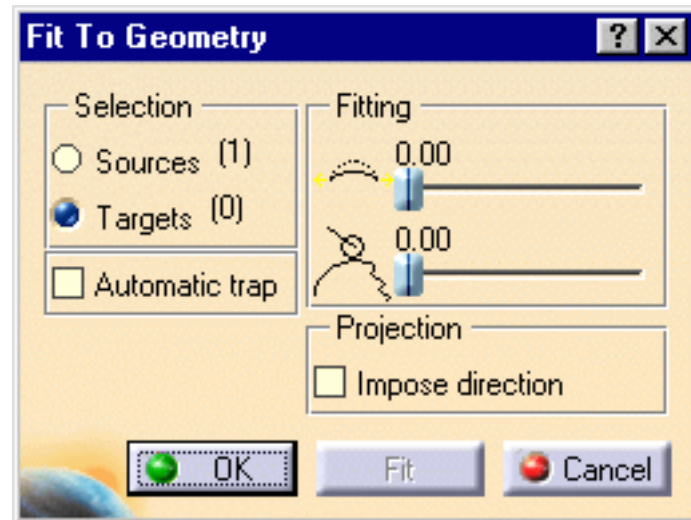

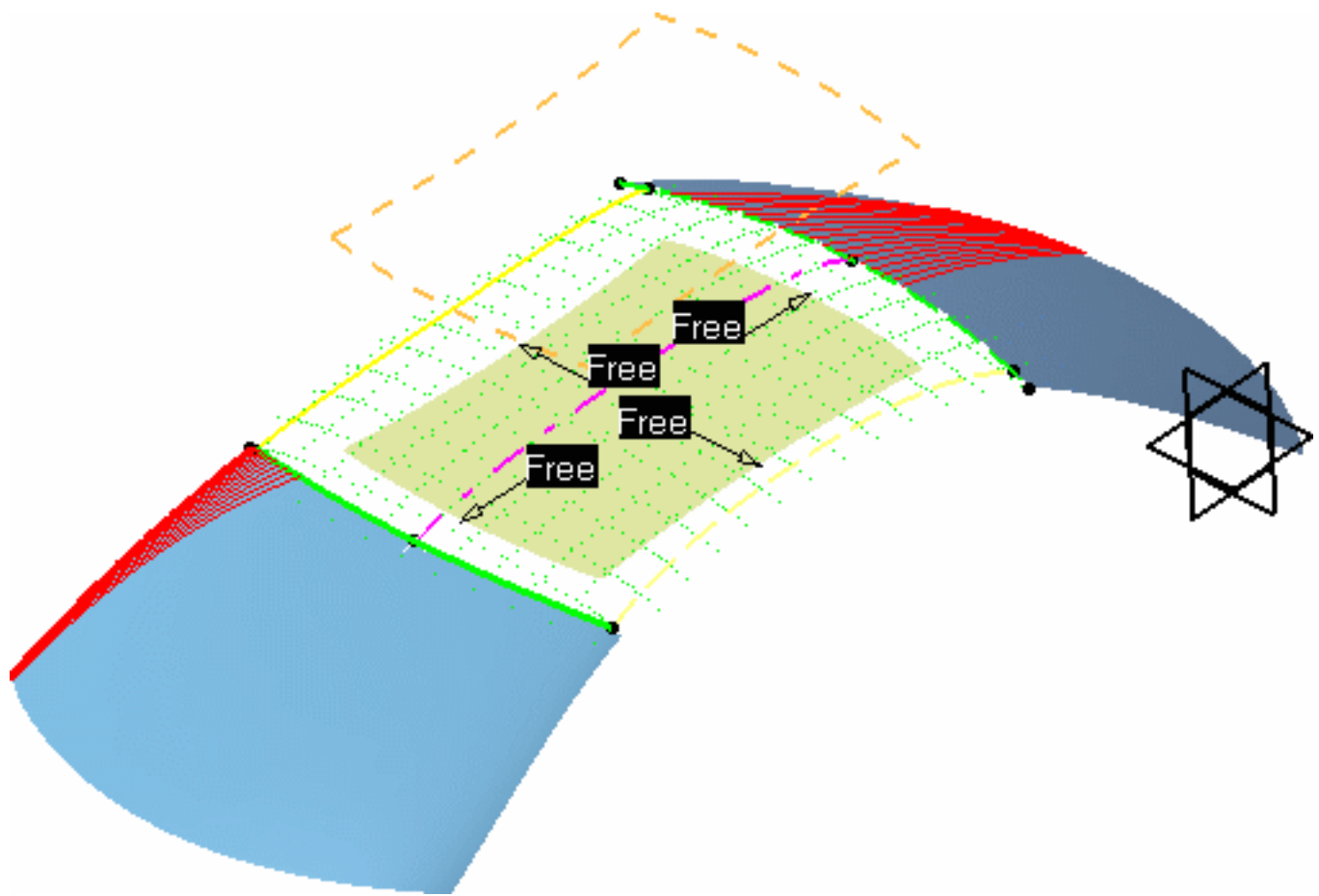

4. Set the following parameters in the dialog box:

- set the fitting tension to 0.5 and smoothing to 0.3
- make sure the **Impose direction** option is unchecked
- and from the Dashboard, click the **U, V Orders** icon  and make sure they are Nu= 4 and Nv= 4

5. Select the Cloud of points as the target element.

It may be easier to select it from the specification tree than from the geometry itself.

6. Click Fit in the dialog box.

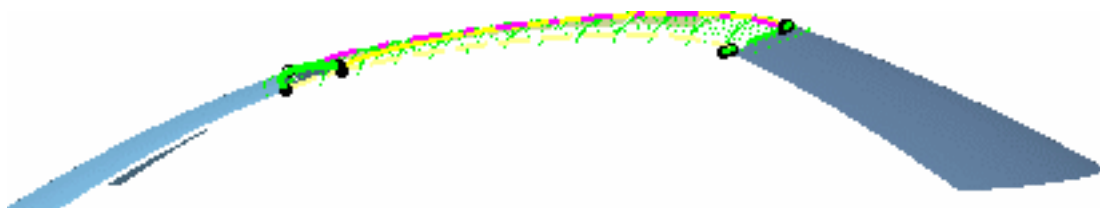

7. Click OK in the dialog box.



Analyzing The Surface



 This task explains how to analyze the surface, once it has been fitted onto the cloud of points. This is done via two different analyses:

1. a distance analysis
2. a reflect line analysis

 The RoofStart.CATPart document still is open from the previous task.

 **1.** Click the **Distance Analysis** icon .

The Distance dialog box is displayed.

2. Select the fitted surface as the first element.

3. Set the following parameters in the dialog box:

- Check the **Normal distance** direction
- Check the **Limited Color Range** mode

4. Click the More button to display further options:

- Check the **Color scale** button to display the color range
- Check the Min/Max values to display these values on the geometry

- Check the **Points** button
- Uncheck the **Spikes** button and all its options

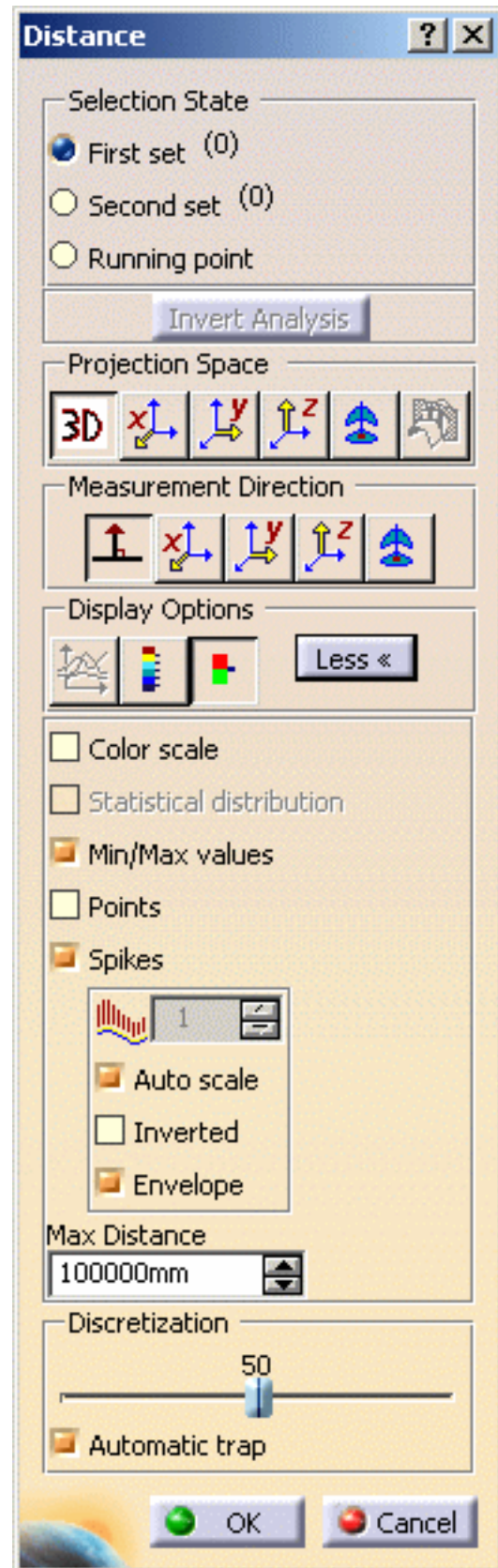

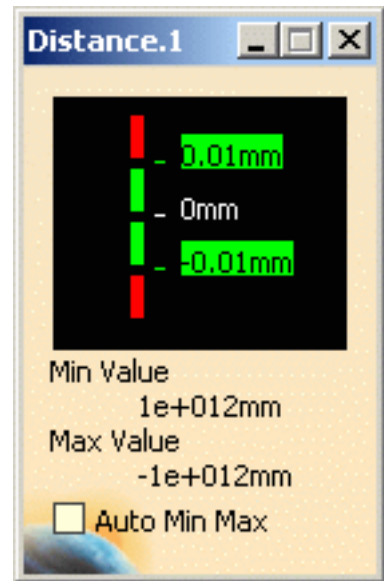

- From the displayed color range, set the colors to:
 - blue for all points located over 0.15mm above the surface
 - green for all points between 0.15 and -0.15mm away from the surface
 - red for all points located beyond -0.15mm below the surface

5. Check the **Second set** button then select the cloud of points.

Points are dynamically displayed and the minimum and maximum deviations are identified on the surface.

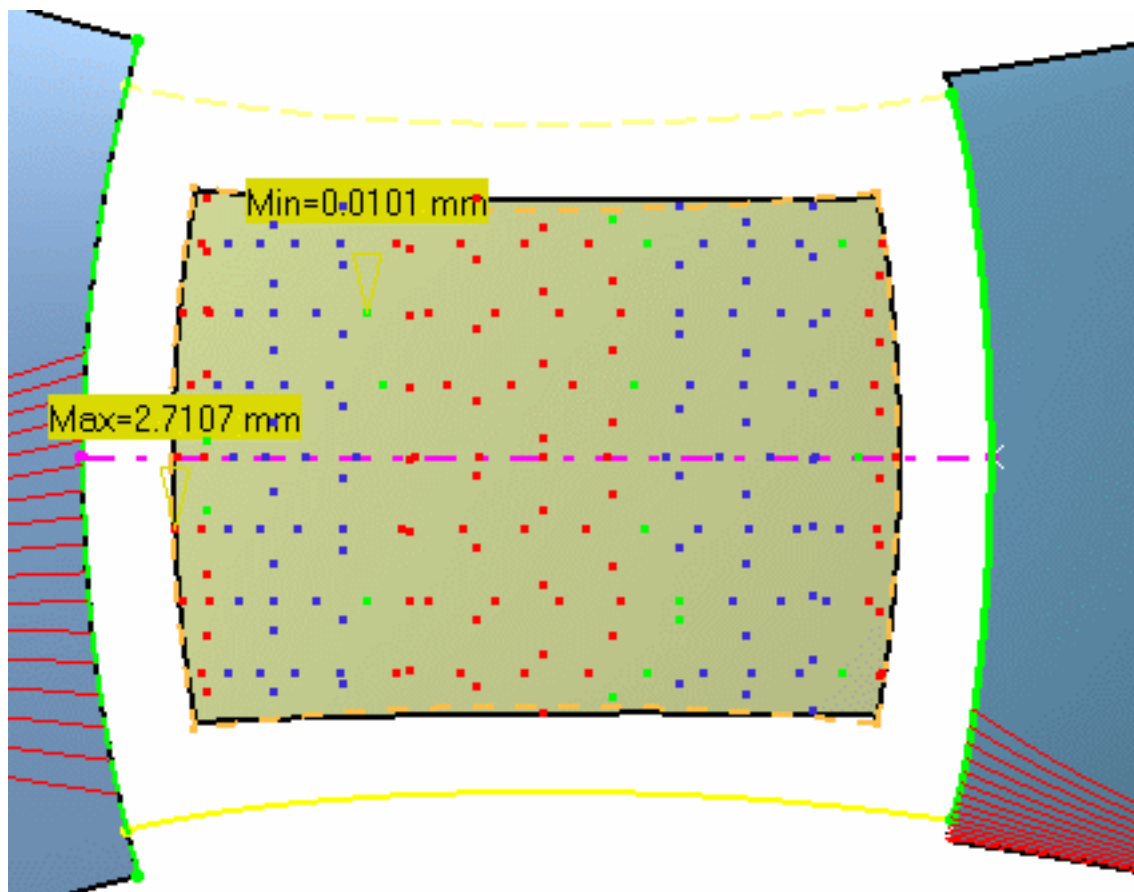

6. Click OK.

The parts of the surface that lie above the cloud are identified by blue dots, and red for parts lying below the cloud. This means that the surface needs to be smoothed further, so that all points turn green indicating a perfect matching with the cloud of points.

7. From the specification tree, choose the **Show/Hide** contextual menu on the distance analysis to hide it for the moment.

8. Choose the **Top View** icon  from the View toolbar.

9. From the specification tree, double-click the Reflect Line Analysis. 1.

The Reflection Lines dialog box is displayed and a grid of neons appears in the geometry.

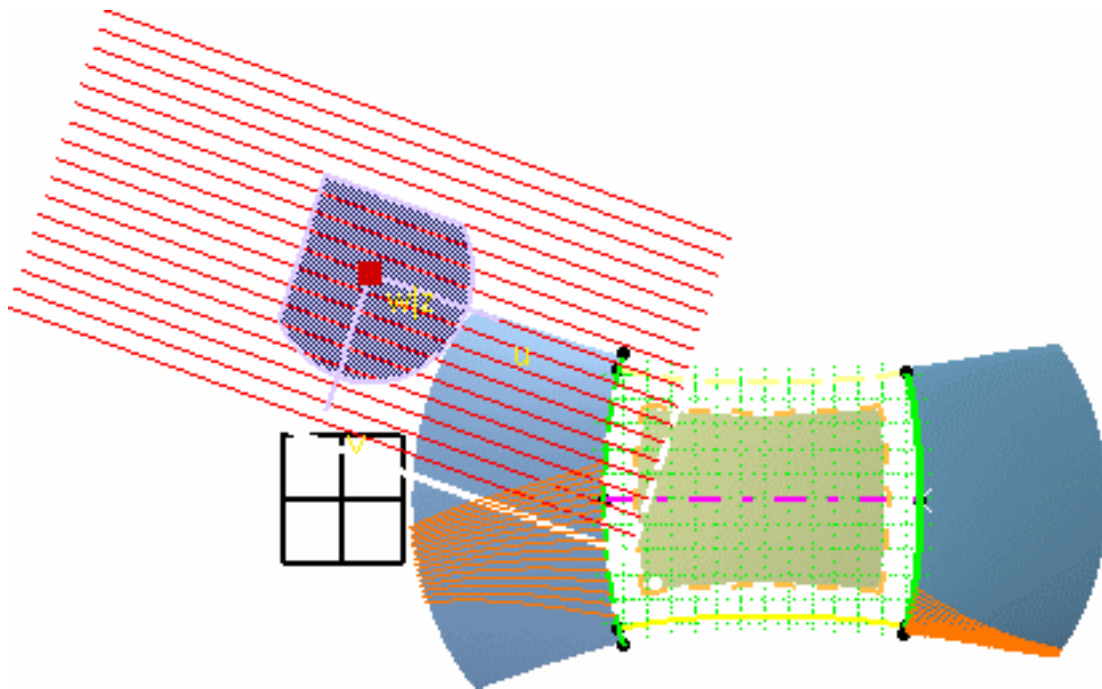

10. Click the front and rear windshields to remove the current reflect lines, then select the roof patch to apply the reflect line analysis.

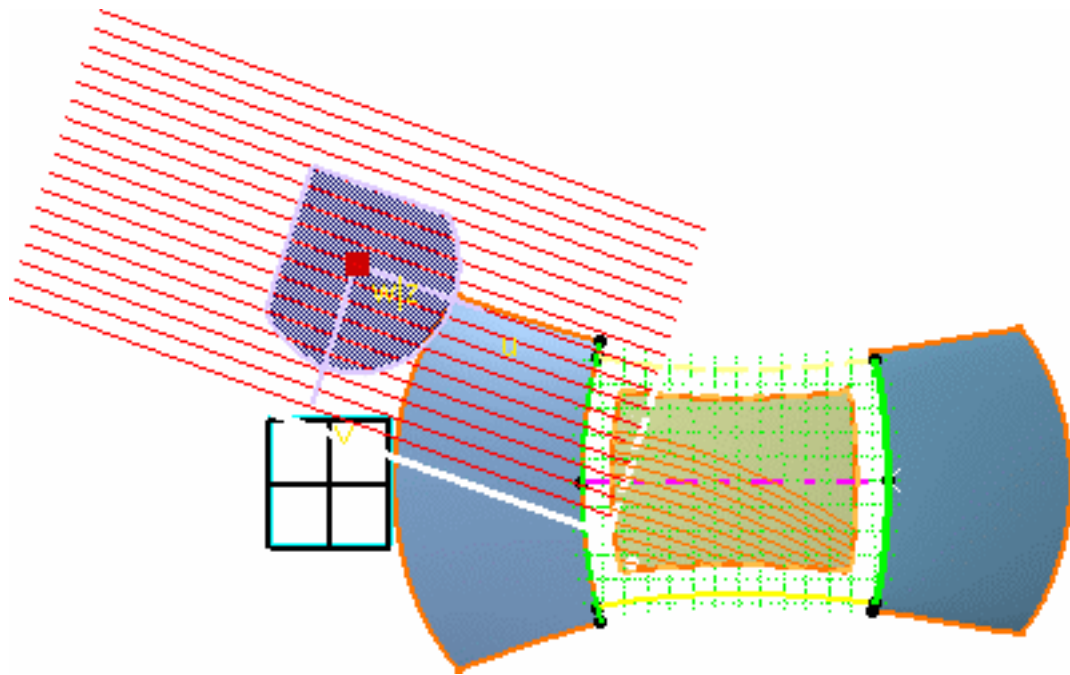

- 11.** Set the neons parameters to $N=21$ (number of neons in grid) and $D=150$ (distance between two neons).
- 12.** Zoom out till you locate the green dot symbolizing the analysis eye.
- 13.** Right-click on this eye and choose the Edit contextual menu.

The Tuner dialog box is displayed.

- 14.** Key in the eye's coordinates: 1850, 0, 3000 and click OK.

This moves the eye directly above the roof patch.

- 15.** Click Close in the Tuner dialog box, then OK in the Reflection Lines dialog box.

The analysis is visible on the roof patch:

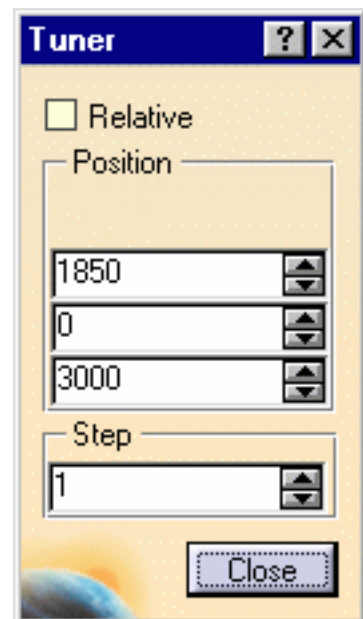

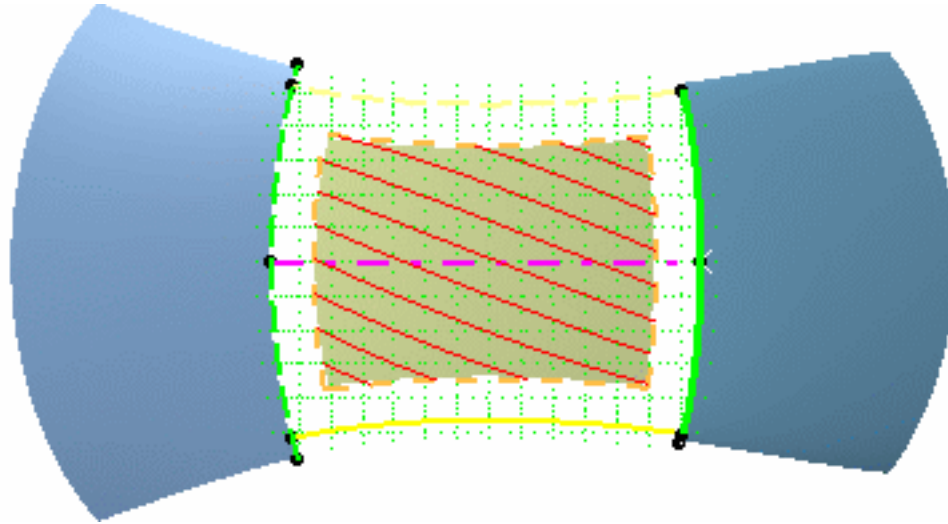

Smoothing The Surface



This task explains how to further smooth the surface onto the cloud of points following the distance and reflect line analyses.





The RoofStart.CATPart document still is open from the previous task, and you need to display the distance analysis again, using the **Show/Hide** contextual menu.



1. Choose the **Tools -> Options** menu item, **Shape -> FreeStyle** tab, set the **attenuation** value to 0.01 and click OK.
2. Drag the compass by its base and drop it to position it, normal to the ZX reference plane. This to set it within the symmetry plane.
3. Select the roof surface and click the **Control Points** icon .

The Control Points dialog box is displayed.

4. Choose the following options:

- Support: **Translation along local normals** 
- Law: **Move points identically** 
- Symmetry: use the current plane

5. From the Dashboard, click the **U, V Orders** icon .

Set the order numbers to $N_u=5$ and $N_v=7$ using the contextual menu, to increase the number of mesh lines in U and V respectively. This brings more flexibility in terms of modifications.

6. Select the central U mesh line.

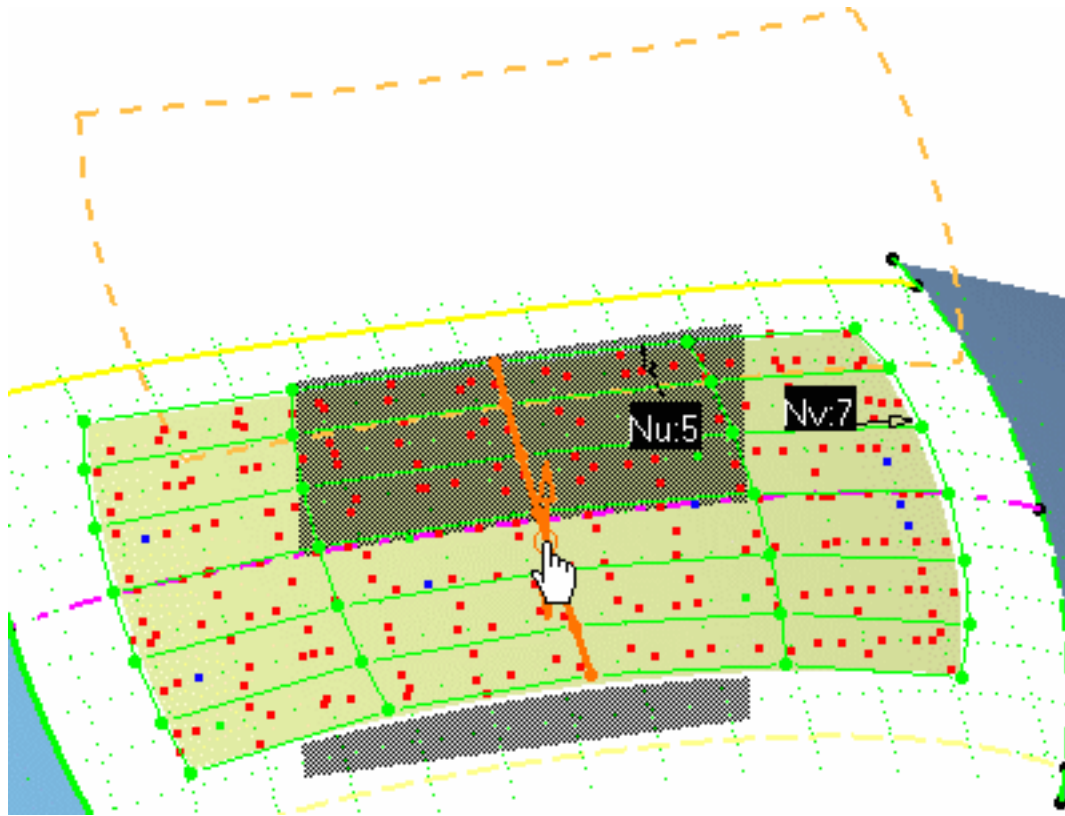

7. Right-click the arrow to display the contextual menu and choose **Edit**, then decrease the deformation step to 0.75.

8. You can also choose the **Freeze** contextual menu, to avoid selecting points from the cloud.

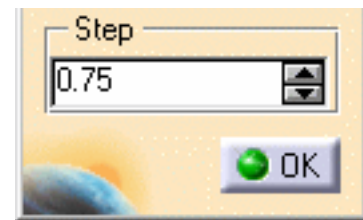

9. Press and hold the Shift key, and click the arrow up or down till you display green points all over the surface. You may also need to decrease the step and attenuation values and the number in U and V to reach a smoothed surface, i.e. displaying mostly green dots, that is lying between - 0.15mm and 0.15 mm from the cloud of points.

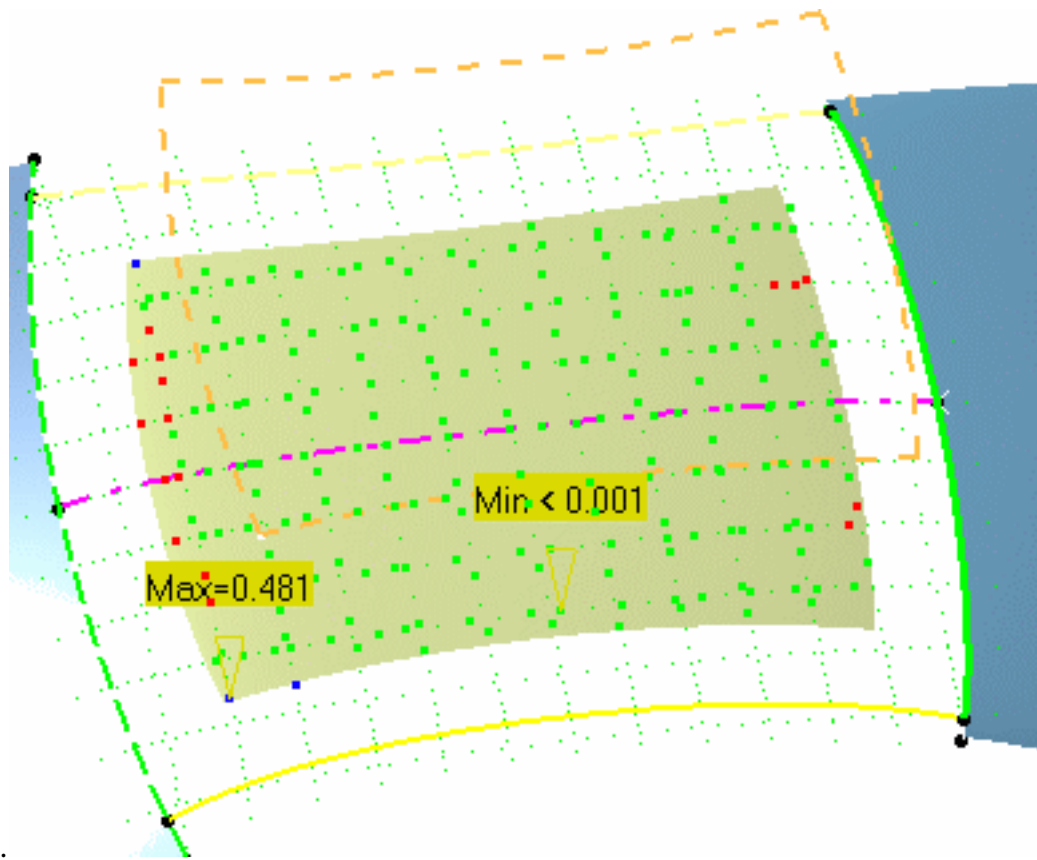

Extracting The Final Surface

P2



This task explains how to extract a shorter surface from the smoothed surface in order to remove the rugged ends of the surface.



The RoofStart.CATPart document still is open from the previous task.



1. Click the **Geometry Extraction** icon .

2. Select the roof surface, move the pointer to the limit of the green area, towards the rear of the surface, and click to define a corner of the new surface.

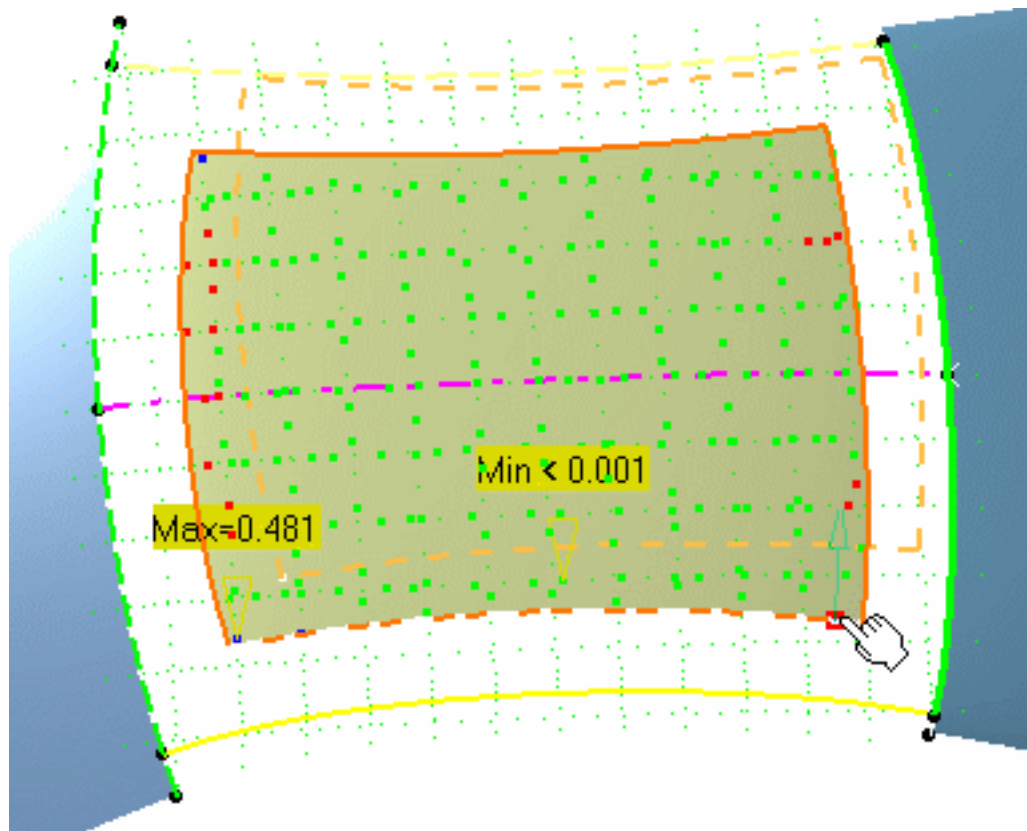

3. Drag the pointer over the side of the surface to the green area limit and click to define the second corner definition.

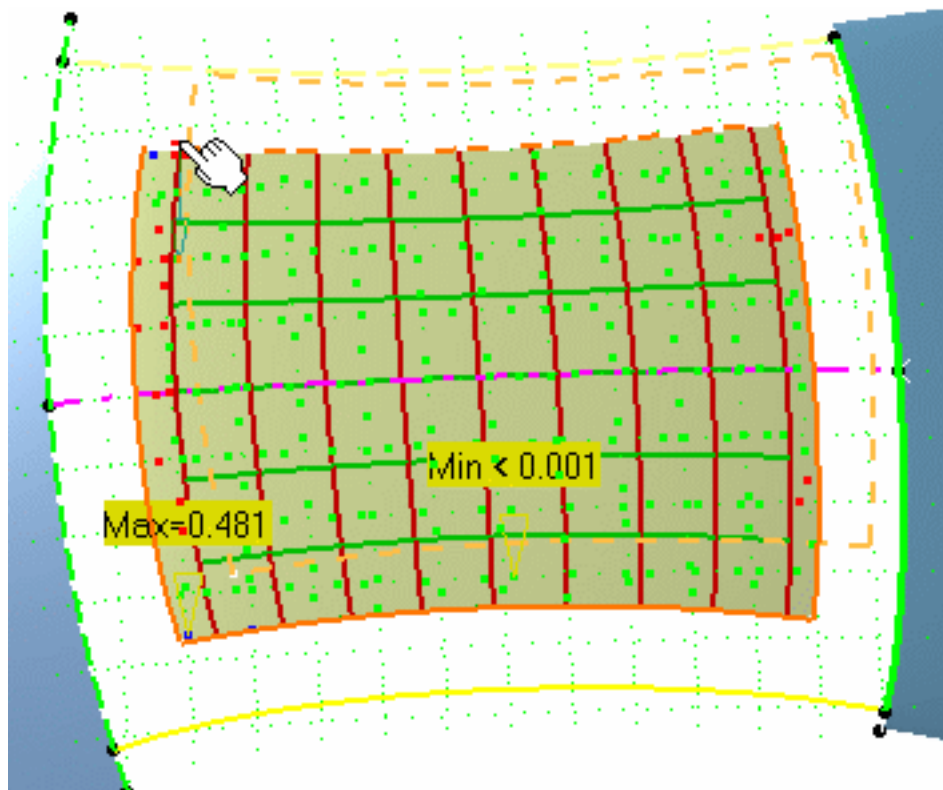

The new surface is created.

4. Double-click the Reflect Line Analysis from the specification tree, and transfer it by successively clicking the initial surface then the new one.

5. Hide the initial surface using the **Hide/Show** contextual menu.

You can also modify the final surface color using the **Properties** contextual menu, **Graphic** tab.

The final roof surface looks like this:

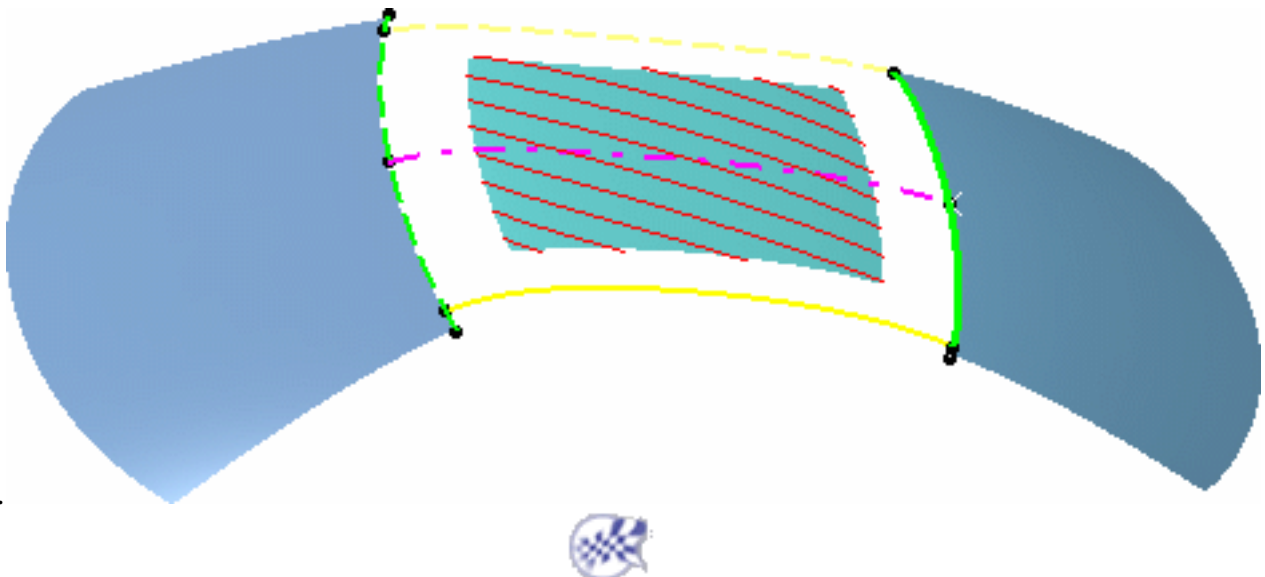

Using the FreeStyle Profiler



The FreeStyle Profiler offers complementary capabilities to the FreeStyle Shaper. It is used on the same type of elements yet taking the design capabilities one step further.



Create a net surface : select the guide and profile curves, choose the dominant curves



Create a styling sweep: choose the sweep type, select the profile, spine, guide and reference profiles if needed, display and manipulate the parameters.

Creating a Net Surface

P2

 This command is only available with the FreeStyle Profiler.

 This task explains how to create a surface, based on an existing set of curves (the net).

 Open the [NetSurface1.CATPart](#) document.

 **1.** Click the **Net Surface** icon .

The **Net Surface** dialog box is displayed.

The **guides (0)** text is highlighted.

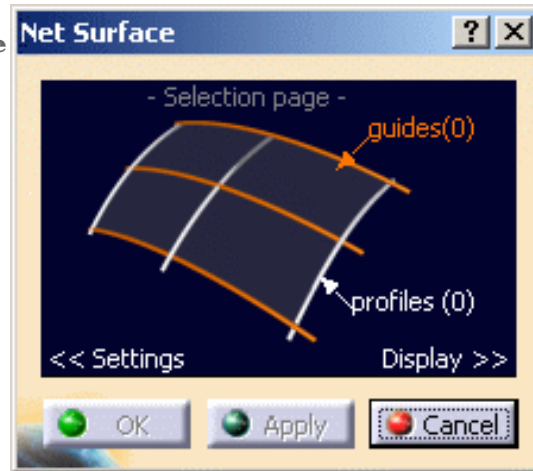

2. Successively select one or more guide curves in the geometry (using the **Ctrl** key for multi-selection).

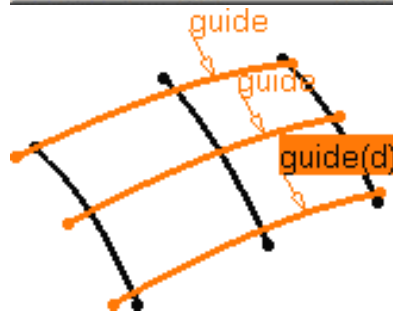

3. Click the **profiles** text in the dialog box and select all the profile curves in the geometry, one after the other.

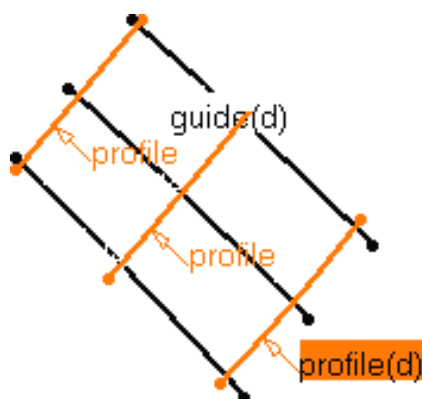

The dialog box is updated with the number of guides and profiles selected.

i You noticed that the first guide and profile you selected is identified by a **(d)** standing for "dominant". This means that the surface segmentation is based on these specific curves segmentation.

If you click on a curve text, **guide** or **profile**, the curve then becomes the dominant curve.

4. Click the **<<Settings** text to access advanced settings.

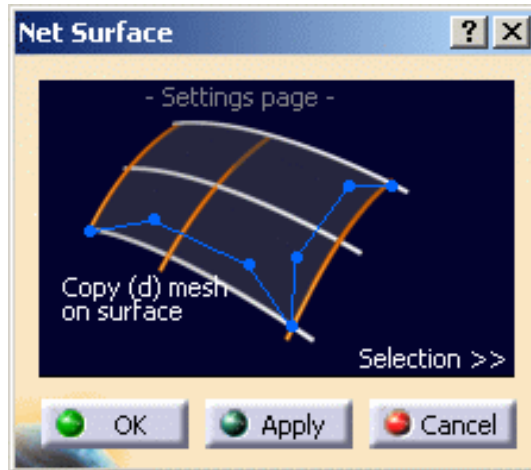

5. Click the **Copy (d) mesh on surface** (it highlights) to copy the geometry of the dominant guide curve and the dominant profile onto the net surface.

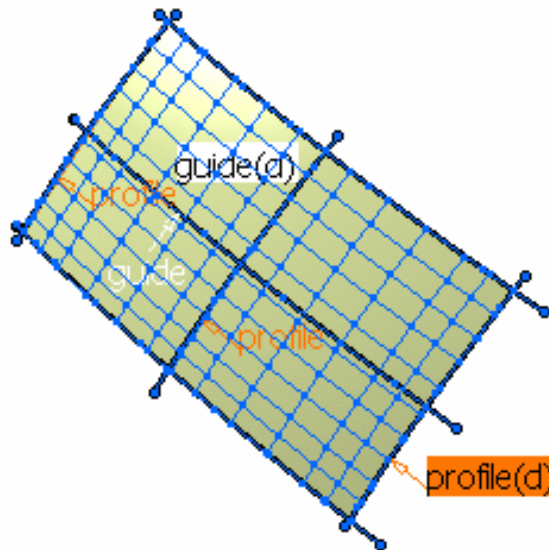

Without option highlighted

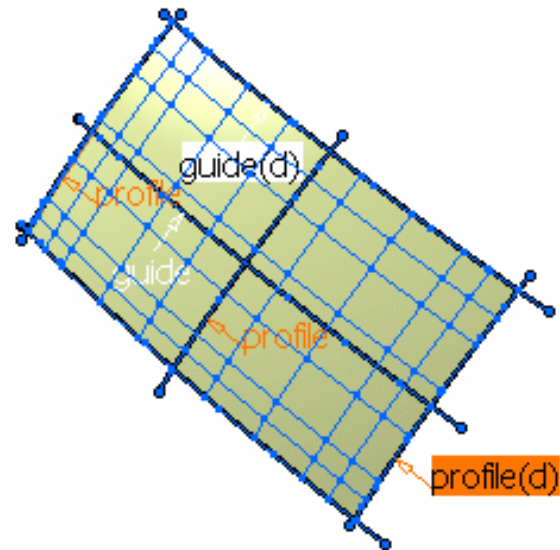

With option highlighted

i The selected curve must be isoparametric.

6. Click the **Display>>** text to display the maximum information.

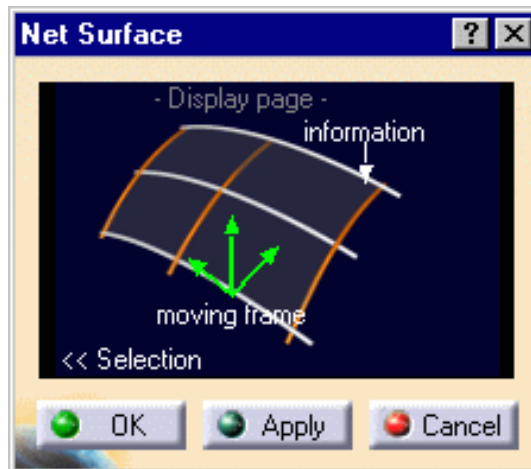

i The information option enables you to display or not the tags.

7. Activate the moving frame.
frame.

The moving frame is used to define how the profile's position along the guiding curve.

In the geometry, you can click the moving frame to change its type, press and hold Shift while clicking to move back, or right-click to display the contextual menu. Four types of moving frames are available:

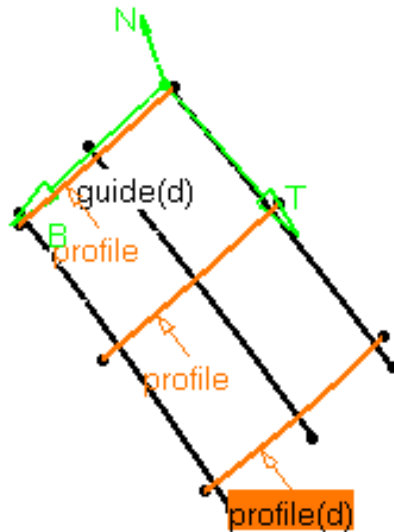

- Perpendicular to the dominant guiding curve

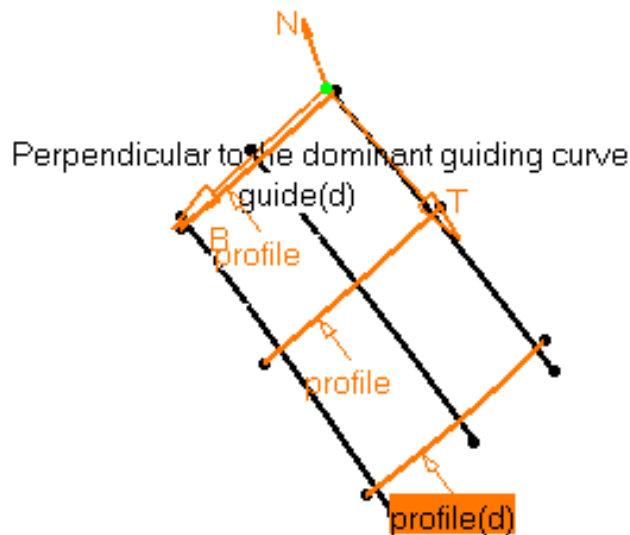

- Pseudo-Perpendicular to the dominant guiding curve

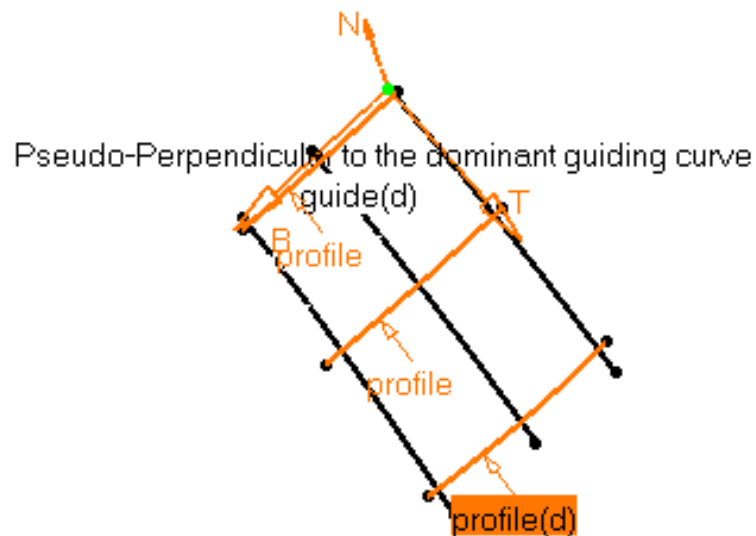

- Two guiding curves and perpendicular to the dominant guiding curve

Two guiding curves and perpendicular to the dominant guiding curve

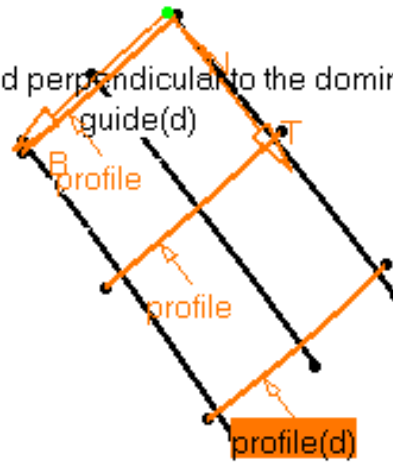

- Two guiding curves and pseudo-perpendicular to the dominant guiding curve

Two guiding curves and pseudo-perpendicular to the dominant guiding curve

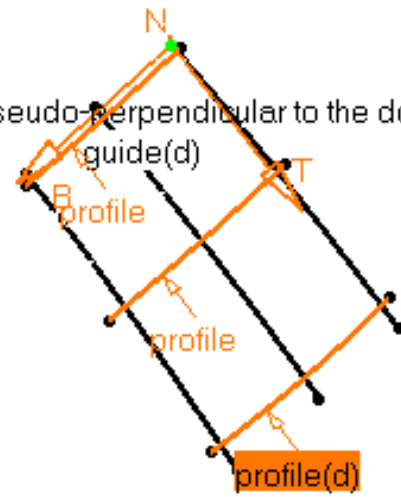

- Parallel to plane

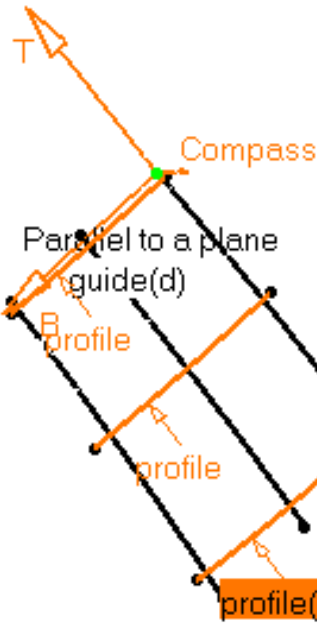

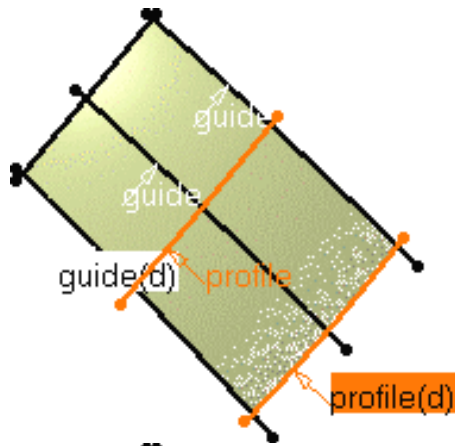

8. Click **Apply** to create the surface.
If you are not satisfied with the results, you can click another guide or curve to modify the surface.

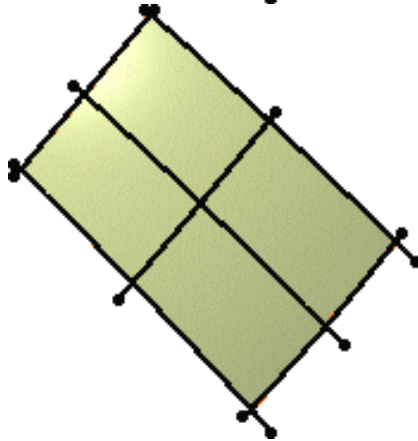

9. Click OK to confirm the net surface creation.



 You can create a net surface by selecting two or more profiles and no guide or two or more guides and no profile.

In case the selected guide or profile lies on more than one support, the  appears.

Please refer to [Selecting a Support](#) for further information.

 Available capabilities from the dashboard are: [datum creation](#), [temporary analysis](#), [continuities](#), and [furtive display](#).





Creating a Styling Sweep

P2

 This command is only available with the FreeStyle Profiler.

 This task explains how to create a swept surface, based on a profile swept along a spine.

 Open the [StylingSweep1.CATPart](#) document.

 1. Click the Sweep icon .

The Styling Sweep dialog box is displayed.

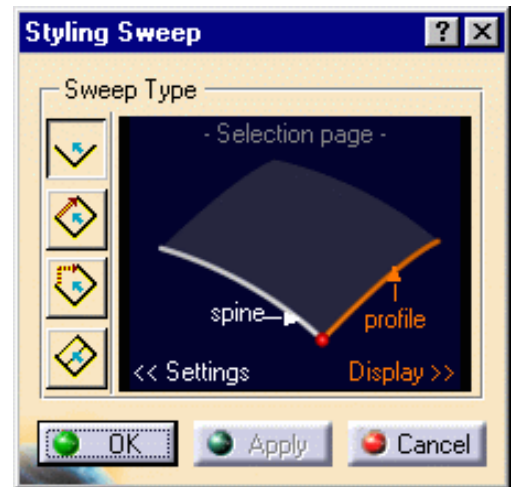

2. Choose the sweep type by clicking on the icons on the left.

Four types are available:

1. **Simple:** creates a surface based on two curves (profile and spine).

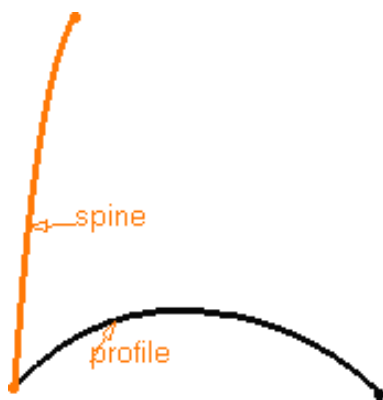

Example of Simple Sweep

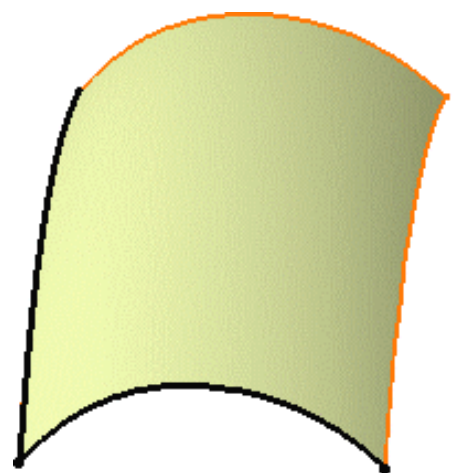

Resulting Sweep

2. Sweep &

snap: creates a surface based on three curves (profile, spine and guide). The swept surface is relimited onto the guiding curve. There is no deformation of the swept profile according to the guiding curve.

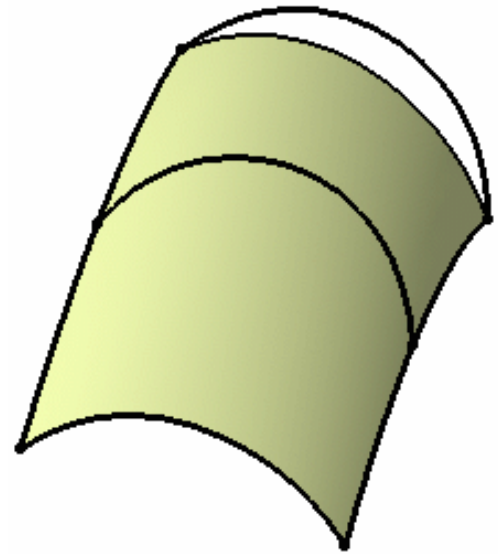

If the profile is extrapolated half its length, and is no longer in contact with the guide, then the calculation of the sweep stops.

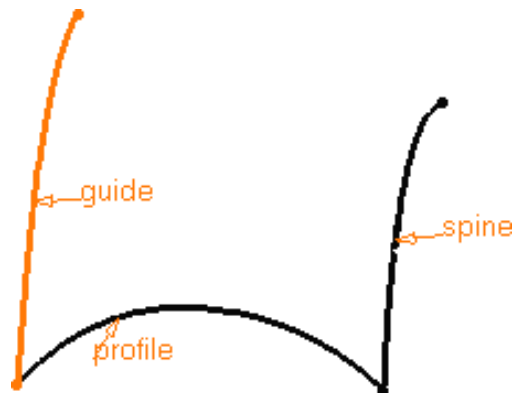

3. Sweep & fit:

creates a surface based on three curves (profile, spine and guide). The swept profile is deformed onto the guiding curve. There is no relimitation of the swept surface onto the guiding curve.

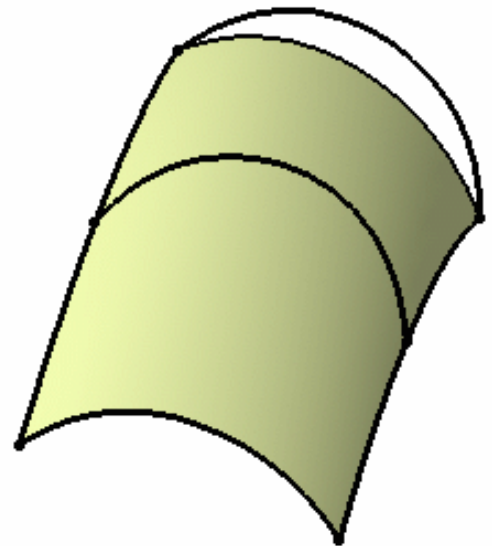

4. **Sweep near profiles:** creates a surface based on at least four curves (profile, spine, guide, and one or more reference profiles). The swept profile is deformed onto the guiding curve. Moreover, tangency conditions are taken into account at the contact points between the reference profile(s) and spine and guiding curve.

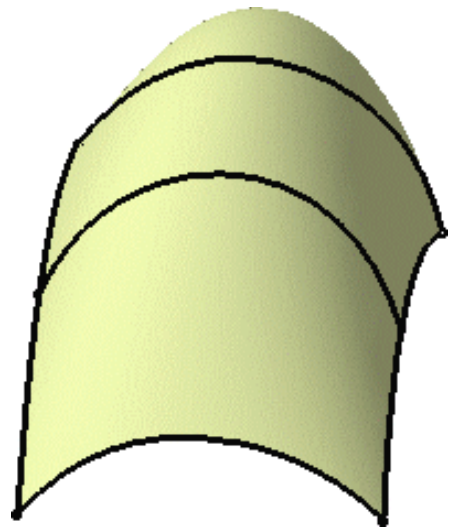

3. Click the <<**Settings** text in the dialog box to view and select the settings:

You can define the following parameters that will affect the quality of the resulting swept surface:

- the maximum V order allowed for the resulting swept surface, ranging between two and sixteen, the U order being defined by the profile curve's order. This value is the maximum allowed, but not necessarily the resulting surface's order if the system finds a better solution.
- the maximum deviation between the exact surface and the resulting surface, in order to decrease the number of control points and segments on the resulting swept surface.

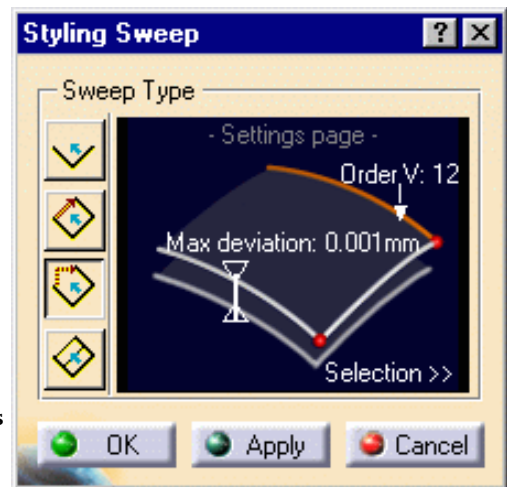

Click the values in the dialog box to edit them.

Be careful not to over-constrain the surface by setting low values for both deviation and V order. This would result in an increase of segments for the generated swept surface.

4. Click **Selection**>> then **Display** in the dialog box to view and select the display parameters: limits points, moving frame, and information.

When the texts are displayed in white, the corresponding parameter is visible in the 3D geometry.

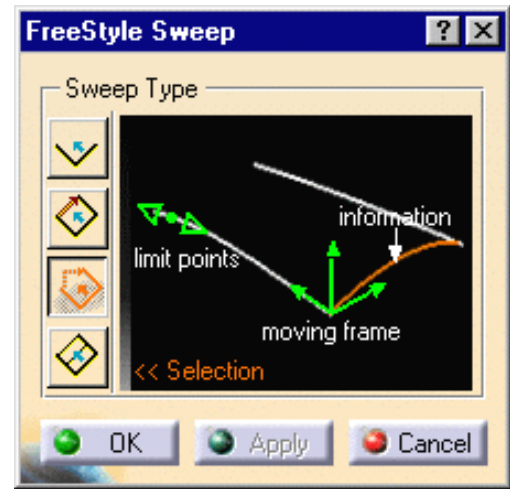

5. Activate the moving frame.

The moving frame is used to define how the profile is swept along the spine.

In the geometry, you can click the moving frame to change its type, press and hold Shift while clicking to move back, or right-click to display the contextual menu.

Four types of moving frames are available:

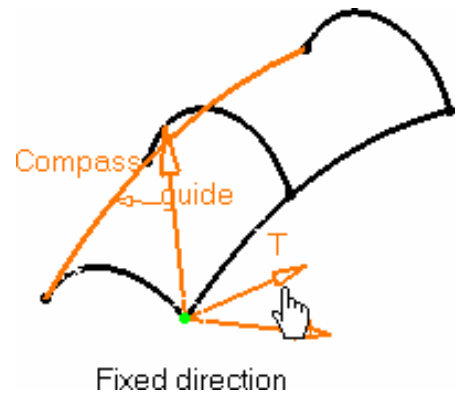

1. **Translation:** the profile is translated along the spine

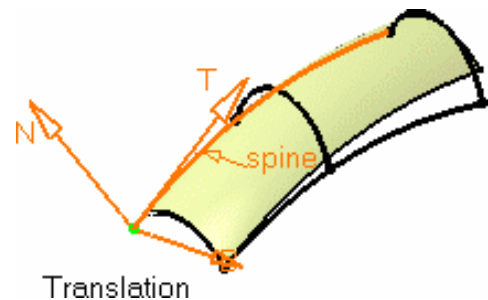

2. **On contour:** the profile translation is recomputed at every point of the spine, meaning the profile follows the spine contour.

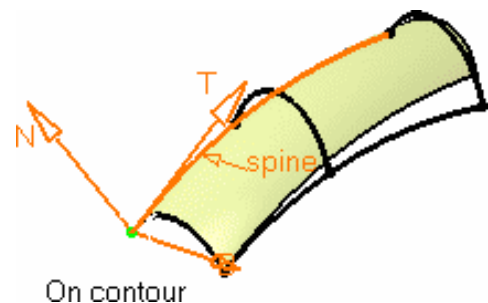

3. **Fixed direction:** the profile is translated according to the compass orientation.

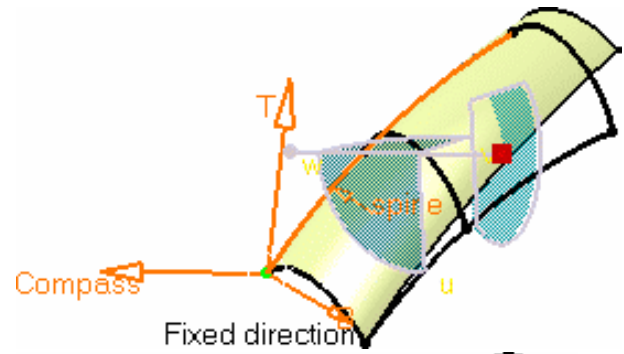

4. **Tangent to contour:** the profile translated according to the compass orientation, while constantly remaining tangent to the spine. In the moving frame representation:

- T is the tangent to the spine at the current point
- B is the vectorial product between T and the compass direction
- N is the vectorial product between T and B.

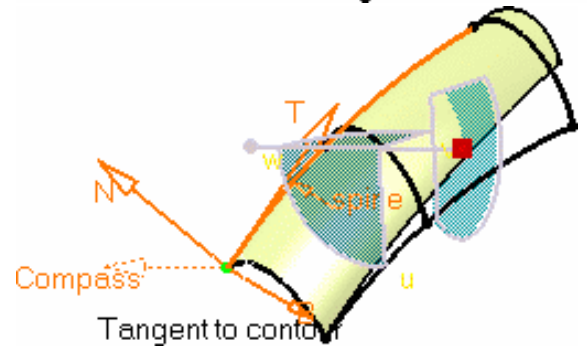

In the last two cases, you need to drag and drop the compass onto the geometry, or use the quick compass orientation capability, to set the direction according to the [compass orientation](#) definition.

The current type is displayed when passing the pointer over the moving frame. You can move the frame along the spine using the manipulator at the moving frame's origin.

i The moving frame is not available with the sweep near profile.

6. Activate the limit points.

They allow you to redefine the surface limits on the spine/guide. These points show up only when the surface extends beyond the reference profile, when selected, and are limited by the spine or guide's length.

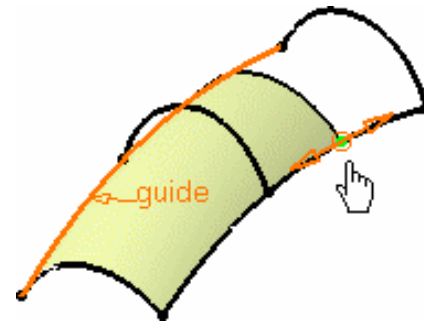

P2 Capabilities are available from the [contextual menu](#) when right-clicking a limit point.

i The Information option displays the role of the selected elements in the geometry: profile, spine, and guide.

7. Click OK to create the styling sweep.



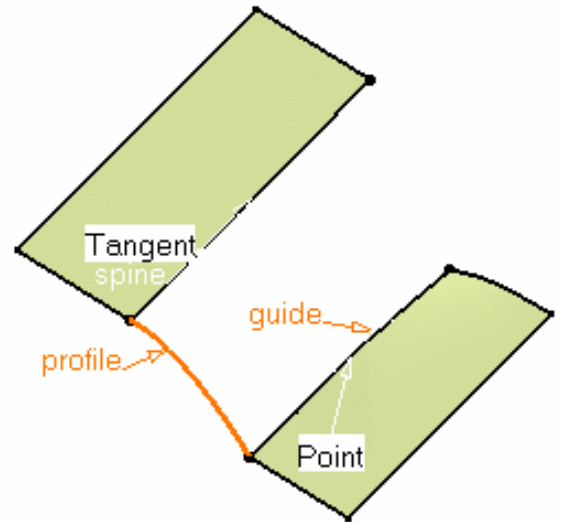

- You can select surface edges as the spine and guide. In that case, provided the **Continuity** icon  is active from the dashboard, you can set the type of continuity to be taken into account (point, tangency, or curvature continuity) using the contextual menu on the displayed information.

Note that all continuities are not always available, depending on the chosen sweep type, and the geometry itself.

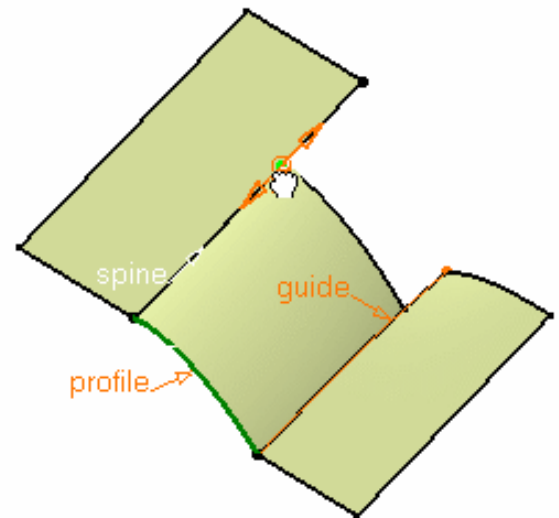

- Similarly, you can use the **Contact Points** icon  to display the manipulator on the surface and modify its limits.



In case the selected guide or profile lies on more than one support, the  appears.

Please refer to [Selecting a Support](#) for further information.



Styling sweeps cannot be created using canonical profiles.



Available capabilities from the dashboard are: [datum creation](#), [temporary analysis](#), [auto detection](#), [attenuation](#), [continuity](#), [contact points](#), and [furtive display](#).



Interoperability with the Part Design Workbench

You can work in the FreeStyle Shaper/FreeStyle Optimizer workbench only, creating forms and modifying them. However in an industrial environment, it is always useful to have integrated design tools at one's disposal. The integration between the FreeStyle Shaper workbench and the Part Design workbench is described in the chapter, based on a step-by-step scenario composed of several tasks illustrating how to work with both surface and body type elements, that is elements created using the Part Design workbench.

Creating a Sketch and a Pad
Creating a Surface
Splitting the Pad
Modifying the Splitting Surface



This scenario is accomplished in ten minutes.

The resulting body will look like this:

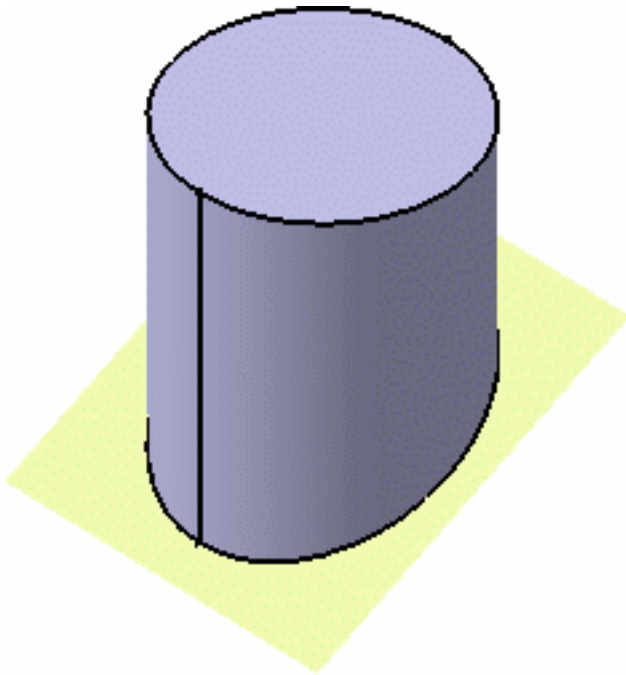

Creating a Sketch and a Pad



This task explains how to create a pad from a sketch in the Part Design Workbench.



Open a new .CATPart document (see [Opening a new CATPart Document](#)) and activate the Part Design Workbench.



1. Click the **Sketcher** icon .

2. Select **xy plane** to define the sketch plane.



3. Click the **Circle** icon .

4. Click where you wish the center of the circle to appear.

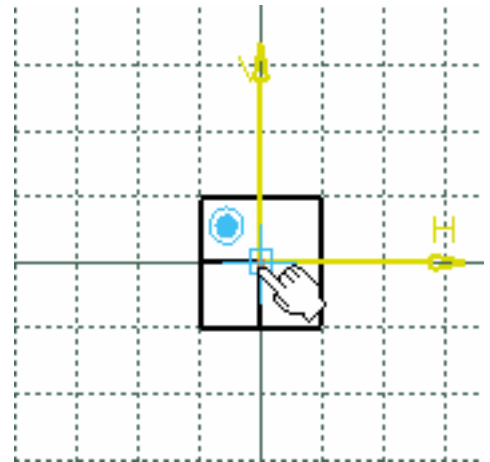

5. Drag the pointer to see the circle being created.

A rubberbanding circle follows the pointer as you drag it.

6. Click once you are satisfied with the size of the circle.

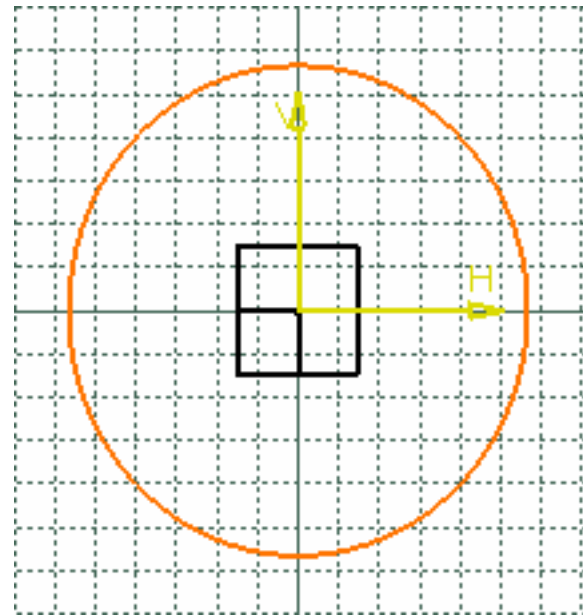

7. Click the **Exit Sketcher** icon  then the **Pad** icon



A default cylindrical pad is previewed.

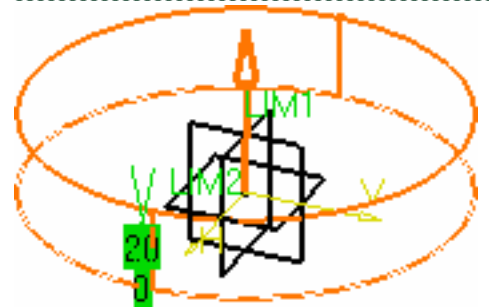

8. Key in 150 in the power input entry area, and click **OK** to create the pad.

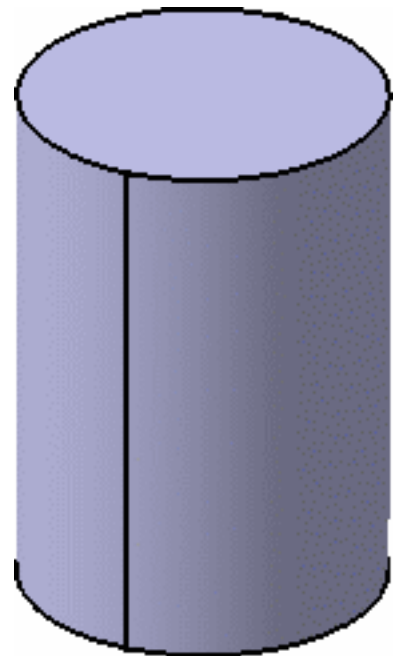

A cylindrical pad has been created using the Part Design workshop.



Creating a Surface

 This task will show you how to enter the FreeStyle Shaper workbench.



1. From the View toolbar, select the **Top View** icon  to see the cylinder from the top.
2. Now, choose **FreeStyle** from the **Start -> Shape** menu.

The FreeStyle Shaper workbench is displayed.

3. Select the **Planar patch** icon .

4. Click at the center of the cylinder (where you clicked to create the circle sketch) press the Ctrl-key and drag the pointer so as to cover the cylinder face by the outline.

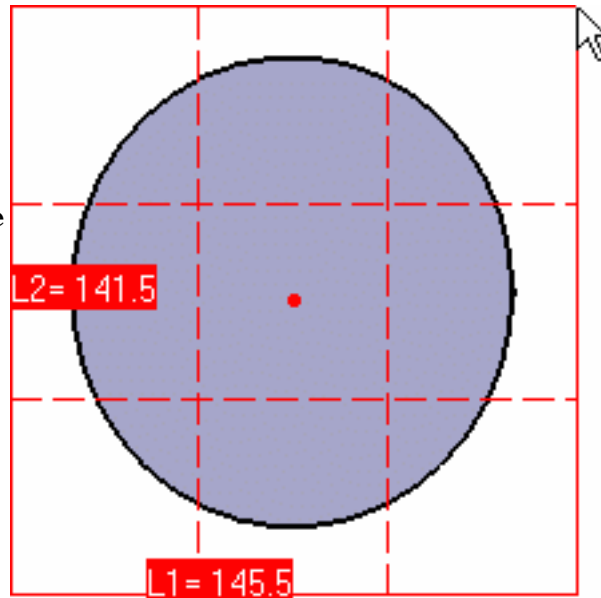



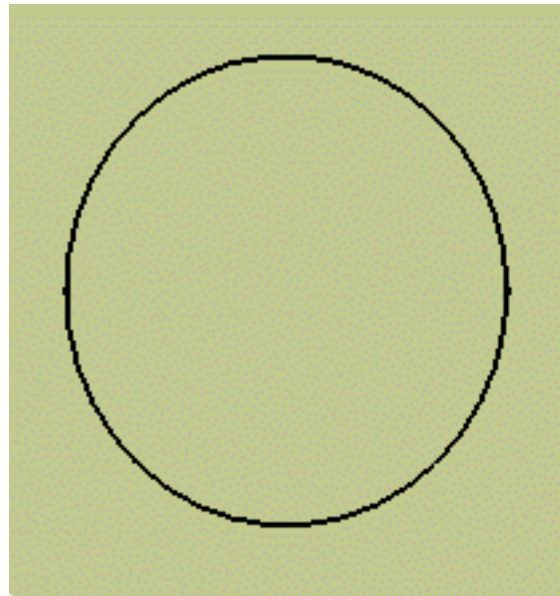

5. When you have reached the adequate size, click again.

The corresponding surface has been created in a plane parallel to that defined by the 3D compass.

See [Creating Planar Patches](#) for further details on the 3D compass capabilities and on creating planar surfaces.



6. Click the Isometric view icon .
7. In P2 mode, drag and drop the compass onto the surface and drag the surface halfway of the cylinder length pulling on the z axis.
8. Reset the compass by clicking the **Quick Compass Orientation**  then the **In Model or On Perch**  icons in the **Current plane orientation** toolbar.
9. In P1 mode, click the **Control Points** icon , click the **Move selected points identically** option, and pull the manipulator to drag the surface halfway of the cylinder length.
10. Click OK in the Control Points dialog box.

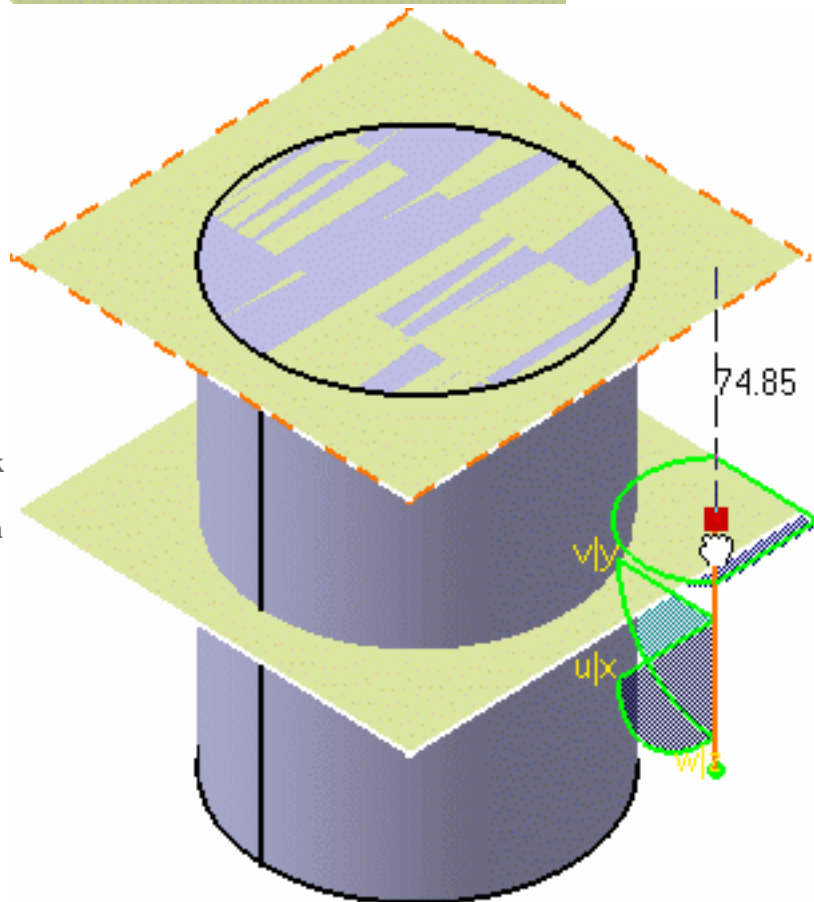

The body now looks like this:

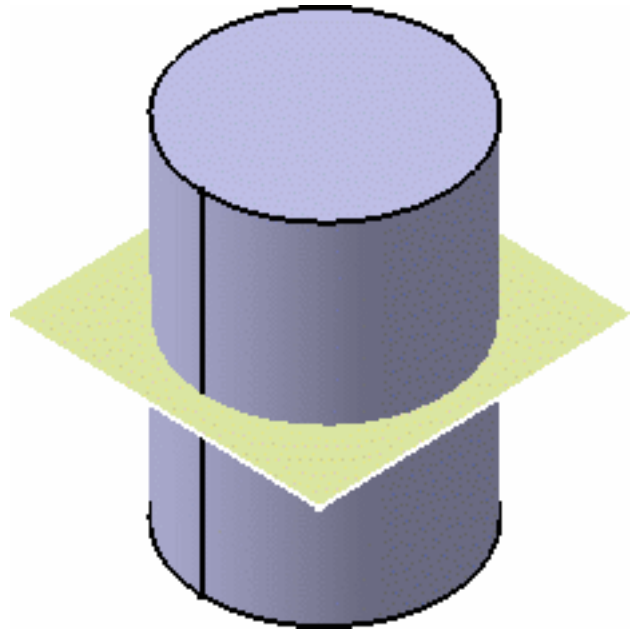

Splitting the Pad

 This task will show you how to split the cylinder by the surface.

 **1.** Now, choose **Part Design** from the **Start -> Mechanical Design** menu. The Part Design workbench is displayed again.

2. Select the cylinder and click the **Split**  icon.

3. Select the created surface as the splitting plane.

An arrow appears indicating the portion of body that will be kept, make sure that it points in the right direction.

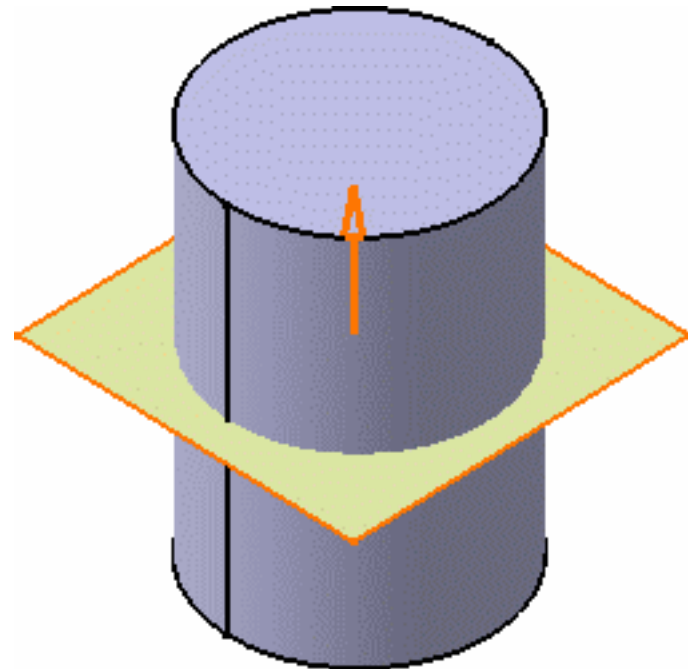

4. Click **OK** in the Split Definition dialog box.

The cylinder has been split by the surface.

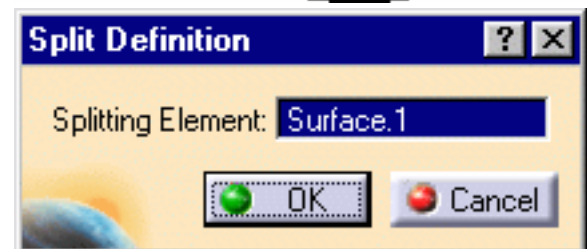

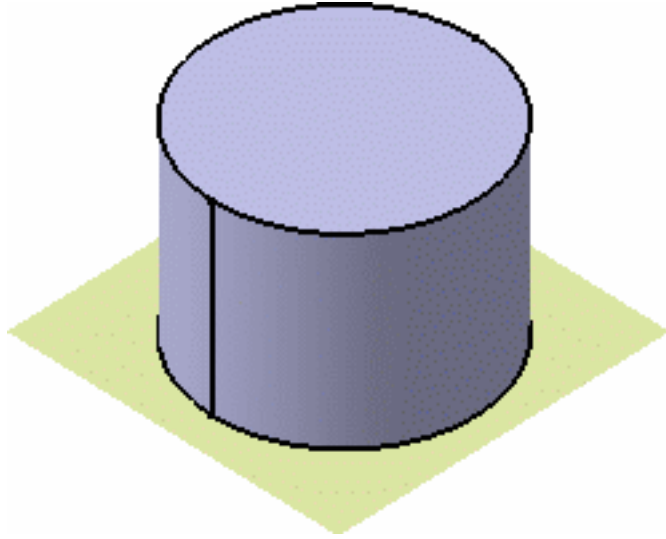

Modifying the Splitting Surface



This task will show you how to modify the splitting surface.



1. Return to the FreeStyle Shaper workbench.

2. Set the current plane to **Flip to VW or YZ**  using the **Current Plane Orientation** or **Quick Compass Orientation** toolbar, depending on the mode you are working in.

3. Select the surface and click the **Control points** icon



Control points and mesh lines are displayed along with the Control Points dialog box.

4. From the dialog box, choose the **Stretch selected points** .

Note that the **Translation in the plane**  icon is the current support.

5. Move the pointer over an edge mesh line and pull down so as to manually deform the surface.

The cylinder is automatically updated.

If needed, refer to [Editing Surfaces Using Control Points](#) for further details on surface modification.

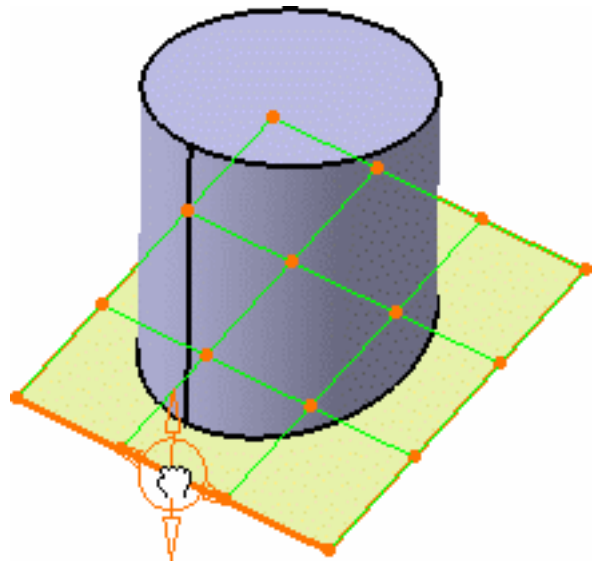
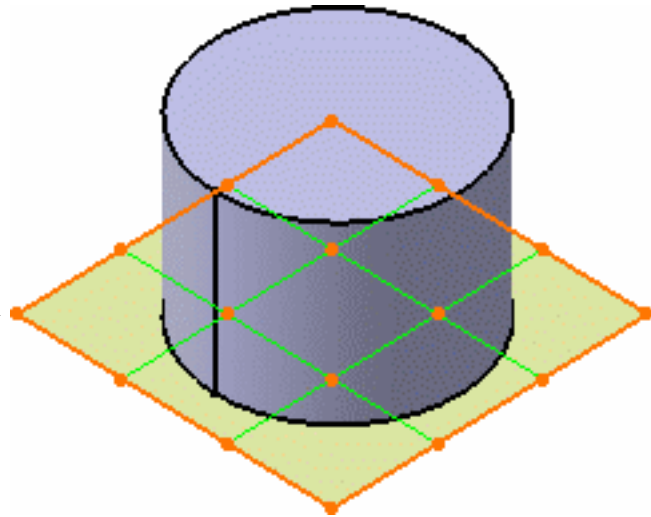

6. Click **OK** in the Control Points dialog box to validate both surface and cylinder deformation.

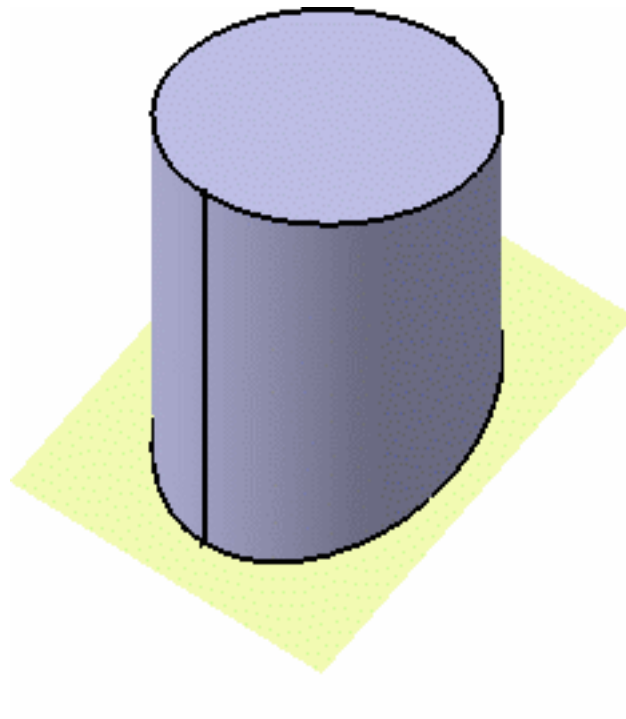

Interoperability with the Wireframe Workbench

You can work in the FreeStyle Shaper/FreeStyle Optimizer workbench only, creating forms and modifying them. However in an industrial environment, it is always useful to have integrated design tools at one's disposal. The integration between the FreeStyle Shaper workbench and the Wireframe workbench is described in the chapter, based on four tasks illustrating how to create wireframe geometry using the Wireframe workbench.

[Creating Points](#)

[Creating Lines](#)

[Creating Planes](#)

[Creating Circles](#)

When using these commands, elements are created with their history. If you need to deactivate the history, refer to [Creating Datums](#).

Creating Points

This task shows the various methods for creating points:

- [by coordinates](#)
- [on a curve](#)
- [on a plane](#)
- [on a surface](#)
- [at a circle center](#)
- [tangent point on a curve](#)
- [between](#)

Open the [Points3D-1.CATPart](#) document.

1. Click the **Point** icon .

The Point Definition dialog box appears.

2. Use the combo to choose the desired point type.

Coordinates

- Enter the X, Y, Z coordinates in the current axis-system.
- Optionally, select a reference point.

The corresponding point is displayed.

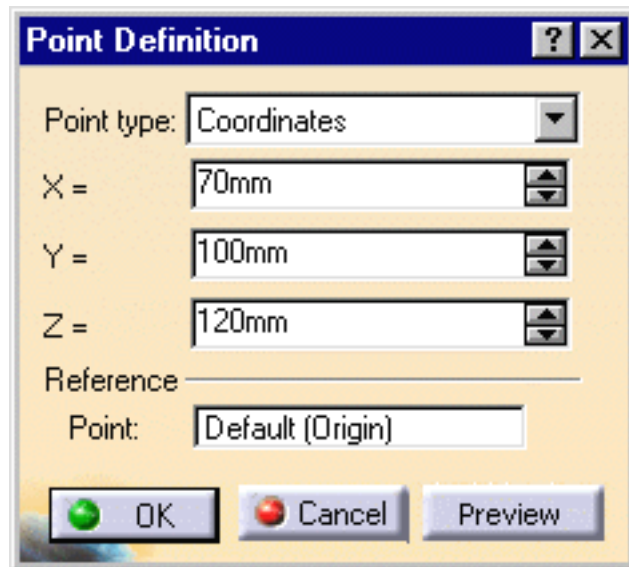

When creating a point within a user-defined axis-system, note that the **Coordinates in absolute axis-system** check button is added to the dialog box, allowing you to be define, or simply find out, the point's coordinates within the document's default axis-system.

If you create a point using the coordinates method and an axis system is already defined and set as current, the point's coordinates are defined according to current the axis system. As a consequence, the point's coordinates are not displayed in the specification tree.

The axis system must be different from the absolute axis.

On curve

- Select a curve
- Optionally, select a reference point.

If this point is not on the curve, it is projected onto the curve.
If no point is selected, the curve's extremity is used as reference.

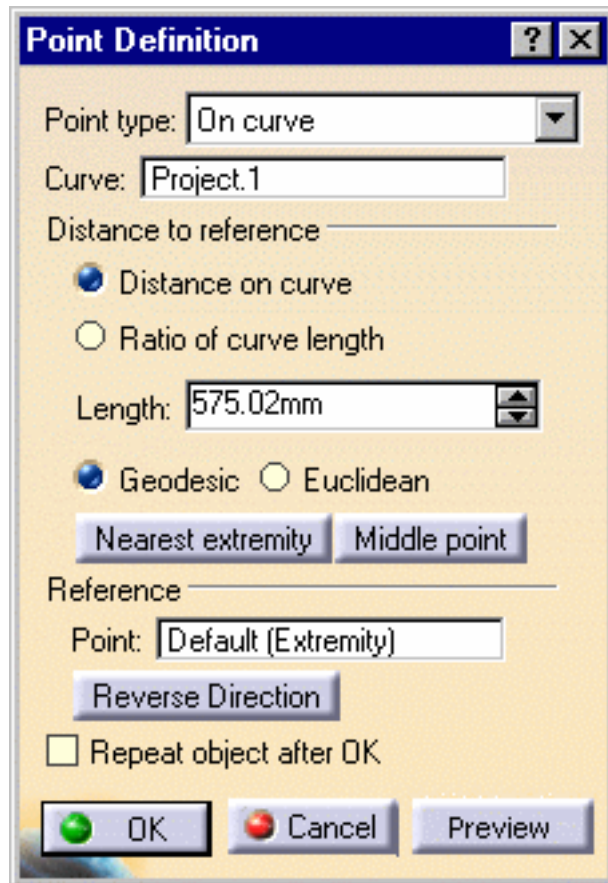

- Select an option point to determine whether the new point is to be created:
 - at a given distance along the curve from the reference point
 - a given ratio between the reference point and the curve's extremity.
- Enter the distance or ratio value.
If a distance is specified, it can be:
 - a geodesic distance: the distance is measured along the curve
 - an Euclidean distance: the distance is measured in relation to the reference point (absolute value).

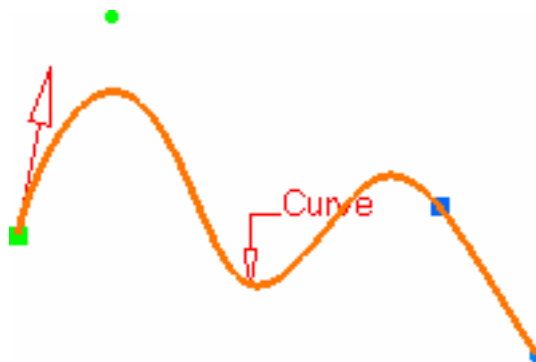
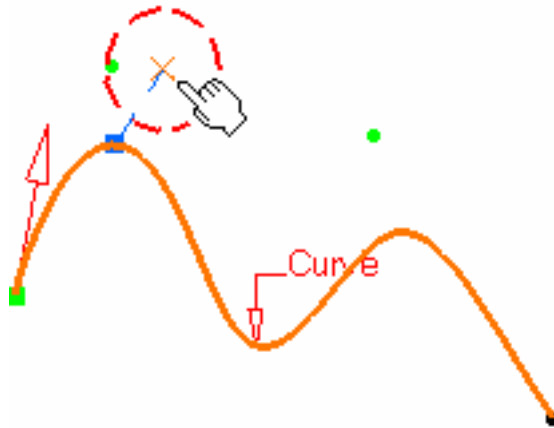

The corresponding point is displayed.



If the reference point is located at the curve's extremity, even if a ratio value is defined, the created point is always located at the end point of the curve.

You can also:

- click the **Nearest extremity** button to display the point at the nearest extremity of the curve.
- click the **Middle Point** button to display the mid-point of the curve.



Be careful that the arrow is orientated towards the inside of the curve (providing the curve is not closed) when using the **Middle Point** option.

- use the **Reverse Direction** button to display:
 - the point on the other side of the reference point (if a point was selected originally)
 - the point from the other extremity (if no point was selected originally).
- click the **Repeat object after OK** if you wish to create equidistant points on the curve, using the currently created point as the reference, as described in Creating Multiple Points in the Wireframe and Surface User's Guide.

You will also be able to create planes normal to the curve at these points, by checking the **Create normal planes also** button, and to create all instances in a new geometrical set by checking the **Create in a new geometrical set** button.

If the button is not checked the instances are created in the current geometrical set .



- If the curve is infinite and no reference point is explicitly given, by default, the reference point is the projection of the model's origin
- If the curve is a closed curve, either the system detects a vertex on the curve that can be used as a reference point, or it creates an extremum point, and highlights it (you can then select another one if you wish) or the system prompts you to manually select a reference point.

Extremum points created on a closed curve are now aggregated under their parent command and put in no show in the specification tree.

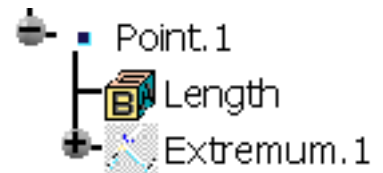
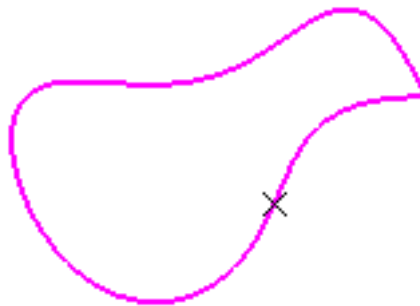

On plane

- Select a plane.
- Optionally, select a point to define a reference for computing coordinates in the plane.

If no point is selected, the projection of the model's origin on the plane is taken as reference.

- Optionally, select a surface on which the point is projected normally to the plane.

If no surface is selected, the behavior is the same.

Furthermore, the reference direction (H and V vectors) is computed as follows:

With N the normal to the selected plane (reference plane), H results from the vectorial product of Z and N ($H = Z \wedge N$).

If the norm of H is strictly positive then V results from the vectorial product of N and H ($V = N \wedge H$). Otherwise, $V = N \wedge X$ and $H = V \wedge N$.

Would the plane move, during an update for example, the reference direction would then be projected on the plane.

- Click in the plane to display a point.

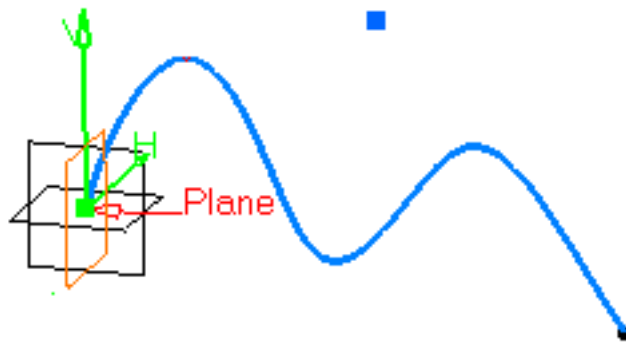
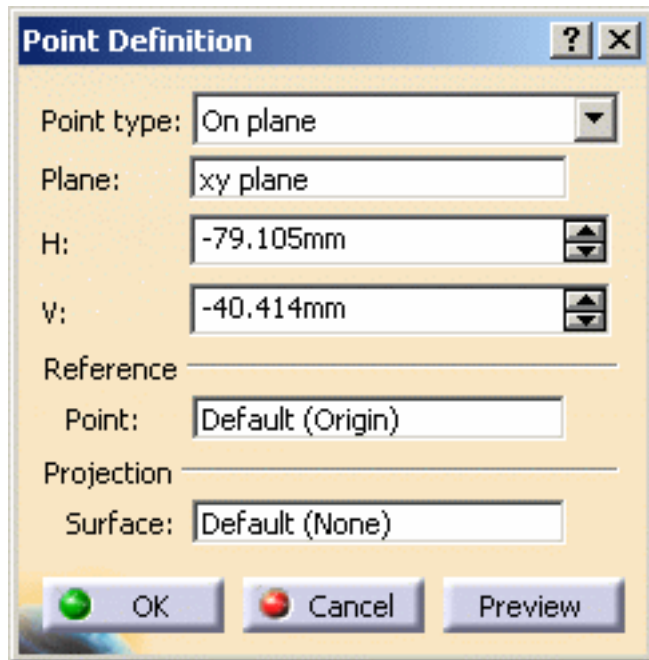

On surface

- Select the surface where the point is to be created.

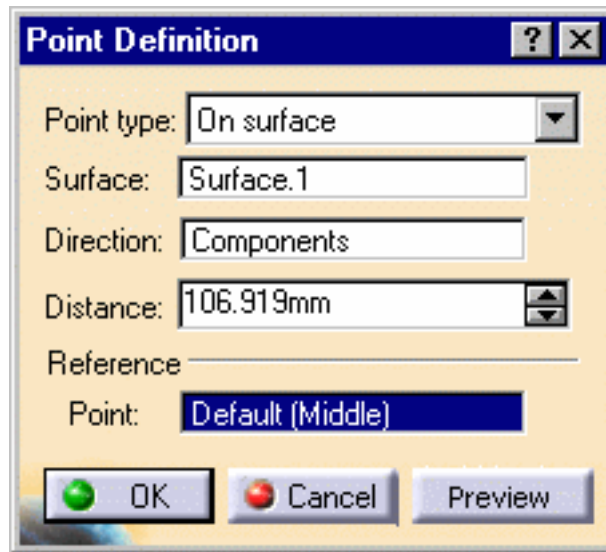

- Optionally, select a reference point. By default, the surface's middle point is taken as reference.
- You can select an element to take its orientation as reference direction or a plane to take its normal as reference direction. You can also use the contextual menu to specify the X, Y, Z components of the reference direction.
- Enter a distance along the reference direction to display a point.

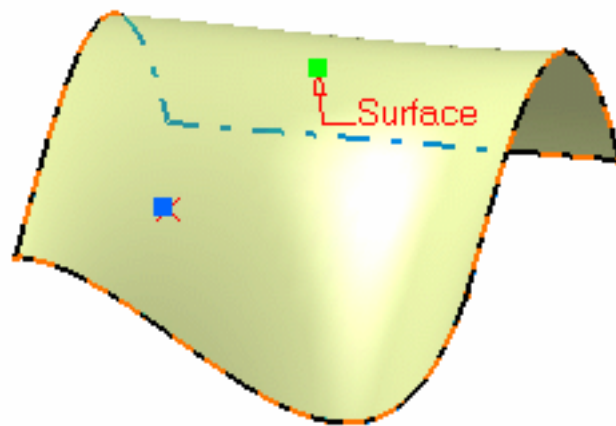

Circle center

- Select a circle, circular arc, or ellipse.

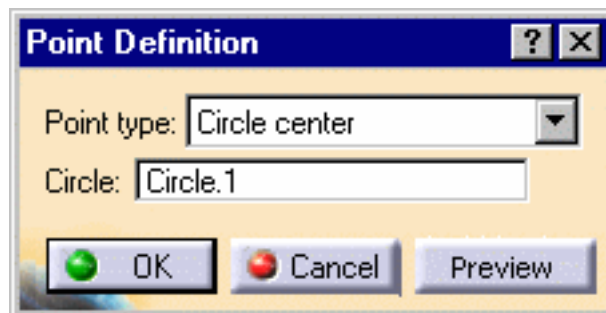

A point is displayed at the center of the selected element.

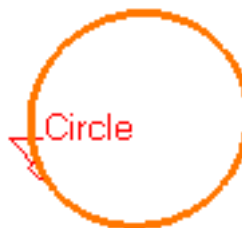

Tangent on curve

- Select a planar curve and a direction line.

A point is displayed at each tangent.

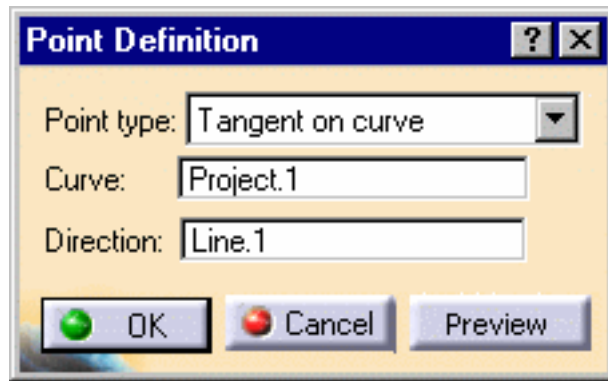

The Multi-Result Management dialog box is displayed because several points are generated.

- Click **YES**: you can then select a reference element, to which only the closest point is created.
- Click **NO**: all the points are created.

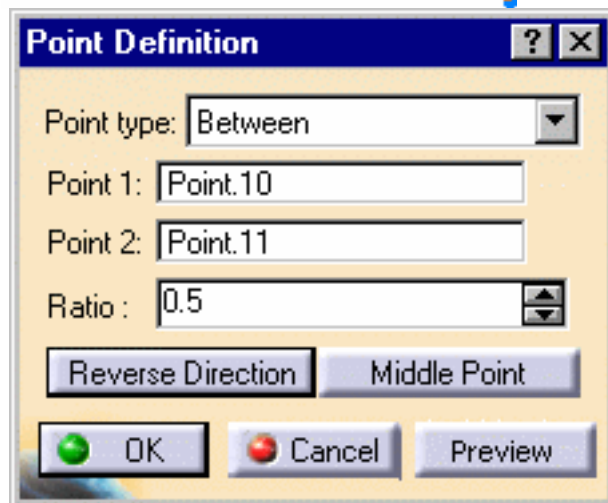
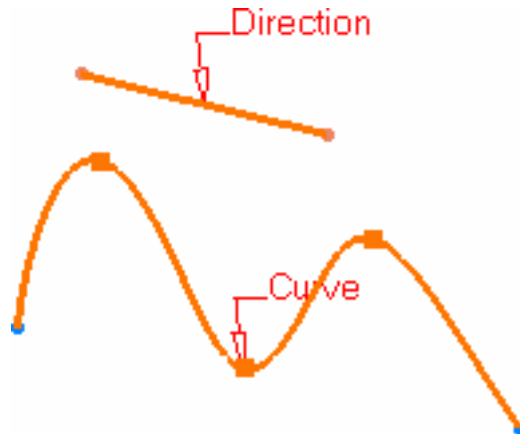

Between

- Select any two points.

- Enter the ratio, that is the percentage of the distance from the first selected point, at which the new point is to be. You can also click **Middle Point** button to create a point at the exact midpoint (ratio = 0.5).



Be careful that the arrow is orientated towards the inside of the curve (providing the curve is not closed) when using the **Middle Point** option.

- Use the **Reverse direction** button to measure the ratio from the second selected point.





If the ratio value is greater than 1, the point is located on the virtual line beyond the selected points.

3. Click OK to create the point.

The point (identified as Point.xxx) is added to the specification tree.



Creating Lines



This task shows the various methods for creating lines:

- point to point
- point and direction
- angle or normal to curve
- tangent to curve
- normal to surface
- bisecting

It also shows you how to **automatically reselect the second point**.



Open the **Lines1.CATPart** document.



1. Click the **Line** icon .

The Line Definition dialog box appears.

2. Use the drop-down list to choose the desired line type.



A line type will be proposed automatically in some cases depending on your first element selection.

Point - Point



This command is only available with the Generative Shape Design 2 product.

- Select two points.

A line is displayed between the two points.
Proposed **Start** and **End** points of the new line are shown.

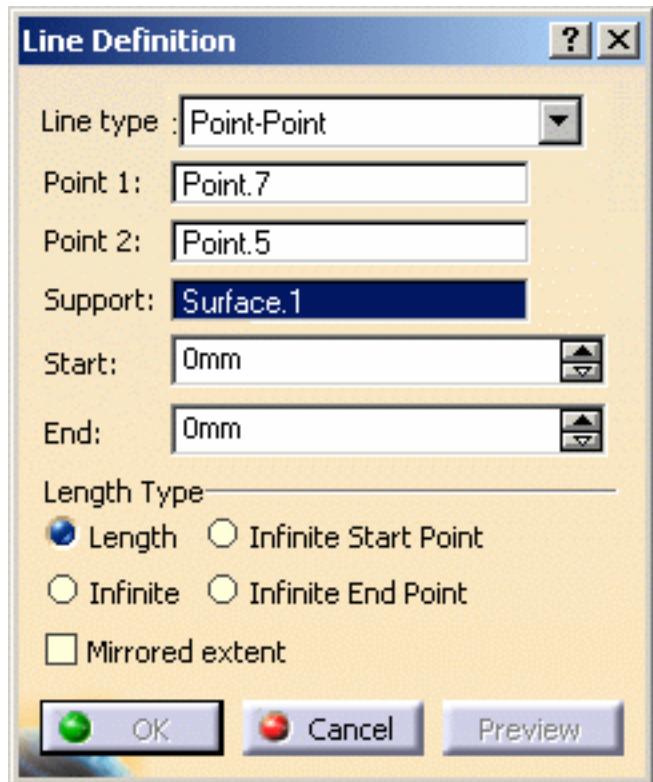

- If needed, select a support surface.
In this case a geodesic line is created, i.e. going from one point to the other according to the shortest distance along the surface geometry (blue line in the illustration below).
If no surface is selected, the line is created between the two points based on the shortest distance.

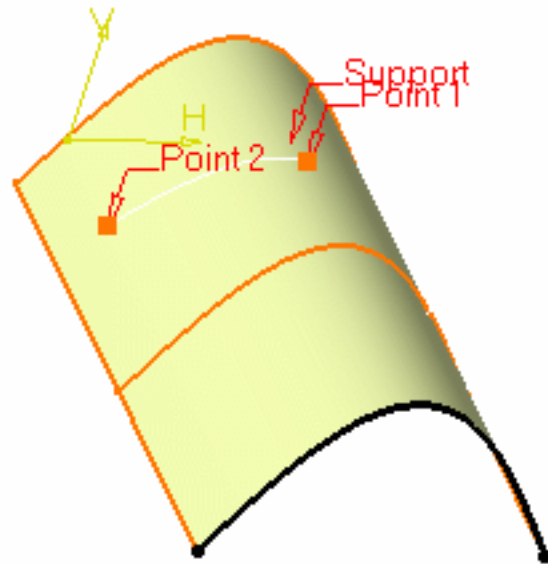

 If you select two points on closed surface (a cylinder for example), the result may be unstable. Therefore, it is advised to split the surface and only keep the part on which the geodesic line will lie.

 The geodesic line is not available with the Wireframe and Surface workbench.

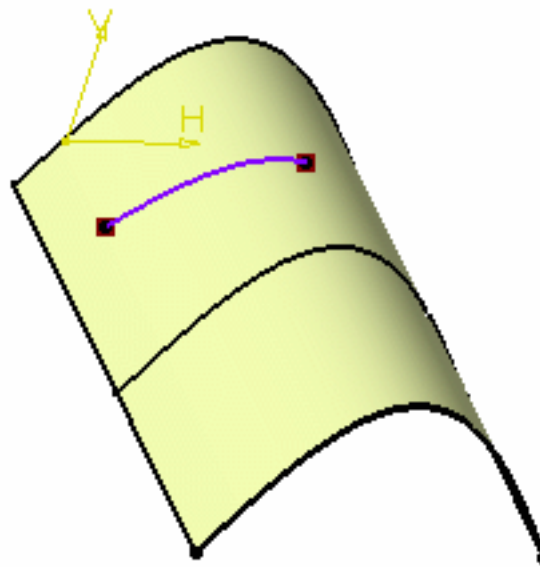

- Specify the **Start** and **End** points of the new line, that is the line endpoint location in relation to the points initially selected. These **Start** and **End** points are necessarily beyond the selected points, meaning the line cannot be shorter than the distance between the initial points.
- Check the **Mirrored extent** option to create a line symmetrically in relation to the selected **Start** and **End** points.

 The projections of the 3D point(s) must already exist on the selected support.

Line Definition
? X

Line type : Point-Direction ▼

Point: Point.7

Direction: yz plane

Support: Default (None)

Start: -70mm ▲▼

End: 70mm ▲▼

Length Type _____

Length Infinite Start Point

Infinite Infinite End Point

Mirrored extent

Reverse Direction

OK
Cancel
Preview

Point - Direction

- Select a reference **Point** and a **Direction** line. A vector parallel to the direction line is displayed at the reference point. Proposed **Start** and **End** points of the new line are shown.

- Specify the **Start** and **End** points of the new line.
The corresponding line is displayed.

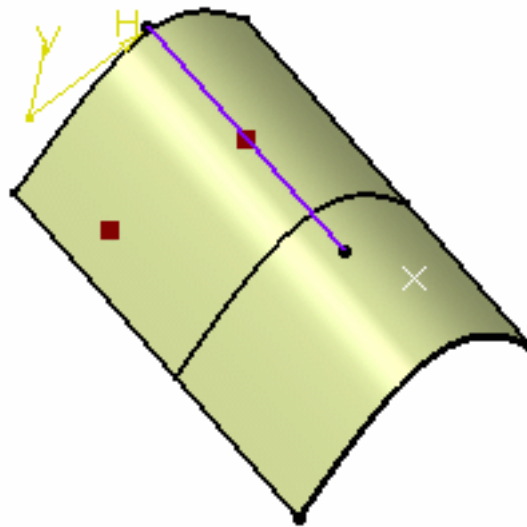

 The projections of the 3D point(s) must already exist on the selected support.

Angle or Normal to curve

- Select a reference **Curve** and a **Support** surface containing that curve.

- If the selected curve is planar, then the **Support** is set to Default (Plane).

- If an explicit **Support** has been defined, a contextual menu is available to clear the selection.

- Select a **Point** on the curve.
- Enter an **Angle** value.

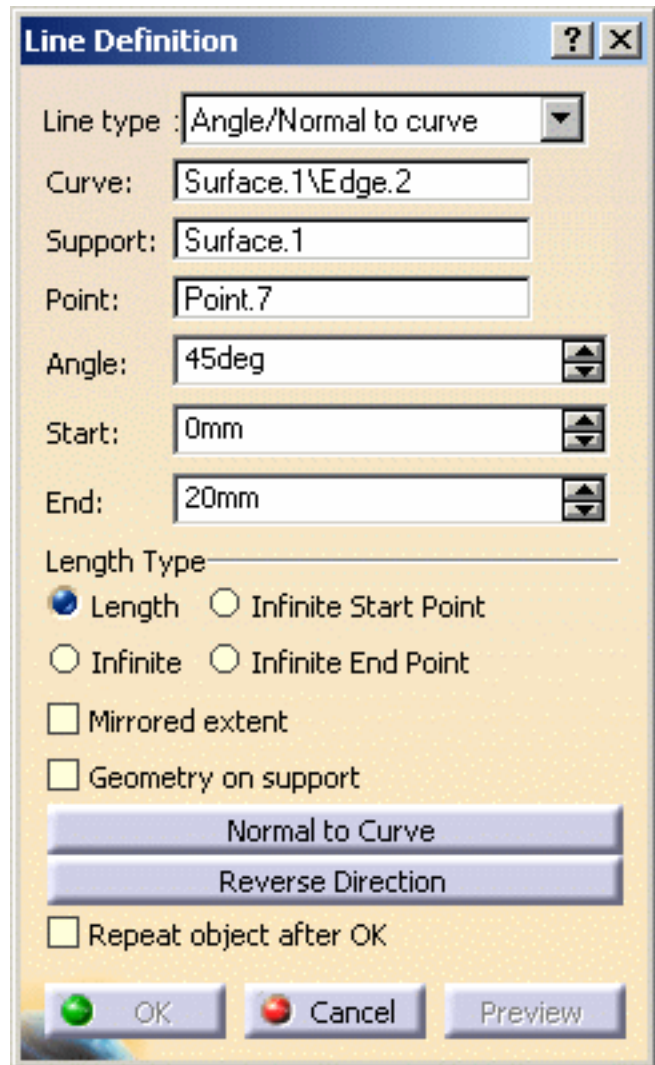

A line is displayed at the given angle with respect to the tangent to the reference curve at the selected point. These elements are displayed in the plane tangent to the surface at the selected point.

You can click on the **Normal to Curve** button to specify an angle of 90 degrees. Proposed **Start** and **End** points of the line are shown.

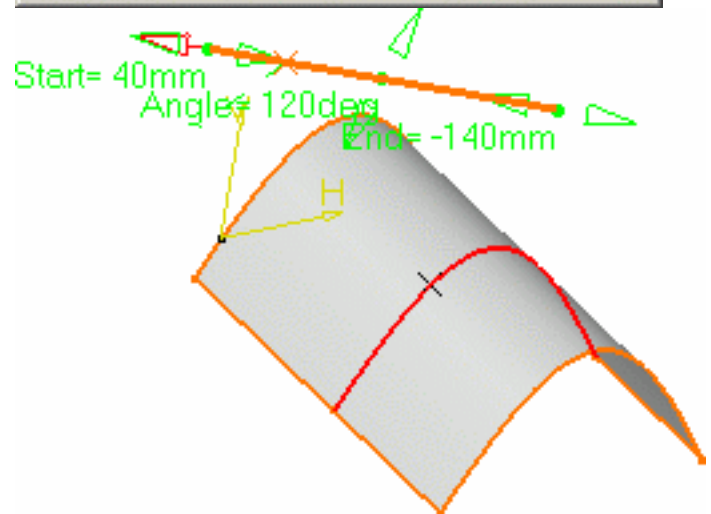

- Specify the **Start** and **End** points of the new line. The corresponding line is displayed.

- Click the **Repeat object after OK** if you wish to create more lines with the same definition as the currently created line.
In this case, the Object Repetition dialog box is displayed, and you key in the number of instances to be created before pressing OK.

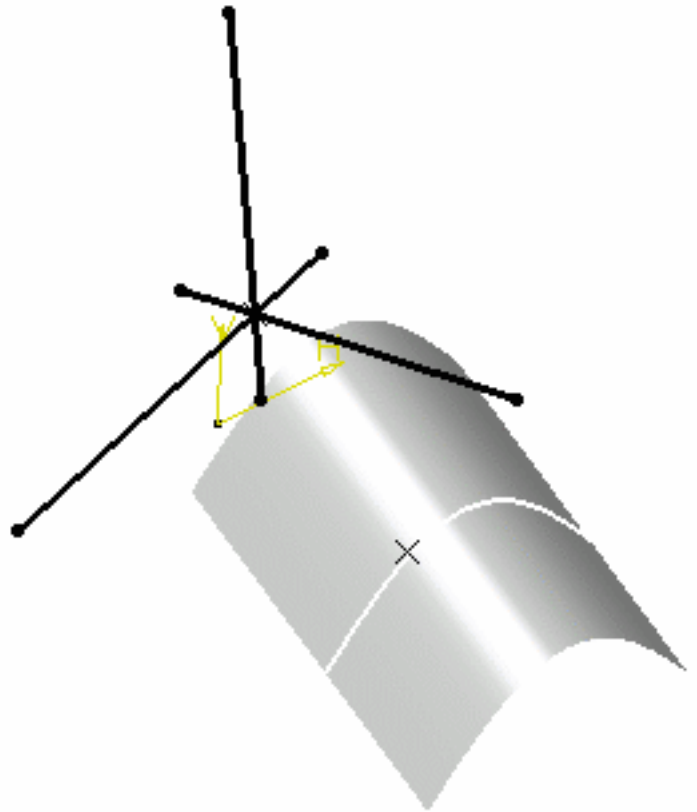
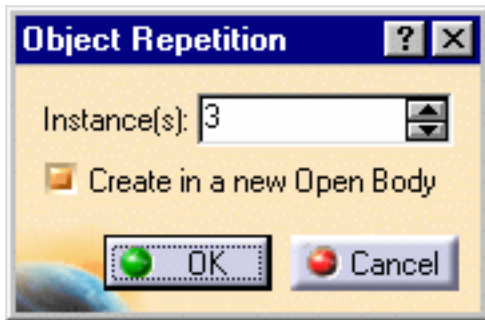

As many lines as indicated in the dialog box are created, each separated from the initial line by a multiple of the **angle** value.

You can select the **Geometry on Support** check box if you want to create a geodesic line onto a support surface.

The figure below illustrates this case.

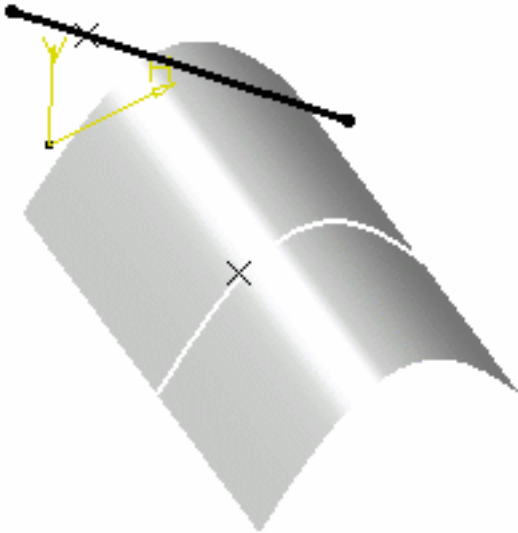

Geometry on support option not checked

This line type enables to edit the line's parameters. Refer to [Editing Parameters](#) to find out how to display these parameters in the 3D geometry.

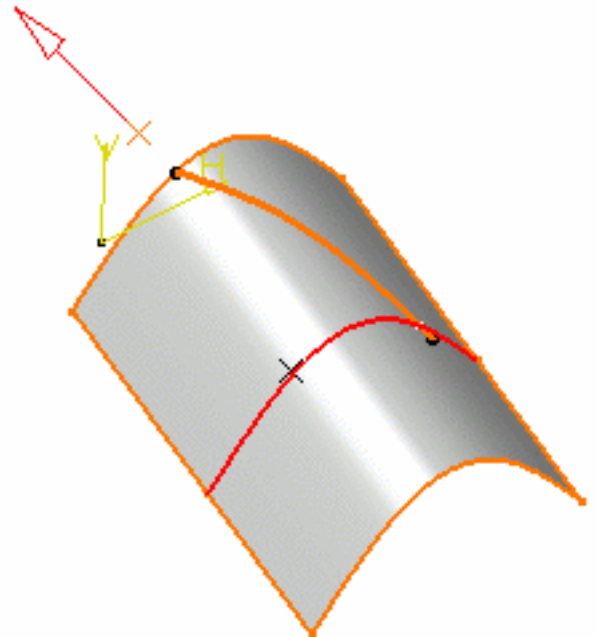

Geometry on support option checked

Tangent to curve

- Select a reference **Curve** and a **point** or another **Curve** to define the tangency.
 - if a point is selected (mono-tangent mode): a vector tangent to the curve is displayed at the selected point.
 - If a second curve is selected (or a point in bi-tangent mode), you need to select a support plane. The line will be tangent to both curves.

- If the selected curve is a line, then the **Support** is set to Default (Plane).

- If an explicit **Support** has been defined, a contextual menu is available to clear the selection.

When several solutions are possible, you can choose one (displayed in red) directly in the geometry, or using the **Next Solution** button.

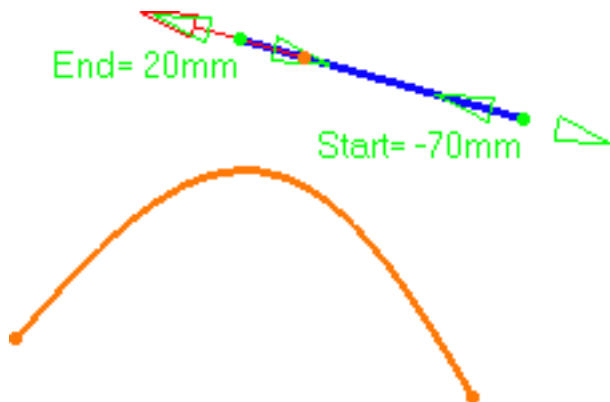
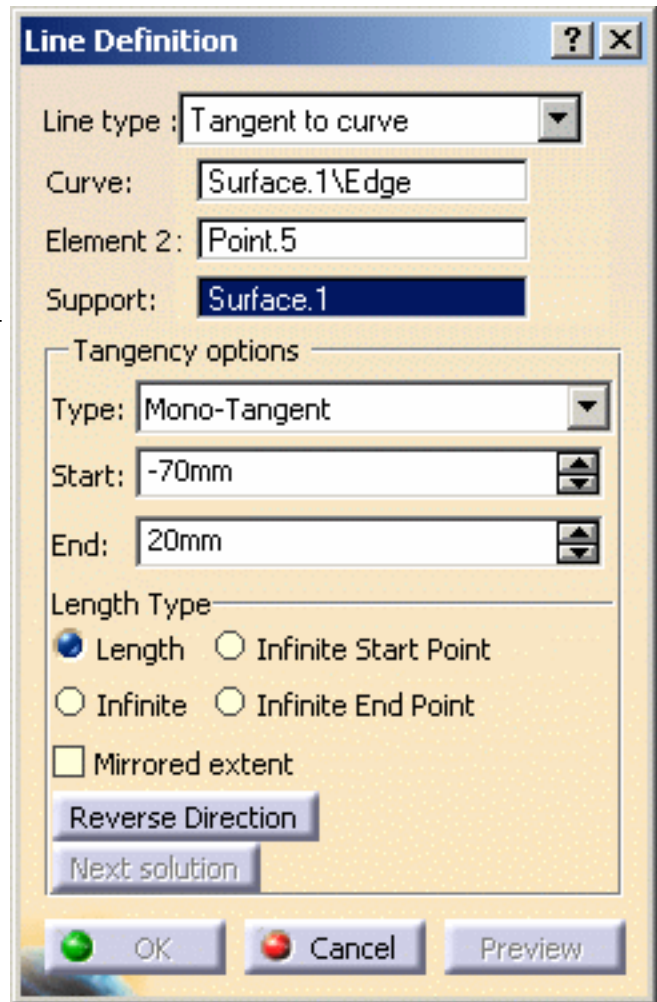

Line tangent to curve at a given point

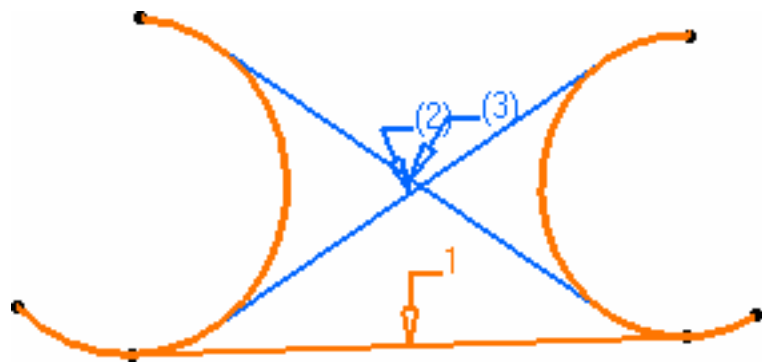

Line tangent to two curves

- Specify **Start** and **End** points to define the new line. The corresponding line is displayed.

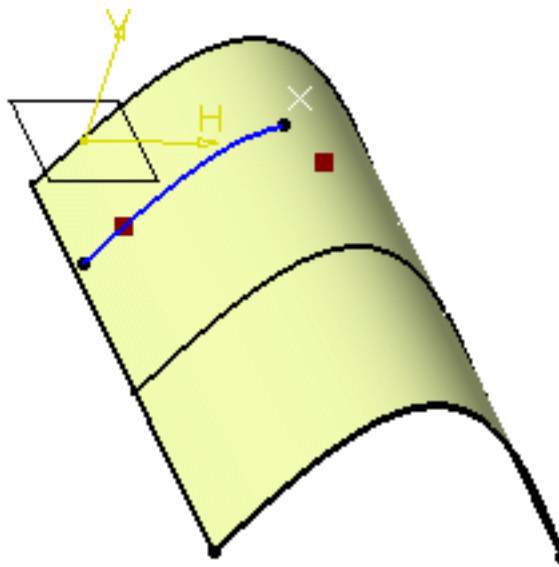

Normal to surface

- Select a reference **Surface** and a **Point**.
A vector normal to the surface is displayed at the reference point.
Proposed **Start** and **End** points of the new line are shown.

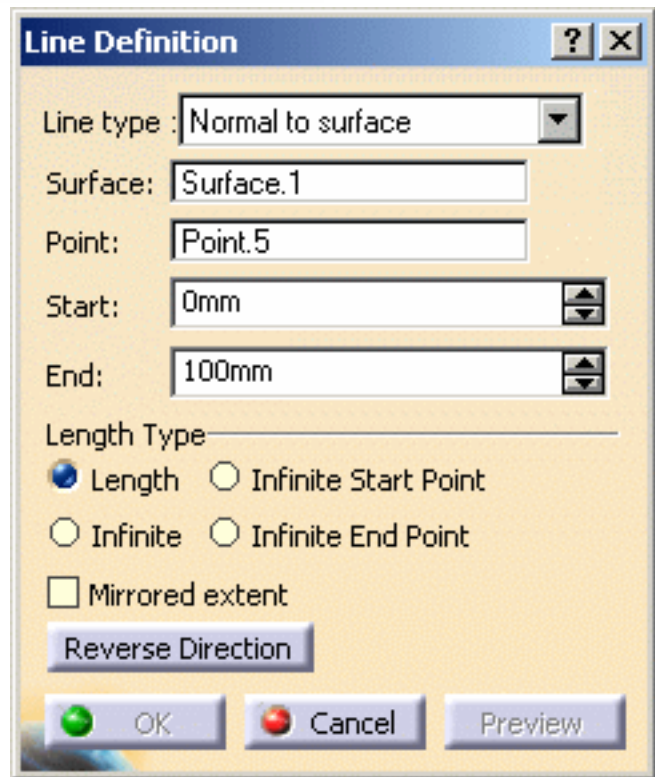

- Specify **Start** and **End** points to define the new line.
The corresponding line is displayed.

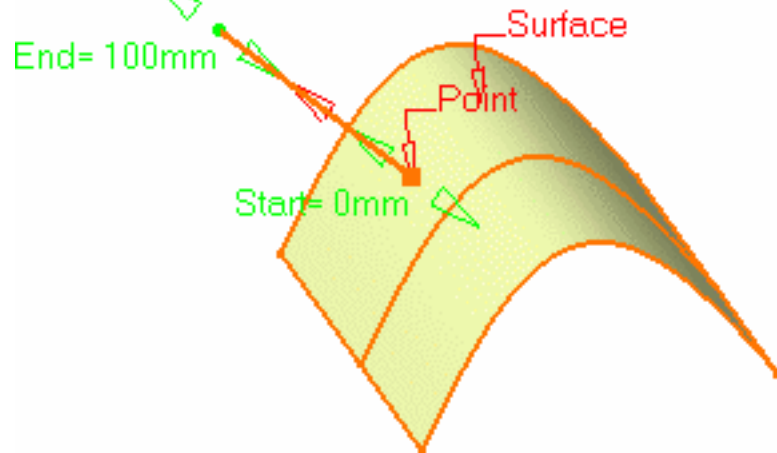

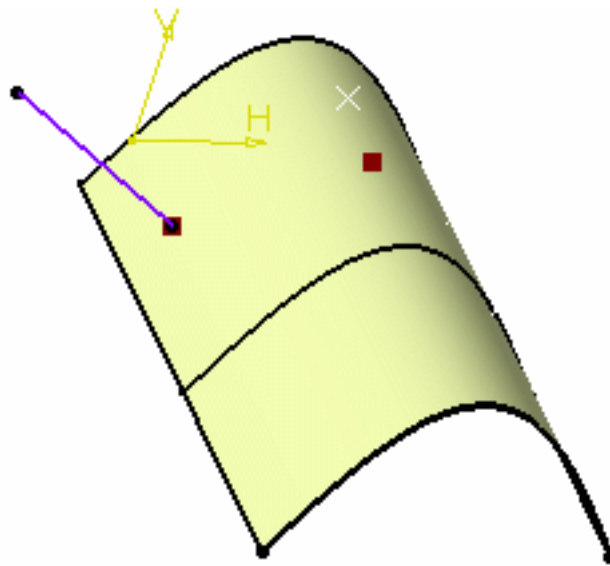

Bisecting

- Select two lines. Their bisecting line is the line splitting in two equal parts the angle between these two lines.
- Select a point as the starting point for the line. By default it is the intersection of the bisecting line and the first selected line.

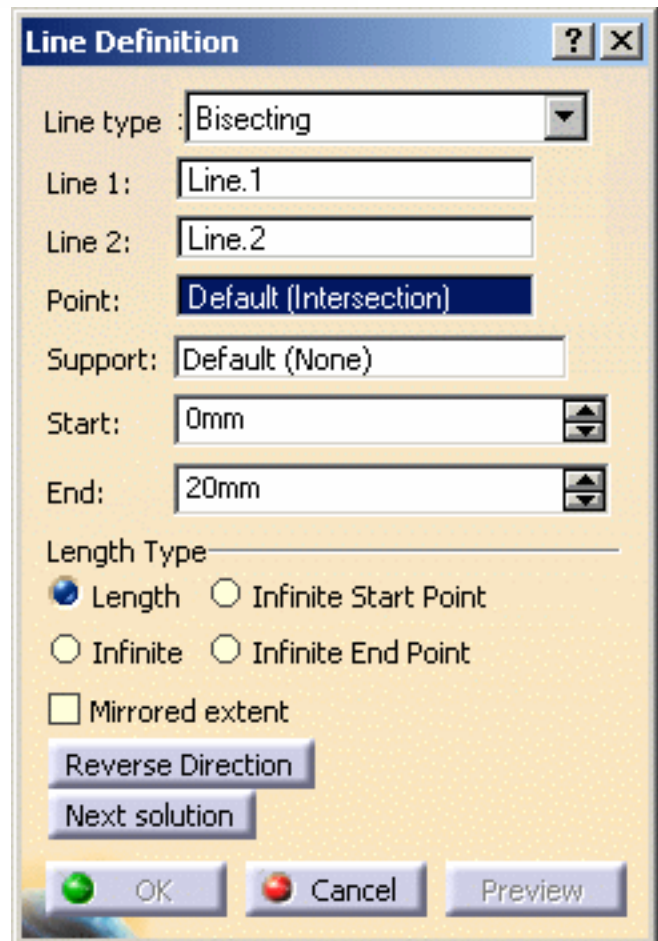

- Select the support surface onto which the bisecting line is to be projected, if needed.
- Specify the line's length in relation to its starting point (**Start** and **End** values for each side of the line in relation to the default end points). The corresponding bisecting line, is displayed.
- You can choose between two solutions, using the **Next Solution** button, or directly clicking the numbered arrows in the geometry.

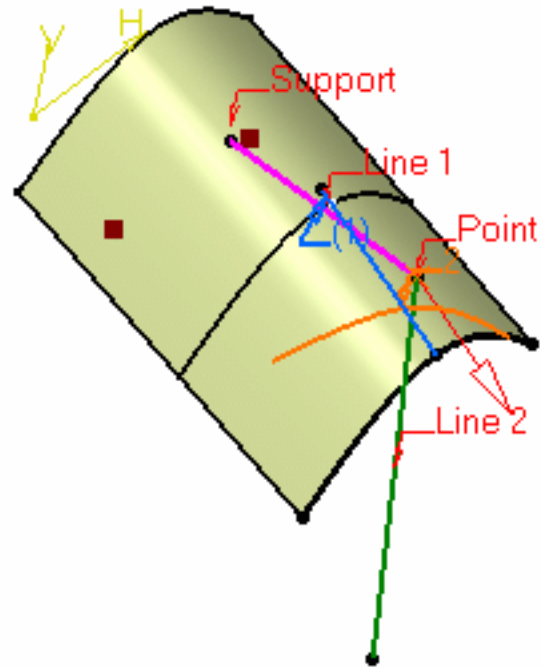

3. Click OK to create the line.

The line (identified as Line.xxx) is added to the specification tree.



- Regardless of the line type, **Start** and **End** values are specified by entering distance values or by using the graphic manipulators.
- Start and End values should not be the same.
- Select the Length Type:
 - **Length**: the line will be defined according to the **Start** and **End** points values
 - **Infinite**: the line will be infinite
 - **Infinite Start Point**: the line will be infinite from the **Start** point
 - **Infinite End Point**: the line will be infinite from the **End** point

By default, the Length type is selected.

The **Start** and/or the **End** points values will be greyed out when one of the **Infinite** options is chosen.

- Check the **Mirrored extent** option to create a line symmetrically in relation to the selected **Start** point.
- In most cases, you can select a support on which the line is to be created. In this case, the selected point(s) is projected onto this support.
- You can reverse the direction of the line by either clicking the displayed vector or selecting the **Reverse Direction** button (not available with the point-point line type).



Automatic Reselection

 This capability is only available with the **Point-Point** line method.



1. **Double-click** the **Line** icon .

The Line dialog box is displayed.

2. Create the first point.

The **Reselect Second Point at next start** option appears in the Line dialog box.

3. Check it to be able to later reuse the second point.
4. Create the second point.
5. Click OK to create the first line.

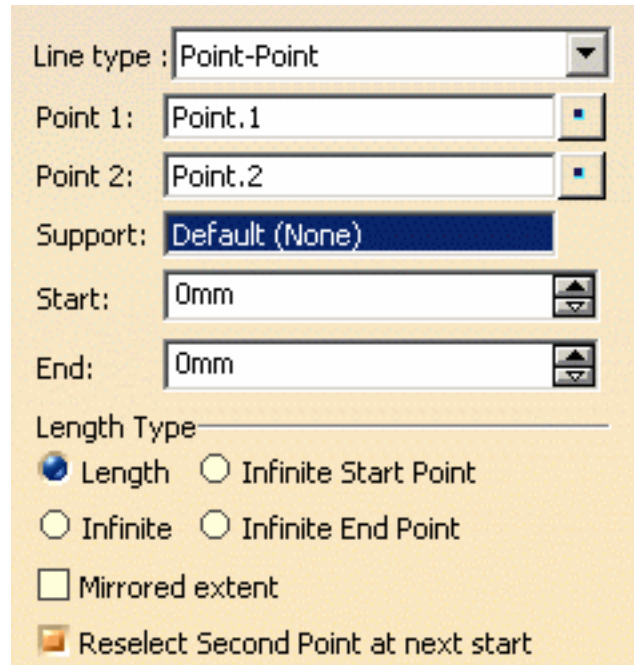

Line type : Point-Point

Point 1: Point.1

Point 2: Point.2

Support: Default (None)

Start: 0mm

End: 0mm

Length Type

Length Infinite Start Point

Infinite Infinite End Point

Mirrored extent

Reselect Second Point at next start

The Line dialog box opens again with the first point initialized with the second point of the first line.

6. Click OK to create the second point.
7. Click OK to create the second line, and so on.

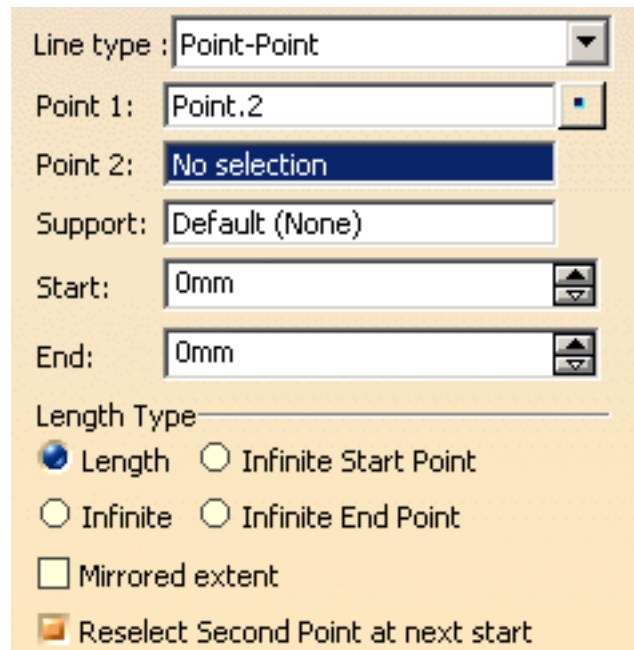

Line type : Point-Point

Point 1: Point.2

Point 2: No selection

Support: Default (None)

Start: 0mm

End: 0mm

Length Type

Length Infinite Start Point

Infinite Infinite End Point

Mirrored extent

Reselect Second Point at next start

To stop the repeat action, simply uncheck the option or click Cancel in the Line dialog box.





Creating Planes

 This task shows the various methods for creating planes:

- offset from a plane
- parallel through point
- angle/normal to a plane
- through three points
- through two lines
- through a point and a line
- through a planar curve
- normal to a curve
- tangent to a surface
- from its equation
- mean through points

 Open the [Planes1.CATPart](#) document.

 1. Click the **Plane** icon .

The Plane Definition dialog box appears.

2. Use the combo to choose the desired **Plane type**.

 Once you have defined the plane, it is represented by a red square symbol, which you can move using the graphic manipulator.

Offset from plane

- Select a reference **Plane** then enter an **Offset** value.

A plane is displayed offset from the reference plane.

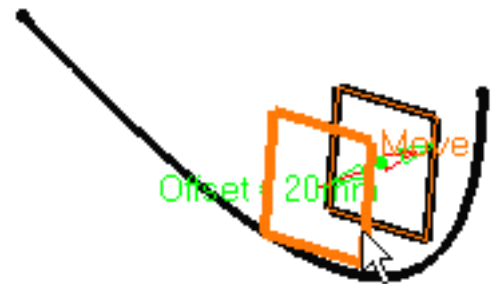

Use the **Reverse Direction** button to reverse the change the offset direction, or simply click on the arrow in the geometry.

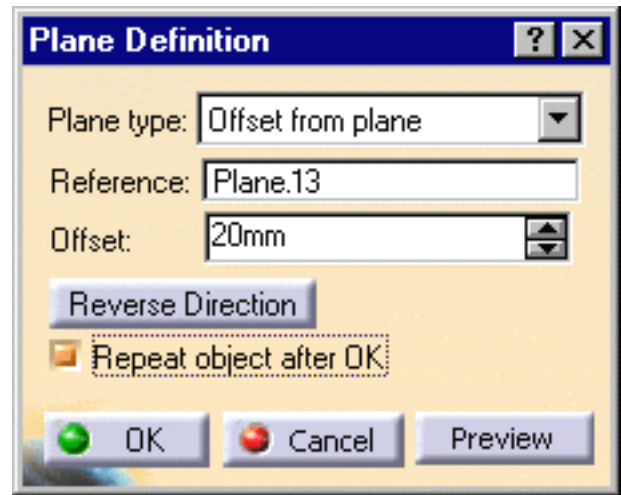

- Click the **Repeat object after OK** if you wish to create more offset planes . In this case, the **Object Repetition** dialog box is displayed, and you key in the number of instances to be created before pressing OK.

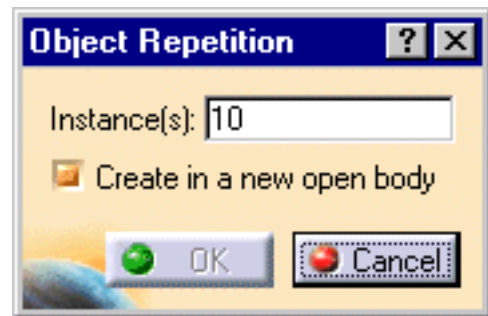

As many planes as indicated in the dialog box are created (including the one you were currently creating), each separated from the initial plane by a multiple of the **Offset** value.

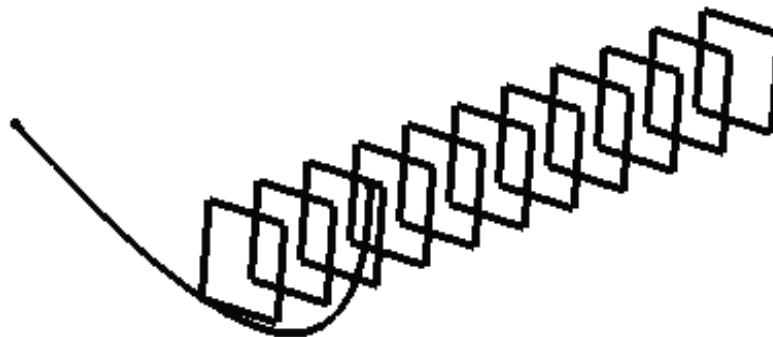

Parallel through point

- Select a reference **Plane** and a **Point**.

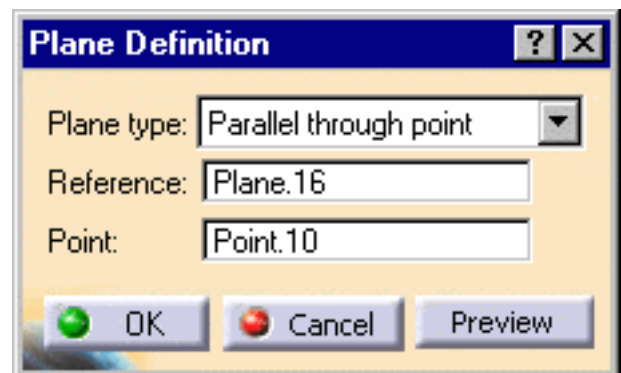

A plane is displayed parallel to the reference plane and passing through the selected point.

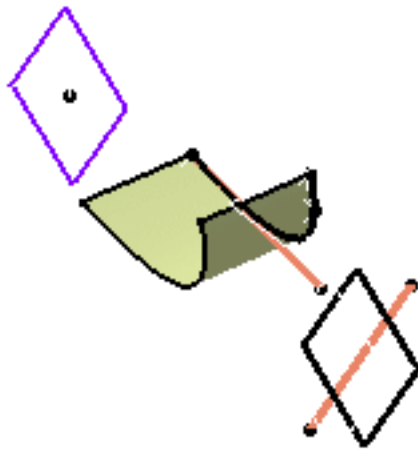
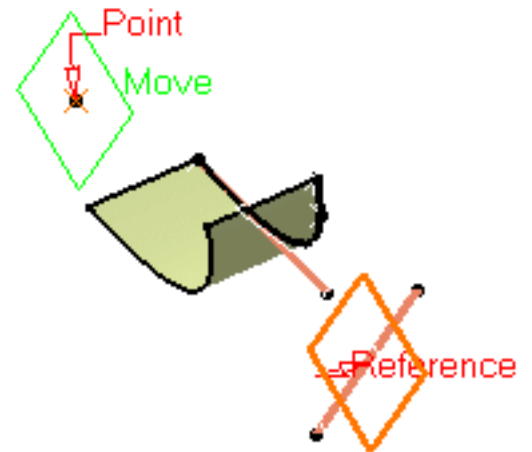

Angle or normal to plane

- Select a reference **Plane** and a **Rotation axis**.
This axis can be any line or an implicit element, such as a cylinder axis for example. To select the latter press and hold the Shift key while moving the pointer over the element, then click it.
- Enter an **Angle** value.

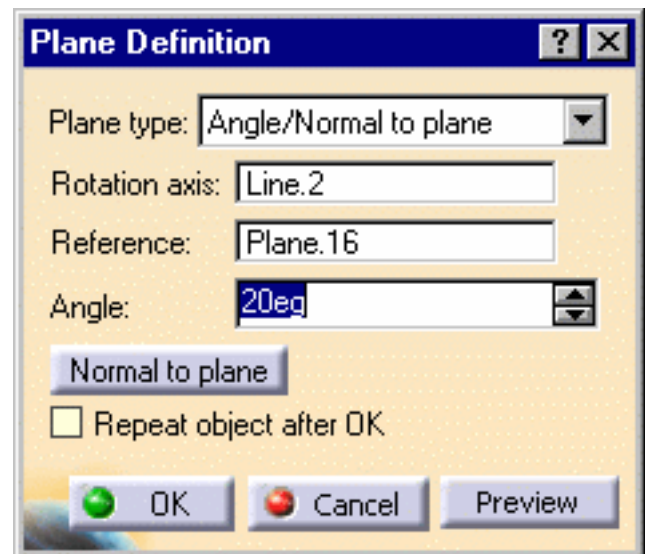

A plane is displayed passing through the rotation axis. It is oriented at the specified angle to the reference plane.

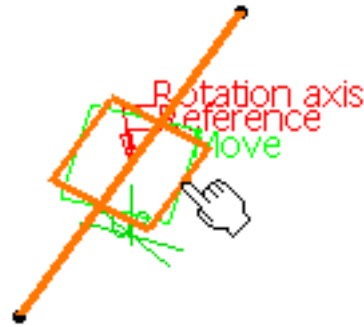

- Click the **Repeat object after OK** if you wish to create more planes at an angle from the initial plane. In this case, the **Object Repetition** dialog box is displayed, and you key in the number of instances to be created before pressing OK.

As many planes as indicated in the dialog box are created (including the one you were currently creating), each separated from the initial plane by a multiple of the **Angle** value.



Here we created five planes at an angle of 20 degrees.

This plane type enables to edit the plane's parameters. Refer to [Editing Parameters](#) to find out how to display these parameters in the 3D geometry.

Through three points

- Select three points.

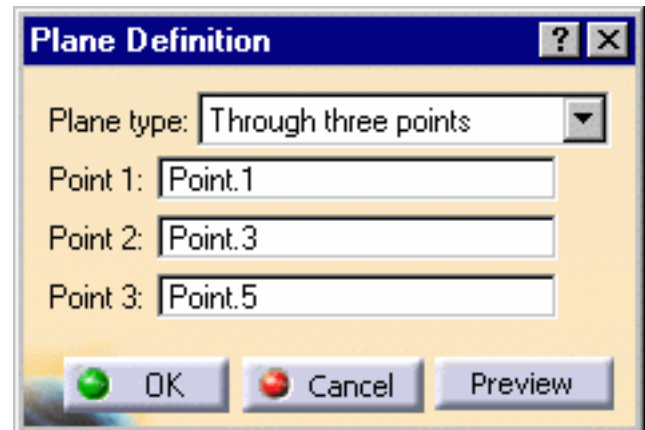

The plane passing through the three points is displayed. You can move it simply by dragging it to the desired location.

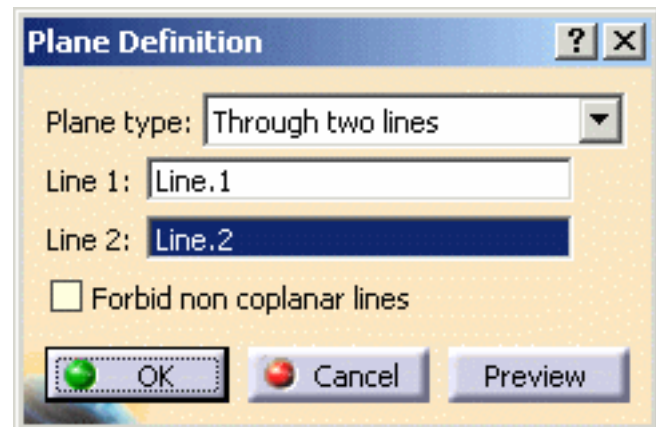
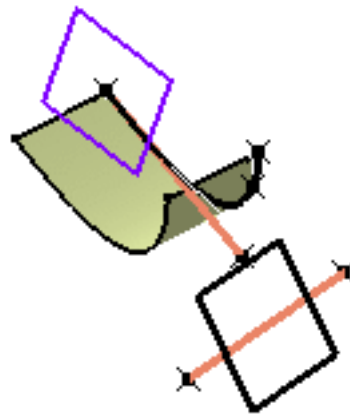
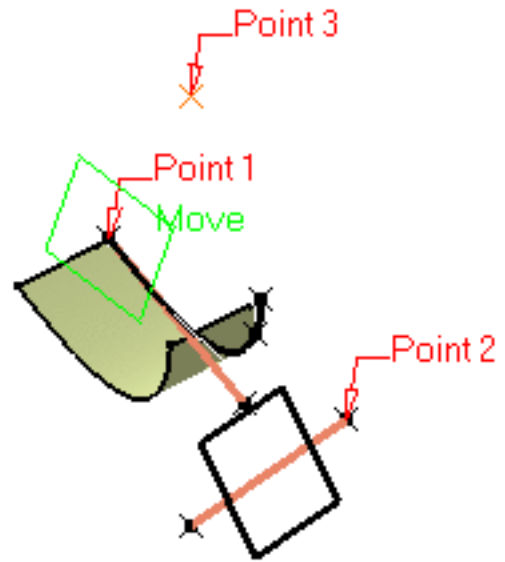

Through two lines

- Select two lines.

The plane passing through the two line directions is displayed.

When these two lines are not coplanar, the vector of the second line is moved to the first line location to define the plane's second direction.

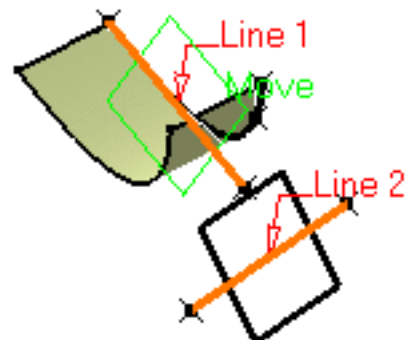

Check the **Forbid non coplanar lines** button to specify that both lines be in the same plane.

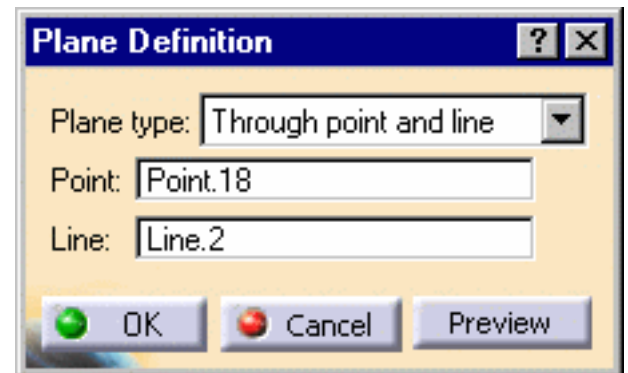
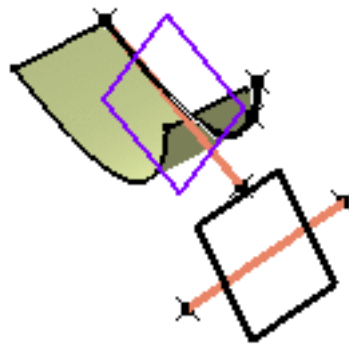

Through point and line

- Select a **Point** and a **Line**.

The plane passing through the point and the line is displayed.

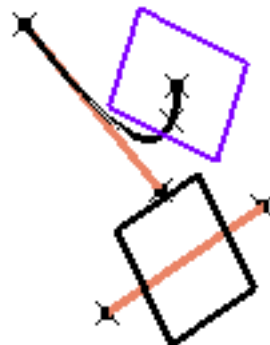
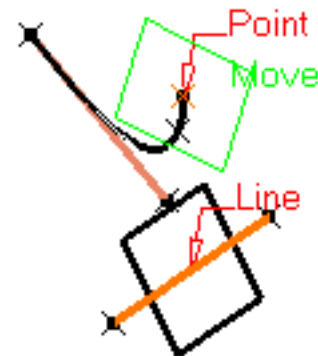

Through planar curve

- Select a planar **C**urve.

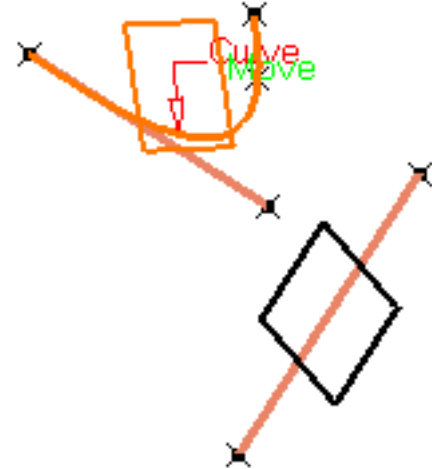
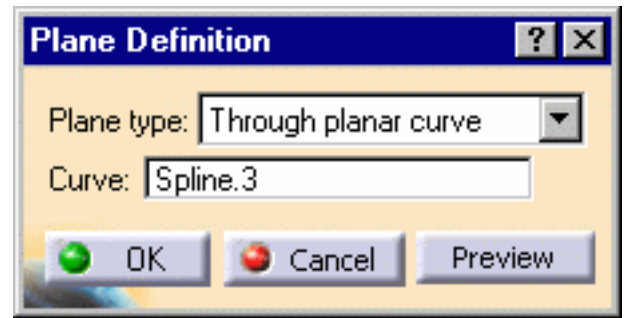

The plane containing the curve is displayed.

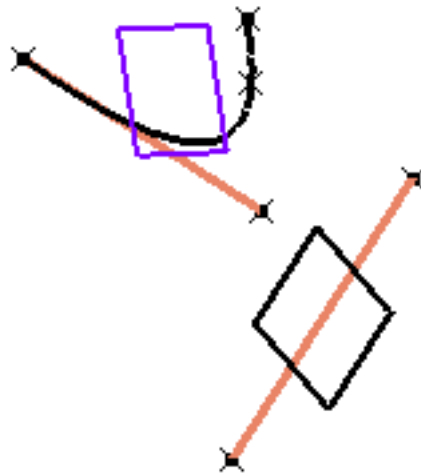

Tangent to surface

- Select a reference **S**urface and a **P**oint.

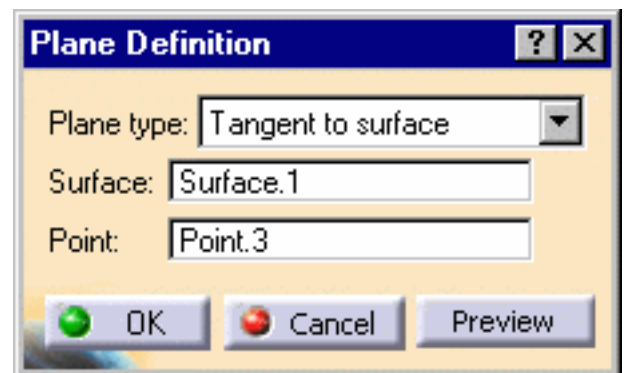

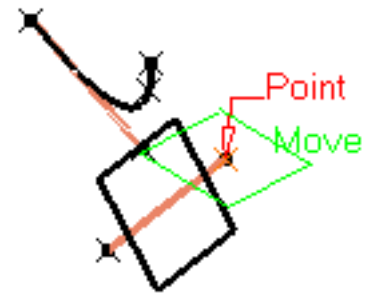

A plane is displayed tangent to the surface at the specified point.

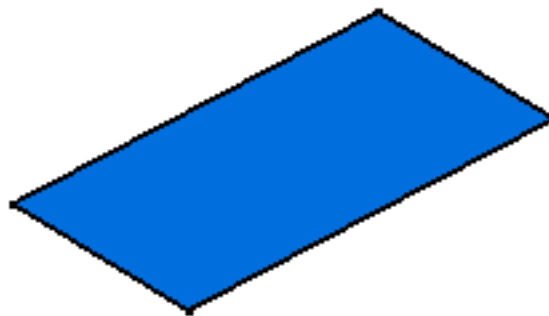
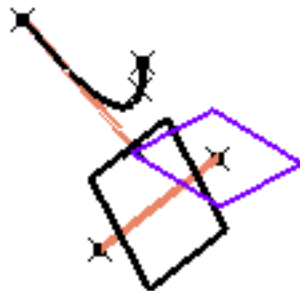
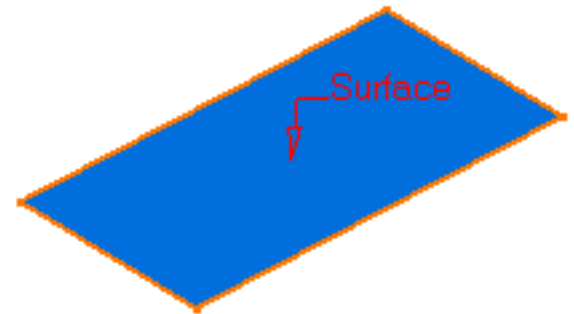

Normal to curve

- Select a reference **Curve**.
- You can select a **Point**. By default, the curve's middle point is selected.

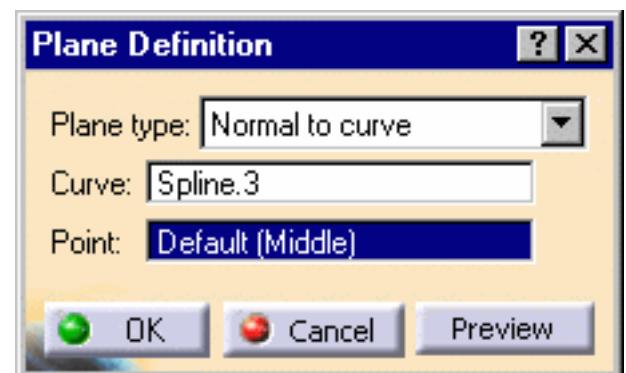

A plane is displayed normal to the curve at the specified point.

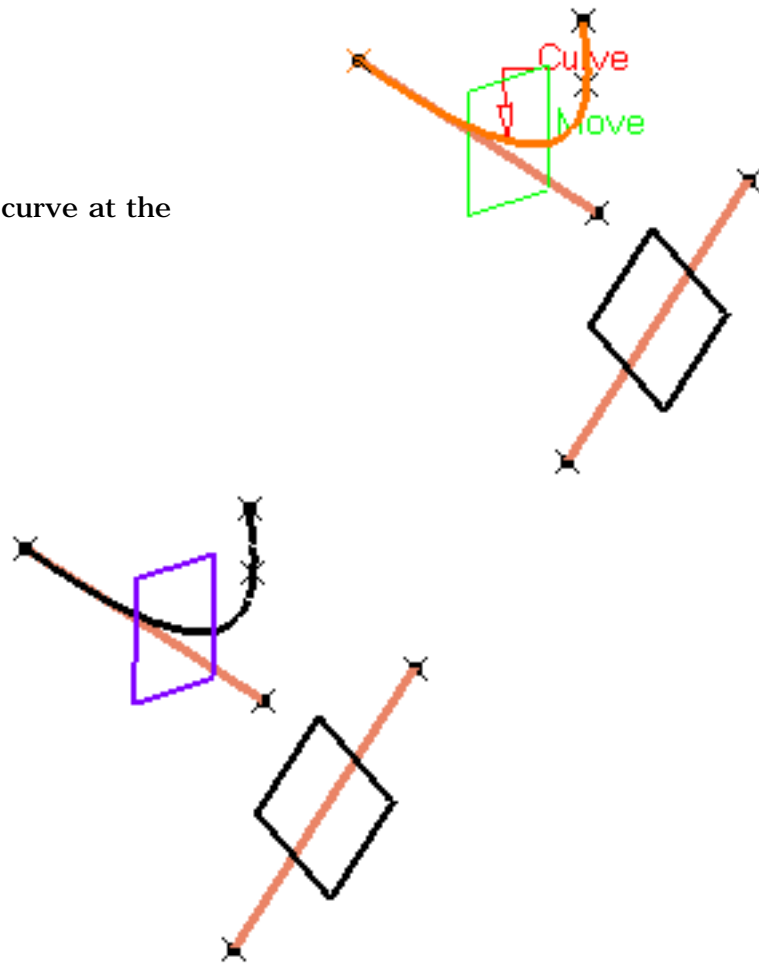

Mean through points

- Select three or more points to display the mean plane through these points.

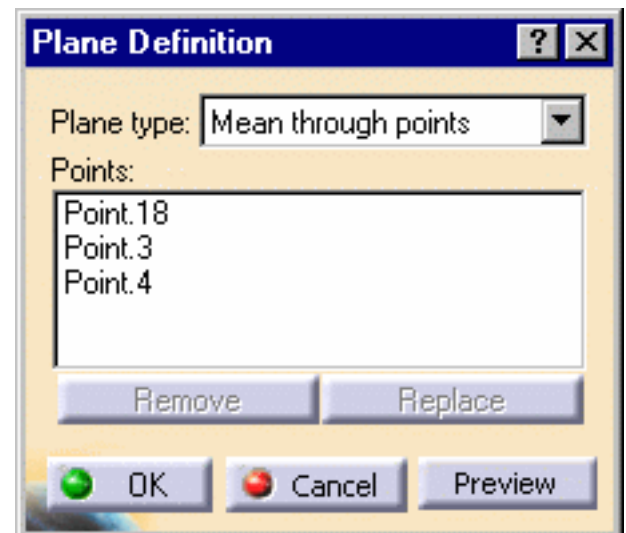

It is possible to edit the plane by first selecting a point in the dialog box list then choosing an option to either:

- **Remove** the selected point
- **Replace** the selected point by another point.

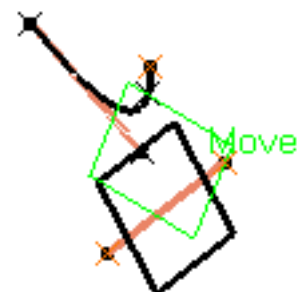

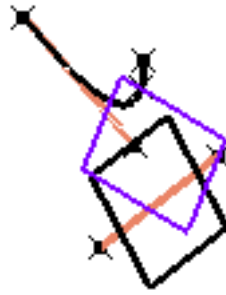

Equation

- Enter the **A**, **B**, **C**, **D** components of the $Ax + By + Cz = D$ plane equation.

Select a point to position the plane through this point, you are able to modify **A**, **B**, and **C** components, the **D** component becomes grayed.

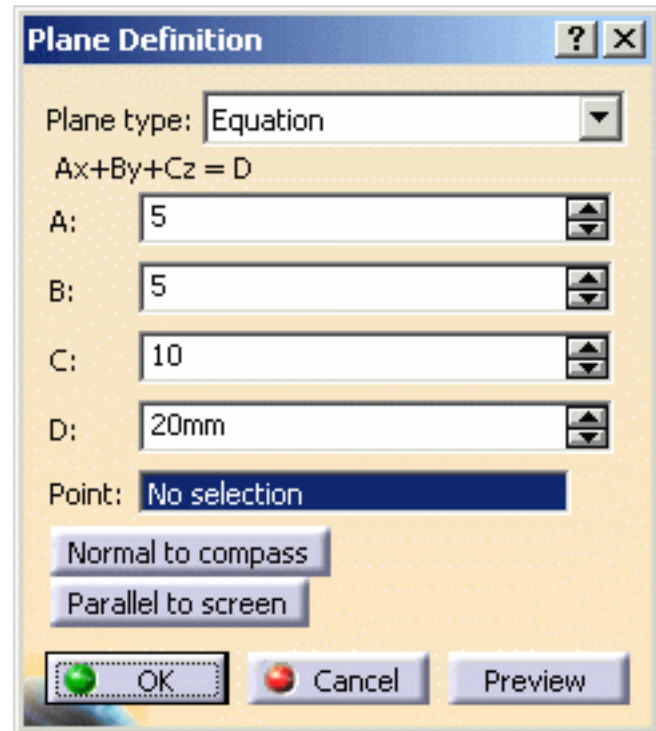

Use the **Normal to compass** button to position the plane perpendicular to the compass direction.

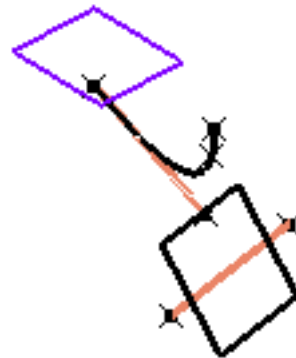

Use the **Parallel to screen** button to parallel to the screen current view.

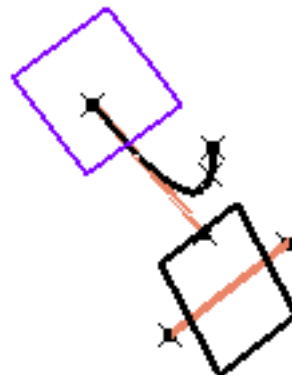

- Click **OK** to create the plane.

The plane (identified as Plane.xxx) is added to the specification tree.



Creating Circles

This task shows the various methods for creating circles and circular arcs:

- center and radius
- center and point
- two points and radius
- three points
- bitangent and radius
- bitangent and point
- tritangent
- center and tangent

Open the [Circles1.CATPart](#) document.

Please note that you need to put the desired geometrical set in show to be able to perform the corresponding scenario.

1. Click the **Circle** icon .

The Circle Definition dialog box appears.

2. Use the combo to choose the desired circle type.

Center and radius

- Select a point as circle **Center**.
- Select the **Support** plane or surface where the circle is to be created.
- Enter a **Radius** value.

Depending on the active **Circle Limitations** icon, the corresponding circle or circular arc is displayed.

For a circular arc, you can specify the **Start** and **End** angles of the arc.

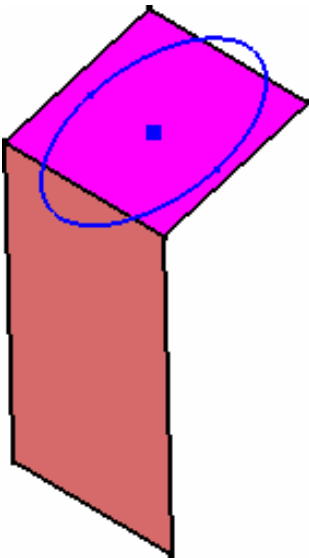
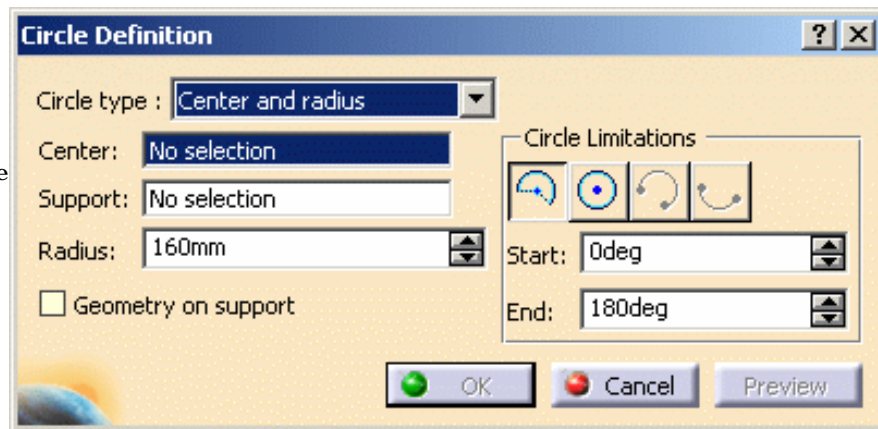

 If a support surface is selected, the circle lies on the plane tangent to the surface at the selected point.

Start and **End** angles can be specified by entering values or by using the graphic manipulators.

Center and point

- Select a point as **Circle center**.
- Select a **Point** where the circle is to be created.
- Select the **Support** plane or surface where the circle is to be created.

The circle, which center is the first selected point and passing through the second point or the projection of this second point on the plane tangent to the surface at the first point, is previewed.

Depending on the active **Circle Limitations** icon, the corresponding circle or circular arc is displayed. For a circular arc, you can specify the **Start** and **End** angles of the arc.

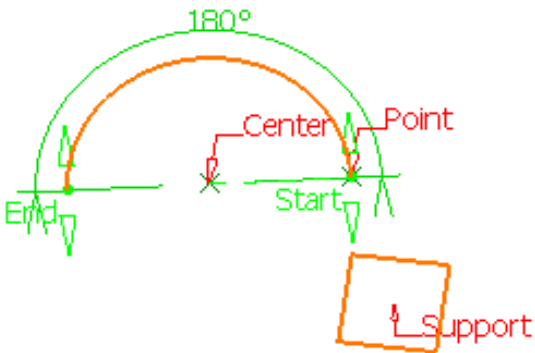

 You can select the **Geometry on Support** check box if you want the circle to be projected onto a support surface.

In this case just select a support surface.

Two points and radius

- Select two points on a surface or in the same plane.
- Select the **Support** plane or surface.
- Enter a **Radius** value.

The circle, passing through the first selected point and the second point or the projection of this second point on the plane tangent to the surface at the first point, is previewed.

Depending on the active **Circle Limitations** icon, the corresponding circle or circular arc is displayed. For a circular arc, you can specify the trimmed or complementary arc using the two selected points as end points.

You can use the **Second Solution** button, to display the alternative arc.

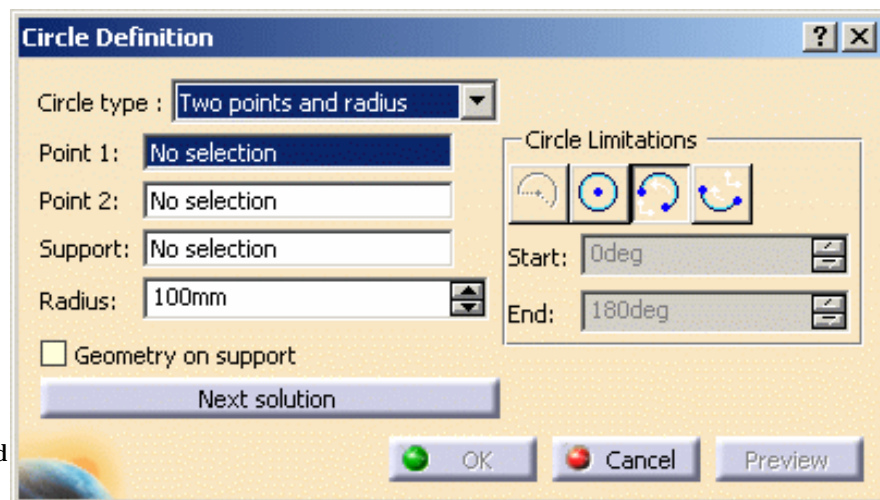
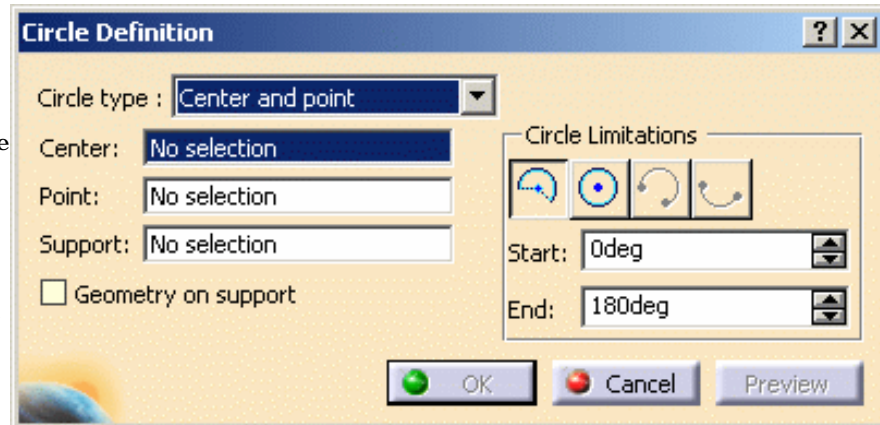

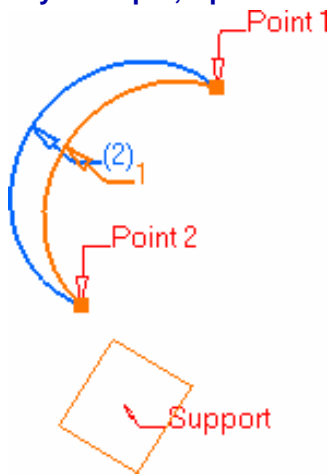

You can select the **Geometry on Support** check box if you want the circle to be projected onto a support surface.

In this case just select a support surface.

Three points

- Select three points where the circle is to be created.

Depending on the active **Circle Limitations** icon, the corresponding circle or circular arc is displayed. For a circular arc, you can specify the trimmed or complementary arc using the two of the selected points as end points.

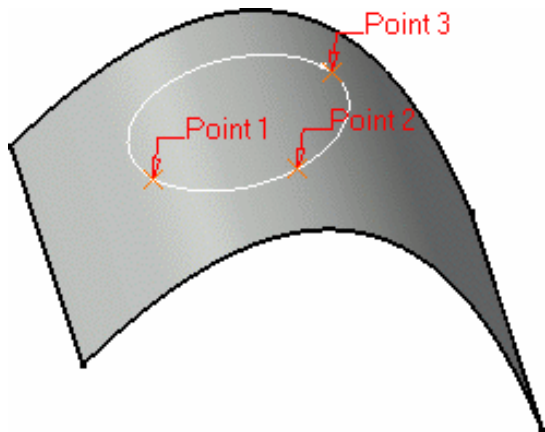
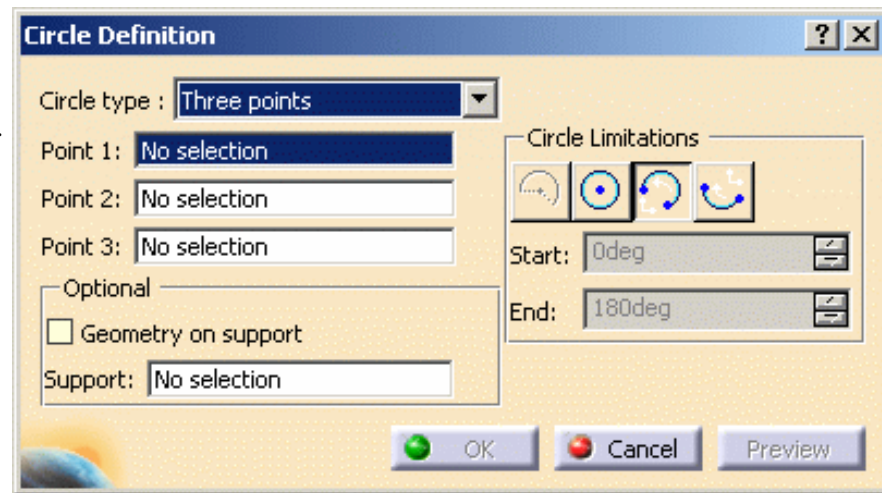

You can select the **Geometry on Support** check box if you want the circle to be projected onto a support surface.

In this case just select a support surface.

Bi-tangent and radius

- Select two **Elements** (point or curve) to which the circle is to be tangent.
- Select a **Support** surface.

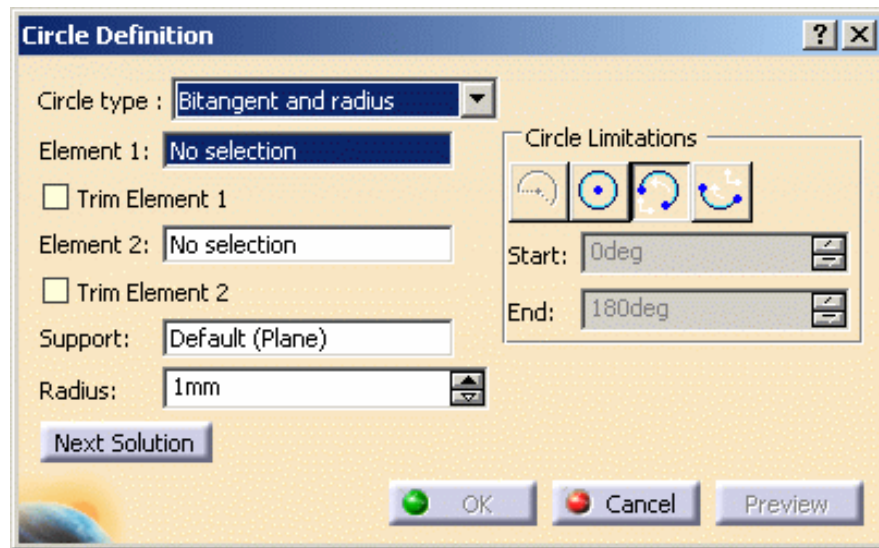

If one of the selected inputs is a planar curve, then the **Support** is set to Default (Plane).

If an explicit **Support** needs to be defined, a contextual menu is available to clear the selection in order to select the desired support.



This automatic support definition saves you from performing useless selections.

- Enter a **Radius** value.
- Several solutions may be possible, so click in the region where you want the circle to be.

Depending on the active **Circle Limitations** icon, the corresponding circle or circular arc is displayed.

For a circular arc, you can specify the trimmed or complementary arc using the two tangent points as end points.

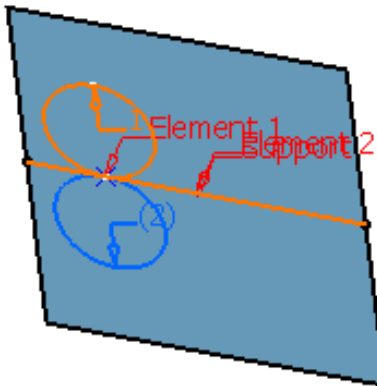

You can select the **Trim Element 1** and **Trim Element 2** check boxes to trim the first element or the second element, or both elements.

Here is an example with Element 1 trimmed.

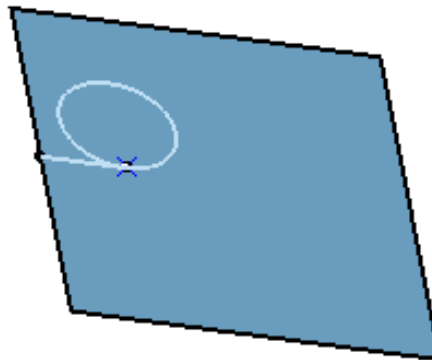

These options are only available with the Trimmed Circle limitation.

Bi-tangent and point

- Select a point or a curve to which the circle is to be tangent.
- Select a **Curve** and a **Point** on this curve.
- Select a **Support** plane or planar surface.

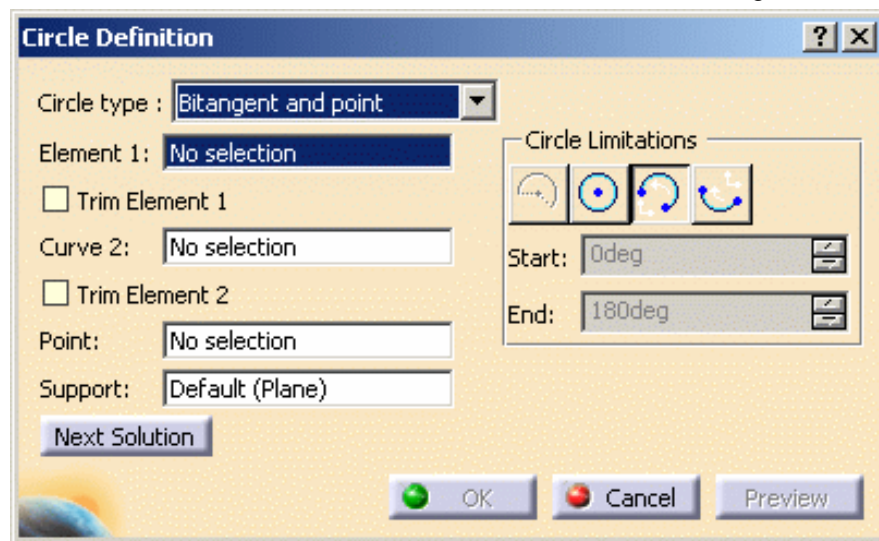

 The point will be projected onto the curve.

If one of the selected inputs is a planar curve, then the **Support** is set to Default (Plane).

If an explicit **Support** needs to be defined, a contextual menu is available to clear the selection in order to select the desired support.

 This automatic support definition saves you from performing useless selections.

- Several solutions may be possible, so click in the region where you want the circle to be.

Depending on the active **Circle Limitations** icon, the corresponding circle or circular arc is displayed.

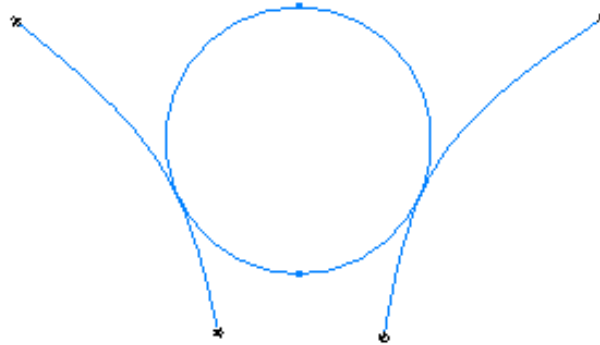

Complete circle

For a circular arc, you can choose the trimmed or complementary arc using the two tangent points as end points.

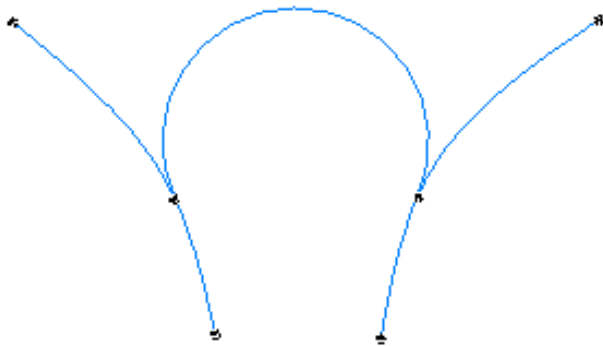

Trimmed circle

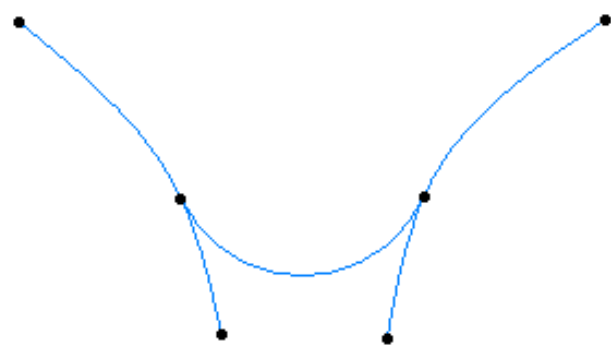

Complementary trimmed circle

 You can select the **Trim Element 1** and **Trim Element 2** check boxes to trim the first element or the second element, or both elements. Here is an example with both elements trimmed.

 These options are only available with the Trimmed Circle limitation.

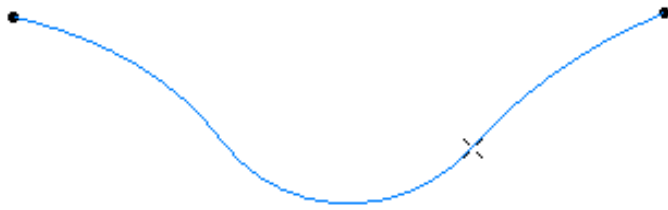

Tritangent

- Select three **Elements** to which the circle is to be tangent.
- Select a **Support** planar surface.

If one of the selected inputs is a planar curve, then the **Support** is set to Default (Plane).

If an explicit **Support** needs to be defined, a contextual menu is available to clear the selection in order to select the desired support.

-  This automatic support definition saves you from performing useless selections.
- Several solutions may be possible, so select the arc of circle that you wish to create.

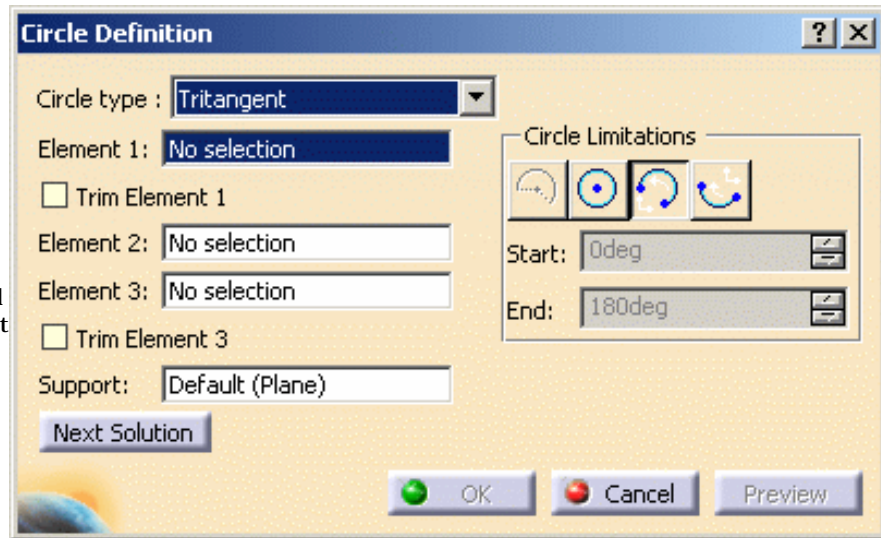

Depending on the active **Circle Limitations** icon, the corresponding circle or circular arc is displayed. The first and third elements define where the relimitation ends. For a circular arc, you can specify the trimmed or complementary arc using the two tangent points as end points.

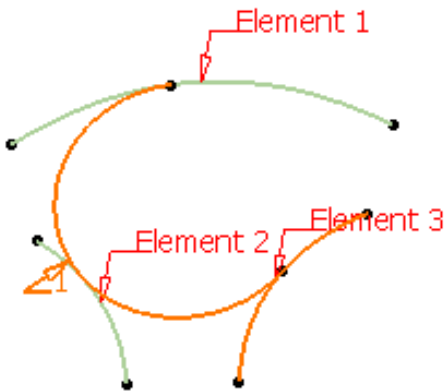

-  You can select the **Trim Element 1** and **Trim Element 3** check boxes to trim the first element or the third element, or both elements. Here is an example with Element 3 trimmed.

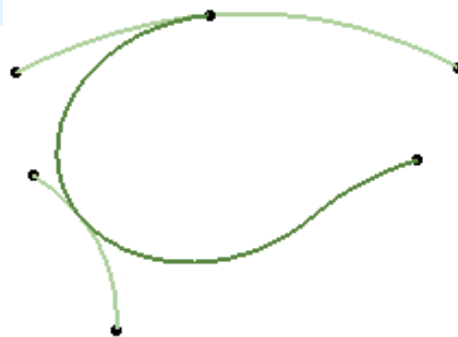

 These options are only available with the Trimmed Circle limitation.

Center and tangent

There are two ways to create a center and tangent circle:

1. Center curve and radius

- Select a curve as the **Center Element**.
- Select a **Tangent Curve**.
- Enter a **Radius** value.

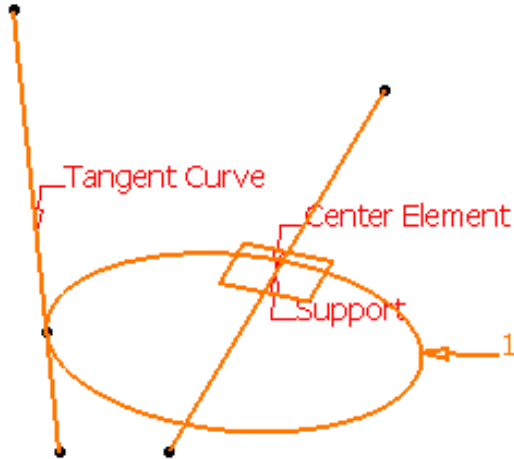
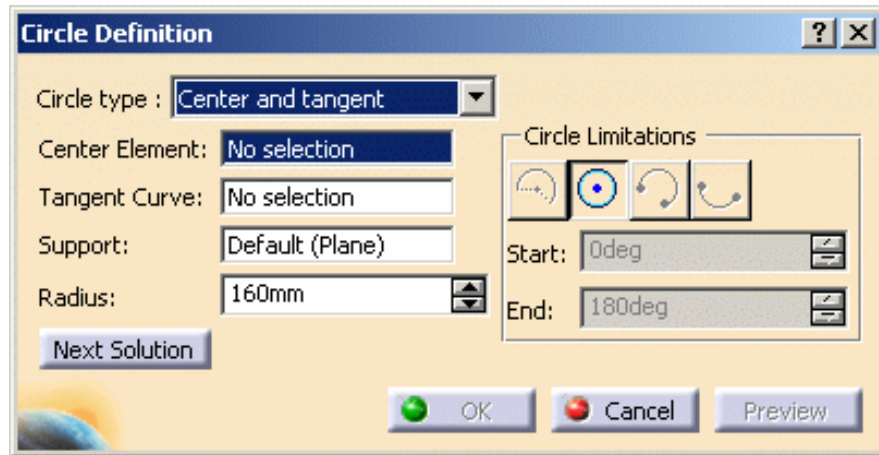

2. Line tangent to curve definition

- Select a point as the **Center Element**.
- Select a **Tangent Curve**.

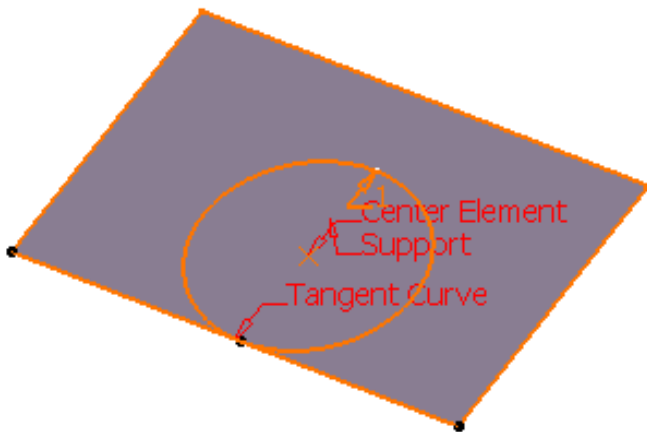

- If one of the selected inputs is a planar curve, then the **Support** is set to Default (Plane). If an explicit **Support** needs to be defined, a contextual menu is available to clear the selection in order to select the desired support.

This automatic support definition saves you from performing useless selections.

- The circle center will be located either on the center curve or point and will be tangent to tangent curve.
- Please note that only full circles can be created.

4. Click **OK** to create the circle or circular arc.

The circle (identified as Circle.xxx) is added to the specification tree.



When several solutions are possible, click the **Next Solution** button to move to another arc of circle, or directly select the arc you want in the 3D geometry.



A circle may have several points as center if the selected element is made of various circle arcs with different centers.

Parameters can be edited in the 3D geometry. To have further information, please refer to the [Editing Parameters](#) chapter.





FreeStyle Interoperability

Optimal CATIA PLM Usability for FreeStyle



Optimal CATIA PLM Usability for FreeStyle



When working with ENOVIA V5, the safe save mode ensures that you only create data in CATIA that can be correctly saved in ENOVIA. Therefore, in interoperability mode, some CATIA V5 commands are grayed out / hidden in the FreeStyle workbench.

ENOVIA V5 offers two different storage modes: Workpackage (Document kept - Publications Exposed) and Explode (Document not kept).

In FreeStyle workbench, when saving data into ENOVIA V5, the global transaction is guaranteed but only if the target is in Workpackage mode. All FreeStyle commands are thus available at all times in this mode.



To ensure seamless integration, you must have both a CATIA and ENOVIA session running.



Workbench Description

In this chapter we will describe the various menus, submenus, items and toolbars of the FreeStyle Shaper and FreeStyle Optimizer workbench.

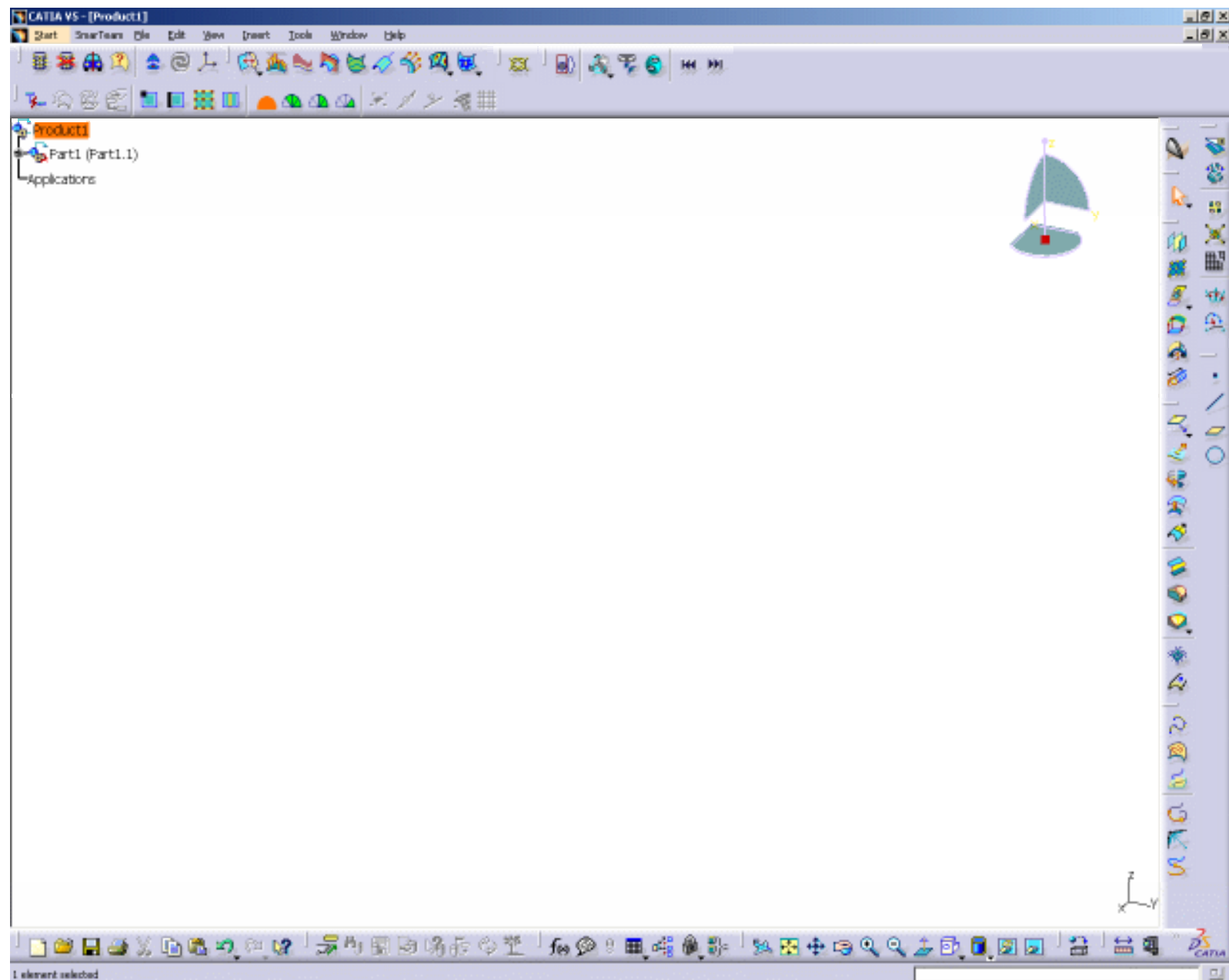

Menu Bar
Creation Toolbars
Modification Toolbars
Analysis Toolbar
Generic Tools Toolbar
FreeStyle Dashboard
FreeStyle Constraints Toolbar
Views Toolbar
Wireframe Toolbar
Specification Tree

This section presents the tools and commands which are available in the FreeStyle Shaper, Optimizer and Profiler workbenches. Many other operations are documented in the *Infrastructure User's Guide*.

Start

[File](#)[Edit](#)[View](#)[Insert](#)[Tools](#)[Windows](#)[Help](#)

File

The File menu lets you perform file creation, opening saving, printing operations. Refer to the *Infrastructure User's Guide*

Edit





The Edit menu lets you manipulate selected objects. Refer to the *Infrastructure User's Guide* and *Part Design User's Guide*.

View

The View menu lets you view document contents Refer to the *Infrastructure User's Guide*.

Insert

The Insert menu lets you insert FreeStyle Shaper, Optimizer and Profiler elements.

	For...	See...
 Insert Tools Window Help		
 Geometrical set...	Geometrical set...	Managing Geometrical Sets
 Ordered geometrical set...	Ordered geometrical set...	Managing Ordered Geometrical Sets
 Axis System...	Axis System	Defining an Axis System
Shape Modification ▶	Shape Modification	Insert -> Shape Modification
Surface Creation ▶	Surface Creation	Insert -> Surface Creation
Curve Creation ▶	Curve Creation	Insert -> Curve Creation
Operations ▶	Operations	Insert -> Operations
Shape Analysis ▶	Shape Analysis	Insert -> Shape Analysis
FreeStyle Constraints ▶	FreeStyle Constraints	Insert -> FreeStyle Constraints

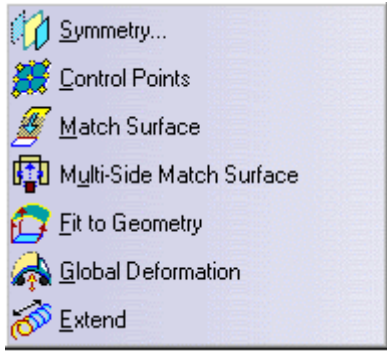

For...
Symmetry...
Control Points
Match Surface
Multi-Side Match Surface
Fit to Geometry
Global Deformation
Extend

See...
[Performing a Symmetry on Geometry](#)
[Editing Curves Using Control Points](#), [Editing a Surface Boundary](#), and [Editing Surfaces Using Control Points](#),
[Performing a Draft Analysis](#), [Performing a Surfacic Curvature Analysis](#)
[Matching Surfaces](#)
[Multi-side Matching](#)
[Fitting a Curve to a Cloud of Points](#) and [Fitting a Surface to a Cloud of Points](#) (Freestyle Optimizer)
[Globally Deforming a Surface](#) (Freestyle Optimizer)
[Extending Curves](#) and [Extrapolating Surfaces](#)

Surface Creation

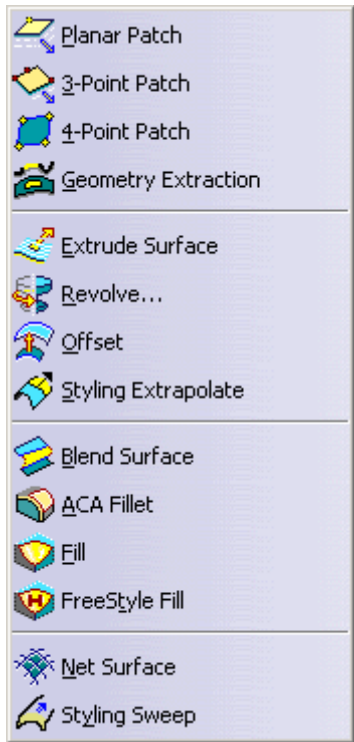

For...
Planar Patch
3-Point Patch
4-Point Patch
Geometry Extraction
Extrude Surface
Revolve...
Offset
Styling Extrapolate
Blend Surface
ACA Fillet
Fill
FreeStyle Fill
Net Surface
Styling Sweep

See...
[Creating Planar Patches](#)
[Creating a Surface from Three Points](#)
[Creating a Surface from Four Points](#)
[Creating a Surface on an Existing Surface](#)
[Extruding a Surface](#)
[Creating Revolution Surfaces](#)
[Offsetting Surfaces](#)
[Extrapolating Curves](#)
[Creating Blend Surfaces](#)
[Creating an ACA Fillet](#)
[Creating Filling Surfaces](#)
[Creating Associative Filling Surfaces](#)
[Creating Net Surfaces](#) (Freestyle Profiler)
[Creating Swept Surfaces](#) (Freestyle Profiler)

Curve Creation

For...
3D Curve
Curve on Surface
Project Curve
Blend Curve

See...
[Creating Associative Curves](#)
[Creating Free Form Curves on Surfaces](#)
[Projecting Curve](#)
[Creating Blend Curves](#)

 Curve on Surface

 Project Curve

 Blend Curve

 Styling Corner

 Match Curve
Match Curve[Matching Curves](#)

Operations

 Break

 Untrim

 Concatenate

 Fragmentation

 Disassemble

 Converter Wizard

 Copy Geometric Parameters
For...**Break****Untrim****Concatenate****Fragmentation****Disassemble****Converter Wizard****Copy Geometric Parameters****See...**[Redefining Surface Limits](#)[Restoring a Surface](#)[Concatenating Curves](#)[Fragmenting Curves](#) and [Fragmenting Surfaces](#)[Disassembling Surfaces](#)[Approximating/Segmenting Procedural Curves](#) and [Approximating/Segmenting Procedural Surfaces](#)[Copying Geometric Parameters](#)

Shape Analysis

 Connect Checker

 Curve Connect Checker

 Distance Analysis

 Porcupine Analysis

 Cutting Planes

 Reflection Lines

 Inflection Lines

 Highlight lines

 Draft Analysis

 Surfacic Curvature Analysis

 Environment Mapping

 Isophotes Mapping

 ACA Highlight
For...**Connect Checker****Curve Connect Checker****Porcupine Analysis****Cutting Planes****Reflection Lines****Inflection Lines****Highlight Lines****Distance Analysis****Draft Analysis****Curvature Mapping****Environment Mapping****Isophotes Analysis****ACA Highlight****See...**[Checking Connections Between Surfaces](#)[Checking Connections Between Curves](#)[Performing a Curvature Analysis](#)[Using Dynamic Cutting Planes](#)[Analyzing Reflect Curves](#) (Freestyle Optimizer)[Creating Inflection Lines](#) (Freestyle Optimizer)[Analyzing Using Highlight Lines](#)[Analyzing Distance Between Two Sets of Elements](#)[Performing a Draft Analysis](#)[Performing a Surfacic Curvature Analysis](#)[Mapping an Environment on a Surface](#)[Analysis Using Isophotes](#)[Analyzing Using Highlights](#)

FreeStyle Constraints

Tools

The Tools menu lets you perform image capture and album management, set user preferences and manage macros. Refer to the [Infrastructure User's Guide](#).

It also allows you to define visualization options, viewpoints, and manage the compass specifically for the FreeStyle Shaper, Optimizer and Profiler elements.

Please note that most of the Tools commands available here are common facilities offered with the Infrastructure.

Specific Generative Shape Design commands are described in the present document.

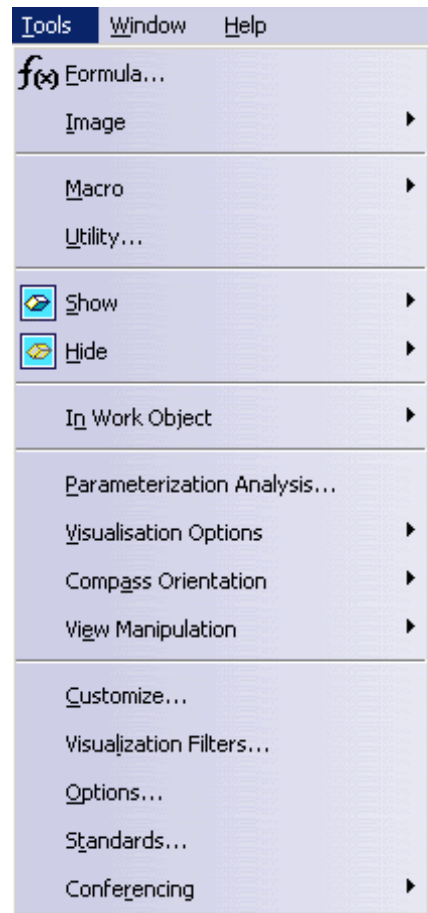

For...

Formula

Image

Macro

Utility...

Show

Hide

In Work Object

Parameterization Analysis...

Visualisation Options

Compass Orientation

View Manipulation

Customize...

Visualization Filters...

Options...

Standards...

Conferencing

See...

Allows editing parameters and formula

Allows capturing images

Allows recording, running and editing macros

[Using the Batch Monitor](#)

Allows to show a set of elements according to their type, or whether they are currently selected or not

Allows to hide a set of elements according to their type, or whether they are currently selected or not

See [Scanning a Part and Defining In Work Objects](#)

[Analysing Using Parameterization](#)

[Visualization Options](#)

[Compass Orientation](#)

[View Manipulation](#)

Allows customizing the workbench.

Allows layer filters management

Allows customizing settings

Managing Standards in the Interactive Drafting documentation

Allows setting up of communication tools

Visualization Options

For...

Apply Dress-Up

Remove Visualization Options

See...

[Setting Visualization Options](#)

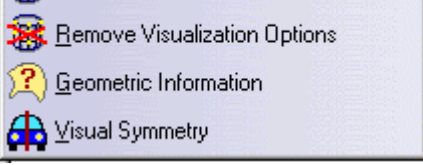

Visual Symmetry [Displaying a Part Symmetrically](#)

Compass Orientation

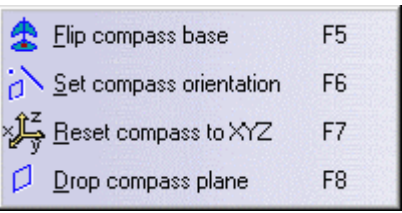

For...	See...
Flip compass base	
Set Compass Orientation	
Reset compass to XYZ	Managing the Compass
Drop compass plane	

View Manipulation

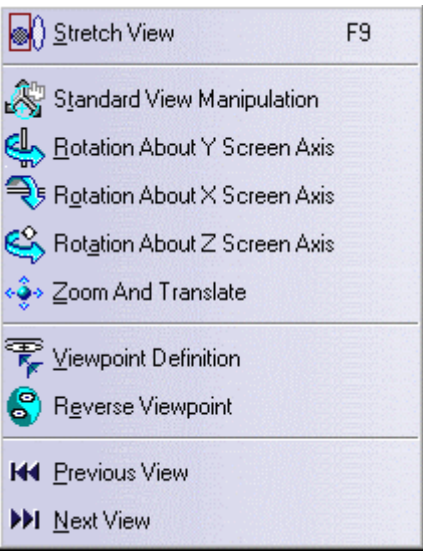

For...	See...
Stretch View	Stretch View Analysis Tool
Standard View Manipulations	
Rotation About Y Screen Axis	
Rotation About X Screen Axis	Manipulating Views
Rotation About Z Screen Axis	
Zoom And Translate	
Viewpoint Definition	
Reverse Viewpoint	Defining Views
Previous View	
Next View	Manipulating Views

Window

The Window menu lets you arrange document windows in relation one to the other. Refer to the [Infrastructure User's Guide](#).

Help

The Help menu lets you get help on the currently active command, and the product in general. Refer to the [Infrastructure User's Guide](#).

Creation Toolbars

The creation toolbars contain the following tools:



See [Creating Planar Patches](#)



See [Creating a Surface from Three Points](#)



See [Creating a Surface from Four Points](#)



See [Creating a Surface on a Existing Surface](#)



See [Extruding a Surface](#)



See [Creating Revolution Surfaces](#)



See [Offsetting a Surface](#)



See [Extrapolating Curves](#)



See [Creating Blend Surfaces](#)



See [Creating an ACA Fillet](#)



See [Creating Filling Surfaces](#)



See [Creating Associative Filling Surfaces](#)



See [Creating a Net Surface](#) (Freestyle Profiler)



See [Creating Swept Surfaces](#) (Freestyle Profiler)



See [Creating Associative 3D Curves](#)



See [Creating Associative 3D Curves on a Scan of Cloud](#)



See [Creating Free Form Curves on Surfaces](#)



See [Projecting Curves](#)



See [Creating Blend Curves](#)



See [Creating Styling Curve Fillets](#)



See [Matching Curves](#)

Modification Toolbars

The modification toolbar contains the following tools:



 See [Manipulating Surfaces](#) and [Rotating a Surface](#)



See [Selecting Using Multi-Selection](#)



See [Performing a Symmetry on Geometry](#)



See [Editing Curves Using Control Points](#), [Smoothing Curves](#), [Editing Surfaces Using Control Points](#) and [Smoothing Surfaces](#)



See [Matching Surfaces](#)

P2



See [Multi-side Matching](#)

P2



See [Fitting a Curve to a Cloud of Points](#) and [Fitting a Surface to a Cloud of Points](#) (Freestyle Optimizer)

P2



See [Globally Deforming Surfaces](#) (Freestyle Optimizer)



See [Extending a Curve](#) and [Extrapolating a Surface](#)

P2



See [Redefining Surface Limits](#)



See [Restoring a Surface](#)



See [Fragmenting Curves](#) and [Fragmenting Surfaces](#)



See [Concatenating Curves](#)



See [Disassembling](#)



See [Approximating/Segmenting Curves](#) or [Approximating/Segmenting Surfaces](#)



See [Copying Geometric Parameters](#)

Analysis Toolbar

The analysis toolbar contains the following tools:

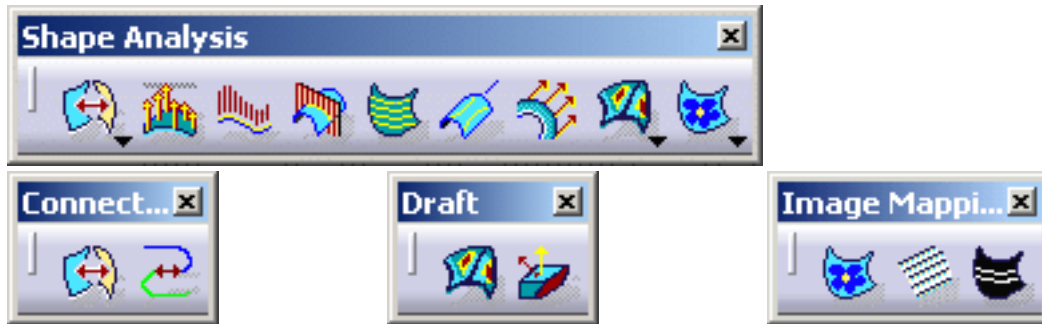

See [Checking Connections Between Elements](#)



See [Checking Connections Between Curves](#)



See [Analyzing Distance Between Two Sets of Elements](#)



See [Performing a Curvature Analysis](#)



See [Using Dynamic Cutting Planes](#)



See [Analyzing Reflect Curves \(Freestyle Optimizer\)](#)



See [Creating Inflection Lines \(Freestyle Optimizer\)](#)



See [Analyzing Using Highlight Lines](#)



See [Performing a Surfacic Curvature Analysis](#)



See [Performing a Draft Analysis](#)



See [Mapping an Environment on a Surface](#)



See [Analyzing Using Isophotes](#)



See [Analyzing Using Highlights](#)

Generic Tools Toolbar

The generic tools toolbar contains the following tools:



See [Setting FreeStyle Visualization Options](#)



See [Setting FreeStyle Visualization Options](#)



See [Displaying a Part Symmetrically](#)



See [Displaying Geometric Information on Elements](#)



See [Managing the Compass](#)

















See [Defining an Axis System](#)

FreeStyle Dashboard



The FreeStyle Dashboard contains the following tools:



- | | |
|---|---|
|  | See Creating Datums |
|  | See Keeping the Initial Element |
|  | See Inserting in a New Geometrical Set |
|  | See Creating a Temporary Analysis |
|  | See Auto detection |
|  | |
|  | See Attenuation |
|  | |
|  | See Displaying Manipulators on Elements |
|  | |
|  | See Displaying Control Points Temporarily |
|  | |
|  | |
|  | |
|  | |

FreeStyle Constraints Toolbar



See [Creating a Continuity Constraint](#)

Views Toolbar

The views toolbar contains the following tools:



See [Stretch View Analysis Tool](#)



See [Manipulating Views](#)



See [Manipulating Views](#)



See [Manipulating Views](#)



See [Manipulating Views](#)



See [Manipulating Views](#)



See [Defining Views](#)



See [Defining Views](#)



See [Manipulating Views](#)



See [Manipulating Views](#)

Wireframe Toolbar

By default, the WireFrame toolbar is hidden.



See [Creating Points](#)



See [Creating Lines](#)



See [Creating Planes](#)



See [Creating Circles](#)

Specification Tree

Within the FreeStyle Shaper and FreeStyle Optimizer workbench, you can generate a number of elements that are identified in the specification tree by the following icons.

Further information on general symbols in the specification tree are available in [Symbols Used in the Specification Tree](#).

 Sketch	 Symmetry
 3D Curve	 Untrim
 Curve on Surface	 Point
 Curve Projection	 Line
 Blend Curve	 Plane
 Styling Corner	 Circle
 Match Curve	 Axis System
 Break	 Surface Connect Checker
 Disassembling Curves	 Curve Connect Checker
 Curve Approximation/Segmentation	 Distance Analysis
 Planar Surface	 Curvature Analysis
 3-Point Surface	 Cutting Plane Analysis
 4-Point Surfaces	 Reflect Lines
 Geometry Extraction	 Inflection Lines
 Extrusion Surface	 Highlight Lines
	 Surface Curvature Analysis

-  Offset Surface
-  Extrapolation Surface
-  Blend Surface
-  ACA Fillet
-  Fill Surface
-  Surface Fragmentation
-  Disassembling Surfaces
-  Surface Approximation/Segmentation
-  FreeStyle Fill Surface
-  Revolution Surface
-  Net Surface
-  Styling Sweep

-  Draft Analysis
-  Environment Mapping
-  Isophotes Mapping
-  Geometrical Set
-  Ordered Geometrical Set
-  Multi-Output

Customizing For FreeStyle Shaper, Optimizer, and Profiler

 This task explains how to customize settings for FreeStyle workbenches.



1. Select the **Tools** -> **Options** menu item.

The Options dialog box is displayed.

2. Select the **Shape** category then select the **FreeStyle** subcategory.

The options for FreeStyle settings appear, organized in separate areas depending on the type of setting.

- Geometry
- Auto-detection
- Display
- Tuning

3. In the **Geometry** area, check:

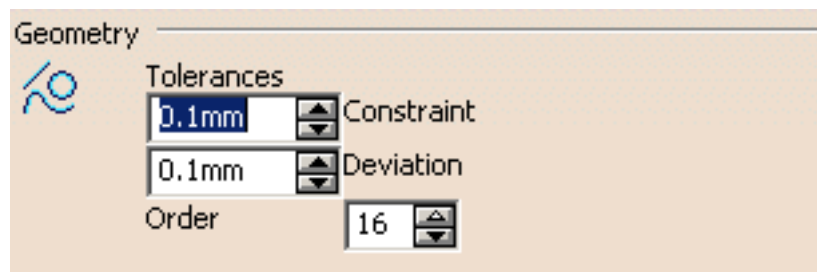

- **Tolerances:** to impose user-defined tolerances to every elements to be created and modified within a FreeStyle workbench.
You can define:
 - the **constraint tolerance value** used to define the continuity variation. In this case if the continuity is over the set value the element is not created/modified.
In P1 mode, the **constraint tolerance value** is set and cannot be modified.
 - the **deviation tolerance value**, used when converting elements using the Converter Wizard for example (see tasks "Approximating/Segmenting Procedural Curves" and "Approximating/Segmenting Procedural Surfaces" within the *FreeStyle Shaper, Optimizer, and Profiler User's Guide*). In this case you accept the conversion up to the set tolerance value.
- **Order:** to set the maximum allowed order along the U (and V) directions for each curve segment and surface patch.
This maximum order value ranges from 5 to 16 included, in a given direction.



In P1 mode, the **Max order** is set to 16 and cannot be modified.



4. In the **Auto-Detection** area, you can choose to display:

- the point coordinates as the pointer moves along the geometry by selecting the **Coordinates** checkbox
- the dressing mode by selecting the **Search dressing** checkbox. This option allows the display of control points on geometry detected with the pointer when using the **Snap on Cpt** (snap on control points) option from the Dashboard.

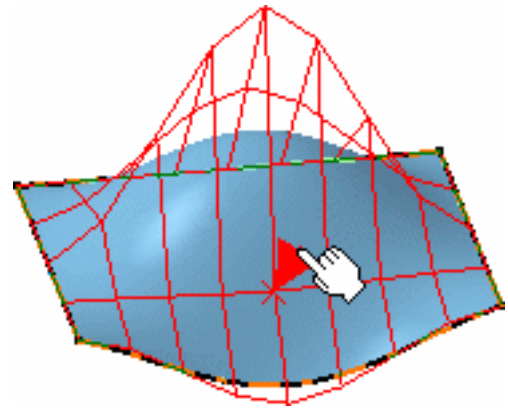
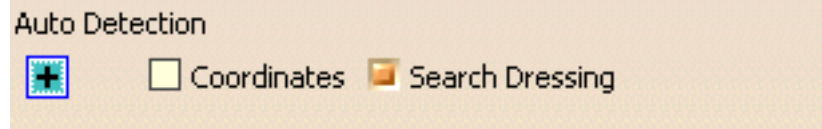

5. In the **Display** area, you set the information to be displayed on the geometry as you manipulate it, that is:

- the **Control Points** on the geometry. See "Displaying Control Points Temporarily" in the *FreeStyle Shaper, Optimizer, and Profiler User's Guide*).
- the **Continuity** at every connection between elements (such as blend and match curves and surfaces, fill surfaces, and so forth)

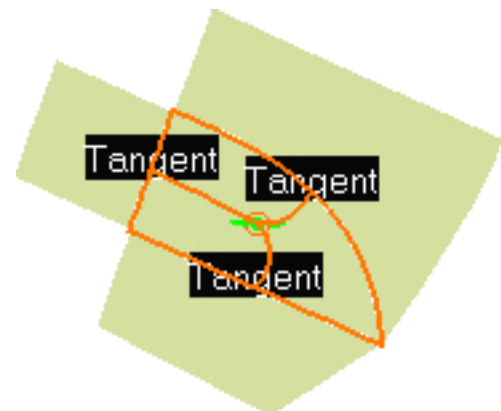
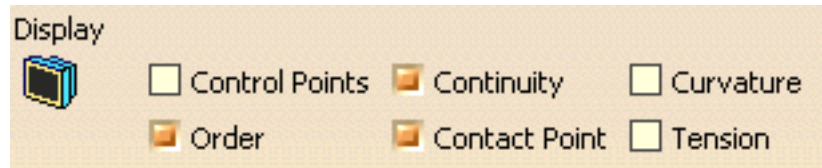

- the **Curvature** texts on an element (such as blend and match curves and surfaces, and so forth)

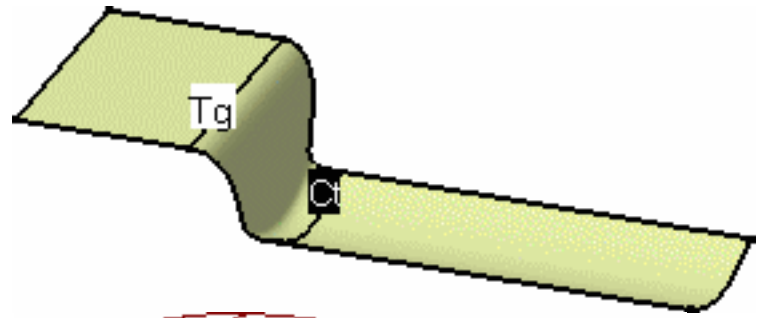

- the **Order** number along the U (for curves) or U and V directions (for surfaces).

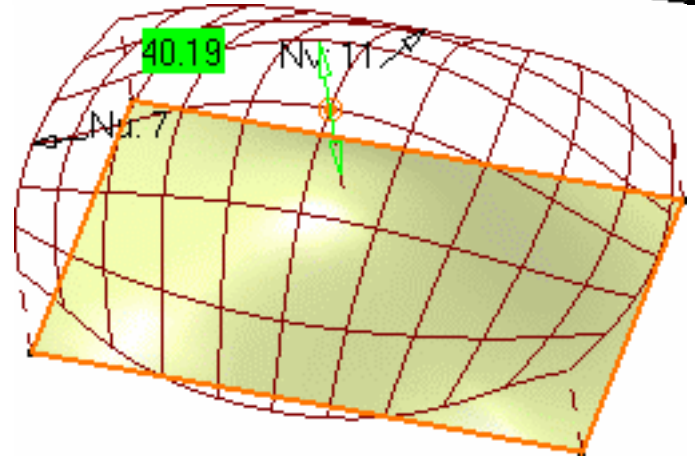

- the **Contact Point** at every connection between connected elements (such as blend and match curves and surfaces, and so forth)

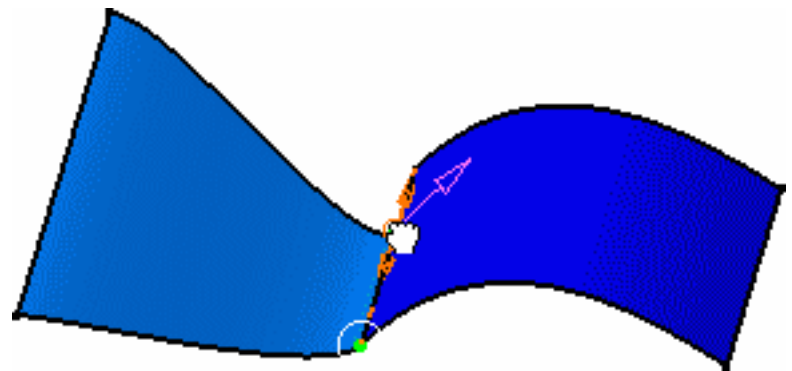

P2

- the **Tension** manipulators at every connection between connecting elements (such as blend and match curves and surfaces, and so forth)

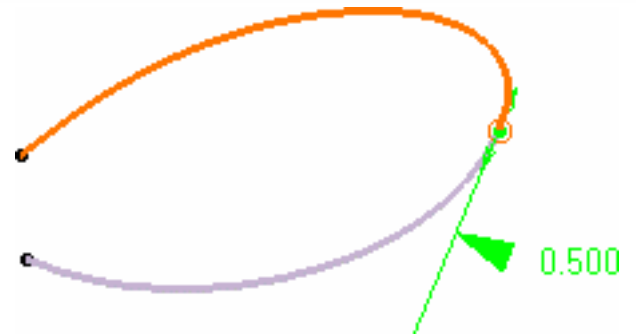

P2

- 6.** In the **Tuning** area, you set the values used when manipulating views or geometry (P2 only).

See "Editing Surfaces Using Control Points", and "Manipulating Views" in the *FreeStyle Shaper, Optimizer, and Profiler User's Guide* for example.

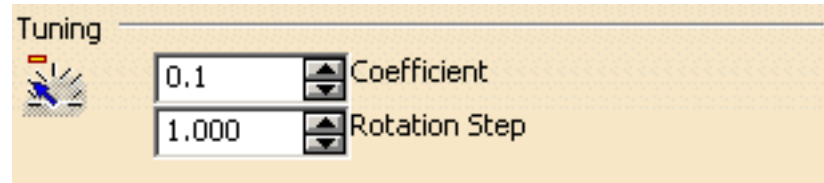

- 7.** Click **OK** to confirm setting these permanent options.

i

For further information on the Performance tab, refer to the chapter called Performance in the *Infrastructure User's Guide*.



Glossary



Special Characters

- 2D-Curve** A 2D-Curve is defined in the u-v-Parameterspace of the surface. A 2D-Curve yields information of the surface, for example the curvature of the surface. A 2-D Curve does not follow the modification of the surface. If you modify the surface there will be a gap between the 2-D Curve and the surface.
- 3D compass** The 3D compass is a three-axis system used to define the plane into which any action is performed. It is displayed whenever you are creating an element or applying modifications to this element.
- 3D-Curve** Normally a curve is a 3D-Curve. A 3D-Curve placed on a surface does not yield any information about the surface.

A

- approximation** A surface or a curve is converted into a NUPBS surface or a NUPBS curve.
- attenuation** Factor to attenuate the speed with of the mouse displacement.

B

- basic surface** If a surface is trimmed at an arbitrary curve, it is sometimes wanted that the trimmed surface yields the information about the input surface. This input surface is called Basic Surface (if it is not trimmed).
A trimmed surface is called a face and the underlying untrimmed surface is called the Basic surface.
- blend curve** A curve created to connect two pre-existing curves.
- blend surface** A surface created to connect two pre-existing surfaces

C

- chain of curves** A chain of curves contains at least one curve. If there are more than one curve, the endpoint of the first curve has to meet the start point of the second curve and so on. Gaps and overlapping are not allowed.
- cloud of points** A set of points in space. A cloud of points may consist of a single point or several million points.

F

- face** A face is a trimmed surface. A face has an underlying [Basic Surface](#).
- feature modeling** Some Commands, e.g. Fillet, have the Option Feature Modeling. The term Feature Modeling is explained with the Command [ACA Fillet](#).

G

G0 If the endpoint of curve K1 meets the endpoint of curve K2 then we say: At this point both curves are connected with order of continuity G0.
 If one edge of surface S1 meets an edge of the surface S2 then we say along this edge both surfaces are connected with the order of continuity G0.
 If the G0-continuity is missed then we have a so called G0-error. This error is an absolute error, a distance, and it is measured in mm or inches.

G1 The curve K1 and the curve K2 are connected with the order of continuity G0 in the point P. If both curves in the point P run into the same direction, this means the angle between the tangents of both curves is 0, then we say the order of continuity is G1.
 The surface S1 and the surface S2 are connected with the order of continuity G0 along the curve C. We take the normal of S1 in a point near the curve C and run with this normal over the border to S2. If the normal does not change its angle from one point of the border of S1 to the nearest point of S2 then we say the order of continuity is G1.
 If the G1-continuity is missed then we have a so called G1-error. This error is an absolute error, an angle, and it is measured in deg of rad.

G2 The curve K1 and the curve K2 are connected with the order of continuity G1 in the point P. We look at the curvature vector of K1 in point P and the curvature vector of K2 in point P. If both vectors have the same direction and the same absolute value, then we say the order of continuity is G2.
 The surface S1 and the surface S2 are connected with the order of continuity G1 along the curve K. If each curve on S1 which runs over the border to S2 can be continued with another curve on S2 and their order of continuity is G2 then we say both surfaces are connected with the order of continuity G2.
 If the G2-continuity is missed then we have a so called G2-error. This error is a relative error and it is calculated with the following formula. K1 may have the radius R and K2 may have the radius r at the common point, with $r < R$, then yields:

$$\text{error} = 2 * (R-r) / (R+r)$$

The maximum of this error is 2. Sometimes this error is measured in percent % then its maximum is 200%.

G3 The curve K1 and the curve K2 are connected with the order of continuity G2 in the point P. For the definition of the G3-continuity we look at the curvature hedgehog, as it can be created with the command [Porcupine Curvature Analysis](#). We look at the envelope of the curvature hedgehog. If this envelope has at the desired point G1-continuity then we say the order of continuity between both curves is G3.
 If the G3-continuity between both curves is missed, the G1-continuity of the envelope is missed, then we have a so called G3-error between both curves. This error is an absolute error, an angle, and it is measured in deg of rad and it is the G1-error of the envelope. G3-continuity between surfaces is defined on the curves between both surfaces on the same way.

Gaussian curvature The Gaussian curvature is calculated from the Max Principal and the Min Principal curvature with the following formula:

$$\text{Gauss} = \text{sig}(\text{MaxPrincCurvature}) * \text{sig}(\text{MinPrincCurvature}) * \text{sqrt}(\text{abs}(\text{MaxPrincCurvature} * \text{MinPrincCurvature}))$$

Sig is the sign (of MaxPrincCurvature and MinPrincCurvature) and can only have the value +1 or -1.

global deformation A deformation that is applied globally to a set of elements, as opposed to a deformation successively applied to different elements.

I

inflection line Curve, lying on a surface, which curvature value is 0 at each point.

isophote A line or surface on a chart forming the locus of points of equal illumination or light intensity from a given source.





M

- match curve** A curve deformed so as to connect another curve, while taking the continuity type into account.
- match surface** A surface deformed so as to connect another surface, while taking the continuity type into account.
- mesh line** A line on a surface used to deform this surface according to various laws, and types of deformation.



N

- NUPBS** A NUBS, Non Uniform B-Spline is also called NUPBS, to make it more clear that it is a polynomial curve and not a rational curve. See [NURBS](#).
- NURBS** A NURBS, Non Uniform Rational B-Spline, is a NUBS with a rational component. Rational means that the weight of the Control Points must not have the value 1. With a Rational Curve a Circle and a Hyperbola can be described exact.



R

- reflection line** A curve visualized on a surface, that reflects the light emanating from a grid of neon located above the surface.

S

- surface** In CATIA, surfaces are parameterized with the u- and v-Parameters running from 0 to 1. A surface has an order in u- and an order in v-Direction, $2 \leq \text{order} \leq 16$. The simplest surface is a 4-Point-Patch of order 2 in u-Direction and order 2 in v-Direction. A surface can have only one patch or several patches. The command Geometric Information shows you in the panel Geometric Analysis the available information. A surface can be trimmed for example by the command [Break](#). It can be untrimmed by the command [Untrim](#). A trimmed surface is called Face and contains all the information of the untrimmed surface. Because of this a command can work on the Face or on the (untrimmed) Basic Surface.



T

- topological** Concerned with relations between objects abstracted from exact quantitative measurements.
- topological operation** An operation retaining the topological properties of the element undergoing the specified transformation.
- trimmed surface** See [Surface](#).



U

- untrimmed surface** See [Surface](#).

Index



Numerics

3D Curve

Command



3-Point Patch

command



4-Point Patch

command



A

analysis



analyzing



Apply Dress-Up

command



applying



approximating



associative curve

creating



Axis System

command



B

bisecting

lines



bi-tangent and point

circles



bi-tangent and radius

circles



Blend Curve

command 

Blend Surface

command 

blending



Break

command  

breaking



C

checking connections



Circle

command 

circles



color scale



Command



command



compass



compass plane



Concatenate

command  

concatenating



Connect Checker

command 

Contact Points

command 

continuities on guides

global deformation 

Continuity

command 

continuity    

Control Points

command     

Converter Wizard

command  

converting 

copy 

copy geometric parameters

command 

corners

creating 

creating                  

circles 

circular arcs 

Current Plane Orientation

command 

curvature    

analyzing    

Curve Connect Checker

command 

curve connection

analyzing 

Curve On Surface

command 

curves

approximating 

blending 

breaking 

checking connections 

concatenating 

converting 

creating 

extending 

extrapolating 

fit 

fragmenting 

managing 

matching 

modifying 

projecting 

segmenting 

smoothing 

trimming 

curves on surface

creating 

Cutting Planes

command 

cutting planes

analysis 



D

datum

creating 

defining  

compass plane 

deforming 

Disassemble

command 

disassembling 

displaying 

distance

analysis 



Distance Analysis

command 

distance between elements















analyzing 

draft

- analyzing 
- Draft Analysis
- command 
- duplicating elements 





E

- elements
 - disassembling 
 - symmetric 
- elements by symmetry
 - creating 
- Environment Mapping
 - command 
- environment mapping
 - analysis 
- exporting 
- Extend
 - command  
- extending  
- Extrapolate
 - command 
- extrapolating  
- Extrude Surface
 - command 
- extruding 



F

- files
 - exporting 
 - importing 
- Fill
 - command  

filling  

fit  

Fit To Geometry

command  

Flip to VW or YZ

command 

Fragmentation

command  

fragmenting  

FreeStyle Optimizer 

FreeStyle Profiler 

FreeStyle Shaper 

Furtive Display

command 



G

G0

continuity 

curvature 

order of continuity 

G1

continuity 

curvature 

order of continuity 

G2

continuity 

curvature 

order of continuity 

G3

continuity 

curvature 

order of continuity 

Geometric Information

command 

geometric information

analysis 

displaying 

geometric parameters

copy 

Geometry Extraction

command 

Global Deformation

command 

global deformation   



H

High

command 

Highlight Lines

command 

highlight lines

analysis 

analyzing 

highlights

analysis 



I

importing 

Inflection Lines

command 

inflection lines

analysis 

inserting 

integration

Part Design workbench 

Interactive Viewpoint Definition

command 

inverting 

isophotes

analysis 

mapping 

Isophotes Analysis

command 



K

Keep Original

command 



L

line

command 

creating 

lines 

local axis-system

defining 

local visualization options

applying 

removing 



M

managing 

manipulating 

manipulating views     

manipulators 

mapping 

Match Curve

command 

Match Surface

command 

matching    

Medium

command 

modifying   

mono-segment surfaces

creating 

moving 

Multi-Side Match Surface

command 

multi-sides

matching 



N

Net Surface

command 

net surfaces

creating 

Next View

command  

No Attenuation

command 



O

Offset

command 

offsetting 

one guide

global deformation 

Open Body

command 

inserting 

order of continuity    

orientation

compass 



P

parameterization

analyzing 

Part Design workbench 

planar mono-patch surfaces

creating 

Planar Patch

command 

plane

command 

creating 

point

command 

creating 

point center and radius

circles 



porcupine curvature

analysis 

Porcupine Curvature Analysis

command 

Previous View

command  

Project Curve

command 

projecting 



Q

Quick Compass Orientation

command 



R

reflect curves 

Reflection Lines

command 

reflection lines

analysis 

Remove Visualization Options

command 

removing 

restoring 

Reverse Viewpoint

command 

revolution surfaces 

Revolve

command 

RI315904_V5R7SP4 

rotating    

rotation

manipulating views   

Rotation About X Screen Axis

command 

Rotation About Y Screen Axis



command 

Rotation About Z Screen Axis

command 



S

segmenting  

Select

command  

selecting 

Slow

command 

smoothing  

Snap on Cpt

command 

Snap On Edge

command 

Snap On Segment

command 

Snap On Vertex

command 

Standard View Manipulation

command 

Stretch View

command 

stretching 

Styling Corner

command 

Styling Extrapolate

command 

Styling Sweep

command 

support

selecting 

surface boundaries

modifying 

surface connection

analyzing 

surface limits

restoring 

surfaces

approximating 

blending 

breaking 

checking connections 

concatenating 

creating      

deforming 

extending 

extrapolating 

extruding 

filling  

fit 

fragmenting 

matching  

modifying 

offsetting 

segmenting 

smoothing 

swept 

surfaces by extrusion

creating 

surfaces from 3 points

creating 

surfaces from 4 points

creating 

surfaces on surface

creating 

Surfacic Curvature Analysis

command 

swept 

Symmetric

command 

symmetric 

symmetry 



T

Tensions

command 

three points

circles 

translating  

manipulating views 

trimming 

tri-tangent

circles 

two guides

global deformation 

two points

circles 

two points and radius

circles 



U

U,V Orders

command 

Untrim

command 

using

manipulators 



V

view

stretching 

viewpoint

defining 

inverting 

views

manipulating 

rotating   

translating 

zooming 



W

workbench

FreeStyle Optimizer 

FreeStyle Profiler 

FreeStyle Shaper 



Z

Zoom And Translate

command 

zooming 

manipulating views 

