

Ultrasonic Transducers

WEDGES, CABLES, TEST BLOCKS



- Contact
- Dual Element
- Angle Beam
- Shear Wave
- Delay Line
- Protected Face
- Immersion
- TOFD
- High Frequency
- Atlas European Standard

The Company

Olympus Corporation is an international company operating in industrial, medical and consumer markets, specializing in optics, electronics and precision engineering. Olympus instruments contribute to the quality of products and add to the safety of infrastructure and facilities.

Olympus is a world-leading manufacturer of innovative nondestructive testing instruments that are used in industrial and research applications ranging from aerospace, power generation, petrochemical, civil infrastructure and automotive to consumer products. Leading edge testing technologies include ultrasound, ultrasound phased array, eddy current, and eddy current array. Its products include flaw detectors, thickness gages, in-line systems, automated systems, industrial scanners, pulser-receivers, probes, transducers, and various accessories. Olympus is also a distributor of remote visual inspection instruments and high speed video cameras in the Americas.

Olympus is based in Waltham, Massachusetts, USA, the company has sales and service centers in all principal industrial locations worldwide. Visit www.olympus-ims.com for applications and sales assistance.

Panametrics® Ultrasonic Transducers

Panametrics ultrasonic transducers are available in more than 5000 variations in frequency, element diameter, and connector styles. With more than forty years of transducer experience, Olympus has developed a wide range of custom transducers for special applications in flaw detection, weld inspection, thickness gaging, and materials analysis.

The poster, titled "Understanding Ultrasonic Transducers" with the Olympus logo and tagline "Your Vision. Our Future", provides a comprehensive guide to selecting and using ultrasonic transducers. It is organized into several key sections:

- How to select frequency:** Explains the relationship between frequency and resolution, penetration, and wavelength. It includes a diagram showing how higher frequencies provide better resolution for smaller defects but have less penetration.
- Is element diameter important?:** Discusses how element diameter affects the beam diameter and resolution. It includes a diagram of a transducer element and its resulting beam profile.
- Why does bandwidth matter?:** Compares narrowband, broadband, and composite transducers. It includes graphs showing the frequency response of each type and their respective applications.
- Is wave mode important?:b> Explains the differences between longitudinal, shear, and surface waves, including their penetration and resolution characteristics.**
- What does focusing do?:** Illustrates how focusing a transducer beam can increase resolution and penetration at a specific depth.
- What effect does nearfield have?:** Discusses the nearfield (Fresnel zone) and its impact on defect detection, including a diagram of the nearfield and farfield.

On the right side of the poster, there is a "Probe Types" section with images and descriptions for:

- Dual:** Used for thickness measurements.
- Contact:** Used for surface flaw detection.
- Angle Beam:** Used for detecting defects at specific angles.
- Delay Line:** Used for high-frequency applications where a delay is needed.
- Immersion:** Used for testing in liquid environments.

The poster concludes with the website www.olympus-ims.com.

Visit www.olympus-ims.com to receive your free Ultrasonic Transducer poster.



Table of Contents

The Company	2
Panametrics® Ultrasonic Transducers	2
Transducer Selection	4
Part Number Configurations	6
Test and Documentation	7
Contact Transducers	8
Standard Contact	9
Magnetic Hold Down Contact	9
Dual Element Transducers	10
Flush Case Duals	10
Flush Case Dual Cables	10
Composite Element Flush Case Duals	10
Fingertip Duals	11
Miniature Tip Dual	11
Miniature Tip Dual Cables	11
Extended Range Duals	11
Angle Beam Transducers and Wedges	12
Miniature Screw-In Transducers	12
Short Approach Wedges	13
Miniature Screw-In Wedges for 1-5 MHz	13
Miniature Screw-In Wedges for 10 MHz Transducers	13
Accupath Wedges	13
Standard Angle Beam Transducers and Wedges	14
Integral Angle Beam Transducers	15
Shear Wave Wedges for Aluminum	15
Contoured Wedges	15
AWS Wedges and Transducers	16
Snail Wedges	16
CDS Wedges	16
Accupath Wedges	16
Normal Incidence Shear Wave Transducers	17
Direct Contact Series	17
Delay Line Series	17
Shear Wave Couplant	17
Delay Line Transducers	18
Replaceable Delay Line Options	18
Sonopen® Replaceable Delay Line Transducer	19
Permanent Delay Line Transducers with Handle Assembly	19
Protected Face Transducers	20
Standard Protected Face	20
High Temperature Delay Line Options	21
Protective Membrane Option	21
Protective Wear Cap Option	21

Immersion Transducers	22
Standard Case	22
Large Diameter Case	23
Slim Line Case	23
Pencil Case	24
Side Looking Immersion Transducers	24
Extra Miniature (XMS) Transducer	24
Accuscan Paintbrush	25
Reflector Mirrors	25
Immersion Search Tubes	25
Bubblers	26
RBS-1 Immersion Tank	26
Handheld Bubbler Transducer Assembly	26
Spot Weld Transducers	27
High Frequency Transducers	28
High Frequency Contact	28
High Frequency Standard Immersion Case	29
High Frequency SU/RM Immersion Case	29
Polymer (PVDF) Immersion Transducers	29
Dual Element Transducers for Thickness Gages	30
Gage Dual Transducers	30
Other Thickness Gage Transducers	31
Electromagnetic Acoustic Transducer (EMAT)	31
Gage Dual Cables	31
Atlas European Standard Transducers	32
Dual Element Transducers	32
Contact Transducers	32
Integral Angle Beam Transducers	33
Integral Angle Beam with Composite Elements	34
Protected Face Transducers	34
Protective Membrane Accessories	34
TOFD Transducers	35
Special Transducers	36
Low Frequency Narrowband Transducers	36
500 kHz Broadband/Highly Damped Transducers	36
Variable Angle Beam Wedge	36
Continuous High Temperature Delay Line Transducer	36
Couplants and Adaptors	37
Test Blocks	38
Calibration Blocks	38
Reference Blocks	39
Thickness Calibration Blocks	39
Cables	40
Standard	40
Heavy Duty (HD)	40
Waterproof (W)	40
Armored Stainless Steel (SSA)	40
Double Shielded (DS)	40
Cables with Handle	40
Dual	41
Heavy Duty, Armored PVC (HDAP)	41
Heavy Duty, Armored Super Flexible Silicone (HDAS)	41
Atlas	41
Ultrasonic Transducers Technical Notes	42



Transducer Selection

The transducer is one of the most critical components of any ultrasonic system. A great deal of attention should be paid to selecting the proper transducer for the application.

The performance of the system as a whole is of great importance. Variations in instrument characteristics and settings as well as material properties and coupling conditions play a major role in system performance.

We have developed three different series of transducers to respond to the need for variety. Each series has its own unique characteristics.

Transducer configuration also has an impact on system performance. Consideration should be given to the use of focused transducers, transducers with wear surfaces that are appropriate for the test material, and the choice of the appropriate frequency and element diameter.

The summaries below provide a general description of the performance characteristics of each transducer series. While these guidelines are quite useful, each application is unique and performance will be dependent on electronics, cabling, and transducer configuration, frequency, and element diameter.

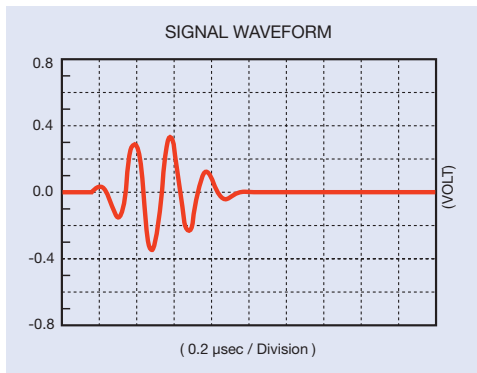

Accuscan "S"

The Accuscan S series is intended to provide excellent sensitivity in those situations where axial resolution is not of primary importance. Typically this series will have a longer wave form duration and a relatively narrow frequency bandwidth.

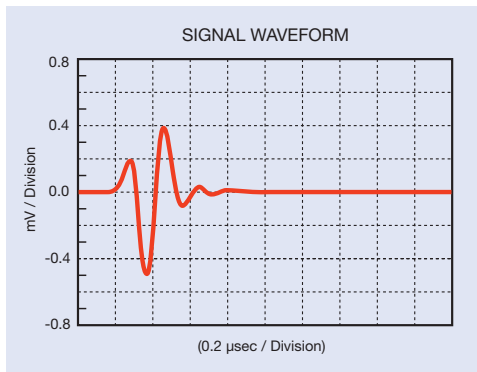
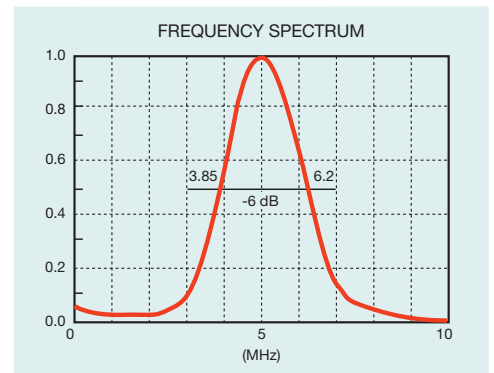

Centrascan™

The piezocomposite element Centrascan Series transducers provide excellent sensitivity with a high signal-to-noise ratio in difficult-to-penetrate materials. They have exceptional acoustic matching to plastics and other low impedance materials.

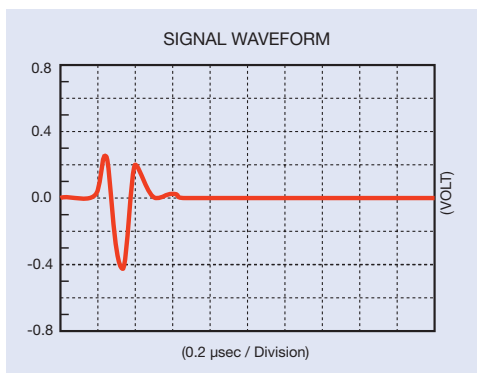
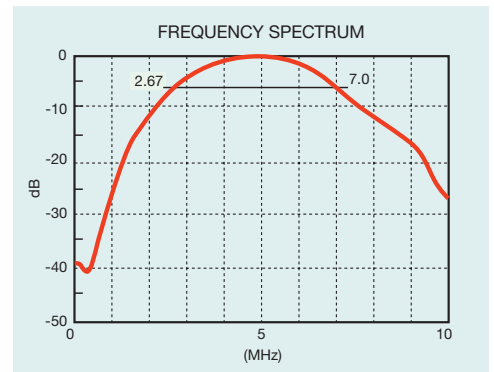

Videoscan

Videoscan transducers are untuned transducers that provide heavily damped broadband performance. They are the best choice in applications where good axial or distance resolution is necessary or in tests that require improved signal-to-noise in attenuating or scattering materials.

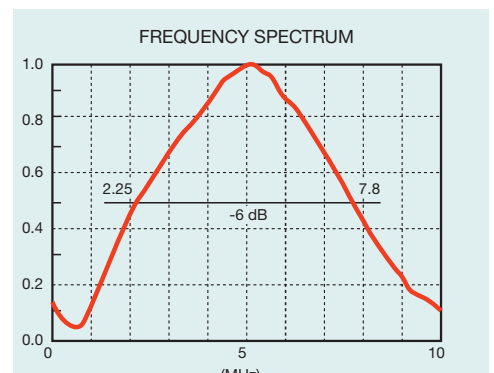

Note: For more information on bandwidth and sensitivity versus resolution, please refer to the "Ultrasonic Transducers Technical Notes" starting on page 42.
 Note: For sample test forms of transducers that you are interested in purchasing or if you have questions, please contact us via phone, or e-mail.



Contact Transducers: A contact transducer is a single element transducer, usually generating a longitudinal wave, that is intended for direct contact with a test piece. All contact transducers are equipped with a WC5 wear face that offers superior wear resistance and probe life as well as providing an excellent acoustic impedance match to most metals. Please see "Contact Transducers" on page 8 for more details on longitudinal contact probes or "Normal Incidence Shear Wave Transducers" on page 17 for information on normal incidence shear wave transducers.



Dual Element Transducers: A dual element transducer consists of two longitudinal wave crystal elements (one transmitter and one receiver) housed in the same case and isolated from one another by an acoustic barrier. The elements are angled slightly towards each other to bounce a signal off the backwall of a part in a V-shaped pattern. Dual element transducers typically offer more consistent readings on heavily corroded parts, and can also be used in high temperature environments. Please see "Dual Element Transducers" on page 10 for more information on dual element transducers for flaw detection or "Dual Element Transducers for Thickness Gages" on page 30 for dual element probes for use with Olympus corrosion gages.

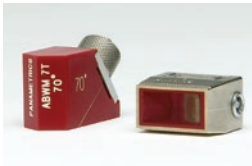

Angle Beam Transducers: Angle beam transducers are single element transducers used with a wedge to introduce longitudinal or shear wave sound into a part at a selected angle. Angle beam transducers allow inspections in areas of a part that cannot be accessed by the ultrasonic path of a normal incidence contact transducer. A common use for angle beam transducers is in weld inspection, where a weld crown blocks access to the weld zone of interest for a standard contact transducer and where typical flaw alignment produces stronger reflections from an angled beam. Please see "Angle Beam Transducers and Wedges" on page 12 for additional information on angle beam transducers and wedges. For a detailed explanation of how wedges are designed using Snell's Law please "Focal Length Variations due to Acoustic Velocity and Geometry of the Test Part" on page 49.



Delay Line Transducers: Delay line transducers are single element broadband contact transducers designed specifically to incorporate a short piece of plastic or epoxy material in front of the transducer element. Delay lines offer improved resolution of flaws very near to the surface of a part and allow thinner range and more accurate thickness measurements of materials. Delay lines can be contoured to match the surface geometry of a part and can also be used in high temperature applications. For more information on delay line transducers and delay line options, please see "Delay Line Transducers" on page 18.



Protected Face Transducers: Protected face transducers are single element longitudinal wave transducers with threaded case sleeves, which allow for a delay line, wear cap, or membrane. This makes them extremely versatile and able to cover a very wide range of applications. Protected face transducers can also be used as a direct contact transducer on lower impedance materials such as rubber or plastic for an improved acoustic impedance match. Please see "Protected Face Transducers" on page 20 for more information on protected face transducers and the options available for use with them.



Immersion Transducers: Immersion transducers are single element longitudinal wave transducers, whose wear face is impedance matched to water. Immersion transducers have sealed cases allowing them to be completely submerged under water when used with a waterproof cable. By using water as both a couplant and delay line, immersion transducers are ideal for use in scanning applications where consistent coupling to the part is essential. As an additional option, immersion transducers can also be focused to increase the sound intensity in a specific area and decrease the spot size of the sound beam. For additional information on immersion transducers and in depth explanation of focusing, please see "Immersion Transducers" on page 48.



High Frequency Transducers: High frequency transducers are either delay line or focused immersion transducers and are available in frequencies from 20 MHz to 225 MHz. High frequency delay line transducers are capable of making thickness measurements on materials as thin as 0.0004 in. (0.010 mm) (dependent on material, transducer, surface condition, temperature, and setup), while high frequency focused immersion transducers are ideal for high resolution imaging and flaw detection applications on thin, low attenuation materials such as silicon microchips. For more information on all high frequency transducers, please see "High Frequency Transducers" on page 28.

Part Number Configurations

Connector Style

RB



Right Angle BNC

SB



Straight BNC

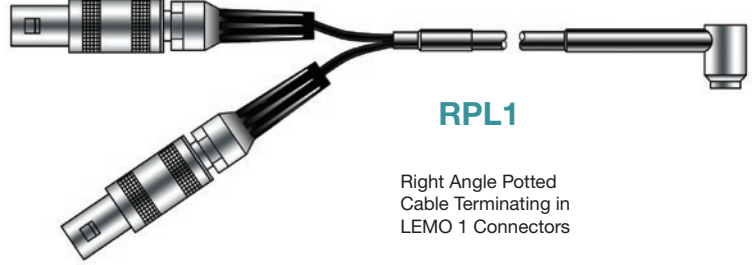

RPL1

Right Angle Potted
Cable Terminating in
LEMO 1 Connectors

RM



Right Angle
Microdot

SM



Straight
Microdot

SU



Straight UHF

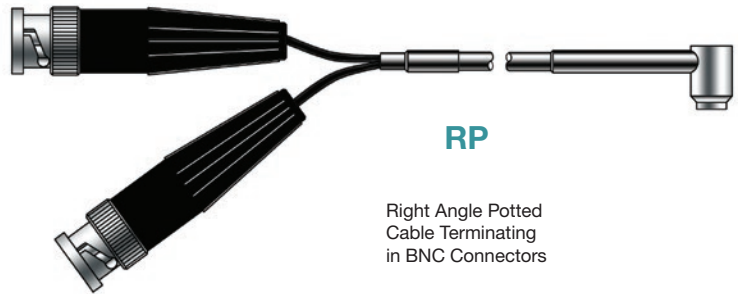

RP

Right Angle Potted
Cable Terminating
in BNC Connectors

Contoured Delays

CC-R



Concave Radius

CX-R



Convex Radius

Part number example
DLH-1-CC-R1.25IN

Contoured Wedges

AID



Axial Inside
Diameter

AOD



Axial Outside
Diameter

CID



Circumferential
Inside Diameter

COD



Circumferential
Outside Diameter

Part number example
ABWM-4T-45-COD-1.25IN

Focal Types

(Immersion Transducers)

F

Spherical Focus

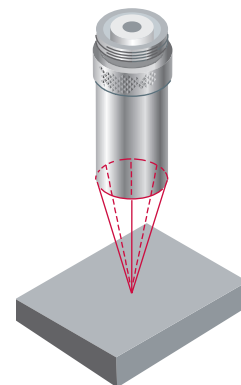

CF

Cylindrical Focus

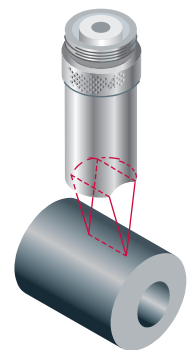

Focal Designations

FPF	Flat Plate Focus
OLF	Optical Limit Focus
PTF	Point Target Focus

Part number example
V309-SU-F1.00IN-PTF

Test and Documentation

Olympus is an active leader in the development of transducer characterization techniques and has participated in the development of the ASTM-E 1065 Standard Guide for Evaluating Characteristics of Ultrasonic Search Units. In addition, we have performed characterizations according to AWS and EN12668-2. As part of the documentation process, an extensive database containing records of the waveform and spectrum of each transducer is maintained and can be accessed for comparative or statistical studies of transducer characteristics. Our test lab offers a variety of documentation services including waveform and spectrum analysis, axial and transverse beam profiles, and electrical impedance plots. Please consult us concerning special testing requirements.

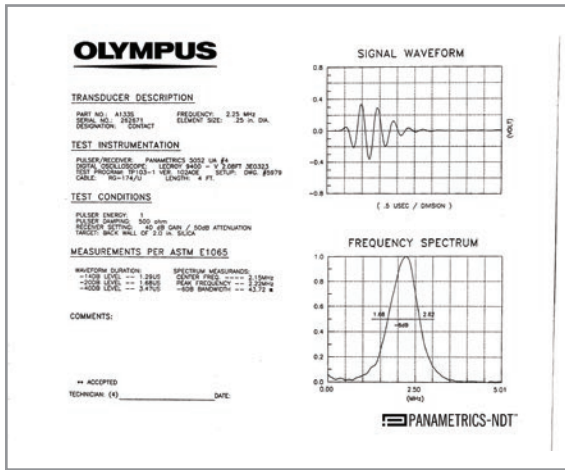

Standard Test Forms (TP103)

TP103, or standard test form, records the actual RF waveform and frequency spectrum for each transducer. Each test form has measurements of the peak and center frequencies, upper and lower -6 dB frequencies, bandwidth, and waveform duration according to ASTM-E 1065. The TP103 test form is included at no extra charge on all types of Accuscan, Centrascan, and Videoscanner transducers.

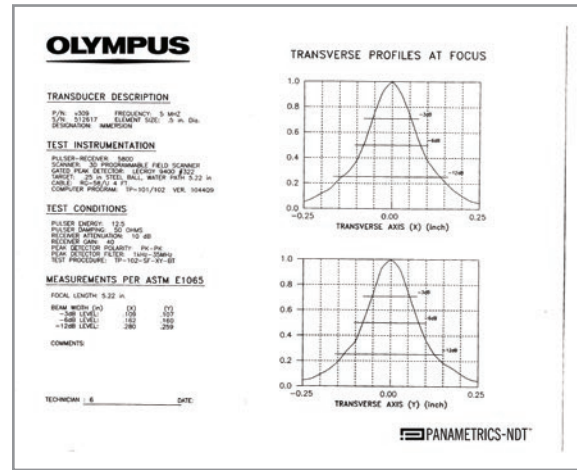

Beam Profiles (TP102)

TP102, or transverse beam profile, is created by recording the amplitude of the sound field as the transducer is moved across a ball target in a plane parallel to the transducer face. This is done at a set distance from the transducer, typically at the near field or focal length distance, and in both X and Y axes. It can be generated from any type of immersion transducer.

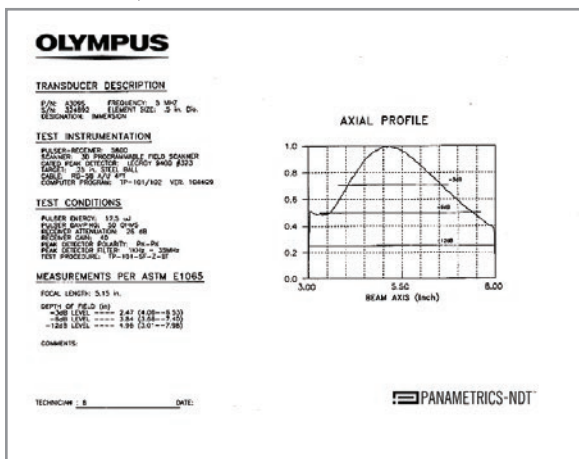

Beam Profiles (TP101)

TP101, or axial beam profile, is created by recording the amplitude of the sound field as a function of distance from the transducer face along the acoustic axis. This provides information on the depth of field, near field, or focal length of the probe. It can be generated from any type of immersion transducer.

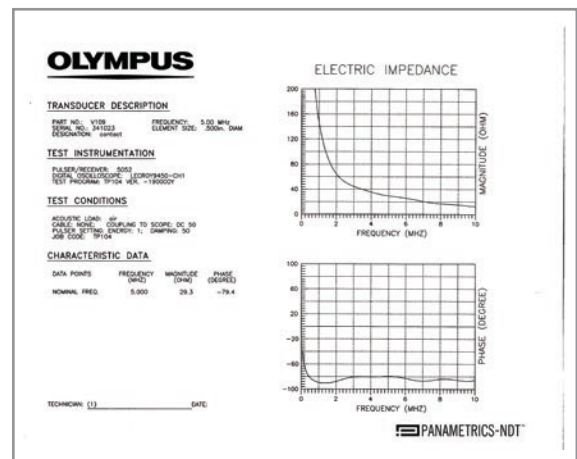

Electrical Impedance Plots (TP104)

TP104, or electrical impedance plot, provides information on the electrical characteristics of a transducer and how it loads a pulser. The TP104 displays the impedance magnitude versus frequency and the phase angle versus frequency. It can be generated from most types of transducers.

Contact Transducers

A contact transducer is a single element longitudinal wave transducer intended for use in direct contact with a test piece.

Advantages

- Proprietary WC-5 wear plate increases durability, fracture resistance, and wear resistance
- All styles are designed for use in rugged industrial environments
- Close acoustic impedance matching to most metals
- Can be used to test a wide variety of materials

Applications

- Straight beam flaw detection and thickness gaging
- Detection and sizing of delaminations
- Material characterization and sound velocity measurements
- Inspection of plates, billets, bars, forgings, castings, extrusions, and a wide variety of other metallic and non-metallic components
- For continuous use on materials up to 122 °F (50 °C)

Fingertip Contact

- Units larger than 0.25 in. (6 mm) are knurled for easier grip
- 303 stainless steel case
- Low profile for difficult-to-access surfaces
- Standard configuration is Right Angle and fits Microdot connector



Freq	Nominal Element Size		Transducer Part Numbers		
	MHz	in.	mm	ACCUSCAN-S	CENTRASCAN
0.5	1.00	25	A101S-RM	—	V101-RM
	1.00	25	A102S-RM	—	V102-RM
1.0	0.75	19	A114S-RM	—	V114-RM
	0.50	13	A103S-RM	—	V103-RM
2.25	1.00	25	A104S-RM	—	V104-RM
	0.75	19	A105S-RM	—	V105-RM
	0.50	13	A106S-RM	C106-RM	V106-RM
3.5	0.375	10	A125S-RM	C125-RM	V125-RM
	0.25	6	A133S-RM	C133-RM	V133-RM
	1.00	25	A180S-RM	—	—
5.0	0.75	19	A181S-RM	—	V181-RM
	0.5	13	A182S-RM	—	V182-RM
	0.375	10	A183S-RM	—	V183-RM
	0.25	6	A184S-RM	—	—
7.5	1.00	25	A107S-RM	—	V107-RM
	0.75	19	A108S-RM	—	V108-RM
	0.50	13	A109S-RM	C109-RM	V109-RM
	0.375	10	A126S-RM	C126-RM	V126-RM
	0.25	6	A110S-RM	C110-RM	V110-RM
10	0.125	3	—	—	V1091
	0.50	13	A120S-RM	—	—
	0.375	10	A122S-RM	—	V122-RM
15	0.25	6	A121S-RM	—	V121-RM
	0.50	13	A111S-RM	—	V111-RM
	0.375	10	A127S-RM	—	V127-RM
	0.25	6	A112S-RM	—	V112-RM
20	0.125	3	—	—	V129-RM
	0.25	6	A113S-RM	—	V113-RM
20	0.125	3	—	—	V116-RM

Transducer Dimensions (in inches)		
Nominal Element Size	(A)	(B)
1.00	1.25	0.63
0.75	1.00	0.63
0.50	0.70	0.63
0.375	0.53	0.50
0.25	0.35	0.42
0.125	0.25	0.38

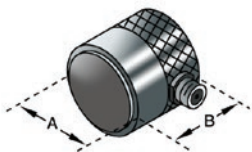

Standard Contact

- Comfort Fit sleeves designed to be easily held and to provide a steady grip while wearing gloves
- 303 stainless steel case
- Large element diameters for increased sound energy and greater coverage
- Standard connector style is Right Angle BNC (RB), may be available in a Straight BNC (SB)



Frequency	Nominal Element Size		Transducer Part Numbers			
	MHz	in.	mm	ACCUSCAN-S		VIDEOSCAN
0.1	1.50	38	—	—	V1011	
0.25	1.50	38	—	—	V1012	
0.5	1.5	38	A189S-RB	—	V189-RB	
	1.125	29	A191S-RB	—	V191-RB	
	1.00	25	A101S-RB	—	V101-RB	
1.0	1.50	38	A192S-RB	—	V192-RB	
	1.125	29	A194S-RB	—	V194-RB	
	1.00	25	A102S-RB	—	V102-RB	
	0.75	19	A114S-RB	—	V114-RB	CENTRASCAN
	0.50	13	A103S-RB	—	V103-RB	C103-SB
2.25	1.5	38	A195S-RB	—	V195-RB	
	1.125	29	A197S-RB	—	V197-RB	
	1.00	25	A104S-RB	—	V104-RB	
	0.75	19	A105S-RB	—	V105-RB	
	0.50	13	A106S-RB	—	V106-RB	
	0.25 × 1	6 × 25	A188S-RB*	—	—	
3.5	1.00	25	A180S-RB	—	V180-RB	
	0.75	19	A181S-RB	—	V181-RB	
	0.50	13	A182S-RB	—	V182-RB	
5.0	1.00	25	A107S-RB	—	V107-RB	
	0.75	19	A108S-RB	—	V108-RB	
	0.50	13	A109S-RB	—	V109-RB	
7.5	0.50	13	A120S-RB	—	V120-RB	
10	0.50	13	A111S-RB	—	V111-RB	

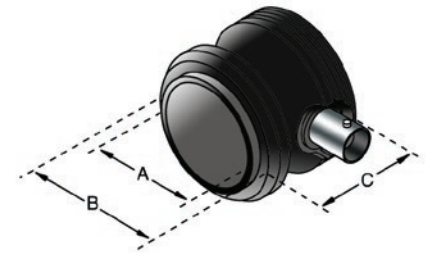

Transducer Dimensions (in inches)			
Nominal Element Size	(A)	(B)	(C)
1.50	1.75	2.23	1.25
1.50*	1.75	2.50	2.50
1.125	1.38	1.79	1.25
1.00	1.25	1.60	1.25
0.25 × 1.00	1.25	1.60	1.25
0.75	1.00	1.37	1.25
0.50	0.63	1.16	1.25

*V1011 and V1012 housed in different case.

*Per ASTM Standard A-418

Magnetic Hold Down Contact

- Magnetic ring around transducer case for stationary positioning on ferrous materials
- Broadband performance similar to Videoscan series

Frequency	Nominal Element Size		Part Number
	MHz	in.	
5.0	0.5	13	M1042
	0.25	6	M1057
	0.25	6	M1054
15	0.25	6	M1055

Note: All above magnetic hold down transducers have straight Microdot connectors.

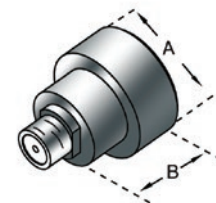

Transducer Dimensions (in inches)		
Nominal Element Size	(A)	(B)
0.50	0.81	0.63
0.25	0.50	0.42

Dual Element Transducers

A dual element transducer consists of two crystal elements housed in the same case, separated by an acoustic barrier. One element transmits longitudinal waves, and the other element acts as a receiver.

For information on transducers for corrosion applications, see "Dual Element Transducers for Thickness Gages" starting on page 30.

Advantages

- Improves near surface resolution
- Eliminates delay line multiples for high temperature applications
- Couples well on rough or curved surfaces
- Reduces direct back-scattering noise in coarse grained or scattering materials
- Combines penetration capabilities of a lower frequency single element transducer with the near surface resolution capabilities of a higher frequency single element transducer
- Can be contoured to conform to curved parts

Applications

- Remaining wall thickness measurement
- Corrosion/erosion monitoring
- Weld overlay and cladding bond/disbond inspection
- Detection of porosity, inclusions, cracks, and laminations in castings and forgings
- Crack detection in bolts or other cylindrical objects
- Maximum temperature capability is 800 °F (425 °C) for 5.0 MHz and below; 350 °F (175 °C) for 7.5 MHz and 10 MHz. Recommended duty cycle for surface temperatures from 200 °F (90 °C) to 800 °F (425 °C) is ten seconds maximum contact followed by a minimum of one minute air cooling (does not apply to Miniature Tip Dual)

Flush Case Duals

- Metal wear ring extends transducer life
- Wear indicator references when transducer face needs resurfacing
- Knurled, 303 stainless steel case
- Replaceable cable design (special dual cables with strain relief available)

Frequency MHz	Nominal Element Size		Transducer Part Numbers
	in.	mm	
1.0	0.50	13	DHC703-RM
2.25	0.50	13	DHC706-RM
	0.25	6	DHC785-RM
5.0	0.50	13	DHC709-RM
	0.25	6	DHC711-RM
10	0.25	6	DHC713-RM

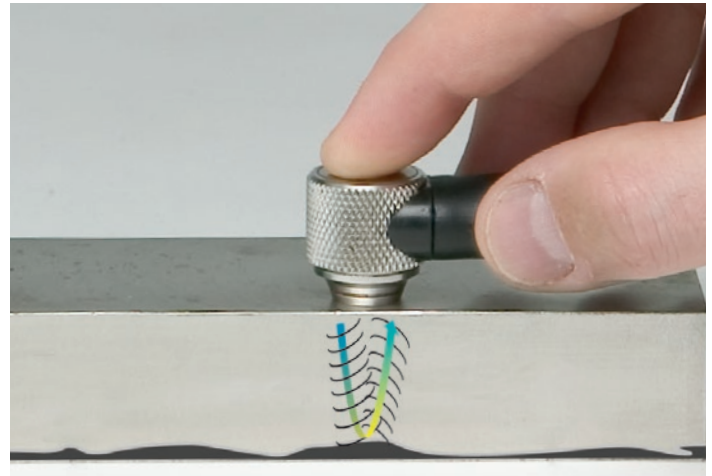

Two angled elements create a V-shaped sound path in the test material. This pseudo-focus enhances resolution in the focal zone.

Flush Case Dual Cables

Cable Part Number	Fits Connector Style
BCMD-316-5F	Dual BNC to Microdot
L1CMD-316-5F	Dual Large LEMO 1 to Microdot
LCMD-316-5F	Dual Small LEMO 00 to Microdot



Composite Element Flush Case Duals

Frequency MHz	Nominal Element Size		Transducer Part Number
	in.	mm	
2.25	0.50	13	CHC706-RM

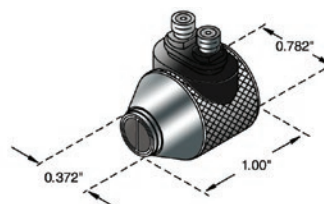

0.25 in. Element size



0.50 in. Element Size

Fingertip Duals

- Knurled case, except the 0.25 in. (6 mm) element size
- High-strength flexible 6 ft (1.8 m) potted cable (fits BNC or Large LEMO 1 connectors)

Frequency MHz	Nominal Element Size		Transducer Part Numbers	
	in.	mm	Fits BNC Connector	Fits Large LEMO Connector
1.0	0.75	19	D714-RP	D714-RPL1
	0.50	13	D703-RP	D703-RPL1
2.25	0.75	19	D705-RP	D705-RPL1
	0.50	13	D706-RP	D706-RPL1
	0.375	10	D771-RP	D771-RPL1
	0.25	6	D785-RP	D785-RPL1
3.5	0.75	19	D781-RP	D781-RPL1
	0.50	13	D782-RP	D782-RPL1
	0.375	10	D783-RP	D783-RPL1
	0.25	6	D784-RP	D784-RPL1
5.0	0.75	19	D708-RP	D708-RPL1
	0.50	13	D709-RP	D709-RPL1
	0.375	10	D710-RP	D710-RPL1
	0.25	6	D711-RP	D711-RPL1
7.5	0.50	13	D720-RP	D720-RPL1
	0.25	6	D721-RP	D721-RPL1
10	0.50	13	D712-RP	D712-RPL1
	0.25	6	D713-RP	D713-RPL1

Miniature Tip Dual

- Provides better coupling on curved surfaces
- Low profile allows for better access in areas of limited space
- Maximum temperature capability 122 °F (50 °C)

Frequency MHz	Tip Diameter		Nominal Element Size		Transducer Part Number
	in.	mm	in.	mm	
5.0	0.20	5	0.15	3.8	MTD705

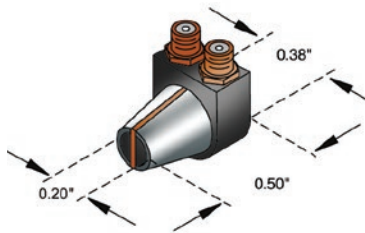

Miniature Tip Dual Cables

- Replaceable cable for all flaw detectors

Cable Part Number	Fits Connector Style
BCLPD-78-5	Dual BNC to Lepra/Con
L1CLPD-78-5	Dual Large LEMO 1 to Lepra/Con
LCLPD-78-5	Dual Small LEMO 00 to Lepra/Con

Extended Range Duals

- Shallow roof angles provide greater sensitivity to deep flaws, back walls, and other reflectors, 0.75 in. (19 mm) and beyond in steel
- Can be used for high temperature measurements when delay lines are unacceptable
- High-strength flexible 6 ft (1.8 m) potted cable with BNC connectors

Frequency MHz	Nominal Element Size		Roof Angle	Transducer Part Numbers
	in.	mm	(°)	
2.25	1.00	25	0	D7079
	0.50	13	0	D7071
	0.50	13	1.5	D7072
	0.50	13	2.6	D7074
5.0	0.50	13	3.5	D7073
	1.00	25	0	D7080
	0.50	13	0	D7075
	0.50	13	1.5	D7076
	0.50	13	2.6	D7078
	0.50	13	3.5	D7077

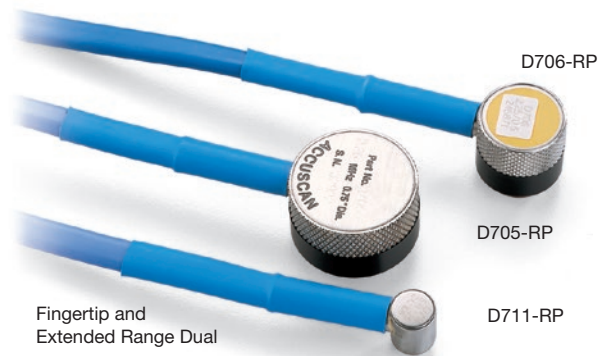

Transducer Dimensions (in inches)

Nominal Element Size	(A)	(B)	(C)
1.00*	1.25	0.75	1.00
0.75	1.00	0.75	0.75
0.50	0.70	0.75	0.50
0.50*	0.70	0.63	0.61
0.375	0.53	0.62	0.375
0.25	0.35	0.54	0.25

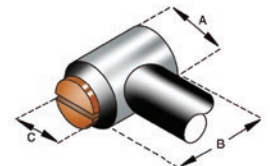

* Extended Range Duals



Miniature Tip Dual

Angle Beam Transducers and Wedges

Angle beam transducers are single element transducers used with a wedge to introduce a refracted shear wave or longitudinal wave into a test piece.

Advantages

- Three-material design of our Accupath wedges improves signal-to-noise characteristics while providing excellent wear resistance
- High temperature wedges available for in-service inspection of hot materials
- Wedges can be customized to create nonstandard refracted angles
- Available in interchangeable or integral designs
- Contouring available
- Wedges and integral designs are available with standard refracted angles in aluminum (see "Shear Wave Wedges for Aluminum" on page 15).

Applications

- Flaw detection and sizing
- For time-of-flight diffraction transducers, see "TOFD Transducers" on page 35
- Inspection of pipes, tubes, forgings, castings, as well as machined and structural components for weld defects or cracks

Miniature Screw-In Transducers

- Screw-in design 303 stainless steel case
- Transducers are color coded by frequency
- Compatible with Short Approach, Accupath, High Temperature, and Surface Wave Wedges

Note: Miniature snap-in transducers available by request.

Nominal Element Size		Frequency MHz	Transducer Part Numbers		
in.	mm		ACCUSCAN-S	CENTRASCAN	VIDEOSCAN
0.50	13	1.0	A539S-SM	C539-SM	V539-SM
		2.25	A540S-SM	C540-SM	V540-SM
		3.5	A545S-SM	C545-SM	V545-SM
		5.0	A541S-SM	C541-SM	V541-SM
		10.0	A547S-SM	—	V547-SM
0.375	10	1.0	—	C548-SM	—
		1.5	A548S-SM	—	—
		2.25	A549S-SM	C549-SM	V549-SM
		3.5	A550S-SM	C550-SM	V550-SM
		5.0	A551S-SM	C551-SM	V551-SM
0.25	6	2.25	A542S-SM	C542-SM	V542-SM
		3.5	A546S-SM	C546-SM	V546-SM
		5.0	A543S-SM	C543-SM	V543-SM
		10	A544S-SM	C544-SM	V544-SM

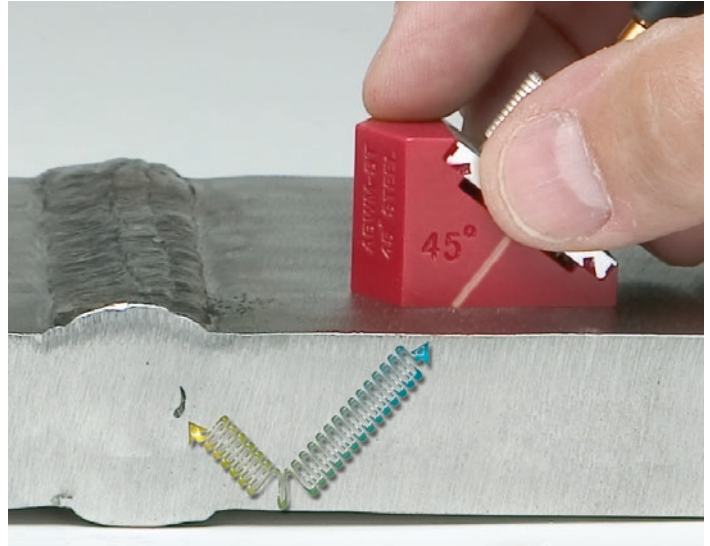

Miniature angle beam transducers and wedges are used primarily for testing of weld integrity. Their design allows them to be easily scanned back and forth and provides a short approach distance.

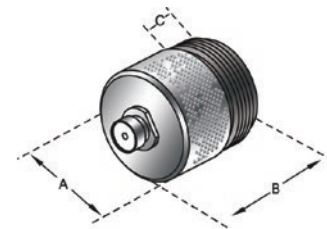

Transducer Dimensions (in inches)				
Nominal Element Size	(A)	(B)	(C)	Thread Pitch
0.50	0.71	0.685	0.257	1 1/4 - 24
0.375	0.58	0.65	0.257	9/16 - 24
0.25	0.44	0.55	0.22	3/8 - 32

Short Approach Wedges

- Smallest footprint
- Short approach distance allows for inspection closest to the weld crown



Accupath Wedges

- Small wedge footprint
- Pointed toe design allows transducer rotation even when the nose is touching a weld crown
- Special wedge design for use with 10 MHz transducer



Miniature Screw-In Wedges for 1-5 MHz

Nominal Element Size		Wedge Part Numbers					
in.	mm	Short Approach†	Accupath*	High Temp* 500 °F (260 °C)	Very High Temp* 900 °F (480 °C)	Surface Wave 90°	Scanner Compatible**
0.50	13	ABSA-5T-X°	ABWM-5T-X°	ABWHT-5T-X°	ABWVHT-5T-X°	ABWML-5T-90°	SPE3-XXS-IHC
0.375	10	ABSA-7T-X°	ABWM-7T-X°	ABWHT-7T-X°	ABWVHT-7T-X°	ABWML-7T-90°	SPE2-XXS-IHC
0.25	6	ABSA-4T-X°	ABWM-4T-X°	ABWHT-4T-X°	ABWVHT-4T-X°	ABWML-4T-90°	SPE1-XXS-IHC

† Short Approach Wedges are available in standard refracted shear wave angles of 45°, 60°, and 70° in steel at 5.0 MHz.

*Accupath Wedges are available in standard refracted shear wave angles of 30°, 45°, 60°, and 70° in steel at 5.0 MHz.

**SPE Wedges are available in standard refracted shear wave angles of 45°, 60°, and 70° in steel

Miniature Screw-In Wedges for 10 MHz Transducers

Nominal Element Size		Wedge Part Numbers		
in.	mm	Accupath*	Surface Wave 90°	Scanner Compatible**
0.50	13	ABWM-5ST-X°	ABWML-5ST-90°	SPE3-XXS-IHC
0.375	10	ABWM-7ST-X°	ABWML-7ST-90°	SPE2-XXS-IHC
0.25	6	ABWM-4ST-X°	ABWML-4ST-90°	SPE1-XXS-IHC

*Accupath Wedges are available in standard refracted shear wave angles of 30°, 45°, 60°, and 70° in steel at 10 MHz.

**SPE Wedges are available in standard refracted shear wave angles of 45°, 60°, and 70° in steel

Short Approach Wedge Dimensions (Miniature Screw-in)
Fits Nominal Element Size (in inches)

	0.5				0.375				0.25			
	(A)	(B)	(C)	(D)	(A)	(B)	(C)	(D)	(A)	(B)	(C)	(D)
45°	0.70	1.03	0.73	0.38	0.60	0.85	0.61	0.32	0.43	0.61	0.43	0.235
60°	0.74	1.19	0.73	0.45	0.67	1.00	0.61	0.367	0.48	0.71	0.43	0.268
70°	0.79	1.34	0.73	0.50	0.69	1.12	0.61	0.406	0.50	0.81	0.43	0.305

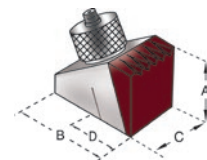

Accupath and Surface Wave Wedge Dimensions* (Miniature Screw-in)
Fits Nominal Element Size (in inches)

	0.5				0.375				0.25			
	(A)	(B)	(C)	(D)	(A)	(B)	(C)	(D)	(A)	(B)	(C)	(D)
30°	0.72	1.22	0.77	0.54	0.62	1.03	0.65	0.42	0.49	0.66	0.45	0.23
45°	0.85	1.31	0.77	0.49	0.76	1.14	0.65	0.41	0.53	0.74	0.45	0.24
60°	1.00	1.66	0.77	0.66	0.87	1.41	0.65	0.52	0.63	0.95	0.45	0.32
70°	1.00	1.82	0.77	0.73	0.92	1.52	0.65	0.51	0.66	1.08	0.45	0.36
90°	1.25	1.84	0.77	—	1.00	1.48	0.65	—	0.83	1.13	0.45	—

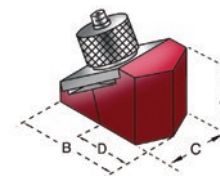

*Wedge dimensions for 10 MHz transducers are slightly different; please consult us for details.

Standard Angle Beam Transducers and Wedges

- Large element size allows for inspection of thicker components and provides a large scanning index
- Transducers available in Accuscan-S, Centrascan, and Videoscan Series
- Accupath and high temperature style wedges available
- Threaded brass screw receptacles ensure firm anchoring of the transducer onto the wedge.
- Available in frequencies as low as 0.5 MHz and 1.0 MHz
- Captive screws included with the transducer

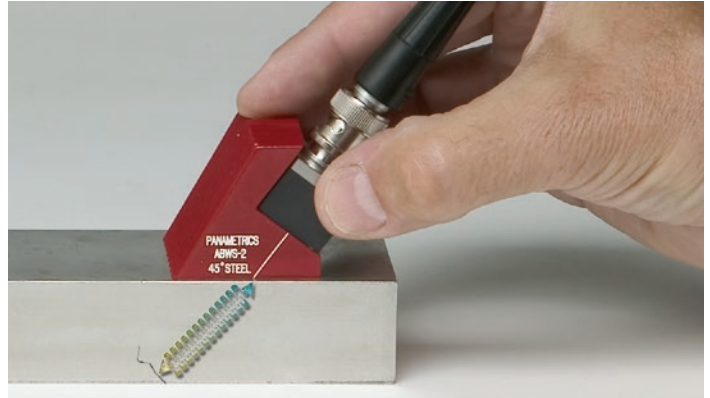

Standard Angle Beam transducers and wedges offer a large scanning index, which allows for a shorter scan time on larger test surfaces.

Nominal Element Size		Frequency MHz	Transducer Part Numbers			Wedge Part Numbers			
in.	mm		ACCUSCAN-S	CENTRASCAN	VIDEOSCAN	Accupath*	High Temp* 500 °F (260 °C)	Very High Temp* 900 °F (480 °C)	Surface Wave 90°
1.00	25	0.5	A414S-SB	—	V414-SB	ABWS-3-X°	ABWHT-3-X°	ABWVHT-3-X°	ABWSL-3-90°
		1.0	A407S-SB	C407-SM	V407-SB				
		2.25	A408S-SB	C408-SB	V408-SB				
		3.5	A411S-SB	C411-SB	—				
		5.0	A409S-SB	—	V409-SB				
0.50 × 1.00	13 × 25	0.5	A413S-SB	—	V413-SB	ABWS-2-X°	ABWHT-2-X°	ABWVHT-2-X°	ABWSL-2-90°
		1.0	A401S-SB	C401-SB	V401-SB				
		2.25	A403S-SB	C403-SB	V403-SB				
		3.5	A412S-SB	C412-SB	—				
		5.0	A405S-SB	C405-SB	V405-SB				
0.50	13	1.0	A402S-SB	C402-SB	V402-SB	ABWS-1-X°	ABWHT-1-X°	ABWVHT-1-X°	ABWSL-1-90°
		2.25	A404S-SB	C404-SB	V404-SB				
		3.5	A415S-SB	C415-SB	—				
		5.0	A406S-SB	C406-SB	V406-SB				

*Wedges are available in standard refracted shear wave angles of 30°, 45°, 60°, and 70° in steel at 5.0 MHz.

Accupath and Surface Wave Wedge Dimensions (Standard)
Nominal Element Size (in inches)

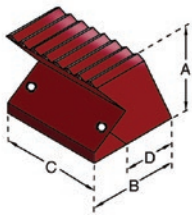

Dimension A = Wedge Height
Dimension D = Approach Distance

	1.00				0.50 × 1.00				0.50			
	(A)	(B)	(C)	(D)	(A)	(B)	(C)	(D)	(A)	(B)	(C)	(D)
30°	1.69	2.15	1.62	1.15	1.30	1.30	1.60	0.76	1.20	1.42	1.10	0.83
45°	1.47	1.96	1.63	0.97	1.30	1.41	1.60	0.78	1.20	1.31	1.08	0.70
60°	1.50	2.18	1.63	1.00	1.30	1.50	1.60	0.67	1.20	1.48	1.08	0.68
70°	1.50	2.47	1.63	1.13	1.35	1.77	1.60	0.85	1.20	1.58	1.09	0.68
90°	1.50	2.50	1.65	0.44	1.20	1.34	1.60	—	1.20	1.34	1.00	—

ABWS-2-X°



ABWS-1-X°

ABWS-1-X°

Transducer Dimensions
(in inches)

Nominal Element Size	(A)	(B)	(C)	(D)
1.00	1.25	0.63	1.38	1.65
0.50 × 1.00	0.73	0.63	1.31	1.53
0.50	0.72	0.63	0.81	1.02

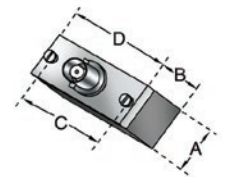

Integral Angle Beam Transducers

- Durable plastic wear surface extends transducer life and avoids scratching of critical components.
- Small approach distance and overall transducer height provides an excellent choice for limited access applications.
- Superior signal-to-noise characteristics for such small integral transducers
- Finger ring included with Micro-Miniature-RM case style transducers



A592S-SM



A592S-RM

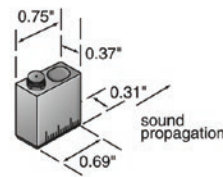

0.25 in. SM style for aluminum

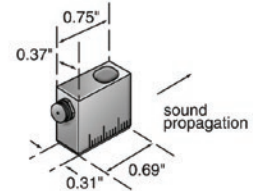

0.25 in. RM style for aluminum

Transducer Case	Nominal Element Size		Frequency MHz	Material	Connector Style	Transducer Part Numbers			
	in.	mm				45°	60°	70°	90°
Miniature	0.25 × 0.25	6 × 6	2.25	Steel	RM	A561S-RM	A562S-RM	A563S-RM	A564S-RM*
			5.0	Steel	RM	A571S-RM	A572S-RM	A573S-RM	A574S-RM*
			5.0	Aluminum	RM or SM	A591S	A592S	A593S	see note*
Micro-Miniature	0.187 × 0.187	5 × 5	2.25	Steel	RM	A5050	—	—	A5053*
			5.0	Steel	RM	A5020	A5023	A5021	—
			5.0	Steel	SM	A5015	A5014	A5013	—
			5.0	Aluminum	SM	A5067	A5068	A5069	see note*
			10	Steel	SM	—	—	A5054	—

*A564S-RM, A574S-RM, and A5053 create surface waves in steel and aluminum.

0.187 in., RM Style

A5023

0.187 in., SM Style

A5014

0.25 in., RM Style for Steel

A564S-RM

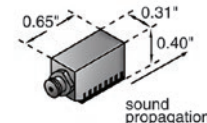
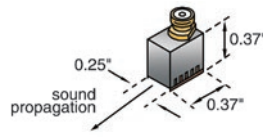
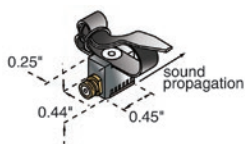

Shear Wave Wedges for Aluminum

- Compatible with our Miniature Screw-In and Standard Angle Beam transducers

Transducer Case	Nominal Element Size		Wedge Part Numbers				
	in.	mm	30°	45°	60°	70°	90°
Screw-In	0.50	13	ABWM-5053T	ABWM-5027T	ABWM-5028T	ABWM-5029T	ABWML-5041T
	0.375	10	ABWM-7024T	ABWM-7025T	ABWM-7026T	ABWM-7027T	ABWML-7028T
	0.25	6	ABWM-4086T	ABWM-4087T	ABWM-4088T	ABWM-4089T	ABWML-4074T
Standard	1.00	25	ABWS-3028	ABWS-3016	ABWS-3029	ABWS-3030	ABWSL-3039
	0.50 × 1.00	13 × 25	ABWS-2021	ABWS-2022	ABWS-2023	ABWS-2024	ABWSL-2056
	0.50	13	ABWS-1033	ABWS-1034	ABWS-1035	ABWS-1036	ABWSL-1045

Contoured Wedges

- Improve coupling on curved surfaces
- When ordering, please specify wedge type, contour orientation, and contour diameter.
- Example Part #: ABWM-4T-45-COD-1.25IN

AWS Wedges and Transducers

- Transducers and wedges meet or exceed the specifications as set forth by the AWS Code Section D1.1.
- Snail wedges use industry accepted hole spacing.
- Captive screws included with the transducer
- Accupath style wedges marked with a five line graticule to assist in locating the beam exit point

Nominal Element Size	Frequency	Transducer Part Numbers		Snail Wedge Part Number*	Accupath Wedge Part Number*
		ACCUSCAN	CENTRASCAN		
in.	MHz				
0.625 × 0.625	2.25	A430S-SB	C430-SB	ABWS-8 -X°	ABWS-6-X°
0.625 × 0.75		A431S-SB	C431-SB		
0.75 × 0.75		A432S-SB	C432-SB		

* Wedges are available in standard refracted shear wave angles of 45°, 60° and 70° in steel. Please specify upon ordering.

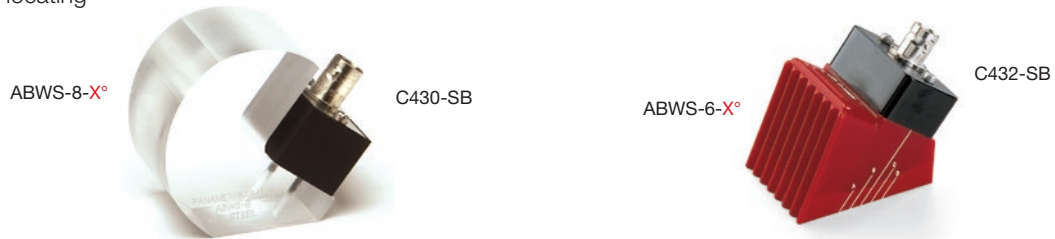

Snail Wedges

	Snail Wedge Dimensions* (in inches)			
	(A)	(B)	(C)	(D)
45°	2.15	0.62	1.78	1.25
60°	1.91	0.65	1.81	1.25
70°	2.17	0.67	1.92	1.25

*Distance between screws (center to center) is 1.00 in.

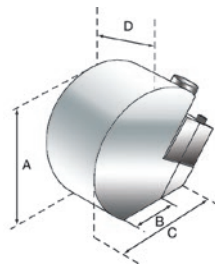

Accupath Wedges

	Accupath Wedge Dimensions* (in inches)			
	(A)	(B)	(C)	(D)
45°	1.50	0.90	1.96	1.50
60°	1.68	0.79	2.05	1.50
70°	1.66	0.96	2.20	1.50

*Distance between screws (center to center) is 1.062 in.

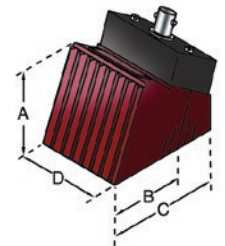

CDS Wedges

CDS Wedges are used in the "30-70-70" technique for crack detection and sizing. They are compatible with our replaceable miniature screw-in angle beam transducers, making them an economical alternative to other commercially available products. For information on transducers, see "Angle Beam Transducers and Wedges" starting on page 12.

Fits Nominal Element Size		Wedge Part Number
in.	mm	
0.25	6	CDS-4T
0.375	10	CDS-7T

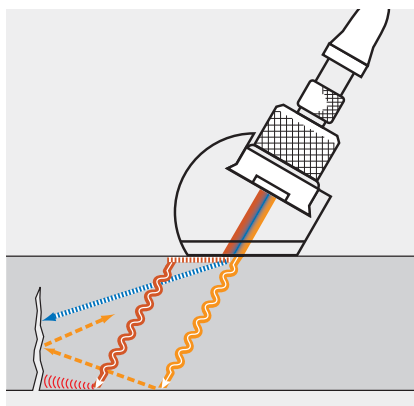

Understanding CDS

The 30-70-70 crack detection technique uses a single element transducer with a CDS wedge for detection and sizing of ID connected cracks. This technique uses a combination of three waves for sizing flaws of different depths.

- An OD creeping wave creates a 31.5 degree indirect shear (red in diagram to the left) wave, which mode converts to an ID creeping wave; this will produce a reflected signal on all ID connected cracks.
- A 30 degree shear wave (orange in diagram to the left) will reflect off the material ID at the critical angle and mode convert to a 70 degree longitudinal wave; a signal will be received by the transducer on mid-wall deep cracks.
- A 70 degree longitudinal wave (blue in diagram to the left) will reflect off the tip of a deep wall crack.

Based on the presence or absence of these three waves, both detection and sizing of ID connected cracks is possible.

Normal Incidence Shear Wave Transducers

Single element contact transducers introduce shear waves directly into the test piece without the use of refracted wave mode conversion.

Advantages

- Generate shear waves which propagate perpendicular to the test surface
- For ease of alignment, the direction of the polarization of shear wave is nominally in line with the right angle connector.
- The ratio of the longitudinal to shear wave components is generally below -30 dB.

Applications

- Shear wave velocity measurements
- Calculation of Young's Modulus of elasticity and shear modulus ("Technical Notes -Normal Incidence Shear Wave Transducers" on page 49)
- Characterization of material grain structure

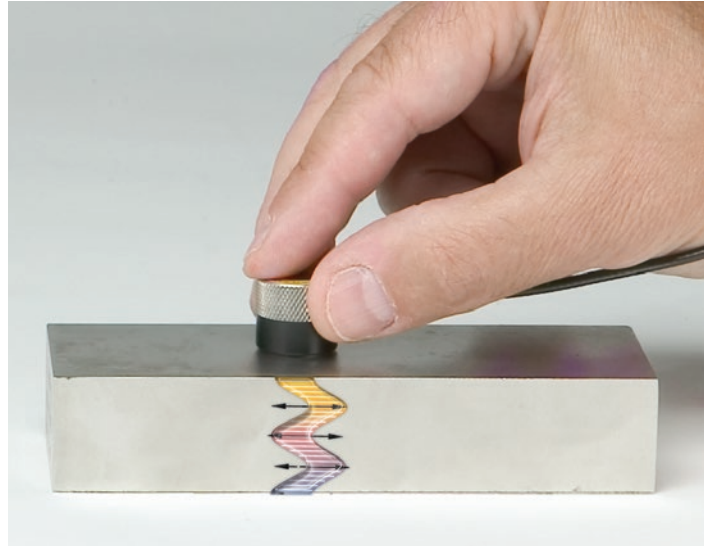

We recommend the use of our SWC shear wave couplant for general purpose testing.



Direct Contact Series

- WC-5 wear plate increases durability and wear resistance.
- Available in both the Standard and Fingertip case styles
- 303 stainless steel case

Frequency MHz	Nominal Element Size		Transducer Part Numbers	
	in.	mm	Standard Case	Fingertip Case
0.1	1.00	25	V1548	—
0.25	1.00	25	V150-RB	V150-RM
0.5	1.00	25	V151-RB	V151-RM
1.0	1.00	25	V152-RB	V152-RM
	0.50	13	V153-RB	V153-RM
2.25	0.50	13	V154-RB	V154-RM
	0.25	6	V155-RB	V155-RM
5.0	0.25	6	—	V156-RM
	0.125	3	—	V157-RM

For dimensions, see "Contact Transducers" starting on page 8.

Delay Line Series

- Integral delay line permits measurements at higher frequencies.
- Fused silica delay line minimizes attenuation and provides physical protection to the crystal element.

Frequency MHz	Nominal Element Size		Delay	Transducer Part Numbers
	in.	mm	μs.	
5.0	0.25	6	7	V220-BA-RM
10	0.25	6	7	V221-BA-RM
20	0.25	6	7	V222-BA-RM
	0.25	6	7	V222-BB-RM
	0.25	6	4	V222-BC-RM

For dimensions, see ""High Frequency Transducers" on page 28.

Shear Wave Couplant

SWC	4 oz (0.12 liter)	Normal Incidence Shear Wave, non-toxic, water soluble organic substance of very high viscosity
-----	-------------------	--

Delay Line Transducers

A replaceable delay line transducer is a single element contact transducer designed specifically for use with a replaceable delay line.

Advantages

- Heavily damped transducer combined with the use of a delay line provides excellent near surface resolution.
- Higher transducer frequency improves resolution.
- Improves the ability to measure thin materials or find small flaws while using the direct contact method
- Contouring available to fit curved parts

Applications

- Precision thickness gaging
- Straight beam flaw detection
- Inspection of parts with limited contact areas
- Replaceable Delay Line Transducers
- Each transducer comes with a standard delay line and retaining ring
- High temperature and dry couple delay lines are available
- Requires couplant between transducer and delay line tip



Frequency	Nominal Element Size		Transducer Part Numbers
	in.	mm	
2.25	0.25	6	V204-RM
5.0	0.50	13	V206-RM
	0.25	6	V201-RM
10	0.25	6	V202-RM
	0.125	3	V203-RM
15	0.25	6	V205-RM
20	0.125	3	V208-RM

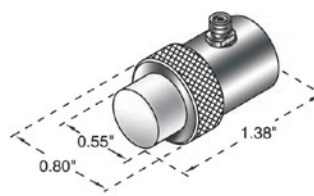
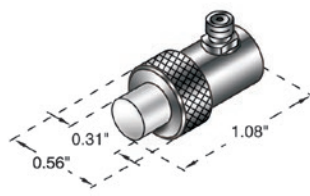
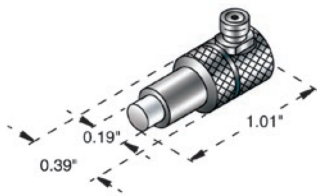

Replaceable Delay Line Options

Nominal Element Size		Standard Delay Line	High Temperature			Dry Couple Delay Line	Spare Retaining Ring	Spring Loaded Holders
			350 °F max. (175 °C)	500 °F max. (260 °C)	900 °F max. (480 °C)			
in.	mm							
0.50	13	DLH-2	DLHT-201	DLHT-2	DLHT-2G	DLS-2	DRR-2	2130
0.25	6	DLH-1	DLHT-101	DLHT-1	DLHT-1G	DLS-1	DRR-1	2127 & DRR-1H
			DLHT-301	DLHT-3	DLHT-3G	DLS-3	DRR-3	2133 & DRR-3H

DLP-301



V260-45



V260-SM



V260-RM

Sonopen® Replaceable Delay Line Transducer

- Focused replaceable delay line
- Extremely small tip diameter may improve performance on curved surfaces and small indentations.
- Handle for easier positioning of transducer head

Frequency	Nominal Element Size		Transducer Part Numbers		
	MHz	in.	mm	Straight Handle	Right Angle Handle
15	0.125	3	V260-SM	V260-RM	V260-45

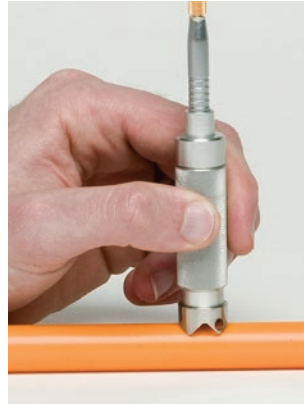

Sonopen Replaceable Delay Lines

Tip diameter		Part Number
in.	mm	
0.080	2.0	DLP-3
0.060	1.5	DLP-302
0.080	2.0	DLP-301*

* High temperature delay for use up to 350°F (175°C)

Spring Loaded Holder

SLH-V260-SM*

* For use with V260-SM only.

Permanent Delay Line Transducers with Handle Assembly

These transducers are used to reach into areas of limited access such as adjacent turbine blades. The swivel head improves contact in tight areas.

Frequency	Nominal Element Size		Delay Line Length	Transducer Part Number
	MHz	in.		
20	0.125	3	1.5	M2054
20	0.125	3	4.5	M2055
20	0.125	3	4.0	V2034

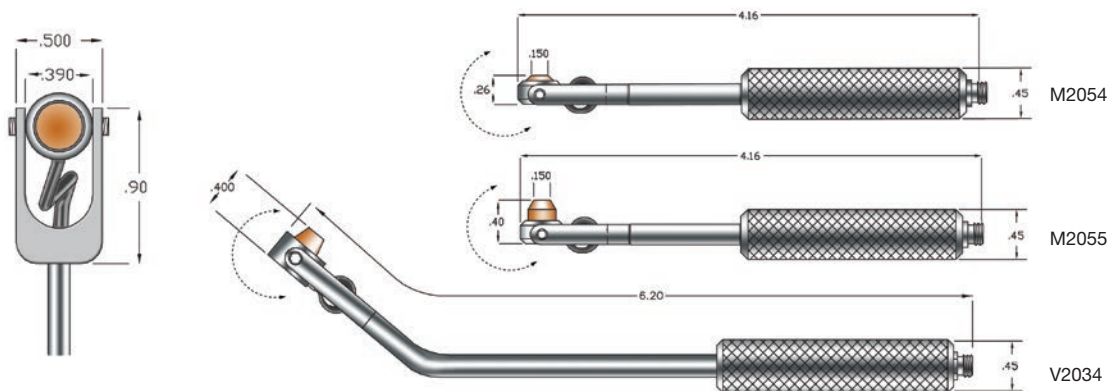

Protected Face Transducers

A protected face transducer is a single element longitudinal wave contact transducer that can be used with either a delay line, protective membrane, or protective wear cap.

Advantages

- Provides versatility by offering removable delay line, protective wear cap, and protective membrane
- When the transducer is used alone (without any of the options), the epoxy wear face provides good acoustic impedance matching into plastics, many composites, and other low impedance materials.
- Cases are threaded for easy attachment to the delay line, protective membrane, and wear cap options.

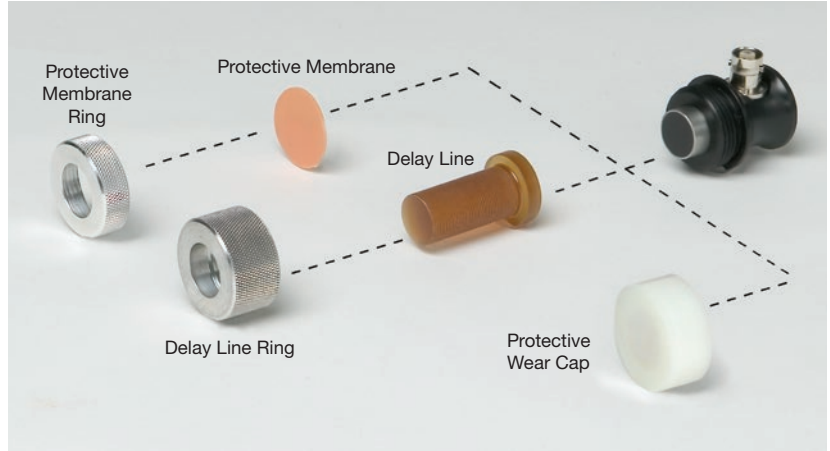

Applications

- Straight beam flaw detection
- Thickness gaging
- High temperature inspections
- Inspection of plates, billets, bars, and forgings

Standard Protected Face

- Comfort Fit sleeves are designed to be easily held and provide steady grip while wearing gloves
- Standard connector style Right Angle BNC (RB); may be available in Straight BNC (SB)
- Delay line, protective membrane, and wear cap options sold separately from the transducer



Frequency	Nominal Element Size		Transducer Part Numbers		
	in.	mm	ACCUSCAN-S	CENTRASCAN	VIDEOSCAN
0.5	1.50	38	A689S-RB	—	V689-RB
	1.125	29	A691S-RB	—	V691-RB
	1.00	25	A601S-RB	—	V601-RB
1.0	1.50	38	A692S-RB	—	V692-RB
	1.125	29	A694S-RB	—	V694-RB
	1.00	25	A602S-RB	C602-RB	V602-RB
	0.75	19	A614S-RB	—	V614-RB
	0.50	13	A603S-RB	C603-RB	V603-RB
2.25	1.50	38	A695S-RB	—	V695-RB
	1.125	29	A697S-RB	—	V697-RB
	1.00	25	A604S-RB	C604-RB	V604-RB
	0.75	19	A605S-RB	—	V605-RB
3.5	0.50	13	A606S-RB	C606-RB	V606-RB
	1.00	25	A680S-RB	—	V680-RB
	0.75	19	A681S-RB	—	V681-RB
	0.50	13	A682S-RB	—	V682-RB
5.0	1.00	25	A607S-RB	—	V607-RB
	0.75	19	A608S-RB	—	V608-RB
	0.50	13	A609S-RB	C609-RB	V609-RB
10	0.50	13	A611S-RB	—	V611-RB

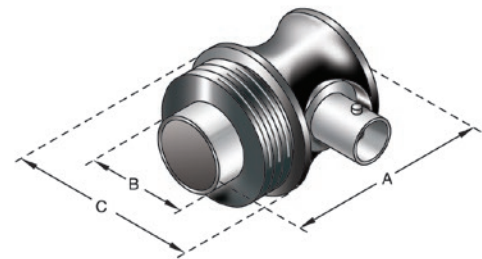

Transducer Dimensions (in inches)			
Nominal Element Size	(A)	(B)	(C)
1.50	1.53	1.75	2.25
1.125	1.53	1.38	1.81
1.00	1.53	1.25	1.63
0.75	1.53	0.99	1.41
0.50	1.53	0.63	1.19

High Temperature Delay Line Options

- Allows for intermittent contact with hot surfaces*
- Improves near surface resolution
- Contouring of delay lines provides better coupling on curved surfaces.
- Warm temperature delay lines (WTD) can be used for room temperature applications.



Nominal Element Size		Delay Line Retaining Ring	350 °F max. (175 °C)	500 °F max. (260 °C)	900 °F max. (480 °C)
in.	mm				
1.00	25	DRN-3	WTD-3-x	HTD-3-x	VHTD-3-x
0.75	19	DRN-4	WTD-4-x	HTD-4-x	VHTD-4-x
0.50	13	DRN-5	WTD-5-x	HTD-5-x	VHTD-5-x

*Recommended usage cycle is ten seconds maximum contact followed by one minute of air cooling. However, the transducer itself should not be heated above 122 °F (50 °C).

X = standard delay line lengths, available in ½ in. (13 mm), 1 in. (25 mm), 1-½ in. (38 mm). Specify at time of ordering.

Note: For the delay lines above, a room temperature material longitudinal wave velocity of 0.100 in/μsec ±0.005 in/μsec may be used as an approximation for basic calculations. This value should not be used for engineering design calculations. Contact us for details.



Protective Membrane Option

- Improves coupling on rough or uneven surfaces
- Dry couple to smooth, clean surfaces

Nominal Element Size		Membranes Only*		Membrane Retaining Ring	Kits†
in.	mm	pkg of 12	pkg of 60		
1.50	38	PM-1-12	PM-1-60	MRN-1	PMK-1
1.125	29	PM-2-12	PM-2-60	MRN-2	PMK-2
1.00	25	PM-3-12	PM-3-60	MRN-3	PMK-3
0.75	19	PM-4-12	PM-4-60	MRN-4	PMK-4
0.50	13	PM-5-12	PM-5-60	MRN-5	PMK-5

*Available in 36 in. x 36 in. x 1/32 in. sheets. Order part number NPD-665-3101.

† Kit includes 12 Membranes, 1 ring, B-2 couplant



Protective Wear Cap Option

- The nylon wear cap provides an economical solution in applications requiring scanning or scrubbing of rough surfaces

Nominal Element Size		Protective Wear Caps
in.	mm	
1.50	38	NWC-1
1.125	29	NWC-2
1.00	25	NWC-3
0.75	19	NWC-4
0.50	13	NWC-5

Immersion Transducers

An immersion transducer is a single element longitudinal wave transducer with a 1/4 wavelength layer acoustically matched to water. It is specifically designed to transmit ultrasound in applications where the test part is partially or wholly immersed

Advantages

- The immersion technique provides a means of uniform coupling.
- Quarter wavelength matching layer increases sound energy output.
- Corrosion resistant 303 stainless steel case with chrome-plated brass connectors
- Proprietary RF shielding for improved signal-to-noise characteristics in critical applications
- All immersion transducers, except paintbrush, can be focused spherically (spot) or cylindrically (line) (see "Immersion Transducers" on page 48).
- Customer specified focal length concentrates the sound beam to increase sensitivity to small reflectors.

Applications

- Automated scanning
- On-line thickness gaging
- High speed flaw detection in pipe, bar, tube, plate, and other similar components
- Time-of-flight and amplitude based imaging
- Through transmission testing
- Material analysis and velocity measurements

Usage Note: Transducers should not be submerged for periods exceeding 8 hours. Allow 16 hours of dry time to ensure the life of the unit.

Standard Case

- Knurled case with Straight UHF connector (SU)
- Contact us for nonknurled case design and availability of other connector styles.
- Frequencies ranging from 1.0 to 25 MHz

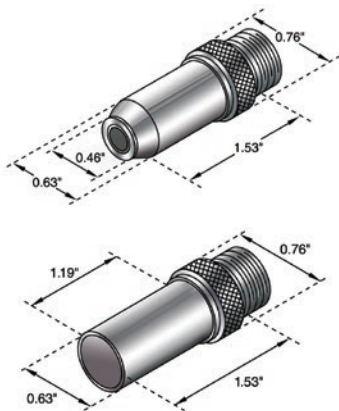

For more technical information, please refer to the following pages:
 "Focusing Configurations" on page 48
 and "Table 1 - Near Field Distance of Flat Transducers in Water" on page 51

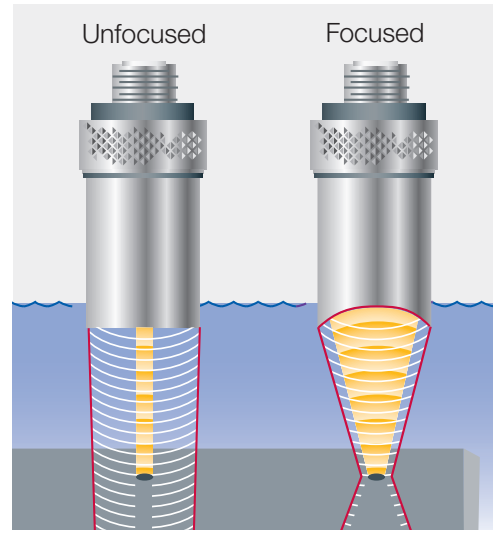

If a focus is required, select a focal length between min. and max.

Frequency MHz	Nominal Element Size		Unfocused Transducer Part Numbers			Point Target Focus (in inches)*	
	in.	mm	ACCUSCAN-S	CENTRASCAN	VIDEOSCAN	Min.	Max.
1.0	0.50	13	A303S-SU	—	V303-SU	0.60	0.80
	0.50	13	A306S-SU	C306-SU	V306-SU	0.80	1.90
2.25	0.375	10	—	C325-SU	V325-SU	0.50	1.06
	0.25	6	—	C323-SU	V323-SU	0.35	0.45
3.5	0.50	13	A382S-SU	C382-SU	V382-SU	0.83	2.95
	0.375	10	—	C383-SU	V383-SU	0.60	1.65
5.0	0.25	6	—	C384-SU	V384-SU	0.39	0.70
	0.50	13	A309S-SU	C309-SU	V309-SU	0.75	4.20
7.5	0.375	10	A326S-SU	C326-SU	V326-SU	0.60	2.35
	0.25	6	A310S-SU	C310-SU	V310-SU	0.43	1.00
10	0.50	13	A320S-SU	—	V320-SU	0.75	6.30
	0.50	13	A311S-SU	—	V311-SU	0.75	8.40
15	0.375	10	A327S-SU	—	V327-SU	0.60	4.75
	0.25	6	A312S-SU	—	V312-SU	0.46	2.10
20	0.50	13	A319S-SU	—	V319-SU	0.75	11.75
	0.375	10	—	—	V328-SU	0.60	7.10
25	0.25	6	A313S-SU	—	V313-SU	0.50	3.15
	0.125	3	—	—	V317-SU	0.50	4.20
25	0.25	6	—	—	V316-SU	0.25	1.00
25	0.25	6	—	—	V324-SU	0.50	5.25

* Please select a specific focus between min. and max.

Large Diameter Case

- Large element diameters increase near field length allowing for longer focal lengths.
- Larger diameters can increase scanning index.
- Low frequency, large element diameter designs available for challenging applications

If a focus is required, select a focal length between min. and max.

Frequency	Nominal Element Size		Unfocused Transducer Part Numbers			Point Target Focus (in inches)*	
	MHz	in.	mm	ACCUSCAN-S	CENTRASCAN	VIDEOSCAN	Min.
0.5	1.50	38	A389S-SU	—	V389-SU	2.15	3.80
	1.125	29	A391S-SU	—	V391-SU	1.50	2.10
	1.00	25	A301S-SU	—	V301-SU	1.25	1.65
	0.75	19	—	—	V318-SU	0.78	0.93
1.0	1.50	38	A392S-SU	—	V392-SU	2.50	7.56
	1.125	29	A394S-SU	—	V394-SU	1.90	4.30
	1.00	25	A302S-SU	C302-SU	V302-SU	1.63	3.38
	0.75	18	A314S-SU	—	V314-SU	1.00	1.90
2.25	1.50	38	A395S-SU	—	V395-SU	2.70	14.50
	1.125	29	A397S-SU	—	V397-SU	2.15	9.50
	1.00	25	A304S-SU	C304-SU	V304-SU	1.88	7.60
3.5	0.75	19	A305S-SU	C305-SU	V305-SU	1.00	4.30
	1.00	25	A380S-SU	C380-SU	V380-SU	1.95	11.25
	0.75	19	A381S-SU	C381-SU	V381-SU	1.00	6.65
5.0	1.00	25	A307S-SU	—	V307-SU	1.95	14.40
	0.75	19	A308S-SU	C308-SU	V308-SU	1.00	9.50
7.5	0.75	19	A321S-SU	—	V321-SU	1.00	12.75
10	1.00	25	—	—	V322-SU	2.00	20.00
	0.75	19	A315S-SU	—	V315-SU	1.00	15.37

* Please select a specific focus between min. and max.

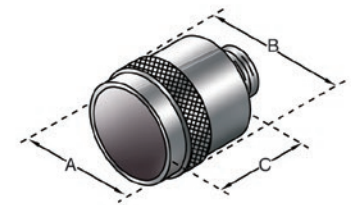

Transducer Dimensions (in inches)

Nominal Element Size	(A)	(B)	(C)
1.50	1.75	1.81	1.50
1.125	1.38	1.44	1.25
1.00	1.25	1.31	1.25
0.75	1.00	1.06	1.25

Slim Line Case

- Stainless steel case is only 0.38 in. (10 mm) in diameter, ideal for limited access areas.
- Standard configuration is Straight and fits Microdot connector style.

If a focus is required, select a focal length between min. and max.

Frequency	Nominal Element Size		Unfocused Transducer Part Numbers		Point Target Focus (in inches)*	
	MHz	in.	mm	ACCUSCAN-S	VIDEOSCAN	Min.
2.25	0.25	6	—	V323-SM	0.35	0.45
3.5	0.25	6	—	V384-SM	0.39	0.70
5.0	0.25	6	A310S-SM	V310-SM	0.43	1.00
10	0.25	6	A312S-SM	V312-SM	0.46	2.10
15	0.25	6	A313S-SM	V313-SM	0.50	3.15
20	0.25	6	—	V317-SM	0.50	4.20
	0.125	3	—	V316-SM	0.25	1.00
25	0.25	6	—	V324-SM	0.50	5.25

* Please select a specific focus between min. and max.

V312-SM

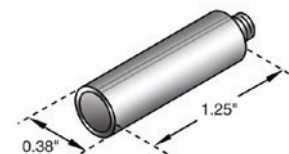

Pencil Case

- Small diameter, 2 in. (51 mm) long barrel improves access to difficult-to-reach areas.
- Standard connector style is Straight UHF (SU).

Frequency	Nominal Element Size		Unfocused Transducer Part Numbers		Point Target Focus (in inches)*	
	MHz	in.	mm	ACCUSCAN-S	VIDEOSCAN	Min.
2.25	0.25	6	—	V323-N-SU	0.35	0.45
3.5	0.25	6	—	V384-N-SU	0.30	0.70
5.0	0.25	6	A310S-N-SU	V310-N-SU	0.43	1.00
10	0.25	6	A312S-N-SU	V312-N-SU	0.46	2.10
15	0.25	6	A313S-N-SU	V313-N-SU	0.50	3.15
20	0.25	6	—	V317-N-SU	0.50	4.20
	0.125	3	—	V316-N-SU	0.25	1.00
25	0.25	6	—	V324-N-SU	0.50	5.25

* Please select a specific focus between min. and max.

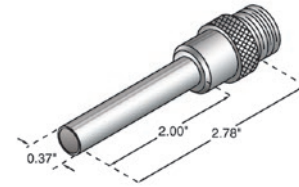

Side Looking Immersion Transducers

- Ideal for measuring wall thicknesses of pipe where access to the outer diameter is limited.
- Small outer diameter allows for greater accessibility in tight spaces than standard immersion transducers with reflector mirrors.
- Sound exit point is located at a 90° angle relative to the straight Microdot connector.
- Probe extensions such as the F211 are available to lengthen the standard design.

Part Numbers	Frequency	Nominal Element Size		Focus
		MHz	in.	
V3591	10	0.125	3	0.50 OLF
V3343	20	0.125	3	0.50 OLF

Note: All above side looking immersion transducers have straight Microdot connectors.



Extra Miniature (XMS) Transducer

The XMS transducer is an extremely small 10 MHz immersion transducer with a 3 mm (0.118 in.) diameter by 3 mm (0.118 in.) long case. This transducer is ideal for extremely tight access areas or for multi-element array flaw detection. The transducer assembly has a special connector attached to the 1 m (38 in.) long potted cable. An adaptor is also available to interface with most commercial ultrasonic equipment.

Frequency	Nominal Element Size		Part Number	Included Adapter
	MHz	in.		
10	.080	2	XMS-310-B	BNC
10	.080	2	XMS-310-L	LEMO 01



Accuscan Paintbrush

- Large scanning index is ideal for inspections of aluminum or steel plate
- Sensitivity uniformity of better than ± 1.5 dB is maintained across the transducer face (sensitivity peaks at the edges are also controlled).

Frequency	Nominal Element Size		Transducer Part Numbers
	in.	mm	
2.25	1.50 x 0.25	38 x 6	A330S-SU
3.5			A331S-SU
5.0			A332S-SU
7.5			A333S-SU
10			A334S-SU
2.25	2.00 x 0.25	51 x 6	A340S-SU
3.5			A341S-SU
5.0			A342S-SU
7.5			A343S-SU
10			A344S-SU

Note: Certification of beam uniformity is included with each transducer.

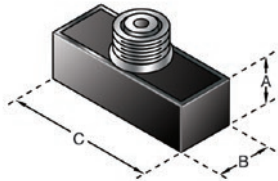

Transducer Dimensions (in inches)

Nominal Element Size	(A)	(B)	(C)
2.00 x 0.25	0.82	0.75	2.50
1.50 x 0.25	0.82	0.75	2.00

For 7.5 MHz and 10 MHz, case height (A) is 0.62 in.



A334S-SU

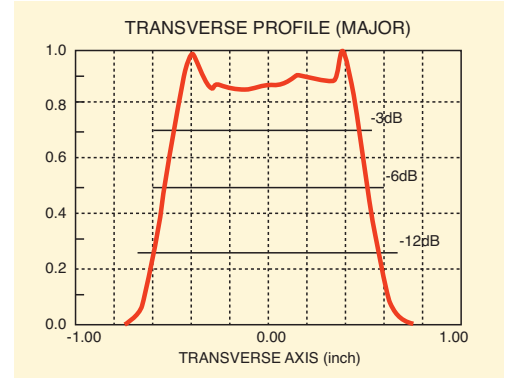

Reflector Mirrors

- Directs sound beam when a straight-on inspection is not possible
- Standard mirrors provide a 90° reflection of the sound beam.

Case Style	Incident Angle	Part Numbers
Standard	45°	F102
Slim Line	45°	F132
Pencil	45°	F198

Note: Contact us for other reflected angles.



Immersion Search Tubes

- Provides a quick and easy way to fixture and manipulate immersion transducers

Part Numbers	Length		Fits Connector Styles	Outside Diameter	
	in.	mm		in.	mm
F112	1.5	38	UHF to UHF	0.738	18.75
F113	2	51	UHF to UHF	0.738	18.75
F114	3	76	UHF to UHF	0.738	18.75
F115	6	152	UHF to UHF	0.738	18.75
F116	8	203	UHF to UHF	0.738	18.75
F117	12	305	UHF to UHF	0.738	18.75
F118	18	457	UHF to UHF	0.738	18.75
F119	24	610	UHF to UHF	0.738	18.75
F120	30	762	UHF to UHF	0.738	18.75
F211	12	305	Microdot to Microdot	0.312	7.92



Bubblers

- Allows for immersion testing when complete immersion of parts is not desirable or possible
- Designed to maintain a consistent, low volume flow of water



Part Numbers	Diameter Opening		Water Path		Case Style	Nominal Element Size		Opening Type
	in.	mm	in.	mm		in.	mm	
MPF-B-0.5	0.300	7.6	1.00	25.4	Standard SU†	0.125	3	flat
						0.25	6	flat
B103	0.350	8.9	0.775	19.9	Standard SU†	0.125	3	V-notch
						0.25	6	V-notch
B103A	0.350	8.9	0.475	12.1	Standard SU†	0.125	3	flat
						0.25	6	flat
B103W	0.550	14	0.775	19.7	Standard SU†	0.375	10	V-notch
						0.50	13	V-notch
B103AW	0.550	14	0.475	12.1	Standard SU†	0.375	10	flat
						0.50	13	flat
B116	0.100	2.5	variable, min. of:		Fits SU/RM case style*	0.125	3	flat
			0.075	1.9		0.25	6	flat
B117	1.375	34.4	1.400	35.6	Large Diameter	1.00	25.4	V-notch

* For more information on SU/RM case styles see "High Frequency SU/RM Immersion Case" on page 29.

† For more information on Standard SU case styles see ""Standard Case" on page 22.

RBS-1 Immersion Tank

RBS-1 immersion tank is designed to simplify testing measurements using immersion techniques. It consists of a clear acrylic tank, a submersible pump, and a transducer fixture in a single, portable unit. The pump feeds an adjustable stream of water to a bubbler mounted in the fixture, providing a water column to couple sound from an immersion transducer into the test piece. It is ideal for offline thickness measurements on metal, glass, and plastic products such as small containers, pipe or tubing, sheets or plates or machined parts.

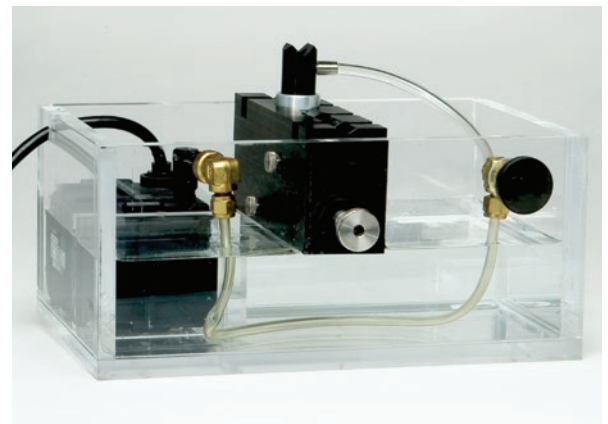

Clear Acrylic Tank

- 5.5 H × 8 W × 12 L inches (140 × 200 × 305 mm)
- 0.83 gallon (3.1 liter) capacity

Pump

- Up to 0.25 gallons (0.9 liters) per minute
- 115 or 230 V, 30 watt (voltage range 90 to 135 VAC), 50 to 60 Hz
- Submersible (ground fault interrupter circuit recommended)

Handheld Bubbler Transducer Assembly

Handheld bubbler transducers are available in either 20 MHz (V316B) or 10 MHz (V312B). They are immersion transducers that screw onto a bubbler assembly (B120) which has a replaceable stainless steel tip and a water feed tube. They offer high resolution and easy access inspection of thin materials. The V316B and bubbler combination can resolve thicknesses down to 0.008 in. (0.2 mm).

Frequency	Nominal Element Size		Focal Length		Transducer Part Number	Bubbler Assembly	Replacement Tip	Flexible Tip
	MHz	in.	mm	in.				
10	0.25	25	1.00	25	V312B-RM	B120	B120-TIP	B120-FLEX-TIP
20	0.125	3	0.75	19	V316B-RM	B120	B120-TIP	B120-FLEX-TIP



Spot Weld Transducers

A spot weld transducer is a single element delay line transducer compatible with either a hard tip delay line or captive water column specifically intended for testing the integrity of spot welds.

Advantages:

- Variety of element sizes for testing different size weld nuggets
- Compatible with either hard tip delay line or water column
- Engraved with both inches and millimeters

Applications:

- Automotive, appliances, and other critical industrial spot welds



Top Row:
Transducer, Water Column, Membranes
Bottom Row:
Transducer, Delay Line, Delay Line Retaining Ring

Select either delay line or water column. (Transducers, delay lines, delay line retaining rings, water columns, and membranes need to be ordered separately.)

Transducer Part Number	Frequency Mhz	Diameter (mm)	Diameter (in.)	Delay Line* Choose Appropriate Diameter		Delay Line Retaining Ring	Water Column Order Membranes (Below)
V2325	15	2.5	0.098	SWDL-25 (2.5 mm)	SWDL-27 (2.7 mm)	SWRR-1	DLCW-1003
V2330	15	3	0.118	SWDL-30 (3.0 mm)	SWDL-32 (3.2 mm)	SWRR-1	DLCW-1003
V2335	15	3.5	0.138	SWDL-35 (3.5 mm)	SWDL-37 (3.7 mm)	SWRR-2	DLCW-2003
V2340	15	4	0.157	SWDL-40 (4.0 mm)	SWDL-42 (4.2 mm)	SWRR-2	DLCW-2003
V2345	15	4.5	0.177	SWDL-45 (4.5 mm)	SWDL-47 (4.7 mm)	SWRR-2	DLCW-2003
V2350	15	5	0.197	SWDL-50 (5.0 mm)	SWDL-52 (5.2 mm)	SWRR-2	DLCW-2003
V2355	15	5.5	0.217	SWDL-55 (5.5 mm)	SWDL-57 (5.7 mm)	SWRR-2	DLCW-2003
V2360	15	6	0.236	SWDL-60 (6.0 mm)	SWDL-62 (6.2 mm)	SWRR-2	DLCW-2003
V2365	15	6.5	0.256	SWDL-65 (6.5 mm)	SWDL-67 (6.7 mm)	SWRR-3	DLCW-3003
V2380	15	8	0.315	SWDL-80 (8.0 mm)	SWDL-82 (8.2 mm)	SWRR-3	DLCW-3003
V2425	20	2.5	0.098	SWDL-25 (2.5 mm)	SWDL-27 (2.7 mm)	SWRR-1	DLCW-1003
V2430	20	3	0.118	SWDL-30 (3.0 mm)	SWDL-32 (3.2 mm)	SWRR-1	DLCW-1003
V2435	20	3.5	0.138	SWDL-35 (3.5 mm)	SWDL-37 (3.7 mm)	SWRR-2	DLCW-2003
V2440	20	4	0.157	SWDL-40 (4.0 mm)	SWDL-42 (4.2 mm)	SWRR-2	DLCW-2003
V2445	20	4.5	0.177	SWDL-45 (4.5 mm)	SWDL-47 (4.7 mm)	SWRR-2	DLCW-2003
V2450	20	5	0.197	SWDL-50 (5.0 mm)	SWDL-52 (5.2 mm)	SWRR-2	DLCW-2003
V2455	20	5.5	0.217	SWDL-55 (5.5 mm)	SWDL-57 (5.7 mm)	SWRR-2	DLCW-2003
V2460	20	6	0.236	SWDL-60 (6.0 mm)	SWDL-62 (6.2 mm)	SWRR-2	DLCW-2003
V2465	20	6.5	0.256	SWDL-65 (6.5 mm)	SWDL-67 (6.7 mm)	SWRR-3	DLCW-3003

Captive Water Column Membranes (includes O-Rings)

fits DLCW-1003	
Part Number	Qty./Desc.
DLCW-1003-MK25	25 Std.
DLCW-1003-MK50	50 Std.
DLCW-1003-MKX25	25 Hvy. Duty
DLCW-1003-MKX50	50 Hvy. Duty

fits DLCW-2003	
Part Number	Qty./Desc.
DLCW-2003-MK25	25 Std.
DLCW-2003-MK50	50 Std.
DLCW-2003-MKX25	25 Hvy. Duty
DLCW-2003-MKX50	50 Hvy. Duty

fits DLCW-3003	
Part Number	Qty./Desc.
DLCW-3003-MK25	25 Std.
DLCW-3003-MK50	50 Std.
DLCW-3003-MKX25	25 Hvy. Duty
DLCW-3003-MKX50	50 Hvy. Duty

High Frequency Transducers

High frequency transducers are single element contact or immersion transducers designed to produce frequencies of 20 MHz and greater.

Advantages

- Heavily damped broadband design provides excellent time resolution.
- Short wavelengths for superior flaw resolution capabilities
- Focusing allows for very small beam diameters.
- Frequencies range from 20 MHz to 225 MHz.

Applications

- High resolution flaw detection such as inspection for microporosity or microcracks
- C-scan imaging of surface breaking cracks or irregularities
- Thickness measurements of materials as thin as 0.0004 in. (0.010 mm)*
- Examination of ceramics and advanced engineering materials
- Materials analysis

*Thickness range depends on material, transducer, surface condition, temperature, and setup selected.

High Frequency Contact

- Permanent fused silica delay line allows for flaw evaluation, material analysis, or thickness measurements using a direct contact testing method.
- Three different delay line configurations (BA, BB, BC) allow for various combinations of delay line echoes.
- Standard connector style is Right Angle Microdot (RM).

Frequency MHz	Nominal Element Size		Delay µs.	Transducer Part Numbers
	in.	mm		
20	0.25	6	4.25	V212-BA-RM
	0.25	6	4.25	V212-BB-RM
	0.25	6	2.5	V212-BC-RM
30	0.25	6	4.25	V213-BA-RM
	0.25	6	4.25	V213-BB-RM
	0.25	6	2.5	V213-BC-RM
50	0.25	6	4.25	V214-BA-RM
	0.25	6	4.25	V214-BB-RM
	0.25	6	2.5	V214-BC-RM
	0.125	3	4.25	V215-BA-RM
	0.125	3	4.25	V215-BB-RM
	0.125	3	2.5	V215-BC-RM
75	0.25	6	2.5	V2022 (BC)
	0.125	3	2.5	V2025 (BC)
100	0.125	3	4.25	V2054 (BA)
	0.125	3	2.5	V2012 (BC)
125	0.125	3	2.5	V2062

Please contact us for transducers in higher frequencies.

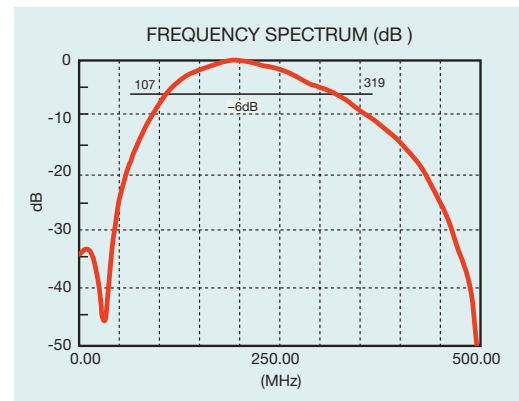
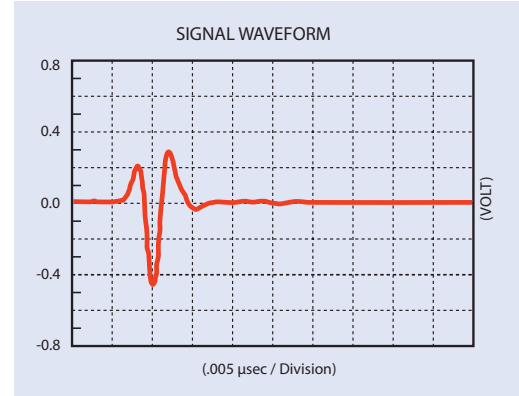

Contact transducers are available in frequencies up to 225 MHz.

Performance is dependent on pulser/receiver and application. All transducers are manufactured on a special basis to customer specifications. Contact us to discuss applications.

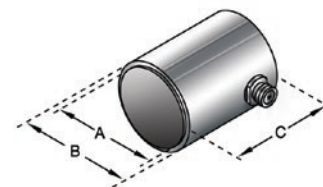
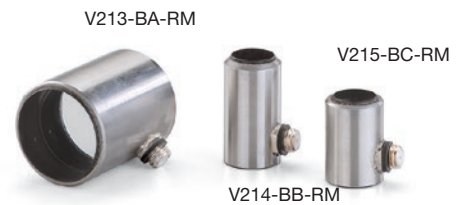

Transducer Dimensions
(in inches)

Delay Style	(A)	(B)	(C)
BA	0.72	0.81	1.00
BB	0.34	0.44	0.81
BC	0.34	0.44	0.63

High Frequency Standard Immersion Case

- Permanent fused silica delay line
- Focused units use an optical quality ground lens.
- F202 adaptor allows fixturing with a passive UHF connector and an active Microdot style connector (see "Couplants and Adaptors" on page 37).
- Combines high frequency with a small case design

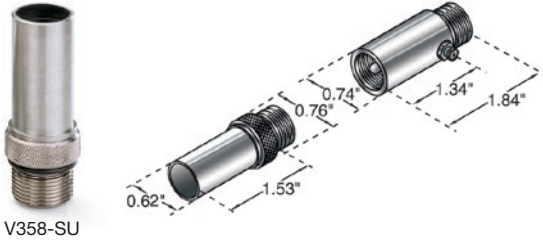

High Frequency SU/RM Immersion Case

- Permanent fused silica delay with an optical quality ground lens provides a high degree of precision in beam alignment and focusing.
- Stainless steel case has a passive Straight UHF (SU) connector and an active Right Angle Microdot (RM) connector.
- Large cases allow for larger delay lines and decrease in delay reverberations and noise.

Frequency	Nominal Element Size		Delay	Focal Length		Transducer Part Numbers
	in.	mm		in.	mm	
50	0.25	6	19.5	0.50	13	V390-SU/RM
	0.25	6	19.5	0.75	19	V3192
	0.25	6	19.5	1.00	25	V3193
	0.25	6	19.5	1.75	45	V3409
	0.25	6	19.5	2.00	51	V3337
	0.25	6	9.4	0.20	5	V3330*
	0.125	3	19.5	0.50	13	V3332
75	0.25	6	19.5	0.50	13	V3320
	0.25	6	19.5	0.75	19	V3349
90	0.25	6	19.5	0.50	13	V3512
100	0.25	6	19.5	0.50	13	V3194
	0.25	6	19.5	1.00	25	V3394
	0.25	6	9.4	0.20	5	V3534*
	0.125	3	10	0.25	6	V3346

Polymer (PVDF) Immersion Transducers



- Provides optimal impedance match to water without the use of a delay line or lens.
- No delay line echoes as seen in fused silica designs.
- Broadband performance

Frequency	Nominal Element Size		Delay	Focal Length		Transducer Part Numbers
	in.	mm		in.	mm	
20	0.25	6	4.25	flat		V354-SU
	0.25	6	2.5	0.75	19	V372-SU
	0.25	6	4.25	1.25	32	V373-SU
	0.25	6	4.25	2.00	51	V374-SU
30	0.25	6	4.25	flat		V356-SU
	0.25	6	2.25	0.75	19	V375-SU
	0.25	6	4.25	1.25	32	V376-SU
50	0.25	6	4.25	2.00	51	V377-SU
	0.25	6	4.25	flat		V358-SU

V3194 with F109 transformer



*Transducers create surface waves in steel, titanium and other materials with similar velocities. Please contact us for higher frequency. Lightweight High Frequency transducers are an alternative to the SU/RM case style transducers. They offer a smaller case width and lighter weight without sacrificing performance.

Frequency	Nominal Element Size	Part Number	Standard Focal Lengths
			in.
15	0.25	PI15-2-RX.XX*	1.00
20	0.25	PI20-2-RX.XX*	0.50, 1.00, 1.50, 2.00
35	0.25	PI35-2-RX.XX*	0.50, 0.75, 1.00, 1.50, 2.00
50	0.25	PI50-2-RX.XX*	0.50, 0.75, 1.00, 1.50, 2.00
75	0.125	PI75-1-RX.XX*	0.50, 1.00

Note: Please replace X.XX" with the standard focal length of your choice. Due to the fact that polymer transducers are inherently broadband, their center frequency may be lower than the frequency indicated on the transducer. Note: Polymer transducer center frequencies are based on the film thickness of the polymer film element. Performance is highly dependent on pulser and cable characteristics and effective center frequency may be 15% to 25% lower than the nominal value.

Dual Element Transducers for Thickness Gages

Olympus NDT offers a complete line of dual element and single element transducers for use with its corrosion thickness gages. Most of these transducers feature Automatic Probe Recognition for maximum gage performance for each transducer. These transducers are available in an assortment of frequencies, sizes, and temperature capabilities to provide an off-the-shelf solution to most corrosion applications.

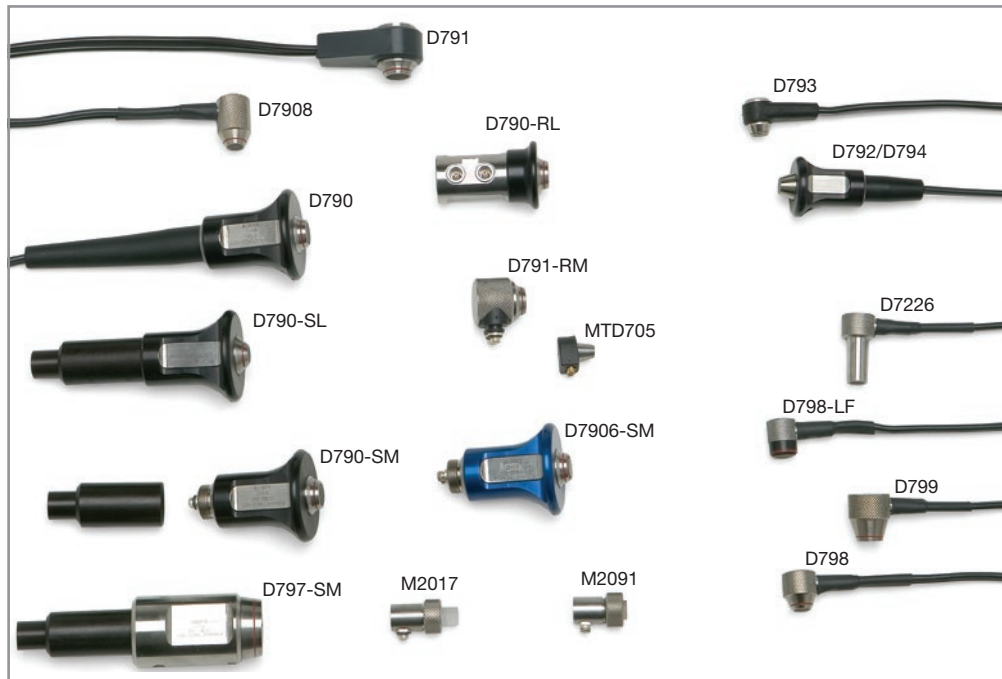

Gage Dual Transducers

Transducer Part Number	Frequency	Tip Diameter		Connector Type	Connector Location	Range in Steel		Temperature Range		Wand	Holder (w/ wand)
		MHz	in.			mm	in.	mm	°F		
D790	5.0	0.434	11	Potted	Straight	0.040 - 20	1.0 - 508	-5 to 932	-20 to 500	F152	F152A
D790-SM	5.0	0.434	11	Microdot	Straight	0.040 - 20	1.0 - 508	-5 to 932	-20 to 500	F152	F152A
D790-SL	5.0	0.434	11	LEMO 00	Straight	0.040 - 20	1.0 - 508	-5 to 932	-20 to 500	F152	F152A
D790-RL	5.0	0.434	11	LEMO 00	Rt Angle	0.040 - 20	1.0 - 508	-5 to 932	-20 to 500	—	—
D791	5.0	0.434	11	Potted	Rt Angle	0.040 - 20	1.0 - 508	-5 to 932	-20 to 500	F153	—
D791-RM	5.0	0.434	11	Microdot	Rt Angle	0.040 - 20	1.0 - 508	-5 to 752	-20 to 400	—	—
D792	10	0.283	7.2	Potted	Straight	0.020 - 1	0.5 - 25	32 to 122	0 to 50	F150	F150A
D793	10	0.283	7.2	Potted	Rt Angle	0.020 - 1	0.5 - 25	32 to 122	0 to 50	F151	—
D794	5.0	0.283	7.2	Potted	Straight	0.030 - 2	0.75 - 50	32 to 122	0 to 50	F150	F150A
D797	2.0	0.900	22.9	Potted	Rt Angle	0.150 - 25	3.8 - 635	-5 to 752	-20 to 400	—	—
D797-SM	2.0	0.900	22.9	Microdot	Straight	0.150 - 25	3.8 - 635	-5 to 752	-20 to 400	—	—
D7226	7.5	0.350	8.9	Potted	Rt Angle	0.028 - 4	0.71 - 100	-5 to 300	-20 to 150	—	—
D798-LF	7.5	0.350	8.9	Potted	Rt Angle	0.028 - 4	0.71 - 100	-5 to 300	-20 to 150	—	—
D798	7.5	0.283	7.2	Potted	Rt Angle	0.028 - 4	0.71 - 100	-5 to 300	-20 to 150	—	—
D798-SM	7.5	0.283	7.2	Microdot	Straight	0.028 - 4	0.71 - 100	-5 to 300	-20 to 150	—	—
D799	5.0	0.434	11	Potted	Rt Angle	0.040 - 20	1.0 - 508	-5 to 300	-20 to 150	—	—
D7910	5.0	0.500	12.7	Potted	Rt Angle	0.040 - 20	1.0 - 508	32 to 122	0 to 50	—	—
MTD705	5.0	0.200	5.1	Lepra/Con	Rt Angle	0.040 - 0.75	1.0 - 19	32 to 122	0 to 50	—	—

Other Thickness Gage Transducers

Transducer Part Number	Frequency	Tip Diameter		Transducer Type	Connector Type	Connector Location	Range in Steel		Temperature Range		Holder
		MHz	in.				mm	in.	mm	°F	
V260-SM	15	0.080	2	Sonopen	Microdot	Straight	0.02 - 0.400	0.5 - 10	32 to 122	0 to 50	SLH-V260-SM
V260-RM	15	0.080	2	Sonopen	Microdot	Right Angle	0.02 - 0.400	0.5 - 10	32 to 122	0 to 50	—
V260-45	15	0.080	2	Sonopen	Microdot	45° Handle	0.02 - 0.400	0.5 - 10	32 to 122	0 to 50	—
D7906-SM*	5.0	0.434	11	Thru-Coat Dual	Microdot	Straight	0.040 - 2.0	1.0 - 50	32 to 122	0 to 50	F152 / F152A
D7906-RM*	5.0	0.434	11	Thru-Coat Dual	Microdot	Right Angle	0.040 - 2.0	1.0 - 50	32 to 122	0 to 50	F152 / F152A
D7908*	7.5	0.283	7.2	Thru-Coat Dual	Potted	Potted	0.040 - 1.5	0.71 - 37	32 to 122	0 to 50	—
M2017	20	0.250	6.35	Internal Oxide Scale	Microdot	Right Angle	Steel: 0.020 - 0.50 Oxide: 0.010 - 0.050	Steel: 0.5 - 12 Oxide: 0.25 - 1.25	32 to 122	0 to 50	2127
M2091	20	0.250	6.35	Replaceable Delay Line Shear Wave	Microdot	Right Angle	Steel: 0.020 - 0.50 Oxide: 0.006 - 0.050	Steel: 0.5 - 12 Oxide: 0.150 - 1.25	32 to 122	0 to 50	2127
E110-SB†	—	1.25	28.5	EMAT	BNC	Straight	0.080 - 5	2.0 - 125	32 to 176	0 to 80	—

* Thru-Coat Transducers

† Adaptor required for E110 (part number 1/2XA/E110).

Electromagnetic Acoustic Transducer (EMAT)

Electromagnetic Acoustic Transducers are single element transducers that employ a magnetostrictive effect to transmit and receive ultrasonic waves. Part number E110-SB.

Advantages

- No need to remove external scale
- No couplant required
- Use in contact with or at a small distance from surface

Applications

- External oxide scaled surfaces
- For use with 38DL Plus thickness gage and conventional UT flaw detectors

*Temperature specification are 32°F to 140°F (0°C to 60°C) for continuous contact and 176°F (80°C) for intermittent contact, defined as 10 seconds in contact with part and 60 seconds of cooling time. **Adaptor required. Please order separately. Part number 1/2XA/E110.



Gage Dual Cables

Cable Part Number	For Use With	Length		Cable Type	Plug Type
		feet	meters		
LCMD-316-5B	D790-SM	5.0	1.5	Standard	Straight
RLCMD-316-5B	D790-SM	5.0	1.5	Standard	Rt Angle
LCMD-178-5B SSA	D790-SM	5.0	1.5	Armored	Straight
RLCMD-178-5B SSA	D790-SM	5.0	1.5	Armored	Rt Angle
LCLD-316-5G	D790-RL	5.0	1.5	Standard	Straight
LCLD-316-5H	D790-SL	5.0	1.5	Standard	Straight
LCMD-316-5C	D791-RM	5.0	1.5	Standard	Straight
LCMD-316-5D	D797-SM	5.0	1.5	Standard	Straight
LCMD-316-5J	D798-SM	5.0	1.5	Standard	Straight
LCMD-316-5L	D7906-SM	5.0	1.5	Standard	Straight
LCMD-316-5N	D7906-RM	5.0	1.5	Standard	Straight
LCLPD-78-5	MTD705	5.0	1.5	Standard	Straight
LCM-74-4	V260-SM, V260-RM, V260-45, M2017	4.0	1.2	Standard	—
LCM-188-4 SSA	V260-SM, V260-RM, V260-45, M2017	4.0	1.2	Armored	—
LCB-74-4	E110-SB	4.0	1.2	Standard	—

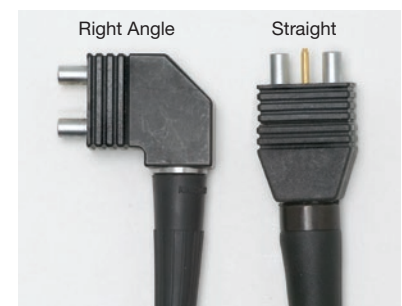

The above picture illustrates the Panametrics® RLCMD (Right Angle) and LCMD (Straight) probe recognition plugs that are compatible only with Panametrics brand thickness gages. The Probe Recognition technology automatically notifies the gage of the frequency and probe type being used. No information needs to be entered by the inspector.

Atlas European Standard Transducers

Our Atlas European Standard transducers are available in Dual Element, Angle Beam, Contact, and Protected Face styles designed to meet inspection criteria referenced throughout Europe and the rest of the world. Our Atlas transducers are available in metric unit element diameters and common frequencies, such as 1, 2, 4, 5, and 6 MHz.



Dual Element Transducers

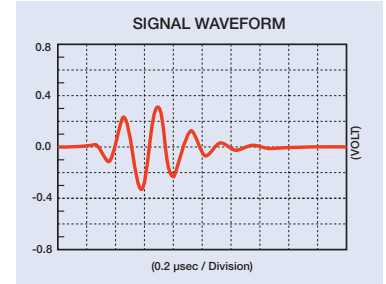
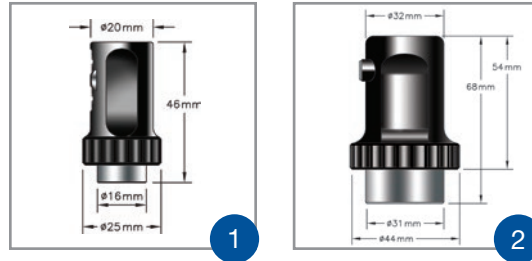

Frequency	Nominal Element Size	Transducer Part Number	Focus in Steel	Typical Bandwidth	Connector	Connector Location	Outline #
MHz	mm		mm	(%)			
2.0	7 × 18	DL2R-7X18	15	50	LEMO 00 (2)	Right Angle	2
	7 × 18	DL2R-7X18-0	30	50	LEMO 00 (2)	Right Angle	2
	11	DL2R-11	8	48	LEMO 00 (2)	Right Angle	1
4.0	3.5 × 10	DL4R-3.5X10	10	45	LEMO 00 (2)	Right Angle	1
	6 × 20	DL4R-6X20	12	48	LEMO 00 (2)	Right Angle	2
	6 × 20	DL4R-6X20-0	25	48	LEMO 00 (2)	Right Angle	2

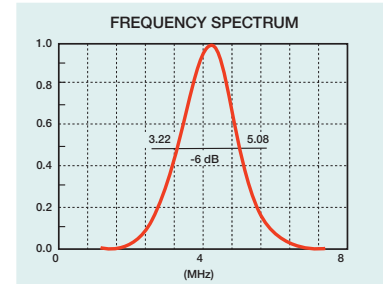

Signal waveform and frequency spectrum of DL4R-3.5X10

DGS diagrams are included with all Dual Element Transducers.

Contact Transducers

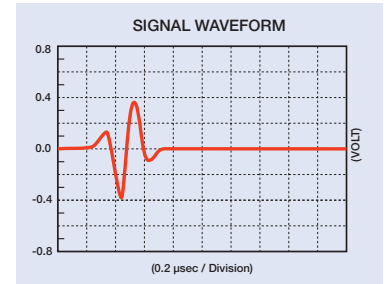
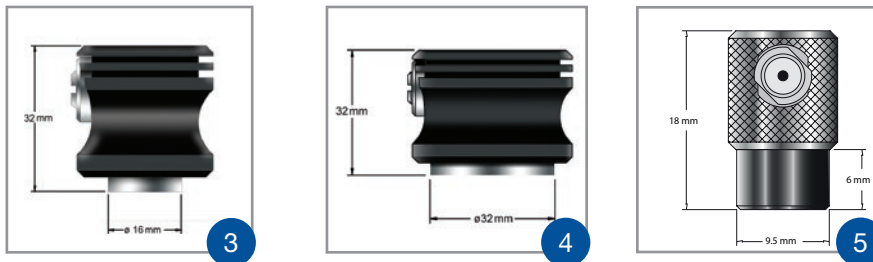

Frequency	Nominal Element Size	Transducer Part Number	Near Field	Typical Bandwidth	Connector	Connector Location	Outline #
MHz	mm		mm	(%)			
2.0	10	CN2R-10	7.2	85	LEMO 00	Right Angle	3
	24	CN2R-24	45	85	LEMO 00	Right Angle	4
4.0	10	CN4R-10	15.6	85	LEMO 00	Right Angle	3
	24	CN4R-24	91	85	LEMO 00	Right Angle	4
5.0	5	CN5R-5	127	60	Microdot	Right Angle	5
10	5	CN10R-5	254	60	Microdot	Right Angle	5

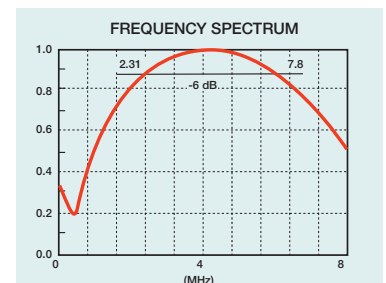

Signal waveform and frequency spectrum of CN4R-10

DGS diagrams are currently not available for Contact Transducers.

Integral Angle Beam Transducers

AM4R-8X9-70



AM 2R-8X9-45

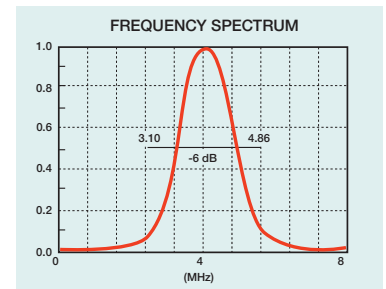
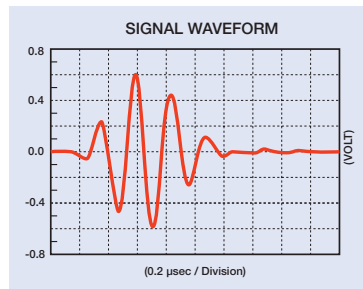

Signal waveform and frequency spectrum of AM4R-8X9-45

Frequency	Nominal Element Size	Angle	Near Field in Steel	Transducer Part Number	Typical Bandwidth	Connector	Connector Location	Outline #
MHz	mm	(°)	mm		(%)			
1.0	20 × 22	45	45	AM1R-20X22-45	55	LEMO 1	Right Angle	9
	20 × 22	60	45	AM1R-20X22-60	55	LEMO 1	Right Angle	9
	20 × 22	70	45	AM1R-20X22-70	55	LEMO 1	Right Angle	9
2.0	8 × 9	45	15	AM2R-8X9-45	40	LEMO 00	Right Angle	6
	8 × 9	45	15	AM2S-8X9-45	40	LEMO 00	Straight	7
	8 × 9	60	15	AM2R-8X9-60	40	LEMO 00	Right Angle	6
	8 × 9	60	15	AM2S-8X9-60	40	LEMO 00	Straight	7
	8 × 9	70	15	AM2R-8X9-70	40	LEMO 00	Right Angle	6
	8 × 9	70	15	AM2S-8X9-70	40	LEMO 00	Straight	7
2.0	14 × 14	45	39	AM2R-14X14-45	45	LEMO 00	Right Angle	8
	14 × 14	60	39	AM2R-14X14-60	45	LEMO 00	Right Angle	8
	14 × 14	70	39	AM2R-14X14-70	45	LEMO 00	Right Angle	5
	20 × 22	38	90	AM2R-20X22-38	40	LEMO 1	Right Angle	9
	20 × 22	45	90	AM2R-20X22-45	40	LEMO 1	Right Angle	9
	20 × 22	60	90	AM2R-20X22-60	40	LEMO 1	Right Angle	9
	20 × 22	70	90	AM2R-20X22-70	40	LEMO 1	Right Angle	9
4.0	8 × 9	38	30	AM4R-8X9-38	40	LEMO 1	Right Angle	6
	8 × 9	45	30	AM4R-8X9-45	40	LEMO 00	Right Angle	6
	8 × 9	45	30	AM4S-8X9-45	40	LEMO 00	Straight	7
	8 × 9	60	30	AM4R-8X9-60	40	LEMO 00	Right Angle	6
	8 × 9	60	30	AM4S-8X9-60	40	LEMO 00	Straight	7
	8 × 9	70	30	AM4R-8X9-70	40	LEMO 00	Right Angle	6
	8 × 9	70	30	AM4S-8X9-70	40	LEMO 00	Straight	7
	20 × 22	45	180	AM4R-20X22-45	40	LEMO 1	Right Angle	9
	20 × 22	60	180	AM4R-20X22-60	40	LEMO 1	Right Angle	9
20 × 22	70	180	AM4R-20X22-70	40	LEMO 1	Right Angle	9	
5.0	14 × 14	45	88	AM5R-14X14-45	40	LEMO 00	Right Angle	7
	14 × 14	60	88	AM5R-14X14-60	40	LEMO 00	Right Angle	7
	14 × 14	70	88	AM5R-14X14-70	40	LEMO 00	Right Angle	7
6.0	3 × 4	45	N/A	AM6S-3X4-45	38	Microdot	Straight	10
	3 × 4	60	N/A	AM6S-3X4-60	38	Microdot	Straight	10
	3 × 4	70	N/A	AM6S-3X4-70	38	Microdot	Straight	10

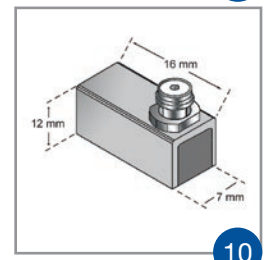
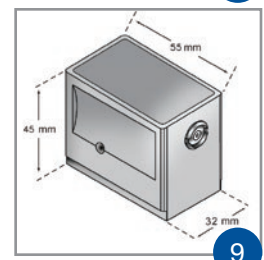
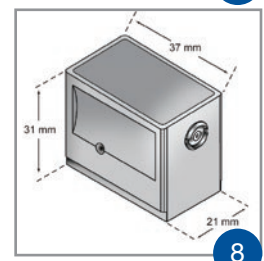
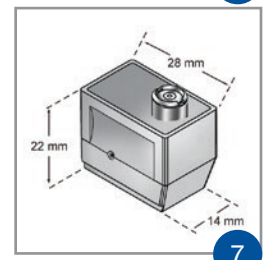
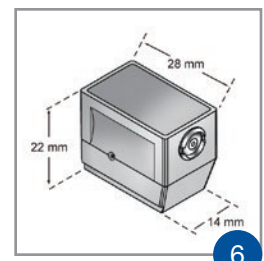

DGS diagrams are included with all Integral Angle Beam Transducers except AM6S-3x4-45, AM6S-3x4-60 and AM6S-3x4-45.

Integral Angle Beam with Composite Elements

Frequency	Nominal Element Size	Angle	Transducer Part Number	Near Field	Typical Bandwidth	Connector	Connector Location	Outline #
MHz	mm			mm	(%)			
2.0	8 x 9	45°	AM2R-8X9-C45	15	65	LEMO 00	Right Angle	6
	8 x 9	60°	AM2R-8X9-C60	15	65	LEMO 00	Right Angle	6
	8 x 9	70°	AM2R-8X9-C70	15	65	LEMO 00	Right Angle	6
4.0	8 x 9	45°	AM4R-8X9-C45	30	80	LEMO 00	Right Angle	6
	8 x 9	60°	AM4R-8X9-C60	30	80	LEMO 00	Right Angle	6
	8 x 9	70°	AM4R-8X9-C70	30	80	LEMO 00	Right Angle	6

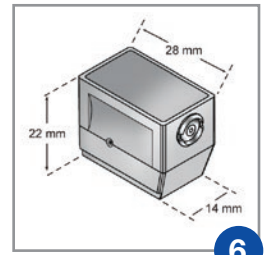

Protected Face Transducers

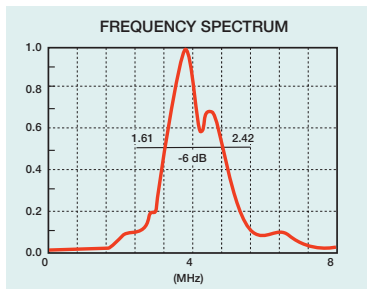
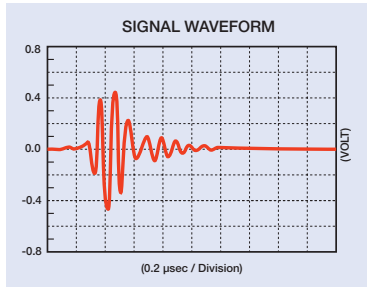

Signal waveform and frequency spectrum of PF2R-24

Frequency	Nominal Element Size	Transducer Part Number	Near Field	Typical Bandwidth	Connector	Connector Location	Outline #
MHz	mm		mm	(%)			
1.0	24	PF1R-24	23	45	LEMO 1	Right Angle	12
	24	PF1S-24	23	45	LEMO 1	Straight	11
2.0	10	PF2R-10	7.2	45	LEMO 00	Right Angle	13
	24	PF2R-24	45	45	LEMO 1	Right Angle	12
4.0	24	PF2S-24	45	45	LEMO 1	Straight	11
	10	PF4R-10	15.6	35	LEMO 00	Right Angle	13
	24	PF4R-24	91	30	LEMO 1	Right Angle	12
	24	PF4S-24	91	30	LEMO 1	Straight	11

DGS diagrams are included with all Protected Face Transducers.

Protective Membrane Accessories

Description	Fits With Nominal Element Size	Part Number
	mm	
Set of 12 Membranes	10	PM-10-12
Set of 12 Membranes	24	PM-24-12
Retaining Ring	10	MRN-10
Retaining Ring	24	MRN-24



TOFD Transducers

Our time-of-flight diffraction transducers are highly damped longitudinal wave probes that offer excellent resolution in challenging TOFD applications. These highly sensitive composite element broadband transducers are available in frequencies from 2.25 MHz to 15 MHz and in sizes from 3 mm (0.25 in.) to 12 mm (0.50 in.). They are for use with specialized TOFD wedges designed to produce refracted longitudinal waves in steel.

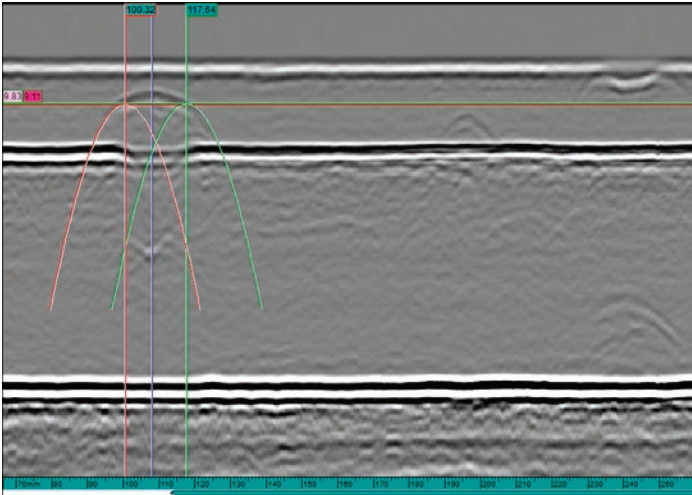

TOFD scan screen shot generated with Olympus OmniPC software.

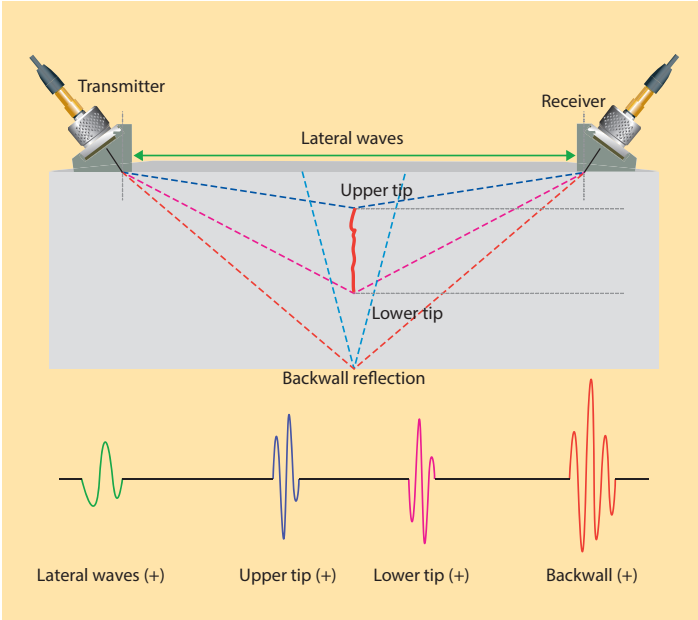

Miniature Screw-in TOFD Transducers

Frequency	Nominal Element Size		Transducer Part Numbers	Wedge Type
	in.	mm		
2.25	0.25	6	C542-SM	ST1
	0.375	9.5	C566-SM	ST2
	0.5	12	C540-SM	ST2
5.0	0.125	3	C567-SM	ST1 **
	0.25	6	C543-SM	ST1
	0.375	9.5	C568-SM	ST2
10	0.5	12	C541-SM	ST2
	0.125	3	C563-SM	ST1 **
15	0.25	6	C544-SM	ST1
	0.125	3	V564-SM*	ST1 **

* Active element is standard piezo-ceramic (not available in composite)
 ** 0.125 in. (3 mm) element size transducers are also compatible with ST1-XXX-Cobra wedges

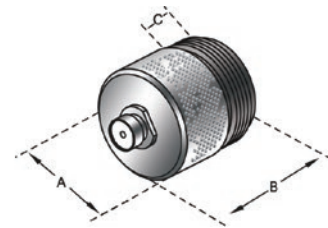

Transducer Dimensions (in inches)				
Nominal Element Size	(A)	(B)	(C)	Thread Pitch
0.125 0.25	0.44	0.55	0.22	3/8 - 32
0.375 0.5	0.71	0.685	0.257	1 1/16 - 24

TOFD Wedges Ordering Number Nomenclature

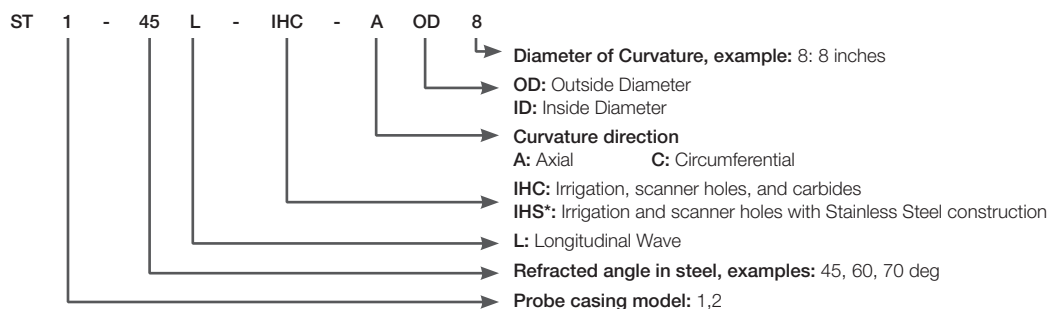

*Only available for ST1 models



Special Transducers



Low Frequency Narrowband Transducers

Meant for use in pairs for through transmission in materials such as concrete, wood, and geological samples, these are available in frequencies of 50 kHz (X1021), 100 kHz (X1020), and 180 kHz (X1019). Recommended instruments are high voltage pulser-receivers such as the Model 5058PR or 5077PR Square Wave Pulser.



500 kHz Broadband/Highly Damped Transducers

This highly damped transducer measures the thickness of fiberglass, composites, and other attenuating materials. This transducer can also be used with a NWC-302 Nylon Wear Cap for flaw detection on thick or rough surfaced casting materials.

Part number is M2008, (1.5 in., 38 mm diameter).

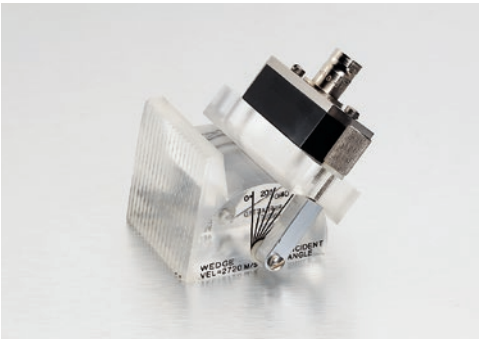

Variable Angle Beam Wedge

The Variable Angle Beam Wedge allows the user to adjust the incident angle from 0° to 50° to create refracted angles in steel from 0° to 90°. The wedge is to be used with the 0.50 × 1.00 in. Standard Angle Beam Transducers (see "Standard Angle Beam Transducers" on page 14).

Wedge Part Number = ABWX-2001

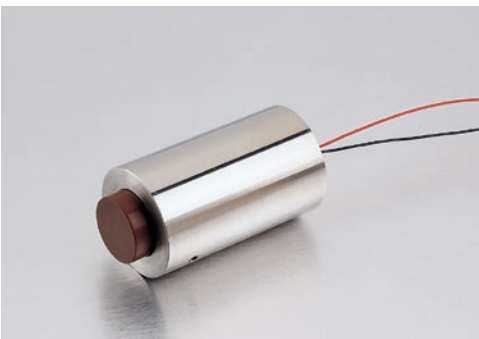

Continuous High Temperature Delay Line Transducer

This transducer can continuously withstand temperatures as high as 350 °F (175 °C) and pressures up to 85 PSIG. One typical application is to monitor the cure of materials in autoclave.

Part number is X2002, (2.25 MHz, 0.5 inch, 13 mm diameter).

Couplants and Adaptors

Couplants

The use of couplant is almost always necessary to provide acoustic coupling between the transducer and the test piece. We offer various types of couplants to suit virtually all applications.

Part Number	Description	Volume	Application
B2	Glycerin	2 oz. (0.06 liter)	General purpose, more viscous and has a high acoustic impedance making it the preferred couplant for rough surfaces and highly attenuating materials.
D12	Gel Type	12 oz. (0.35 liter)	Rough surfaces such as sand-cast metals and fiberglass layups, weld inspections, overhead surfaces or vertical walls.
G-4	Medium Temp	4 oz. (0.12 liter)	Temperature range 0°F to 600°F (-12°C to 315°C) Easy removal at high temperatures, non-toxic and biodegradable.
H-2	High Temp	2 oz. (0.06 liter)	Temperature range 0°F to 950°F (-18°C to 510°C) in many open environment applications when used per manufacturer's recommended procedure.*
SWC	Shear Wave	4 oz. (0.12 liter)	Normal incidence shear wave, non-toxic, water soluble organic substance of very high viscosity.

*Typical UT flaw and thickness applications use thin couplant films in an open environment where the small amount of gas formed can dissipate quickly. However, if an unlikely couplant gas auto ignition flash is of major concern, this couplant should not be used above the auto ignition temperature of 800°F (425°C).

Adaptors

Part Numbers	Fits Connector Style
F108	Right Angle UHF Male to UHF Female, waterproof
F195	45° UHF Female to UHF Male
F202	Active UHF Female to Passive UHF Male/Active Right Angle Microdot Female
F206	UHF to Flange
F267	Right Angle UHF Female to UHF Male, waterproof
BF-BF	BNC Female to BNC Female
BM-BM	BNC Male to BNC Male
BM-UF	BNC Male to UHF Female
L1F-BM	LEMO 1 Female to BNC Male
L1M-BF	LEMO 1 Male to BNC Female
LM-BF	LEMO 00 Male to BNC Female
LF-BM	LEMO 00 Female to BNC Male
MM-UMW	Microdot Male to UHF Male, waterproof
UM-BF	UHF Male to BNC Female
LF-UM	LEMO 00 Female to UHF Male
MM-UFW	Microdot Male to UHF Female, waterproof



Test Blocks

Calibration and/or reference blocks should be used in every application. Standard blocks are available for angle beam calibrations and thickness calibrations of common materials.

- Blocks manufactured from 1018 steel, 304 stainless steel, or 7075-T6 aluminum are commonly in stock (other materials require special quotes for price and delivery).
- Contact us for more information regarding materials not listed, blocks not listed, or custom blocks.

Calibration Blocks

All blocks are checked dimensionally using measuring equipment traceable to the National Institute of Standards and Technology, NIST. The most commonly required calibration blocks are listed below.

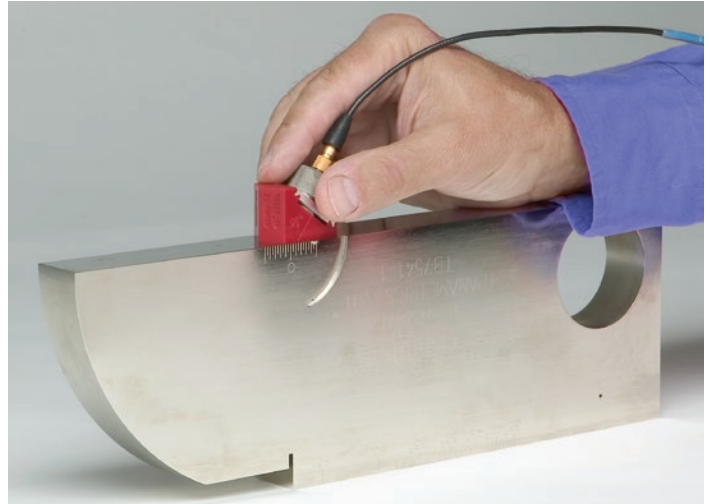

Type	Part Number	Description	Hardwood Case
ASTM E164 Calibration IIW-Type Block	TB7541-X	Meets AASHTO and AWS Type 1 block requirements. Calibrates distance and sensitivity settings. Measure refracted angle and sound exit point of angle beam transducers. U.S. customary units (inches).	F129
	TB1136-X	Meets AASHTO and AWS Type 1 block requirements. Calibrates distance and sensitivity settings. Measure refracted angle and sound exit point of angle beam transducers. U.S. customary units (inches). Block with Lucite plug.	F129
	TB1054-X	Metric units.	F129
	TB1137-X	Metric units. Block with Lucite plug.	F129
US Air Force IIW-2 Calibration Block	TB5939-X	IIW-type block per U.S. Air Force NDI Manual T.O. 33B -1-1. Includes 2 in. and 4 in. radius cutouts for distance calibration. No. 3, No. 5, and No. 8 side drilled holes, and distance calibration marks to the 2 in. hole.	F129
RC AWS Block	TB7543-X	Determining resolution capabilities of angle beam transducers per AWS and AASHTO requirements.	F157
SC AWS Block	TB7545-X	Sensitivity and refracted angle calibration per AWS and AASHTO requirements.	F158
DC AWS Block	TB7547-X	Distance and beam index calibration for angle beam transducers per AWS and AASHTO requirements.	F159
DSC AWS Block	TB7549-X	Distance, sensitivity, refracted angle and beam index calibration for angle beam transducers per AWS and AASHTO requirements.	F160
DS AWS Block	TB7551-X	Calibration block for horizontal linearity and dB accuracy procedures per AWS and AASHTO requirements.	F161
30FBH Resolution Reference Block	TB7160-X	Evaluate near surface resolution and flaw size/depth sensitivity of UT equipment. No. 3, No. 5, and No. 8 ASTM flat bottom holes at ten metal travel distances from 0.050 in. to 1.250 in.	Included
NAVSHIPS Block	TB7567-X	Contains six No. 3 side drilled holes. Used for distance-amplitude calibration per NAVSHIPS 0900-006 -3010.	F162
ASTM E164 MAB Block	TB7150-X	Miniature Angle Beam (ROMPAS) Block. Distance, beam index, refracted angle, and sensitivity calibration. One inch thick.	F197
ISO 7963 Steel	TB1065-X	Miniature Angle Beam Block Distance, beam index, refracted angle and sensitivity calibration. 25 mm thick.	F197

Replace the "X" in the part number with the appropriate number listed below to signify block material:

- 1 = 1018 Steel
- 2 = 4340 Steel
- 4 = 7075-T6 Aluminum
- 5 = 304 Stainless Steel
- 8 = 6-4 Titanium

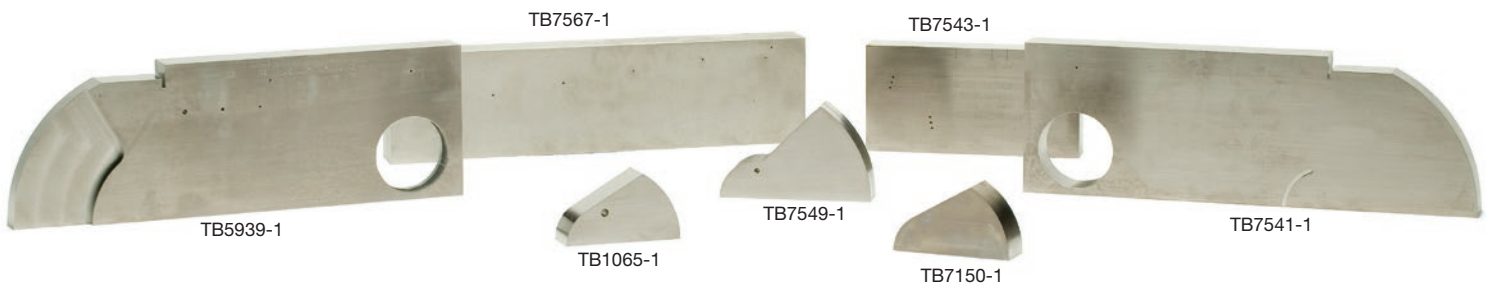

Reference Blocks

We offer commonly used sets of reference blocks recommended by ASTM standards. These sets are manufactured to ASTM E127 and ASTM E428 physical dimensions requirements. All reference blocks are provided with an ultrasonic response curve. We can provide, by special order, materials not listed and individual reference blocks. Contact us for more information regarding materials not listed, custom calibration blocks, or quotations on blocks not listed in this section.



Type of Set*	Part Number	Description of Set
Distance-Area Amplitude Set	TB6100-X	Set of 10 ASTM E 127 (7075 Alum) or ASTM E 428 (all other materials) basic set consisting of $\frac{3}{64}$ at 3 in., $\frac{5}{64}$ at $\frac{1}{8}$ in., $\frac{1}{4}$ in., $\frac{1}{2}$ in., $\frac{3}{4}$ in., 1- $\frac{1}{2}$ in., 3 in., and 6 in., and $\frac{9}{64}$ at 3 in. and 6 in. This set is used for determining dead zone, sensitivity, distance and area amplitude linearity measurement.
Area-Amplitude Set	TB6200-X	Set of 8 ASTM E 127 (7075 Alum) or ASTM E 428 (all other materials) Area Amplitude Set consisting of $\frac{1}{64}$, $\frac{2}{64}$, $\frac{3}{64}$, $\frac{4}{64}$, $\frac{5}{64}$, $\frac{6}{64}$, $\frac{7}{64}$, and $\frac{8}{64}$ flat bottom holes at 3 in. This set is used to determine the relationship between flaw size and echo amplitude by comparing signal response.
Distance-Amplitude Set-No. 3FBH	TB6303-X	Set of 19 ASTM E 127 (7075 Alum) or ASTM E 428 (all other materials) Distance Amplitude Set. All flat bottom holes are the same and metal travel distances are $\frac{1}{16}$ in., $\frac{1}{8}$ in., $\frac{1}{4}$ in., $\frac{3}{16}$ in., $\frac{1}{2}$ in., $\frac{5}{8}$ in., $\frac{3}{4}$ in., $\frac{7}{8}$ in., 1 in., 1- $\frac{1}{4}$ in., 1- $\frac{3}{4}$ in., 2- $\frac{1}{4}$ in., 2- $\frac{3}{4}$ in., 3- $\frac{1}{4}$ in., 3- $\frac{3}{4}$ in., 4 in., 4- $\frac{3}{4}$ in., 5- $\frac{1}{4}$ in., and 5- $\frac{3}{4}$ in. This set is used to determine the relationship between metal distance and signal amplitude by comparing signal responses obtained.
Distance-Amplitude Set-No. 5FBH	TB6305-X	$\frac{1}{16}$ in. $\frac{1}{2}$ in. 1 in. 2- $\frac{1}{4}$ in. 3- $\frac{1}{4}$ in. 4- $\frac{1}{4}$ in. 5- $\frac{1}{4}$ in.
Distance-Amplitude Set-No. 8FBH	TB6308-X	$\frac{1}{8}$ in. $\frac{5}{8}$ in. 1- $\frac{1}{4}$ in. 2- $\frac{3}{4}$ in. 3- $\frac{3}{4}$ in. 4- $\frac{3}{4}$ in. 5- $\frac{3}{4}$ in.
Distance-Amplitude Set-No. 3FBH	TB6303-X	$\frac{1}{4}$ in. $\frac{3}{4}$ in. 1- $\frac{3}{4}$ in.
Distance-Amplitude Set-No. 8FBH	TB6308-X	$\frac{3}{8}$ in. $\frac{7}{8}$ in.
Sensitivity-Resolution Set	TB6025-X	Set of 9 ASTM E 127 (7075 Alum) or ASTM E 428 (all other materials) consisting of $\frac{1}{64}$ at 3 in., $\frac{2}{64}$ at 3 in., and $\frac{5}{64}$ at $\frac{1}{8}$ in., $\frac{1}{4}$ in., $\frac{3}{8}$ in., $\frac{1}{2}$ in., $\frac{3}{4}$ in., 1 in., and 1- $\frac{1}{2}$ in., and 1 ASTM E 317 horizontal and vertical linearity block used to evaluate the sensitivity, entry surface resolution, and horizontal and vertical linearity characteristics of UT equipment.

Replace the "X" in the part number with the appropriate number listed below to signify block material:

- 1 = 1018 Steel
 - 2 = 4340 Steel
 - 4 = 7075-T6 Aluminum
 - 5 = 304 Stainless Steel
 - 8 = 6-4 Titanium
- *Includes Hardwood case

Thickness Calibration Blocks

- Blocks are held to tighter tolerances than called out in ASTM E797 Code.

Material	Part Numbers	Steps
304 Stainless Steel	2211E	0.100 in., 0.200 in., 0.300 in., 0.400 in., 0.500 in.
304 Stainless Steel	2211M	2.5 mm, 5.0 mm, 7.5 mm, 10.0 mm, 12.5 mm
1018 Carbon Steel	2212E	0.250 in., 0.500 in., 0.750 in., 1.00 in.
1018 Carbon Steel	2212M	6.25 mm, 12.5 mm, 18.75 mm, 25 mm
7075-T6 Aluminum	2213E	0.100 in., 0.200 in., 0.300 in., 0.400 in., 0.500 in.
7075-T6 Aluminum	2213M	2.5 mm, 5.0 mm, 7.5 mm, 10.0 mm, 12.5 mm
1018 Carbon Steel	2214E	0.100 in., 0.200 in., 0.300 in., 0.400 in., 0.500 in.
1018 Carbon Steel	2214M	2.5 mm, 5.0 mm, 7.5 mm, 10.0 mm, 12.5 mm

Note: For hardwood case, order 2214C.



Cables

- Select from a variety of cable grades to meet your specific application needs.
- Standard lengths 3 ft (1 m), 4 ft (1.2 m), 6 ft (1.8 m). When ordering, replace the x in the part number with the desired cable length in feet.
- Custom cable lengths are available; please specify when ordering.
- Part numbering prefix indicates connector style for both ends of the cable.
- All cables are 50 ohms impedance unless otherwise specified.
- Contact us for special or customized cables.



Standard

Cable Part Numbers	Fits Connector Style
BCB-58-X BCB-74-X BCM-74-X BCMA-74-X BCRM-74-X BCU-58-X BCU-62-X	Fits BNC to BNC Fits BNC to BNC Fits BNC & Microdot Fits BNC & Microdot without Boot Fits BNC & Right Angle Microdot Fits BNC to UHF Fits BNC to UHF
FLCB-74-X LCB-74-X LCM-74-X LCU-74-X L1CB-58-X L1CM-74-X L1CU-74-X L1CU-74-X	Fits Female LEMO & BNC Fits Small LEMO 00 & BNC Fits Small LEMO 00 & Microdot Fits Small LEMO 00 & UHF Fits Large LEMO 1 & BNC Fits Large LEMO 1 & Microdot Fits Large LEMO 1 & UHF Fits Large LEMO 1 & UHF
UCM-74-X UCU-58-X	Fits UHF and Microdot Fits UHF to UHF

Heavy Duty (HD)

- External Teflon coating provides flexibility and improved cable performance in industrial settings

Cable Part Numbers	Fits Connector Style
BCB-188-X HD BCM-188-X HD BCU-188-X HD	Fits BNC to BNC Fits BNC and Microdot Fits BNC to UHF
LCB-188-X HD LCM-188-X HD	Fits Small LEMO 00 and BNC Fits Small LEMO 00 and Microdot

Waterproof (W)

- Specially designed proprietary waterproof UHF connector provides a waterproof connection good to depths of about 150 ft (50 m) in fresh water.

Cable Part Numbers	Fits Connector Style
BCM-74-X W BCRM-74-X W BCU-58-X W BCU-62-X W BCU-74-X W	Fits BNC to Waterproof Microdot Fits BNC to Waterproof Right Angle Microdot Fits BNC to Waterproof UHF Fits BNC to Waterproof UHF Fits BNC to Waterproof UHF
LCM-74-X W LCU-74-X W L1CU-74-X W	Fits Small LEMO 00 to Waterproof Microdot Fits Small LEMO 00 to Waterproof UHF Fits Large LEMO 1 to Waterproof UHF

Armored Stainless Steel (SSA)

Interlocking stainless steel jacket provides flexibility, protection, and ruggedness in heavy industrial settings

- Can be ordered in lengths up to 20 ft (6.1m)

Cable Part Numbers	Fits Connector Style
BCB-188-X SSA BCM-188-X SSA BCRM-188-X SSA BCU-188-X SSA	Fits BNC to BNC Fits BNC and Microdot Fits BNC and Right Angle Microdot Fits BNC to UHF
LCM-188-X SSA LCRM-188-X SSA	Fits Small LEMO 00 and Microdot Fits Small LEMO 00 and Right Angle Microdot

Double Shielded (DS)

- Additional grounded shield provides low cable noise for better performance in high frequency applications.
- 15 ohm or 25 ohm cable of different lengths may help to optimize high frequency system performance.

Cable Part Numbers	Fits Connector Style	Impedance
BCM-74-X DS	Fits BNC and Microdot	50 ohms
BCM-15-X DS	Fits BNC and Microdot	15 ohms
BCM-25-X DS	Fits BNC and Microdot	25 ohms

Cables with Handle

- Special 3 in. (75 mm) long reinforced handle for increased durability and easier grip
- Custom handles can be ordered 6 in. (152 mm) and 9 in. (229 mm)

Cable Part Numbers	Fits Connector Style	Handle Length
		inches
BCMH-74-X	Fits BNC and Microdot	3
LCMH-74-X	Fits Small LEMO 00 and Microdot	3
L1CMH-74-X	Fits Large LEMO 1 and Microdot	3
BCMH6-74-X	Fits BNC and Microdot	6
LCMH6-74-X	Fits Small LEMO 00 and Microdot	6
L1CMH6-74-X	Fits Large LEMO 1 and Microdot	6
BCMH9-74-X	Fits BNC and Microdot	9
LCMH9-74-X	Fits Small LEMO 00 and Microdot	9
L1CMH9-74-X	Fits Large LEMO 1 and Microdot	9

Standard



Standard RG174 Microdot Connector



Standard RG174 Right Angle Microdot Connector



Standard RG58 LEMO 1 Connector



Double Shielded RG58 (DS) Waterproof UHF Connector

Heavy Duty



RG188 Heavy Duty Teflon Coated (HD) Microdot Connector



RG188 Heavy Duty Teflon Coated (HD) Microdot Handle 3 in. Connector



RG188 Heavy Duty Teflon Coated (HD) BNC Connector



RG188 Heavy Duty Teflon Coated (HD) LEMO 00 Connector

Armored



RG188 Heavy Duty Armored PVC (HDAP) LEMO 00 Connector



RG188 Heavy Duty Armored Super Flexible Silicone (HDAS) Microdot Connector



RG188 Armored Stainless Steel (SSA) Microdot Connector

Dual

- Single cable design with two connectors at each end to fit dual element transducers

Cable Part Numbers	Fits Connector Style	Compatible With
BCMD-74-6 LCMD-74-6 L1CMD-74-6	Dual BNC to Microdot Dual Small LEMO 00 to Microdot Dual Large LEMO 1 to Microdot	Standard Dual Transducer
BCMD-316-5F L1CMD-316-5F	Dual BNC to Microdot Dual Large LEMO 1 to Microdot	Flush Case Dual Transducer
BCLPD-78-5 L1CLPD-78-5	Dual BNC to Leptra/Con Dual Large LEMO 1 to Leptra/Con	MTD-705 Transducer

Heavy Duty, Armored PVC (HDAP)

- Spiral stainless steel jacket with external solid PVC coating makes this cable very durable.

Cable Part Numbers	Fits Connector Style
BCB-188-X HDAP BCM-188-X HDAP BCU-188-X HDAP	Fits BNC to BNC Fits BNC to Microdot Fits BNC to UHF
LCB-188-X HDAP LCM-188-X HDAP	Fits Small LEMO 00 to BNC Fits Small LEMO 00 to Microdot

Heavy Duty, Armored Super Flexible Silicone (HDAS)

- Stainless steel jacket with an external silicone coating makes this cable durable, yet flexible.

Cable Part Numbers	Fits Connector Style
BCB-188-X HDAS BCM-188-X HDAS BCU-188-X HDAS	Fits BNC to BNC Fits BNC to Microdot Fits BNC to UHF
LCB-188-X HDAS LCM-188-X HDAS	Fits Small LEMO 00 to BNC Fits Small LEMO 00 to Microdot

Atlas

Cable Part Numbers	Fits Connector Style	Transducer Type	Length meters
L1CLD-316-2MK*	LEMO 00 × 2 to LEMO 1 × 2	Dual	2
LCLD-316-2MK*	LEMO 00 × 2 to LEMO 00 × 2	Dual	2
BCLD-316-2MK*	BNC × 2 to LEMO 00 × 2	Dual	2
LCL-74-2M	LEMO 00 to LEMO 00	Single	2
L1CL1-74-2M	LEMO 1 to LEMO 1	Single	2
L1CL-74-2M	LEMO 1 to LEMO 00	Single	2
LCB-74-2M	LEMO 00 to BNC	Single	2

*Dual cables can be used only with "Atlas Dual Element Transducers" on page 32

Ultrasonic Transducers

Technical Notes

Basic Ultrasonic Principles	43
What is Ultrasound?	43
Frequency, Period and Wavelength	43
Velocity of Ultrasound and Wavelength	43
Wave Propagation and Particle Motion	43
Applying Ultrasound	44
Sensitivity and Resolution	44
Advanced Definitions And Formulas	44
Transducer Waveform and Spectrum	44
Acoustic Impedance, Reflectivity and Attenuation	45
Sound Field	45
Other Parameters of a Sound Beam	45
Design Characteristics Of Transducers	46
What is an Ultrasonic Transducer?	46
The Active Element	46
Backing	46
Wear Plate	46
Transducer Specific Principles	47
Dual Element Transducers	47
Angle Beam Transducers	47
Delay Line Transducers	48
Immersion Transducers	48
Normal Incidence Shear Wave Transducers	49
Transducer Excitation Guidelines	50
Cables	50
Near Field Distances of Flat Transducers in Water	51
Acoustic Properties of Materials	52



Technical Notes

The Technical Notes section is designed to provide a brief overview of the ultrasonic principles important to transducer application and design. The Technical Notes are organized in the following sections:

1. Basic ultrasonic principles
2. Advanced definitions and formulas
3. Design characteristics of transducers
4. Transducer specific principles
5. Transducer excitation guidelines
6. Cables

1. Basic Ultrasonic Principles

a. What is Ultrasound?

Sound generated above the human hearing range (typically 20 kHz) is called ultrasound. However, the frequency range normally employed in ultrasonic nondestructive testing and thickness gaging is 100 kHz to 50 MHz. Although ultrasound behaves in a similar manner to audible sound, it has a much shorter wavelength. This means it can be reflected off very small surfaces such as defects inside materials. It is this property that makes ultrasound useful for nondestructive testing of materials.

The Acoustic Spectrum in Figure (1) breaks down sound into three ranges of frequencies. The Ultrasonic Range is then broken down further into three sub-sections.

Fig. 1

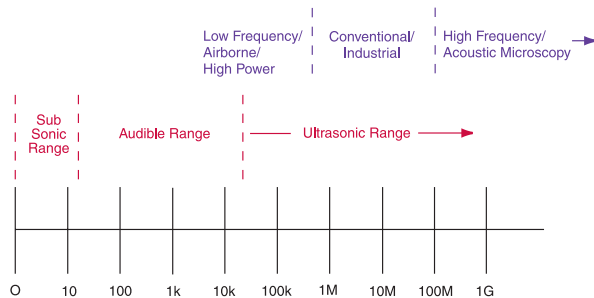

b. Frequency, Period and Wavelength

Ultrasonic vibrations travel in the form of a wave, similar to the way light travels. However, unlike light waves, which can travel in a vacuum (empty space), ultrasound requires an elastic medium such as a liquid or a solid. Shown in Figure (2) are the basic parameters of a continuous wave (cw). These parameters include the wavelength (λ) and the period (T) of a complete cycle.

Fig. 2

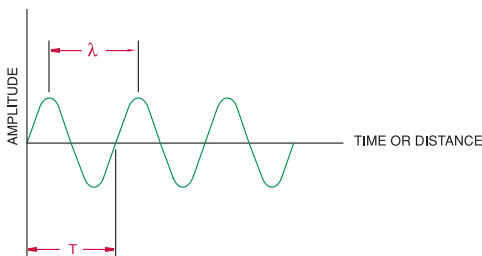

The number of cycles completed in one second is called frequency (f) and is measured in hertz (Hz), with multiples as follows;

- 1 cycle/second= 1 Hz
- 1000 cycles/second= 1 kHz
- 1,000,000 cycles/second= 1 MHz

The time required to complete a full cycle is the period (T), measured in seconds. The relation between frequency and period in a continuous wave is given in Equation (1).

Eqn. 1

$$f = 1/T$$

c. Velocity of Ultrasound and Wavelength

The velocity of ultrasound (c) in a perfectly elastic material at a given temperature and pressure is constant. The relation between c, f, λ and T is given by Equations (2) and (3):

Eqn. 2

$$\lambda = c/f$$

Eqn. 3

$$\lambda = cT$$

- λ = Wavelength
- c = Material Sound Velocity
- f = Frequency
- T = Period of time

"Table 2 - Acoustic Properties of Materials" on page 52 lists the longitudinal and shear wave velocities of materials that are commonly tested with ultrasonics.

d. Wave Propagation and Particle Motion

The most common methods of ultrasonic examination utilize either longitudinal waves or shear waves. Other forms of sound propagation exist, including surface waves and Lamb waves.

- A longitudinal wave is a compressional wave in which the particle motion is in the same direction as the propagation of the wave.
- A shear wave is a wave motion in which the particle motion is perpendicular to the direction of the propagation.
- Surface (Rayleigh) waves have an elliptical particle motion and travel across the surface of a material. Their velocity is approximately 90% of the shear wave velocity of the material and their depth of penetration is approximately equal to one wavelength.
- Plate (Lamb) waves have a complex vibration occurring in materials where thickness is less than the wavelength of ultrasound introduced into it.

Figure (3) provides an illustration of the particle motion versus the direction of wave propagation for longitudinal waves and shear waves.

Fig. 3

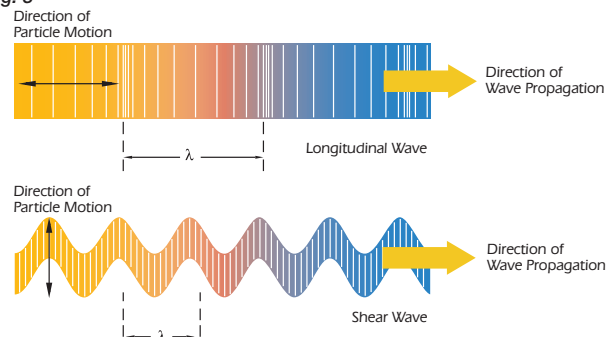

Technical Notes

e. Applying Ultrasound

Ultrasonic nondestructive testing introduces high frequency sound waves into a test object to obtain information about the object without altering or damaging it in any way. Two basic quantities are measured in ultrasonic testing; they are time of flight or the amount of time for the sound to travel through the sample, and the amplitude of the received signal. Based on velocity and round trip time of flight through the material the material thickness can be calculated as follows:

Eqn. 4

$$T = \frac{ct}{2}$$

T = Material Thickness
 c = Material Sound Velocity
 t = Time of Flight

Measurements of the relative change in signal amplitude can be used in sizing flaws or measuring the attenuation of a material. The relative change in signal amplitude is commonly measured in decibels. Decibel values are the logarithmic value of the ratio of two signal amplitudes. This can be calculated using the following equation. Some useful relationships are also displayed in the table below;

Eqn. 5

$$dB = 20 \log_{10} (A_1/A_2)$$

dB = Decibels
 A₁ = Amplitude of signal 1
 A₂ = Amplitude of signal 2

A ₁	Ratio	dB
100%	1.4142	3
70.71%		
100%	2	6
50%		
100%	4	12
25%		
100%	10	20
10%		
100%	100	40
1%		

f. Sensitivity and Resolution

- Sensitivity is the ability of an ultrasonic system to detect reflectors (or defects) at a given depth in a test material. The greater the signal that is received from a given reflector, the more sensitive the transducer system.
- Axial resolution is the ability of an ultrasonic system to produce simultaneous and distinct indications from reflectors located at nearly the same position with respect to the sound beam.
- Near surface resolution is the ability of the ultrasonic system to detect reflectors located close to the surface of the test piece.

2. Advanced Definitions And Formulas

a. Transducer Waveform and Spectrum

Transducer waveform and spectrum analysis is done according to test conditions and definitions of ASTM E1065. Typical units are MHz for frequency analysis, microseconds for waveform analysis, and dB down from peak amplitude. Figure (4) illustrates waveform duration at the -14 dB level or 20% amplitude of peak. The -40 dB waveform duration corresponds to 1% amplitude of peak.

Fig. 4

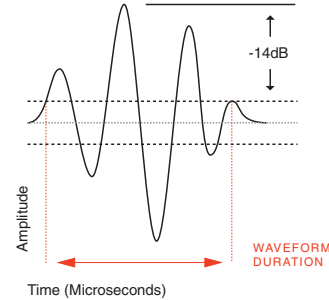
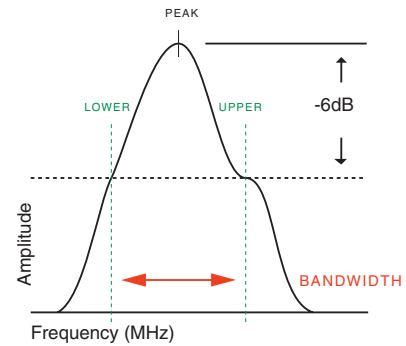

Figure (5) illustrates peak frequency, upper and lower -6 dB frequencies and MHz bandwidth measurements.

Fig. 5



The relation between MHz bandwidth and waveform duration is shown in Figure (6). The scatter is wider at -40 dB because the 1% trailing end of the waveform contains very little energy and so has very little effect on the analysis of bandwidth. Because of the scatter it is most appropriate to specify waveforms in the time domain (microseconds) and spectra in the frequency domain.

Fig. 6

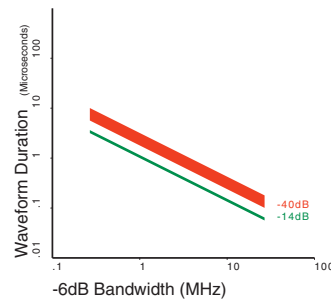

The approximate relations shown in Figure (6) can be used to assist in transducer selection. For example, if a -14 dB waveform duration of one microsecond is needed, what frequency transducer should be selected? From the graph, a bandwidth of approximately 1 to 1.2 MHz corresponds to approximately 1 microsecond -14 dB waveform duration. Assuming a nominal 50% fractional bandwidth transducer, this calculates to a nominal center frequency of 2 to 2.4 MHz. Therefore, a transducer of 2.25 MHz or 3.5 MHz may be applicable.

b. Acoustic Impedance, Reflectivity and Attenuation

The acoustic impedance of a material is the opposition to displacement of its particles by sound and occurs in many equations. Acoustic impedance is calculated as follows:

Eqn. 6

$$Z = \rho c$$

- Z = Acoustic Impedance
- c = Material Sound Velocity
- ρ = Material Density

The boundary between two materials of different acoustic impedances is called an acoustic interface. When sound strikes an acoustic interface at normal incidence, some amount of sound energy is reflected and some amount is transmitted across the boundary. The dB loss of energy on transmitting a signal from medium 1 into medium 2 is given by:

Eqn. 7a

$$\text{dB loss} = 10 \log_{10} [4Z_1Z_2 / (Z_1 + Z_2)^2]$$

- Z_1 = Acoustic Impedance of First Material
- Z_2 = Acoustic Impedance of Second Material

The dB loss of energy of the echo signal in medium 1 reflecting from an interface boundary with medium 2 is given by:

Eqn. 7b

$$\text{dB loss} = 10 \log_{10} [(Z_2 - Z_1)^2 / (Z_1 + Z_2)^2]$$

For example: The dB loss on transmitting from water ($Z = 1.48$) into 1020 steel ($Z = 45.41$) is -9.13 dB; this also is the loss transmitting from 1020 steel into water. The dB loss of the backwall echo in 1020 steel in water is -0.57 dB; this also is the dB loss of the echo off 1020 steel in water. The waveform of the echo is inverted when $Z_2 < Z_1$.

Finally, ultrasound attenuates as it progresses through a medium. Assuming no major reflections, there are three causes of attenuation: diffraction, scattering and absorption. The amount of attenuation through a material can play an important role in the selection of a transducer for an application.

c. Sound Field

The sound field of a transducer is divided into two zones (figure 7a); the near field and the far field. The near field is the region directly in front of the transducer where the echo amplitude goes through a series of maxima and minima and ends at the last maximum, at distance N from the transducer. In the beam profile below, figure 7, red represents areas of highest energy, while green and blue represent lower energy.

Fig. 7



Fig. 7a

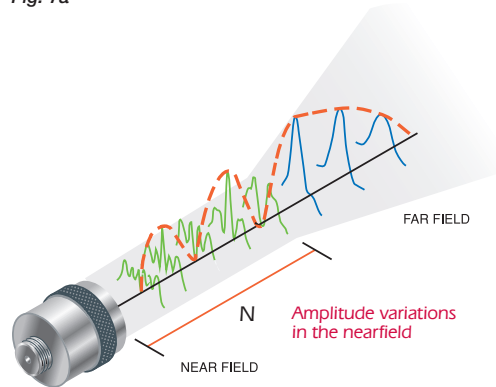

The location of the last maximum is known as the near field distance (N or Y_0^*) and is the natural focus of the transducer. The far field is the area beyond N where the sound field pressure gradually drops to zero. Because of the variations within the near field it can be difficult to accurately evaluate flaws using amplitude based techniques. The near field distance is a function of the transducer frequency, element diameter, and the sound velocity of the test material as shown by Equation 8:

Eqn. 8

$$N = D^2 f / 4c$$

Eqn. 8a

$$N = D^2 / 4\lambda$$

- N = Near Field Distance
- D = Element Diameter
- f = Frequency
- c = Material Sound Velocity
- λ = Wavelength

("Table 1 - Near Field Distance of Flat Transducers in Water" on page 51 lists the near field distances in water for many combinations of transducer frequency and element diameter.)

d. Other Parameters of a Sound Beam

There are a number of sound field parameters that are useful in describing the characteristics of a transducer. In addition to the near field, knowledge of the beam width and focal zone may be necessary in order to determine whether a particular transducer is appropriate for a given inspection. Figure (8) gives a graphical representation of these parameters:

Fig. 8

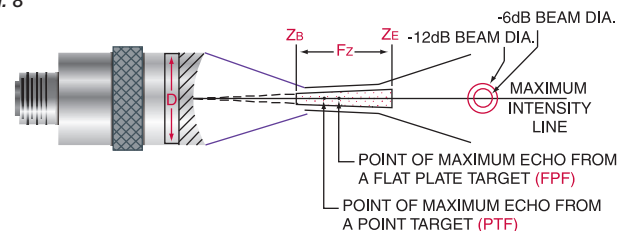

- Z_B = Beginning of the Focal Zone
- F_z = Focal Zone
- Z_E = End of the Focal Zone
- D = Element Diameter

Note that the distance to the maximum echo from a flat plate target and the maximum echo from the point target are not the same, although both will occur within the calculated -6 dB focal zone.

Technical Notes

Beam Diameter

A transducer's sensitivity is affected by the beam diameter at the point of interest. The smaller the beam diameter, the greater the amount of energy is reflected by a flaw. The -6 dB pulse-echo beam diameter at the focus can be calculated with Equation 9 or 9a. For a flat transducer use Equation 9a with $S_F = 1$

Eqn. 9 $BD(-6\text{ dB}) = 1.02Fc/fD$

Eqn. 9a $BD(-6\text{ dB}) = .2568DS_F$

- BD = Beam Diameter
- F = Focal Length
- c = Material Sound Velocity
- f = Frequency
- D = Element Diameter
- S_F = Normalized Focal Length (Eqn. 14)

Focal Zone

The starting and ending points of the focal zone are located where the on-axis pulse-echo signal amplitude drops to -6 dB of the amplitude at the focal point. The length of the focal zone is given by Equation 10:

Eqn. 10 $F_Z = N \cdot S_F^2 [2 / (1 + .5S_F)]$

- F_Z = Focal Zone
- N = Near Field
- S_F = Normalized Focal Length (Eqn. 14)

Figure (9) shows the normalized beginning (S_B) and ending (S_E) point of the -6 dB focal zone versus the focusing factor.

Fig. 9
-6 dB Focal Zone

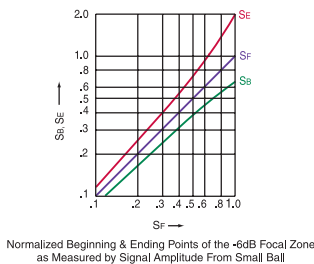

Beam Spread and Half Angle

All ultrasonic beams diverge. In other words, all transducers have beam spread. Figure (10) gives a simplified view of a sound beam for a flat transducer. In the near field, the beam has a complex shape that narrows. In the far field the beam diverges.

Fig. 10

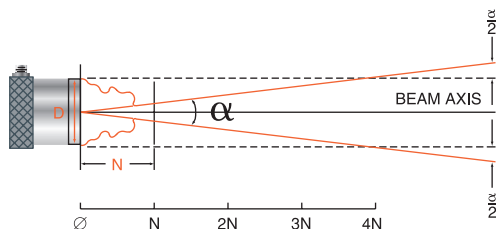

For flat transducers as shown in Figure (10), the -6 dB pulse-echo beam

spread angle is given by Equation (11):

Eqn. 11 $\sin(\alpha/2) = .514c/fD$

$\alpha/2$ = Half Angle Spread between -6 dB points

It can be seen from this equation that beam spread from a transducer can be reduced by selecting a transducer with a higher frequency or a larger element diameter or both.

3. Design Characteristics Of Transducers

a. What is an Ultrasonic Transducer?

A transducer is any device that converts one form of energy to another. An ultrasonic transducer converts electrical energy to mechanical energy, in the form of sound, and vice versa. The main components are the active element, backing, and wear plate.

Fig. 11

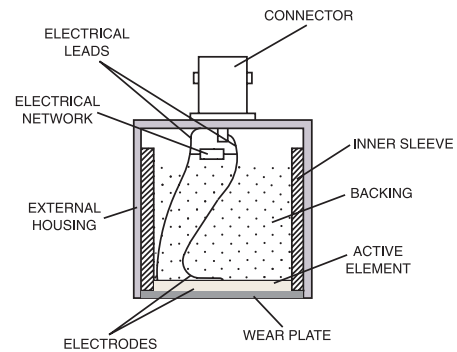

b. The Active Element

The active element, which is piezo or ferroelectric material, converts electrical energy such as an excitation pulse from a flaw detector into ultrasonic energy. The most commonly used materials are polarized ceramics which can be cut in a variety of manners to produce different wave modes. New materials such as piezo polymers and composites are also being employed for applications where they provide benefit to transducer and system performance.

c. Backing

The backing is usually a highly attenuative, high density material that is used to control the vibration of the transducer by absorbing the energy radiating from the back face of the active element. When the acoustic impedance of the backing matches the acoustic impedance of the active element, the result will be a heavily damped transducer that displays good range resolution but may be lower in signal amplitude. If there is a mismatch in acoustic impedance between the element and the backing, more sound energy will be reflected forward into the test material. The end result is a transducer that is lower in resolution due to a longer waveform duration, but may be higher in signal amplitude or greater in sensitivity.

d. Wear Plate

The basic purpose of the transducer wear plate is to protect the transducer element from the testing environment. In the case of contact transducers, the wear plate must be a durable and corrosion resistant material in order to withstand the wear caused by use on materials such as steel.

For immersion, angle beam, and delay line transducers the wear plate has the additional purpose of serving as an acoustic transformer or matching

layer between the high acoustic impedance of the active element and the water, the wedge or the delay line, all of which are of lower acoustic impedance. This is accomplished by selecting a matching layer that is $\frac{1}{4}$ wavelength thick ($\lambda/4$) and of the desired acoustic impedance (the active element is nominally $\frac{1}{2}$ wavelength). The choice of the wear surface thickness is based upon the idea of superposition that allows waves generated by the active element to be in phase with the wave reverberating in the matching layer as shown in Figure (4).

When signals are in phase, their amplitudes are additive, thus a greater amplitude wave enters the test piece. Figure (12) shows the active element and the wear plate, and when they are in phase. If a transducer is not tightly controlled or designed with care and the proper materials, and the sound waves are not in phase, it causes a disruption in the wavefront.

Fig. 12

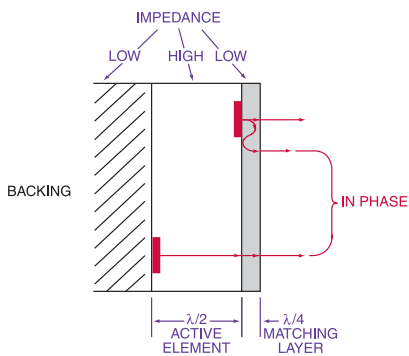

4. Transducer Specific Principles

a. Dual Element Transducers

Dual element transducers utilize separate transmitting and receiving elements, mounted on delay lines that are usually cut at an angle (see illustration on page 10). This configuration improves near surface resolution by eliminating main bang recovery problems. In addition, the crossed beam design provides a pseudo focus that makes duals more sensitive to echoes from irregular reflectors such as corrosion and pitting.

One consequence of the dual element design is a sharply defined distance/amplitude curve. In general, a decrease in the roof angle or an increase in the transducer element size will result in a longer pseudo-focal distance and an increase in useful range, as shown in Figure (13).

Fig. 13

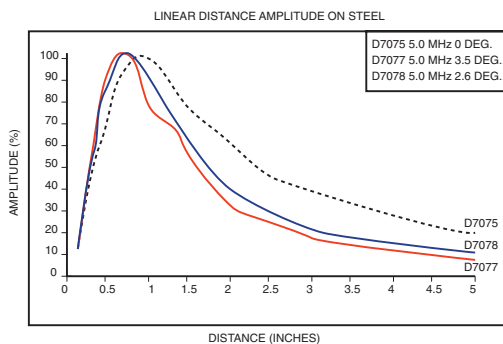

b. Angle Beam Transducers

Angle beam transducers use the principles of refraction and mode conversion to produce refracted shear or longitudinal waves in the test material as shown in Figure (14).

Fig. 14

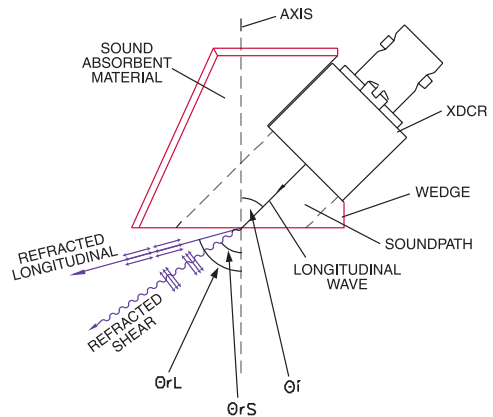

The incident angle necessary to produce a desired refracted wave (i.e. a 45° shear wave in steel) can be calculated from Snell's Law as shown in Equation (12). Because of the effects of beam spread, this equation doesn't hold at low frequency and small active element size. Contact us for details concerning these phenomena.

Eqn. 12

$$\sin\theta_i/c_i = \sin\theta_{rl}/c_{rl} = \sin\theta_{rs}/c_{rs}$$

- θ_i = Incident Angle of the Wedge
- θ_{rl} = Angle of the Refracted Longitudinal Wave
- θ_{rs} = Angle of the Refracted Shear Wave
- c_i = Velocity of the Incident Material (Longitudinal)
- c_{rl} = Material Sound Velocity (Longitudinal)
- c_{rs} = Velocity of the Test Material (Shear)

Figure (15) shows the relationship between the incident angle and the relative amplitudes of the refracted or mode converted longitudinal, shear, and surface waves that can be produced from a plastic wedge into steel.

Fig. 15

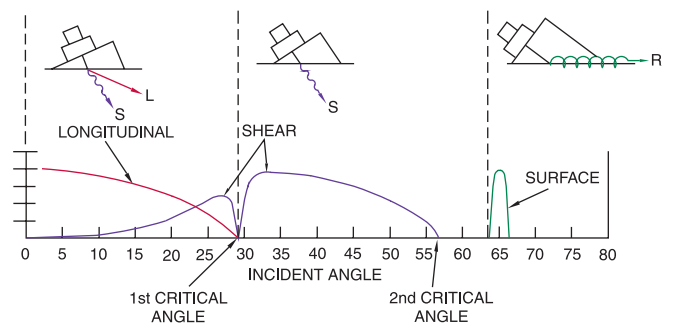

Angle beam transducers are typically used to locate and/or size flaws which are oriented non-parallel to the test surface. Following are some of the common terms and formulas used to determine the location of a flaw.

Technical Notes

Fig. 16

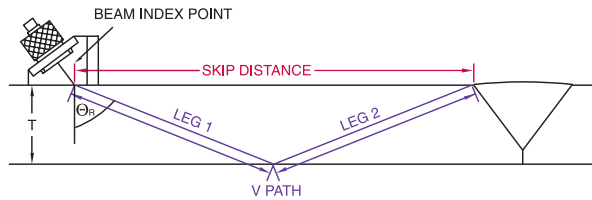

θ_r = Refracted Angle

T = Thickness

$$\text{Leg} = \frac{T}{\cos \theta_r}$$

$$\text{V-PATH} = \frac{2T}{\cos \theta_r}$$

$$\text{Skip Distance} = 2T \times \tan \theta_r$$

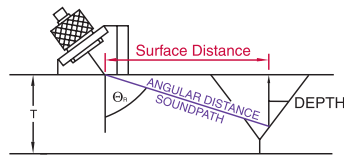

$$\text{Surface Distance} = \sin \theta_r \times \text{Soundpath}$$

$$\text{Depth (1st Leg)} \cos \theta_r \times \text{Soundpath}$$

$$\text{Depth (2nd Leg)} = 2T - [\cos \theta_r \times \text{Soundpath}]$$

Many AWS inspections are performed using refracted shear waves. However, grainy materials such as austenitic stainless steel may require refracted longitudinal waves or other angle beam techniques for successful inspections.

c. Delay Line Transducers

Delay line transducers are single element longitudinal wave transducers used in conjunction with a replaceable delay line.

One of the reasons for choosing a delay line transducer is that near surface resolution can be improved. The delay allows the element to stop vibrating before a return signal from the reflector can be received. When using a delay line transducer, there will be multiple echoes from end of the delay line and it is important to take these into account.

Another use of delay line transducers is in applications in which the test material is at an elevated temperature. The high temperature delay line options listed in this catalog (see "Delay Line Transducers" starting on page 18) are not intended for continuous contact, they are meant for intermittent contact only.

d. Immersion Transducers

Immersion transducers offer three major advantages over contact transducers:

- Uniform coupling reduces sensitivity variations.
- Reduction in scan time due to automated scanning.
- Focusing of immersion transducers increases sensitivity to small reflectors.

Focusing Configurations

Immersion transducers are available in three different configurations: unfocused ("flat"), spherically ("spot") focused, and cylindrically ("line") focused. Focusing is accomplished by either the addition of a lens or by curving the element itself. The addition of a lens is the most common way to focus a transducer.

An unfocused transducer may be used in general applications or for penetration of thick materials. A spherically focused transducer is commonly used to improve sensitivity to small flaws and a cylindrical focus is typically used in the inspection of tubing or bar stock. Examples of spherical and cylindrical focusing are shown in Figure (17).

Fig. 17

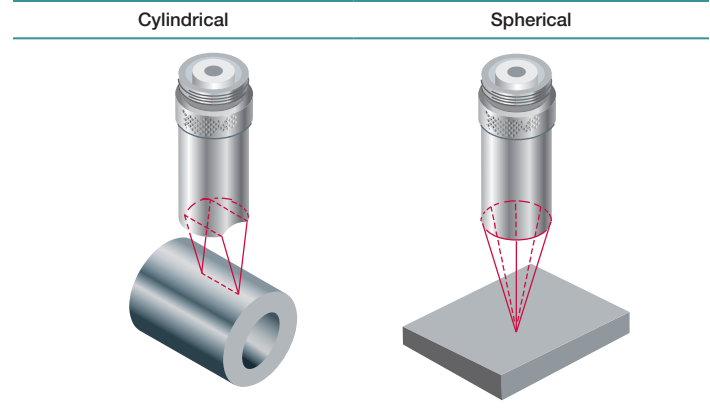

By definition, the focal length of a transducer is the distance from the face of the transducer to the point in the sound field where the signal with the maximum amplitude is located. In an unfocused transducer, this occurs at a distance from the face of the transducer which is approximately equivalent to the transducer's near field length. Because the last signal maximum occurs at a distance equivalent to the near field, a transducer, by definition, can not be acoustically focused at a distance greater than its near field.

Focus may be designated in three ways:

FPF (Flat Plate Focus) - For an FPF focus, the lens is designed to produce a maximum pulse/echo response from a flat plate target at the distance indicated by the focal length

PTF (Point Target Focus) - For a PTF focus, the lens is designed to produce a maximum pulse/echo response from a small ball target at the distance indicated by the focal length

OLF (Optical Limit Focus) - The OLF designation indicates that the lens is designed according to the lens maker's formula from physical optics and without reference to any operational definition of focal length. The OLF designation describes the lens and ignores diffraction effects.

When focusing a transducer, the type of focus (spherical or cylindrical), focal length, and the focal target (point or flat surface) need to be specified. Based on this information, the radius of curvature of the lens for the transducer which varies based on above parameters, can be calculated. When tested, the measured focal length will be off of the target specified.

There are limitations on focal lengths for transducers of a given frequency and element diameter for a particular focal designation. The maximum practical focal length for a flat plate focus (FPF) is 0.6 times the near field length, and for a point target focus (PTF) the maximum practical focal length is 0.8 times the near field length. Optical limit focus (OLF) focal length is not specifically constrained, but it should be understood that the actual maximum response point from a given target may not correspond to the distance indicated by the OLF focal length.

FPF and PTF transducers with focal lengths beyond these maximums, but less than the near field length, will usually be weakly focused units with only a small increase in sensitivity at the focal point. As a practical matter, there may be no functional advantage to a weakly focused transducer over a flat, unfocused transducer. In addition to acoustic limitations on maximum focal lengths, there are mechanical limitations on minimum focal lengths. Consult us for detailed information on focusing parameters.

"Table 1 - Near Field Distance of Flat Transducers in Water" on page 51 lists the near field distances as well as the minimum and maximum practical focal lengths for common frequency-element diameter combinations. Consult us for detailed information in focusing parameters.

Focal Length Variations due to Acoustic Velocity and Geometry of the Test Part

The measured focal length of a transducer is dependent on the material in which it is being measured. This is due to the fact that different materials have different sound velocities. When specifying a transducer's focal length it is typically specified for water. Since most materials have a higher velocity than water, the focal length is effectively shortened. This effect is caused by refraction (according to Snell's Law) and is illustrated in Figure (18).

Fig. 18

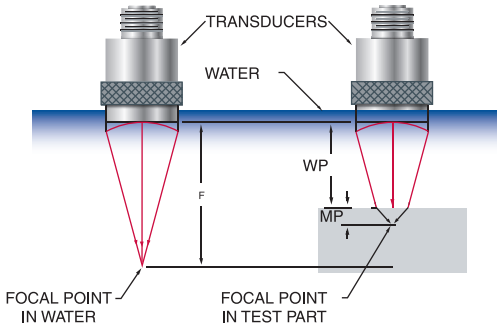

This change in the focal length can be predicted by Equation (13).

For example, given a particular focal length and material path, this equation can be used to determine the appropriate water path to compensate for the focusing effect in the test material.

Eqn. 13

$$WP = F - MP(c_{tm}/c_w)$$

WP	=	Water Path
MP	=	Material Depth
F	=	Focal Length in Water
c_{tm}	=	Sound Velocity in the Test Material
c_w	=	Sound Velocity in Water

In addition, the curvature of surface of the test piece can affect focusing. Depending on whether the entry surface is concave or convex, the sound beam may converge more rapidly than it would in a flat sample or it may spread and actually defocus.

Focusing Gain

Focused immersion transducers use an acoustic lens to effectively shift the location of the Y_0^+ point toward the transducer face. The end result can be a dramatic increase in sensitivity. Figure (19) illustrates the relative increase in signal amplitude from small defects due to focusing where S_F is the normalized focal length and is given by Equation (14). The amplitude from a small defect cannot exceed the echo amplitude from a flat plate.

Eqn. 14

$$S_F = F/N$$

S_F	=	Normalized Focal Length
F	=	Focal Length
N	=	Near Field

Fig. 19

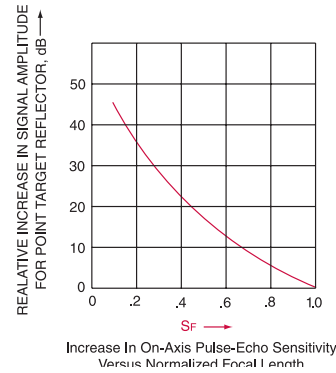

For example, the chart can be used to determine the increase in on-axis pulse-echo sensitivity of a 2.25 MHz, 1.0 in. element diameter transducer that is focused at 4 inches. The near field length of this transducer is 9.55 in., and the normalized focal length is 0.42 (4.0 in./9.55 in.). From the chart it can be seen that this will result in an increase in sensitivity of approximately 21 dB.

Focusing gain (dB) for cylindrical focuses can be estimated as being $\frac{3}{4}$ of the gain for spherical focuses.

e. Normal Incidence Shear Wave Transducers

Normal Incidence Shear Wave transducers incorporate a shear wave crystal in a contact transducer case. Rather than using the principles of refraction, as with the angle beam transducers, to produce shear waves in a material, the crystal itself produces the shear wave.

Typically these transducers are used to make shear velocity measurements of materials. This measurement, along with a longitudinal velocity measurement can be used in the calculation of Poisson's Ratio, Young's Modulus, and Shear Modulus. These formulas are listed below for reference.

Eqn. 15

$$\sigma = \frac{1 - 2(V_T/V_L)^2}{2 - 2(V_T/V_L)^2}$$

Eqn. 16

$$E = \frac{VL^2\rho(1 + \sigma)(1 - 2\sigma)}{(1 - \sigma)}$$

Eqn. 17

$$G = V_T^2\rho$$

σ	=	Poisson's Ratio
V_L	=	Longitudinal Velocity
V_T	=	Shear (Transverse) Velocity
ρ	=	Material Density
E	=	Young's Modulus
G	=	Shear Modulus

Because shear waves do not propagate in liquids, it is necessary to use a very viscous couplant when making measurements with these. When using this type of transducer in a through transmission mode application, it is important that direction of polarity of each of the transducers is in line with the other. If the polarities are 90° off, the receiver may not receive the signal from the transmitter.

Technical Notes

5. Transducer Excitation Guidelines

As a general rule, all of our ultrasonic transducers are designed for negative spike excitation. The maximum spike excitation voltages should be limited to approximately 50 volts per mil of piezoelectric transducer thickness. Low frequency elements are thick, and high frequency elements are thin. A negative-going 600 volt fast rise time, short duration, spike excitation can be used across the terminals on transducers 5.0 MHz and lower in frequency. For 10 MHz transducers, the voltage used across the terminals should be halved to about 300 V as measured across the terminals.

Although negative spike excitation is recommended, continuous wave or tone burst excitations may be used. However there are limitations to consider when using these types of excitation. First, the average power dissipation to the transducer should not exceed 125 mW to avoid overheating the transducer and depoling the crystal.

Since total average power depends on a number of factors such as voltage, duty cycle and transducer electrical impedance, the following equations can be used to estimate the maximum excitation duration as well as the number of cycles in a burst to stay within the total power limitation:

Eqn. 18

$$V_{rms} = 1/2(0.707)V_{p-p}$$

Eqn. 19

$$P_{tot} = \frac{(Duty\ Cycle)(V_{rms})^2 \cos(\text{phase angle})}{Z}$$

Eqn. 20

$$\text{No. of Cycles in a Burst} = \frac{(\text{Freq.})(\text{Duty Cycle})}{\text{Rep Rate}}$$

Following is an example of how to use the above equations to calculate a duty cycle and number of cycles for a V310-SU transducer.

**V310-SU
Assuming:**

5.0M Hz, 0.25 in. element diameter, unfocused
100 V Peak-to-Peak
50 ohm nominal impedance at the transducer input impedance (Note: This value will vary from transducer to transducer and should be measured. An impedance plot can be ordered at the time of purchase if necessary.)
-45° Phase Angle
5 kHz Rep Rate

Step 1:

Calculate V_{rms}

$$V_{rms} = 1/2(0.707)V_{p-p}$$

$$V_{rms} = 1/2(0.707)(100) = 35.35\text{ V}$$

Rearrange Equation (19) to solve for the Duty Cycle. Use 0.125 W as P_{tot} , as this is the maximum recommended for any transducer.

Step 2:

$$\text{Duty Cycle} = \frac{Z \cdot P_{tot}}{(V_{rms})^2 \cdot \cos(\text{phase angle})}$$

$$= \frac{(50)(0.125)}{(35.35)^2 \cdot (\cos -45^\circ)}$$

$$= 0.007\text{ s/s}$$

This means 7 milliseconds of excitation in every 1000 milliseconds.

Step 3:

Number of cycles in the burst can now be calculated from Equation (20).

$$\text{No. Of Cycles in Burst} = (\text{Freq.})(\text{Duty Cycle}) \text{ Rep Rate}$$

$$= (5 * 10^6)(0.007)/(5 * 10^3)$$

$$= 7$$

6. Cables

The inside of a cable is made of three main components. They are the conductor, the dielectric, and shield/braid. These components are then surrounded by an outer protective jacket. Figure (20) shows a cross-sectional view of a typical cable. The conductor acts as the positive connection of the cable while the shield acts as the ground. The dielectric isolates the conductor from the shield.

Fig. 20

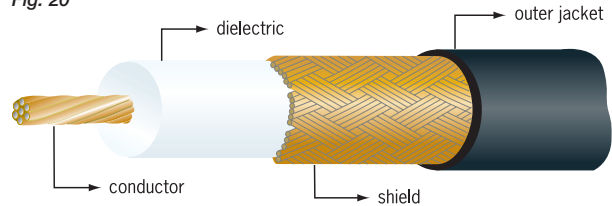

Most cables have one shielding/braided layer. However, to better prevent electrical interference from the environment double shielded cables have an additional shielding/braided layer in contact with the other.

The following is a list of standard cable grades we offer:

Type	Grade	Impedance	Nominal Diameter in.
15	Low Impedance	15 ohms	0.11
25	Low Impedance	25 ohms	0.10
58	RG58/U	50 ohms	0.20
62	RG62/U	93 ohms	0.24
74	RG174/U	50 ohms	0.11
188	RG188/U	50 ohms	0.11
316	RG316/U	50 ohms	N/A

RG/U is the abbreviation for “radio guide, universal” in the military, “RG” is the designation for coaxial cable and “U” stands for “general utility”. Most of the cables used in ultrasonic NDT have military RG numbers that define the materials, dimensions, and electrical characteristics of the cables.

The characteristic impedance of a coaxial cable is determined by the ratio for the inner diameter of the outer conductor (D) to the outer diameter of the inner conductor (d) and by the dielectric constant (E) of the insulating material between the conductors.

Eqn. 21

$$\text{Impedance } (Z_0) = \frac{138}{\sqrt{E}} \log(D/d) \Omega$$

The characteristic impedance can also be calculated from the capacitance (C) and the inductance (L) per unit length of cable

Eqn. 22

$$\text{Impedance } (Z_0) = \sqrt{\frac{L}{C}}$$

The most common values for coaxial cables are 50 ohm, 75 ohm, and 95 ohm. Note that the actual input impedance at a particular frequency may be quite different from the characteristics impedance of the cable due to the impedance of the source and load. In ultrasonics, on transmit the source is the pulser and the load is the transducer; on receive the source is the transducer and the load is the receiver. The complex impedance of the pulser and the transducers will reflect some of the electrical energy at each end of the cable. The amount of reflection is determined by the length of the cable, the frequency of the RF signal, and the electrical impedance of the cable and its termination. In ultrasonic NDT the effect of the cable is most practically determined by experimenting with the shorter and longer cables, with cables of differing impedance, and by placing a 50 ohm feed-through attenuator at the pulser/receiver jack.

7. Near Field Distances of Flat Transducers in Water

Table 1 — Near Field Distance of Flat Transducers in Water

Frequency (MHz)	Element Diameter (in.)	N (in.)	Focal Length (PTF)**	
			Min. (in.)	Max. (in.)
0.5	1.50	4.757	2.15	3.80
	1.125	2.661	1.50	2.10
	1.00	2.095	1.25	1.65
	0.75	1.164	0.78	0.93
1.0	1.50	9.559	2.50	7.65
	1.125	5.366	1.90	4.30
	1.00	4.235	1.625	3.38
	0.75	2.372	1.00	1.90
2.25	0.50	1.043	0.60	0.80
	1.50	21.534	2.70	14.50
	1.125	12.099	2.15	9.50
	1.00	9.554	1.875	7.60
	0.75	5.364	1.00	4.30
	0.50	2.374	0.80	1.90
3.5	0.375	1.329	0.50	1.06
	0.25	0.584	0.35	0.45
	1.00	14.868	1.95	11.5
	0.75	8.350	1.00	6.65
	0.50	3.699	0.83	2.95
5.0	0.375	2.073	0.60	1.65
	0.25	0.914	0.385	0.70
	1.00	21.243	1.95	14.40‡
	0.75	11.932	1.00	9.50
	0.50	5.287	0.75	4.20
7.5	0.375	2.965	0.60	2.35
	0.25	1.309	0.43	1.00
	0.75	17.900	1.00	12.75‡
	0.50	7.933	0.75	6.30‡
10	1.00	42.490	2.00	20.00‡
	0.75	23.868	1.00	15.375‡
	0.50	10.579	0.75	8.40‡
	0.375	5.934	0.60	4.75‡
	0.25	2.622	0.46	2.10
15	0.50	15.870	0.75	11.75‡
	0.375	8.902	0.60	7.10‡
	0.25	3.935	0.50	3.15‡
20	0.25	5.247	0.50	4.20‡
	0.125	1.290	0.25	1.00‡
25	-	6.559	0.50	5.25‡

** Panametrics® Standard Case Style, Large Diameter Case Style, Slim Line Case Style, and Pencil Case Style Immersion Transducers with straight connectors (see "Immersion Transducers" starting on page 48) can be focused between the Minimum and Maximum Point Target Focal (PTF) distance limits listed in Table 1. Please consult Olympus before ordering a transducer focused outside these limits.

‡ Consideration should be given to attenuation effects which increase linearity and with the square of frequency and the square of bandwidth. In applications where long water paths are required the effects of frequency dependent attenuation should be checked per ASTM E 1065 Annex A7. It is advisable to consider the effects of frequency dependent attenuation if the focal distance equals or exceeds the following values:

The near field values in this table have been determined using the following equation:

$$N = \frac{D^2}{4\lambda} \left[1 - \left(\frac{\lambda}{D} \right)^2 \right]$$

Note that equations 8 and 8a on page 45 were derived from this expression. The calculations were carried out assuming an ultrasonic velocity in water of 0.586×10^5 in./s at 22 °C and using the actual transducer element diameters. It should be noted that the actual transducer element diameters are slightly smaller than the nominal element diameters listed in the tables in the catalog .

The minimum and maximum practical focal lengths have been calculated by considering the acoustic and mechanical limitations of each configuration. These limitations are a function of transducer frequency, element diameter, and case dimensions. There may be exceptions to the limits listed in the table.

Frequency MHz	Focal Length in.
5.0	13
7.5	6
10	3.5
15	1.5
20	0.8
25	0.5
30	0.4

8. Acoustic Properties of Materials

Table 2 — Acoustic Properties of Materials

Material	Longitudinal Velocity		Shear Velocity		Acoustic Impedance (kg/m ² s × 10 ⁹)
	(in/μs)*	(m/s)	(in/μs)*	(m/s)	
Acrylic resin (Perspex)	0.107	2,730	0.056	1,430	3.22
Aluminum	0.249	6,320	0.123	3,130	17.06
Beryllium	0.508	12,900	0.350	8,880	23.5
Brass, naval	0.174	4,430	0.083	2,120	37.30
Cadmium	0.109	2,780	0.059	1,500	24.02
Columbium	0.194	4,920	0.083	2,100	42.16
Copper	0.183	4,660	0.089	2,260	41.61
Glycerine	0.076	1,920	—	—	2.42
Gold	0.128	3,240	0.047	1,200	62.60
Inconel	0.29	5,820	0.119	3,020	49.47
Iron	0.232	5,900	0.127	3,230	45.43
Iron, cast					
(slow)	0.138	3,500	0.087	2,200	25.00
(fast)	0.220	5,600	0.126	3,220	40.00
Lead	0.085	2,160	0.028	700	24.49
Manganese	0.183	4,660	0.093	2,350	34.44
Mercury	0.057	1,450	—	—	19.66
Molybdenum	0.246	6,250	0.132	3,350	63.75
Motor Oil (SAE 20 or 30)	0.069	1,740	—	—	1.51
Nickel, pure	0.222	5,630	0.117	2,960	49.99
Platinum	0.156	3,960	0.066	1,670	84.74
Polyamide, (nylon, Perlon)					
(slow)	0.087	2,200	0.043	1,100	.40
(fast)	0.102	2,600	0.047	1,200	3.10
Polystyrene	0.092	2,340	—	—	2.47
Polyvinylchloride, PVC, hard	0.094	2,395	0.042	1,060	3.35
Silver	0.142	3,600	0.063	1,590	37.76
Steel, 1020	0.232	5,890	0.128	3,240	45.63
Steel, 4340	0.230	5,850	0.128	3,240	45.63
Steel, 302	0.223	5,660	0.123	3,120	45.45
Austenitic stainless Steel, 347	0.226	5,740	0.122	3,090	45.40
Austenitic stainless Tin	0.131	3,320	0.066	1,670	24.20
Titanium, Ti 150A	0.240	6,100	0.123	3,120	27.69
Tungsten	0.204	5,180	0.113	2,870	99.72
Uranium	0.133	3,370	0.078	1,980	63.02
Water (20 °C)	0.058	1,480	—	—	1.48
Zinc	0.164	4,170	0.095	2,410	29.61
Zirconium	0.183	4,650	0.089	2,250	30.13

* Conversion Factor: 1 m/s = 3.937 × 10⁻⁵ in/μs

Source: Nondestructive Testing Handbook 2nd Edition Volume 7
Ultrasonic Testing ASNT 1991 ed Paul McIntire

www.olympus-ims.com

OLYMPUS[®]

For enquiries - contact
www.olympus-ims.com/contact-us

OLYMPUS SCIENTIFIC SOLUTIONS AMERICAS CORP.

48 Woerd Avenue, Waltham, MA 02453, USA, Tel.: (1) 781-419-9300
12569 Gulf Freeway, Houston, TX 77034, USA, Tel.: (1) 281-922-9300

OLYMPUS NDT CANADA INC.

505, boul. du Parc-Technologique, Québec (Québec) G1P 4S9, Tel.: (1) 418-872-1155
1109 78 Ave, Edmonton (Alberta) T6P 1L8

OLYMPUS SCIENTIFIC SOLUTIONS AMERICAS CORP.
is certified to ISO 9001, ISO 14001, and OHSAS 18001.

*All specifications are subject to change without notice.

All brands are trademarks or registered trademarks of their respective owners and third party entities.
Copyright © 2016 by Olympus.

