

BODY FABRICATION

PANEL FASTENERS

These self-locking fasteners are widely used for fastening panels and hoods. They provide an easily operated, positive acting, shake proof fastener. Several styles to choose from. All are functional for steel, aluminum, and fiberglass installations.

BUTTONS

Accepts C73-505-10, C73-508-10, or C73-510-10 tabs with C73-525-10 springs.



FLAT



DOME



TECH TIP HOW TO MEASURE GRIP LENGTH If you are trying to match existing buttons on your application, follow these illustrations to determine the correct measurement. Grip length is measured from the rim surface in contact with the surface of the panel (A) and the actual fastened point of the spring (B). Diameter is (C).

TABS & SPRINGS

An assortment of tabs to choose from for your panel fastener installation.



C73-505-10



C73-508-10



C73-510-10



C73-525-10
*1-3/8" C-C HOLES

DOME STEEL

PACK OF (10)	SHANK DIA.	DIA. OF HEAD	GRIP	DISCOUNT PRICE PER PACK		
				1-5	6-9	10+
C73-562-10	.406	.700	.400	\$16.95	\$15.26	\$14.41
C73-563-10	.406	.700	.450	\$16.95	\$15.26	\$14.41
C73-564-10	.406	.700	.500	\$16.95	\$15.26	\$14.41
C73-565-10	.406	.700	.550	\$16.95	\$15.26	\$14.41
C73-566-10	.406	.700	.600	\$16.95	\$15.26	\$14.41
C73-567-10	.406	.700	.650	\$16.95	\$15.26	\$14.41

DOME ALUMINUM

PACK OF (10)	SHANK DIA.	DIA. OF HEAD	GRIP	DISCOUNT PRICE PER PACK		
				1-5	6-9	10+
C73-572-10	.406	.700	.400	\$17.95	\$16.16	\$15.26
C73-573-10	.406	.700	.450	\$17.95	\$16.16	\$15.26
C73-574-10	.406	.700	.500	\$17.95	\$16.16	\$15.26
C73-575-10	.406	.700	.550	\$17.95	\$16.16	\$15.26
C73-576-10	.406	.700	.600	\$17.95	\$16.16	\$15.26
C73-577-10	.406	.700	.650	\$17.95	\$16.16	\$15.26

FLAT STEEL

PACK OF (10)	SHANK DIA.	DIA. OF HEAD	GRIP	DISCOUNT PRICE PER PACK		
				1-5	6-9	10+
C73-582-10	.406	.700	.400	\$16.95	\$15.26	\$14.41
C73-583-10	.406	.700	.450	\$16.95	\$15.26	\$14.41
C73-584-10	.406	.700	.500	\$16.95	\$15.26	\$14.41
C73-585-10	.406	.700	.550	\$16.95	\$15.26	\$14.41
C73-586-10	.406	.700	.600	\$16.95	\$15.26	\$14.41
C73-587-10	.406	.700	.650	\$16.95	\$15.26	\$14.41

FLAT ALUMINUM

PACK OF (10)	SHANK DIA.	DIA. OF HEAD	GRIP	DISCOUNT PRICE PER PACK		
				1-5	6-9	10+
C73-592-10	.406	.700	.400	\$17.95	\$16.16	\$15.26
C73-593-10	.406	.700	.450	\$17.95	\$16.16	\$15.26
C73-594-10	.406	.700	.500	\$17.95	\$16.16	\$15.26
C73-595-10	.406	.700	.550	\$17.95	\$16.16	\$15.26
C73-596-10	.406	.700	.600	\$17.95	\$16.16	\$15.26
C73-597-10	.406	.700	.650	\$17.95	\$16.16	\$15.26

PACK OF (10)	TYPE	DISCOUNT PRICE PER PACK			BAG OF (20)	(1) BAG
		1-5	6-9	10+		
C73-505-10	REG LENGTH	\$6.95	\$6.26	\$5.91	C73-505-20	\$13.80
C73-508-10	LIGHT WEIGHT	\$7.95	\$7.16	\$6.76	C73-508-20	\$15.90
C73-510-10	LONG LENGTH	\$6.95	\$6.26	\$5.91	C73-510-20	\$13.90
C73-525-10*	SPRING	\$5.95	\$5.36	\$5.06	C73-525-20	\$11.90

*1-3/8" c-c holes and .425" tall.



STEEL SELF-EJECT BUTTONS

Accepts C73-500-10 tabs and C73-515-10 springs.

FLAT



WING



Rivet Spacing

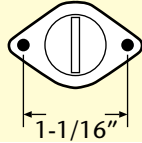

PACK OF (10)	SHANK DIA.	DIA. OF HEAD	GRIP	DISCOUNT PRICE PER PACK		
				1-5	6-9	10+
C73-598-10	.350	.625	.400	\$22.95	\$20.66	\$19.51
C73-599-10	.350	.625	.450	\$22.95	\$20.66	\$19.51
C73-600-10	.350	.625	.500	\$22.95	\$20.66	\$19.51
C73-601-10	.350	.625	.550	\$22.95	\$20.66	\$19.51
C73-602-10	.350	.625	.600	\$22.95	\$20.66	\$19.51
C73-603-10	.350	.625	.650	\$22.95	\$20.66	\$19.51

PACK OF (10)	SHANK DIA.	DIA. OF HEAD	GRIP	DISCOUNT PRICE PER PACK		
				1-5	6-9	10+
C73-610-10	.350	.625	.500	\$33.95	\$30.56	\$28.86

TECH TIP

HOW TO MEASURE GRIP LENGTH If you are trying to match existing buttons on your application, follow these illustrations to determine the correct measurement. Grip length is measured from the rim surface in contact with the surface of the panel (A) and the actual fastened point of the spring (B), Diameter is (C).

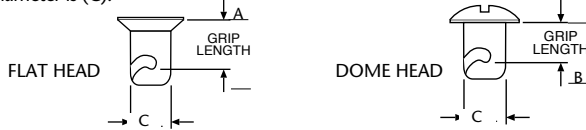

LARGE STEEL SELF-EJECT BUTTONS "PRO-STOCK STYLE"

These flat head Pro-Stock style buttons accept C73-500-10 tabs with C73-515-10 springs.



Rivet Spacing

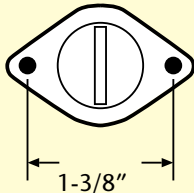

PACK OF (10)	SHANK DIA.	DIA. OF HEAD	GRIP	DISCOUNT PRICE PER PACK		
				1-5	6-9	10+
C73-612-10	.406	.750	.400	\$28.95	\$26.06	\$24.61
C73-613-10	.406	.750	.450	\$28.95	\$26.06	\$24.61
C73-614-10	.406	.750	.500	\$28.95	\$26.06	\$24.61
C73-615-10	.406	.750	.550	\$28.95	\$26.06	\$24.61
C73-616-10	.406	.750	.600	\$28.95	\$26.06	\$24.61
C73-617-10	.406	.750	.650	\$28.95	\$26.06	\$24.61

SELF-EJECT TAB & SPRING

Special tab and spring combination is designed to accept Self-Eject style panel fasteners.

C73-500-10



C73-515-10



PACK OF (10)	TYPE	DISCOUNT PRICE PER PACK			BAG	
		1-5	6-9	10+	OF (20)	(1) BAG
C73-500-10	TAB	\$7.95	\$7.16	\$6.76	C73-500-20	\$15.90
C73-515-10*	SPRING	\$6.95	\$6.26	\$5.91	C73-515-20	\$13.90

*1" c-c holes and .325" tall.

FABRICATION TOOLS

DZUS WRENCH

This handy wrench fits all Dzus style buttons.



PART #	DESCRIPTION	PRICE
C72-010	DZUS WRENCH	\$8.27

TRANSFER PUNCH

Use for accurate transfer of hole location on to attaching panel. Punch fits in tab with or without spring.



PART #	DESCRIPTION	PRICE
C73-544	TRANSFER PUNCH	\$8.45



DOUBLER PLATES

Aluminum construction is .040" thick and accepts Flat Head Style buttons. Rivets on location for increased strength of fiberglass, carbon fiber, and aluminum panels. Rivet holes measure 1/8" diameter, center hole measures .435" diameter.



PACK OF (10)	TYPE	DISCOUNT PRICE PER PACK	
		1-5	6+
C73-536-10	ROUND	\$9.45	\$8.51
C73-535-10	SQUARE	\$9.45	\$8.51

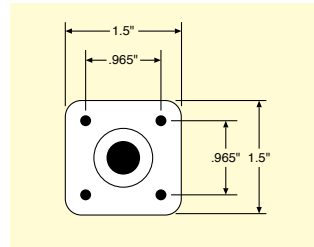
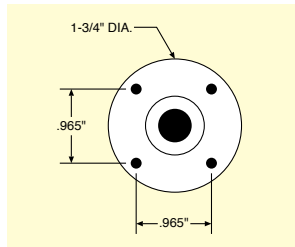

Both styles accept C73-525-10 springs, and may be used as spring reinforcement on the back side of panel or for wear plate on the front side.

DIMPLE TOOLS

These tools provide the professional quality dimple necessary for flat head button applications.

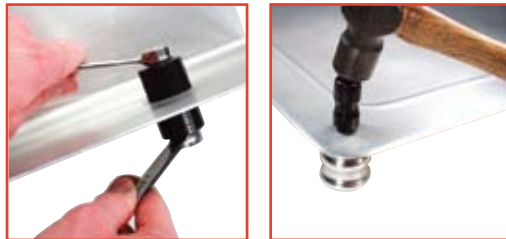

REF	PART #	DESCRIPTION	TYPE	PRICE
	C73-540	FLAT HEAD	WRENCH	\$17.95
(A)	C73-541	FLAT HEAD	HAMMER	\$20.95
(A)	C73-542	SELF EJECT	HAMMER	\$20.95
(A)	C73-543	LARGE SELF EJECT	HAMMER	\$20.95



SPRING ADJUSTER

Effectively adjusts installed fastener springs that are too tight or too loose. Universal design fits both C73-515-10 and C73-525-10 springs.

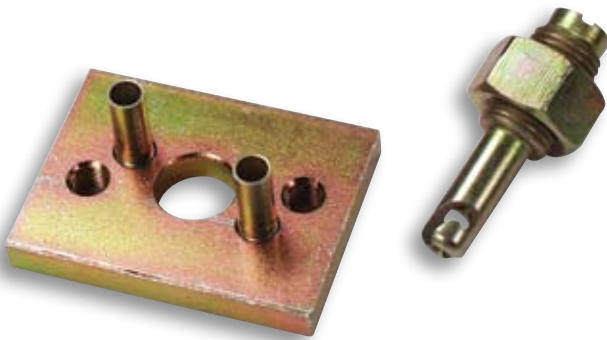

PART #	DESCRIPTION	PRICE
C73-545	SPRING ADJUSTER	\$39.75

Simplify assembly of your project by using one length button and adjusting the spring height for varied panel thickness.



ALUMINUM SPRING RIVETS

Special dual groove creates a large bulb to retain the spring. Rivets measure 1/8" in diameter and fit all sizes of Dzus springs.



PART #	DESCRIPTION	QTY. PER PACK	PRICE
C73-531	1/8" DIA.	10	\$1.10
C73-532	1/8" DIA.	100	\$8.95



CLECOS

Quick and easy to use, spring-loaded Cleco fasteners are inserted into drilled rivet holes to temporarily hold panels in place during fit up. Cleco pliers are required for installation. Complete kit includes pliers and quantity of 10 each of 3/32", 1/8", and 3/16" diameter Clecos.



C72-011

PART #	DESCRIPTION	QTY. PER PACK	PRICE
C72-008	KIT	1	\$33.50
C72-011	PLIERS	1	\$12.95
C72-013	3/32"	10	\$6.95
C72-015	1/8"	10	\$6.95
C72-019	3/16"	10	\$6.95



C72-008

LATCHES / SEATS

ACCESS DOOR KIT

Provides easy access to knobs, fill caps, and computers. Complete kit includes aluminum door, stop flange, hinge, access door release, and all mounting hardware.



Installed



C73-492



C73-490

PART #	DOOR	PRICE
C73-492	8" x 12"	\$72.95
C73-490	5" x 5"	\$60.95

ESCAPE HATCH LATCH

Positive locking and easily released, these latches are constructed of stainless steel and anodized aluminum for corrosion resistance.



C73-481



C73-482



C73-483



C73-484

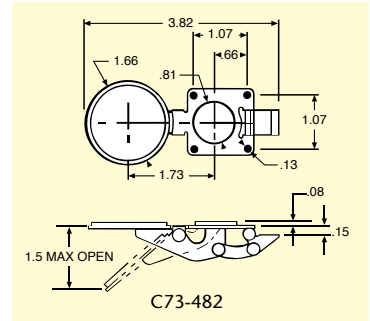

PART #	HOOK	PRICE
C73-481	SMALL BUTTON - FLAT HOOK	\$44.95
C73-482	LARGE BUTTON - FLAT HOOK	\$44.95
C73-483	SMALL BUTTON - LONG HOOK	\$57.86
C73-484	LARGE BUTTON - LONG HOOK	\$57.86

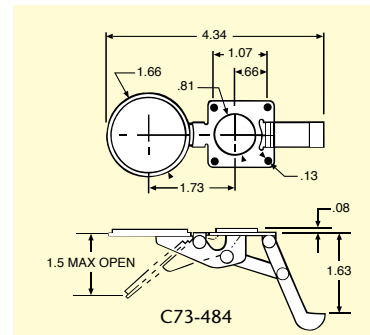

COMPOSITE DRAGSTER SEAT

These lightweight hand laid composite seats may be used in dragsters, altered, or funny cars. Seats are flexible enough to adjust in width if needed. Available in Carbon Fiber and Fiberglass. Standard seat measures 20-1/2" wide at top, 28" tall along back, and 17" wide at bottom front, wide seat is 19" wide at bottom front.



ACCESS DOOR RELEASE

This flush mounted release is made of stainless steel, with 1/16" offset. Spring is loaded and equipped with positive lock. It is ideal for access doors.



PART #	DESCRIPTION	PRICE
C73-480	ACCESS DOOR RELEASE	\$24.50

ALUMINUM HINGE

Perfect for access doors. Lightweight aluminum is 1/16" thick x 1-1/16" wide x 12" long.



PART #	DESCRIPTION	PRICE
C73-485	ALUM HINGE	\$6.50

PART #	DESCRIPTION	AVERAGE WEIGHT	PRICE
C42-028	STD FIBERGLASS	4#	\$181.95
C42-029	STD CARBON FIBER	2#	\$377.95
C42-031	WIDE FIBERGLASS	4#	\$181.95
C42-032	WIDE CARBON FIBER	2#	\$377.95



Carbon fiber is stronger and lighter than fiberglass.

PLASTIC NACA DUCT WITH HOSE OUTLET

These high impact ducts with hose outlets allow air hose hook-up for direct routing of air.



Clear Ducts

CLEAR PLASTIC			
PART #	DESCRIPTION	HOSE OUTLET	PRICE
C42-002	3-1/2" W x 6-1/2" L	2-1/2"	\$32.95
C42-008	4-1/4" W x 9-1/4" L	3"	\$33.95



Black Ducts

BLACK PLASTIC			
PART #	DESCRIPTION	HOSE OUTLET	PRICE
C42-001	3-1/2" W x 6-1/2" L	2-1/2"	\$23.95
C42-007	4-1/4" W x 9-1/4" L	3"	\$24.95

HOSE KIT

Wire reinforced black neoprene flexible hose works with Pro-werks Plastic NACA Ducts.



PART #	I.D.	LENGTH	PRICE
C42-012	2-1/2"	10'	\$66.00
C42-013	3"	10'	\$66.00

NACA DUCTS

FIBERGLASS NACA DUCT

Lightweight hand laid fiberglass NACA ducts provide a positive low resistance method of fresh air entry or removal. They are easily attached with bonding compound or riveted on fiberglass, aluminum, or steel body panels. Flange width measures approximately 1".

C42-017



C42-016



C42-030



PART #	INLET SIZE	INLET DEPTH	PRICE
C42-016	3" W x 6-1/2" L	7/8"	\$27.95
C42-017	4" W x 9" L	1"	\$30.45
C42-030	7" W x 14" L	2"	\$47.95

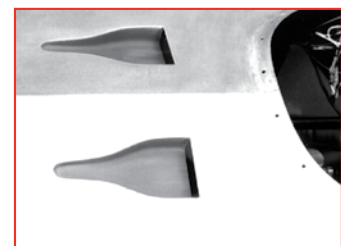

NACA Ducts Installed

Air Intake

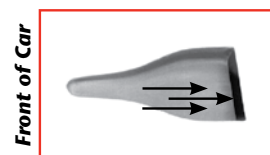

Air Removal

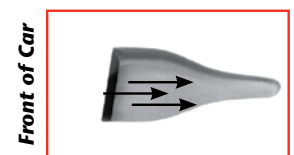



DRAGSTER WINDSCREEN

Measuring 1/8" thick, these windscreens are both flexible and durable. Made from scratch resistant GE Lexan, they are easily cut and sanded for installation. The protective coating dissolves with water after fitting.

CLEAR



CLEAR LEXAN			
PART #	DESCRIPTION	SIZE	PRICE
C42-014	STANDARD	7" H x 17" W x 33" L	\$203.95
C42-020	TALL	9" H x 17" W x 33" L	\$230.95
C42-024	WIDE	9" H x 20" W x 33" L	\$262.95
C42-026	JUNIOR	5" H x 14" W x 25" L	\$64.95

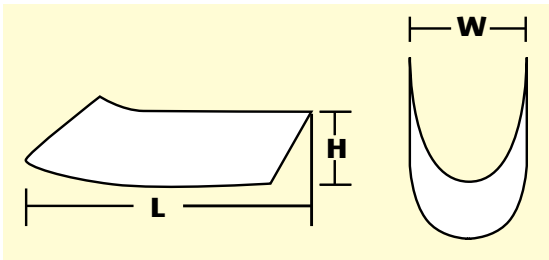

TINTED LEXAN			
PART #	DESCRIPTION	SIZE	PRICE
C42-015	STANDARD	7" H x 17" W x 33" L	\$230.95
C42-021	TALL	9" H x 17" W x 33" L	\$252.95
C42-025	WIDE	9" H x 20" W x 33" L	\$285.95
C42-027	JUNIOR	5" H x 14" W x 25" L	\$77.95

TINTED



DRAGSTER NOSE

These pieces are made of hand laid composite fiberglass. They may be trimmed to match height, length, and angle requirements. Noses measure 8-1/2" tall at back.

C42-022

* Dimensions:
8-1/2" wide,
8-1/2" tall at back,
25" long



PART #	DRAGSTER NOSE	SIZE	PRICE
C42-022	ECONO	8-1/2" W x 25" L	\$156.95
C42-023	FUEL	11-3/4" W x 28" L	\$176.95

C42-023

* Dimensions:
11-3/4" wide,
8-1/2" tall at back
28" long



WINDSCREEN FASTENER KIT

This secure fit fastener kit includes 100° counter sunk #8 flat head screws and Nylock Nuts.

PART #	DESCRIPTION	QTY. PER PACK	PRICE
C42-018	WINDSCREEN FASTENER KIT	24	\$12.95
C42-034	WINDSCREEN FASTENER KIT	100	\$49.95



FRONT CANARD WINGS

Durable all aluminum construction includes superior quality CNC machined ribs, measuring 10" deep. Available with wind tunnel proven NACA profiles. Mount tube is 1" outside diameter and aluminum skin is .032" thick. Wings are offered with three different tip plate profiles. Ribs are not available separately.

CANARD WINGS WITH INNER AND OUTER TIPS

For applications requiring inner and outer tip plates. Tip plate style "B" shown below.



Without inner tip plates for profile fit to body.

CANARD WINGS WITH OUTER TIPS

Overhang is 1-1/2". May be trimmed to match body contour. Wing tip profile "C" shown below left and style "A" shown below right.

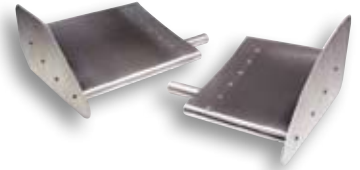

Wing Tip profiles

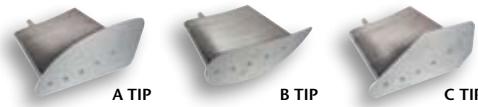

All tip plate profiles designed for equal performance.

WINGS W/ INNER AND OUTER TIPS			
PART #	WIDTH	TIP PLATE	PRICE
C42-123-AT	6"	A	\$429.95
C42-123-BT	6"	B	\$429.95
C42-123-CT	6"	C	\$429.95
C42-125-AT	8"	A	\$429.95
C42-125-BT	8"	B	\$429.95
C42-125-CT	8"	C	\$429.95
C42-127-AT	12"	A	\$429.95
C42-127-BT	12"	B	\$429.95
C42-127-CT	12"	C	\$429.95
C42-129-AT	14"	A	\$429.95
C42-129-BT	14"	B	\$429.95
C42-129-CT	14"	C	\$429.95

WINGS W/ OUTER TIPS			
PART #	WIDTH	TIP PLATE	PRICE
C42-122-AT	6"	A	\$379.95
C42-122-BT	6"	B	\$379.95
C42-122-CT	6"	C	\$379.95
C42-124-AT	8"	A	\$379.95
C42-124-BT	8"	B	\$379.95
C42-124-CT	8"	C	\$379.95
C42-126-AT	12"	A	\$379.95
C42-126-BT	12"	B	\$379.95
C42-126-CT	12"	C	\$379.95
C42-128-AT	14"	A	\$379.95
C42-128-BT	14"	B	\$379.95
C42-128-CT	14"	C	\$379.95
C42-132-AT	18"	A	\$429.95
C42-132-BT	18"	B	\$429.95
C42-132-CT	18"	C	\$429.95



Assembled with billet CNC machined ribs.

Replacement Canard Tip Plate Set

Outer Tips		
Part#	Description	Price
C42-156-A	A Style	\$49.95
C42-156-B	B Style	\$49.95
C42-156-C	C Style	\$49.95
Inner Tips		
C42-158-A	A Style	\$49.95
C42-158-B	B Style	\$49.95
C42-158-C	C Style	\$49.95

FRONT WING DOWNFORCE/DRAW DATA

Calculated values based on ideal environmental conditions & 12" x 10" wing size.

		50 MPH	100 MPH	150 MPH	200 MPH
8 °ANGLE OF ATTACK	DOWNFORCE	5.2 lbs	20.8 lbs	46.8 lbs	83.1 lbs
	DRAG	.05 lbs	.2 lbs	.4 lbs	.7 lbs
10 °ANGLE OF ATTACK	DOWNFORCE	5.5 lbs	22 lbs	49.4 lbs	87.9 lbs
	DRAG	.05 lbs	.2 lbs	.5 lbs	.8 lbs
12 °ANGLE OF ATTACK	DOWNFORCE	6.6 lbs	26.2 lbs	58.9 lbs	104.7 lbs
	DRAG	.1 lbs	.3 lbs	.6 lbs	1.1 lbs

ONE-PIECE WING

Measuring 10" deep, this wing features 1/4" thick mount tabs with 3/8" diameter front and 5/16" diameter rear holes with a 3-1/2" spacing. Includes your choice of interchangeable tip plates. Custom width and tab spacing available. Shown with "B" Tip Plate style.



PART #	WIDTH	TIP PLATE	MOUNT TAB CENTERLINE	PRICE
C42-116-AT-8	36"	A	8"	\$495.95
C42-116-BT-8	36"	B	8"	\$495.95
C42-116-CT-8	36"	C	8"	\$495.95
C42-118-AT-10	40"	A	10"	\$495.95
C42-118-BT-10	40"	B	10"	\$495.95
C42-118-CT-10	40"	C	10"	\$495.95

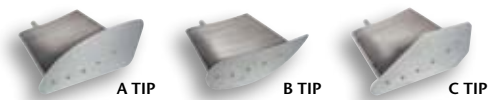

All tip plate profiles designed for equal performance.

REAR WINGS

Rear wings are built with CNC machined ribs and durable .032" thick aircraft aluminum skin using wind tunnel proven NACA wing profiles. Ribs have 15" cord length and wing is complete with internal reinforcement tubes. The 3/16" thick mount tabs have 3/8" diameter front and 5/16" diameter rear holes with 5-7/8" spacing. Tip plates are removable, interchangeable, and the profiles available are designed for equal performance. The ribs are not available separately. We can custom build wings up to 70" wide.

REAR WING



Shown with "A" Tip Plates



Shown with "B" Tip Plates

WING TIP PROFILES

All tip plate profiles designed for equal performance.



A TIPS



B TIPS



C TIPS



D TIPS



E TIPS



F TIPS

REAR WING DOWNFORCE/DRAW DATA

Calculated values based on ideal environmental conditions & 40" x 15" wing size.

		50 MPH	100 MPH	150 MPH	200 MPH
8 °ANGLE OF ATTACK	DOWNFORCE	27.8 lbs	111.3lbs	250.4 lbs	445.1 lbs
	DRAG	.3 lbs	1.0 lb	2.3 lbs	4.1 lbs
10 °ANGLE OF ATTACK	DOWNFORCE	32.4 lbs	129.5 lbs	291.5 lbs	517.9 lbs
	DRAG	.3 lbs	1.2 lbs	2.7 lbs	4.9 lbs
12 °ANGLE OF ATTACK	DOWNFORCE	36.2 lbs	144.6 lbs	325.5 lbs	578.6 lbs
	DRAG	.4 lbs	1.4 lbs	3.2 lbs	5.7 lbs

REPLACEMENT WING TIP PLATE SET

PART#	DESCRIPTION	PRICE
C42-160-A	A Style	\$69.95
C42-160-B	B Style	\$69.95
C42-160-C	C Style	\$69.95
C42-160-D	D Style	\$69.95
C42-160-E	E Style	\$69.95
C42-160-F	F Style	\$69.95

PART #	WIDTH	MOUNT TAB		PRICE
		PLATE	CENTERLINE	
C42-136-AT-8	36"	A	8"	\$505.95
C42-136-AT-15	36"	A	15"	\$505.95
C42-136-AT-17-1-4	36"	A	17-1/4"	\$505.95
C42-136-BT-8	36"	B	8"	\$505.95
C42-136-BT-15	36"	B	15"	\$505.95
C42-136-BT-17-1-4	36"	B	17-1/4"	\$505.95
C42-136-CT-8	36"	C	8"	\$505.95
C42-136-CT-15	36"	C	15"	\$505.95
C42-136-CT-17-1-4	36"	C	17-1/4"	\$505.95
C42-136-DT-8	36"	D	8"	\$505.95
C42-136-DT-15	36"	D	15"	\$505.95
C42-136-DT-17-1-4	36"	D	17-1/4"	\$505.95
C42-136-ET-8	36"	E	8"	\$505.95
C42-136-ET-15	36"	E	15"	\$505.95
C42-136-ET-17-1-4	36"	E	17-1/4"	\$505.95
C42-136-FT-8	36"	F	8"	\$505.95
C42-136-FT-15	36"	F	15"	\$505.95
C42-136-FT-17-1-4	36"	F	17-1/4"	\$505.95
C42-140-AT-15	40"	A	15"	\$505.95
C42-140-AT-17-1-4	40"	A	17-1/4"	\$505.95
C42-140-BT-15	40"	B	15"	\$505.95
C42-140-BT-17-1-4	40"	B	17-1/4"	\$505.95
C42-140-CT-15	40"	C	15"	\$505.95
C42-140-CT-17-1-4	40"	C	17-1/4"	\$505.95
C42-140-DT-15	40"	D	15"	\$505.95
C42-140-DT-17-1-4	40"	D	17-1/4"	\$505.95
C42-140-ET-15	40"	E	15"	\$505.95
C42-140-ET-17-1-4	40"	E	17-1/4"	\$505.95
C42-140-FT-15	40"	F	15"	\$505.95
C42-140-FT-17-1-4	40"	F	17-1/4"	\$505.95
C42-144-AT-15	44"	A	15"	\$505.95
C42-144-AT-17-1-4	44"	A	17-1/4"	\$505.95
C42-144-BT-15	44"	B	15"	\$505.95
C42-144-BT-17-1-4	44"	B	17-1/4"	\$505.95
C42-144-CT-15	44"	C	15"	\$505.95
C42-144-CT-17-1-4	44"	C	17-1/4"	\$505.95
C42-144-DT-15	44"	D	15"	\$505.95
C42-144-DT-17-1-4	44"	D	17-1/4"	\$505.95
C42-144-ET-15	44"	E	15"	\$505.95
C42-144-ET-17-1-4	44"	E	17-1/4"	\$505.95
C42-144-FT-15	44"	F	15"	\$505.95
C42-144-FT-17-1-4	44"	F	17-1/4"	\$505.95
C42-148-AT-15	48"	A	15"	\$559.95
C42-148-AT-18	48"	A	18"	\$559.95
C42-148-BT-15	48"	B	15"	\$559.95
C42-148-BT-18	48"	B	18"	\$559.95
C42-148-CT-15	48"	C	15"	\$559.95
C42-148-CT-18	48"	C	18"	\$559.95
C42-148-DT-15	48"	D	15"	\$559.95
C42-148-DT-18	48"	D	18"	\$559.95
C42-148-ET-15	48"	E	15"	\$559.95
C42-148-ET-18	48"	E	18"	\$559.95
C42-148-FT-15	48"	F	15"	\$559.95
C42-148-FT-18	48"	F	18"	\$559.95

Custom widths and tab spacing available.

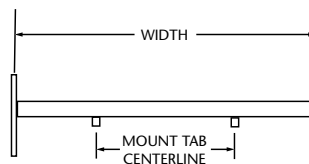

Standard mount tab spacing is available or positioned to your specifications.



Assembled with billet CNC machined ribs.

WING STRUT KITS

Kits include chromoly tubing, mount tabs, wing adjusters, and hardware. Dragster style kits have 44" main supports and altered style kits have 24" main supports. These kits are sized for comp class cars and do not meet SFI specifications required for some applications.

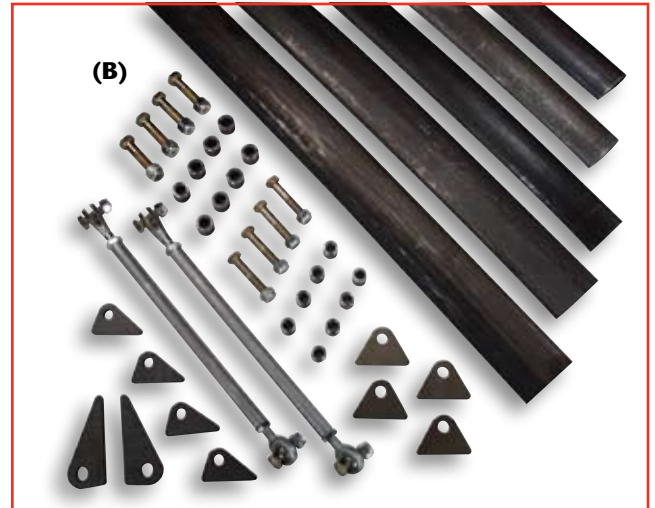
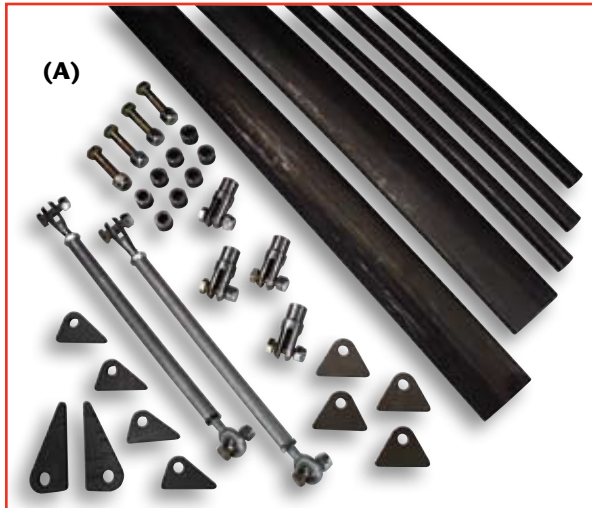

ALTERED APPLICATIONS				
REF	PART #	MAIN STRUTS	DIAGONALS	PRICE
(A)	C42-212	STREAMLINE	ROUND	\$336.95
(B)	C42-213	STREAMLINE	STREAMLINE	\$473.95
(C)	C42-202	ROUND	ROUND	\$279.95

DRAGSTER APPLICATIONS				
REF	PART #	MAIN STRUTS	DIAGONALS	PRICE
(A)	C42-210	STREAMLINE	ROUND	\$415.95
(B)	C42-211	STREAMLINE	STREAMLINE	\$531.95
(C)	C42-200	ROUND	ROUND	\$299.95



WING ADJUSTER KIT

Includes aluminum adjuster links (7-3/4" long), left hand 5/16" rod ends, and right hand threaded slot clevis with 3/16" slot and 5/16" hole.



PART #	DESCRIPTION	QTY. PER PACK	PRICE
C42-182	ADJ LINK KIT	2	\$99.95
C42-180	ADJ LINKS ONLY	1	\$15.95

CLEVISES / QUICK PINS

SLOT CLEVISES

Weld-in slot clevises, made from 4130 chromoly, assist in overcoming many fabrication obstacles. Available for tubing sizes 1/2" to 1-1/8" with all appropriate holes and slots.

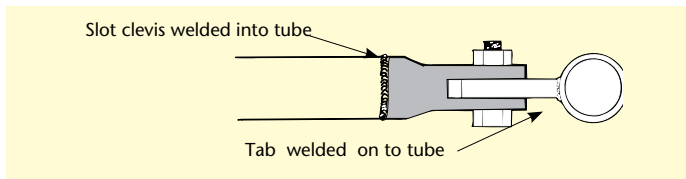

PACK OF (2)	FITS TUBE SIZE	SLOT	HOLE	PRICE PER PACK	BAG OF (20)	PRICE PER BAG
C73-962-2	1/2" O.D. x .058"	1/8"	1/4"	\$15.00	C73-962-20	\$120.00
C73-964-2	5/8" O.D. x .058"	1/8"	5/16"	\$15.00	C73-964-20	\$120.00
C73-965-2	3/4" O.D. x .058"	3/16"	5/16"	\$15.80	C73-965-20	\$126.40
C73-966-2	3/4" O.D. x .058"	3/16"	3/8"	\$15.80	C73-966-20	\$126.40
C73-970-2	7/8" O.D. x .058"	3/16"	3/8"	\$17.30	C73-970-20	\$138.40
C73-976-2	1" O.D. x .058"	3/16"	3/8"	\$18.50	C73-976-20	\$148.00
C73-978-2	1" O.D. x .058"	1/4"	3/8"	\$18.50	C73-978-20	\$148.00
C73-987-2	1-1/8" O.D. x .058"	1/4"	3/8"	\$20.20	C73-987-20	\$161.60
C73-995-2	1-1/2" O.D. x .120"	1/2"	1/2"	\$38.10	C73-995-20	\$304.80
C73-997-2	1-3/4" O.D. x .120"	5/8"	5/8"	\$45.00	C73-997-20	\$360.00

SLOT CLEVIS / QUICK PIN CROSS REFERENCE

SLOT CLEVIS	QUICK PIN
C73-962	C73-350
C73-964	C73-355
C73-965	C73-355
C73-966	C73-360
C73-970	C73-360
C73-976	C73-360
C73-978	C73-360
C73-987	C73-361



QUICK PINS

Zinc-plated steel quick pins allow for easy removal and installation of sidebars, radiator mounts, cross members, and wheelie bars.

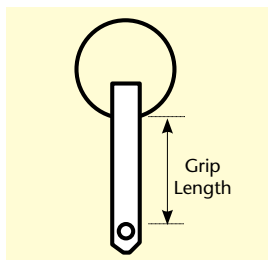

PACK OF (2)	DIAMETER x GRIP	PRICE
C73-350-2*	1/4 x .500"	\$7.69
C73-351-2	1/4 x .800"	\$7.69
C73-352-2	1/4 x 1"	\$7.69
C73-353-2	1/4 x 1.3"	\$7.78
C73-354-2	1/4 x 1.5"	\$7.78
C73-355-2*	5/16 x .800"	\$7.78
C73-356-2	5/16 x 1"	\$7.78
C73-357-2	5/16 x 1.3"	\$8.22
C73-358-2	5/16 x 1.5"	\$8.45
C73-360-2*	3/8 x .800"	\$8.45
C73-361-2*	3/8 x 1"	\$8.45
C73-362-2	3/8 x 1.3"	\$8.72
C73-363-2	3/8 x 1.5"	\$8.72
C73-364-2	3/8 x 2"	\$8.72

* Fits Pro-werks slot clevis.

THREADED SLOT CLEVIS

These clevises, with their threaded shank, offer maximum adjustability.



PACK OF (2)	THREAD SIZE	SLOT	HOLE	MATERIAL	PRICE
C73-491-2	10-32 RH	1/8	3/16	STAINLESS	\$29.95
C73-493-2	1/4-28 RH	1/8	3/16	STAINLESS	\$29.95
C73-494-2	3/8-24 RH	3/16	5/16	4130	\$35.75
C73-496-2	1/2-20 RH	1/4	3/8	4130	\$35.75

CO₂ BOTTLE

Aluminum CO₂ bottles are available in two sizes. The C72-088 o-ring seal listed below is recommended for positive seal.



PART #	BOTTLE	SIZE	PRICE
C72-080	10 OZ	16-3/4" x 2"	\$76.95
C72-084	2-1/2#	14" x 4-3/8"	\$94.45

These bottles use Thermo style valve.



BOTTLE KNOB

Lightweight knob features positive grip finger notches. Please measure bottle, knobs come in 2 sizes. Available in anodized black, red, blue, silver, or polished aluminum.

PART #	DESCRIPTION	PRICE
C72-250	BLACK BOTTLE KNOB, .290" square drive	\$27.95
C72-251	RED BOTTLE KNOB, .290" square drive	\$27.95
C72-252	BLUE BOTTLE KNOB, .290" square drive	\$27.95
C72-253	SILVER BOTTLE KNOB, .290" square drive	\$27.95
C72-254	POLISHED BOTTLE KNOB, .290" square drive	\$27.95
C72-260	BLACK BOTTLE KNOB, .320" square drive	\$27.95
C72-261	RED BOTTLE KNOB, .320" square drive	\$27.95
C72-262	BLUE BOTTLE KNOB, .320" square drive	\$27.95
C72-263	SILVER BOTTLE KNOB, .320" square drive	\$27.95
C72-264	POLISHED BOTTLE KNOB, .320" square drive	\$27.95



CO₂ REGULATOR

These brass CO₂ regulators are preset and non-adjustable at the pressure listed. Includes small diameter gauge that reads bottle pressure. Regulator has one 1/4" NPT outlet port.

REGULATOR W/ PART #	GAUGE	PRICE
C72-089	90#	\$70.45
C72-090	150#	\$70.45
C72-091	220#	\$73.45

PART #	DESCRIPTION	PRICE
C72-095	REPLACEMENT GAUGE 1/8 NPT 1-2000#	\$20.95

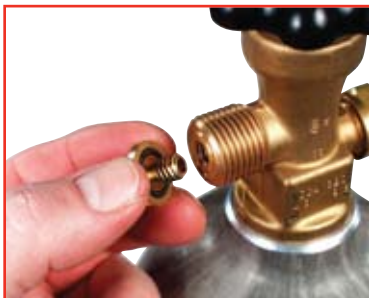

CO₂ BOTTLE ACCESSORIES

Quality replacement parts for your CO₂ applications.

PART #	DESCRIPTION	DETAIL	PRICE
C72-087	REPLACEMENT PRESSURE RELIEF	(3000#)	\$7.45
C72-088	O-RING SEAL	-	\$6.55
C72-094	PRESSURE RELIEF	-	\$7.45

BAR / NECK / UNIVERSAL MOUNTS

UNIVERSAL CLAMP

Provides secure mounting of remote reservoirs for shock absorbers without cylinder distortion. May also be used for fuel pumps, filters, exhaust pipes, etc. The micro-polished aluminum clamp may be flat mounted or accepts Pro-werks Bar Mount for clamping on round tubing. Clamp has two 1/4"-20 threaded mount holes with 2-5/8" spacing, measures 1/2" thick.



PART #	DIA.	PRICE
C72-320	1.910"	\$43.95
C72-321	1.935"	\$43.95
C72-322	2.010"	\$43.95
C72-324	2.437"	\$43.95
C72-325	2.475"	\$43.95
C72-326	2.5"	\$43.95

SOLD INDIVIDUALLY

NECK MOUNT

Provides mounting of fire extinguisher cylinders when clamping on the neck portion is required. Designed to be used with bottle mounts. May be flat mounted or accepts Pro-Werks bar mount for clamping on round tubing. Clamp has two 1/4"-20 threaded mount holes with 2-5/8" spacing, measures 1/2" thick.



PART #	DIA.	USE WITH BOTTLE MOUNT	PRICE
C72-165	1.215"	C72-104	\$46.95
C72-167	1.300"	C72-106	\$46.95
C72-168	1.300"	C72-108	\$46.95
C72-174	1.525"	C72-113	\$46.95
C72-175	1.600"	C72-113	\$46.95

SOLD INDIVIDUALLY



BAR MOUNT

Clamps around tubing and eliminates the need for welding on chassis. Accepts Pro-werks Bottle Mounts and Pro-werks Universal Clamps when attachment to round tubing is necessary. Ideal for add-on accessories such as fuel pumps and electronic devices. Mount base is 3-1/2" wide end to end and the 1/4" bolt spacing is 2-5/8", measures 1/2" thick.



PART #	DIA.	PRICE
C72-300	3/4"	\$34.95
C72-301	7/8"	\$34.95
C72-302	1"	\$34.95
C72-303	1-1/8"	\$34.95
C72-304	1-1/4"	\$34.95
C72-305	1-3/8"	\$34.95
C72-306	1-1/2"	\$34.95
C72-307	1-5/8"	\$34.95
C72-308	1-3/4"	\$34.95
C72-309	1-7/8"	\$34.95
C72-310	2"	\$34.95

SOLD INDIVIDUALLY



BOTTLE MOUNTS

BOTTLE MOUNT

Perfect for nitrous, CO2, and fresh air bottles. May be mounted on tabs or flat surface. Accepts Pro-werks Bar Mount for clamping on round tubing. Micro-polished 6061-T6 billet aluminum is CNC machined for accuracy with a lightweight, attractive design. Mounts have smooth radiused outside corners and two 1/4"-20 threaded mount holes with 2-5/8" spacing, measures 1/2" thick. The easy spin knob provides positive, secure clamping and quick bottle loading. Mounts are required by most sanctioning bodies and two mounts per bottle are recommended. The diameter listed is the actual bottle diameter. The clamp range is less than 1/16". To ensure proper fit, measure bottle before ordering.



PART #	DIA.	PRICE
C72-101	2"	\$43.95
C72-102	2-7/8"	\$43.95
C72-103	3.2"	\$43.95
C72-104	3.55"	\$43.95
C72-106	4"	\$46.95
C72-110	4-1/4"	\$46.95
C72-107	4-5/16"	\$46.95
C72-108	4-3/8"	\$46.95
C72-109	4-1/2"	\$46.95
C72-111	5"	\$49.95
C72-112	5.1"	\$49.95
C72-113	5-1/4"	\$49.95
C72-115	6.2"	\$63.95
C72-117	6.9"	\$63.95

SOLD INDIVIDUALLY

PART #	DESCRIPTION	PRICE
C72-099	REPL KNOB	\$3.95



LIGHTWEIGHT 2" BOTTLE MOUNT

Fits 2" diameter 10-ounce CO2 bottle. For flat mount application only – will not accept Pro-werks Bar Mount. Lightweight mount has two 1/4"-20 threaded mount holes with 1-1/2" spacing, measures 3/8" thick. It is recommended to use two mounts per bottle. If bar mountable version is required, order part # C72-101 listed above and necessary Bar Mount listed on page 37.



PART #	DIA.	PRICE
C72-100	2"	\$32.95

SOLD INDIVIDUALLY

CAPS & BUNGS

EASY TURN FILL CAP

This lightweight, **non-vented** cap features positive grip finger notches and quick-starting coarse threads. Caps are available in anodized black, red, blue, or polished aluminum. Each is standard with a radial squeeze o-ring seal. Assembly is provided with a choice of standard weld-in bung (aluminum and steel) or bolt-on bung (aluminum only).



CAP ASSEMBLY WITH STEEL WELD-IN BUNG				
PART #	CAP	THREAD	BUNG HEIGHT	PRICE
C73-730	1-5/8" BLACK	1-1/4-12	.500	\$28.95
C73-731	1-5/8" RED	1-1/4-12	.500	\$28.95
C73-732	1-5/8" BLUE	1-1/4-12	.500	\$28.95
C73-733	1-5/8" SILVER	1-1/4-12	.500	\$28.95
C73-734	1-5/8" POLISHED	1-1/4-12	.500	\$28.95
C73-750	2" BLACK	1-1/2-12	.500	\$31.95
C73-751	2" RED	1-1/2-12	.500	\$31.95
C73-752	2" BLUE	1-1/2-12	.500	\$31.95
C73-753	2" SILVER	1-1/2-12	.500	\$31.95
C73-754	2" POLISHED	1-1/2-12	.500	\$31.95
C73-770	2-3/4" BLACK	2-1/4-10	.625	\$36.55
C73-771	2-3/4" RED	2-1/4-10	.625	\$36.55
C73-772	2-3/4" BLUE	2-1/4-10	.625	\$36.55
C73-773	2-3/4" SILVER	2-1/4-10	.625	\$36.55
C73-774	2-3/4" POLISHED	2-1/4-10	.625	\$36.55

STEEL WELD-IN BUNG					
PART #	DESC.	HEIGHT	THREAD	CAP SIZE	PRICE
C73-745	1-1/2" O.D.	.500	1-1/4-12	1-5/8"	\$9.25
C73-745-L	1-1/2" O.D.	1"	1-1/4-12	1-5/8"	\$14.25
C73-745-XL	1-1/2" O.D.	2"	1-1/4-12	1-5/8"	\$16.25
C73-765	1-3/4" O.D.	.500	1-1/2-12	2"	\$9.25
C73-765-L	1-3/4" O.D.	1"	1-1/2-12	2"	\$14.25
C73-765-XL	1-3/4" O.D.	2"	1-1/2-12	2"	\$16.25
C73-785	2-3/4" O.D.	.625	2-1/4-10	2-3/4"	\$11.50

For Caps only and O-rings, see page 40.



Weld-On Bung



CAP ASSEMBLY WITH ALUMINUM WELD-IN BUNG				
PART #	CAP	THREAD	BUNG HEIGHT	PRICE
C73-735	1-5/8" BLACK	1-1/4-12	.500	\$28.95
C73-736	1-5/8" RED	1-1/4-12	.500	\$28.95
C73-737	1-5/8" BLUE	1-1/4-12	.500	\$28.95
C73-739	1-5/8" POLISHED	1-1/4-12	.500	\$28.95
C73-755	2" BLACK	1-1/2-12	.500	\$31.95
C73-756	2" RED	1-1/2-12	.500	\$31.95
C73-757	2" BLUE	1-1/2-12	.500	\$31.95
C73-759	2" POLISHED	1-1/2-12	.500	\$31.95
C73-775	2-3/4" BLACK	2-1/4-10	.625	\$36.55
C73-776	2-3/4" RED	2-1/4-10	.625	\$36.55
C73-777	2-3/4" BLUE	2-1/4-10	.625	\$36.55
C73-779	2-3/4" POLISHED	2-1/4-10	.625	\$36.55

ALUMINUM WELD-IN BUNG					
PART #	DESC.	HEIGHT	THREAD	CAP SIZE	PRICE
C73-747	1-5/8" O.D.	.500	1-1/4-12	1-5/8"	\$9.25
C73-747-L	1-5/8" O.D.	1"	1-1/4-12	1-5/8"	\$14.25
C73-747-XL	1-5/8" O.D.	2"	1-1/4-12	1-5/8"	\$16.25
C73-767	2" O.D.	.500	1-1/2-12	2"	\$9.25
C73-767-L	2" O.D.	1"	1-1/2-12	2"	\$14.25
C73-767-XL	2" O.D.	2"	1-1/2-12	2"	\$16.25
C73-787	2-3/4" O.D.	.625	2-1/4-10	2-3/4"	\$11.50



CAP ASSEMBLY WITH ALUMINUM BOLT-ON BUNG

PART #	CAP	THREAD	PRICE
C73-735-B	1-5/8" BLACK	1-1/4-12	\$39.95
C73-736-B	1-5/8" RED	1-1/4-12	\$39.95
C73-737-B	1-5/8" BLUE	1-1/4-12	\$39.95
C73-738-B	1-5/8" SILVER	1-1/4-12	\$39.95
C73-739-B	1-5/8" POLISHED	1-1/4-12	\$39.95
C73-755-B	2" BLACK	1-1/2-12	\$42.95
C73-756-B	2" RED	1-1/2-12	\$42.95
C73-757-B	2" BLUE	1-1/2-12	\$42.95
C73-758-B	2" SILVER	1-1/2-12	\$42.95
C73-759-B	2" POLISHED	1-1/2-12	\$42.95
C73-775-B	2-3/4" BLACK	2-1/4-12	\$48.95
C73-776-B	2-3/4" RED	2-1/4-12	\$48.95
C73-777-B	2-3/4" BLUE	2-1/4-12	\$48.95
C73-778-B	2-3/4" SILVER	2-1/4-12	\$48.95
C73-779-B	2-3/4" POLISHED	2-1/4-12	\$48.95

ALUMINUM BOLT-ON BUNG

PART #	DESCRIPTION	THREAD	CAP SIZE	BOLT CIRCLE	PRICE
C73-746	1-5/8"	1-1/4-12	1-5/8"	4 ON 2"	\$19.95
C73-766	2"	1-1/2-12	2"	4 ON 2.25"	\$19.95
C73-786	2-3/4"	2-1/4-10	2-3/9"	4 ON 2.625"	\$21.95



Bolt-On Bung



FILL CAP W/ O-RING

PART #	CAP	THREAD	PRICE
C73-740	1-5/8" BLACK	1-1/4-12	\$25.95
C73-741	1-5/8" RED	1-1/4-12	\$25.95
C73-742	1-5/8" BLUE	1-1/4-12	\$25.95
C73-743	1-5/8" SILVER	1-1/4-12	\$25.95
C73-744	1-5/8" POLISHED	1-1/4-12	\$25.95
C73-744-R	1-5/8" RAW	1-1/4-12	\$25.95
C73-760	2" BLACK	1-1/2-12	\$25.95
C73-761	2" RED	1-1/2-12	\$25.95
C73-762	2" BLUE	1-1/2-12	\$25.95
C73-763	2" SILVER	1-1/2-12	\$25.95
C73-764	2" POLISHED	1-1/2-12	\$25.95
C73-764-R	2" RAW	1-1/2-12	\$25.95
C73-780	2-3/4" BLACK	2-1/4-10	\$26.95
C73-781	2-3/4" RED	2-1/4-10	\$26.95
C73-782	2-3/4" BLUE	2-1/4-10	\$26.95
C73-784	2-3/4" SILVER	2-1/4-10	\$26.95
C73-784	2-3/4" POLISHED	2-1/4-10	\$26.95
C73-784-R	2-3/4" RAW	2-1/4-10	\$26.95



REPLACEMENT O-RING

PART #	APPLICATION	CAP SIZE	PRICE
C73-749	CAP	1-5/8"	\$2.15
C73-769	CAP	2"	\$2.15
C73-788	CAP	2-3/4"	\$2.45
C73-748	BOLT-ON BUNG	1-5/8"	\$2.15
C73-768	BOLT-ON BUNG	2"	\$2.15
C73-789	BOLT-ON BUNG	2-3/4"	\$2.45