



Advanced Solutions
for Document Processing



Panini Vision X Operator Manual



CONTENTS

0. Preface

1. General

- 1.1 Audience
- 1.2 Safety Precautions
- 1.3 If the Machine is Damaged

2. Learning about the Panini Vision X

- 2.1 Packaging List
- 2.2 External Parts Description
- 2.3 Internal Parts Description

3. Operating your Panini Vision X

- 3.1 Document Support Installation
- 3.2 Extension Plate Installation
- 3.3 Power Cables Connection
- 3.4 USB 2 Cable Connection
- 3.5 HP C6602A Ink-Jet Cartridge Installation
- 3.6 Pocket Length Adjustment



4. Getting started

- 4.1 Status Lights
- 4.2 How to Prepare and Load Checks
- 4.3 Clearing Jams

5. Maintenance

- 5.1 Cleaning the Transport
- 5.2 Cleaning the Contact Image Sensors
- 5.3 Cleaning the HP C6602A Ink-Jet cartridge
- 5.4 Cleaning Photocells Detector
- 5.5 Replacing the Feeder and Separator Rollers
- 5.6 Cleaning the Reading Transport Belt
- 5.7 Install the External Covers

6. Specifications

- 6.1 Technical specifications of the Panini Vision X
- 6.2 Technical specifications of the PC

7. Vision X SD Addendum

8. Vision X AGP Addendum

9. Vision X P Addendum

10. Multilingual WEEE Disposal Procedure and Safety Precautions



Advanced Solutions
for Document Processing



**Second Edition:
February 2008**

© **2008**

PANINI SpA

Via Po, 39

10124 Torino Italy

Internet: www.panini.com

PANINI NORTH

AMERICA

(Subsidiary)

577 Congress Park Drive

Dayton, OH 45459

(USA)

This manual and the software described in it are protected under the Panini S.p.A Copyright. All rights reserved. Reproduction of this material in any form without the express written consent of Panini SpA or its subsidiaries is prohibited.

PANINI SpA PROVIDES THIS MANUAL "AS IS" WITHOUT WARRANTY OF ANY KIND, EXPRESS OR IMPLIED, INCLUDING, BUT NOT LIMITED TO THE IMPLIED WARRANTIES OF MERCHANTABILITY AND FITNESS FOR A PARTICULAR PURPOSE. PANINI SpA MAY MAKE IMPROVEMENTS AND OR CHANGES IN THE PRODUCT(S) AND OR THE PROGRAM(S) DESCRIBED IN THIS MANUAL AT ANY TIME AND WITHOUT NOTICE.

This manual could contain technical inaccuracies or typographical errors. Changes are periodically made to the information herein; these changes will be incorporated in new editions of this publication.

Trademark Acknowledgement

PANINI, Vision X, Vision API, ICR Vision and MICR Plus are trademarks or registered trademarks of Panini SpA.

The mark  affixed to the product certifies that the product satisfies the basic quality requirements.



The Panini Vision X is also UL 950 compliant



NOTE: This equipment has been tested and found to comply with the limits for a Class A digital device, pursuant to Part 15 of the FCC Rules. These limits are designed to provide reasonable protection against harmful interference when the equipment is operated in a commercial environment. This equipment generates, uses, and can radiate radio frequency energy and, if not installed and used in accordance with the instruction manual, may cause harmful interference to radio communications. Operation of this equipment in a residential area is likely to cause harmful interference in which case the user will be required to correct the interference at his own expense.

© 2008 PANINI S.p.A., ALL RIGHTS RESERVED

Proper Disposal of WEEE

FOR COUNTRIES IN THE EUROPEAN UNION (EU)

The European Commission of the European Union has determined that electrical and electronic equipment on the market today contain parts and components that may be properly reused or recycled to reduce quantities of materials ultimately disposed in landfills and other disposal arenas. To address this determination, waste electrical and electronic equipment (WEEE) should not be collected or disposed with unsorted waste from private households or businesses. Rather, it must be collected separately. Dumping of these devices at unequipped and unauthorized places may have hazardous effects on health and environment. Offenders will be subjected to the penalties and measures laid down by the law.

To that end, Panini products are appropriately marked with the European Union WEEE Directive's crossed-out dustbin symbol to indicate the requirement for separate collection of electrical and electronic equipment put on the market after August 13, 2005, according to the WEEE directive 2002/96/EC (and subsequent amendments) and your national laws.



To dispose of our devices correctly:

- Contact the Local Authorities or local distributor, who will give you the practical information you need and the instructions for handling the waste correctly, for example: location and times of the waste collection centres, etc.
- When you purchase a new device of ours, give a used device similar to the one purchased to our distributor for disposal.

FOR OTHER COUNTRIES (NOT IN THE EU)

The treatment, collection, recycling and disposal of electric and electronic devices will be carried out in accordance with the laws in force in the country in question.

O. Preface

Here is an overview of the manual layout:

Chapter 1: "General" introduces you to all the general information regarding the manual or the Panini Vision X.

Chapter 2: "Learning about Panini Vision X" introduces you to all the major components of your machine.

Chapter 3: "Operating your Panini Vision X" describes simple installation procedures.

Chapter 4: "Getting started" explains how to operate the Vision X.

Chapter 5: "Maintenance" describes how to solve problems that you may encounter using this machine.

Chapter 6: "Specifications" lists the main functions of the Vision X and the features of the PC.



O. Preface

Chapter 7: "Vision X SD Addendum"

Chapter 8: "Vision X AGP Addendum"

Chapter 9: "Vision X P Addendum"

Chapter 10: "Multilingual WEEE Disposal Procedure and Safety Precautions" explains how to dispose the Vision X in 12 languages



1. General

Congratulations on your selection of the Panini Vision X!

The Panini Vision X is the next generation check scanning platform designed specifically for distributed check capture.

With a small footprint, sleek design and quiet operation, the Panini Vision X series is the ideal choice for a wide array of applications such as: Teller Window, Back Counter, Commercial Deposits, Microfilm Replacement, Cash Vault, Brokerage Houses, Accounts Receivable Conversion (ARC), just to name a few.

The Panini Vision X incorporates the latest, state-of-the-art technology and the latest standards for check processing in the marketplace. It is characterized by its ease of use and scalability.

A unique, patent-protected 3-mode feeder can be found in the Panini Vision X, allowing for single item feeding, up to 50 items batch feeding or up to 100 items batch insertion.

Panini Vision X image capture capabilities have been optimized in order to guarantee image integrity and perfect data readability despite variations in documents processed, operational skills, environmental and usage conditions.

MICR reading technology available with the Panini Vision X is comparable to the larger and faster reader sorter, thanks to the Panini MICR Plus™ technology.

Taking advantage of the most up to date technology, the Panini Vision X connects to computers via USB2.0 interface, allowing for fast data transfer at no additional cost.

A rear Ink-Jet endorser can also be found on the Panini Vision X.

The Panini Vision API is standard on the Vision X, guaranteeing easy and reliable software integration.

Finally, the Panini Vision X has been designed specifically to allow for entire track accessibility, including scanner area, for easy intervention and for maintenance purposes.



1.1 Audience

This manual is written primarily for personnel who process checks or other documents.

1.2 Safety Precautions

Before you begin operating or servicing your Vision X as instructed in this manual, please make sure you read and understand these important safety instructions.

- Dress safely. Do not wear loose clothing, long hair or jewelry that can become entangled in moving parts.
- Do not allow anything to rest on the power cord. Do not locate the Vision X where people may walk on the cord.
- Always unplug the Vision X before cleaning.
- Do not attempt to service or repair the Vision X, except as instructed elsewhere in this manual.
- Attempting to service or repair the external power supply of the Vision X may expose you to dangerous voltage points or other risks.
- Refer all servicing to qualified service personnel.

1.3 If the Machine is Damaged

Unplug the Vision X from the wall outlet and refer servicing to qualified personnel under the following conditions:

- If the power cord is damaged or frayed.
- If liquid has been spilled into the product.
- If the equipment has been exposed to rain or water.
- If the equipment does not operate normally when the operating instructions are followed.
- If the equipment has been dropped or damaged.
- If the equipment exhibits a distinct change in performance, indicating a need for service.

Adjust only those controls and replace only those items that are covered by the instructions in this manual. If you attempt to make adjustments not covered in this manual, you may damage the equipment and void the warranty.

Unauthorized adjustments or repairs may result in the need for extensive work by a qualified technician to return the equipment to its proper working condition.

2. Learning About the Panini Vision X

The Panini Vision X is a compact, easy-to-use and quiet scanner.

The Panini Vision X automatically scans the front and/or rear of checks while simultaneously capturing the Magnetic Ink Character Recognition (MICR) code line. An optional Ink-Jet endorser prints alphanumeric characters on the rear of items. Any of the Windows standard fonts can be used for printing endorsements. The Panini Vision X is connected to a PC via a USB2.0 interface.

2.1 Packaging List

The Panini Vision X package includes:

- Operator Manual (1)
- Accessories box (2)*
- Panini Vision X scanner unit (3)
- Power cable (4)

(*) The accessories box contains:

- Feeder Extension
- Extension plate
- Ink-Jet Cartridge HP C6602A
(Panini P/N: CA-00138-00)
Cartridge not included with No Ink Jet (NJ) versions
- Ink-Jet Plastic Lever (adapter for HP 51604A cartridge)
- USB 2 Cable
- Power Supply

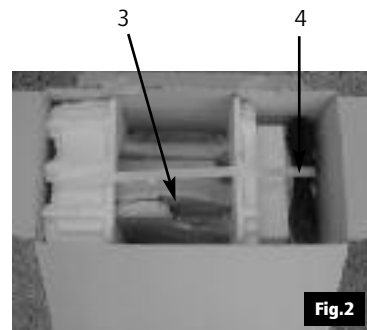
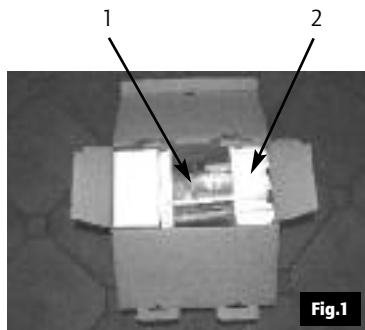

Removing the Panini Vision X from the Packaging

1. Remove the Accessories box, the operator manual and the power cable out of the packaging.
2. Holding the packaging down with one hand, lift the Vision X together with the packing materials making use of the plastic handle (Fig.3).

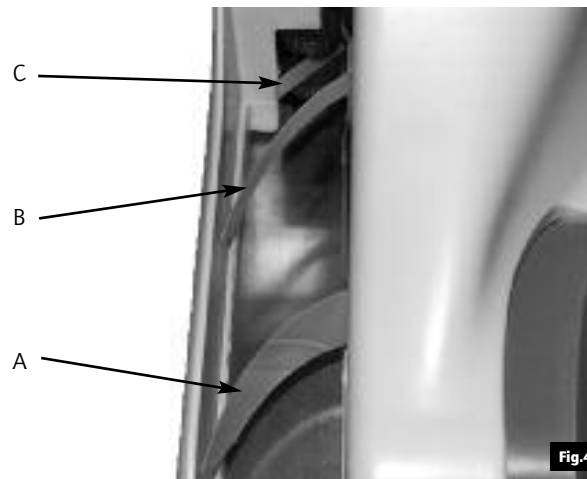
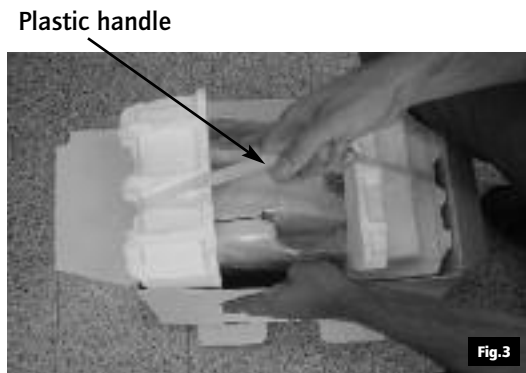

Attention:

- Don't use the plastic handle to carry the Vision X from one place to another. Use it only to extract the device from its packaging.
- During unpackaging, do not remove or pull the Mylar blades A, B and C (see Fig.4).

2.2 External Parts Description

This section describes the major components of the Panini Vision X. The component names introduced here and shown in the figures are used throughout this manual.

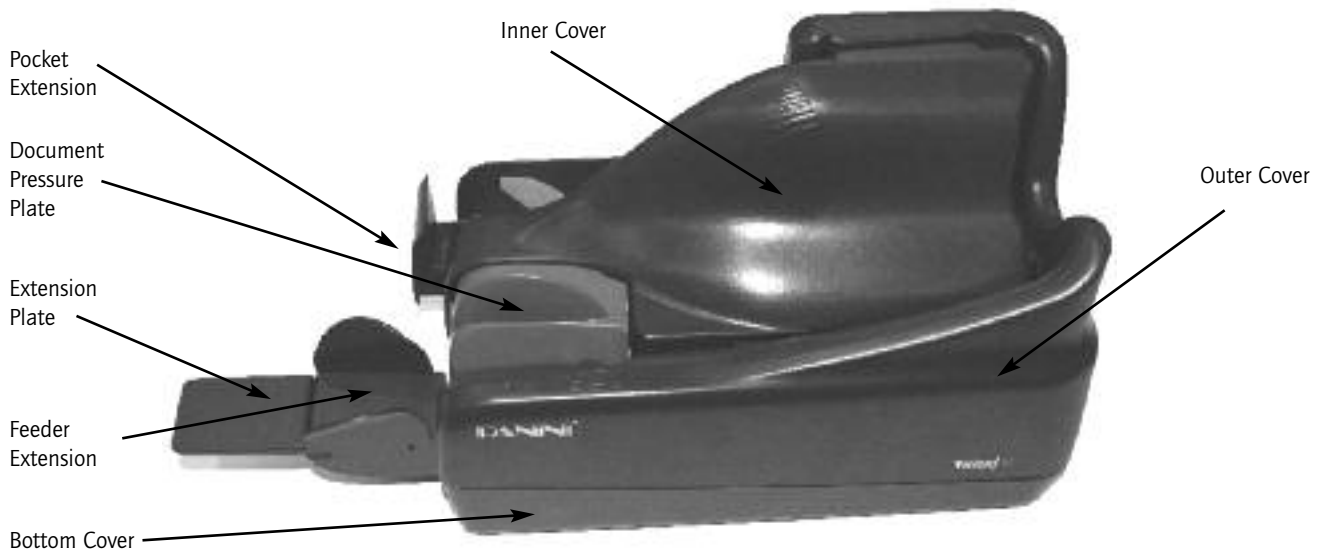
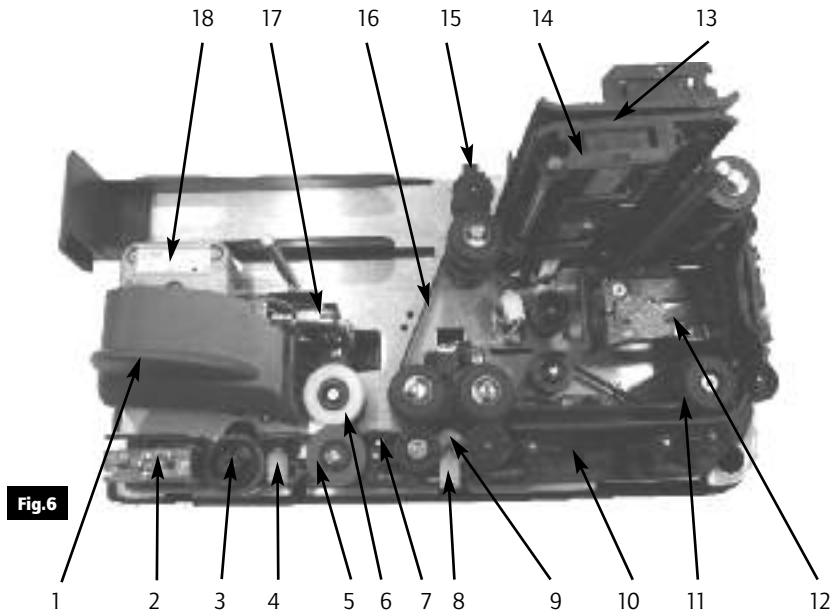

Fig.5

2.3 Internal Parts Description

- 1 Document Pressure Plate
- 2 LED board
- 3 Feeder Roller
- 4 Feeder Sensor
- 5 Separator Roller
- 6 Rear Separator Roller
- 7 Pre-magnetization Head
- 8 Synchronization Sensor
- 9 MICR Reading Head
- 10 "U" Track Wall
- 11 Transport Rollers
- 12 Ink-Jet Cartridge Cradle
- 13 Front Image Camera
- 14 Rear Image Camera
- 15 Pocket sensor
- 16 Transport Belt
- 17 Interlock Board
- 18 Feeder Motor



3. Operating your Panini Vision X

3.1 Document Support Installation

Insert the Feeder Extension in the slot uncovered by pushing back the Document Pressure Plate. Installation is correct if the Feeder Extension is at the same level of the entrance of the scanner platform.

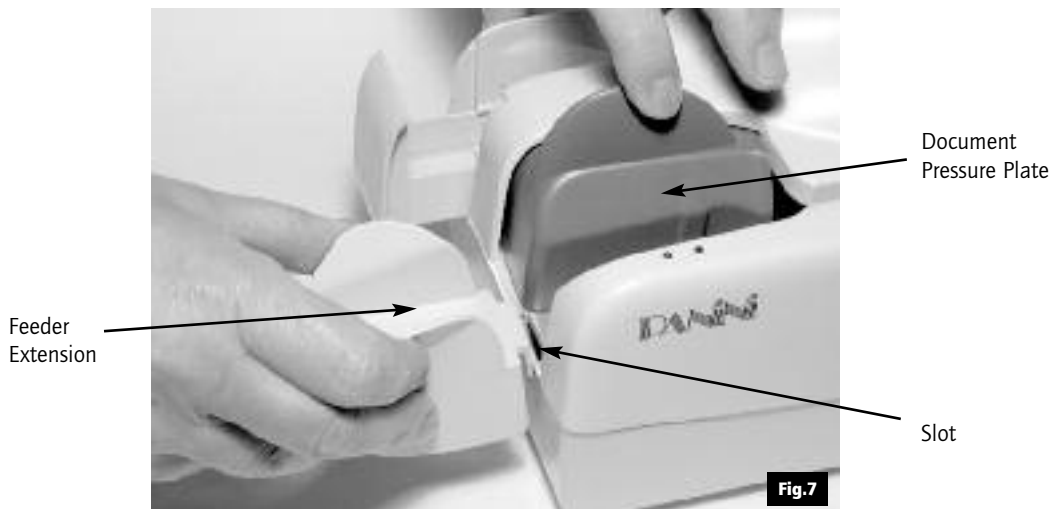

3.2 Extension Plate Installation

The feeder extension is designed to support all documents anticipated to be processed by the Vision X. Markets or applications that process a large number of long documents (longer than 8 inches) may find it necessary to apply the optional extension plate for better document support, reducing the risk of image skewing, MICR rejects, etc. Assembly is made by sliding the extension plate, face side up, along the bottom side of the feeder extension into the support notches until the plate snaps into place (Fig.8). The lock tabs should securely fit into the round holes and the short and long tabs should be fully inserted into the support notches (Fig.9).

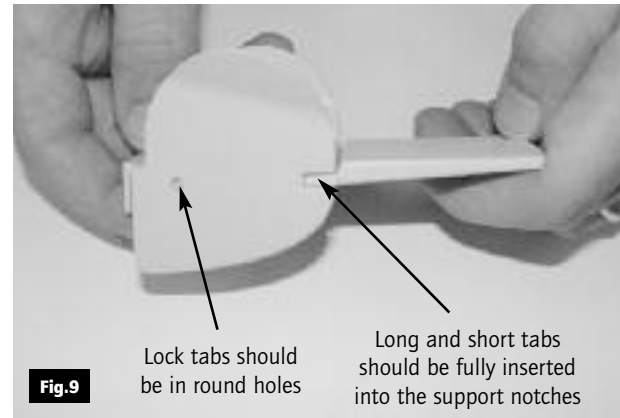
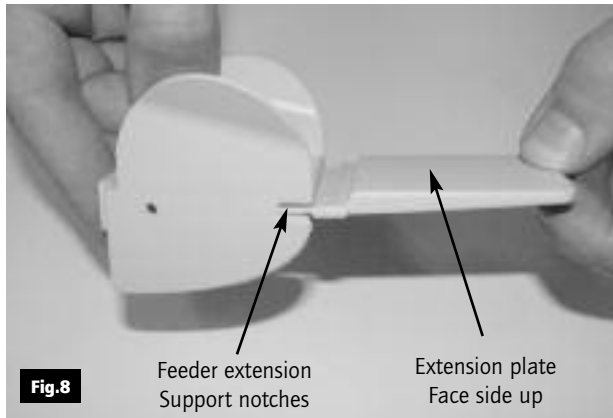

To remove, firmly grip the feeder extension and the extension plate and pull apart.

3.3 Power Cable Connection

Before connecting the scanner to your PC, make sure to locate the unit on a flat surface near the PC, away from direct light and from electromagnetic equipment.

1. Plug the power cord connector in the Power Supply socket (Fig.10).
2. Plug the Power Supply cable in the Vision X power connector (Fig.11).

Warning:

- The electromagnetic emission from a CRT monitor can produce interference and affect the MICR reading; therefore place the Vision X as far as possible from the CRT.
- The Vision X will be in compliance to the standard IEC/EN 60950-1 and UL 60950-1 only using the Power Supply model DSA-0421S-28 1 42 provided with the machine.



3. The Vision X should be plugged into a dedicated electrical power outlet. The socket outlet shall be installed near the equipment and shall be easily accessible. The power supply will be 100-240 VAC (no power selection required), and the frequency 50/60 Hz. If you are not sure of the type of power available, consult your Service Representative or local power company.

Note: There is no LED power indication upon connecting the Vision X. LED status indicators only illuminate when the application connects to the Vision X unit. See section 4.1.

3.4 USB 2 Cable Connection

Connect the USB 2 cable to the USB 2.0 port located on the rear side of the scanner, then connect the other end of the cable to an available USB 2.0 port on the PC.



3.5 HP C6602A Ink-Jet Cartridge Installation (*Optional)

Remove the inner cover (see section 5.1 for details).

Take a new Ink-Jet cartridge out from its package.

Do not touch the ink with your fingers or clothing; it will stain.

Angle the front side of the cartridge downwards and face the two pins with the two holes in the cradle.

Gently push down the rear side of the cartridge until it snaps in the plastic retainer.

* If the unit was purchased without the endorser option then the unit is shipped without an ink cartridge and that one is not needed to run the device.

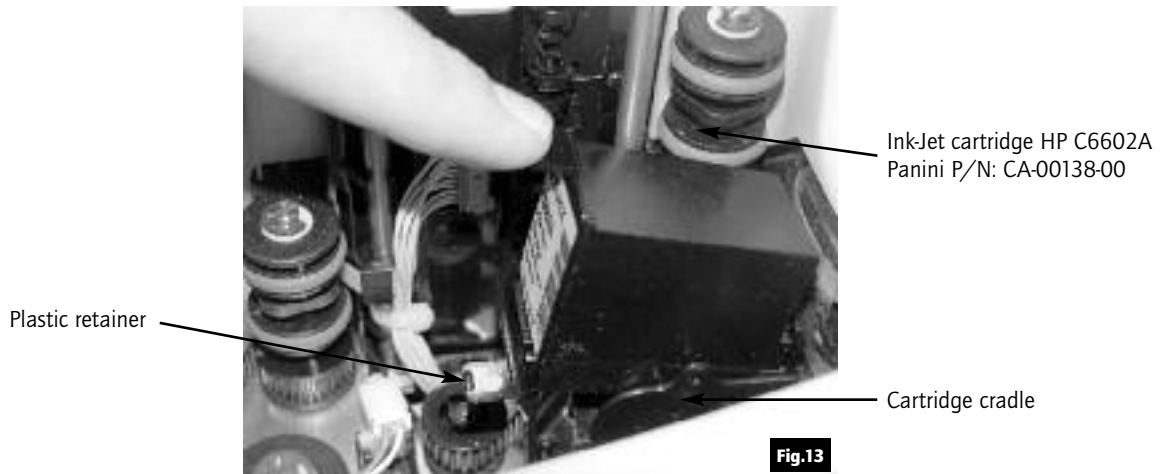

3.6 Pocket Length Adjustment

Adjust the pocket length by inserting the longest document that will be processed in the pocket. Move the pocket extension left or right until a space of 5 mm (1/4") is available between the leading edge of the document and the end of the pocket extension.

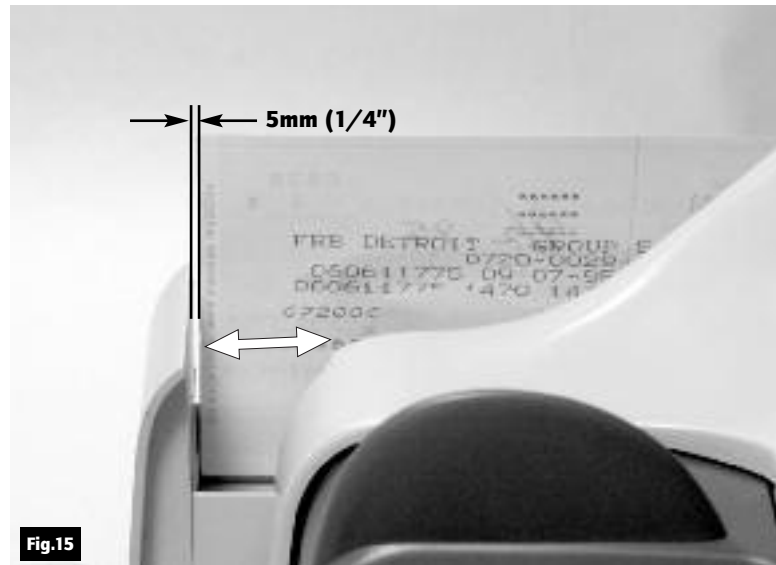

Fig.15



4. *Getting Started*

1. Turn on the PC.
2. Start the Vision X application (see note).
3. Follow the Vision X application instructions.
4. Load your checks.

Note: An application must be started before you begin to process documents. When the application starts, the Vision X turns on which is indicated by the green led in the outer cover.

If it is your job to start the application, refer to the documentation supplied with the application by the vendor.

Normally, the Vision X will automatically go on-line when the control application starts, and goes offline when the control application shuts down. If you want to force the reader to go offline even when the application is on, press the rear button switch for at least one second; at this point, the motor will briefly buzz and the green LED will turn off. To put the reader back on-line (only if the application is still running), press the button switch again for at least one second; the motors will briefly buzz and the green LED will turn on. Normally, this operation is allowed only when the Vision X is idle and will be ignored if the reader is working.

Pressing the button switch when the green LED is off will have no effect.

4.1 Status Lights

Two status lights located near the feeder indicate the status of the unit.

The following table describes the meaning of each status light.

Red LED	Green LED	Description
Off	Off	The Vision X is offline
Off	On	The Vision X is online and the feeder is empty
Off	Blinking	The Vision X is online and the feeder contains documents ready to feed
On	Off	Interlock switch is activated and the central plastic cover is removed
Blinking	Off	Jam on the transport track



Fig.16

Note: There is no LED power indication upon connecting the Vision X. LED status indicators only illuminate when the application connects to the Vision X unit.

4.2 How to Prepare and Load Checks

Preparing Documents for Processing

1. Remove all rubber bands, staples, paper clips, dog ears, etc. from the documents.
2. Jogging the documents is strongly recommended. In any case, align the bottom edges by repeatedly tapping the bottom edge of the documents on a hard, flat surface, see Fig.17.
3. Repeatedly tap the leading edge of the documents on a hard, flat surface, see Fig.18.
4. Check bottom and leading edges once more to ensure documents are aligned.

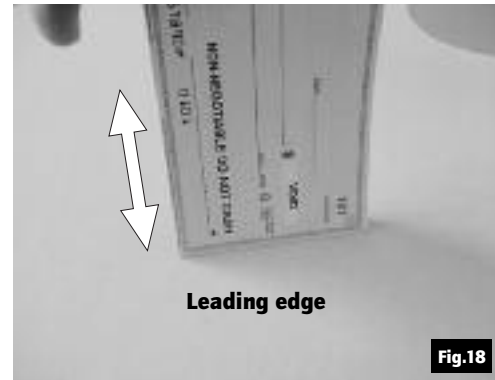
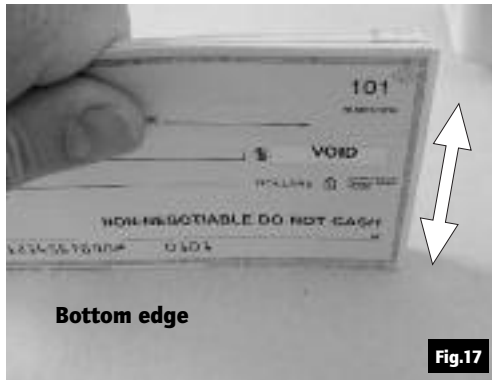

Tip: Use a mechanical jogger device for faster and more accurate alignment of bottom and leading edges.

Feeding Documents

You may feed documents one at a time or in small batches by inserting the documents all the way into the feeder. (Fig.19).

The documents must be inserted into the feeder so that the leading edge fits between the two black lines shown in Fig.20.

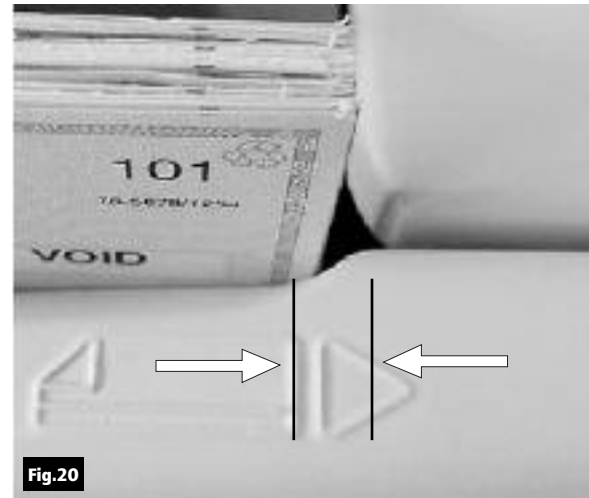

! *Do not insert the checks past the rollers.*

Larger batches up to 100 checks require the pressure plate be pushed back before inserting checks into the feeder.

To prevent misfeeding, do not insert more than 100 documents into the feeder. Leave at least 2 mm (1/8") between the last document and the pressure plate in the maximum backwards position. The leading edges of the documents should be aligned as described in the previous page.

Document Feeder Options

Depending on the configuration ordered, three feeder types are available:

1. Full Feeder (FF) Option:

Designed for both single document automatic insertion and up to 100 document batch processing.

2. Small Feeder (SF) Option:

Designed for both single document automatic insertion and up to 50 document batch processing.

Note: The small feeder option causes the automatic document feeding operation to stop, followed by a system warning message, after 50 consecutive documents have been processed, according to the ordered configuration. The feeder sensor must then be cleared by removing the documents from the feeder and then repositioning and restarting the application. All other features are the same as the Full Feeder.

Note: This option is reset if the feeder is emptied before the 50 document limit is met for the 50 documents limited feeder.

3. Single Document Feeder (1F) Option:

Designed to process documents one at a time with single document automatic insertion.

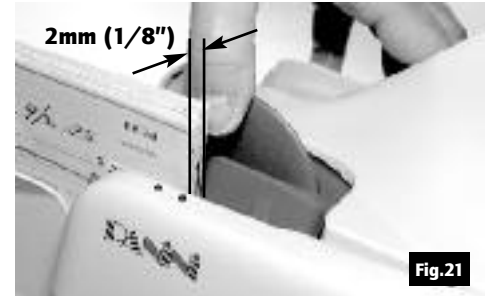

Fig.21

The feeder is designed so that checks can be loaded continuously, while the scanner is processing. This can be done by inserting checks behind those already present in the feeder.





Advanced Solutions
for Document Processing



Removing Documents from Pocket

Processed documents are sent to the exit pocket.

For best result, follow these recommendations:

- Remove the documents when the pocket is nearly full. Jams occur when the pocket is too full. No "pocket-full" sensor is available.
- Occasionally verify that the endorsements are clearly printed.
- Occasionally verify that the images are being properly captured and that the image quality is good.

4.3 Clearing Jams

When a jam occurs, the paper path must be cleared. To do this, first remove all the documents from the exit pocket and then free the track by pressing Eject in your application. In case of unsuccessful operation, apply the following suggestions:

1. Extract the jammed document simply by pulling it out with your fingers (see Fig.23).
2. If the document does not pull out , lift the inner cover at the point indicated by the ribbed surface as shown in Fig.24.



Fig.23

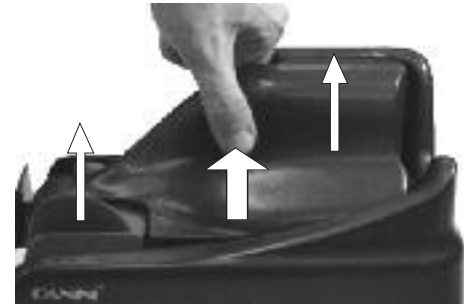
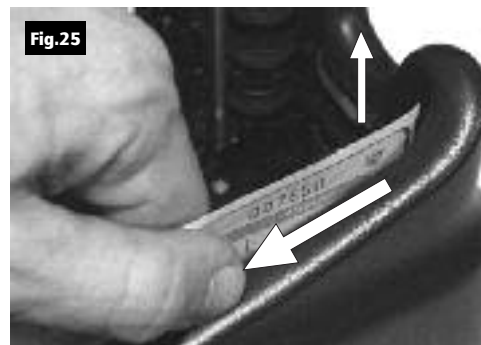

Fig.24

3. Grab the document with your fingers to remove it from the transport. (See Fig.25).



4. After the jam is removed, install the inner cover by following the instructions below:

- a. Open the pocket extension.
- b. Insert the two reference shafts in the corresponding housings found in the inner cover (See Fig.26).

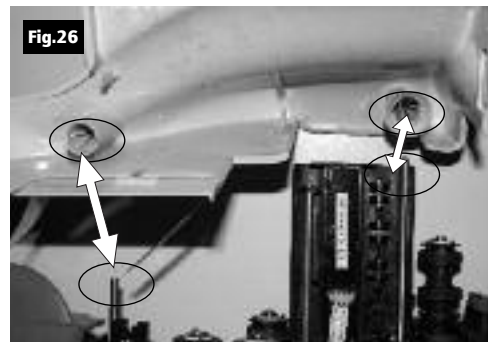

c. Push down the inner cover until it is back to its original position. Take care to ensure that the inner cover stays behind the scanner, which is indicated by a black area (see Fig.27).

The inner cover (grid) must be inserted behind the scanner (black)

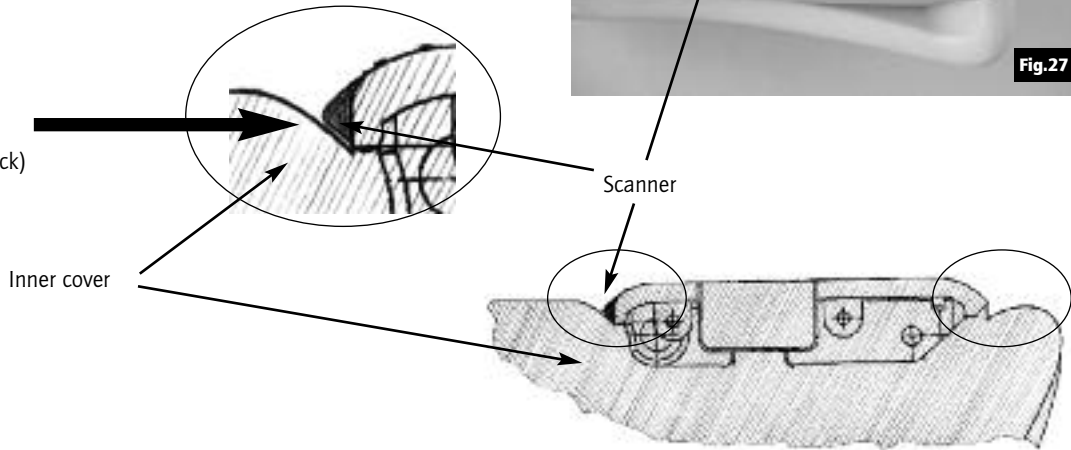

d. Check the exit pocket to ensure that the two plastic springs are aligned properly as shown in Fig.28.

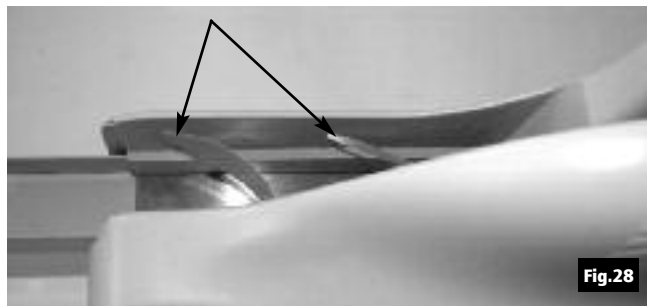

5. In the event that the outer cover has to be removed, first disconnect the USB and power cables and then lift the outer cover as shown in Fig.29.



6. To remove the “U” track wall see Fig.30.
Please follow the instructions listed in chapter 5.1.2.

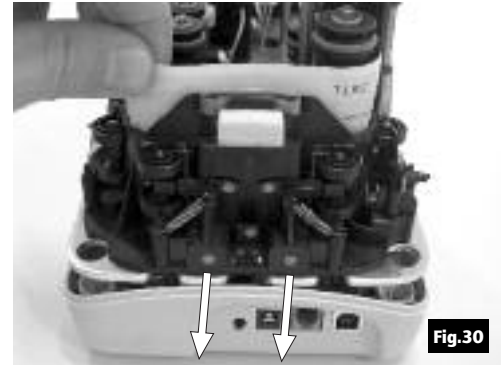

7. If the jam occurs in the image camera area,
it is advisable to open the front image camera
(see Fig.31) so that the document can easily be
removed.

! *Close the image camera carefully.
Don't allow the spring to snap it closed.*

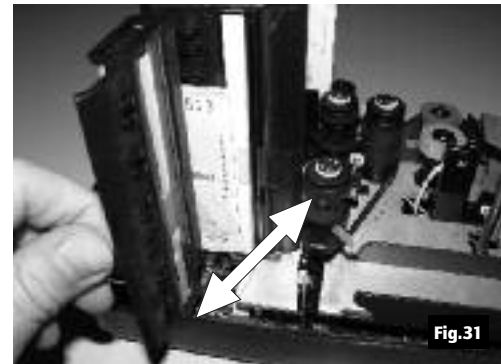

8. Insert the outer cover by aligning the two shafts with the holes in the bottom cover of the unit (Fig.32). Insert the two teeth located on each side of the outer cover in the bottom cover and lock it (Fig.33 and 34).
9. Reconnect the USB and power cables.

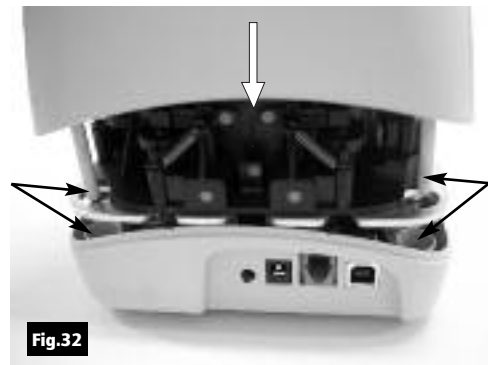

Fig.32

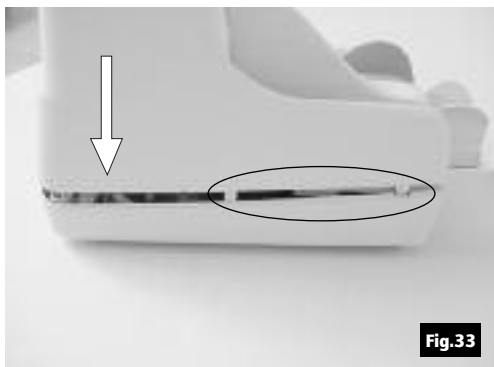

Fig.33

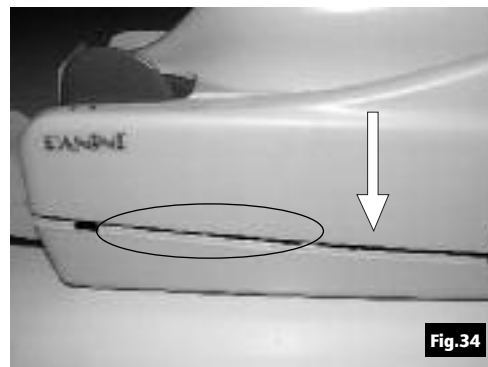

Fig.34

5. Maintenance

Warning: Before doing maintenance, remember to disconnect the USB 2 and power cables from the device.

Note: Panini recommends cleaning the Vision X weekly, or on a needed based with respect to the quantity and condition of the documents being processed.

Note: The parts accessible to the operator for cleaning or jam removal are identifiable by green stickers.

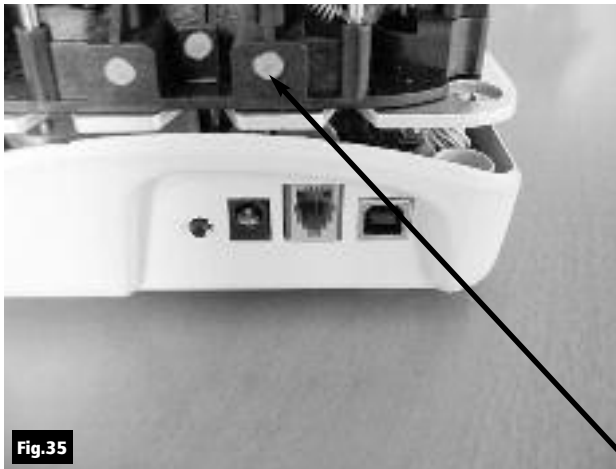

Green stickers

5.1 Cleaning the Transport

Dust, lint and small particles can get into the track area. Clean this area as follows:

1. Remove the inner and outer covers by pulling up on the covers as illustrated below.



Fig.37

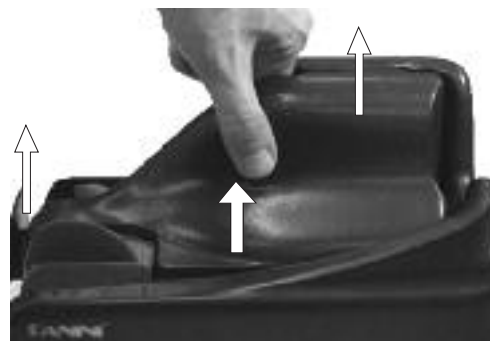
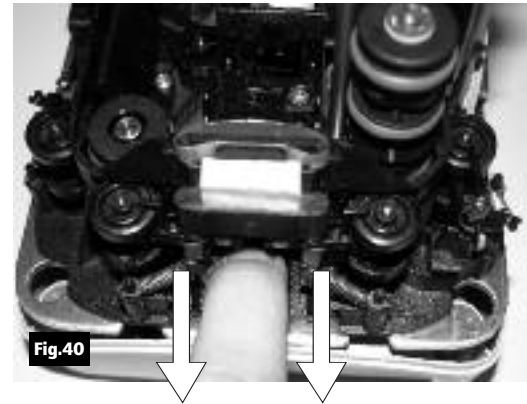
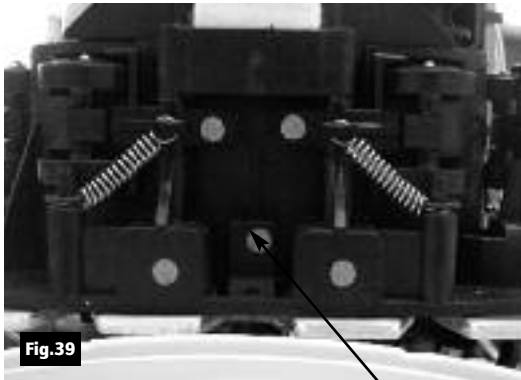

Fig.38

2. To remove the U-track, pull back on lever (A) away from unit (Fig.39).

The Fig.40 shows how to pull the lever and remove the U-track.



3. Inspect and clean the entire track area from beginning to end.
4. Remove staples, paper clips, rubber bands, and pieces of paper that may have accumulated during use.
5. Using a container of canned air and nozzle, spray the track area and check entrance.

6. To reinstall the U-track insert the two teeth "C" in the rail "D" (Fig.44), and align the U-track (Fig.41). Push back the U-track (Fig.45) until the lever "E" (Fig.41) locks the unit in place. Make sure that the pin "B" (Fig.43) is inserted in the receptacle "A" (Fig.42).

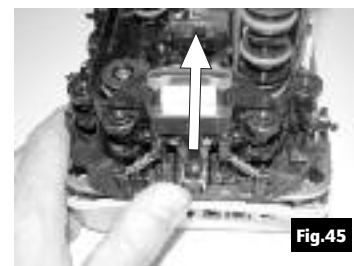
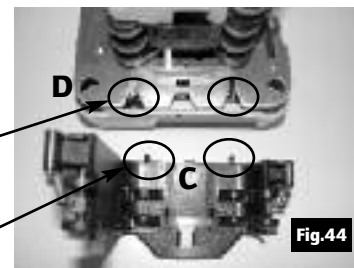
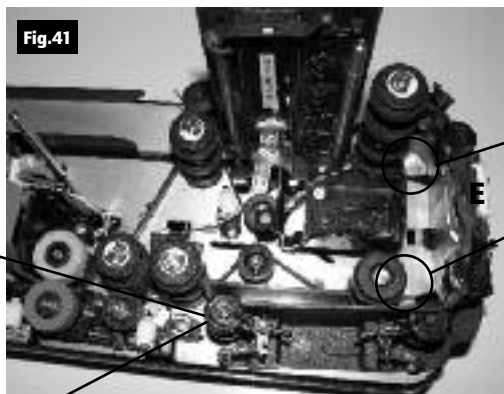
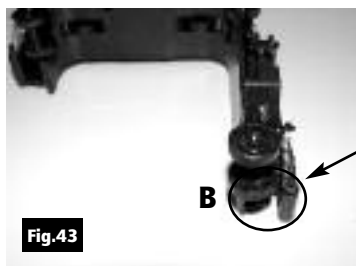
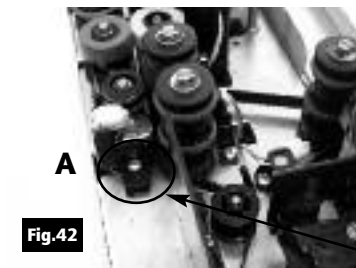

Note: If the blotting pad housing assembly. (A) comes away from the U-track, insert the low mylar spring in the lateral slots (B) and the pad housing in the reference pins (C). Gently press down until the pad housing stops on the top of the U-Track wall.

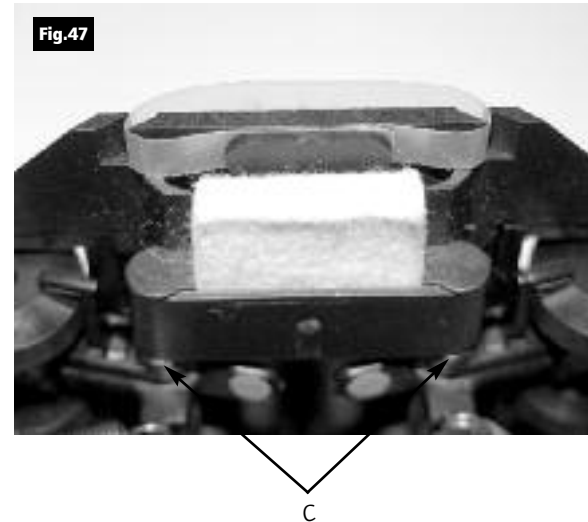
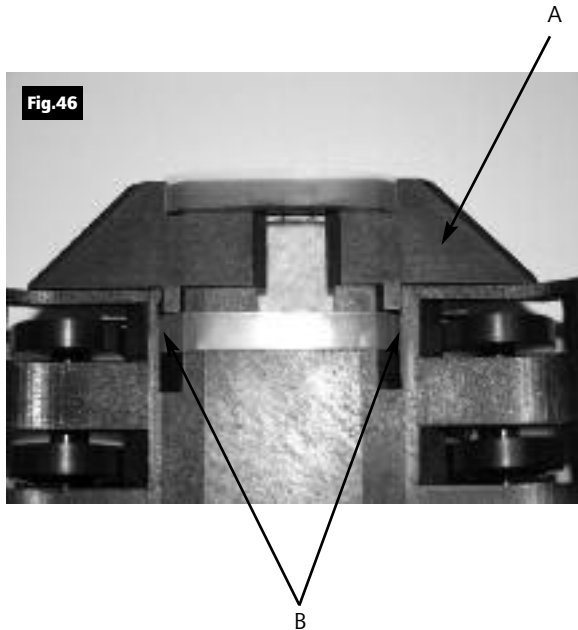

5.2 Cleaning the Contact Image Sensors

1. Gently open the front image camera (Fig.48) and remove any debris and dust.
2. Clean the Contact Image Sensors with a soft, lint-free cloth dampened with Isopropyl Alcohol or with eye glass cleaner (Fig.49).

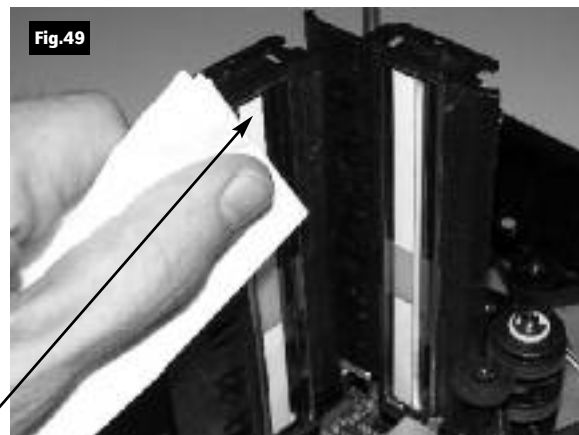
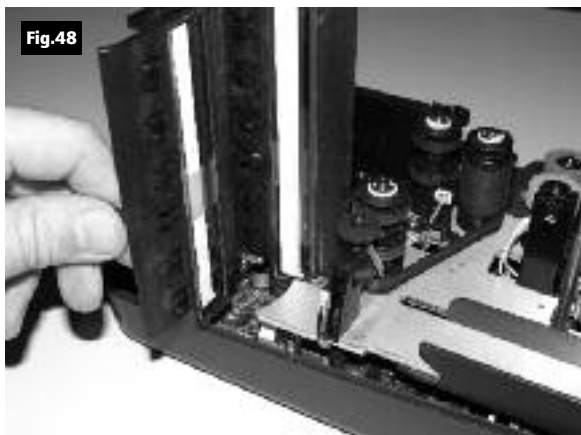

Contact Image Sensor (CIS)

5.3 Cleaning the HP C6602A Ink-Jet Cartridge (*Optional)

Fibers, such as cotton or paper, dried ink plugs or crust, or excess ink puddles on the nozzle plate can obstruct ink droplets or cause ink droplets to deflect from the desired trajectory, resulting in a degraded print quality.

When this occurs:

1. Open the inner cover.
2. Remove the print cartridge by pushing down the plastic retainer (Fig.50).
3. Dampen a clean, lint-free cloth with deionized (or distilled) water.
4. Hold the dampened cloth in contact with the nozzles for a few seconds.
5. Then gently wipe the nozzle plate in the direction of the paper movement.
Do not wipe the electrical contact area.
6. If ink remains on the nozzle plate wipe again with a clean dry lint-free cloth.
7. Reinsert the cartridge.
8. Replace the inner cover.



Remove the Ink-Jet cartridge when transporting the unit and when the unit is not used for long periods. In case the scanner is not used regularly, periodically clean the Ink-Jet nozzles with a lint-free cloth.

* If the unit was purchased without the endorser option then the unit is shipped without an ink cartridge and that one is not needed to run the device.

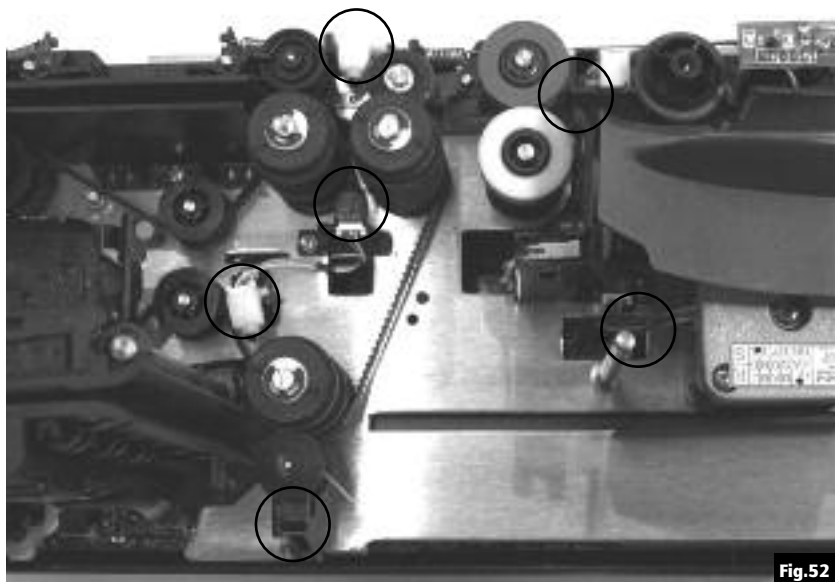

Fig.50

Plastic retainer

5.4 Cleaning the Photocell Detectors

The six photocells (emitter and receiver) are identified with black circles in Fig.52 below. Using a container of canned air and nozzle, spray the sensors to remove any dust. Also a dry soft cloth can be used.



5.5 Replacing the Feeder and Separator Rollers

After extended use it will be necessary to replace the Feeder and Separator Roller rings due to normal wear.

1. Open the inner and outer covers.
2. Carefully lift the rings off the rollers (See the arrows in Fig.53, 54 and 55).

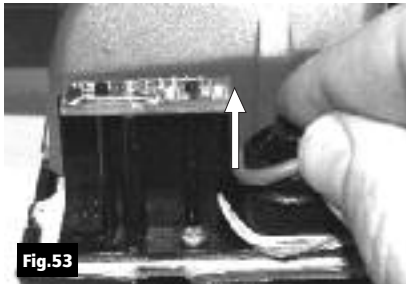

Feeder ring

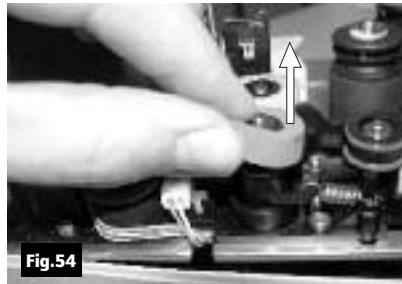

Front separator ring

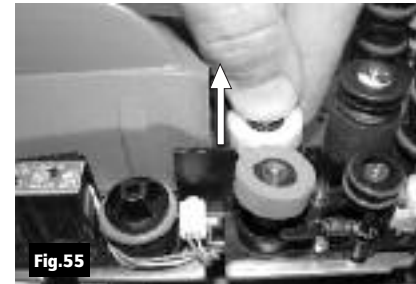

Rear separator ring

3. Install the new separator rings on the hubs by pressing down on the surface of the rings, making sure the rings are installed flat on their seats. The feeder ring must be rolled onto the black pulley.

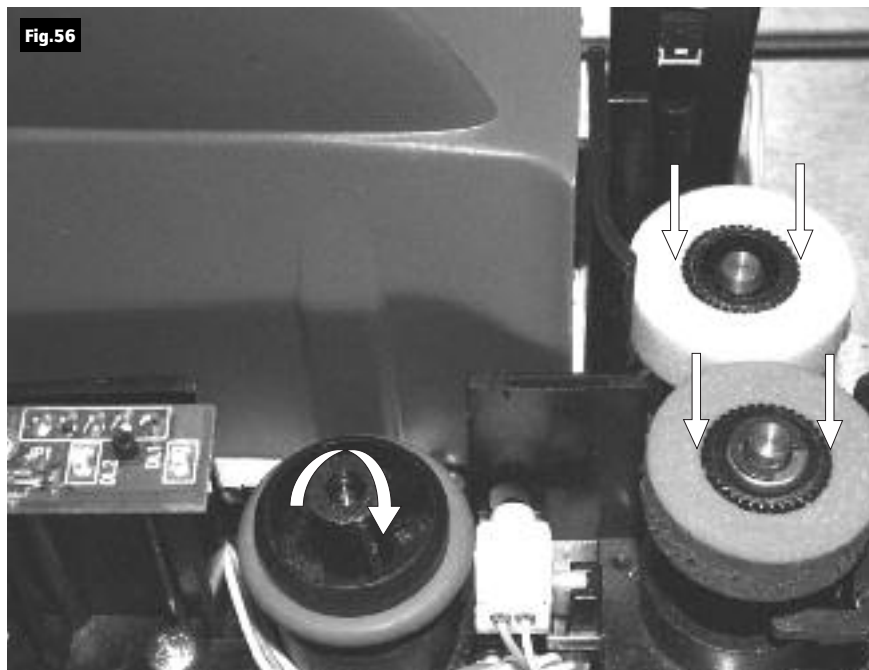

5.6 Cleaning the Reading Transport Belt

If an increase in the number of MICR (Magnetic Ink Characters Recognition) rejects is noticed, it may be necessary to clean the surface of the reading transport belt to remove extraneous magnetic ink or iron dust. Clean the external surface of the belt with a soft, lint-free cloth, dampened with Isopropyl Alcohol. Turn pulley "A" counterclockwise to move the belt in the direction of the arrow and clean the entire belt surface.

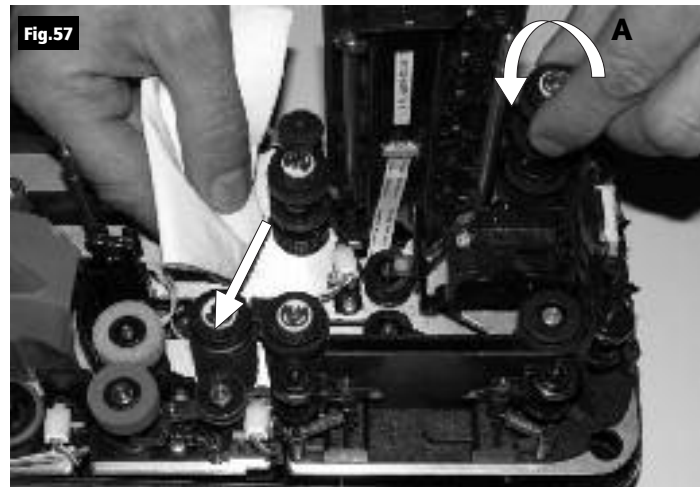

5.7 Install the External Covers

Install the inner cover following the instructions below:

1. Open the pocket extension.
2. Insert the two reference shafts in the corresponding housings found in the inner cover (Fig.58).

3. Push down on the inner cover until it stops, ensuring that the inner cover stays behind the scanner (black area) (Fig.59).

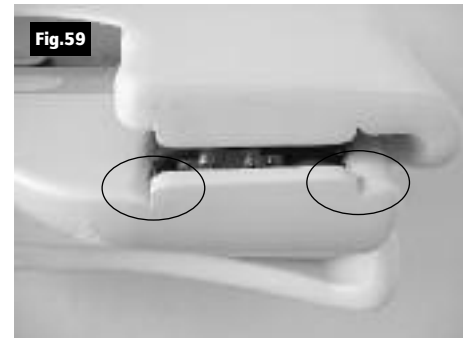
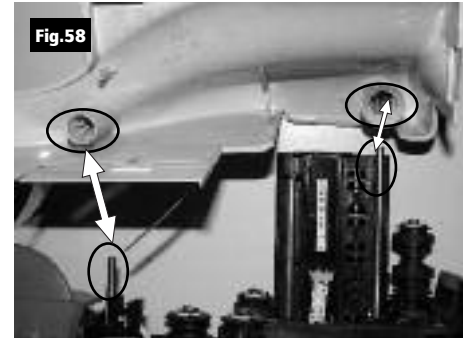

The inner cover (grid) must be inserted behind the scanner (black)

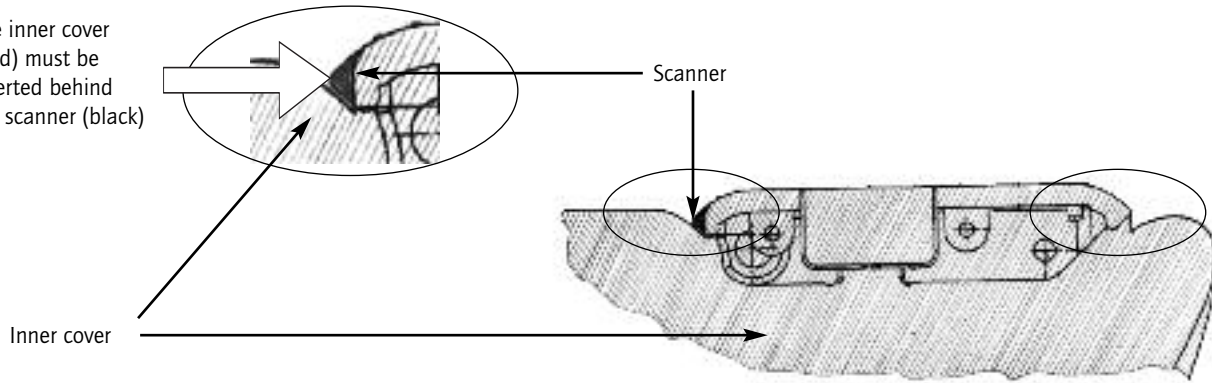

4. Check the exit pocket to ensure that the two plastic springs are properly aligned as shown in Fig.60.



5. Insert the outer cover by aligning the two shafts with the two holes in the bottom cover of the unit (Fig.61). Push the cover down.

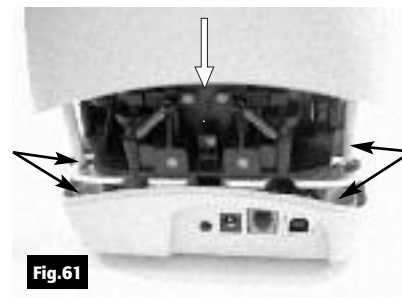

Fig.61

6. Insert the two teeth located on each side of the outer cover in the bottom cover and lock it see Fig.62 and 63.

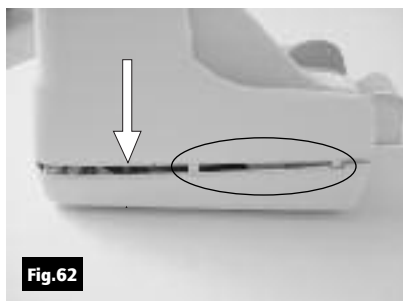

Fig.62

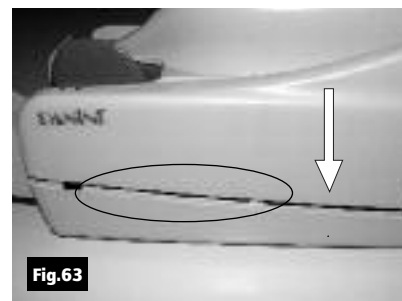

Fig.63

6. Specifications

6.1 Technical Specifications of the Panini Vision X

PERFORMANCE

3 versions (sw upgradable)
VX 50: Up to 50 DPM
VX 75: Up to 75 DPM
VX 100: Up to 100 DPM
Performance declared for 6'' checks . Final performance depends on applications and PC performance
USB2.0 interface

IMPROVED AUTOMATIC DOCUMENT FEEDER

3 versions (sw upgradable)
- single document automatic drop - 1F version
- holding up to 50 documents - SF version
- holding up to 100 documents - FF version
Double feed detection with infrared (std) and ultra sonic technologies(future HW option)
Auto-tuning separator rollers designed to process varied thickness of documents and to compensate wear

INKJET PRINTER

2 versions (sw upgradable)
Rear Ink-jet Printer (IJ version) and No ink jet (NJ version, sw upgradable)
Printing capability: Single line, Alphanumeric characters, all MS Windows fonts
Reg CC Compliant
Printed information captured by the image
Intelligent printing, image and MICR driven
Automatic cartridge presence detection and empty cartridge alert

TOTAL COMPATIBILITY AND SCALABILITY

Total backward compatibility for software API > release 2.24
Full version scalability (for sw options) throughout the range, via software upgrade

POCKETS

A single exit pocket capable of holding up to 100 documents

WORKSPACE

Extremely compact footprint - Ideal for teller, back office and corporate installations

DOCUMENTS SPECIFICATIONS

Height: Min: 54 mm (2.12'') - Max: 106 mm (4.17'')
Length: Min: 80 mm (3.14'') - Max 235 mm (9.25'')
Weight: Min: 60 gr/m2 (16#) - Max: 120 gr/m2 (32#)

INTERFACE

USB2.0 port/Backward compatible with USB 1.1
RS232 Port for external device connection. (SW/FW developments on request.)



MAGNETIC READER

E13B/CMC7/Automatic
New Panini MICR Plus® exclusive technology with OCR assist feature
Superior MICR recognition and management

IMAGE CAPTURE

Scanning: Next Generation Contact Image Sensor (CIS) technology (front and rear)
Image format: Bitmap in B/W, 256 shades of gray, Infrared, Color (Fast and True) and drop out mode. TIFF, JPEG and Group IV compression
Image Quality Assurance sw (IQA) available as sw option
Image resolution: 100, 200 or enhanced 300 dpi
Advanced Dynamic Thresholding
Superior auto calibrated image quality
Dual Image: 4 images in one document pass

SOFTWARE TOOLS

Panini Vision API control running on:
Windows 2000 S.P. 3, XP S.P. 1, Windows Vista with USB 2.0 or USB 1.1
ICR Vision function for image snippet definition and download
Easy integration of ICR/Barcode/OCR recognition technology

ADDITIONAL OPTIONS

HW : 3 Tracks Magnetic BADGE READER (future option)
HW: External dongle for temporary and device independent upgrades
SW: OCR Recognition: OCR-A, OCR-B recognition engine
SW: Barcode Recognition: Code 39, Interleaved 2/5, EAN8, EAN13, UPCA, UPCE, Code 128
SW: Bi-dimensional barcode (pdf)

**APPLICATION PC
MINIMUM REQUIREMENTS**

V X 50, V X 75: Intel Pentium IV, 1.2 GHz, 512 Megabytes Ram
V X 100: Intel Pentium IV, 2 GHz, 512 Megabytes Ram

DIAGNOSTIC FEATURES

On board Diagnostics: tests the functionality of the scanner
Power-on Self Testing: Automatic self testing and photocells calibration when powering the unit

MAINTENANCE

Maximum accessibility to every component to minimize MTTR
Total access to scanner and track area
Firmware upgradeable via PC

POWER SUPPLY INPUT VOLTAGE

Autosensing from 100 to 240 Vac, 50 to 60 Hz

DEVICE INPUT VOLTAGE

30 VDC

OPERATING CONDITIONS

Temperature: 15 ÷ 35°C
Humidity: 20 ÷ 80% R.H. Non-Condensing

DIMENSIONS and WEIGHT

Height	Width	Length	Weight
175 mm (6.88")	138 mm (5.43")	264 mm (10.39")	2.5 Kg (5.73#)

Specifications subject to change without previous notice.

6.2 Technical Specification of the PC

**Panini Vision API running on:
Windows 2000 SP3 or Windows XP SP1 or higher with USB2.0 or USB1.1 port
Windows NT 4.0 SP6 with USB1.1**

50 dpm and 75 dpm Models

Application PC minimum requirements

Intel Pentium IV, 1.2 GHz, 512 Megabytes Ram

100 dpm Models

Application PC minimum requirements

Intel Pentium IV, 2 GHz, 512 Megabytes Ram

7. Vision X SD Addendum

This addendum provides specific product details related to the Vision X SD model. This information highlights product characteristics that vary from the information in the Operator Manual.

Vision X SD Packaging List

** Replaces section 2.1

The package includes:

1. Operator Manual
2. Accessories box (*)
3. Vision X scanner unit
4. Power Cable

(*) The accessories box contains:

- Feeder Extension
- Extension plate
- Ink-Jet Cartridge HP C6602A
- USB 2 Cable
- Power Supply
- Ink-Jet Plastic Lever (adapter for HP 51604 cartridge)
Cartridge not included with No Ink Jet (NJ) versions

Document Support Installation

** Replaces section 3.1

The installation procedure for inserting the document feeder extension on a SD machine varies slightly as the Document Pressure Plate has a fixed position and can not be pushed backwards. The Feeder Extension is simply inserted into the available slot. Installation is correct if the Feeder Extension is at the same level of the entrance of the scanner platform.

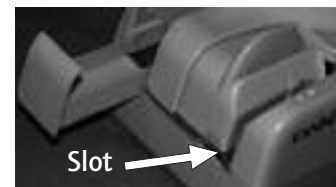



How to Prepare and Load Checks

** Adjustment to section 4.2

The SD scanner unit is designed for single document processing exclusively. All references to preparing and processing batches of multiple items in this section is not relevant to the SD version of the Vision X. Inserting multiple items into the feeder of a SD scanner will cause multiple documents to be fed or document jams to occur.

Replacing the Feeder and Separator Rollers

** Adjustment to section 5.5

Please note that the Vision X SD machine is not furnished with front and rear separator rollers. The addition of which is not needed when processing one item at a time. As such, the instructions for replacing these rings are irrelevant with reference to the SD scanner unit.

8. Vision X AGP Addendum

This addendum provides specific product details related to the Vision X AGP model. This information highlights product characteristics that vary from the information in the Operator Manual.

AGP Packaging List

** Replaces section 2.1

The Panini Vision X AGP package includes:

1. Operator Manual
2. Accessories box (*)
3. Panini Vision X AGP scanner unit
4. Power Cable
5. Ink-Jet Cartridge

(*) The accessories box contains:

- Feeder Extension & Extension plate
 - USB 2 Cable
 - Power Supply
 - Panini cleaning cloth (Panini P/N: GS-00020-00)
- Cartridge not included with No Ink Jet (NJ) versions

AGP Ink-Jet Cartridge Use

Use only one of the following Panini recommended cartridges.

Cartridge	Panini Part Number	Usage
HP Q2344A (Black 1918 Dye) *	CA-00140-00	Best for high usage
Universal Black 7482	CA-00165-00	Best for high and low usage

* Note: Frequent cleaning of the nozzle head may be required on HP Q2344A cartridges when processing with long intervals between batches of endorsed documents.

Ink-Jet Cartridge Installation

** Replaces section 3.5 and 3.6

The following steps indicate how to install the Vision X AGP ink-jet cartridge.

- Remove the new print cartridge from its package, and gently remove the transparent tape covering the ink nozzles, being careful not to touch the ink nozzles and electrical contacts.
- Remove Vision X inner cover (see section 4.3)
- Push the new cartridge down firmly into its cradle slot, and close the rear cradle lever.
- Insert the inner cover



Cleaning the Contact Image Sensors

** Addition to section 5.2

In addition to following the basic cleaning instructions provided in section 5.2 of the Operator Manual, Panini recommends that you occasionally inspect the images for the presence of any streaking due to residual ink on the Contact Image Sensors (CIS) glass. If so, use the Panini cleaning cloth (Panini P/N: GS-00020-00) to clean the CIS surface.

Cleaning the Ink-Jet Cartridge

** Replaces section 5.3

Fibers, such as cotton or paper, dried ink plugs or crust, or excess ink puddles on the nozzle plate can obstruct ink droplets or cause ink droplets to deflect from the desired trajectory, resulting in a degraded print quality.

- Open the inner cover
- Open the rear cradle lever and remove the print cartridge
- Using a slightly dampened (de-ionized water is best) lint free cloth gently wipe the nozzle head in an upward vertical direction. Do not apply excessive force, as this could scratch the nozzle surface
- Reinsert the print cartridge and inner cover

Note: If the print cartridge sits inactive for a period of time, ink may dry clogging the nozzles. As a result white streaks will be visible in the printed text or graphic on the document. Printing alone may not remove ink clogs. Follow the steps above to properly clean the nozzle. If print quality does not improve, gently shake the cartridge with the nozzle head towards the cleaning cloth, causing a slight expulsion of ink on the cloth. Gently wipe the nozzle head in an upward vertical direction. The Ink being pulled from the cartridge will flush the nozzles out, then print a few lines of text or graphics.



9. Vision X P Addendum

This addendum provides specific product details related to the Vision X P model. This information highlights product characteristics that vary from the information in the Operator Manual.

External Parts Description

** Replaces section 2.2

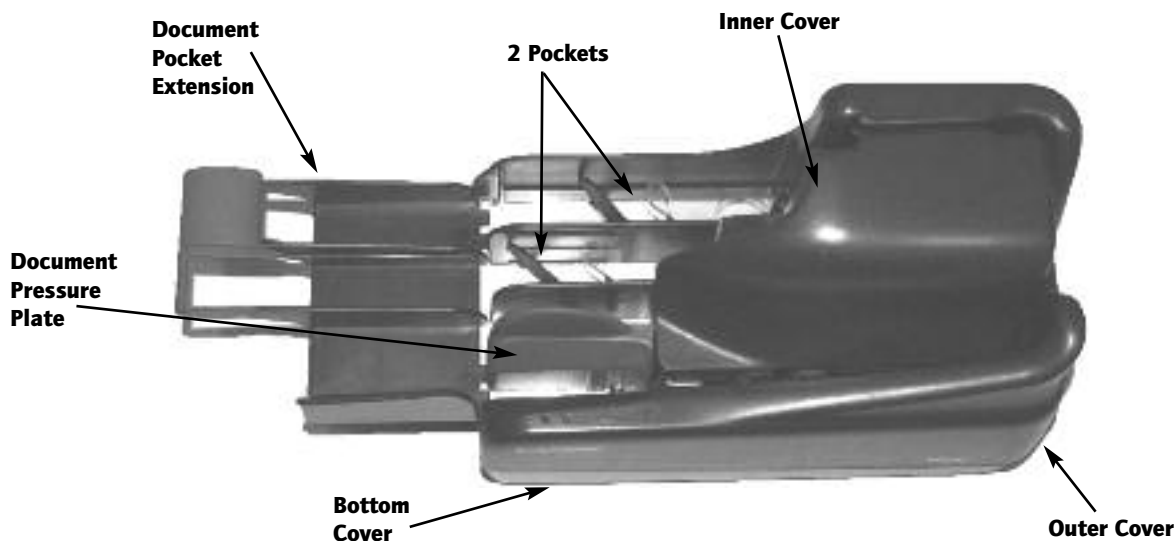

Internal Parts Description

** Replaces section 2.3

1. Document Pressure Plate
2. LED board
3. Feeder Roller
4. Feeder Sensor
5. Separator Roller
6. Rear Separator Roller
7. Pre-magnetization Head
8. Synchronization Sensor
9. MICR Reading Head
10. "U" Track Wall
11. Transport Rollers
12. Ink-Jet Cartridge Cradle
13. Front Image Camera
14. Rear Image Camera
15. Pocket sensor
16. Transport Belt
17. Interlock Board
18. Feeder Motor
19. Document Alignment Mylar
20. Full Pocket Sensor

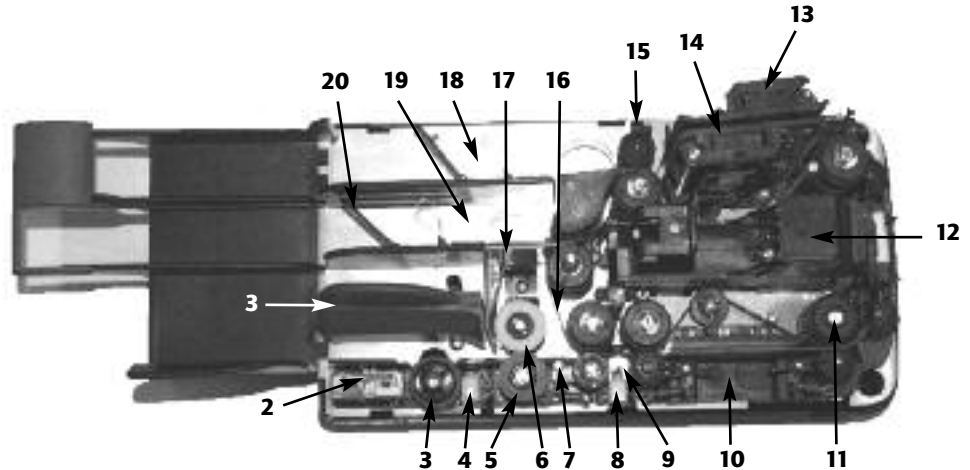

Document Support Installation / Pocket Length Adjustment

** Replaces section 3.1

Insert the Document Pocket Extension in the slot uncovered by pushing back the Document Pressure Plate and the corresponding slots in the first document pocket. Installation is correct if the Document Pocket Extension is at the same level of the scanner base plate.

Adjust the pocket length by inserting the longest document that will be processed in the pocket. Move the pocket extension plate left or right until a space of 5 mm (1/4") is available between the leading edge of the document and the end of the pocket extension. The pocket extension plate will provide support for both machines pockets.

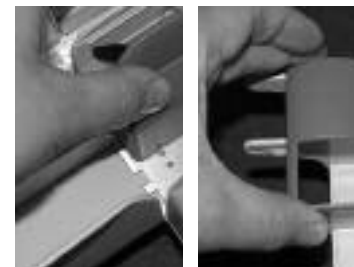

Cleaning the Contact Image Sensors

** Addition to section 5.2

In addition to following the basic cleaning instructions provided in section 5.2 of the Operator Manual, Panini recommends that you occasionally inspect the images for the presence of any streaking due to residual ink on the Contact Image Sensors (CIS) glass. If so, use the Panini cleaning cloth (Panini P/N: GS-00020-00) to clean the CIS surface.



Technical Specifications of the Panini Vision X P

Vision X P Technical Specifications	
<p>PERFORMANCE</p> <p>3 versions (sw upgradable) VX P 50: Up to 50 DPM VX P 75: Up to 75 DPM VX P 100: Up to 100 DPM Performance declared for 6" checks. Final performance depends on applications and PC performance USB2.0 interface</p>	<p>ADDITIONAL OPTIONS</p> <p>HW: 3 Tracks Magnetic BADGE READER (future option) HW: External dongle for temporary and device independent upgrades SW: OCR Recognition: OCR-A, OCR-B SW: Barcode Recognition: Code 39, Interleaved 2/5, EAN8, EAN13, UPCA, UPCE, Code 128 SW: Bi-dimensional barcode (pdf)</p>
<p>IMPROVED AUTOMATIC DOCUMENT FEEDER</p> <p>2 versions (sw upgradable):</p> <ul style="list-style-type: none"> • Holding up to 50 documents – SF version • Holding up to 120 documents – FF version <p>Double feed detection with infrared (std) and ultrasonic technologies (future HW option). Auto-tuning separator rollers designed to process varied thickness of documents and to compensate wear</p>	<p>POCKETS</p> <p>2 versions (based on the same hardware platform) :</p> <ul style="list-style-type: none"> • 1P: one exit pocket capable of holding 100 documents • 2P: two exit pockets capable of holding 100 documents each. <p>Flexible Sorting Options, based on MICR and/or image Full pocket sensor for both versions</p>
<p>MAINTENANCE</p> <p>Maximum accessibility to every component to minimize MTTR Total access to scanner and track area Firmware upgradeable via PC</p>	<p>MAGNETIC READER</p> <p>E13B/CMC7/Automatic New Panini MICR Plus® exclusive technology with OCR assist feature Superior MICR recognition and management MICR based sorting</p>
<p>DOCUMENTS SPECIFICATIONS</p> <p>Height: Min: 54 mm (2.12") – Max: 106 mm (4.17") Length: Min: 80 mm (3.14") – Max 235 mm (9.25") Weight: Min: 60 gr/m² (16#) – Max: 120 gr/m² (32#)</p>	<p>SOFTWARE TOOLS</p> <p>Panini Vision API control running on: Windows 2000 S.P. 3, XP, Windows Vista with USB 2.0 or USB 1.1 ICR Vision function for image snippet definition and download Easy integration of ICR/Barcode/OCR recognition technology</p>



<p>INKJET PRINTER</p> <p>Rear Ink-jet AGP (advanced Graphic Printer) Printing capability, two versions:</p> <ul style="list-style-type: none"> • AGP 1: one line text/graph in any vertical position • AGP 2: two lines text/graph in any vertical position • AGP 4: four lines text/graph for full 1/2" height <p>Alphanumeric characters: all MS Windows fonts Reg CC Compliant Printed information captured by image Intelligent printing based on MICR or image on a defined printing area Automatic cartridge presence detection and empty cartridge alert</p>	<p>IMAGE CAPTURE</p> <p>Scanning: Contact Image Sensor (CIS) technology (front and rear) Image format: Bitmap in B/W, 256 shades of gray, Infrared, Color (Fast and True) and drop out mode. TIFF, JPEG and Group IV compression Image Quality Assurance sw (IQA) available as sw option Image resolution: 100, 200 or enhanced 300 dpi Advanced dynamic thresholding Superior auto calibrated image quality Dual Image: 4 images in one document pass Front/rear image based sorting</p>
<p>INTERFACE</p> <p>USB2.0 port/Backward compatible with USB 1.1 RS232 Port for external device connection.</p>	<p>TOTAL COMPATIBILITY AND SCALABILITY</p> <p>Total backward compatibility for software API > release 2.24 Full version scalability (for sw options) throughout the range, via software upgrade</p>
<p>APPLICATION PC MINIMUM REQUIREMENTS</p> <p>V X P 50, V X P 75: Intel Pentium IV, 1.2 GHz, 512 Megabytes Ram V X P 100: Intel Pentium IV, 2 GHz, 512 Megabytes Ram</p>	<p>WORKSPAC</p> <p>Extremely compact footprint – Ideal for teller, back office and corporate installations</p>
<p>DIAGNOSTIC FEATURES</p> <p>On board Diagnostics: tests the functionality of the scanner Power-on Self Testing: Automatic self testing and photocells calibration when powering the unit</p>	<p>DIMENSIONS AND WEIGHT</p> <p>Height: 175 mm (6.88") Width: 138 mm (5.43") Length: 264 mm (10.39") Weight: 2.6 Kg (5.73#)</p>
<p>OPERATING CONDITIONS</p> <p>Temperature: 15 ÷ 35°C Humidity: 20 ÷ 80% R.H. Non-Condensing</p>	<p>POWER SUPPLY INPUT VOLTAGE</p> <p>Autosensing from 100 to 240 Vac, 50 to 60 Hz</p>
<p>DEVICE INPUT VOLTAGE</p> <p>30 VDC</p>	

10. Vorschriftmäßige Entsorgung von Elektro- und Elektronikaltgeräten (WEEE)

FÜR LÄNDER DER EUROPÄISCHEN UNION (EU)

Die EU-Kommission hat bestimmt, dass elektrische und elektronische Geräte, die heute auf dem Markt angeboten werden, Bauteile und Komponenten enthalten, die wiederverwertet werden und somit dazu beitragen können, die in Müllgruben und Deponien entsorgten Materialmenge zu reduzieren. In Übereinstimmung mit dieser Bestimmung dürfen elektrische und elektronische Geräte (WEEE) nicht mit dem unsortierten Müll von Privathaushalten oder Büros entsorgt werden. Sie müssen vielmehr einer gesonderten Abfallentsorgung zugeführt werden. Die Entsorgung dieser Geräte an Stellen, die dafür weder ausgerüstet noch zugelassen sind, hat verheerende Folgen auf Umwelt und Gesundheit. Zuwiderhandlungen werden mit den gesetzlichen Strafen und Bußgeldern belegt.

Die Panini-Produkte sind daher in Entsprechung der europäischen WEEE-Richtlinie über Elektro- und Elektronikaltgeräte (WEEE) mit dem Symbol einer durchgestrichenen Mülltonne gekennzeichnet, das darauf hinweist, dass alle nach dem 13. August 2005 auf dem Markt eingeführten Produkte dieser Art gemäß WEEE-Richtlinie 2002/96/EC (und folgender Zusätze) nicht mit dem normalen Hausmüll entsorgt werden dürfen.



So entsorgen Sie die Altgeräte umweltgerecht:

- Wenden Sie sich an die lokalen Behörden oder an Ihren Fachhändler, die Ihnen die notwendigen Informationen zur korrekten Entsorgung liefern werden, wie zum Beispiel: Ort und Öffnungszeiten der Abfallsammelstellen usw.
- Wenn Sie ein neues Gerät von uns kaufen, können Sie ein ähnliches Altgerät unserem Fachhändler zur Entsorgung übergeben.

FÜR ANDERE (NICHT DER EU ANGEHÖRIGE) LÄNDER

Die Behandlung, Sammlung, Wiederverwertung und Entsorgung von Elektro- und Elektronikaltgeräten erfolgt in Entsprechung der in dem betreffenden Land gültigen Bestimmungen.

10.1 Audience

Das vorliegende Handbuch ist vornehmlich für das Personal bestimmt, das Schecks und andere Dokumente bearbeitet.

10.2 Sicherheitsmaßnahmen

Vergewissern Sie sich, bevor Sie mit dem Gerät Vision X arbeiten oder das Gerät warten, dass Sie die Sicherheitsanweisungen gelesen und verstanden haben.

- Tragen Sie sichere Kleidung. Vermeiden Sie das Tragen lockerer Kleider, langer Haare und von Schmuck, die sich in den sich bewegenden Teilen verfangen können.
- Achten Sie darauf, dass niemand auf dem Stromkabel steht. Stellen Sie Vision X nicht in Bereichen auf, in denen Leute auf das Kabel treten können.
- Ziehen Sie vor dem Reinigen des Gerätes Vision X immer den Netzstecker.
- Versuchen Sie nicht, Vision X selbst zu warten oder zu reparieren, soweit dies im Handbuch nicht ausdrücklich erwähnt wird.
- Der Versuch, den externen Netzanschluss selbst zu warten oder zu reparieren, setzt Sie gefährlichen Spannungen oder anderen Gefahren aus.
- Wenden Sie sich immer an erfahrene Wartungsfachkräfte.

Hinweis:

- Vision X entspricht den Normen IEC/EN 60950-1 und UL 60950-1 nur, wenn es mit dem Netzteil DSA-0421S-28 1 42 verwendet wird, das mit der Maschine geliefert wird.
- Die Wandsteckdose muss in der Nähe des Gerätes installiert werden und immer leicht zugänglich sein.
- BETRIEBSBEDINGUNGEN: Temperatur: 15 ÷ 35°C. Relative Luftfeuchtigkeit: 20 ÷ 80% ohne Kondensation.

10.3 Bei Maschinenstörungen

Ziehen Sie den Netzstecker des Gerätes Vision X und rufen Sie eine Fachkraft, wenn sich folgende Bedingungen einstellen:

- Wenn das Netzkabel beschädigt oder abgenutzt ist.
- Wenn Flüssigkeit in das Produkt eingedrungen ist.
- Wenn das Gerät Regen oder Wasser ausgesetzt worden ist.
- Wenn das Gerät bei Befolgung der Bedienungsanweisungen nicht korrekt funktioniert.
- Wenn das Gerät beschädigt oder hingefallen ist.
- Wenn die Geräteleistungen deutlich nachlassen und damit anzeigen, dass das Gerät gewartet werden muss.

Nehmen Sie nur solche Einstellungen vor und ersetzen Sie nur Bauteile, die in diesem Handbuch erwähnt werden.

Wenn Sie versuchen, Einstellungen vorzunehmen, die nicht in dem Handbuch erwähnt werden, laufen Sie Gefahr, das Gerät zu beschädigen; außerdem verfällt die Garantie.

Ungenehmigte Einstellungen oder Reparaturen können später außergewöhnliche Arbeiten durch eine Fachkraft erfordern, um das Gerät wieder in die normalen Betriebsbedingungen zu versetzen.

10. Mise au rebut des équipements électriques et électroniques (WEEE)

POUR LES PAYS DE L'UNION EUROPÉENNE (UE)

L'Union européenne a établi que les équipements électriques et électroniques actuellement sur le marché contiennent des composants et des matériaux pouvant être réutilisés ou recyclés afin de réduire la masse de déchets jetés dans des centres d'enfouissement et autres décharges. Dans cette optique, l'UE appelle à ne pas collecter ou jeter les déchets d'équipements électriques et électroniques (WEEE) avec des déchets tout venant issus des ménages ou des entreprises. Ils doivent faire l'objet d'une collecte sélective. La mise au rebut de (WEEE) dans des décharges non équipées et non homologuées peut avoir des conséquences nocives pour la santé et l'environnement. Les contrevenants s'exposent aux sanctions et autres mesures établies par la loi.

Dans cette optique, les produits Panini portent le pictogramme de la « poubelle barrée » prévu par la Directive (WEEE) de l'Union européenne. Ce pictogramme indique l'obligation de procéder à la collecte sélective des équipements électriques et électroniques mis sur le marché après le 13 août 2005, conformément à la directive européenne (WEEE) 2002/96/CE (et à ses amendements suivants), ainsi qu'aux lois en vigueur dans chaque pays.



Pour la mise au rebut de vos (WEEE):

- demandez aux autorités locales compétentes ou à un distributeur local de vous donner les informations pratiques et les indications dont vous avez besoin pour une gestion appropriée de vos déchets comme, par exemple, l'adresse et les horaires des centres de collecte des déchets, etc.
- quand vous achetez un nouvel appareil électrique ou électronique, remettez votre ancien appareil au revendeur pour qu'il se charge de son élimination.

POUR LES AUTRES PAYS (HORS UE)

Le traitement, la collecte, le recyclage et l'élimination des équipements électriques et électroniques doivent être effectués conformément à la législation en vigueur dans le pays concerné.

10.1 Destinataires

Ce manuel s'adresse principalement au personnel chargé du traitement de chèques ou d'autres documents.

10.2 Consignes de sécurité

Avant l'utilisation ou la maintenance de votre Vision X conformément aux indications de ce manuel, il est important d'avoir entièrement lu et bien compris ces consignes de sécurité.

- Portez des vêtements appropriés. Ne portez pas de vêtements amples ou de bijoux et attachez les cheveux longs pour éviter qu'ils ne soient happés par les pièces en mouvement.
- Ne posez aucun objet sur le cordon d'alimentation. Installez le Vision X en veillant à ce que personne ne risque de marcher sur le cordon d'alimentation.
- Débranchez toujours le Vision X avant de le nettoyer.
- Ne tentez pas d'intervenir sur le Vision X pour sa maintenance ou sa réparation, sauf pour les interventions explicitement décrites dans ce manuel.
- Toute tentative d'intervenir sur l'alimentation externe du Vision X expose l'opérateur à des hautes tensions ou d'autres dangers.
- Pour toutes les opérations d'entretien et les réparations, faites appel à du personnel de maintenance qualifié.

Remarque:

- Le Vision X n'est conforme aux normes CEI/EN 60950-1 et UL 60950-1 qu'en cas d'utilisation de l'alimentation modèle DSA-0421S-28 1 42 fournie avec la machine.
- La prise de courant doit être installée près de l'équipement et doit être facilement accessible.
- CONDITIONS DE FONCTIONNEMENT: Température: 15 ÷ 35°C. Humidité: 20 ÷ 80 % H.R. sans condensation.

10.3 Si l'appareil est endommagé

Débranchez le Vision X de la prise murale et faites appel à du personnel qualifié :

- si le cordon d'alimentation est endommagé ou fissuré ;
- si du liquide a pénétré dans l'appareil ;
- si l'appareil a été exposé à la pluie ou à de l'eau ;
- si l'appareil ne fonctionne pas normalement bien que les instructions d'utilisation aient été respectées ;
- si l'appareil est tombé ou a subi des dommages ;
- si l'appareil a besoin d'une vérification suite à une altération quelconque de son fonctionnement.

Procédez uniquement aux réglages et aux remplacements décrits dans ce manuel.

Si vous tentez d'effectuer un réglage non indiqué dans ce manuel, vous risquez de causer des dommages à l'appareil. Ces dommages ne sont pas couverts par la garantie.

Les réglages ou réparations effectués sans autorisation peuvent exiger l'intervention d'un technicien qualifié pour rétablir les conditions de fonctionnement de l'appareil.

10. Smaltimento corretto delle apparecchiature elettriche ed elettroniche (WEEE)

PER I PAESI MEMBRI DELL'UNIONE EUROPEA (EU)

La Commissione dell'Unione Europea ha stabilito che le apparecchiature elettriche ed elettroniche attualmente presenti sul mercato contengono parti e componenti che possono essere adeguatamente riutilizzati o riciclati per ridurre le quantità di materiali destinati in ultimo alle discariche e ad altri siti di smaltimento. Per rispettare questa decisione, le apparecchiature elettriche ed elettroniche (WEEE) non devono essere raccolte o smaltite nei normali cassonetti di raccolta sia dai privati cittadini che dalle aziende. Devono invece essere oggetto di raccolta differenziata. La discarica di questi dispositivi presso luoghi non adeguatamente attrezzati e non autorizzati può avere effetti nocivi sulla salute e sull'ambiente. I trasgressori saranno passibili delle sanzioni e dei provvedimenti previsti dalla legge.

A tal fine, i prodotti Panini sono debitamente contrassegnati dal marchio stabilito dalla direttiva WEEE dell'Unione Europea, costituito dal simbolo da un bidone della spazzatura barrato da una croce per indicare che le apparecchiature elettriche ed elettroniche immesse sul mercato dopo il 13 agosto 2005 devono essere smaltite in modo differenziato, ai sensi della Direttiva WEEE 2002/96/CE (e successivi emendamenti) e della legislazione nazionale.



Per smaltire i nostri dispositivi correttamente:

- Contattare le autorità o il distributore locali, che forniranno le informazioni pratiche e le istruzioni necessarie per smaltire correttamente il prodotto, per esempio: luogo e orari dei centri di raccolta rifiuti, ecc.
- Al momento dell'acquisto di un nostro nuovo dispositivo, è possibile consegnare un dispositivo simile a quello acquistato al nostro distributore, che si occuperà dello smaltimento.

PER ALTRI PAESI (EXTRA UE)

Il trattamento, la raccolta, il riciclaggio e lo smaltimento delle apparecchiature elettriche ed elettroniche dovrà avvenire in conformità alle leggi in vigore nel paese di residenza.

10.1 A chi è rivolto il presente manuale

Il presente manuale è rivolto principalmente al personale che elabora gli assegni o altri documenti.

10.2 Precauzioni di sicurezza

Prima di mettere in funzione o effettuare interventi di manutenzione su Vision X nel rispetto delle istruzioni del presente manuale, assicurarsi di aver letto e compreso le presenti importanti istruzioni di sicurezza.

- Indossare indumenti sicuri. Non indossare indumenti larghi, non portare capelli sciolti o gioielli che potrebbero rimanere impigliati nelle parti in movimento dell'apparecchio.
- Non appoggiare oggetti sul cavo di alimentazione. Non posizionare Vision X in punti in cui sia possibile calpestare il cavo di alimentazione.
- Staccare sempre Vision X dalla presa di alimentazione prima di pulirlo.
- Non tentare di effettuare interventi di manutenzione o riparazione su Vision X, eccetto secondo le istruzioni impartite in altri punti del presente manuale.
- Eventuali tentativi di manutenzione o riparazione dell'alimentatore esterno di Vision X possono esporre a pericolosi picchi di tensione o ad altri rischi.
- Per tutti gli aspetti della manutenzione, fare riferimento a personale qualificato.

Nota:

- Vision X sarà conforme alle norme CEI/EN 60950-1 e UL 60950-1 solo utilizzando l'alimentatore modello DSA-0421S-28 1 42 fornito in dotazione con l'apparecchio.
- La presa deve essere installata nelle vicinanze dell'apparecchio e in una posizione facilmente accessibile.
- CONDIZIONI DI ESERCIZIO: Temperatura: 15 ÷ 35°C. Umidità: 20 ÷ 80% Umidità relativa non condensante.

10.3 Se l'apparecchio è danneggiato

Scollare la spina di Vision X dalla presa a muro e, nei seguenti casi, rivolgersi a personale qualificato per un intervento di manutenzione:

- Se il cavo di alimentazione è danneggiato o usurato.
- Se è penetrato del liquido nell'apparecchio.
- Se l'apparecchio è stato esposto a pioggia o acqua.
- Se l'apparecchio non funziona normalmente pur rispettando le istruzioni di sicurezza.
- Se l'apparecchio è caduto o ha subito danni.
- Se l'apparecchio mostra chiari segni di calo di prestazioni, indicando così la necessità di un intervento di manutenzione.

Regolare unicamente i comandi e sostituire solo le parti coperte da istruzioni nel presente manuale.

Tentando di effettuare regolazioni non coperte dal presente manuale, l'apparecchio si potrebbe danneggiare, invalidando pertanto la garanzia.

Regolazioni o riparazioni non autorizzate possono determinare la necessità di un lungo intervento da parte di un tecnico qualificato per riportare l'apparecchio alle corrette condizioni di funzionamento.

10. Cómo deshacerse correctamente de los equipos eléctricos y electrónicos (WEEE)

PARA LOS PAÍSES DE LA UNIÓN EUROPEA (UE)

La Comisión Europea ha determinado que los equipos eléctricos y electrónicos comercializados actualmente contienen piezas y componentes que se pueden volver a utilizar o reciclar para reducir las cantidades de materiales que invaden los vertederos y otras zonas destinadas a los desechos. Con el fin de respetar esta decisión, los residuos de aparatos eléctricos y electrónicos (WEEE) no deberían ser recogidos ni eliminados junto con los residuos sin clasificar de los hogares o empresas. Se deben recoger por separado. Arrojar estos dispositivos en lugares no-equipados o no-autorizados puede tener consecuencias peligrosas para la salud y el medioambiente. Los infractores sufrirán las penas y las medidas establecidas por ley.

Por todo ello, los productos Panini están debidamente marcados con el símbolo de la papelera tachada, según obliga la normativa (WEEE) de la Unión Europa, para indicar que es necesario realizar una recogida selectiva de los aparatos eléctricos y electrónicos comercializados después del 13 de agosto de 2005, con arreglo a la normativa (WEEE) 2002/96/EC (y sus posteriores enmiendas) y según las leyes nacionales de cada país miembro.



Para deshacerse de los aparatos correctamente:

- Póngase en contacto con las Autoridades Locales o con su distribuidor local, quien le proporcionará la información práctica que necesite y las instrucciones para desechar correctamente el aparato, por ejemplo: Ubicación y horarios de los centros de recogida, etc.
- Cuando compre un aparato nuevo de Panini, entregue a nuestro distribuidor un aparato similar usado para que lo deseché.

PARA OTROS PAÍSES (FUERA DE LA UE)

El tratamiento, la recogida, el reciclaje y la eliminación de aparatos eléctricos y electrónicos se realizarán con arreglo a las leyes en vigor en el país en cuestión.

10.1 Público objetivo

Este manual ha sido redactado principalmente para el personal que realiza las comprobaciones o procesa otros documentos.

10.2 Instrucciones de Seguridad

Antes de empezar a utilizar el Vision X tal y como se indica en este manual, asegúrese de leer y comprender estas importantes instrucciones de seguridad.

- Debe vestirse con prendas seguras. No lleve ropa floja, pelo largo o joyas que puedan engancharse en las piezas en movimiento.
- No permita que nada repose sobre el cable eléctrico. No coloque el Vision X donde alguien pueda pisar el cable.
- Desconecte siempre el Vision X antes de limpiarlo.
- No intente realizar el mantenimiento o las reparaciones del Vision X, de otra forma que no se la indicada en este manual.
- Si intenta realizar el mantenimiento o las reparaciones del suministro de potencia externo del Vision X puede exponerse a picos de tensión peligrosos u otros riesgos.
- Encargue siempre el mantenimiento al personal de servicio cualificado.

Nota:

- Vision X respetará las normas IEC/EN 60950-1 y UL 60950-1 utilizando sólo el modelo de Suministro de Energía DSA-0421S-28 1 42 suministrado con el aparato.
- La salida del enchufe deberá estar instalada cerca del equipo y deberá ser fácil acceder a ella.
- **CONDICIONES DE FUNCIONAMIENTO:** Temperatura: 15 ÷ 35°C. Humedad: 20 ÷ 80% H.R. Sin condensación.

10.3 Si el Aparato Está Estropeado

Desenchufe el Vision X de la toma de corriente de la pared y encargue el mantenimiento al personal cualificado si se dan las siguientes condiciones:

- Si el cable eléctrico está dañado o desgastado.
- Si se ha derramado líquido en el producto.
- Si el aparato ha quedado expuesto a la lluvia o el agua.
- Si el aparato no funciona con normalidad cuando se siguen las instrucciones de funcionamiento.
- Si el aparato ha quedado expuesto a la lluvia o el agua.
- Si el aparato muestra un claro cambio en el funcionamiento que indique que hay que repararlo.

Ajuste sólo los controles y repare sólo los elementos cubiertos por las instrucciones de este manual.

Si intenta realizar ajustes que no estén cubiertos en este manual, puede dañar el aparato e invalidar la garantía.

Los ajustes o reparaciones no-autorizados pueden requerir posteriormente un trabajo más importante a cargo de un técnico cualificado, con vistas a restituir al aparato sus condiciones de funcionamiento adecuadas.

10. Eliminação adequada de equipamento eléctrico e electrónico (WEEE)

PARA PAÍSES PERTENCENTES À UNIÃO EUROPEIA (UE)

A Comissão Europeia da União Europeia determinou que o equipamento eléctrico e electrónico no mercado actual contém partes e componentes que podem ser devidamente recuperados e reciclados para reduzir as quantidades de materiais eliminados em lixeiras e aterros. Para cumprir esta determinação, os resíduos de equipamento eléctrico e electrónico (WEEE) não devem ser recolhidos ou eliminados juntamente com lixo indiferenciado proveniente de casas particulares ou empresas. Em vez disso, devem ser recolhidos separadamente. A descarga destes dispositivos em locais não equipados e não autorizados pode ter efeitos prejudiciais para a saúde e o meio ambiente. Os transgressores serão sujeitos a multas e medidas estabelecidas pela legislação. Neste sentido, os produtos Panini estão devidamente marcados com o símbolo do caixote do lixo barrado com uma cruz (Directiva (WEEE) da União Europeia), para indicar a necessidade de uma recolha separada de equipamento eléctrico e electrónico comercializado após 13 de Agosto de 2005, de acordo com a directiva (WEEE) 2002/96/CEE (e posteriores alterações) e a legislação nacional.



Para eliminar os aparelhos correctamente:

- Contacte as autoridades competentes ou o distribuidor local, que lhe fornecerá as informações práticas de que necessita e as instruções para o tratamento adequado do lixo, por exemplo: localização e horário dos centros de recolha de resíduos, etc.
- Quando adquirir um novo aparelho, entregue ao seu distribuidor um aparelho usado semelhante ao que acabou de adquirir, para garantir uma eliminação adequada.

PARA OUTROS PAÍSES (NÃO PERTENCENTES À UE)

O tratamento, recolha, reciclagem e eliminação de aparelhos eléctricos e electrónicos será efectuado de acordo com a legislação em vigor no país em questão.

10.1 Público alvo

Este manual destina-se principalmente ao pessoal responsável pelas verificações ou outros documentos.

10.2 Precauções de segurança

Antes de começar a utilizar ou a efectuar a manutenção do seu Vision X de acordo com as instruções neste manual, certifique-se de que leu e compreendeu estas importantes precauções de segurança.

- Use vestuário de protecção. Não use roupa folgada, cabelo comprido ou jóias que possam ficar presas nas partes em movimento.
- Não apoie nada no cabo de alimentação. Não coloque o Vision X em locais onde as pessoas possam pisar o cabo.
- Desligue sempre o Vision X antes das operações de limpeza.
- Não tente efectuar operações de manutenção ou reparação no Vision X, salvo indicações em contrário neste manual.
- A tentativa de efectuar operações de manutenção ou reparação na alimentação externa do Vision X pode expô-lo a picos de tensão perigosos ou outros riscos.
- Confie estas operações a pessoal de assistência qualificado.

Nota:

- O Vision X estará em conformidade com as normas IEC/EN 60950-1 e UL 60950-1 utilizando apenas o modelo de alimentação de energia DSA-0421S-28 1 42 fornecido com a máquina.
- A tomada será instalada próximo do equipamento e deverá estar facilmente acessível.
- CONDIÇÕES DE FUNCIONAMENTO: Temperatura: 15 ÷ 35°C. Humidade: 20 ÷ 80% H.R. não condensada.

10.3 Se a máquina estiver danificada

Desligue o Vision X da tomada e confie as operações de manutenção a pessoal qualificado nas seguintes condições:

- Se o cabo de alimentação estiver gasto ou danificado.
- Se se derramar líquido no produto.
- Se o equipamento tiver sido exposto à chuva ou água.
- Se o equipamento não funcionar normalmente quando se seguem as instruções de funcionamento.
- Se o equipamento tiver caído ou estiver danificado.
- Se o equipamento apresentar uma alteração visível em termos de desempenho, indicando uma necessidade de manutenção.

Ajuste apenas estes comandos e substitua apenas as peças abrangidas neste manual de instruções.

Se tentar realizar ajustes não abrangidos neste manual, poderá danificar o equipamento e anular a garantia.

Ajustes ou reparações não autorizados podem resultar na necessidade de operações alargadas por parte de um técnico qualificado para fazer regressar o equipamento à sua condição de funcionamento adequada.

10. Correct afdanken volgens de elektrische en elektronische apparaten WEEE-richtlijn

VOOR LANDEN IN DE EUROPESE UNIE (EU)

De Europese Commissie van de Europese Unie heeft bepaald dat elektrische en elektronische apparaten die tegenwoordig op de markt zijn onderdelen en componenten bevatten die op correcte wijze hergebruikt of gerecycled kunnen worden teneinde de hoeveelheid materiaal die uiteindelijk op stortterreinen en andere afvalplaatsen terecht komt te verminderen. Om aan deze bepaling te voldoen, mag afgedankte elektrische en elektronische apparatuur (WEEE) niet ingezameld of weggegooid worden samen met ongesorteerd afval van particuliere huishoudens of bedrijven. Het dient daarentegen gescheiden te worden ingezameld. Het weggoien van deze apparaten op plaatsen die daarvoor niet ingericht en bevoegd zijn kan gevaarlijke gevolgen hebben voor de gezondheid en het milieu. Overtreders zullen onderworpen worden aan de in de wet vastgestelde boetes en maatregelen.

Daarom zijn de producten van Panini overeenkomstig voorzien van het door de Europese WEEE-richtlijn voorgeschreven symbool van de doorgekruiste verrijdbare afvalbak om de vereiste aan te geven van gescheiden inzameling van elektrische en elektronische apparatuur die na 13 augustus 2005 op de markt is gebracht, in overeenstemming met de WEEE-richtlijn 2002/96/EG (en hierna volgende amendementen) en uw nationale wetten.



Om uw apparatuur op de juiste wijze af te danken:

- kunt u contact opnemen met de plaatselijke autoriteiten of plaatselijke distributeur, die u de noodzakelijke praktische informatie en de aanwijzingen voor het op de juiste hanteren van het afval zal geven, bijvoorbeeld: plaats en openingstijden van de afvalinzamelcentra, enz.
- Indien u een nieuw apparaat van ons aanschaft, lever dan een vergelijkbaar apparaat in bij onze distributeur voor verwerking tot afval.

VOOR ANDERE LANDEN (NIET BINNEN DE EU)

De behandeling, inzameling, recycling en afvalverwerking van elektrische en elektronische apparatuur dient te geschieden in overeenstemming met de geldende wetten in het betreffende land.

10.1 Doelgroep

Deze handleiding is in de eerste plaats geschreven voor personeel die controles uitvoert of andere documenten samenstelt.

10.2 Veiligheidsmaatregelen

Verzeker u er alstublieft van dat u, voordat u uw Vision X in gebruik neemt of enig onderhoud verricht zoals beschreven in deze handleiding, deze belangrijke veiligheidsinstructies gelezen en begrepen hebt.

- Draag veilige kleding. Draag geen loshangende kleding, lang haar of juwelen die verstrikt kunnen raken in bewegende delen.
- Laat niets op het voedingsnoer staan. Zet de Vision X niet op plaatsen waar mensen over het snoer kunnen lopen.
- Trek de stekker van de Vision X altijd uit het stopcontact voordat u hem schoonmaakt.
- Probeer geen onderhoud of reparaties te verrichten aan de Vision X, behalve als deze handelingen elders in deze handleiding beschreven zijn.
- Als u probeert onderhoud of reparaties te verrichten aan de externe elektrische voeding van de Vision X loopt u het risico van blootstelling aan een hoog voltage of andere risico's.
- Laat alle onderhoudswerkzaamheden over aan gekwalificeerd onderhoudspersoneel.

Opmerking:

- De Vision X voldoet alleen aan de norm IEC/EN 60950-1 en UL 60950-1 wanneer de Voeding, model DSA-0421S-28 1 42, die bij de machine geleverd is, gebruikt wordt.
- De uitgang van het stopcontact dient vlakbij de apparatuur geïnstalleerd te worden en moet makkelijk toegankelijk zijn.
- BEDIENINGSVOORWAARDEN: Temperatuur: 15 ÷ 35°C. Vochtigheidsgraad: 20 ÷ 80% R.H. Niet-Condenerend.

10.3 Als de machine beschadigd is

Trek de stekker van de Vision X uit het stopcontact en wend u voor onderhoud tot gekwalificeerd personeel, in de volgende omstandigheden:

- Als de voedingskabel beschadigd of gerafeld is.
- Als er vloeistof in het product gemorst is.
- Als de apparatuur blootgesteld geweest is aan regen of water.
- Als de apparatuur niet normaal werkt terwijl de bedieningsinstructies zijn opgevolgd.
- Als de apparatuur gevallen of beschadigd is.
- Als de apparatuur een duidelijke verandering in de prestatie vertoont, hetgeen aangeeft dat onderhoud nodig is.

Stel alleen die bedieningselementen af en vervang uitsluitend die onderdelen die beschreven zijn in de instructies in deze handleiding.

Als u tracht aanpassingen te maken die niet zijn beschreven in deze handleiding, kunt u de apparatuur beschadigen en de garantie ongeldig maken.

Onbevoegde aanpassingen of reparaties kunnen leiden tot de noodzaak van uitgebreide werkzaamheden door een gekwalificeerd technicus, om de apparatuur weer terug te brengen in de toestand van goede werking.

10. Korrekt kassering av elektrisk og elektronisk utstyr (WEEE)

FOR LAND I DEN EUROPEISKE UNION (EU)

Europakommisjonen i EU har slått fast at elektrisk og elektronisk utstyr på dagens marked inneholder deler og komponenter som på korrekt vis kan brukes på nytt eller bli resirkulert, slik at mengdene av materialer som tilslutt blir kastet på fyllplasser og andre søppelområder, reduseres. For å forholde seg til denne beslutningen må man ikke samle opp eller kaste elektrisk og elektronisk utstyr sammen med usortert søppel fra privathusholdninger eller fra forretningsvirksomheter. Det må derimot samles inn særskilt. Det kan ha skadelig innvirkning på helse og miljø hvis slike innretninger kastes på steder som ikke har autorisasjon eller utstyr. Gjerningspersoner vil kunne bli gjenstand for de straffereaksjoner og -tiltak som er fastsatt i lovverket. I denne sammenheng er Panini-produktene korrekt merket med symbolet bestående av en søppelbøtte med et kryss over, som angitt i EUs WEEE-direktiv. Dette angir kravet om særskilt innsamling av elektrisk og elektronisk utstyr som kom på markedet etter 13. august 2005 i henhold til WEEE-direktiv 2002/96/EC (og senere endringer) og din nasjonale lovgivning.



Slik kasserer du innretningene på korrekt vis:

- Kontakt lokale myndigheter eller lokal distributør, som vil gi deg den praktiske informasjonen du behøver og veiledninger for å håndtere søppel korrekt, for eksempel: Lokasjon og åpningstider til søppelopsamlingsstasjonene osv.
- Når du kjøper en ny innretning fra oss, kan du gi til distributøren vår en innretning som er lik den du kjøper, for kassering.

FOR ANDRE LAND (IKKE I EU)

Behandlingen, innsamlingen, resirkuleringen og kasseringen av elektriske og elektroniske innretninger vil bli utført i samsvar med lovverket som gjelder i det aktuelle landet.

10.1 Målgruppe

Denne håndboken er hovedsakelig skrevet for personer som behandler kontroller og andre dokumenter.

10.2 Sikkerhetsforanstaltninger

Før du begynner å bruk eller foreta service på Vision X som angitt i denne håndboken, må du lese og forstå disse viktige sikkerhetsveiledningene.

- Kle deg sikkert. Ikke bruk løstsittende klær, ikke ha langt hår eller smykker som kan henge seg opp i bevegelige deler.
- Ikke la noe ligge oppå strømledningen. Ikke plasser Vision X der du risikerer at noen trækker på ledningen.
- Koble alltid Vision X fra før rengjøring.
- Ikke prøv å utføre service eller reparasjoner på Vision X bortsett fra det som det er gitt veiledning om andre steder i denne håndboken.
- Du kan bli utsatt for farlig spenning eller andre farer hvis du prøver å utføre service eller reparasjoner på den eksterne strømforsyningen til Vision X.
- Henvis all service til kvalifisert servicepersonell.

Merk:

- Vision X er i samsvar med standarden IEC/EN 60950-1 og 60950-1 kun bruk av strømforsyningsmodell DSA-0421S-28 1 42 som leveres med maskinen.
- Kontaktuttaket må installeres nær utstyret og være lett tilgjengelig.
- BRUKSFORHOLD: Temperatur: 15 ÷ 35° C. Fuktighet: 20 ÷ 80 % R.H. ikke-kondenserende.

10.3 Hvis maskinen er skadet

Trekk ut ledningen til Vision X fra uttaket i veggen, og henvis servicen til kvalifisert personell under følgende forhold:

- Hvis strømledningen er skadet eller slitt.
- Hvis det er sølt væske inn i produktet.
- Hvis utstyret har vært utsatt for regn eller vann.
- Hvis utstyret ikke virker normalt når bruksveiledningene følges.
- Hvis utstyret har falt i bakken eller er blitt skadet.
- Hvis utstyret viser en tydelig endring i ytelsen, som angir behov for service.

Juster kun de kontrollene, og bytt kun ut de elementene som omfattes av veiledningene i denne håndboken.

Hvis du prøver å foreta justeringer som ikke omfattes av denne håndboken, kan du skade utstyret og ugyldiggjøre garantien.

Uautoriserte justeringer eller reparasjoner kan føre til at det blir nødvendig med omfattende arbeider utført av kvalifisert tekniker for at utstyret skal bli satt tilbake i skikkelig stand.

10. Korrekt kassering av elektroniska komponenter enligt (WEEE)

FÖR LÄNDER INOM DEN EUROPEISKA UNIONEN (EU)

Europakommissionen i den Europeiska Unionen har fastställt att elektronisk utrustning som finns på marknaden idag innehåller delar och komponenter som kan återanvändas eller återvinnas för att minska den mängd material som slutligen hamnar på tippen och andra sopförvaringsplatser. För att tillgodose denna bestämmelse skall avfall från elektriska och elektroniska produkter (WEEE) inte samlas upp tillsammans med osorterat avfall från privata hushåll eller företag. Det skall istället samlas in separat. Att dumpa dessa apparater på icke härför utrustade eller icke-auktorerade platser kan ha en farlig inverkan på vår hälsa och miljö. Lagöverträdare blir föremål för de åtal och straff som lagen föreskriver.

Därför är Panini-produkter märkta med det härför avsedda EU-märket (WEEE): en symbol med en överkryssad soptunna som visar att den skall gå till separat uppsamling enligt den lag som säger att elektriska och elektroniska produkter som når marknaden efter den 13 augusti 2005 skall återvinnas enligt WEEE-direktivet 2002/96/EG (och senare tillägg) och enligt lokal lagstiftning.



För att skrota våra produkter på ett korrekt vis:

- Kontakta dina lokala myndigheter eller din lokala återförsäljare: de kan ge dig de praktiska upplysningar som du behöver och alla instruktioner om hur du korrekt skall behandla dessa sopor, till exempel: plats och öppettider för sopstationer, osv
- Då du handlar en ny apparat av oss, kan du lämna den gamla apparaten hos vår återförsäljare som ser till att skrota den på korrekt vis.

FÖR ANDRA LÄNDER (UTANFÖR DEN EUROPEISKA UNIONEN (EU))

Behandling, insamling, återvinning och skrotning av elektrisk och elektronisk utrustning skall utföras i enlighet med de lokala lagarna i landet i fråga.

10.1 Målgrupp

Denna manual är först och främst skriven för den personal som utför kontroll och annan dokumentation.

10.2 Säkerhetsföreskrifter

Innan du börjar använda eller serva din VisionX enligt instruktionerna i denna manual, skall du läsa och förstå dessa viktiga säkerhetsinstruktioner.

- Klä dig säkert. Använd inte lössittande kläder eller smycken, och ha inte långt hår - dessa kan alla fastna i rörliga delar.
- Se till att ingenting står på strömkabeln. Placera inte VisionX på en plats där folk måste kliva på eller över strömkabeln.
- Koppla alltid loss VisionX från strömförande nät innan du rengör den.
- Utför inget underhåll eller reparation på VisionX, förutom enligt de instruktioner du finner i denna manual.
- Att försöka serva eller reparera det yttre strömförsörjningspaketet på VisionX kan utsätta dig för farligt höga volttal och andra risker.
- Se till att allt underhållsarbete utförs av kvalificerad underhållspersonal.

OBS:

- Vision X är endast i överensstämmelse med standard IEC/EN 60950-1 och UL 60950-1 om Strömförsörjningsenhet av modell DSA-0421S-28 1 42 används, den medföljer maskinen.
- Vägguttaget skall vara placerat i närheten av utrustningen och skall vara lättåtkomligt.
- DRIFTSFÖRHÅLLANDEN: Temperatur: 15 ÷ 35 °C. Luftfuktighet: 20 ÷ 80 % relativ luftfuktighet, icke-kondenserande.

10.3 Om maskinen är skadad

Koppla bort Vision X från strömförande nät och se till att underhållet utförs av kvalificerad personal vid dessa tillfällen:

- Om den strömförande kabeln är skadad eller sliten.
- Om vätska spillts i maskinen.
- Om utrustningen har utsatts för regn eller vatten.
- Om utrustningen inte fungerar normalt trots att driftsinstruktionerna följs.
- Om utrustningen har tappats eller skadats.
- Om utrustningen uppvisar nedsatt prestanda, något som tyder på behov för underhåll.

Justera endast de reglage och byt endast ut de delar som finns omnämnda i denna manual.

Om du försöker att justera sådant som inte behandlas i denna manual, kan du eventuellt skada utrustningen och då ogiltigförklaras garantin.

Icke-auktorerade ingrepp eller reparationer kan resultera i betydande arbetsinsats av en kvalificerad tekniker för att återställa utrustningen till dess korrekta driftskondition.

10. Sähkö- ja elektroniikkalaitteiden oikea hävittäminen (WEEE)

EUROOPAN UNIONIN MAAT (EU)

Euroopan Unionin komissio on päättänyt, että nykyään markkinoilla olevat sähköiset ja elektroniset laitteet sisältävät osia ja komponentteja, joita voidaan uudelleenkäyttää tai kierrättää sellaisten jätteiden vähentämiseksi, jotka käytetään täyttömaana tai viedään kaatopaikalle. Tämän päätöksen mukaisesti sähkö- ja elektroniikkalaiteromua (WEEE) ei saa kerätä tai hävittää yhdessä lajittelemattomien kotitalous- tai yhdyskuntajätteiden kanssa. Se on kerättävä erikseen. Näiden laitteiden jättäminen varustelemattomiin tai valtuuttamattomiin paikkoihin saattaa aiheuttaa vaaraa terveydelle ja ympäristölle. Rikkomuksentekijöitä rangaistaan lain mukaisesti.

Tätä varten Panini-tuotteet on asianmukaisesti merkitty Euroopan Unionin WEEE-direktiivin mukaisella merkillä, jossa on risti jäteastian päällä, joka osoittaa, että 13. elokuuta 2005 jälkeen markkinoille tulleet sähkö- ja elektroniikkalaitteet täytyy WEEE-direktiivin 2002/96/EY (ja myöhempien muutosten) mukaisesti kerätä erikseen.



Laitteiden asianmukainen hävittäminen:

- Ota yhteys paikallisiin viranomaisiin tai jälleenmyyjään, joilta saat tarvitsemasi käytännön tiedot ja ohjeet romun käsittelemistä varten, esimerkiksi: keräyskeskusten sijainti ja aukioloajat jne.
- Kun hankit uuden laitteen, palauta samanlainen käytetty laite jälleenmyyjälle hävittämistä varten.

MUUT MAAT (EI EU)

Sähkö- ja elektroniikkaromun käsittely, kerääminen, kierrätys ja hävittäminen on tehtävä maassa voimassa olevien lakien mukaisesti.

10.1 Kenelle opas on tarkoitettu

Tämä opas on laadittu ennen kaikkea henkilökunnalle, joka käsittelee shekkejä tai muita asiakirjoja.

10.2 Turvallisuusvarotoimet

Varmista, että olet lukenut ja ymmärtänyt nämä tärkeät turvaohjeet ennen kuin alat käyttää tai huoltaa Vision X -laitetta.

- Pukeudu turvallisesti. Älä käytä löysiä vaatteita, älä pidä pitkää tukkaa auki, älä käytä koruja, jotka saattavat tarttua liikkuviin osiin.
- Virtajohdon päällä ei saa olla mitään. Älä sijoita Vision X -laitetta paikkaan, jossa joku voi kävellä johdon päällä.
- Irrota pistoke aina pistorasiasta ennen Vision X -laitteen puhdistamista.
- Älä yritä huoltaa tai korjata Vision X -laitetta muuten kuin tässä oppaassa kuvatulla tavalla.
- Vision X:n virtajohdon huolto- tai korjausyritykset saattavat aiheuttaa sähköisku- tai muun vaaran.
- Anna kaikki huoltotoimet pätevän henkilökunnan tehtäväksi.

Huomaa:

- Vision X vastaa standardeja IEC/EN 60950-1 ja UL 60950-1 vain kun käytetään koneen mukana toimitettua virtajohtoa, malli DSA-0421S-28 1 42.
- Pistorasian täytyy olla laitteen lähellä ja sen on oltava helposti saavutettavissa.
- KÄYTTÖOLOSUHTEET: Lämpötila: 15 ÷ 35 °C. Kosteus: 20 ÷ 80 % S.K. tiivistymätön.

10.3 Jos kone on vahingoittunut

Kytke Vision X irti sähköverkosta ja anna huolto pätevän henkilökunnan tehtäväksi seuraavissa olosuhteissa:

- Jos virtajohto on vahingoittunut tai kulunut.
- Jos tuotteeseen on valunut nestettä.
- Jos laitteisto on ollut sateessa tai vedessä.
- Jos laitteisto ei toimi normaalisti kun käyttöohjeita noudatetaan.
- Jos laite on pudonnut tai vaurioitunut.
- Jos laitteen tehossa havaitaan selvä muutos, joka osoittaa, että huoltoa tarvitaan.

Säädä ainoastaan sellaisia asetuksia ja vaihda ainoastaan sellaisia osia, jotka kuvataan tässä oppaassa.

Jos yrität tehdä muita kuin tässä oppaassa kuvattuja säätöjä, laite voi vahingoittua ja takuu raukeaa.

Valtuuttamattomat säädöt tai korjaukset voivat johtaa tilanteeseen, jossa vaaditaan pätevän teknikon työskentelyä laitteen palauttamiseksi oikeisiin toimintaolosuhteisiin.

10. Σωστή απόρριψη των (WEEE)

ΓΙΑ ΧΩΡΕΣ ΣΤΗΝ ΕΥΡΩΠΑΪΚΗ ΕΝΩΣΗ (ΕΕ)

Η Ευρωπαϊκή Επιτροπή της Ευρωπαϊκής Ένωσης έχει καθορίσει ότι οι ηλεκτρικές και ηλεκτρονικές συσκευές στην αγορά σήμερα περιέχουν μέρη και εξαρτήματα τα οποία μπορούν να επαναχρησιμοποιηθούν ή να ανακυκλωθούν κατάλληλα για να μειωθούν οι ποσότητες των υλικών που τελικά απορρίπτονται σε χωματερές και άλλους χώρους απόρριψης. Για να εξυπηρετηθεί αυτή η απόφαση, τα απόβλητα ηλεκτρικού και ηλεκτρονικού εξοπλισμού (WEEE) δεν πρέπει να συλλέγονται ή να απορρίπτονται μαζί με τα απορρίμματα που δεν έχουν υποστεί διαλογή από ιδιωτικές κατοικίες ή επιχειρήσεις. Αντίθετα, πρέπει να συλλέγονται ξεχωριστά. Η απόρριψη αυτών των συσκευών σε χώρους χωρίς κατάλληλο εξοπλισμό ή εξουσιοδότηση μπορεί να έχει επικίνδυνες επιπτώσεις στην υγεία και το περιβάλλον. Οι παραβάτες θα υπόκεινται σε ποινές και μέτρα που καθορίζει η νομοθεσία.

Προς το σκοπό αυτό, τα προϊόντα της Ranini φέρουν την κατάλληλη σήμανση με το σύμβολο του διαγραμμένου κάδου απορριμμάτων της Οδηγίας (WEEE) της Ευρωπαϊκής Ένωσης, για να υποδεικνύουν την ανάγκη για ξεχωριστή συλλογή του ηλεκτρικού και ηλεκτρονικού εξοπλισμού που κυκλοφόρησε στην αγορά μετά τις 13 Αυγούστου 2005, σύμφωνα με την οδηγία (WEEE) 2002/96/ΕΚ (και τις επακόλουθες τροπολογίες της) και την εθνική σας νομοθεσία.

Για να απορριφθούν σωστά οι συσκευές μας:

- Επικοινωνήστε με τις τοπικές αρχές ή τον τοπικό αντιπρόσωπο, οι οποίοι θα σας δώσουν τις πρακτικές συμβουλές που χρειάζεστε και τις οδηγίες για το σωστό χειρισμό των αποβλήτων, για παράδειγμα: τοποθεσίες και ώρες λειτουργίας των κέντρων συλλογής απορριμμάτων, κλπ.
- Όταν αγοράζεται μια καινούρια συσκευή μας, παραδώστε μια μεταχειρισμένη συσκευή παρόμοια με εκείνη που αγοράσατε στον αντιπρόσωπό μας για απόρριψη..



ΓΙΑ ΑΛΛΕΣ ΧΩΡΕΣ (ΟΧΙ ΣΤΗΝ ΕΕ)

Η επεξεργασία, συλλογή, ανακύκλωση και απόρριψη των ηλεκτρικών και ηλεκτρονικών συσκευών θα πραγματοποιείται σύμφωνα με την ισχύουσα νομοθεσία στη συγκεκριμένη χώρα.

10.1 Αποδέκτες

Το εγχειρίδιο αυτό γράφτηκε κυρίως για το προσωπικό που χειρίζεται τους ελέγχους ή άλλα έγγραφα.

10.2 Προφυλάξεις ασφαλείας

Πριν ξεκινήσετε τη λειτουργία ή το σέρβις του Vision X σύμφωνα με τις οδηγίες του παρόντος εγχειριδίου, παρακαλούμε βεβαιωθείτε ότι διαβάσατε και κατανοήσατε αυτές τις σημαντικές οδηγίες ασφαλείας.

- Ασφάλεια ένδυσης. Μη φοράτε χαλαρά ρούχα, μακριά μαλλιά ή κοσμήματα τα οποία μπορεί να μπλεχτούν σε κινούμενα μέρη.
- Μην αφήνετε τίποτε να ακουμπά πάνω στο καλώδιο τροφοδοσίας. Μην τοποθετείτε το Vision X σε σημείο όπου κάποιος μπορεί να πατήσει πάνω στο καλώδιο τροφοδοσίας.
- Πάντοτε αποσυνδέετε το Vision X από την πρίζα πριν τον καθαρισμό.
- Μην προσπαθήσετε να επισκευάσετε ή να συντηρήσετε το Vision X, με εξαίρεση τις οδηγίες που παρέχονται σε άλλο σημείο του παρόντος εγχειριδίου.
- Η προσπάθεια συντήρησης ή επισκευής της εξωτερικής παροχής τροφοδοσίας του Vision X μπορεί να σας εκθέσει σε σημεία με επικίνδυνες τάσεις ή άλλους κινδύνους.
- Αναθέστε κάθε συντήρηση σε εξειδικευμένο προσωπικό σέρβις.

Σημείωση:

- Το Vision X θα είναι σύμφωνο με το πρότυπο IEC/EN 60950-1 και UL 60950-1 χρησιμοποιώντας μόνο το μοντέλο Παροχής Τροφοδοσίας DSA-0421S-28 1 42 που διατίθεται με το μηχάνημα.
- Ο ρευματολήπτης θα πρέπει να είναι εγκατεστημένος κοντά στον εξοπλισμό και να είναι εύκολα προσβάσιμος.
- ΣΥΝΘΗΚΕΣ ΛΕΙΤΟΥΡΓΙΑΣ: Θερμοκρασία: 15 ÷ 35°C. Υγρασία: 20 ÷ 80%. Σ.Υ. Χωρίς συμπύκνωση.

10.3 Εάν το μηχάνημα πάθει ζημιά

Αποσυνδέστε το Vision X από την πρίζα στον τοίχο και αναθέστε τη συντήρηση σε εξειδικευμένο προσωπικό σέρβις υπό τους παρακάτω όρους:

- Εάν το καλώδιο τροφοδοσίας έχει υποστεί ζημιά ή έχει ξεφτίσει.
- Εάν έχει χυθεί υγρό πάνω στο προϊόν.
- Εάν η συσκευή εκτέθηκε σε βροχή ή νερό.
- Εάν η συσκευή δε λειτουργεί κανονικά όταν ακολουθούνται οι οδηγίες λειτουργίας.
- Εάν η συσκευή έπεσε ή έπαθε ζημιά.
- Εάν η συσκευή παρουσιάσει σαφή αλλαγή στην απόδοση, υποδεικνύοντας την ανάγκη για σέρβις.

Ρυθμίστε μόνο εκείνα τα χειριστήρια και αντικαταστήστε μόνο εκείνα τα εξαρτήματα τα οποία καλύπτονται από τις οδηγίες του παρόντος εγχειριδίου.

Εάν προσπαθήσετε να κάνετε ρυθμίσεις οι οποίες δεν καλύπτονται στο παρόν εγχειρίδιο, μπορεί να προκαλέσετε βλάβη στη συσκευή και να ακυρώσετε την εγγύηση.

Οι μη εξουσιοδοτημένες ρυθμίσεις μπορεί να προκαλέσουν την ανάγκη για εκτενή εργασία από εξειδικευμένο τεχνικό για την αποκατάσταση της συσκευής στην κανονική κατάσταση λειτουργίας της.

10. WEEE指令による電気・電子器具廃棄物の適正処理

欧州連合（EU）諸国に向けて

欧州連合の欧州委員会は、その取り決めの中で、今日市場に販売されている電子器具には最終的にごみ処理埋め立て地や、その他の理由で処分されることになるパズルやコンポーネントが含まれており、そうした素材の分量を削減するためには再利用またはリサイクルできるものがある、としています。

こうした取り決めにする取り決めとして、電子器具廃棄物（WEEE）は、分別収集されない一般の家庭ごみやオフィス廃棄物といっしょに回収または処分されるべきではないものと定められています。むしろ、分別回収が要求されます。こうした装置を分別が整っていない回収所に投ずることは、保健と環境にとって有害な結果を及ぼす恐れがあります。反者には、法律により定められた刑罰ならびに措置が科されることとなります。こうした目的のため、2002/96/EC（後の改正も含む）のWEEE指令とあなたの居住国の法律に一致し、Panini（パニニ）の製品には2005年8月13日以降に市場に投入された電子器具の分別回収をする必要条件を示す欧州連合WEEE指令のゴミ箱上に貼られた所定マークが付されています。



弊社の装置を正しい方法で処分するためには：

- 製品の正しい取り扱い方について必要な情報の提供や指図を行っている地方の当局または地方自治体におい合わせいただき、例えば回収所などといった施設の場所や受付などをご確認ください。
- また、弊社の新しい装置をお使いの旧型装置が分別できるよう弊社にお渡しください。

その他諸国（EU以外の国々）に向けて

電子器具装置の取り扱い、また回収、リサイクル、分別は当該国で施行されている法律に基づいて行われるものとします。

10.1 本書の対象となる主体

本マニュアルは、主として やその他文 のデータ 理を行う にあたる人々に向けて作成されています。

10.2 安全のための注意

本 マ ニ ュ ア ル の 解 に し た が っ て V i s i o n X (ヴィジョンエックス)の操作や点を 始する前に、こちらに された安全のための注意をしっかりと お みていただき、理解 であることをご ください。

- 安全な作 着を着用のこと。ルズ な衣服の着用や 、またはジュエリ などを身に付けていた 合、装置の可 部に き まれる恐れがあります。
- 源コード 上には、何も せないでください。Vision X (ヴィジョンエックス)の 置 所は、人がコード を踏んで渡る恐れ のあるようなところに 定しないでください。
- Vision X (ヴィジョンエックス)のクリーニング を行う前には、必ずプラグを いてください。
- Vision X (ヴィジョンエックス)は、本マニュアル に解 された以外の方法で点 または修理の みを行わないでください。
- Vision X (ヴィジョンエックス)の点 または修理の みを行う に外部 源供 が用いられた 合、 度に高 となったりの他 の危 に身をさらすことになったりする恐れがあります。
- 点 についてはすべて 格の担当スタッフにお えてください。

注：

- Vision X (ヴィジョン・エックス)は、装置とセットの モデル DSA-0421S-28 1 42 と合わせて使用された に限り 格 IEC/EN 60950-1およびUL 60950-1とのコンプライアンスが守られます。
- 出力ソケットは装置の近くに 置し、すぐ手の届く 所に保つ必要があります。
- 作 条件：温度15 ÷ 35 °C、湿度20 ÷ 80% R.H.、 露のないこと。

10.3 機械が破損した場合の対処について

Vision X (ヴィジョンエックス) のプラグを壁面の出力から引き取り、下の状態について点検して格の担当スタッフにお伝えください：

電源コードに破損部や擦り切れた部分がないかどうか。

品の中に液体が流出してきていないかどうか。

装置が雨や水にさらされたことがあるかどうか。

使用上の注意を守って操作中、装置が正常に動作しないことがあるかどうか。

装置が倒れたり落下したり破損したりしたことがあるかどうか。

装置の性能に、点検の必要を要して取ることのできるほどの目立った変化が表れていないかどうか。

本マニュアルの使用解除に記述のある部分でのみ、コントロールパネルのケーブルやパワースイッチなどの交換を行ってください。

本マニュアルに記載のない調節を行うよう試みた場合、装置に破損をきたすこととなり、製品保証は無効となります。

可動部や修理を行なった場合、装置の動作状態を元に戻すため、格の担当技者がより詳しく点検を行う必要性が生ずることになります。

10. WEEE的正确处理

适用于欧盟(EU)国家

欧盟的欧洲委员会规定目前市场上的电子电气设备的零部件可以适当重新使用或再循环，以减少最终掩埋在垃圾填筑地和其它垃圾处理场所的材料数量。为了遵循这一规定，废旧电子电气设备(WEEE)不应连同私人家庭或商业的未分类垃圾一起被回收或处理。它们必须分开回收。将这些装置废弃在设施不良和未经授权的地方，可能会对健康和环境造成危险。违反者将根据法律规定受到处罚。为此，Panini产品适当标有欧盟WEEE指令的打交叉垃圾桶标记，该标记表示根据WEEE指令2002/96/EC(以及后续修订条例)和您的国家法律，从2005年8月13日起投放到市场的电子电气设备需要分开回收。

本公司设备的正确处理方法：

联系地方当局或当地分销商，他们将给予您所需的实用资料及正确处理废物的说明，例如：废品回收中心的地点和时间等等。

当您购买我们的一台新设备时，可以将类似所购设备的废旧产品交由我们的分销商进行处理。



适用于其它国家(非欧盟国家)

电子电气设备的处理、回收、再循环和废弃，将根据有关国家的现行法律规定进行。

10.1 观众

本手册主要为处理检查或其他文件的人士而编写。

10.2 安全措施

在您根据本手册开始操作或维修您的Vision X设备前，请确认您已阅读和理解这些重要的安全说明。

衣着安全。不要穿着宽松的衣服、披长头发或穿戴首饰，因为它们可能会缠住运动部件。

不要让任何东西压在电源线上。不要将Vision X放置在人们可能踩踏电源线的地方。

清洁前必须拔出Vision X的电源插头。

不要尝试自行保养或维修Vision X，除非本手册有说明。

尝试保养或维修Vision X的外部电源，可能令您有触电或其它危险。

所有维修应由有资格的维修人员进行。

备注：

Vision X只有在使用本机随附的电源型号DSA-0421S-28 1 42时才符合标准IEC/EN 60950-1及UL 60950-1。

插座出口必须安装在设备附近而且容易接触。

操作条件：温度：15 ÷ 35 °C。湿度：20 ÷ 80% R.H.。不冷凝

10.3 如果机器损坏

将Vision X的电源插头从墙上的电源插座中拔出，并在以下情况下请专业人员维修：

- 如果电源线损坏或磨损。
- 如果液体溢出到产品中。
- 如果设备受到雨淋或被水弄湿。
- 如果遵循了操作说明但设备操作不正常。
- 如果设备跌落或损坏。
- 如果设备性能发生明显变化而需要维修。

只进行本手册有说明的控制调节和零件更换。

如果您尝试进行本手册没有说明的调节，您可能会损坏设备并导致担保失效。

未经授权的调节或维修可能导致专业技术人员需要花费很多功夫才能令设备恢复正常的工作条件。



Advanced Solutions
for Document Processing



Notes
