



Architecture

21036

Arc de Triomphe

Paris, France

L'Arc de Triomphe

Paris, France

Arco del Triunfo

París (Francia)



LEGO.com/architecture/booklet

Arc de Triomphe



Located at the western end of the Champs-Élysées, the iconic Arc de Triomphe stands at the center of the Place Charles de Gaulle, also known as the “Place de l’Étoile”.

It was built between 1806 and 1836 in honor of those who had fought for France and is considered the linchpin of the historic axis (L’Axe historique) – a sequence of monuments and grand thoroughfares on a route that stretches from the courtyard of the Louvre Palace to the outskirts of Paris.



Then and now

Commissioned by Napoléon I to commemorate his military conquests, the Arc de Triomphe was the world's largest triumphal arch when it was finally completed in 1836. Architect Jean François Thérèse Chalgrin's creation is twice the size of the ancient Roman Arch of Constantine after which it is modeled. Work on the Arch stopped when Napoléon was defeated in 1814, but started up again in 1833 in the name of King Louis-Philippe I, who dedicated it to the glory of the French armed forces.

Seen as an emblem of French patriotism, the Arc de Triomphe is engraved with the names of war victories and 558 generals (those who died at war are underlined). An Unknown Soldier is buried under the arch and an eternal flame of remembrance, lit since 1920, commemorates victims of the world wars.

Each of the Arc's pillars is adorned with one of four large sculptural reliefs: The Departure of the Volunteers in 1792 (aka La Marseillaise), Napoléon's Triumph of 1810, Resistance of 1814 and Peace of 1815. The simple design and immense size of the Arc de Triomphe are typical of late 18th-century romantic neoclassicism.

The observation deck at the top of the Arch still offers some of the best views in Paris. At the summit of 284 steps, you can see much of the city and take in the spectacular panoramas of La Défense, the Champs Elysées and the Sacré Coeur. On national holidays like Armistice Day and Bastille Day, the decorated Arc de Triomphe always features at the beginning or end of the parade or celebration.



The architects and design history



In March 1806, architect Jean-Francois-Therese Chalgrin (1739-1811) was given the task of finding the best possible location for a “triumphal arch” in Paris. He studied several different options and on May 9th, Napoleon agreed to the site: Place de l'Etoile.

Chalgrin was then tasked with designing and constructing the Arch itself, and on August 15th, 1806 the first stone was laid to coincide with Napoleon's birthday. Chalgrin was able to see his drawings brought to life when a wood and painted canvas replica of the Arch was constructed exactly the same

as it was to be built. This allowed the architect to make some last minute changes after seeing what it would look like.

After the unfortunate death of Chalgrin in 1811, the work was taken over by Louis-Robert Goust (1762-1838) who had been a pupil of Chalgrin. The construction of the arch was disrupted and eventually halted in April 1814 by the defeat of Napoleon and subsequent decades of political turmoil. In 1832 the architect Guillaume-Abel Blouet (1795-1853) took over the project and the Arch was eventually completed in 1836. Blouet is the architect actually credited on the monument itself.

While the Neoclassical version of ancient Roman architecture was Chalgrin's design, the main sculptures, treated as independent trophies applied to the vast masonry edifice, were created by many of the most renowned French artists of the day such as Jean-Pierre Cordot, François Rude, Antoine Étex, James Pradier and Philippe Lemaire.





Facts

- Location: Paris, France
Construction Period: 1806 to 1836
Architectural Style: 19th century Neo-Classical
Dimensions: 162 ft. (49.5 m) tall,
150 ft. (45 m) wide and
72 ft. (22 m) deep
Construction Materials: White Limestone





*"You will return home through
arches of triumph"*

Napoleon to his troops after
the victory at Austerlitz, 1805





L'Arc de Triomphe

Situé à l'extrémité ouest des Champs-Élysées, le célèbre Arc de Triomphe se tient au centre de la place Charles-de-Gaulle, également appelée « place de l'Étoile ».

Il fut construit entre 1806 et 1836 en l'honneur de ceux qui avaient combattu pour la France et il est considéré comme le pilier de l'Axe historique, une suite de monuments et de grandes avenues qui s'étend de la cour du Louvre jusqu'en banlieue de Paris.



Hier et aujourd'hui

Commandé par Napoléon 1^{er} pour commémorer ses conquêtes militaires, l'Arc de Triomphe était la plus grande arche triomphale au monde quand il fut finalement terminé en 1836. La création de l'architecte Jean-François-Thérèse Chalgrin fait deux fois la taille de l'Arc de Constantin de la Rome antique, qui en est l'inspiration. Les travaux de l'Arc cessèrent lorsque Napoléon fut vaincu en 1814, mais reprurent en 1833 au nom du roi Louis-Philippe 1^{er}, qui le dédia à la gloire des forces armées françaises.

Considéré comme un emblème du patriotisme français, l'Arc de Triomphe comporte les noms gravés de victoires de guerre et de 558 généraux (les noms de ceux qui sont morts à la guerre sont soulignés). Un Soldat inconnu est enterré sous l'Arc et une flamme éternelle du souvenir, allumée depuis 1920, commémore les victimes des guerres mondiales.

Chacun des piliers de l'Arc est décoré de l'une des quatre sculptures en bas-relief : Le Départ des volontaires en 1792 (appelé également La Marseillaise), Le Triomphe de Napoléon de 1810, La Résistance de 1814 et La Paix de 1815. Le design simple et la taille immense de l'Arc de Triomphe sont caractéristiques du néo-classicisme romantique de la fin du 18^e siècle.

La plateforme d'observation en haut de l'Arc offre toujours certaines des meilleures vues de Paris. Au sommet des 284 marches, il est possible de voir une grande partie de la ville et des panoramas spectaculaires de La Défense, des Champs-Élysées et du Sacré-Cœur. Lors des fêtes nationales telles que le jour de l'Armistice et le 14 juillet, l'Arc de Triomphe décoré figure toujours au début ou à la fin du défilé ou de la célébration.



Les architectes et l'histoire de la création



En mars 1806, l'architecte Jean-François-Thérèse Chalgrin (1739-1811) fut chargé de trouver le meilleur endroit possible pour une « arche triomphale » à Paris. Il étudia différentes options et le 9 mai, Napoléon donna son accord pour le site : la place de l'Étoile.

Chalgrin fut ensuite chargé de concevoir et de construire l'Arc et le 15 août 1806, la première pierre fut posée pour coïncider avec l'anniversaire de Napoléon. Chalgrin put voir ses dessins prendre vie quand une réplique de l'Arc en toile peinte et en bois fut réalisée exactement comme il devait être construit. Cela permit à l'architecte de faire quelques

changements de dernière minute après avoir vu à quoi sa création allait ressembler.

Après la mort regrettable de Chalgrin en 1811, le travail fut repris par Louis-Robert Goust (1762-1838), qui avait été l'élève de Chalgrin. La construction de l'Arc fut perturbée et finalement arrêtée en avril 1814 par la défaite de Napoléon et les décennies successives de crise politique. En 1832, l'architecte Guillaume-Abel Blouet (1795-1853) reprit le projet et l'Arc fut finalement terminé en 1836. Blouet est l'architecte dont le nom figure sur le monument.

Alors que la version néo-classique de l'architecture romaine antique était l'œuvre de Chalgrin, les principales sculptures, traitées comme des trophées indépendants appliqués au vaste édifice de maçonnerie, furent créées par les artistes français les plus célèbres de l'époque, tels que Jean-Pierre Cordot, François Rude, Antoine Étex, James Pradier et Philippe Lemaire.





Informations :

Lieu : Paris, France

Période de construction : 1806 à 1836

Style architectural : Néo-classique du 19^e siècle

Dimensions : 49,5 m de haut,
45 m de large et
22 m de profondeur

Matériau de construction : Calcaire blanc





« Vous ne rentrerez dans vos foyers que sous des arcs de triomphe »

Napoléon à ses troupes après la victoire d'Austerlitz, en 1805





Arco del Triunfo

Ubicado en el extremo occidental de los Campos Elíseos, el emblemático Arco del Triunfo se sitúa en el centro de la plaza Charles de Gaulle, también conocida como «Plaza de la Estrella».

Se construyó entre 1806 y 1836 para honrar a aquellos que lucharon por Francia, y está considerado el elemento principal del eje histórico parisino (*l'Axe historique*): una sucesión de monumentos y grandiosas avenidas a lo largo de un recorrido que se extiende desde el patio del Palacio del Louvre hasta las afueras de París.



Entonces y ahora

Encargado por Napoleón I para conmemorar sus conquistas militares, el Arco del Triunfo era el arco triunfal más grande del mundo cuando finalmente se completó en 1836. La creación del arquitecto Jean François Thérèse Chalgrin dobla en tamaño al Arco de Constantino de la Antigua Roma, en el cual se inspira. A pesar de que los trabajos se detuvieron tras la derrota de Napoleón en 1814, fueron reanudados en 1833 en nombre del rey Luis Felipe I, quien dedicó el monumento a la gloria de las fuerzas armadas francesas.

Considerado un símbolo del patriotismo francés, el Arco del Triunfo tiene grabados los nombres de diferentes victorias bélicas y 558 generales (subrayando los que murieron en acto de servicio). Bajo el arco se encuentra la Tumba al Soldado Desconocido, mientras que la llama eterna, encendida desde 1920, recuerda a las víctimas de las guerras mundiales.

Cada uno de los cuatro pilares del arco está adornado con un gran relieve escultórico: la partida de los voluntarios de 1792 (también conocida como «La Marsellesa»), el triunfo de Napoleón de 1810, la resistencia de 1814 y la paz de 1815. El sencillo diseño y el colosal tamaño del Arco del Triunfo son típicos del neoclasicismo romántico de finales del XVIII.

El mirador situado en su parte superior continúa ofreciendo hoy una de las mejores vistas de París. En lo más alto de sus 284 escalones se pueden apreciar buena parte de la ciudad y unas espectaculares vistas panorámicas de *La Défense*, los Campos Elíseos y el Sagrado Corazón. En fiestas nacionales como el Día del Armisticio o el Día de la Bastilla, el Arco del Triunfo se decora y sirve siempre de inicio o final del desfile o celebración.



Los arquitectos y la historia del diseño



En marzo de 1806, el arquitecto Jean François Thérèse Chalgrin (1739-1811) recibió el encargo de encontrar la mejor ubicación posible para un «arco triunfal» en París. Después de considerar varias opciones, Napoleón dio su beneplácito al emplazamiento el 9 de mayo: la conocida como «Plaza de la Estrella».

Chalgrin recibió entonces el encargo de diseñar y construir el propio arco; el 15 de agosto de 1806, coincidiendo con el cumpleaños de Napoleón, se puso la primera piedra. Gracias a una réplica del arco en madera y lienzo pintado construida exactamente tal y como sería la obra final, Chalgrin pudo ver cómo sus planos cobraban vida. De este modo, después de

ver cómo quedaría, el arquitecto pudo llevar a cabo algunos cambios de última hora.

Tras la desgraciada muerte de Chalgrin en 1811, la obra fue retomada por Louis-Robert Goust (1762-1838), que había sido alumno de Chalgrin. La construcción del arco se interrumpió y se detuvo finalmente en abril de 1814 como resultado de la derrota de Napoleón y las posteriores décadas de convulsión política. En 1832, el arquitecto Guillaume-Abel Blouet (1795-1853) se hizo cargo del proyecto, y el arco fue finalmente completado en 1836. Blouet es el arquitecto al que realmente se acredita el monumento.

Aunque la versión neoclásica de la obra de la Antigua Roma era diseño de Chalgrin, las esculturas principales, tratadas como trofeos independientes aplicados sobre el enorme edificio de ladrillo, fueron creadas por algunos de los artistas franceses de más renombre del momento, como Jean-Pierre Cordot, François Rude, Antoine Étex, James Pradier y Philippe Lemaire.





Datos

- Situación: París (Francia)
- Período de construcción: 1806 a 1836
- Estilo arquitectónico: Neoclásico del siglo XIX
- Dimensiones: 49,5 m de altura,
45 m de anchura y
22 m de profundidad
- Materiales de construcción: Piedra caliza blanca





*«Volverán a casa bajo arcos
triumfales»*

Napoleón a sus tropas después de
la victoria de Austerlitz, 1805



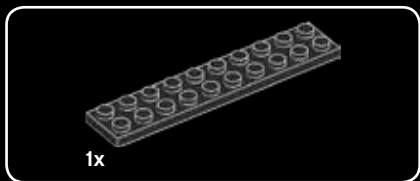

1

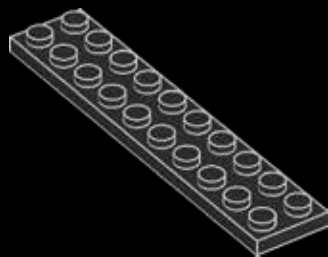

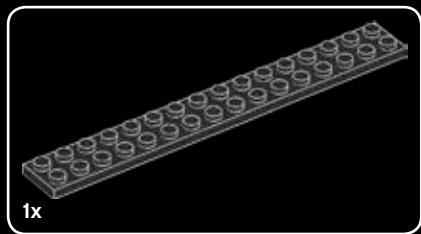

2

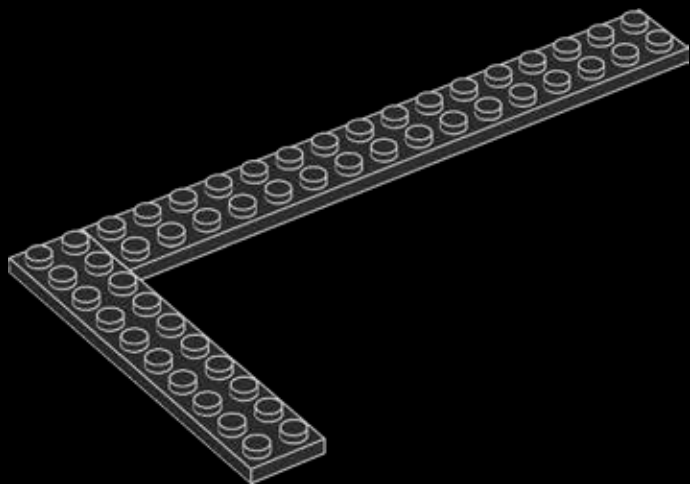

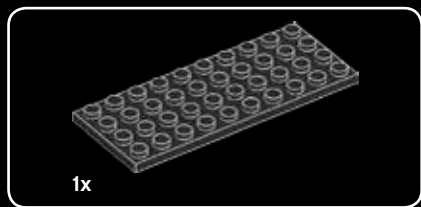

3

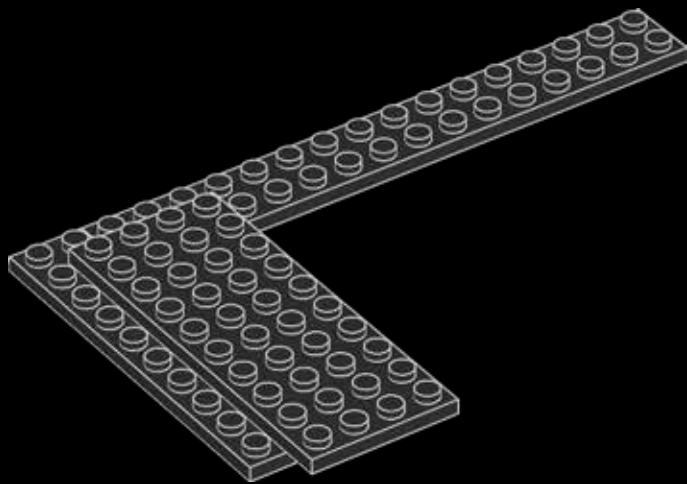

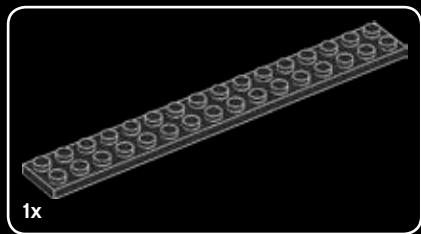

4

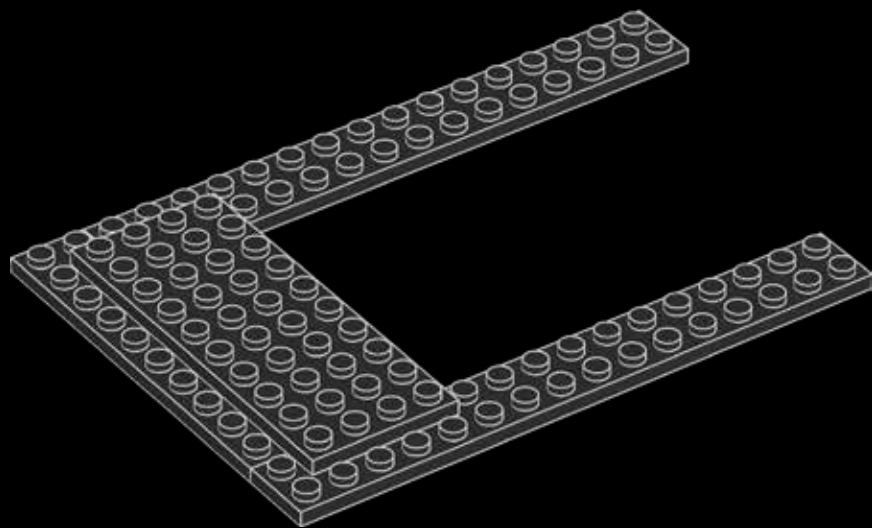

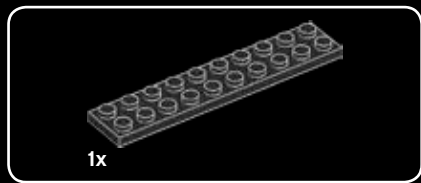

5

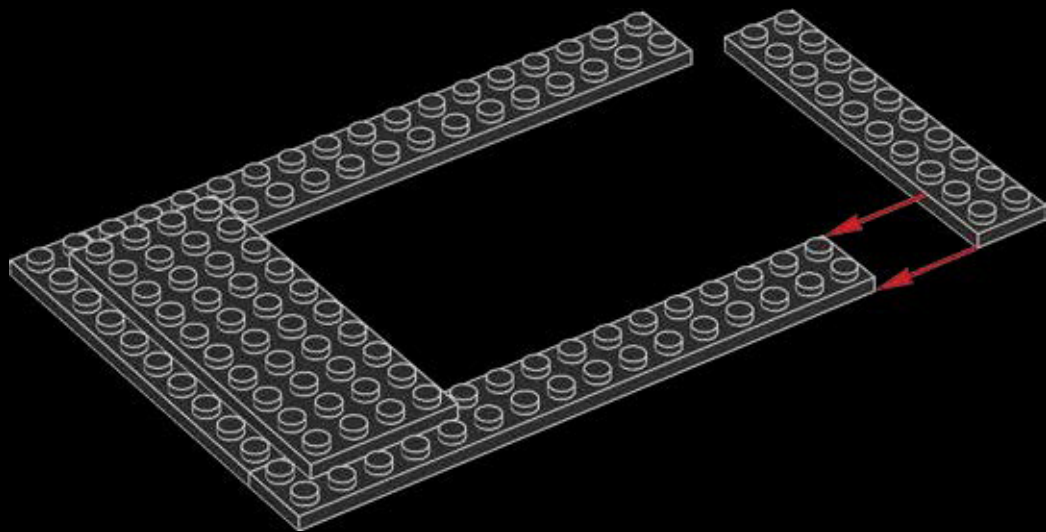

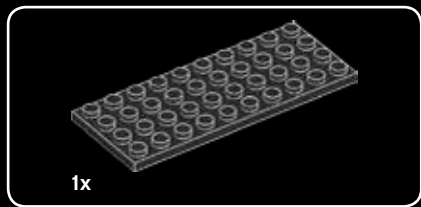

6

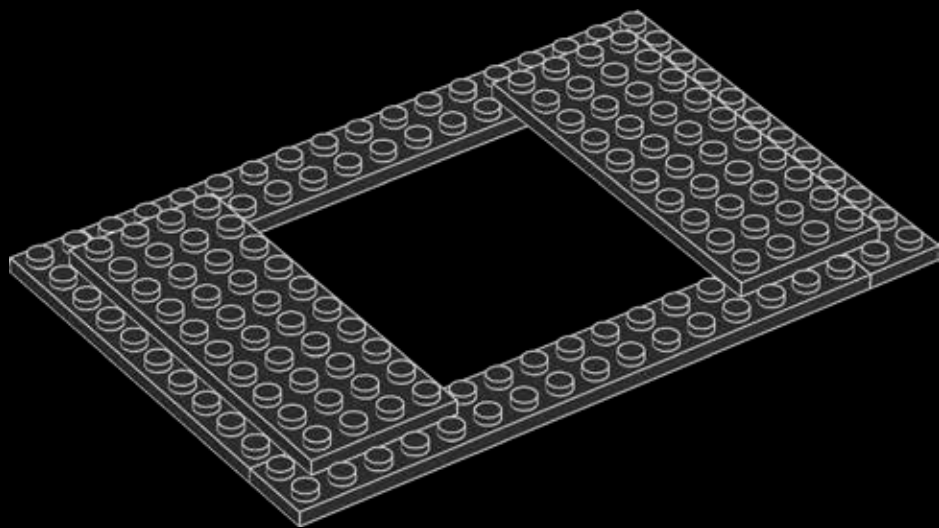

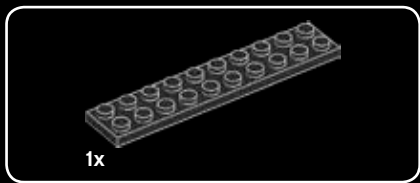

7

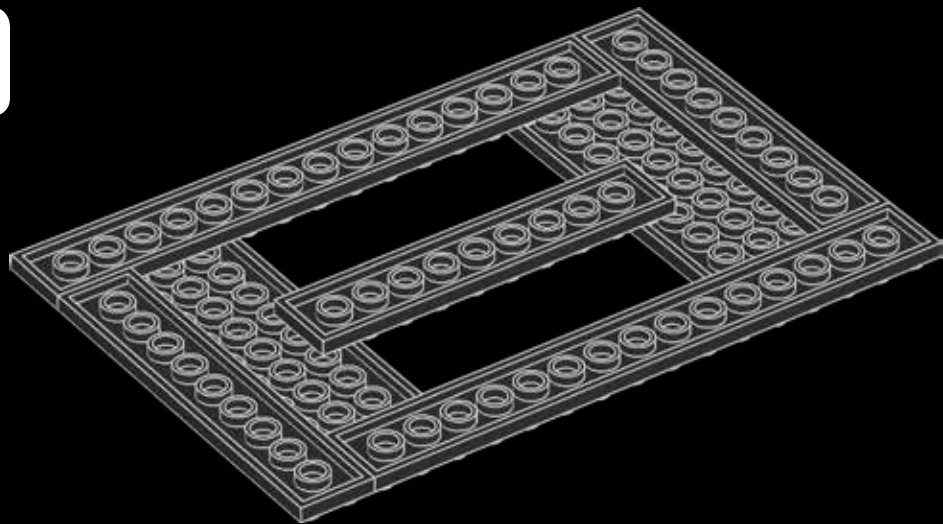

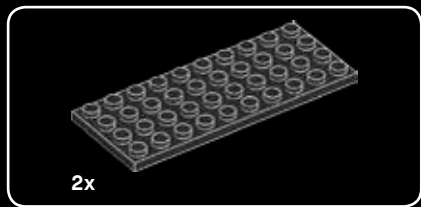

8

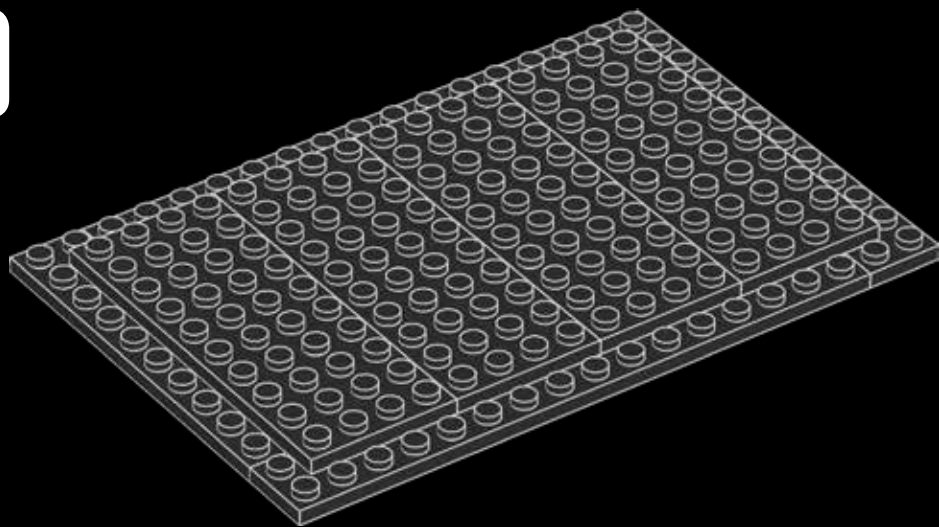

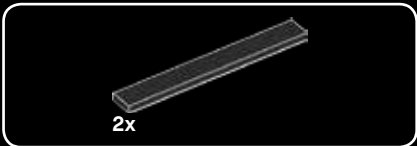

9

Pedestrian tunnels under the heavily trafficked intersection offer visitors safe access to the monument.

Les tunnels piétonniers qui passent sous l'intersection au trafic intense offrent aux visiteurs un accès sûr au monument.

Los túneles peatonales que discurren bajo el concurrido tráfico de la intersección donde se sitúa permiten el acceso seguro de los visitantes.

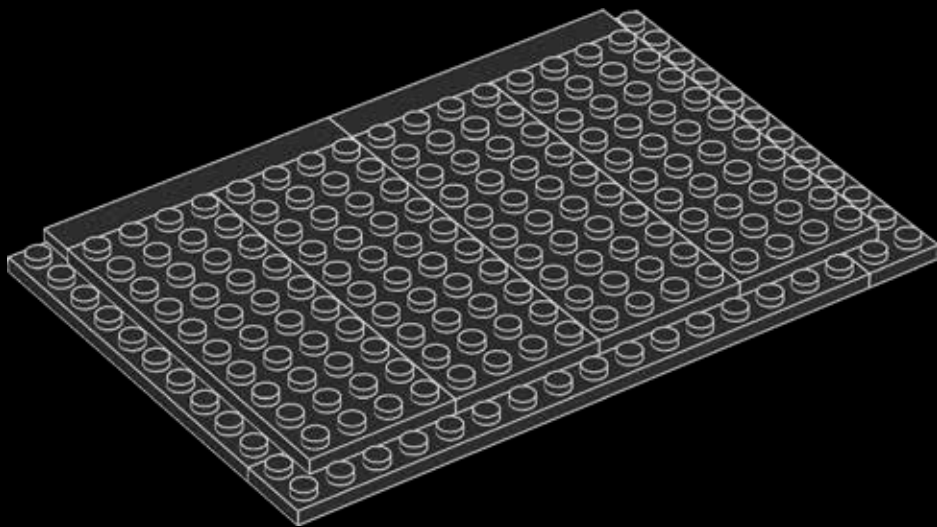

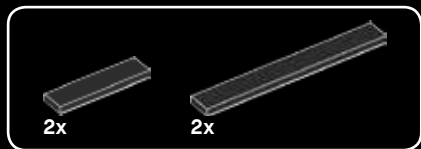

10

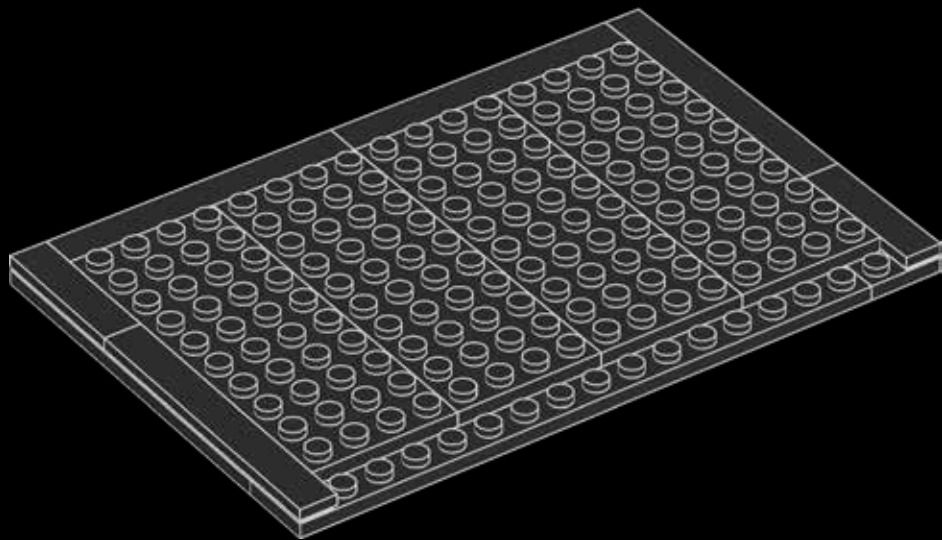

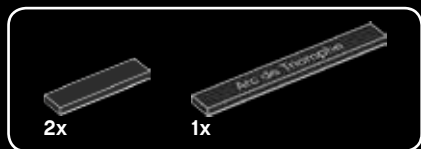

11

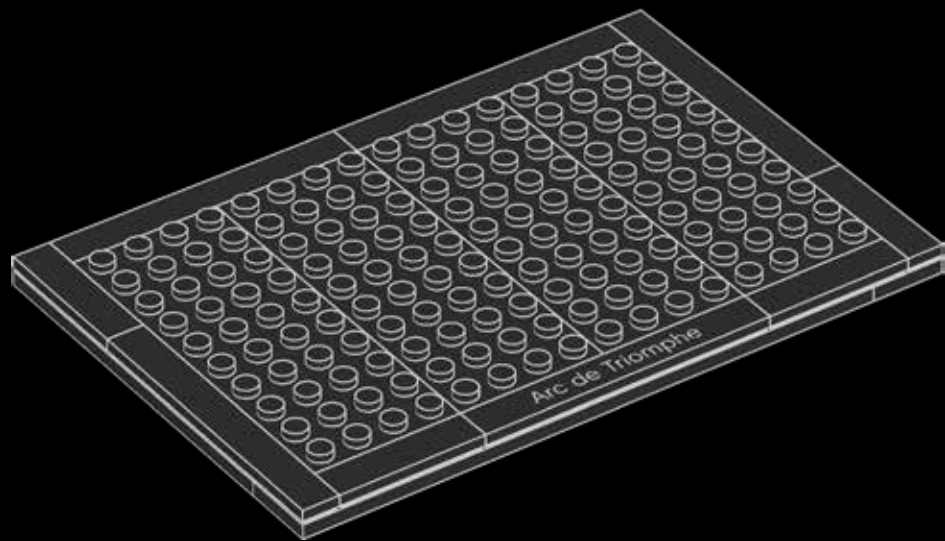



8x

12

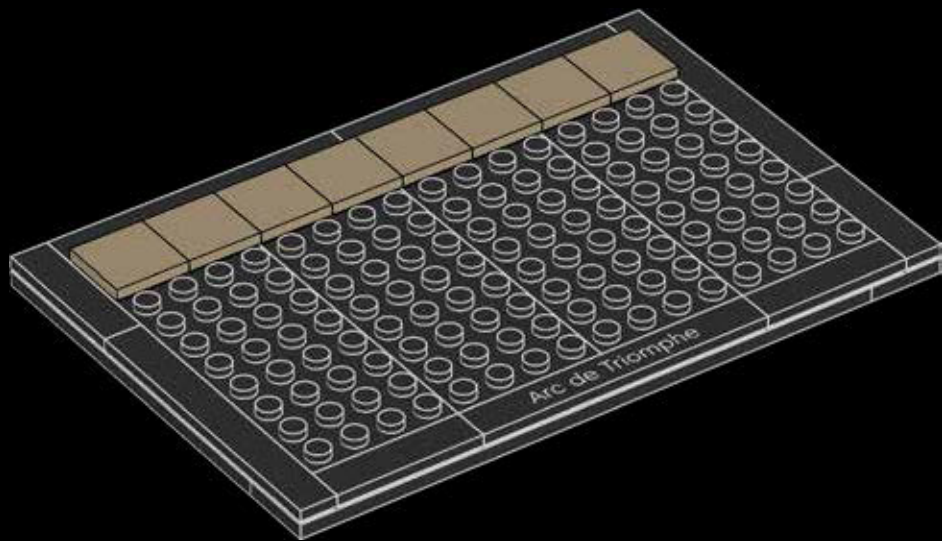



4x



2x



4x

13

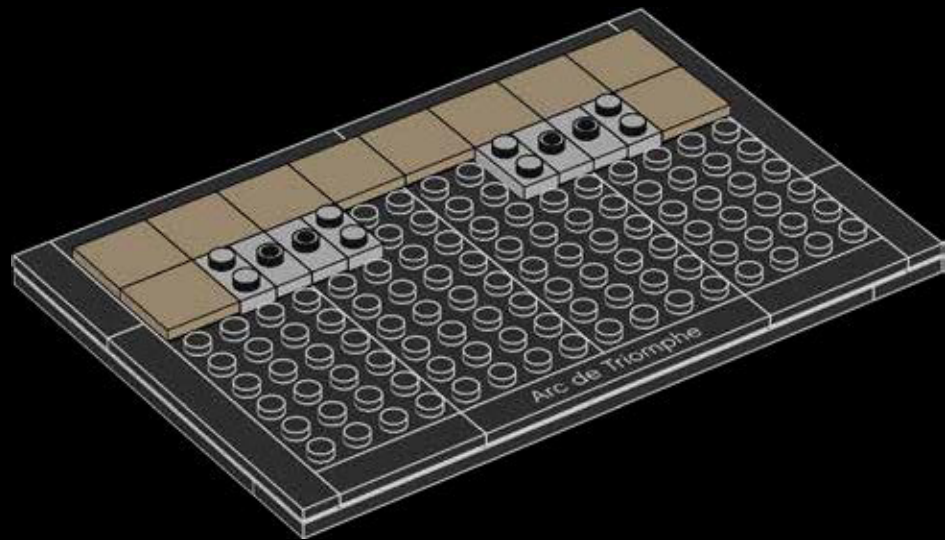



1x



2x



2x

14

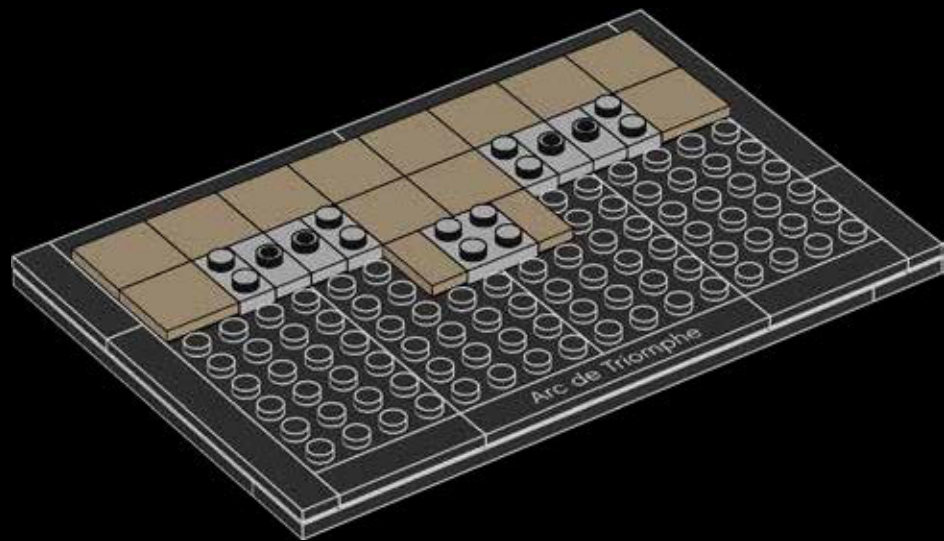



6x

15

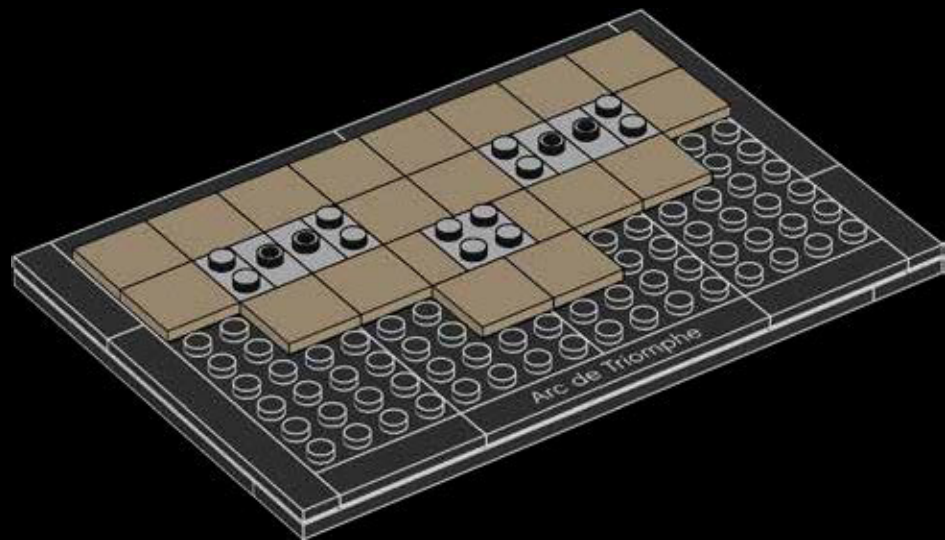



4x



4x

16

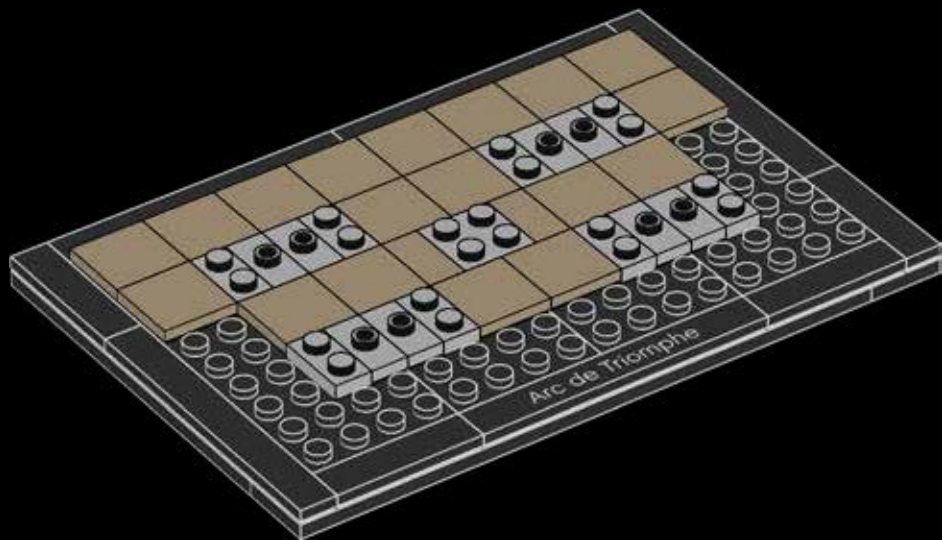



12x

17

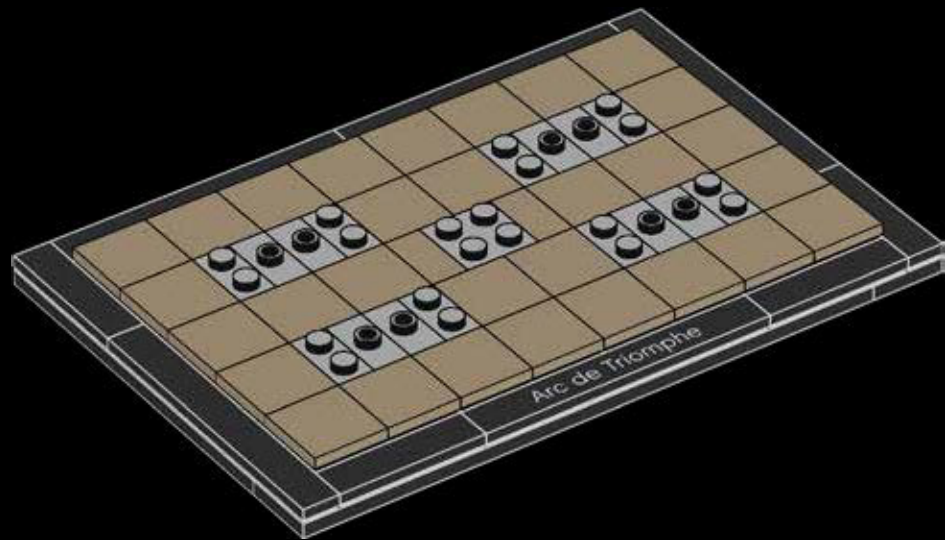



18

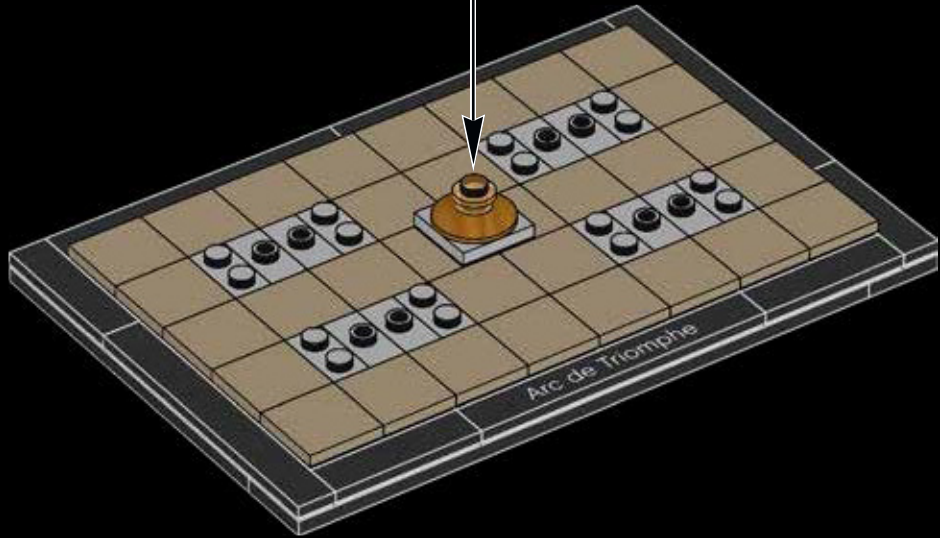
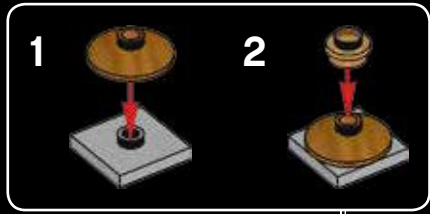



8x



8x



8x

19

1

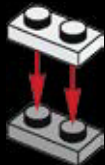

2



8x

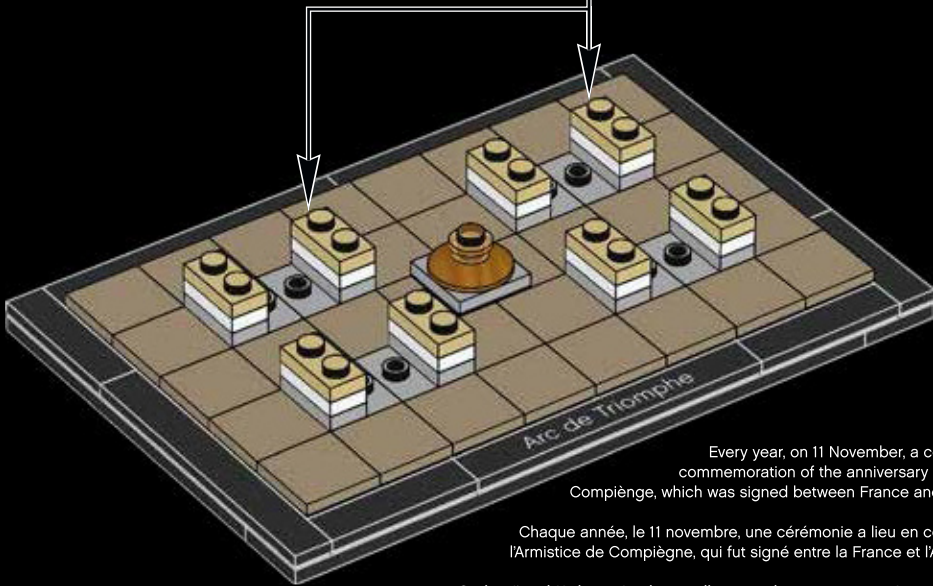

Every year, on 11 November, a ceremony is held in commemoration of the anniversary of the Armistice of Compiègne, which was signed between France and Germany in 1918.

Chaque année, le 11 novembre, une cérémonie a lieu en commémoration de l'Armistice de Compiègne, qui fut signé entre la France et l'Allemagne en 1918.

Cada año, el 11 de noviembre, se lleva a cabo una ceremonia para conmemorar el aniversario del Armisticio de Compiègne, firmado entre Francia y Alemania en 1918.





4x



4x



4x



4x



4x



8x



4x



4x



4x



4x



4x

20

1



2



3

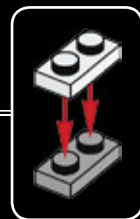

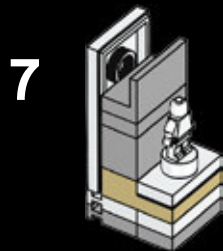
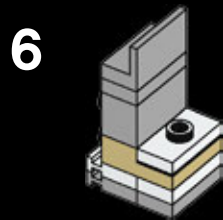
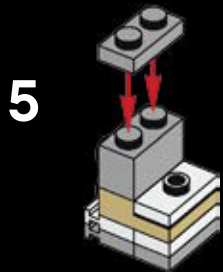
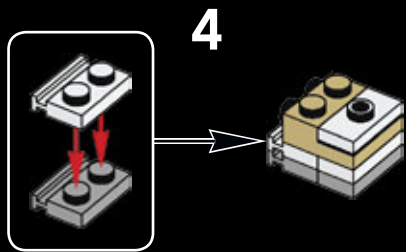

4x

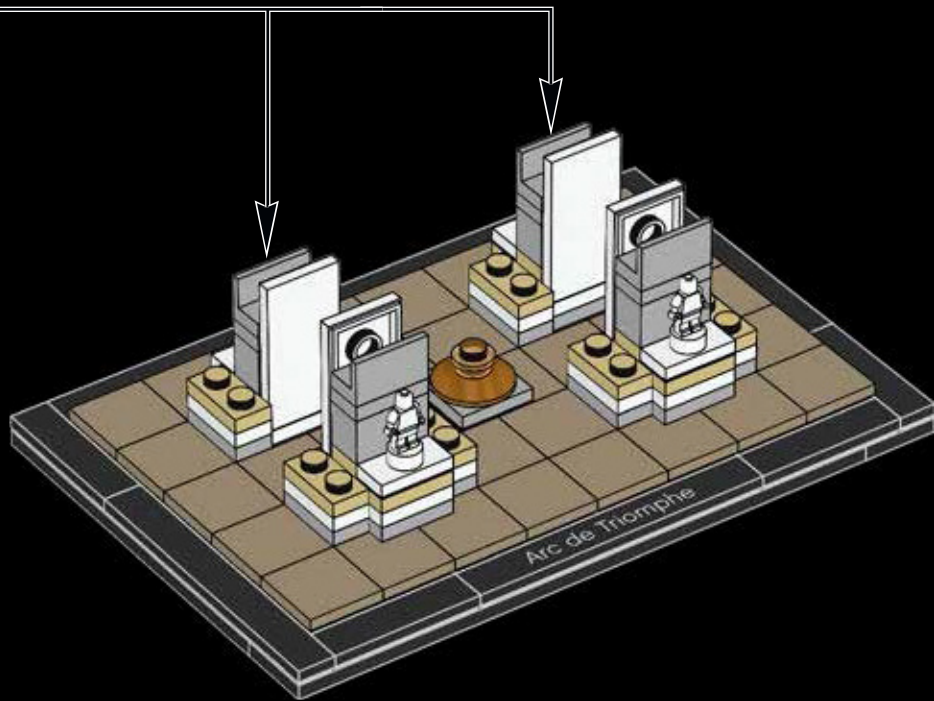



8x

21

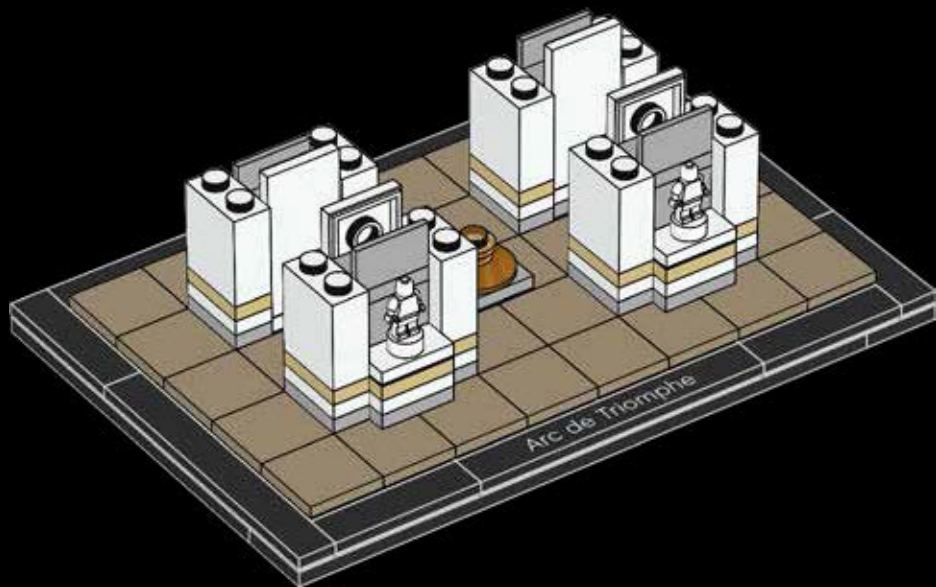



8x

22



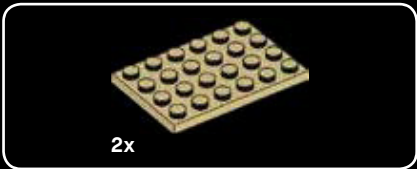

23

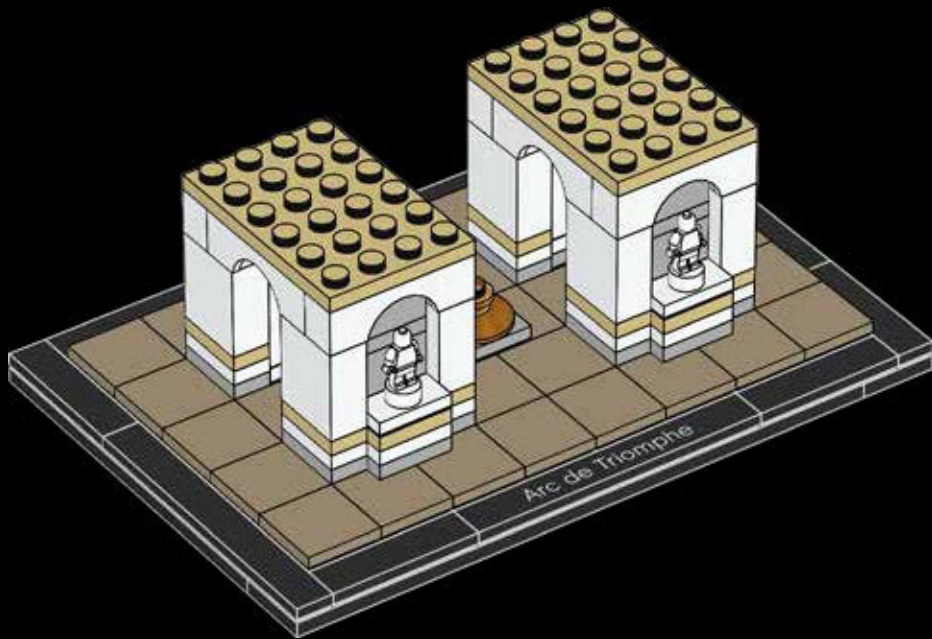

Over 600,000 people visit the Arc de Triomphe every year.

Plus de 600 000 personnes visitent l'Arc de Triomphe chaque année.

Cada año, 600.000 personas visitan el Arco del Triunfo.





4x



2x

24

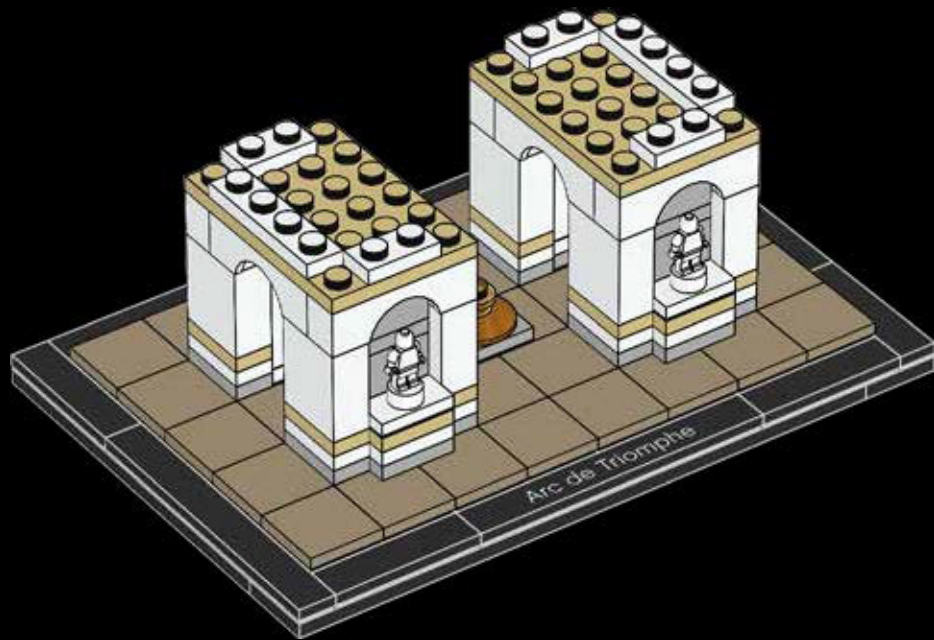



2x



4x

25

The Arc de Triomphe cost 9.3 million French francs to complete, a huge amount of money at that time.

La construction de l'Arc de Triomphe coûta 9,3 millions de francs français, une somme d'argent énorme à l'époque.

Completar el Arco del Triunfo costó 9,3 millones de francos franceses, una cantidad de dinero enorme en aquel tiempo.

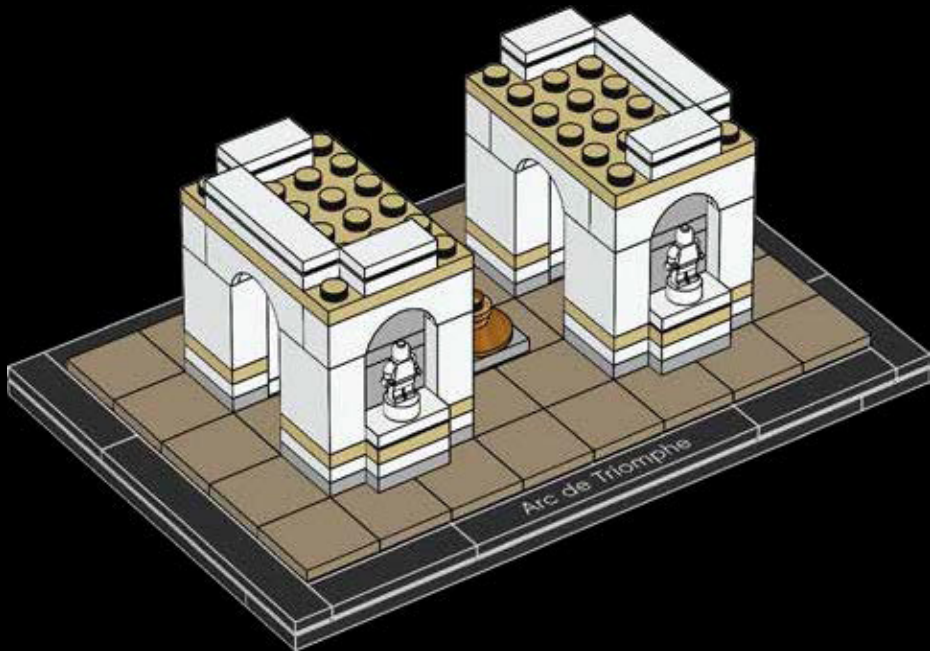



4x

26

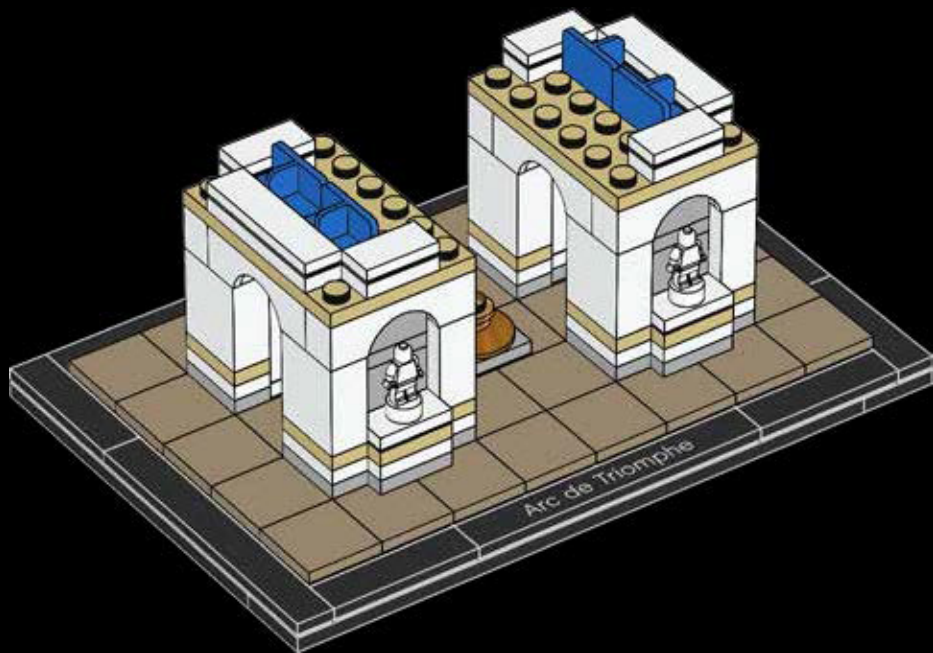



8x

27



4x

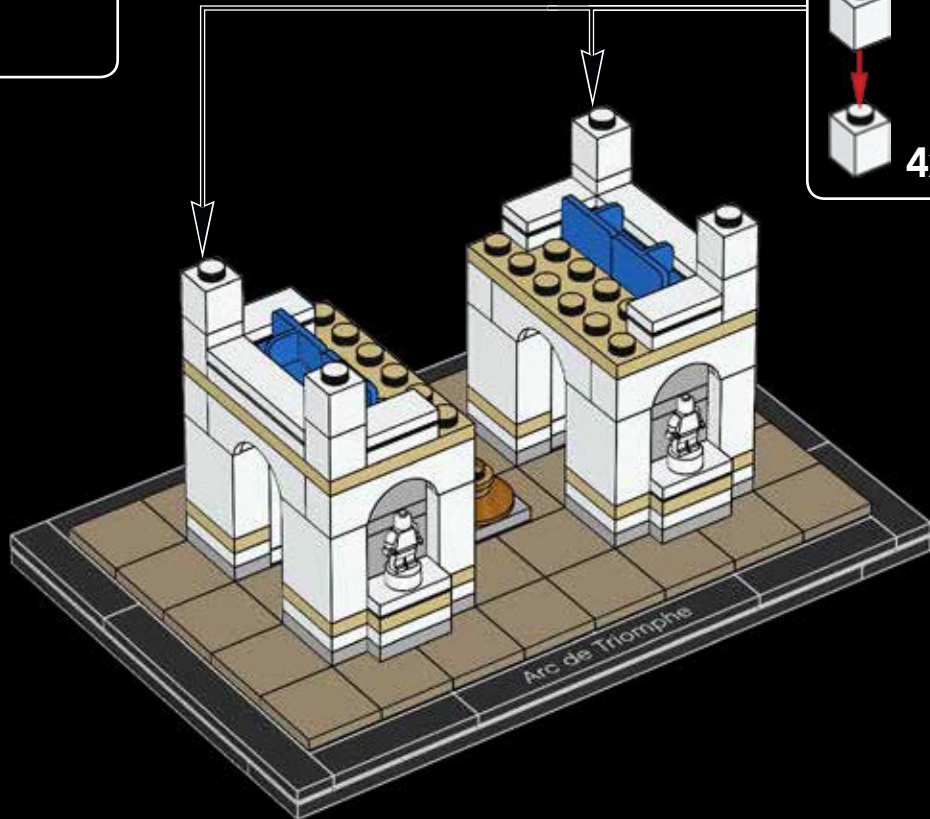



6x

28

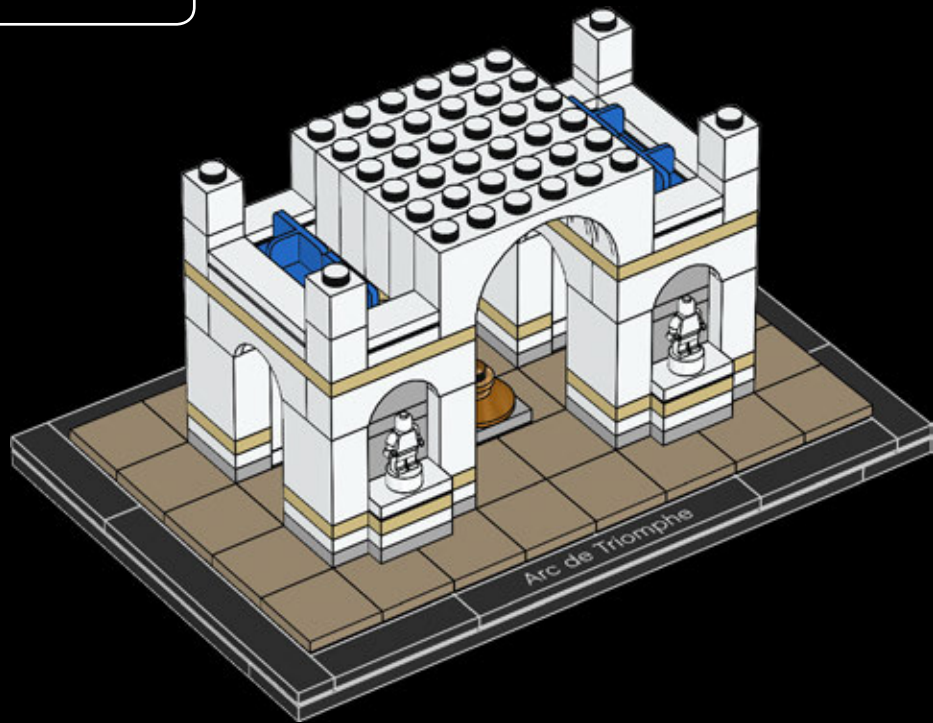



2x



4x



8x



8x



2x



2x

29

1

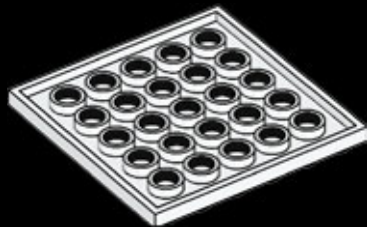

2



3

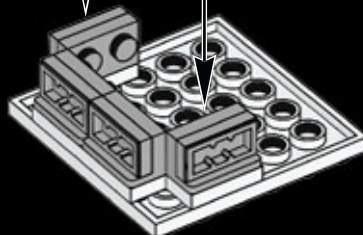
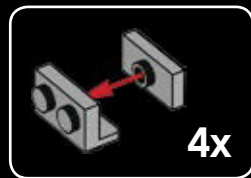

2x

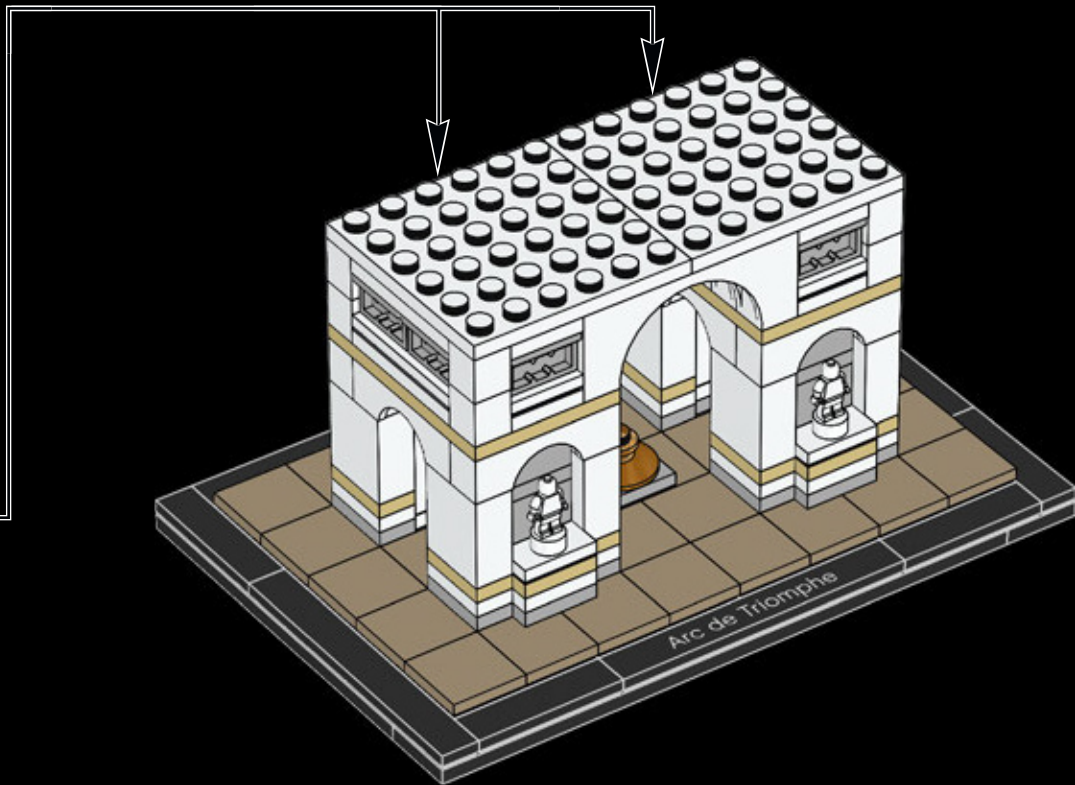

Arc de Triomphe



1x



4x

30

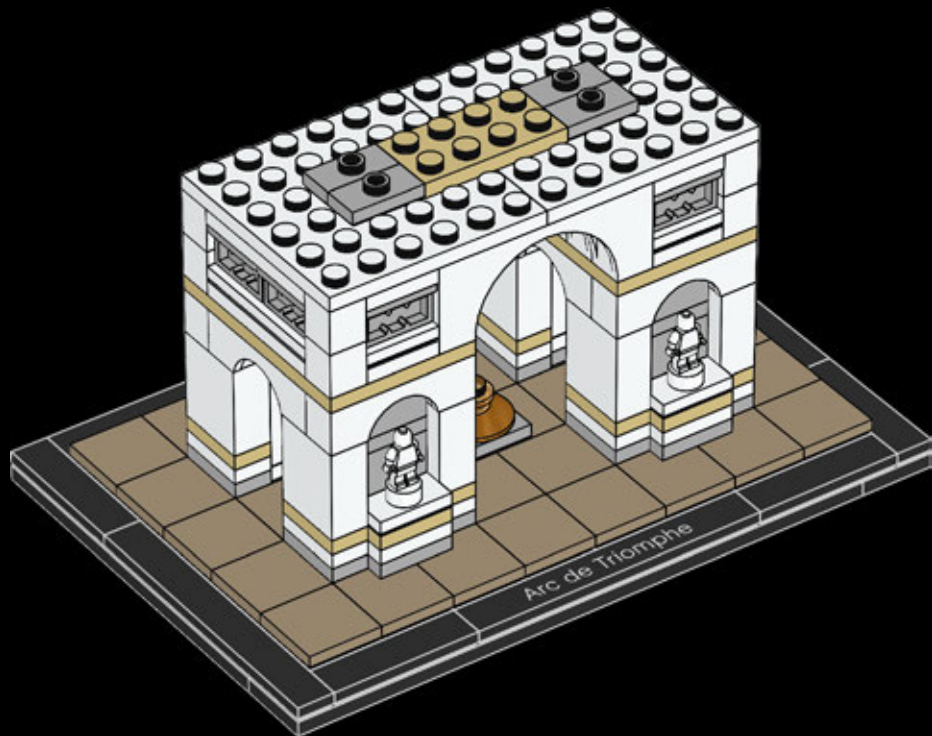



31

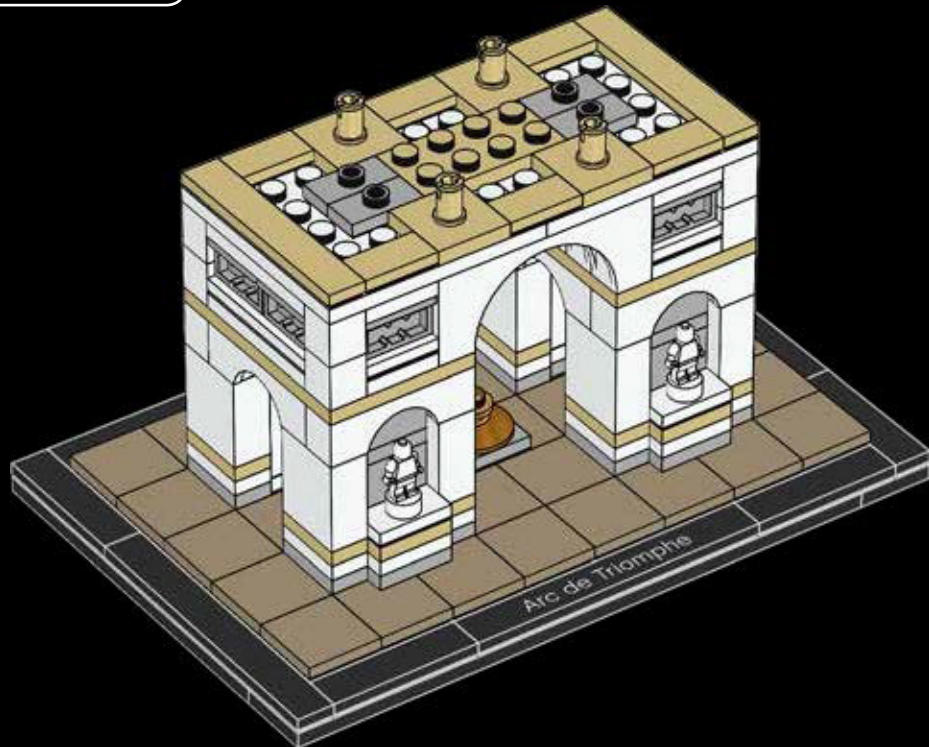



2x



4x



4x



4x



4x



2x

32

1

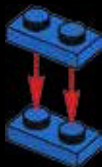

2



3





4

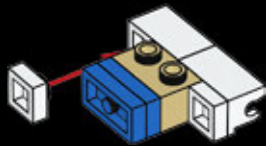

5

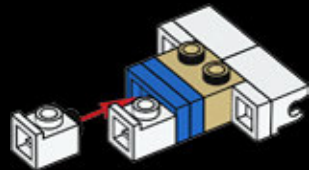

2x

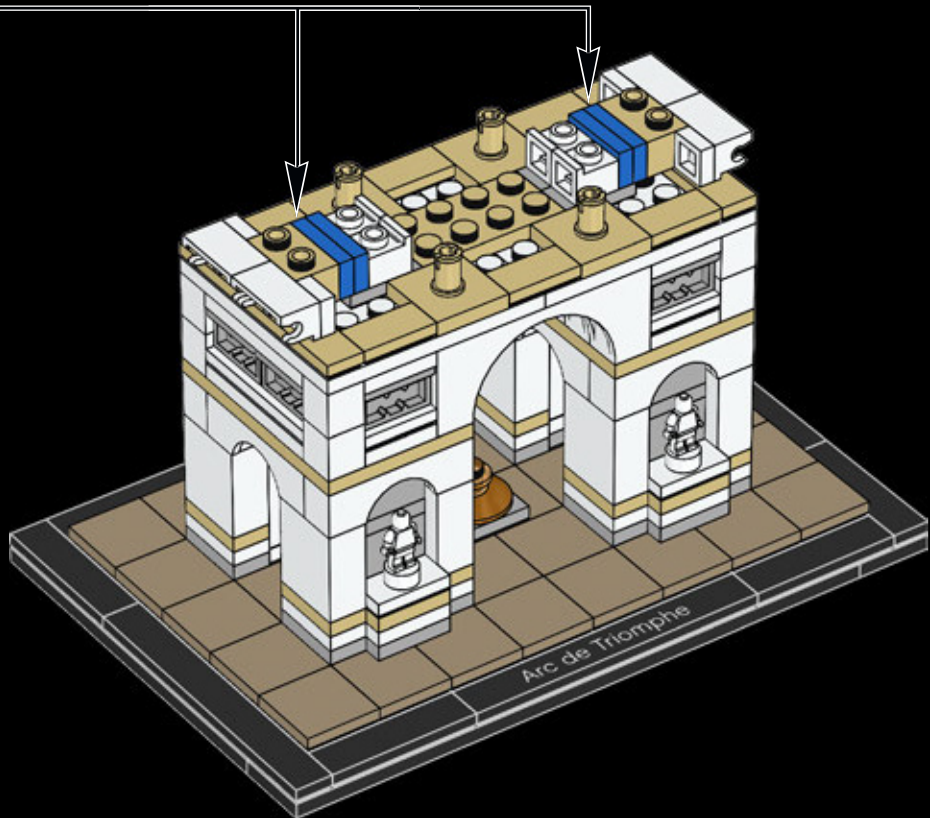

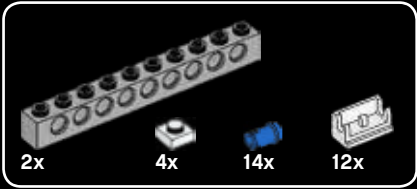

33

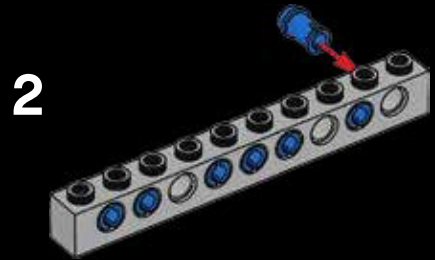
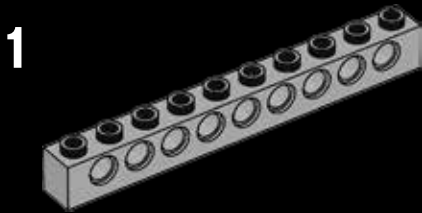

3

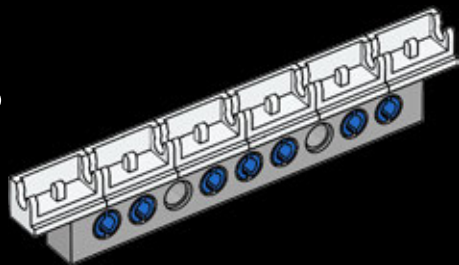

4

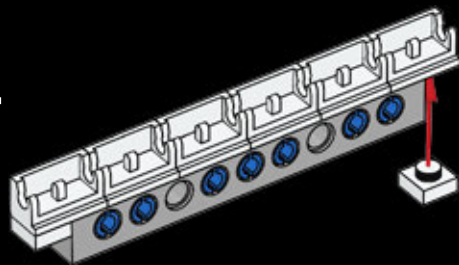

2x

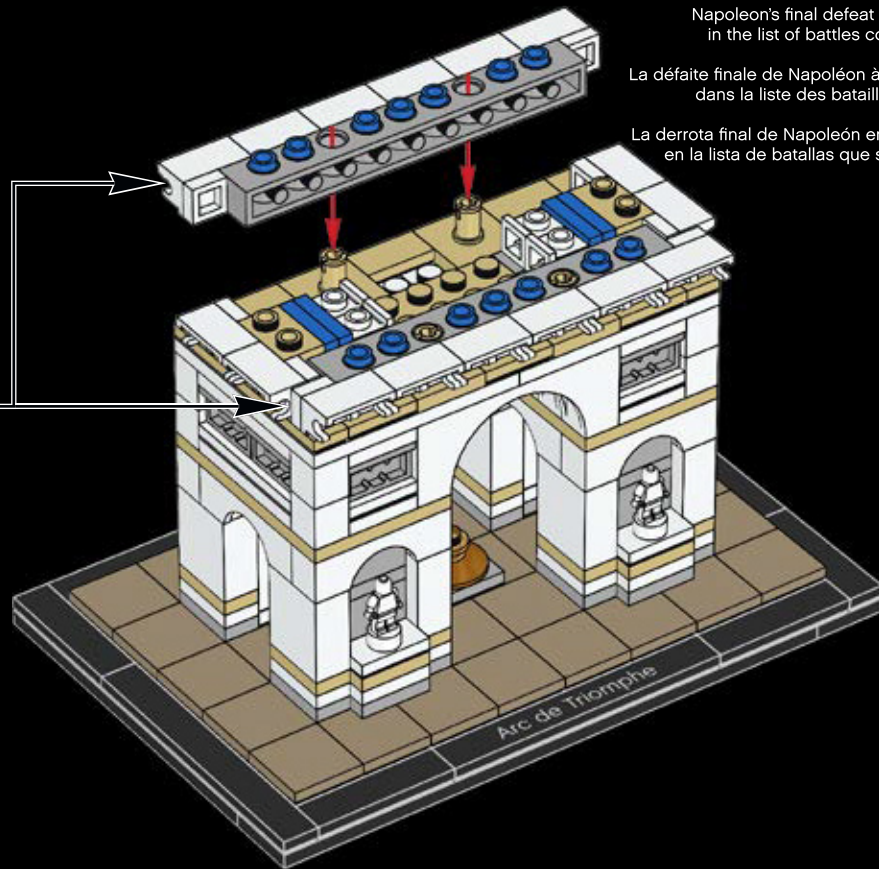

Napoleon's final defeat at Waterloo is not included in the list of battles commemorated on the Arch.

La défaite finale de Napoléon à Waterloo n'est pas incluse dans la liste des batailles commémorées sur l'Arc.

La derrota final de Napoleón en Waterloo no está incluida en la lista de batallas que se conmemoran en el arco.



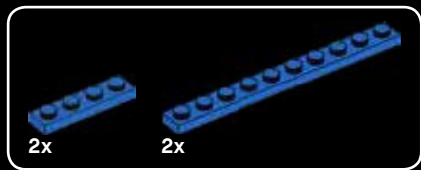

34

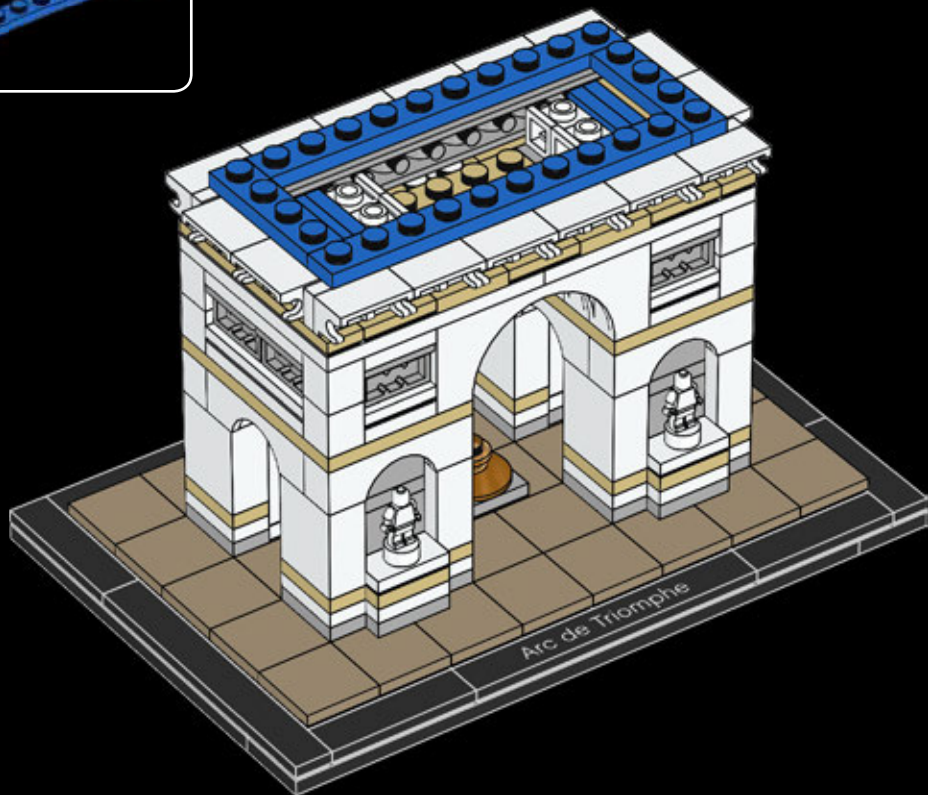

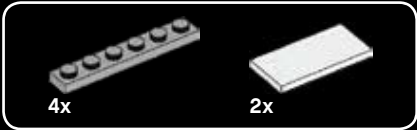

35

1

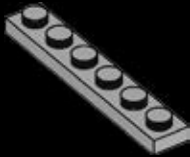

2

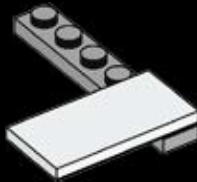

3

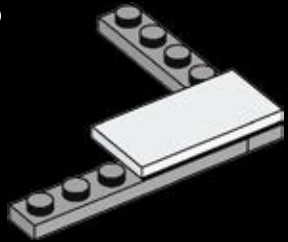

2x

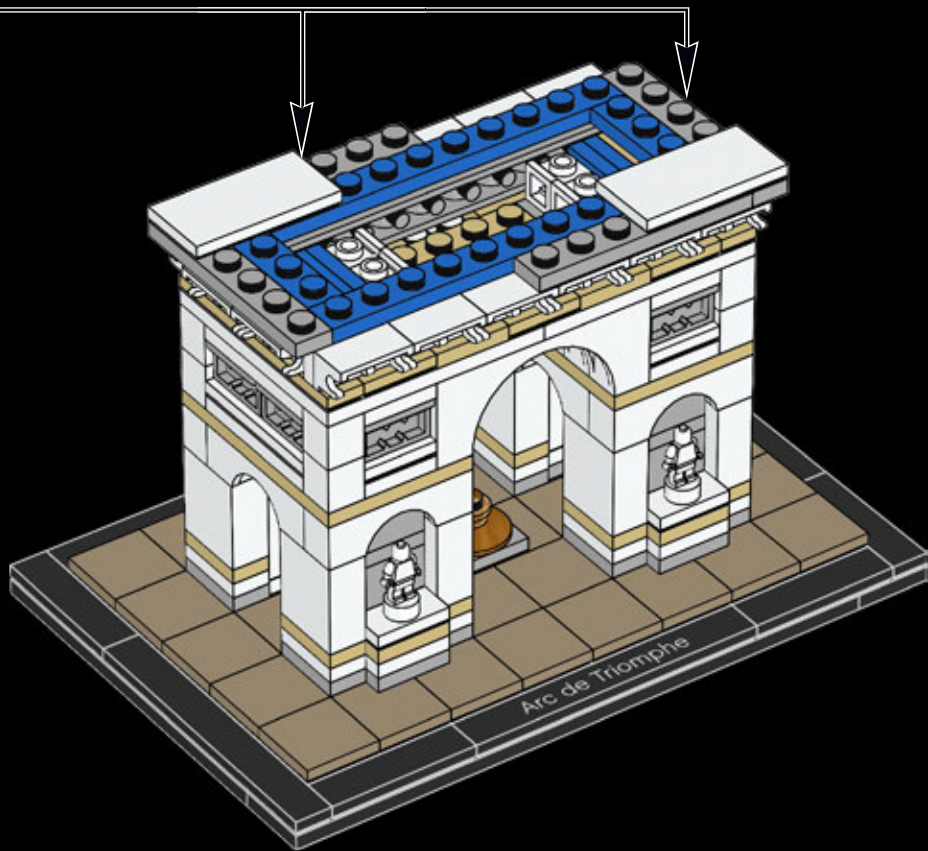

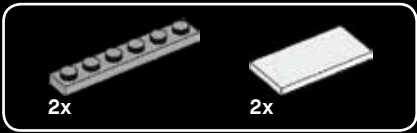

36

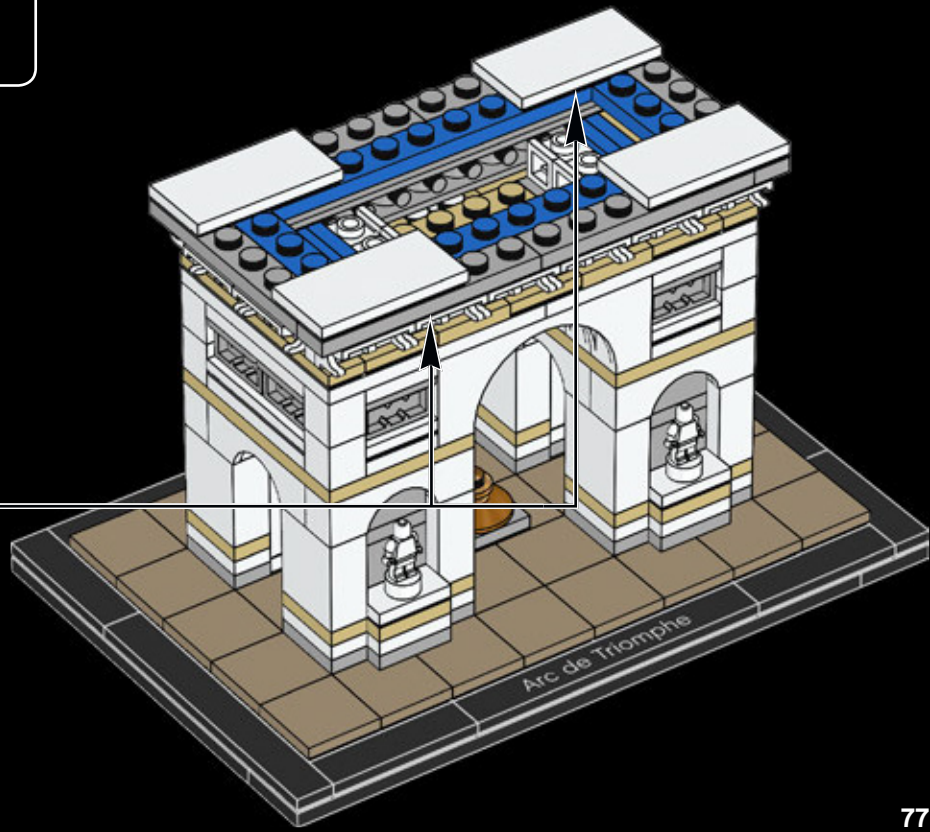
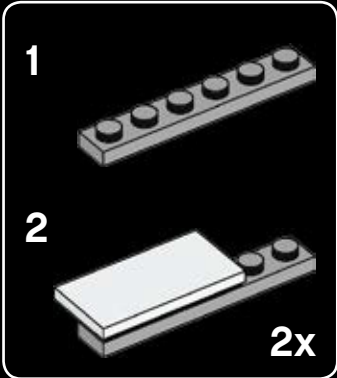



2x



4x

37



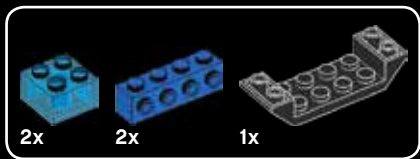

38

1

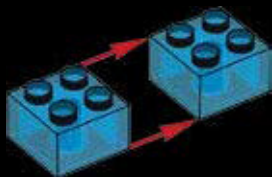

2

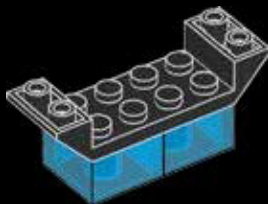

3



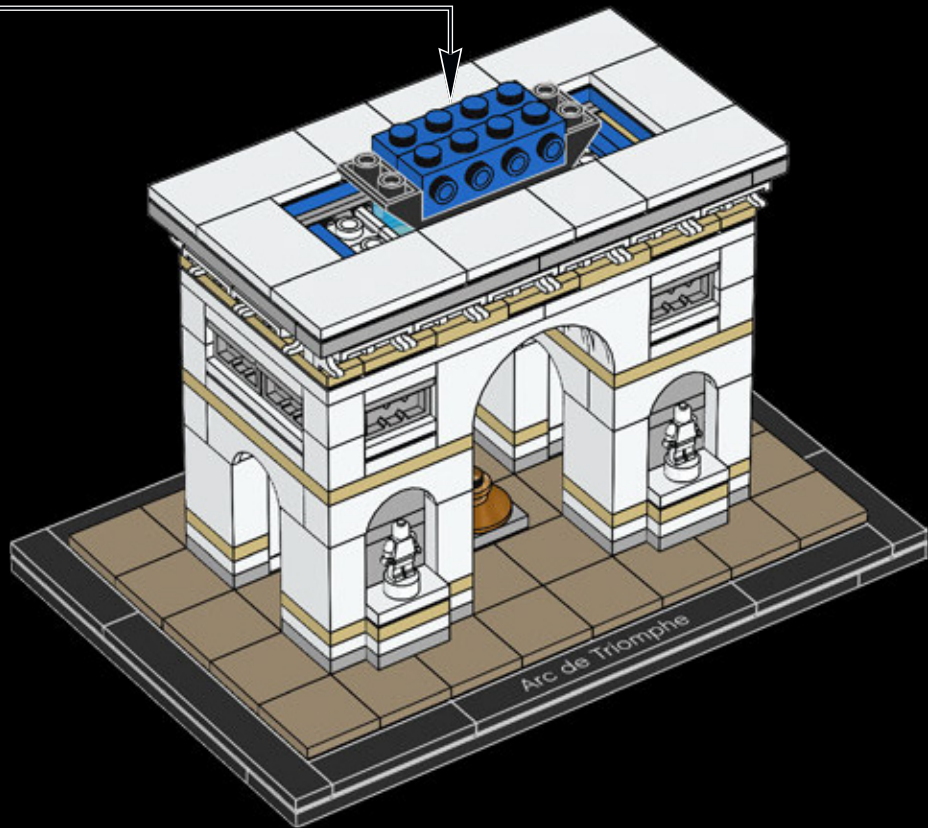



39

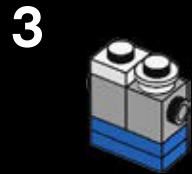
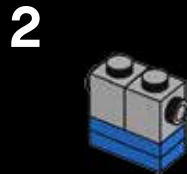
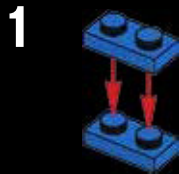

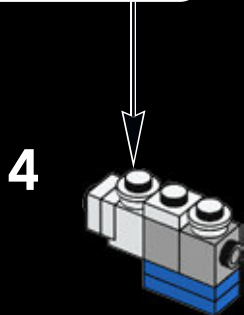
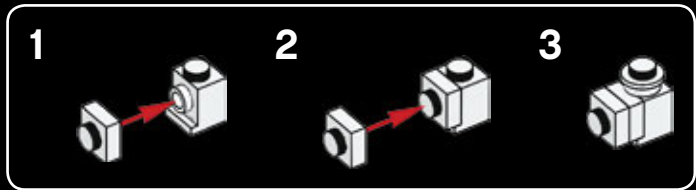

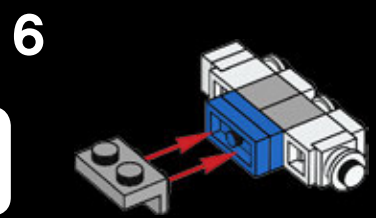
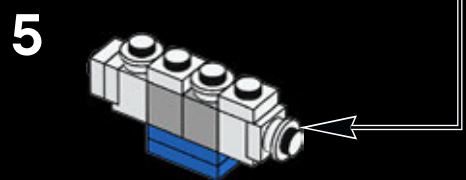
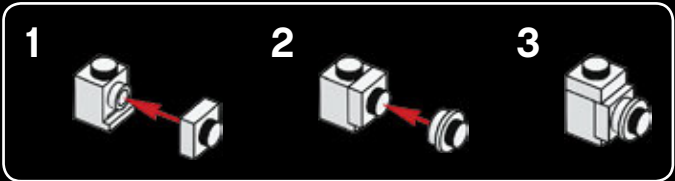

2x
83

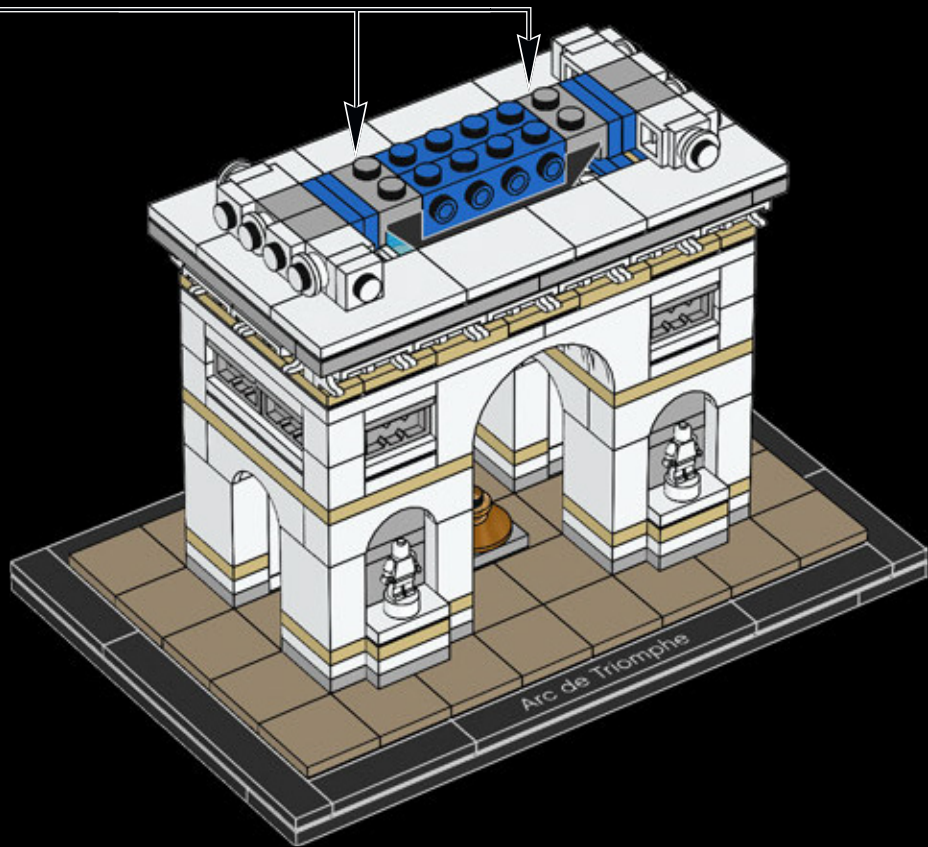

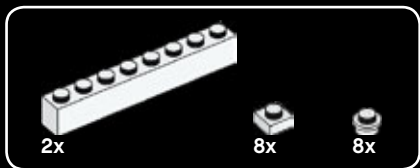

40

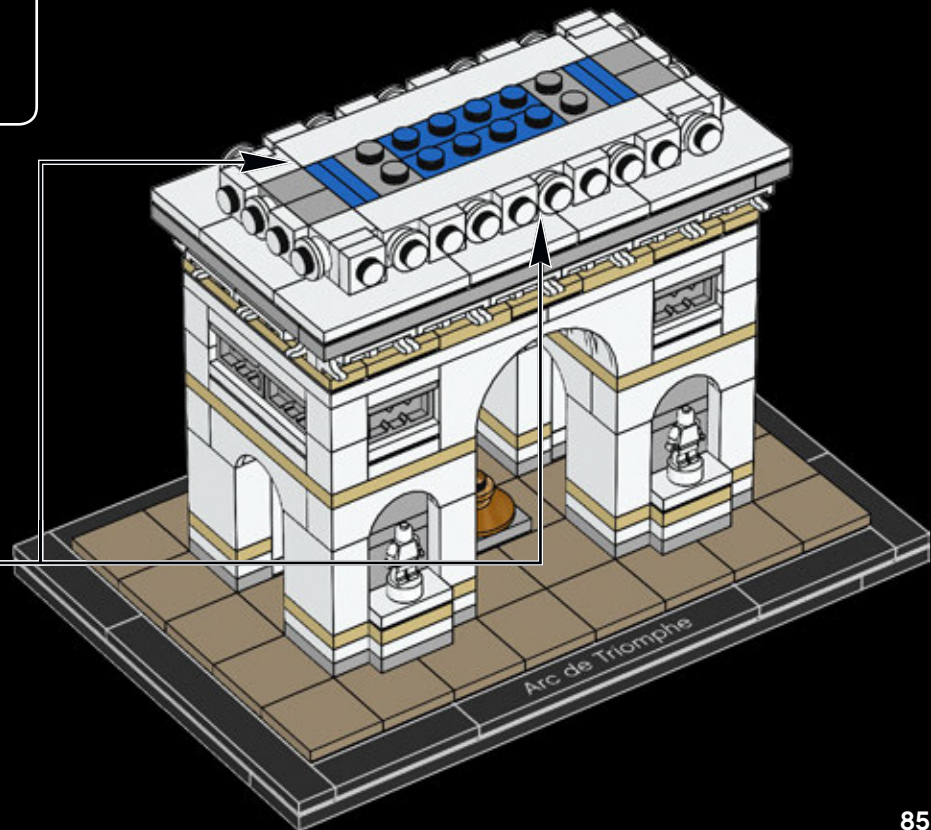
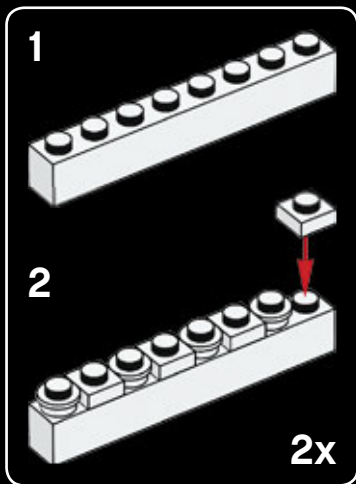

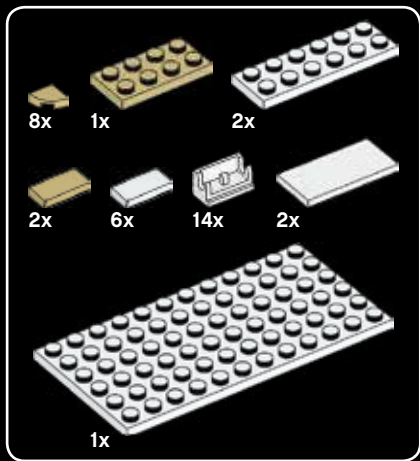
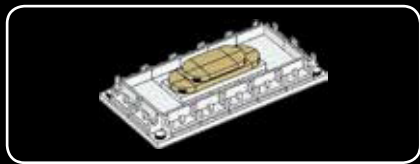

41

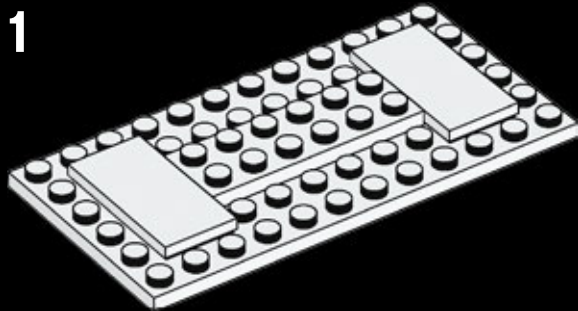

2

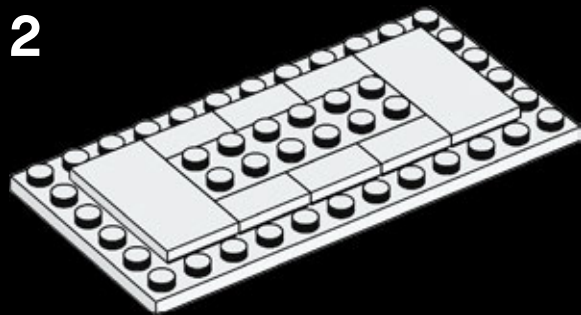

3

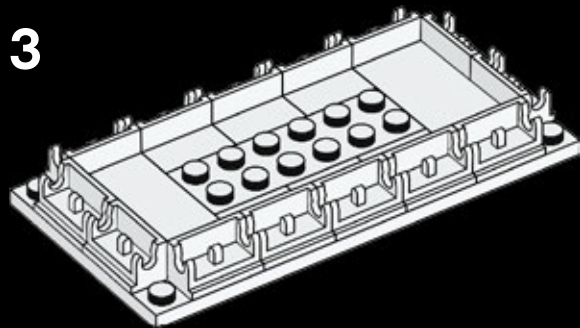

1



2



3



4

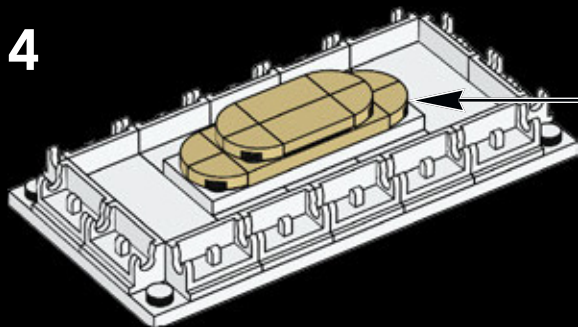

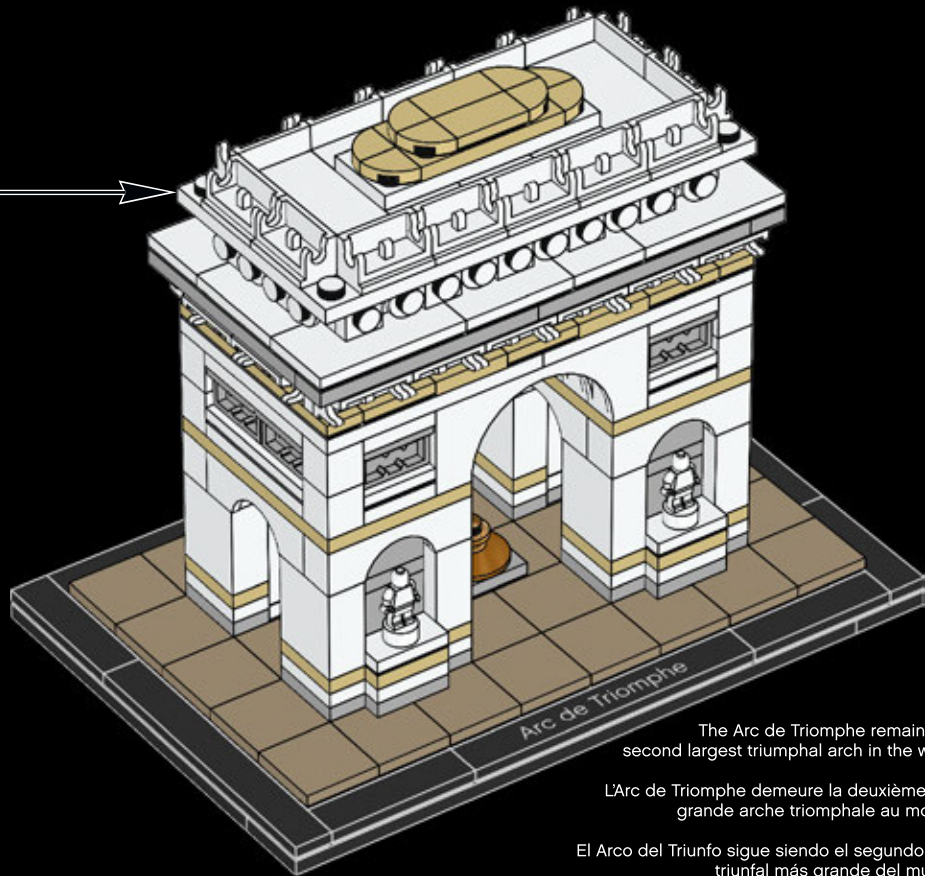

The Arc de Triomphe remains the second largest triumphal arch in the world.

L'Arc de Triomphe demeure la deuxième plus grande arche triomphale au monde.

El Arco del Triunfo sigue siendo el segundo arco triunfal más grande del mundo.



LEGO® Architecture – do you like it?

The LEGO Group would like your opinion on the new product you have just purchased. Your feedback will help shape the future development of this product series. Please visit:

[LEGO.com/productsurvey](https://www.lego.com/productsurvey)

By completing our short feedback survey, you will be automatically entered into a drawing to win a LEGO® prize.



See website for official rules and details. Open to all countries where not prohibited.

LEGO and the LEGO logo are trademarks of the/son des marques de commerce du/son marcas registradas de LEGO Group. ©2017 The LEGO Group.

Aimez-vous LEGO® Architecture ?

Le Groupe LEGO aimerait connaître votre opinion sur le produit que vous venez d'acheter. Vos commentaires nous aideront à concevoir les futurs produits de cette gamme. Rendez-vous sur :

[LEGO.com/productsurvey](https://www.lego.com/productsurvey)

En remplissant ce court sondage sur le produit, vous serez automatiquement inscrit à un tirage au sort pour gagner un prix LEGO®.



Consultez le site Web pour obtenir le règlement officiel et les détails. Ouvert à tous les résidents des pays autorisés.

LEGO and the LEGO logo are trademarks of the/son des marques de commerce du/son marcas registradas de LEGO Group. ©2017 The LEGO Group.

LEGO® Architecture: ¿te gusta?

The LEGO Group quiere conocer tu opinión acerca del nuevo producto que acabas de comprar. Tus comentarios nos ayudarán a dar forma a los futuros productos de esta serie. Visita:

[LEGO.com/productsurvey](https://www.lego.com/productsurvey)

Al rellenar esta breve encuesta de opinión, participarás automáticamente en el sorteo de un producto LEGO®.



Consulta las reglas oficiales y demás información en el sitio web. Válido en todos los países en los que esta actividad no esté prohibida.

LEGO and the LEGO logo are trademarks of the/son des marques de commerce du/son marcas registradas de LEGO Group. ©2017 The LEGO Group.

LEGO® Architecture—then and now

There has always been a natural connection between the LEGO® brick and the world of architecture. Fans who build with LEGO elements instinctively develop an interest in the form and function of the structures they create. At the same time, many architects have discovered that LEGO bricks are the perfect way of physically expressing their creative ideas.

This connection was confirmed in the early 1960s with the launch of the LEGO 'Scale Model' line. It matched the spirit of the age where modern architects were redefining how houses look and people were taking an active interest in the design of their new homes. These sets were designed to be different from the normal, brightly colored LEGO boxes; they also included a book on architecture as a source of inspiration.

Decades later, architect and LEGO fan Adam Reed Tucker, revived the idea of expressing architecture using LEGO bricks and in partnership with the LEGO Group, launched the LEGO Architecture line that we know today.

His first models, and the original sets in the current LEGO Architecture series, were interpretations of famous skyscrapers from his hometown of Chicago. Since then LEGO Architecture has developed and evolved, first with well-known buildings from other cities in the United States, and now with iconic structures from Europe, the Middle East and Asia.

The introduction of our LEGO Architecture Studio set echoes the ambitions of the earlier LEGO 'Scale Model' line and widens the potential of the LEGO Architecture series. Now you can enjoy building and learning about specific landmark buildings, or create exciting architectural models from your own fantasy. An inspiring 270-page book, featuring a number of renowned architects from around the world, guides you through the principles of architecture and encourages you in your own creative building.

LEGO® Architecture – Hier et aujourd'hui

Il y a toujours eu une connexion naturelle entre la brique LEGO® et le monde de l'architecture. Les fans qui construisent avec des éléments LEGO développent instinctivement un intérêt pour la forme et la fonction des structures qu'ils créent. De nombreux architectes ont quant à eux découvert que les briques LEGO sont la façon idéale de matérialiser leurs idées de création.

Cette connexion a été confirmée au début des années 1960 avec le lancement de la gamme « Maquettes à l'échelle » LEGO. Cette gamme correspondait à l'esprit de l'époque, alors que les architectes modernes redéfinissaient les maisons, et que les gens s'intéressaient activement à la conception de leur résidence. Ces ensembles originaux étaient conçus pour être différents des boîtes LEGO habituelles aux couleurs vives, et incluaient aussi « un livret d'architecture » comme source d'inspiration.

Quelques décennies plus tard, l'architecte et fan de LEGO Adam Reed Tucker a fait revivre l'idée d'exprimer l'architecture en utilisant des briques LEGO. En partenariat avec le Groupe LEGO, il lança la gamme LEGO Architecture que nous connaissons aujourd'hui.

Ses premiers modèles, et les ensembles originaux de la gamme LEGO Architecture actuelle, étaient des interprétations de célèbres gratte-ciel de sa ville natale de Chicago. La gamme LEGO Architecture a depuis évolué et s'est élargie, tout d'abord avec des bâtiments célèbres d'autres villes des États-Unis, puis avec de célèbres monuments d'Europe, du Moyen-Orient et d'Asie.

L'introduction de notre ensemble LEGO Architecture Studio fait écho aux ambitions de la précédente gamme « Maquettes à l'échelle » LEGO et accroît le potentiel de la gamme LEGO Architecture. Vous pouvez maintenant découvrir et construire des monuments célèbres ou créer de passionnants modèles architecturaux nés de votre imagination. Un livret d'inspiration de 270 pages, présentant plusieurs architectes célèbres du monde entier, vous guide parmi les principes de l'architecture et vous encourage dans votre propre construction créatrice.

LEGO® Architecture: entonces y ahora

Siempre ha existido una conexión natural entre el brick LEGO® y el mundo de la arquitectura. Los fans que construyen con elementos LEGO desarrollan instintivamente un interés por la forma y las funciones de las estructuras que crean. Al mismo tiempo, muchos arquitectos han descubierto que los bricks LEGO son una forma perfecta de expresar físicamente sus ideas creativas.

Esta relación se confirmó a principios de la década de 1960, con el lanzamiento de la línea «Scale Model» de LEGO. Encajaba bien con el espíritu de la época: un tiempo en el que los arquitectos modernos redefinían el aspecto de las casas y la gente se interesaba cada vez más por el diseño de su nuevo hogar. Los sets se diseñaron para que se diferenciaban de los normales, que se comercializaban en cajas de brillosos colores, e incluían un libro sobre la arquitectura que proporcionaba inspiración a sus usuarios.

Décadas más tarde, el arquitecto y fan de LEGO Adam Reed Tucker reavivó la idea de expresar la arquitectura usando bricks LEGO y, en colaboración

con The LEGO Group, lanzó la línea LEGO Architecture que hoy conocemos.

Sus primeros modelos, y los sets originales de la actual serie LEGO Architecture, eran interpretaciones de los rascacielos más famosos de su ciudad natal, Chicago. Desde entonces, LEGO Architecture se ha desarrollado y ha evolucionado, primero incorporando edificios célebres de otras ciudades de Estados Unidos y, ahora, estructuras emblemáticas de Europa, Oriente Próximo y Asia.

La introducción del set LEGO Architecture Studio recupera las ambiciones de la antigua línea «Scale Model» de LEGO y amplía el potencial de la serie LEGO Architecture. Hoy puedes disfrutar mientras construyes y aprendes sobre edificios célebres, o crear tus propios modelos arquitectónicos a partir de tu imaginación. Un instructivo libro de 270 páginas con materiales creados por arquitectos internacionales de gran reputación te guiará a través de los principios de la arquitectura y te animará a dar tus primeros pasos en el mundo de la construcción creativa.

Celebrate the world of architecture and collect all the models
Célébrez le monde de l'architecture et collectionnez tous les modèles
Celebra el mundo de la arquitectura y colecciona todos los modelos

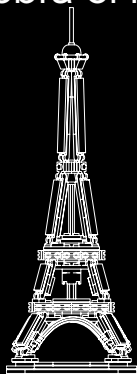

21019
The Eiffel Tower
La tour Eiffel
La Torre Eiffel

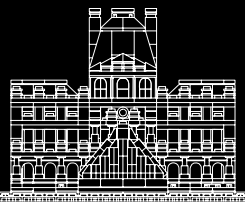

21024
Louvre

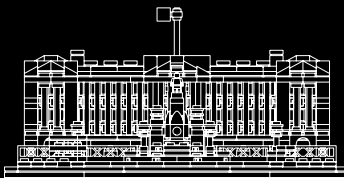

21029
Buckingham Palace
Le palais de Buckingham
Palacio de Buckingham

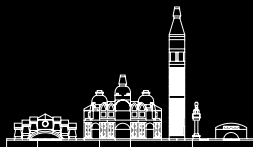

21026
Venice
Venise
Venecia



21027
Berlin
Berlín



21028
New York City
New York
Nueva York

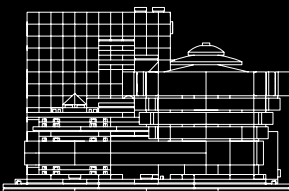

21035
Solomon R. Guggenheim Museum®
Musée Solomon R. Guggenheim®
Museo Solomon R. Guggenheim®



21030
United States Capitol Building
Le Capitole des États-Unis
Edificio del capitolio de Estados Unidos

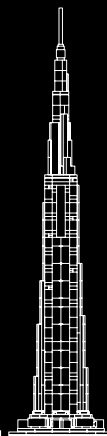

21031
Burj Khalifa



21032
Sydney
Sidney



21033
Chicago

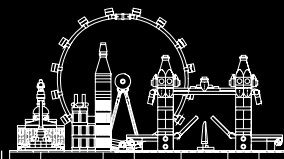

21034
London
Londres

References

Text credits:

www.arcdetriompheparis.com

Photo credits:

www.shutterstock.com

For further information please visit:

www.arcdetriompheparis.com

Références

Crédits textes :

www.arcdetriompheparis.com

Crédits photos :

www.shutterstock.com

Pour en savoir plus, veuillez vous rendre sur :

www.arcdetriompheparis.com

Referencias

Redacción:

www.arcdetriompheparis.com

Fotografías:

www.shutterstock.com

Para más información, visita:

www.arcdetriompheparis.com

Customer Service

Kundenservice

Service Consommateurs

Servicio Al Consumidor

LEGO.com/service or dial



00800 5346 5555:



1-800-422-5346:



4x 6073432
 14x 614101
 8x 407001
 26x 302401
 8x 300501
 8x 4113261
 4x 6051511
 20x 302301
 30x 393701
 10x 306901
 4x 4249563

2x 306801
 4x 6156667
 2x 243101
 4x 371001
 8x 365901
 10x 4560178
 6x 6106183
 2x 379501
 2x 300801

4x 4558953
 1x 6126082
 1x 4211397
 4x 6146223
 6x 4211438
 2x 4211374
 2x 4144012
 1x 4120020

4x 6015344
 24x 4211398
 20x 6066097
 10x 4654582
 4x 4211568

2x 4144387
 14x 4143005
 4x 6127662
 8x 302323
 2x 371023
 2x 4212411
 2x 447723

8x 6145570
 8x 4114026
 2x 6024495
 8x 4113917
 4x 6187580
 4x 6132769
 2x 4114309
 2x 4157277
 2x 4114001

1x 4222960
 1x 6078236
 2x 4496699
 30x 4507045
 4x 243126
 1x 6131571

4x 416226
 1x 6191892
 3x 383226
 4x 303026
 2x 428226



Customer Service

Kundenservice

Service Consommateurs

Servicio Al Consumidor

LEGO.com/service or dial



: 00800 5346 5555

: 1-800-422-5346



LEGO and the LEGO logo are trademarks
of their/son des marques de commerce
du/son marcas registradas de LEGO Group.
©2017 The LEGO Group. 6205215