

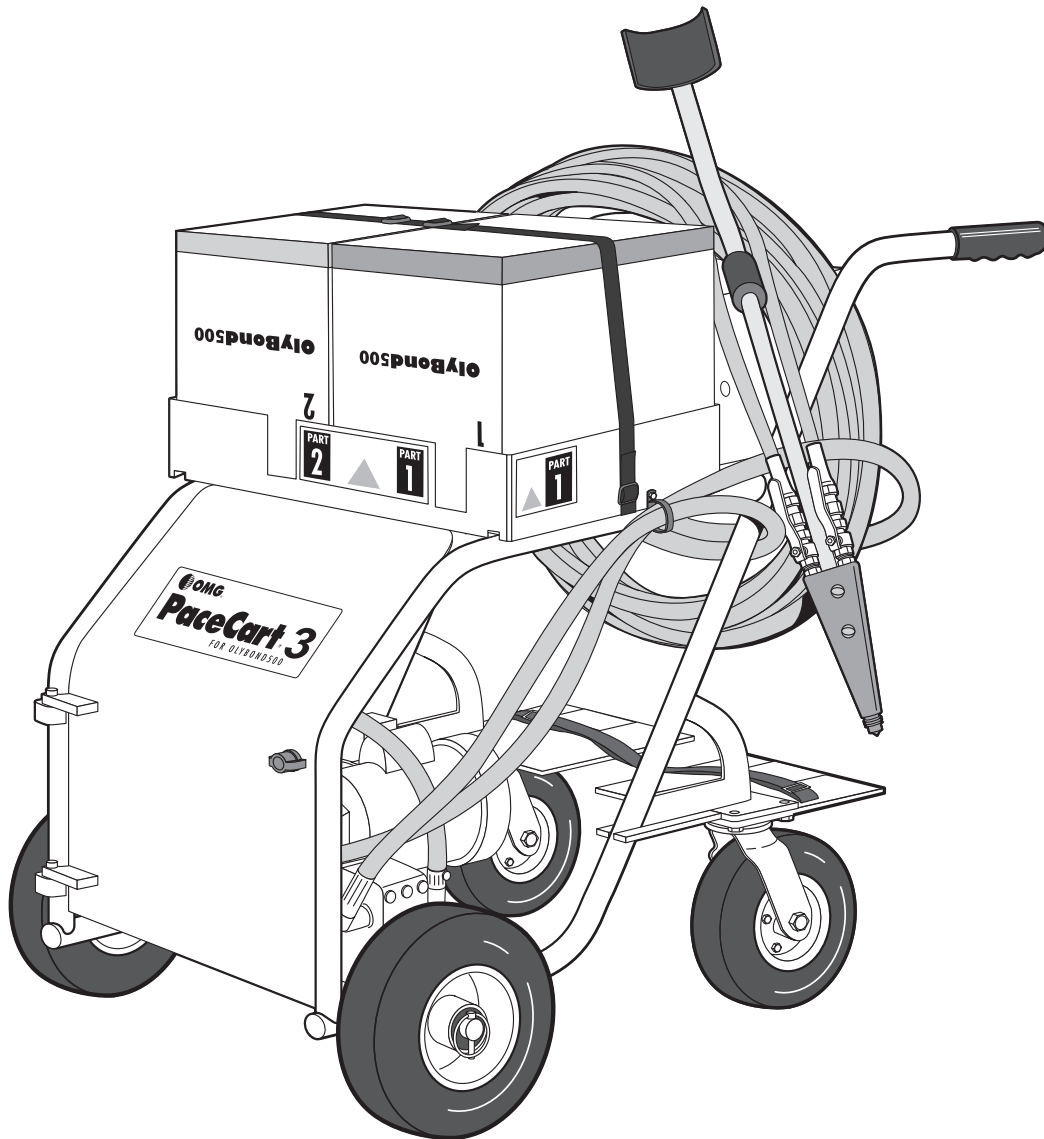

PaceCart 3™

FOR OLYBOND500®

Patented portable delivery system for OlyBond500® Insulation Adhesive featuring bag-in-box technology



OWNER'S MANUAL



153 BOWLES ROAD, AGAWAM, MA 01001 USA
800-633-3800 413-789-0252 OMGROOFING.COM

AH1037 Rev. 04/18/2018

IMPORTANT!
Save this manual
and read it in full
before use.

TABLE OF CONTENTS

- 3 Safety Instructions**
- 3 PaceCart 3 System**
 - Accessories Provided
 - Tools Required
- 4 System Components**
- 4 Material Compatibility Specifications**
 - Approved Substrates
 - Approved Insulation Types
 - OMG Consultation Services
- 5 Operating Instructions**
 - Step 1: Tighten Fittings
 - Step 2: Install OlyBond500 Boxes
 - Step 3: Check Power
 - Step 4: Purge the Gun
 - Step 5: Grease and Attach Mix Tip
 - Step 6: Apply Adhesive to Surface
 - Step 7: Shut-Down Procedures
 - Step 8: Start-Up after Shut-Down

- 6 Schematic & Parts List**
- 7 Troubleshooting**
- 8 Important Information**
- 8 Warranty**

PACECART 3 WITH BAG-IN-BOX TECHNOLOGY

Thank you for choosing OlyBond500® Adhesive, and for investing in the PaceCart 3 for fast, reliable application. PaceCart 3 is a portable, easy-to-use system for attaching approved insulation in virtually any flat or low-slope roofing application.

Features & Benefits:

- Lowest installed cost method of attaching insulation
- Fastest, low-pressure method available, secure up to **60 squares (557m²) of insulation per hour**
- Lightweight, portable, clean and easy-to-use
- No noxious odors or noise during installation
- Two component reaction occurs in the disposable mix tips so the gun and hoses remain clean and free-flowing for maximum efficiency

OlyBond500 is so versatile it can be used to adhere almost any type of insulation to a wide variety of substrates. (See page 4 for details.) Regardless of roof size, installation is easy thanks to the patented PaceCart 3 dispensing system. Highly portable, the PaceCart 3 does not require heated hoses or high-pressure spray equipment. Although it offers a safe, tested method of application, be sure that every member of your crew has a thorough understanding of the system before use. Read, understand and follow all instructions. To schedule rooftop training, call **800-633-3800** or **413-789-0252**.

Use only approved OlyBond500 adhesives with this machine. Failure to do so may cause extensive damage and will void all warranties.

PATENT NOTICE: The OMG PaceCart 3™ dispensing cart and the Bag-in-Box OlyBond500® Part 1/Part 2 adhesive system, including the adhesive dispensing method, are covered by one or more of U.S. Patent Nos. 6,220,526; 8,113,385; 8,132,693; 8,167,170; 8,342,372; 8,474,658; 9,327,308 and Canadian Patent No. 2,591,502. U.S. and Canadian Patents Pending.

Congratulations on your new purchase. We look forward to your feedback. Please send us your comments and suggestions at any time.

PaceCart 3 Product Development Team

OMG, Roofing Products | info@olyfast.com | 800-633-3800 | 413-789-0252 | www.omgroofing.com

© Copyright 2018 OMG, Inc. All rights reserved.

OlyBond500®, PaceCart 3™ and OMG PCPreserver™ are trademarks of OMG, Inc., a leading provider of innovative fastening solutions and products for the construction industry.

Contact OMG or your roofing membrane manufacturer for the most current list of approvals.



Subject to the conditions of approvals as insulation adhesive for use in Class 1 roof construction as described in the current edition of the FMRC Approval Guide.



For roofing systems as to external fire exposure see UL directory of products certified for Canada and UL roofing materials and systems directory.

READ & SAVE ALL INSTRUCTIONS

Thank you for purchasing a PaceCart 3, the most efficient method for installing OlyBond500 Insulation Adhesives. When properly used, your new PaceCart 3 can dispense enough OlyBond500 to apply up to 60 squares (557m²) of roofing insulation per hour.

OlyBond500 is a two-part, slow rise, polyurethane adhesive used to adhere insulation to insulation and to low-slope roof substrates in both new and re-roof applications.

APPLICATION

Part 1 is to be mixed with Part 2 at a 1:1 ratio by volume and applied using the OMG PaceCart 3 dispenser.

HANDLING & STORAGE

OlyBond500 should be stored in a cool, dry location at temperatures between 55°F and 85°F (13°C and 29°C). Protect from freezing at all times. Keep containers closed. Contamination by moisture or basic compounds can cause dangerous build-up in a closed container. The minimum product temperature before application should be 72°F (22°C). The minimum ambient and surface temperatures should be 40°F (4°C) and rising.

For long term PaceCart storage, use OMG PCPreserver™.

WEAR PROTECTIVE GEAR

Do not get into eyes, on skin or on clothing. Wash thoroughly after handling.

- **Splash goggles**
- **Gloves**

DISPOSAL

Do not discharge into lakes, streams, ponds or public waters. Spilled material, unused contents and empty containers should be neutralized and disposed of in accordance with local, state and federal regulations.

DO NOT LEAVE EXPOSED OR UNPROTECTED.

Polyurethane foam or isocyanurate foam products may present a serious fire hazard if exposed or unprotected. Each person, firm or corporation engaged in the manufacture, production, application, installation or use of any of these materials should carefully determine whether there is a potential fire hazard associated with such product in a specific usage and take all appropriate precautionary and safety measures as outlined in local, state and federal regulations. When not in use, keep stored containers closed.

WARNING

OlyBond500 must be applied with a compatible PaceCart dispenser and stored at room temperature prior to use. Keep containers closed and store in a well-ventilated, cool, dry location in temperatures between 55° and 85°F (13°C and 29°C). Protect from freezing. Use only with ventilation, which will keep the vapor concentration below the TLV ceiling limit of 0.02 PPM. Failure to follow all instructions could result in **property damage or serious personal injury**.

FIRST AID DIRECTIONS

Contact with this product can cause serious harm. Seek assistance as follows.

Eyes: Immediately flush eyes with running water for at least 15 minutes. Call a physician immediately. **Skin:** Wash affected area with soap and water. **Ingestion:** If swallowed, give large amounts of water to dilute. If vomiting occurs, give more water. Call a physician immediately.



THE PACECART 3 SYSTEM

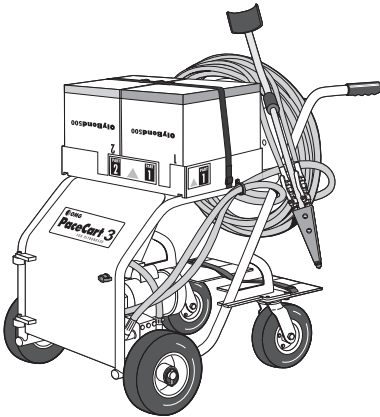

PROVIDED WITH PACECART 3



White Lithium Spray

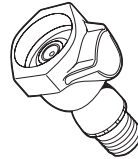

Connectors
(3 black and 3 gray included)



Mix Tips
(20 included)



Cleaning Solvent

ADDITIONAL TOOLS REQUIRED



Stable Power
110-125 volts,
60 Hz AC

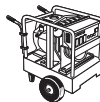

Power Cord
75 feet (23m) max.
12 gauge (2.8mm) min.



Adjustable Wrench

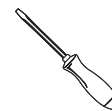

Large Flathead Screwdriver



Empty Bucket



SYSTEM COMPONENTS

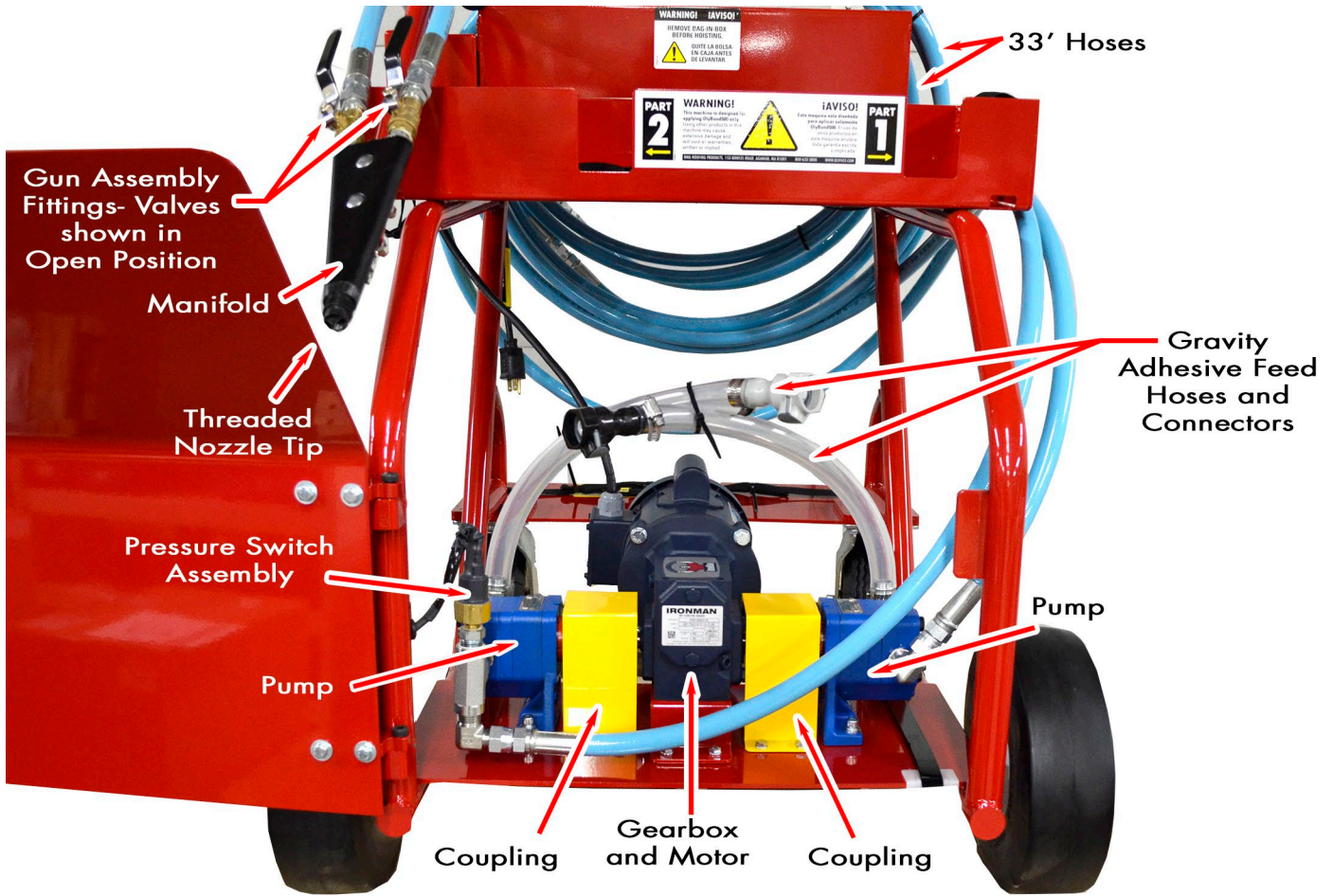

See the complete parts list on pages 6–7.

MATERIAL SPEC

OlyBond500 adheres virtually all common types of insulation to a wide variety of substrates and is compatible with and approved by most roof system manufacturers.

Approved substrates

Concrete	Existing BUR (smooth)
Lightweight concrete	Steel
Gypsum	Wood
Tectum	Existing modified bitumen
Most vapor barriers	

Approved insulation

Polyisocyanurate	Expanded polystyrene
High density wood fiber	Foam glass
Perlite	Certain extruded boards
Most cover boards	

To determine compatibility with substrates or insulation not listed, call 800-633-3800 or 413-789-0252.

FOR ASSISTANCE

In addition to supplying a broad array of fasteners and accessories, OMG Roofing Products has a nationwide team of field representatives who offer services to contractors, building owners, architects and roof consultants, including:

- pull-tests
- job starts
- pre-installation application assistance and training

For consultation or on-site assistance, contact OMG at 800-633-3800 or 413-789-0252.

OPERATING INSTRUCTIONS

STEP 1: TIGHTEN ALL FITTINGS

Fittings can loosen in transit. Use a wrench to check all hose connections and tighten as necessary.

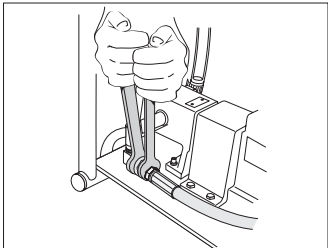

STEP 2: INSTALL BAG-IN-BOX



Extend spout on Part 1 & Part 2 boxes.

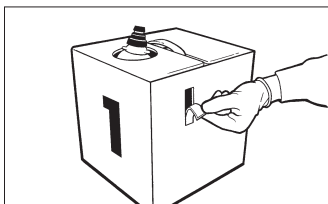

Open window on each box.

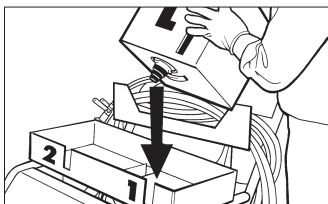

Invert boxes and place in correct trays, aligning windows with open slots at front of each tray.

Note that adhesive tray color matches the color of the nozzle on the adhesive bag. Part 1 is black, part 2 is gray.

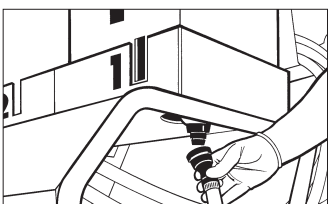

Lubricate connectors using white lithium spray, then connect spouts to gravity hoses. Remove any air from gravity hoses by squeezing and pushing air into box.

WARNING

Connector colors must match!

Part 1A: Black to Black
Part 2B: Gray to Gray



STEP 3: CHECK POWER SPECS, PLUG IN CART

Never run PaceCart 3 with low-voltage power or you risk severe damage to the motor!

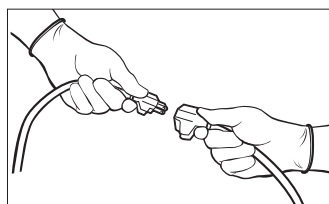

The PaceCart 3 requires power in the range of 110 to 125 volts, 15 amp. Check the power source to be sure there is no competing equipment. Using an overloaded line or an extension cord longer than 75 feet (23m) will diminish your power. Ensure that the on-board voltage meter shows ample power: i.e. 110-125 Volts.

WARNING

If the machine stops operating and begins to hum, turn it off immediately and check the power source.



STEP 4: PURGE GUN TO PREPARE IT FOR USE

WARNING

The nozzle must be cleaned before attempting to purge the gun.



Purge the gun by running OlyBond500 material through it before attaching the mix tip.

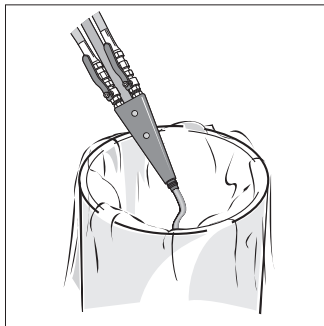

With valves open and the gun over a bucket, turn on the PaceCart 3 at the power switch. For new PaceCart 3 equipment, leave valves open and let material run for 1 minute after it starts to flow to purge packing oil from pumps. For each subsequent use, let material flow for 30 seconds. There should be equal streams of Part 1 and Part 2, indicating that both sides are flowing properly. Make sure the two sides are running evenly. Shut valves.

STEP 5: ATTACH MIX TIP

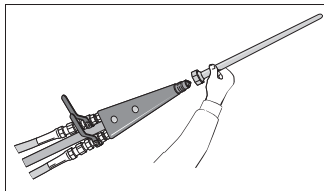

Lubricate threads with white Lithium spray before connecting the tip. Attach the mix tip to the gun. Immediately proceed to step 6.

STEP 6: APPLY ADHESIVE TO SURFACE
Open both valves completely and dispense material in a serpentine pattern as shown above.

Dispense material at increments as specified by the manufacturer.

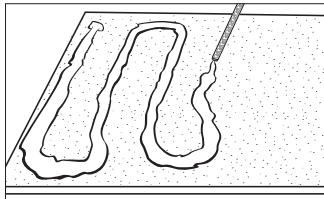

When dispensed with a 1:1 ratio, a chemical reaction occurs on the substrate, and the adhesive begins to foam.

OlyBond500 is formulated to give roofers sufficient time (3-4 minutes) to place the insulation boards onto the adhesive before it reaches its tack-free state.

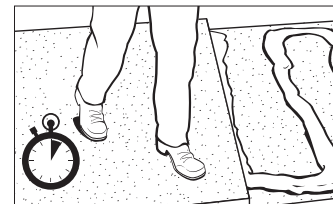

CAUTION

Replace the mix tip every time you stop. Failure to do so may result in clogged gun and hoses.

STEP 7: LONG TERM SHUT-DOWN PROCEDURES

Always store the PaceCart 3 with the boxes in place.

- Turn off power to adhesive cart.
- Close ball valves - relieve pressure from lines completely.
- Leave mix tip on.
- Keep gun pointing downward.

NOTE

For long term storage, use OMG PCPreserver.

After long-term storage, call OMG for service at 800-633-3800 or 413-789-0252.

STEP 8: START-UP AFTER SHUT-DOWN

1. With machine in the "off" position, open valves.
2. Insert supplied drill bit and rotate by hand to clear any obstructions.
3. Clean drill bit before clearing out the other side.

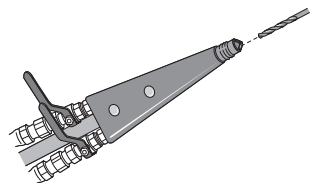

4. Attach new mixing tip when ready to dispense.

PACECART 3 TOOL PARTS BREAKDOWN

All parts sold as each unless otherwise noted.

See part numbers listed on next page.

International customers: Please contact your local OMG representative.

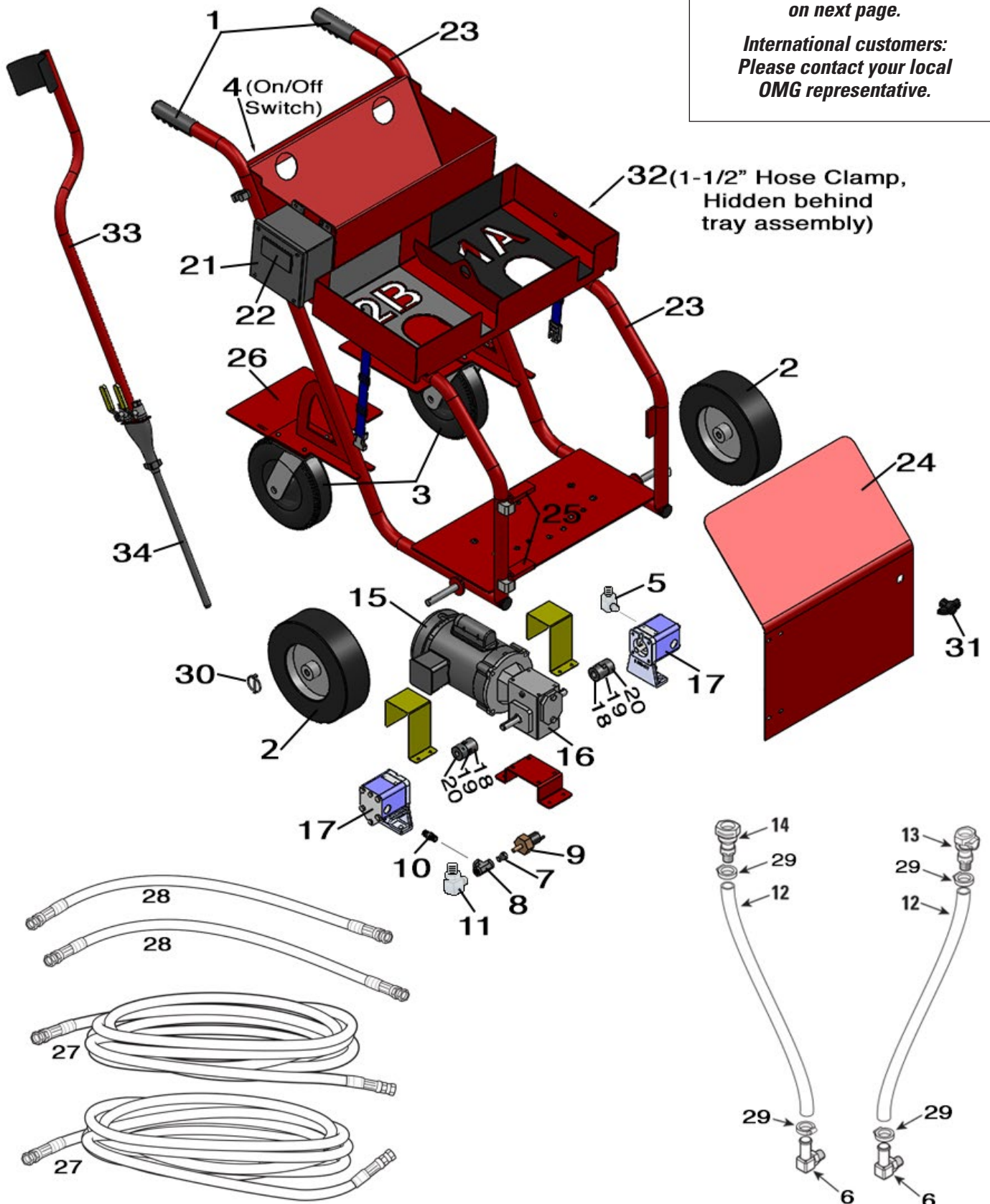

PART NUMBERS

All parts sold as each unless otherwise noted.

KEY DESCRIPTION..... PART #	KEY DESCRIPTION..... PART #	KEY DESCRIPTION..... PART #
Frame, Motor, Gearbox and Pump Assemblies		
1 1.25" Handle Grip	18 5/8" Coupling OBPC3-COUPKIT	Miscellaneous Parts*
2 Front Foam Tire (Front) OBPC-FOAMTIRE	19 Coupling Insert OBPC3-COUPKIT	*9 Pressure Switch OBPSWITCH
3 Foam Caster (Rear) OBPC-CASTER	20 1/2" Coupling OBPC3-COUPKIT	*10 Check Valve 1/2" Male NPT x 1/2" Male NPT OBPC2B-CHECKV
4 On/Off Switch (Ref) OBPC2-ONOFF	21 Junction Box Assembly OBPC3-JBOX	
5 90° 1/2" Male ORB x 1/2" Male NPT OBPC3-FITKIT	21A Breaker Switch OBPC2B-BREAKER	
6 90° 3/4" Hose Barb x 1/2" Male NPT (Quantity of 2 in kit) OBPC3-FITKIT	21B Breaker Reset Button OBPC2B-RESET	
7 1/2" Male NPT x 1/4" Female NPT Reducer OBPC3-SWITCHKIT	22 Voltage Meter OBPC3-VOLTMETER	
8 Tee 1/2" NPT x 1/2" NPT x 1/2" NPT. OBPC3-SWITCHKIT	23 Main Frame Pace Cart	
*9 Pressure Switch OBPC3-SWITCHKIT	24 Hood	
*10 Check Valve 1/2" Male NPT x 1/2" Male NPT OBPC3-SWITCHKIT	25 Hinge	
11 90° 1/2" Male ORB x 1/2" Male NPT OBPC3-SWITCHKIT	26 Generator Shelf (Set of 2) OBPC3-GENPLATE	
12 Clear Gravity Hose OB17GRAVHOSE	27 30' Hose with 1/2" JIC Female Ends OB500HOSE-30	
13 Black Connector Part 1 (Bundle of 6) OBCONKIT	28 36" Whip Hose 1/2" Male JIC x 1/2" Female JIC OB18WHIP	
14 Gray Connector Part 2 (Bundle of 6) OBCONKIT-GRAY	29 1" Hose Clamp	
15 Leeson Motor V13504 1/2 hp OBPC2B-MOTOR	30 Hitch Pin for Wheel	
16 Gear Box OBPC3-GEARBOX	31 Southco Knob	
17 Pump OBPC3-PUMP	32 1 1/2" Hose Clamp	
17A Pump Seal Kit OBPC3-SEALKIT	33 Complete Gun Assembly OBPC-VEEGUN	
	34 Mix Tips (Bundle of 20) OB500MIXTIP-20L	

For part numbers not listed or for older models, please call OMG for assistance.

PACECART 3 TROUBLESHOOTING

SYMPTOM	REPAIR SUGGESTIONS
Audible humming/vibration coming from motor assembly.	Disconnect electrical power from the cart to avoid motor damage. Remove the pump and clean it, or unfreeze it by the method described below. (The last suggestion at the bottom.)
OlyBond500 does not flow from gun.	Check to see if gun, whips or hoses are clogged. Clear any clogs and repeat Steps 2, 4, 5 and 6 of operating instructions. AND: Make sure pumps are working.
Machine pumps unequal amounts of materials 1 and 2.	Flow might be disrupted by clog. Make sure the materials are at the correct application temperature. AND: Check hose for even flow. AND: Clean gun. AND: Check part 1 pump for blockage.
OlyBond500 does not foam up.	Gun may not be delivering equal amounts of material (from boxes 1 & 2), thereby preventing chemical reaction. Check for clogs in hoses or gun. AND: Check boxes for inadequate material levels.
Material foams up, but has no holding power.	Foam may be off ratio. Check for equal flow of Part 1 & Part 2. AND: Material may have been frozen. Dispose of it and replace with fresh material.
Motor turns but pump does not supply material.	Pump may be clogged or broken. Call 800-633-3800 or 413-789-0252 for assistance.
Motor does not turn.	Make sure on/off switch is in "on" position. AND: Make sure breaker switch is on. AND: Pressure switch may be activated. Open valves to relieve pressure in hoses. If none of these remedy the situation, check power source. Turn off PaceCart 3 immediately as insufficient power will damage the motor. Be sure your power cord is no longer than 75 feet (23m). AND: Be sure your power source is delivering power at 110-125v, 15 amp. AND: Check for competing equipment on the same line. AND: Pump may be frozen. With the motor turned off- remove the two pump mounting bolts, pull the pump away from its shaft coupling and use a tool to rotate the pump shaft back-and-forth until the pump shaft freely turns.

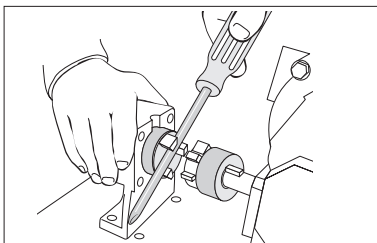

IMPORTANT INFORMATION

to keep your PaceCart 3 dispenser operating smoothly

OlyBond500 and the patented PaceCart 3 System are a team, designed to work together to help make you more productive on the roof. The PaceCart 3 dispenser is engineered to work exclusively with the patented OlyBond500 Bag-in-Box to deliver insulation attachment that lasts and lasts. And the system is supported on the roof by OMG Roofing Products, the best in the business.

In order to get the most from your PaceCart 3 dispenser and to continue to receive the rooftop services that make your life easier, make sure that you always use authentic OlyBond Adhesives. The chemistry and physical properties of genuine OlyBond500 Adhesives are specifically designed to flow smoothly through the PaceCart 3 dispenser and will not create mechanical stress on drive system components or damage the supply lines.

The use of any chemicals not supplied by OMG may cause damage to the PaceCart 3 hoses and pumps, and should be avoided. OMG cannot control the fillers and solvents supplied by other manufacturers, and will not take responsibility for repairing carts damaged by third party chemicals. OMG has the highest confidence in the quality and performance of its products, and when genuine OlyBond500 Adhesives are purchased from authorized OMG distributors, they are supported by the entire OMG Roofing Products Team. With genuine OlyBond500 Adhesives, you can be assured of the highest standards of quality and enduring performance.

Don't settle for an imitation when you can have the original. Use authentic OlyBond500 Adhesives to get the job done.

WARRANTY AND REMEDY

ALL WARRANTIES OF THE PRODUCTS DESCRIBED HEREIN, EXPRESS OR IMPLIED, INCLUDING THE WARRANTIES OF MERCHANTABILITY AND FITNESS FOR PARTICULAR PURPOSES ARE SPECIFICALLY EXCLUDED, EXCEPT FOR THE FOLLOWING: OMG Roofing Products will repair or replace, at its sole option, any tool part which within 30 days after sale by OMG Roofing Products or its distributors, is found by OMG Roofing Products to be defective in material or workmanship, normal wear and tear excluded. DOES NOT COVER MISUSE OR NEGLIGENCE.

THIS IS THE SOLE WARRANTY OF OMG ROOFING PRODUCTS AND THE SOLE REMEDY AVAILABLE TO DISTRIBUTOR OR BUYER.



OMG Roofing Products
153 Bowles Road, Agawam, MA 01001 USA
800-633-3800 413-789-0252
www.OMGRoofing.com