



PDHonline Course M478 (5 PDH)

Coating & Painting Inspections Fundamentals

Instructor: Jurandir Primo, PE



2013

PDH Online | PDH Center

5272 Meadow Estates Drive
Fairfax, VA 22030-6658
Phone: 703-988-0088

www.PDHonline.com
www.PDHcenter.org

An Approved Continuing Education Provider

CONTENTS:**I. INTRODUCTION****II. BASIC CONCEPTS****III. SURFACE PREPARATION**

1. Surface Preparation Standards
2. Contaminants Evaluation
3. Photographic Inspection Standards
4. Standard Surfaces Photographs
5. Alternative Cleaning Surface Methods
6. Abrasives
7. Abrasive Sizes
8. Metal Surface Profiles
9. Blasting and Cleaning Equipment
10. Interval Between Blasting and Painting

IV. COATING APPLICATION AND CONDITIONS

1. Components of Coatings
2. Coating Types
3. Coating Layers
4. Environmental Conditions
5. Coating Application Methods
6. Other Metal Coating Processes
7. Coating Types and Specifications
8. Special Coatings
9. Coating Characteristics
10. Resin Types and Application Properties
11. Alkyd Modifications
12. Curing and Hardening Driers
13. Painting Procedures
14. Relative Humidity and Dew Point in Job Sites

V. COLOR SYSTEMS

1. The Munsell Color System
2. Munsell Color Identification
3. Value and Chroma
4. Industrial Color Identification
5. Industrial Safety Colors
6. Prang Color System
7. British Color System
8. RAL Color System
9. RAL Color Chart

VI. COATING & PAINTING INSPECTIONS

1. Inspection Preparation Procedures
2. Inspection Hold Points
3. Inspection Reports
4. Disagreements with the Contractor
5. Non-conformance Reports NCR)
6. Instruments for Coatings Inspection

VII. DUTIES OF PAINTING INSPECTIONS

1. Painting Inspections
2. Visual Inspection
3. Gages Calibration
4. Weld Coating
5. Material Safety Data Sheet (MSDS)
6. Inspecting Coating & Painting Failures
7. Checking the Relative Humidity and Dew Point
8. Surface Roughness Concepts

VIII. WFT AND DFT RELATIONSHIP

1. WFT and DFT Calculations
2. WFT Measurements
3. DFT Measurements
4. Measuring Surface Profiles
5. Nondestructive Testing Gages
6. Coating Thickness – Gage Selection
7. WFT and Holiday Testing Procedures
8. Adhesion & Destructive Testing Procedures
9. Base Metal Reading (BMR)
10. DFT Rules
11. Immersion Painting Cure Evaluation

IX. CONCRETE COATING INSPECTIONS

- Concrete Coating Inspections
- Concrete Coating Thickness
- Concrete Coating Adhesion Tests
- Concrete Floor Coatings
- Concrete Polishing
- Building Insulation

LINKS AND REFERENCES

I. INTRODUCTION:

The word “*coating*” is a generic term and includes “*painting*”. The terms “*coating*” and “*painting*” are used interchangeably throughout literature. In the most general terms, a “*coating*” is a protection against **corrosion**, where “*painting*” may have additional **properties**, such as color or ultraviolet screening pigments. The other term often used together is “*lining*.” In general, when describing the coating of internal surfaces of pipes or tanks, the term “*lining*” is also used, and to identify the coating of external surfaces the terms “*coating*” or “*painting*” are always used.

The coating formulation is generally based on organic, inorganic, polymer, and co-polymer chemistry. It is not the intention of this short course to discuss coating **chemistry** but, to provide a basic knowledge of coating components, generic coating types and inspection procedures for painting of industrial equipment.

A coating's effectiveness depends on selecting coating material that correctly matches the intended service exposure for the metalwork. Today, selection is based on **service** exposure, results of performance and evaluation of commercially available products. The organizations that define the **standards** for specifying coating materials, surface preparation, application, inspection and testing are referenced below:

- American Society for Testing and Materials (ASTM);
- NACE International (formerly called National Association of Corrosion Engineers) (NACE)
- Society for Protective Coatings (formerly called Steel Structures Painting Council) (SSPC).

The coating (or painting) inspector and the coating applicator are not expected to have the **expertise** of a coating chemical formulator or a coating specialist engineer, but should be reasonably **familiar** with the materials being applied. This **guide** is intended to provide the most **basic** background on generic material types, surface preparation, application, and inspection methods.

II. BASIC CONCEPTS:

Corrosion: The primary reason for coating steel is to prevent corrosion. Corrosion of metals is an electro-chemical reaction that can be controlled by interfering with one or more of the four required elements of a corrosion cell:

- 1) Anode - (corroding area);
- 2) Cathode - (non-corroding area);
- 3) Electrolyte - (water or moisture in atmosphere, immersion, or soil);
- 4) Metallic path - (between two different metals or within the same metal).

The most common types of corrosion encountered on ferrous metal works are:

a) Uniform Corrosion: Corrosion that occurs more or less uniformly and results in rust and metal loss over the metal surface.

b) Galvanic Corrosion: Corrosion that occurs on the more active metal of two dissimilar metals that are electrically coupled together in the same electrolyte (e.g., water). The more active metal will corrode.

c) Crevice Corrosion: Crevice corrosion is a form of localized corrosion that occurs in **crevices** where the environment differs from the surrounding bulk environment. The different environments result in corro-

sion because of differences in concentration (e.g., oxygen, pH, and ferric ions). If there is an **oxygen** concentration difference, corrosion will proceed at crevices where there is less oxygen than in the environment surrounding the crevice.

Crevices are formed when two surfaces are in proximity to one another, such as when **two** metal surfaces are against one another, when a gasket is against a surface, or when angle irons are placed back to back. Crevice corrosion can occur under deposits (e.g., barnacles, dirt, grease, and slime) on a metal surface.

d) Pitting Corrosion: A form of localized corrosion where the depth of penetration is greater than the diameter of the affected area.

e) Cavitation Corrosion: The metal loss caused by the formation and collapse of vapor bubbles in a liquid near a metal surface. The appearance of cavitation is similar to pitting, except that pitted areas are closely spaced and the surface is considerably roughened.

f) Erosion-Corrosion: The accelerated metal loss from an initial corrosion mechanism associated with high-velocity flows and abrasion. Erosion-corrosion is characterized by grooves, gullies, waves, and rounded ridges or valleys and exhibits a directional flow pattern.



g) Leaching: Is the selective **removal** of one of the elements of an alloy by either preferential attack or complete dissolution of the **matrix**, followed by redeposit of the cathodic constituent. The element removed is always anodic to the matrix. With leaching, there is no metal loss, dimension changes, cracks, or grooves; however, the affected area may be evident because of a **color** change. The affected area becomes lighter, porous, and loses its original mechanical properties (i.e., it becomes brittle and loses tensile strength). Two common forms of leaching are:

- **Dezincification:** The selective dissolution of **zinc** from brass alloys. It is recognized by a color change (e.g., from its original yellow brass color to a distinctly red, coppery appearance).
- **Degraphitization:** The selective dissolution of **iron** from some cast irons, usually gray cast irons. It normally proceeds uniformly inward from the surface, leaving a porous matrix alloy that is composed mostly of carbon. Degraphitization can be recognized by a change from an original silver-gray color to a dark gray. The affected metal can be easily cut or pierced with a knife.

III. SURFACE PREPARATION:

Premature failures are often the result of inadequate **surface** preparation. Surface preparations that accept an allowable margin of cleanliness, but leave contaminants on the surface, may tend to lessen the coating service life. Thus, cleanliness of the substrate is an essential and integral component of a coating system. The types of surface contaminants are:

a) Rust: Rust is the corrosion byproduct (ferrous oxide) of steel and may be loose or may adhere relatively tightly to the **substrate**, is porous and may include moisture, oxygen, and soluble salts. Rust will expand up to eight times the volume of the base metal consumed and further corrode the steel substrate, thus dislodging any coating applied over it.

b) Mill Scale: Mill scale is a heavy **oxide** layer formed during hot fabrication or heat treatment of metals and is a bluish color. Mill scale will eventually break loose from the steel substrate, taking the coating with it. Steel is anodic to mill scale (steel has a lower electrical-chemical potential difference than mill scale); therefore, steel will corrode (sacrifice itself) to protect the mill scale.



c) Grease and Oil: Grease and oil prevent a coating from adhering to the substrate.

d) Dirt and Dust: Dirt and dust on the surface prevent the application of a smooth uniform film and weaken the adhesion of the coating to the substrate.

e) Soluble Salts: Soluble salts deposited on a surface can remain on the surface, even after abrasive cleaning. Soluble salts can increase moisture permeation through the coating (osmotic blistering) and may **accelerate the corrosion** rate, under the coating film (under-film corrosion or undercutting). The most common soluble salts encountered in the coating industry are chlorides, sulfates, and metallic salts. The chloride ion is the most aggressive.

f) Water: Water will **prevent** adhesion and may either produce flash rusting before coating application or it may accelerate under-film corrosion after coating application. Moisture in the liquid or frozen state will prevent adhesion of the coating to the substrate and can disrupt curing reactions of coatings. Moisture contamination can cause several types of failure.

g) Chalk: Chalk is the residue left after the deterioration of the coating's organic binder. Chalk results from exposure of the coating to **direct sunlight** or artificial UV light. All coatings chalk to some degree, as epox-

ies are more prone to chalk. Over-coating surfaces will result in poor adhesion and may result in delamination (separation of one coating layer from another coating layer) failure.

h) Deteriorated Coatings: Old, loose, deteriorated coatings that are over-coated may peel, delaminate, or lift from the substrate and take the new coating with them.

i) Compressed Air Contaminants: Moisture and oil of air compressors may contaminate the painting process, which can result in adhesion-related failures. The two **common operations** that transfer oil and water contaminants, from the compressed air supply, to substrates are:

- ✓ Abrasive surface preparation operations;
- ✓ Blowing down the substrate after surface preparation to remove dust before applying the coating.

Note: Air compressors should be equipped with inline moisture and oil separators (traps) on all lines. The painting inspector should check the air supply for contaminants in accordance with ASTM D 4285 (Appendix G). It is recommended that the compressed air lines be checked **once every 4 hours** or after the compressor has been turned off.

j) Flash Rusting: Flash rusting (sometimes called flashback rusting or rust blooming) is a light oxidation (corrosion) of the ferrous surface **after surface preparation** has been completed. Flash rusting develops on freshly prepared surfaces in the presence of moisture. After the moisture dries off, any resulting corrosion is called flash rusting and can **occur within minutes** after surface preparation.

k) Sandblasting: Times ago, the material used for **surface preparation** was sand, before coating, commonly sieved to a uniform size, and hence the term “*sandblasting*”. Health and environment organizations condemn this activity, due the silica dust produced in the sandblasting creates pollution and this process causes a lung disease known as silicosis.

l) Shotblasting: Means the **metal** surface preparation by blowing an **abrasive media**, for example, steel grit, steel shots, copper slag, glass beads (bead blasting), metal pellets, dry ice, garnet, powdered abrasives of various grades, powdered slag, and even ground coconut shells or corncobs, walnut shells, baking soda have been used for specific applications and produce distinct surface finishes, using compressed air, or mechanical means to propel the grit.

1. Surface Preparation Standards:

There are **several standards** describing the surface preparation methods, however, the most usual are **SSPC, ISO and NACE**. The inspector should ensure that the applicable procedure standard is available on the jobsite. Visual standards by SSPC, ISO and NACE are an aid supplement in determining the cleanliness. The surface visual inspection should not show traces of oil, grease or salt. The standard descriptions are:

a) SSPC-SP1: Solvent Cleaning: Solvent cleaning is used to remove grease, oil, dirt, drawing and cutting compounds, and other contaminants by solvent wiping, water washing, cleaning compounds, and steam cleaning. This procedure is a pre-requisite for all other surface preparation methods except for **SSPC-SP12/NACE 5** (water jetting) and **SSPC-SP13/ NACE 6** (concrete surfaces).

b) SSPC-SP2: Hand Tool Cleaning: Hand tools are used to remove loose mill scale, loose rust, loose coatings, weld flux, weld slag, or weld spatter by brushing, sanding, chipping, or scrapping. Tightly adhering rust, mill scale, and paint are allowed to remain. The use of hand tools is generally confined to small areas, all repair areas, or all inaccessible areas.

c) SSPC-SP3: Power Tool Cleaning: Power tools are used to remove loose mill scale, loose rust, loose coatings, weld flux, weld slag, or weld spatter. Tightly adhering rust, mill scale, and coating are allowed to remain if they cannot be removed by lifting with a dull putty knife. The requirements of this method are similar to SSPC-SP2, except that, with power tools, larger areas can be cleaned more efficiently.

d) SSPC-SP5/NACE 1: White Metal Blast Cleaning: White metal blast cleaning employs abrasive blasting to remove all grease, oil, dirt, dust, mill scale, rust, coatings, oxide, corrosion byproducts, and other foreign matter that are visible without magnification. Variation in color caused by steel type, original surface condition, steel thickness, weld metal, mill or fabrication marks, heat treatment, heat-affected zones, blasting abrasives, or differences in blast pattern is acceptable.

e) SSPC-SP6/NACE 3: Commercial Blast Cleaning: Commercial blast cleaning employs abrasive blasting to remove all grease, oil, dirt, dust, mill scale, rust, coatings, oxide, corrosion byproducts, and other foreign matter that are visible without magnification, except for random staining. At least two-thirds of each 9-inch-square area shall be free of all visible residues, and only the above-mentioned staining may be present in the remainder of the area.

f) SSPC-SP7/NACE 4: Brushoff Blast Cleaning: Brush-off blast cleaning employs abrasive blasting to remove all grease, oil, dirt, dust, loose mill scale, loose rust, and loose coatings that are visible without magnification. Tightly adhering rust, mill scale, and coatings are allowed to remain if they cannot be removed by lifting with a dull putty knife.

g) SSPC-SP8: Pickling: Pickling removes all mill scale and rust that are visible without magnification, by chemical reaction (acid bath) or electrolysis (anodic electrical current) or both. Acceptance criteria are to be established between the contracting parties.

h) SSPC-SP10/NACE 2: Near-White Metal Blast Cleaning: Near-white metal blast cleaning employs abrasive blasting to remove all grease, oil, dirt, dust, mill scale, rust, coatings, oxide, corrosion byproducts, and other foreign matter that are visible without magnification, except for random staining. At least **95 %** of each **9-inch-square area** shall be free of all visible residues, and the remainder of the area shall have only the above-mentioned staining.

i) SSPC-SP12/NACE 5: Surface Preparation and Cleaning of Steel by High and Ultra-high Pressure Water Jetting: High or ultra-high water jet blasting employs water blasting to remove all grease, oil, dirt, dust, mill scale, rust coatings, oxides, corrosion by-products, and other foreign matter that are visible without magnification. Nonvisible soluble salts to allowable limits should be removed. This standard defines the following four different water pressures:

- 1) Low-pressure water cleaning at less than **5,000 psi**;
- 2) High-pressure water cleaning at **5,000 to 10,000 psi**;
- 3) High-pressure water jetting at **10,000 to 25,000 psi**;
- 4) Ultra-high-pressure water jetting at greater than **25,000 psi**.

j) SSPC-SP13/ NACE 6: Surface Preparation of Concrete: applicable to all types of cementation surfaces including cast-in-place concrete floors and walls, precast slabs and masonry walls. Acceptable prepared concrete surface should be free of contaminants, laitance, loosely adhering concrete, and dust, and provide a sound, uniform substrate suitable for the application of protective coating or lining systems.

k) SSPC-SP14/NACE 8: Industrial Blast Cleaning: Industrial blast cleaning employs abrasive blasting to remove all visible grease, oil, dirt, and dust that are visible without magnification. Traces of tightly adhering mill scale, rust, and coating residue are allowed to remain on 10 percent of each 9 inch square area, provided that the distribution is even. Traces of rust, mill scale, and coatings are allowed to remain if they cannot be removed by lifting with a dull putty knife.

l) SSPC-SP15: Commercial Grade Power Tool Cleaning: Power tools are used to remove all grease, oil, dirt, dust, mill scale, rust coatings, oxides, corrosion byproducts, and foreign matters that are visible without magnification, except that random stains are allowed on **33 %** of each **9-inch square area**.



SSPC-SP5/NACE 1: White Metal Blast Cleaning

2. Contaminants Evaluation:

The degree of cleanliness is divided into **two categories**:

a) Visible Contaminants: Subdivided into four classifications, designated **WJ-1** through **WJ-4**. (WJ-1 is the cleanest) on the basis of allowable visible rust, coatings, mill scale, and foreign matter verified without magnification.

b) Nonvisible Contaminants: Subdivided into three classifications, designated **SC-1**, **SC-2**, and **SC-3**. (SC-1 is the cleanest) on the basis of allowable soluble chloride ions, iron-soluble salts, or sulfate ions. The visual standard will be determined by comparison to SSPC-VIS 4/ NACE 7 reference photographs.

3. Photographic Inspection Standards:

The ISO, SSPC and NACE/SSPC **visual reference photographs** are supplemental aids for **evaluating cleanliness** but not intended as a substitute for surface cleanliness requirements defined in the surface preparation standard used. The reason for inspecting the surface before surface preparation is that different degradations on the same steel surface (e.g., heavy mill scale with light and heavily rusted areas) will have a different appearance after using the same surface preparation method.

The **ISO 8501-1** is one of the main standards that cover blast cleaning, and it covers surface preparation, hand flame and acid cleaning. The chart below represents the various grades. See below the table of blasting qualities and their descriptions:

Standard	Method	Finish Description
Sa 1	Blast Cleaning	Poorly adhering mill scale, rust and old paint and foreign matter are removed. Well adhered contaminants remain.
Sa 2	Blast Cleaning	Most of the mill scale rust and paint are removed and any remaining is very well adhered.
Sa 2½	Blast Cleaning	Mill scale, rust paint and foreign matter are removed completely. Any remaining traces are visible only as slight stains or discoloration in the form of spots or stripes.
Sa 3	Blast Cleaning	All mill scale, rust, is removed and the surface has a uniform white metal appearance with no shading, stripes, and spots of discoloration.
St 2	Hand or Power-Tools	Poorly adhering rust, mill scale, are removed, leaving surface contamination that is well adhered.
St 3	Hand or Power-Tools	As for St 2, but the surface now exhibits a metallic sheen arising from the metal substrate.
F1	Flame	Almost all mill scale, rust and other surface contamination is removed leaving only a metallic sheen, but some discoloration due to shading left by remaining contaminants.
Be	Acid Pickling	All surface contamination including all mill scale rust is removed, leaving a uniformly grey clean surface. Paint must be removed prior to acid cleaning by some other means.

Notes:





















- a) Poorly adhering is defined for mill scale as “*able to be removed by lifting with a knife blade*”.
- b) Acid cleaning is not normally used for any other coating system than for galvanizing.
- c) For galvanizing, even when steel has been blast cleaned, it is always acid cleaned as well. Therefore for hot dip galvanizing, blast cleaning is rarely required, except to remove paint, severe rust, or for creating a thicker galvanized coating.

4. Standard Surfaces Photographs:

Accordingly, standard **surfaces photographs**, specifying four grades (A,B,C,D) of rusting or surface conditions, and a number of preparation grades, each establishing a quality grade or preparation prior to protective painting required on a steel surface in a **standard rust grade**. These grades are presented as a series of prints, which provide a clearer and more rapidly appreciated definition than a verbal description, as can be seen in pictorial examples, below.

a) Rust Grades: Initial conditions (or rust grades) are **photographs A, B, C, and D** and various areas of the surface to be cleaned **may match** one or more initial condition photographs. The initial surfaces preparation normally complies with rust grades **A or B** according to BS EN ISO 8501-1. Material rust grades **C or D**, should be **avoided**, when possible, since it is difficult to clean all the corrosion products from the pits during surface preparation. Descriptions of rust grades are as follows:

Pictorial examples of surface preparation according to ISO 8501-01.

Cleaning standard	Initial steel condition (see also table 1).			
	A	B	C	D
St2 – Hand tool cleaning	Not applicable			
St3 - Power tool cleaning	Not applicable			
Sa1 -Brush-off blast	Not applicable			
Sa2 - Commercial blast	Not applicable			
Sa2.5 -Near white metal				
Sa3 - White metal				

Notes:

- **A** - Steel surface largely covered with adhering mill scale, but little if any rust;
- **B** - Steel surface which has begun to rust and from which mill scale has begun to flake;
- **C** - Steel surface on which the mill scale can be scraped, but with slight pitting under normal vision;
- **D** - Steel surface on which general pitting is visible under normal vision.

b. Surface Preparation Standards: From the specifications, determine the specified surface preparation standard. The surface preparation standard will be one of the following: SSPC-SP5/NACE 1, SSPC-SP10/NACE 2, SSPC-SP6/NACE 3, or SSPC-SP7 NACE 4.

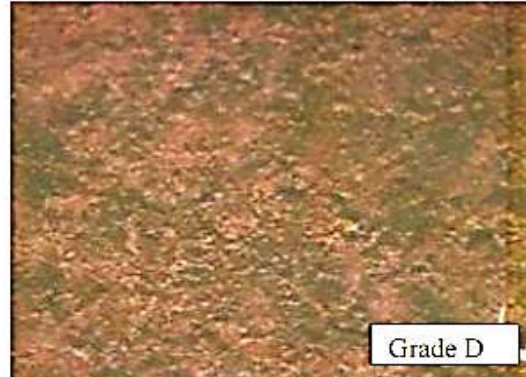
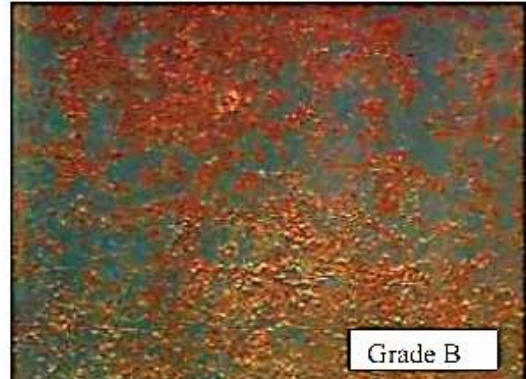
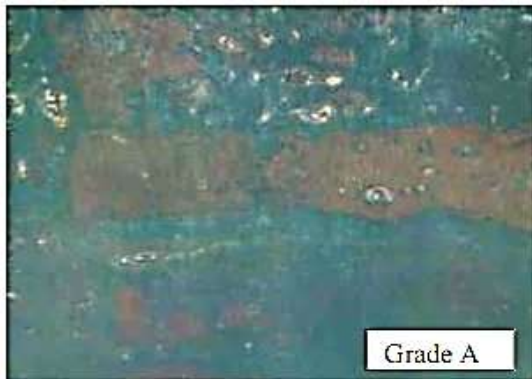

a) SSPC-VIS 1: Visual Standard for Abrasive Blast Cleaned Steel: This guide shows a series of **photographs** of unpainted carbon steel before and after abrasive blast cleaning. Below is an abbreviated explanation of the procedures to follow before and after cleaning the steel.

b) SSPC-VIS 2: Standard Method of Evaluating Degree of Rusting on Painted Surfaces: A scale and description of rust grades are given, and 27 full-color **photographs** and the corresponding black-and-white rust images illustrating the maximum percentage of rusting allowed for each rust grade from rust grade 9 to rust grade 1 for three different rust distributions are included.

c) SSPC-VIS 3: Visual Standard for Power and Hand-Tool Cleaned Steel: Beforehand or power-tool cleaning, match the existing surface condition that most closely represents the appearance with the “initial condition” shown in one of the photographic standards. Rust grades **A, B, C, and D** are for uncoated surfaces. Conditions **E, F, and G** (see table below) are for previously painted surfaces. The following designation codes are used in the standard to identify various hand and power tools:

- **SP2:** Hand wire brush.
- **SP3/ PWD:** Power wire brush. (not permitted a rotary power wire brush to avoid burnishing or polishing the metal surface, thus removing any existing surface profile.)
- **SP3/ SD:** Power sanding disc.
- **SP3/ NG:** Power needle gun.
- **SP11:** Power rotary flap peen or needle gun (to produce a surface profile).
- **SP11/ R:** Power tool using nonwoven disks (to restore existing surface profile).

d) SSPC-VIS 4/NACE VIS 7: Visual Reference for Steel Cleaned by Water Jetting: Initial conditions are B and C (photographs A and B are not included in the guide) are for uncoated surfaces. Conditions **E, F, G, and H** are for previously painted surfaces. The specified degree of cleaning is designated by one the following: WJ1, WJ-2, WJ-3, or WJ-4. A possible surface preparation method could be NACE 5/ SSPC-SP12 WJ-2/ SC-3 and the specified degree of cleaning is WJ-2.

e) SSPC-VIS 5/NACE VIS 9: Visual Reference for Steel Surfaces by Wet Abrasive Cleaning: Contains full-color photographs depicting the appearance of mill scale-free, unpainted, rusted carbon steel prior to and after cleaning by waterjetting, on high- and ultrahigh-pressure waterjetting prior to recoating, and are also applicable to surfaces produced by a wide range of waterjetting pressures.

SCALE AND DESCRIPTION OF RUST GRADES		
Rust Grades ^a	DESCRIPTION	SSPC-ASTM Photographic Standard
10	No rusting or less than 0.01% of surface rusted	Unnecessary
9	Minute rusting, less than 0.03% of surface rusted	No. 9
8 ^b	Few isolated rust spots, less than 0.1% of surface rusted	No. 8
7	Less than 0.3% of surface rusted	None
6 ^c	Extensive rust spots but less than 1% of surface rusted	No. 6
5	Rusting to the extent of 3% of the surface rusted	None
4 ^d	Rusting to the extent of 10% of the surface rusted	No. 4
3 ^e	Approximately one sixth of the surface rusted	None
2	Approximately one third of the surface rusted	None
1	Approximately one half of the surface rusted	None
0	Approximately 100% of the surface rusted	Unnecessary

^aSimilar to European Scale of Degree of Rusting for Anti-Corrosive Paints (1961) (black and white)

^bCorresponds to SSPC Initial Surface Conditions E (0 to 0.1 %)

^cCorresponds to SSPC Initial Surface Conditions F (0.1 to 1%)

^dCorresponds to SSPC Initial Surface Conditions G (1 to 10%)

^eRust Grades below 4 are of no practical importance in grading performance of paints

^fCorresponds to SSPC Initial Surface Condition H (50 to 100%)

c. Visual Standard Guide: It is important to understand that the guides **only describes** the pictorial standard and does not constitute the standard. It is to be used for **comparative purposes** and is not intended to have a direct relationship to a decision regarding painting requirements.

SSPC-VIS 1	Guide and Reference Photographs for Steel Surfaces Prepared by Dry Abrasive Blast Cleaning
SSPC-VIS 2	Standard Method of Evaluating Degree of Rusting on Painted Steel Surfaces
SSPC-VIS 3	Guide and Reference Photographs for Steel Surfaces Prepared by Power- and Hand-Tool Cleaning
SSPC-VIS 4/NACE VIS 7	Guide and Reference Photographs for Steel Surfaces Prepared by Waterjetting
SSPC-VIS 5/NACE VIS 9	Guide and Reference Photographs for Steel Surfaces Prepared by Wet Abrasive Blast Cleaning

TABLE OF COMMON SURFACE PREPARATION

	SSPC	NACE	ISO 8501-1	BSI BS 7079
Solvent Cleaning	SSPC-SP-1			
Hand Tool Cleaning	SSPC-SP-2		St 2 or St 3	Identical to ISO St (2 or 3)
Power Tool Cleaning	SSPC-SP-3		St 2 or St 3	Identical to ISO St (2 or 3)
Flame Cleaning	SSPC-SP-4		F1	Identical to ISO F1
White Metal Blast Cleaning	SSPC-SP-5	NACE No. 1	Sa 3	Identical to ISO Sa 3
Commercial Blast Cleaning	SSPC-SP-6	NACE No. 3	Sa 2	Identical to ISO Sa 2
Brush-Off Blast Cleaning	SSPC-SP-7	NACE No. 4	Sa 1	Identical to ISO Sa 1
Pickling	SSPC-SP-8			
Near-White Blast Cleaning	SSPC-SP-10	NACE No. 2	Sa 2 1/2	Identical to ISO Sa 2 1/2
Power Tool Cleaning to Bare Metal	SSPC-SP-11			
Water Blast	SSPC-SP-12	NACE No. 5		
Surface Preparation of Concrete	SSPC-SP-13	NACE No. 6		
Industrial Blast Cleaning	SSPC-SP-14	NACE No. 8		
Commercial Grade Power Tool Cleaning	SSPC-SP-15			

5. Alternative Cleaning Surface Methods:

There are alternatives to traditional abrasive blast cleaning methods that may reduce surface preparation costs, dust, or fouling of machinery by small abrasive particles, as described below:

a) Soda Bicarbonate Blasting: This method propels large crystals of soda bicarbonate (baking soda) by pressurized air or water. It is used mostly as a stripper for cleaning contaminants and for thin coatings. There is no surface cleanliness standard for this method; however, cleanliness can be specified to meet the requirements of a consensus surface preparation (e.g., NACE 3/ SSPC-SP6).

b) Chemical Strippers: are commonly used for small areas where power is not available, abrasive and water jet blasting is not economically feasible, hose distance is too great to achieve necessary air pressure for blasting operations, or where accessibility is limited. Chemical strippers can be classified into two generic composition types:

1) Bond Breakers: Bond breaker strippers work by breaking the paint's molecular bonds between paint layers and between the paint and the substrate so that paint will crinkle up and be easily removed. Bond breaker strippers can contain toluene, methylene chloride, or methyl ethyl ketone that removes paints in a relatively short time but may be considered hazardous to workers.

2) Caustic: Caustic strippers work by softening the entire paint system rather than breaking the molecular bonds. Caustic strippers can contain sodium, calcium, and magnesium hydroxide, whose applications are restricted to oil-based paints, but will not work on oil-based paints pigmented with aluminum flakes.

Note: There is no surface cleanliness standard for these methods, however, cleanliness can be specified to the requirements of an engineering consensus surface preparation (e.g., SSPC-SP6/NACE 3).

6. Abrasives:

Abrasives come in many forms and can be classified in several different ways, as shown below.

None metallic (Mineral)	Metallic (recyclable) - agricultural	Agricultural by-products
Copper Slag Nickel Slag Boiler Slag Glass Bead Aquamarine (Olivine) Garnet Sand	ACI (Angular Chilled Iron) Steel Grit Steel Shot Grit and Shot Mix Garnet	Walnut Shell Coconut Shell Eggshell Corn Cob Husk Peach Husk

a) Sand: Is **not permitted** to use sand (silica causes pneumoniosis or silicosis). The standard SI 1657 states that any mineral used as an abrasive must release **less** than 1% free silica on impact. Sand by itself is perfectly safe, but the shattering on impact releases silica which can be inhaled.

b) Copper Slag: Although the name implies metallic content, the amount of **copper** in the structure is little. The material is commonly supplied in **grit** form (random, sharp edges, amorphous) and is very brittle. It shatters into smaller pieces on impact, and should be used only once and then discarded, so, this product is classed as expendable.

c) Garnet: Is a natural **mineral** classed as being “*of diamond type hardness*” and can be either expendable or recyclable as the material can be reused, usually up to three times. It doesn’t shatter on impact but suffers some “wear”. This product is commonly supplied in grit form.

d) Metallic Grits: Are **irregular metallic abrasives**, generally recyclable, because the particles reduce in size slowly. Cast **iron** grit is softer than cast steel grit and both are high alloy materials. Anyway, the two of them tends to round off on impact and loses its profiles. Hence it can be reused many times and still perform a useful function in a “working mix”. A working mix is an accepted ratio of large and small particles, where the large particles cut the profile and the smaller particles clean out the equipment troughs.

e) Metallic Shots: Are **spherical metallic abrasives** and doesn’t shatter (otherwise it would form grit). The particles are virtually **uniform** in size and shape, (not a working as a mix) but wear down slowly in size. The particles worn down eventually to finings, and drawn out of the system during cleansing. A typical **mix ratio** of **shot** to **grit** would be 70 – 80 % **shot** to 20 – 30 % **grit**.



7. Abrasive Sizes:

- a) **G Prefix** = Grit amorphous, points and cutting edges, irregular profile.
- b) **S Prefix** = Shot spherical, smoother profile.

The **G** or **S** (SAE J444) notation is followed by a number, which denotes the particle size. For steel **grit**, the number corresponds the nominal test sieve, with a prefix **G** added, in accordance with ASTM E 11. For **shot**, the number corresponds the nominal test sieve, in **ten thousandths of inches**, preceded by an **S**, e.g., **S-550** indicates a cast steel shot identified by a nominal sphere diameter of 0.0550 in. (see table below).



a) Steel Grit (G):

Commonly used for applications requiring aggressive cleaning and stripping of steel and foundry metals. Effectively produces an etching on hard metals for better adhesion of coatings including paints, epoxy, enamel and rubber. Available in 4 Grades of Hardness in HRC: **S** (41-51); **M** (47-56); **L** (54-61); **H** (60 Min.).



b) Steel Shot (S):

Commonly used for stripping & cleaning metal surfaces in finishing operations. Produces smooth and polished finishes. In peening applications, strengthens metal parts. Smaller sizes produce smoother finishes; larger sizes produce rougher surfaces. Available in 4 Grades of Hardness in HRC: **S** (41-51); **M** (47-56); **L** (54-61); **H** (60 Min.).

SAE STANDARD - STEEL SHOT

SAE Size No.	SAE SHOT Tolerances	Screen Opening (Inch – mm)
S780	All Pass No. 7 Screen 85% Min on No. 10 Screen 97% Min on No. 12 Screen	0.1110 - 2.80 0.0787 - 2.00 0.661 - 1.70
S660	All Pass No. 8 Screen 85% Min on No. 12 Screen 97% Min on No. 14 Screen	0.0937 - 2.36 0.0661 - 1.70 0.0555 - 1.40
S550	All Pass No. 10 Screen 85% Min. on No. 14 Screen 97% Min. on No. 16 Screen	0.0787 - 2.00 0.0555 - 1.40 0.0469 - 1.18
S460	All Pass No. 10 Screen 5% Max on No. 12 Screen 85% Min on No. 16 Screen 96% Min on No. 18 Screen	0.0787 - 2.80 0.0661 - 1.70 0.0469 - 1.18 0.0394 - 1.00
S390	All Pass No. 12 Screen 5% Max on No. 14 Screen 85% Min on No. 18 Screen 96% Min on No. 20 Screen	0.0661 - 1.70 0.0555 - 1.40 0.0394 - 1.00 0.0331 - 0.850
S330	All Pass No. 14 Screen 5% Max on No. 16 Screen 85% Min on No. 20 Screen 96% Min on No. 25 Screen	0.0555 - 1.40 0.0469 - 1.18 0.0331 - 0.850 0.0278 - 0.710
S280	All Pass No. 16 Screen 5% Max on No. 18 Screen 85% Min on No. 25 Screen 96% Min on No. 30 Screen	0.0469 - 1.18 0.0394 - 1.00 0.0278 - 0.710 0.0234 - 0.600
S230	All Pass No. 18 Screen 10% Max on No. 20 Screen 85% Min on No. 30 Screen 97% Min on No. 35 Screen	0.0394 - 1.00 0.0331 - 0.850 0.0234 - 0.600 0.0197 - 0.500
S170	All Pass No. 20 Screen 10% Max on No. 25 Screen 85% Min on No. 40 Screen 97% Min on No. 45 Screen	0.0331 - 0.850 0.0278 - 0.710 0.0165 - 0.425 0.0139 - 0.355
S110	All Pass No. 30 Screen 10% Max on No. 35 Screen 85% Min on No. 50 Screen 90% Min on No. 80 Screen	0.0234 - 0.600 0.0197 - 0.500 0.0117 - 0.300 0.0070 - 0.180
S70	All Pass on No. 40 Screen 10% Max on No. 45 Screen 80% Min on No. 80 Screen 90% Min on No. 120 Screen	0.0165 - 0.425 0.0139 - 0.355 0.0070 - 0.180 0.0049 - 0.1250

SAE STANDARD - STEEL GRIT

SAE Size No.	SAE GRIT Tolerances	Screen Opening (Inch – mm)
G10	All Pass No. 7 Screen 80% Min. on No. 10 Screen 90% Min. on No.12 Screen	0.1110 - 2.80 0.0787 - 2.00 0.661 - 1.70
G12	All Pass No. 8 Screen 80% Min. on No. 12 Screen 90% Min. on No. 14 Screen	0.0937 - 2.360 0.0661 - 1.70 0.0555 - 1.40
G14	All Pass No. 10 Screen 80% Min. on No. 14 Screen 90% Min. on No. 16 Screen	0.0787 - 2.00 0.0555 - 1.40 0.0469 - 1.18
G16	All Pass No. 12 Screen 75% Min. on No. 16 Screen 85% Min. on No. 18 Screen	0.0661 - 1.70 0.0469 - 1.18 0.0394 - 1.00
G18	All Pass No. 14 Screen 75% Min. on No. 18 Screen 85% Min. on No. 25 Screen	0.0555 - 1.40 0.0394 - 1.00 0.0278 - 0.710
G25	All Pass No. 16 Screen 70% Min. on No. 25 Screen 80% Min. on No. 40 Screen	0.0469 - 1.18 0.0278 - 0.710 0.0165 - 0.425
G40	All Pass No. 18 Screen 70% Min. on No. 40 Screen 80% Min. on No. 50 Screen	0.0394 - 1.00 0.0165 - 0.425 0.0117 - 0.300
G50	All Pass No. 25 Screen 65% Min. on No. 50 Screen 75% Min. on No. 80 Screen	0.278 - 0.710 0.0117 - 0.300 0.0070 - 0.180
G80	All Pass No. 40 Screen 65% Min. on No. 80 Screen 75% Min. on No. 120 Screen	0.0165 - 0.425 0.0070 - 0.180 0.0049 - 0.125
G120	All Pass No. 50 Screen 60% Min. on No. 120 Screen 70% Min. on No. 200 Screen	0.0117 - 0.300 0.0049 - 0.125 0.0029 - 0.075

8. Metal Surface Profiles:

Grit and **shot** abrasives produce **different metal surface profiles**; therefore, **two profile** comparators should be specified. One for **grit** blasted profiles, **G**, and other for **shot** blasted profiles, **S**. When a **mix** will be used, then the reference profile comparator to be used should be **G**. In all instances the entire area should be blasted to SA 2 1/2 or SA 3 grade, according to BS 7079 and ISO 8503-1.

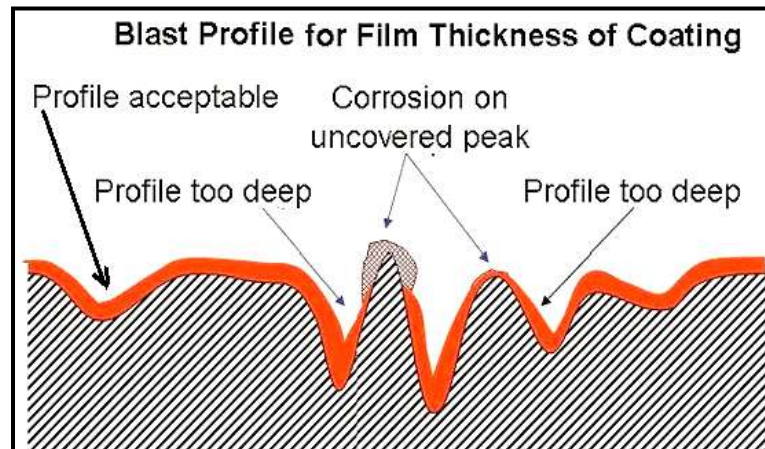

9. Blasting and Cleaning Equipment:

a) Wheelabrator: Sometimes known as centrifugal **blast units** are a mechanized way of preparing components for coating. They are ideal for long production runs on components, such as, pipe coating mills or metallic steelworks. The name is usually referred to by the number of “*wheels*”, where the Wheelabrator operates e.g., 6 wheels. These types of machines are also designed for special circumstances, e.g., pneumatically driven operator controlled equipment, for blasting decks or internal tanks.



b) Air Compressors: Are normal industrial or portable compressors **set at 100 psi**, considered to be the ultimate pressure for open blasting, since the air abrasive mix being constant is considered that blasting at 100 psi gives 100% efficiency. Using pressures over the 100 psi should be used more abra-

sives, more fuel, more effort from the operator, more work by the compressor, without a proportionate increase in the blasted area.

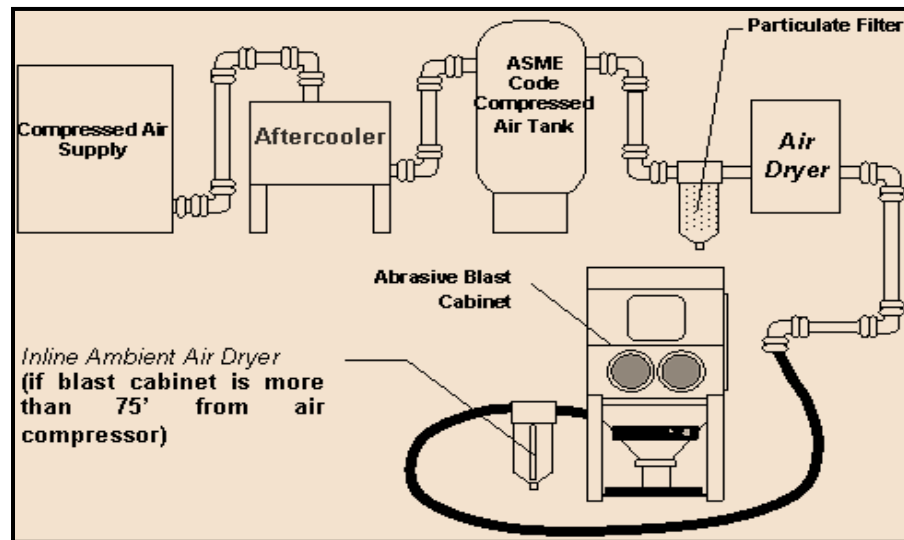

c) Blast Pots or Vessels: Supplied in various sizes and are selected according to surface preparation purpose, e.g., it would not be economical to recharge the pot every 5 minutes when blasting a large crude oil tank. The pots are charged with abrasives and when pressurized, the abrasive is blown by air pressure into the air stream, feeding a nozzle.

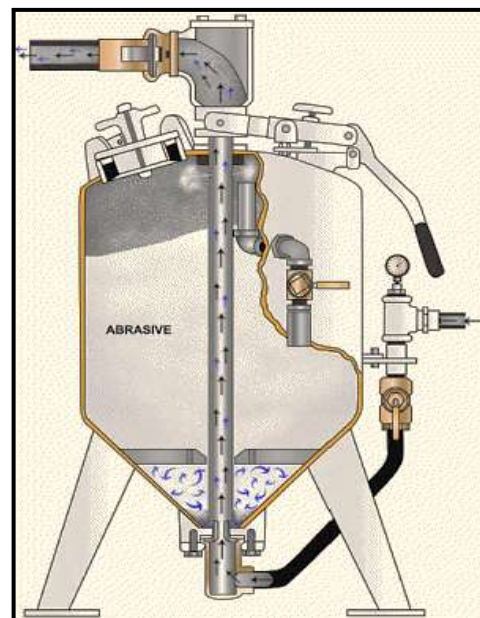

d) High Pressure Water Blasting: Also designated as **water jetting**, with pure water up to 30 000 psi through a rotating head giving alternating fan jets, at about 60 liters per minute. To work efficiently the jet head must be near the surface to be blasted, within 25 to 35 mm. As the distance increases the cleaning efficiency reduces. Using the jet head distance at approximately 250 mm, only loose and flaking material can be removed. There are 3 methods, as described below:



- **High pressure water plus abrasive injection:** This system operates at about **20,000 psi**, and uses abrasives, by gravity into the system or mixed as slurry. Marine growths, e.g., barnacles, are easily removed with this system and is often used in dry-docks on ship hulls.
- **Low pressure water plus abrasive injection:** Uses normal blasting pressures of **100 psi**, but with water as a propellant rather than air. The abrasive content is semi-soluble, e.g., Sodium Bicarbonate crystals, talc, chalk. This system is ideal for use on non-ferrous metals and some plastics. Sodium Bicarbonate is excellent for acidic or greasy situations.
- **Flame cleaning:** Not to be used on oil and gas plants, but it is an approved method of surface preparation, with photographic standards. The BS 7079, ISO 8501 (SS 05 5900) contains four photographs showing flame cleaning standards from the original rust grades A, B, C, D. The designation given is **AFI, BFI, CFI, and DFI**. There is only one flame cleaning standard for each rust grade.

e) Flame Cleaning Method: The operator slowly passes an oxygen/HC gas flame (Butane, Propane, Acetylene) over the area to be cleaned, (weld preheat torches) to burn and de oxidize the corrosion products and other contaminants, then, follows on with a power brush to remove the loose ash deposits. The primer can now be applied over the warm steel, reducing the need for addition of thinners. The paint can be 'wet out' better and pass into tiny cavities and irregularities on the surface. The heat also accelerates the drying process and keeps the steel above dew point temperature.

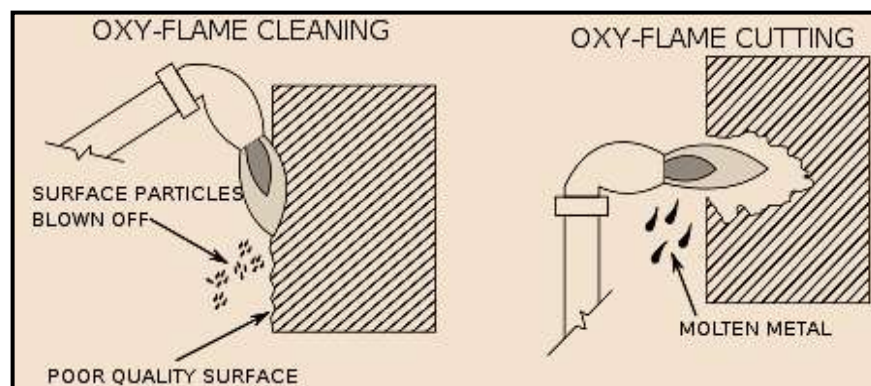

f) Pickling: Is a general term relating to the chemical removal of oxides (rust), from a metal substrate. The metals can be either dipped (totally immersed) in the pickling fluid or sprayed with it. Aqueous solutions of acids are used to convert the oxides into soluble salts, e.g., Sulphuric Acid produces Iron Sulphate salts, and is the most common acid used for economic and safety reasons.

The pickling process is commonly used for **stainless steels**, and uses chemical compounds such as paste, gel, spray or dipping, followed by a passivation process, that is a removal of exogenous iron or iron compounds from the surface of a stainless steel by means of a chemical dissolution, as nitric acid, causing a chemical reaction on the substrate, that is, rust inhibitive. The **ASTM 380** is a standard procedure for **pickling and passivation**.

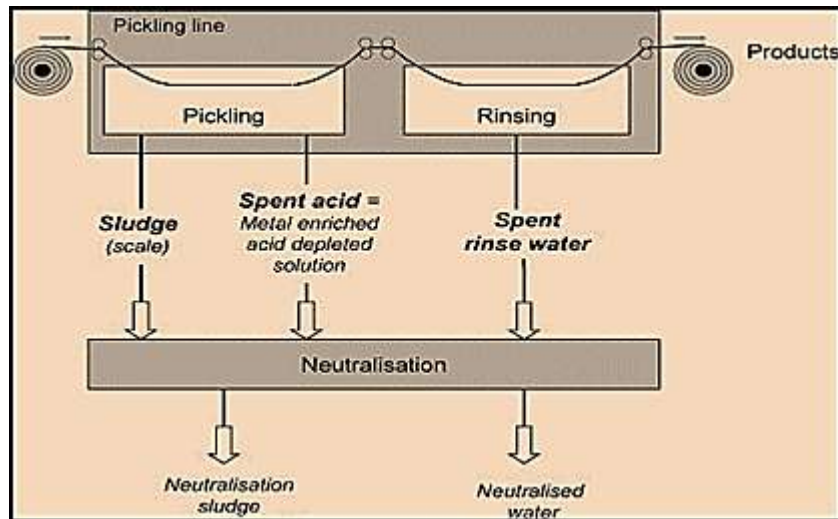

10. Interval Between Blasting and Painting:

After blasting, the steel surface is in vulnerable state, and **should be protected immediately**, with the **primer** or **paint system**, according to the convenience of the work, with the "*shop-primer*" specified. It is not recommended, and it is not good practice, leave the blasted surface exposed. However, in practical terms, it is necessary to observe the following considerations:

a) After Blasting: A range of up to **4.0 hours between blasting and painting** is quite safe, when the work is being carried out in **sheltered environment**, such as in warehouses with clean atmosphere and relative humidity around 70% to 75%.

b) Weather: Under conditions of **industrial atmosphere or sea**, or under **adverse weather** conditions, it is vitally important that the paint is applied as soon as possible, with maximum range **up to 2.0 hours**.

IV. COATING APPLICATIONS AND CONDITIONS:

1. Components of Coatings:

Not all coatings contain solvent and pigmented components. Commonly there are **solvent-free** (with 100 percent solids), **pigment-free coatings**, but **there is not resin-free** coatings. All organic coatings consist of three basic components: Solvent, Resin and Pigments.

The chemical formulations are designated as; **group solvent, resin and pigment components** and commonly fall into **two** general categories:

a) First Category: combines the solvent and the resin together. The solvent portion is called the “*volatile vehicle*” and the resin portion is called the “*nonvolatile vehicle*”. The combination of the solvent and the resin, where the resin is dissolved in the solvent, is called the “vehicle.” commonly

b) Second Category: is the pigment. Pigments are additives that impart specific properties to the coating and are subdivided into two general categories: color, inert-reinforced. When a coating is applied, the **solvent evaporates** during the curing process, **leaving only the resin and the pigment components** on the substrate, sometimes called the “*coating solids*” and they form the protective film for corrosion protection.

c) Solvent: Organic solvents for coatings are formulated to perform three essential functions:

- (1) dissolve the resin component;
- (2) control evaporation for film formation;
- (3) reduce the coating viscosity for ease of application.

In general, less soluble resins require either more solvents or stronger solvents to dissolve. The terms “**solvents**” and “**thinners**” are often used interchangeably. The usage of the term “*thinner*” is most often associated with the coating applicator adding a thinner to a coating container (normally about **1 pint** thinner to **1 gallon** of coating) to reduce the viscosity for ease of application. Adding thinner to a coating in the field is often called “*field thinning*.”

The manufacturer’s **data sheet** commonly specifies a thinner to be used. Use of thinners not recommended by the manufacturer can cause application problems or premature failures such as separation of components, coagulation, too fast or too slow drying, changes in flow characteristics, or lifting of previous coats. The following **common thinners** are used with the associated generic coating types:

Thinners	Coatings
Mineral spirits; Aromatics (benzene, xylol, toluol); Ketones (MEK, MIBK); Alcohols (isopropyl); Water.	Oils and alkyds; Coal tar epoxies, alkyds, chlorinated rubbers; Vinyls, epoxies, urethanes ; Phenolics, inorganic zincs ; Acrylics, some inorganic zincs.

Solvents produce vapors that are heavier than air and will collect in tank bottoms or confined areas. The ketones have the lowest flashpoint of the organic solvents; however, any solvent in the right combination with air can **create an explosive** combination.

Local air quality control districts regulate the amount of **volatile organic solvents** (VOC) in coatings. As the coating cures, VOCs evaporate into the atmosphere and react with sunlight and air pollutants to form **ozone**, a known **human health hazard**.

d) Resin: The resin (**also called binder**) is the film forming component of a coating, typically a high molecular weight solid polymer that forms large repeating molecules in the cured film. The primary purpose of the resin is **to wet the pigment particles** and bind the pigment particles together and to the substrate. The various types of resins formulated and manufactured with **distinct properties** are:

- ✓ Mechanism and time of curing;
- ✓ Performance in service exposure type;
- ✓ Performance on substrate type;
- ✓ Compatibility with other coatings;
- ✓ Flexibility and toughness;
- ✓ Exterior weathering;
- ✓ Adhesion.

e) Pigments: are chemical additives to the coating formulation that impart specific properties to achieve the desired film properties. The following properties are:

- ✓ **Color:** Natural earth pigments (kaolin clay, magnesium silicate, calcium carbonate) provide color stability from ultraviolet (UV) sunlight deterioration. Natural earth pigments are more **UV stable** than synthetic organic pigments.
- ✓ **Opacity:** Titanium oxide hides the substrate or previous coating color and protects the binder from UV sunlight deterioration.
- ✓ **Wet paint:** Silica and talc control viscosity, wet film leveling, and settling but provide little hiding (opacity) power.
- ✓ **Weather and moisture resistance:** Aluminum leafs and micaceous iron oxide (MIO) increase barrier thickness and force moisture to detour around these plate-like additives.
- ✓ **Corrosion resistance:** Pigments added to inhibitive (primer) coatings impede corrosion of ferrous substrates. Past formulations included chromate and lead pigments, but they are seldom used today because of environmental and health concerns. The following chromate and lead pigments are rarely used in current coating formulations:
 - Red lead;
 - White lead;
 - Basic lead silicon-chromate;
 - Strontium chromate
 - Zinc chromate;

f) Slip Resistance: Aluminum oxide or mineral aggregate is **added** in the formulation or applied to the wet film to achieve non-slip surfaces. Aluminum oxide is the better choice because mineral aggregate may be crushed under weight, providing moisture access to the substrate, and promoting further coating degradation and corrosion.

2. Coating Types: The following are **three basic types** of coatings:

a) Barrier: A coating that forms a **barrier** between the metal surface and the electrolyte and electrically isolates the metal. Examples are the epoxies and coal tar epoxies.

b) Inhibitive: Pigment in a coating primer slightly **soluble** in water forms a chemical inhibitor and effectively interferes with the electrolyte. Examples are red lead and chromate primers (no longer acceptable).

c) Galvanic: Zinc-rich primer coatings provide galvanic or cathodic protection to ferrous metal (zinc sacrifices to protect the ferrous metal). Galvanic coatings are effective only if applied directly to bare metal.

3. Coating Layers:

A coating is **not a finished application** until it has been successfully applied to the steel substrate and cured. As described above the coating performance is affected during application and curing by temperature, relative humidity, and dew point, defined by the number of coats to be applied. The following terms provide a description of the coating layers:

a) Stripe Coat: Is applied to prepared bare metal edges, bolt heads, welds, corners, and similar edges before the prime coat is applied. Stripe coats are necessary because, as the coating dries, tensile forces are created at the edges, forcing the coating to pull away from the edge in both directions, resulting in a thinner coating at the edge.

b) Prime Coat: Is applied over the entire surface to be coated, including the stripe coated areas. The prime coat must cover the peaks of the surface profile. The consequence of not covering the peaks is pin-point rusting.

c) Intermediate Coat: Is applied over the primer to provide additional protection or to seal the primer. Multiple intermediate coats can be applied to build up the film thickness.

d) Topcoat or Finished Coat: Is applied over the primer or intermediate coat for color aesthetics or to protect the underlining coating material from sunlight and UV light.

e) Base Coat: is a term often used to describe a self-priming material applied in multiple coats. The term, "base coats," is **used instead of "primer", "intermediate", and "topcoat"**, because all three coats are of the same material. Base coats are not normally considered sunlight or UV resistant.

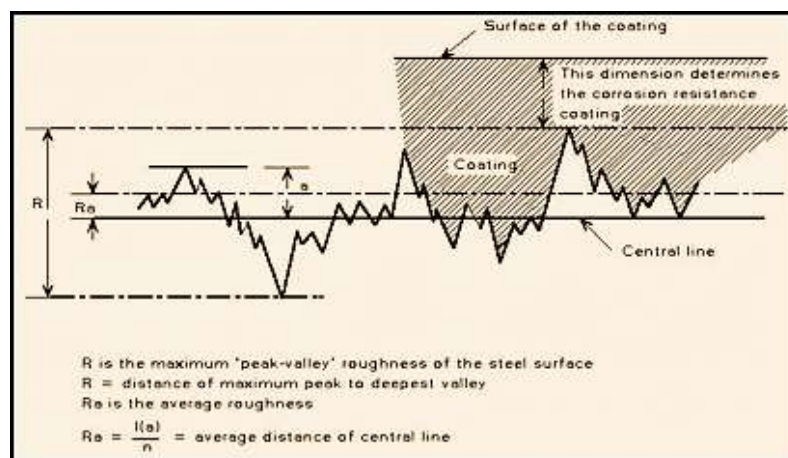

4. Environmental Conditions:

Cold weather, high humidity, water, fog, frost, mist, rain, ice, and snow are some of the **environmental** factors detrimental to the **performance** of coatings. Coatings should be applied under optimum environmental conditions, but weather can abruptly change. The following environmental factors that require monitoring during coating application and the cure period are:

a) Ambient Temperature: During the application of coatings, specifications require the air and surface temperature to be **75 °F (24°C)**. Exceptions are made for cold weather applications. Some epoxy coatings applied below **50 °F (10°C)** will not cure, and curing will not proceed even if temperatures exceed 50 °F at a later time. As a general rule-of-thumb, the coating to be applied should be between **40°F (4.4°C)** and **95°F (35°C)**, depending on the coating material.

b) Surface Substrate Temperature: The specifications require that coatings should be applied when temperatures are minimum at **50°F (10°C)** or higher and within the manufacturer's upper limit or according to the manufacturer's instructions. In general, industry practices require a surface temperature between about **40°F (4.4 °C)** and **125 °F (52°C)**.

c) Relative Humidity: The specification does not indicate limits for relative humidity, but the coating should be applied within the manufacturer's recommended humidity range. General industry practice requires a **maximum** relative humidity of about **80 to 85 %**, except for those coatings that are less moisture sensitive or are moisture cured. However, as a general rule-of-thumb, the closer to the optimum relative humidity, the more likely to achieve the designed service life.

d) Dew Point: Determines if moisture will form on the ferrous substrates by condensation or if moisture will evaporate. Moisture will form on ferrous substrate surfaces when the dew point is higher than the surface temperature. Specifications require that the **ferrous substrate** temperature be a minimum of **5°F higher** than the dew point when coatings are applied. Dew point is a function of ambient temperature, substrate temperature, and relative humidity. All three of these environmental conditions must be known to determine the dew point.

e) Wind: The wind becomes a factor when it overcomes the spraying operation and carries coating particles away from the intended surface, known as airborne overspray, resulting in premature drying of the coating before reaching the intended surface. Lower or higher **DFT** (dry film thickness) at the application point, may carry the spray to other surfaces not intended to be coated.

5. Coatings Application Methods:

The coatings are either **single-component** or **multiple-component**. Before application, the coating materials require mixing to make the paint homogeneous and uniform. Liquids and pigments of different densities may separate, settle, or form a skin within the shipping container. Most multiple components are two-components, such as epoxies, that contain a resin and a hardener, and can be in equal proportions or unequal proportions, determined by volume. The components must be ship-ped in separate packages, regardless of the proportion volume, in enough quantities to hold all the components for mixing. Below is a description of application, equipment and methods.

a) Brush: For steel substrates, **brushes** are normally used for **small** areas, repair areas, and crevices or gaps. There two general types of brushes: wall and sash. They come in various sizes, shapes, and brittle types. Wall or oval brushes are well suited for stripe coating irregular surfaces such as edges, corners, bolt heads, and similar areas. Sash brushes are better suited for coating narrow areas.

c) Rollers: Consist of two general parts; **cover and core**. The cover is the section that applies the coating and will vary in diameter, length, fabric type, and fiber length. Rollers are normally used for **large flat** areas (horizontal and vertical surfaces); Rollers are available in several **materials**, e.g., mohair, lamb's wool and sponge, and several different designs, jumbo rollers for large areas, radiator rollers for confined spaced, pressure fed rollers to avoid recharging, and extension rollers which increase access. Curved rollers are supplied for pipe work and roller pile material is even made in glove form for areas of difficult access.

d) Spray: Paint spray equipment can be divided into two distinctly different types:

- 1) **Conventional Spray:** Can be subdivided into three different types of equipment which all have the same atomization mechanism.
 - **Suction feed:** The paint container is underneath the gun, usually aluminium about one litre capacity, and the paint is drawn up by venturi principle to the gun.
 - **Gravity feed:** The paint container is above the gun and paint feeds to the gun by gravity.
 - **Remote pressure pot:** Supplied in several sizes and have the advantage of having a much greater capacity than the above and much bigger areas can be painted before refilling is required.
- 2) **Airless Spray:** The fluid (paint) is pressurized by means of a pump. Electric motor pumps and hydraulic pumps are also used, but the most common is the pump operated by compressed air. These units operate by increasing the compressed air inlet pressure by a stated ratio, that is, **35:1**, by means of two pistons on a common shaft. For instance, if an air driven piston has a surface area of **35.0 square inches** and is exposed to a pressure of **100 psi**, a piston at the other end of the shaft, with a surface area of **1.0 square inch**, will exert a pressure of **3500 psi**.

e) Electrostatic Spray: Both liquid and powder paints can be electrostatically applied. Powder paints in general are charged electrostatically by **spraying the powder** through an area of **ionized air**. In either case the component to be coated is earthed into the same circuit and thus becomes negatively charged. The coating material is positively charged and is attracted to the component. As the coating thickness increases it has an insulation effect and the coating material is then drawn to other charged areas.

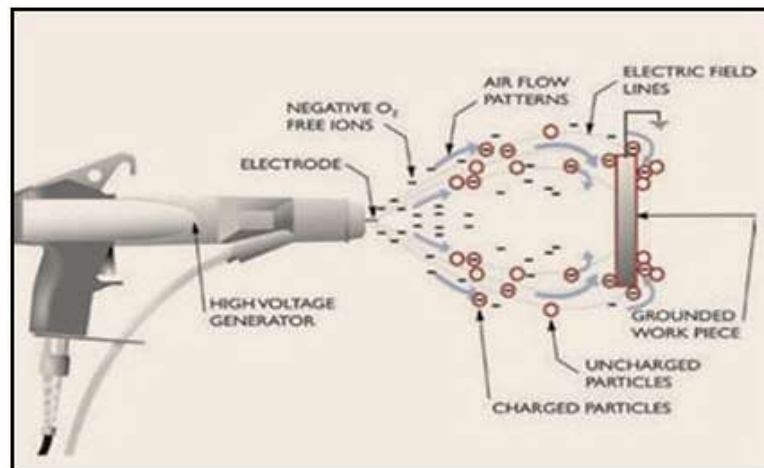

6. Other Metal Coating Processes:

- a) **Anodizing:** Is an electrolytic method of coating which results in the formation of a dense oxide. The component is **immersed** in a weak acid bath and the oxidation is induced electrically.
- b) **Electroplating:** Is done by electrolytic deposition. If a current is released from an item into a metal salt solution, through a cathode, the metal salts ionize and **deposit the metal ions** on the cathode bar.
- c) **Calorizing:** Is a coating with aluminium that has a melting point of **625°C**. One way of calorizing a component is to **dip** it into molten **aluminium**. The resulting exothermic reaction is so severe that it alloys the

aluminium with the steel. Calorizing can also be done by immersing a component in a mix of fine sand and aluminium powder and heating.

d) Phosphatizing: Also called phosphating or phosphate conversion coating, is a phosphate containing solution to form a **nonreactive** zinc phosphate layer on the **surface** and inhibit the formation of zinc oxides. The treatment will slightly etch the surface, producing an anchor profile for the coating primer. Application is by immersion, spray, or soft bristle brush. The solution is left on for about **3 to 6 minutes** and rinsed off with potable water. Coloration is returned to the galvanized surface after washing so that any missed areas will be visible and can be retreated. Allow the surface to air dry before coating.

e) Sherardizing: Is a process of galvanization, also called vapour galvanizing or dry galvanizing. Is a thermal diffusion of zinc at approximately at **400 °C (752 °F)** into the surface of metal substrates, forming a zinc iron alloy (the hardest of all zinc applied coatings). Nuts and bolts and other similar components are coated with this method. The components can also **be tumbled** in the powdered zinc. The impact fuses the zinc onto the components causing an effect, called "*cold welds*", the powder onto the metal.

f) Chroming: Is the introduction of chromium (gaseous diffusion) into the surface of a component to enhance corrosion and oxidation resistance at high temperature (approx. 900°C). Chroming can protect components from corrosion, wear, abrasion and oxidation in engineering environments. Chromide diffusion coatings are still widely applied to hot section industrial gas turbine blades and vanes to protect them against high temperature oxidation and hot corrosion.

g) Thermal Spraying: Zinc and aluminium are the most commonly used metals for spraying, also providing cathodic protection to the steel, and both metals have a reasonable low melting point. Thermal spray with **zinc** performs far **better** than aluminium in rural areas and alkaline environments. Thermal spray with **aluminium** is considered to be superior to zinc in acidic environments and because of its higher melting point, is more widely used on high temperature surfaces such as exhaust stacks, compressor exhausts, etc. It is specified for use on surfaces with working temperatures of up to **540°C**. Application of metal sprayed coatings can be carried out by any of the following methods:

- **Powder system:** Powdered metal is fed into a heat source (usually butane or propane and pure oxygen burning) and **propelled onto** the substrate. Using this method a relatively low proportion of the metal powder is actually deposited on the substrate.
- **Electric arc system:** This method is ideal for production line type facilities such as gas bottle production and lamp standards, where components are of a uniform shape and the process can be mechanized. As in a welding process the metal (to be sprayed) acts as an electrode in a circuit and the electrode melts. The molten metal is atomized and blown onto the component by means of a heated air jet. This system gives a superb fine grain finish.
- **Wire and pistol system:** Is the most common and widely used method for site application of metal spray. The metal wire, of a very high degree of purity, greater than 99.5%, is driven through a gun by means of two knurled wheels powered by compressed air. The fuel gases used are butane/propane and pure oxygen.

h) Galvanizing: Is the coating of components with zinc. Many components both for offshore and onshore use are galvanized. Galvanizing can give protection to steelwork for periods of **up to 60 years** dependent on exposure conditions. The components are chemically cleaned (acid), washed and fluxed, then totally

immersed in a vessel containing molten zinc at **approximately** at **450 °C (842 °F)**. When drawn out, the zinc solidifies at an average thickness of approximately **100 µm**.

- **Galvanizing methods:** There are **several** methods to use when applying zinc. The table below provides the most common methods for galvanizing and includes manufacturing processes, specification references, zinc coating thicknesses, and typical applications for each method:

Method	Process	Specifications	Thickness	Typical application
Electro-galvanizing	Electrolysis	ASTM A 591	Up to 0.14 mil	Interior service exposure: appliance panels, studs, and acoustical ceiling members
Zinc plating	Electrolysis	ASTM B 633	0.2 to 1.0 mil	Interior or exterior service exposure: fasteners and hardware items
Mechanical plating	Peening	ASTM B 695	0.2 to 4.0 mil	Interior or exterior service exposure: fasteners and hardware items
Continuous galvanizing	Hot-dip	ASTM A 653	Up to 4.0 mil	Interior or exterior service exposure: roofing, gutters, culverts, automobile bodies
Hot-dip galvanizing	Hot-dip	ASTM A 123 ASTM A 153	1.4 to 5.0 mil	Interior or exterior service exposure: nearly all shapes and sizes, ranging from nails, bolts, and nuts to large structural items
Thermal Spraying	Hot zinc spray	AWS C2.2	3.3 to 8.3 mil	Interior or exterior service exposure: items that cannot be galvanized by other methods because of their size and shape or because galvanizing must be performed onsite.
Zinc-rich painting	Brush, roller, airless, or conventional spray	Varies with owner's or manufacturer's specifications	0.6 to 5.0 mil per coat	Interior or exterior service exposure: Items that cannot be galvanized by other methods because of their size and shape or because galvanizing must be performed onsite. Aesthetics (color).

7. Coating Types and Specifications:

a) Acrylics: Is a fast-drying paint containing suspended pigments in an **acrylic polymer emulsion**, specified for atmospheric exposures as **a primer or topcoat**. Acrylics cure by coalescence and has an excellent color and gloss retention.

b) Alkyds: Alkyds are **normally natural oils** (soya, styrenate) that have been chemically modified to improve cure rate, chemical resistance, and hardness. Phenolic modified alkyds are specified as a **primer**, and silicone alkyds are specified for atmospheric service exposures, but not suitable for alkaline (concrete or masonry) surfaces or environments. Alkyds cure by air oxidation of drying oils.

c) Bituminous: Is a relatively soft coal containing a **tar like substance** called bitumen. The coatings have good moisture barrier resistance and fair to good chemical resistance, but not resistant to solvents. Bituminous coatings cure by solvent evaporation.

d) Epoxy, Amine: Amine epoxies are **two-component coatings**, catalyzed (hardened) by an **amine** curing agent to produce a bonded, chemical **resistant to alkali, acid, and solvents**. Epoxy resins, also known as **polyepoxides**, are a class of reactive **prepolymers** and **polymers** containing epoxide groups, however, more sensitive to moisture and temperature. This type of coating (or painting) is specified for **burial and immersion service exposures**, but may fade and chalk in direct sunlight.

e) Epoxy, Polyamide: Polyamide epoxies are also **two-component coatings** catalyzed by a **polyamide** curing agent to produce superior **resistance to water and salt solutions**, however, do not provide the chemical resistance as the amine epoxy. Polyamides are also specified for **burial and immersion service exposures**, but have a greater flexibility than the amine epoxies.

f) Epoxy, Coal Tar: Coal tar epoxies are generally an **amine or polyamide epoxy** modified with **coal tar resin** to produce a high-build film that has good chemical resistance and excellent water resistance. This product has a tendency to become **brittle with age** and delaminate between coats or beneath repair patches, also specified for **burial and immersion service exposures**, but will fade and chalk in direct sunlight. Coal tar epoxies cure by chemical reaction.

g) Epoxy, Fusion-Bonded: Fusion bonded epoxies (commonly called **powder coatings**) are complete coatings in **powder form**. There are two application methods, **fluidized-bed and electrostatic**.

- **Fluidized-bed method:** The metal items are **preheated to 204 to 260 °C (400 to 500 °F)**, and immersed in the powder-epoxy solution, to produce a particle size distribution approximately **10 to 100 µm**, usually **0.30 to 0.63 mm** (12 to 25 mils).
- **Electrostatic method:** The epoxy powder particles are charged with high voltage, and the metal item is then sprayed through an area of ionized air, also expecting a particle size distribution approximately **10 to 100 µm**.

h) Inorganic Zinc Primers: Inorganic zincs are **primers** that incorporate a high loading (pounds per gallon) of **metallic zinc** for pigmentation (hence, the term “*zinc-rich*”) and are either solvent or water based. Depending on the solvent and resins used, the coating may be a zinc-rich epoxy or urethane.

These coatings are **exclusively primers** because they provide **galvanic or cathodic protection** to steel substrate, specified for atmospheric and immersion service exposures. Suitable topcoat application requires special skills and knowledge to avoid pinholes. Zinc coatings to fraying surfaces or heated treated metalwork are specified for **ASTM A 325 and ASTM A 490** fasteners. Inorganic zincs cure by either reaction to water (solvent reducible) or reaction to carbon dioxide (water reducible).

i) Organic Zinc Primers: Organic zincs are **primers** that incorporate a high loading (pounds per gallon) of metallic zinc for pigmentation with a wide variety of solvents and resins. Depending on the solvent and resins used, the coating may be a zinc-rich alkyd, drying oil, epoxy, or moisture-cured urethane. These coatings are **exclusively primers** because they provide galvanic protection to steel substrate or used to repair damaged galvanized coatings on steel substrates.

j) Polyurethane: Is a **subclass of urethane**. A two-component polyurethane is created by chemically combining a polyisocyanate and a polyol to produce an isocyanate that has a two mode cure mechanism of solvent evaporation and chemical reaction. Polyurethanes for **top coating** are compatible **amine and pol-**

yamide epoxies to protect against direct sunlight or UV and to provide specific colors. Polyurethanes are specified for atmospheric and partial or fluctuating immersion service exposures.

k) Urethane: Is a colorless or white crystalline **compound**, $\text{CO}(\text{NH}_2)\text{OC}_2\text{H}_5$, used in organic synthesis and specific service environments and application requirements. Urethane painting basis, cures from moisture in the atmosphere and can be **applied** to damp surfaces that do not have free moisture present. These urethanes are formulated with various pigmentations and specified with several combinations to suit the intended service exposure, for atmospheric, burial, and immersion exposures.

8. Special Coatings:

Some special coatings may include **fluoropolymers**, used principally for salty or sea environments and corrosion-resistant surfaces; silicone resin used as thin film or in combination with metal or ceramic frits for high temperature applications, abrasion-resistant corrosion service; chlorinated rubber, neoprene, and other special coatings formulated for high temperature applications in a gloss formula, as aluminum base, VOC compliant, to withstand temperatures of 500°F, 850°F, 900°F, 1200°F and 1500°F.

Protective **tapes and wraps** are commonly used almost exclusively for protecting pipelines and tubular structural shapes from below-grade or (underground) corrosion substrate. The substrate can be either primed bare metal or another tape layer. The tape backing or outer layer is a monolithic polymeric material designed for tensile strength, mechanical strength, temperature, and electrical resistance.

Typical tape backings include **polyvinyl-chloride**, polyethylene, polyolefin, butyl, ethylene propylene diamine monomer (EPDM), and, occasionally, nylon or glass fibers. The most used protective material used for linings are Butyl or EPDM vulcanized rubber-backed tapes, that have excellent flexibility, mechanical and moisture resistance.

9. Coating Characteristics:

All coatings should be applied to provide good aesthetics or a pleasing appearance, even when used for corrosion protection or for any other purpose, contain a film-forming material. This material may be **organic** or **inorganic** and should form a hard, impervious film, a soft porous film, or combinations.

a) Binder: When the film-forming material **contains pigments**, it is called a binder (resin plus pigment). The binder (or resin) is the **film-forming element** of a coating or adhesive. It provides adhesion to a substrate, and binds pigments together and also determines important properties such as durability, flexibility and gloss. The binder holds the pigment particles together to the substrate.

b) Vehicle: When the binder is dissolved in a **solvent** to make it liquid, the combination (solvent, binder, and pigment) is considered to be a vehicle. The term **vehicle** comes from the ability to transport and apply the liquid to the surface being coated. Once on the surface, the solvent evaporates and the vehicle becomes a pigmented binder system.

c) Properties: The viscosity, rate of solvent evaporation, and consistency of the wet coating are most important during application, which binders form **reaction** with oxygen from the air (oxidation), evaporation of the solvent from the vehicle (solvent evaporation), or chemical crosslinking (polymerization), UV (ultra-violet rays), and light-resistant properties.

d) VOC- Volatile Organic Compounds: Are emitted as **gases** from certain solids or liquids. VOCs include a **variety of chemicals**, some of which may have short- and long-term **adverse** health effects. Examples include: paints and lacquers, paint strippers, cleaning supplies, pesticides, office equipment, such as copiers and printers, correction fluids and carbonless copy paper, graphics and craft materials, including glues and adhesives, permanent markers, and photographic solutions.

10. Resin Types and Application Properties:

a. Natural Resins: Natural resins are derived from tree exudations, fossilized vegetable remains, or insect secretions. Natural resins derived from tree exudation may be named after the region from which they originated; this accounts for some exotic names such as Kauri, Batu, Sandric, and others. Natural resins generally are cooked with drying oils to make varnishes with faster drying rates, higher gloss, and harder films than can be attained from the oil alone.

b. Synthetic Resins: Are generally by-products of chemical refining or manufacturing processes. These resins are man-made, refined and modified for coatings use, used as film formers for protective and decorative coatings. Compared with the natural resins, synthetic resins have obtained widespread use in a variety of different service environments as corrosion-protective coatings.

c. Alkyd and Polyester Resins: Are derived as a reaction product of polyhydric alcohols and polybasic acids. Alkyds use a polybasic acid derived from semidrying or drying oil so the resin formed can undergo auto-oxidation at any temperature. This definition also includes the polyester resins, of which alkyds are a specific type. Because of the presence of the drying oil, alkyd coating systems have limited chemical and moisture resistance, cannot be used in highly chemical environments (acid or alkali), and are not resistant to immersion or near immersion condensing conditions.

11. Alkyd Modifications:

Alkyds are perhaps the most widely used industrial protective coating by virtue of their ease of application, relatively low cost, color, stability, and good weather ability in most atmospheric environments; therefore, it is reasonable to assume that coating formulators would seek to improve properties of the drying oil alkyd by modification with other resin types.

a) Phenolic: Improves gloss retention, water, and **alkali** resistance. Phenolic alkyd resins have performed satisfactorily in **water** immersion, a service in which non phenolic modified alkyd resins are not suitable.

b) Vinyl: Is commonly formulated as universal **primers**, which generally can be top **coated** with most generic type intermediate and topcoats. The alkyd constituent improves adhesion, film build, and solvent and thermal resistance; the vinyl modification enhances **re-coatability** and chemical and moisture resistance. These coatings frequently are used as shop primers or as tie coats between different generic coatings (e.g., over inorganic, zinc-rich primers or between alkyd primers and epoxy topcoats).

c) Silicone: Is perhaps the most widely promoted **modification** for corrosion-protective coatings. A silicone intermediate is **added** to the alkyd resin in quantities up to **30%** to provide polymers with greatly improved durability, gloss retention, and heat resistance. Moisture resistance is greatly **improved** by the silicone modification, and this type of paint is used extensively as marine and maintenance paint.

d) Epoxy: Produce coatings with improved **chemical and moisture-resistant** properties. Epoxy ester coatings are similar to alkyds, and they are used when improved performance is required. Epoxy esters result from the direct esterification of an epoxy **resin** and a fatty acid, such as a vegetable oil or rosin. The resulting epoxy ester resin is prepared by reacting it with drying oil by heating in the presence of an esterification catalyst. The same drying used to prepare alkyds also is used to prepare epoxy esters.

- **Polyamine epoxy coatings:** Generally have excellent alkali resistance and good moisture and water resistance. These epoxies are the most **brittle and the least flexible** and have a strong tendency to degrade on UV light exposure, resulting in chalking.
- **Amine epoxy coatings:** Are commonly used widely as tank lining systems for the protection of steel and concrete in water and aqueous chemical immersion service. Because of their high cross-link density, amine-cured epoxies are the epoxies of choice in atmospheric or immersion environments of high and low hydrolyzing chemicals.

e) Urethane: Is commonly reacted with isocyanides to form a so-called **uralkyd or urethane** oil coating. The isocyanate reaction decreases the drying time of the coating and provides enhanced resistance to chemicals, moisture, weathering, and abrasion. The isocyanate reactant can be either **aromatic** (containing the benzene ring) or **aliphatic** (straight chain or cyclical) hydrocarbons, as described below:

- **Aromatic polyurethanes:** Are prone to darkening and yellowing on exposure to sunlight because of the chromophoric nature of the benzene ring.
- **Aliphatic polyurethanes:** Do not contain the benzene ring, then, do not yellow or darken and are always preferred for exterior use.

Other urethanes crosslinking copolymers are:

- **Acrylic urethanes:** Are perhaps the most widely used urethanes for corrosion protection and atmospheric service. When properly formulated, these materials have excellent weatherability, gloss, and color retention and good chemical and moisture resistance.
- **Polyester urethanes:** Form relatively hard, chemical-resistant poly films, as have great chemical and moisture resistance; but are not as flexible and tough as the acrylic urethanes.
- **Epoxy urethanes:** Considerably more expensive than conventionally cured amine or polyamide epoxies. However, the epoxy addition induces a tendency to chalk, results in a less chemical and moisture resistant polymer than the conventionally cured epoxy coating.
- **Vinyl urethanes:** Combine abrasion resistance with toughness, flexibility, and chemical resistance of the vinyl. These urethane coatings are used when flexibility and abrasion resistance are important, however, subject to some chalking and fading on exterior exposure.

Note: To prevent **bubbles** and voids in finished paintings, as a result of the carbon dioxide gas inclusion, all **polyurethane** coatings must be applied relatively thin **0.038 to 0.05 mm or 1.5 to 2.0 mils**, per coat).

f) Styrene-Acrylic: Is a product co-polymerized with **lower** alkyl-acrylates, characterized by a high and good gloss retention. When properly formulated, can **dry** quickly and develop good film hardness. Styrene-

acrylic paintings are used primarily in interior house or as coatings for mild industrial service conditions, but do not have good moisture resistance. Styrene-acrylic is also used as concrete block fillers.

g) Latex Emulsions: This product has gained in popularity because of their **ease** of application and cleanup and their good **color** retention and durability on **exterior** surfaces. One hundred percent acrylic copolymer formulations have been developed to provide good protection as complete water-based systems (primer, intermediate, and topcoat) on blast-cleaned structural steel.

h) Bitumens: Commonly used in the coatings industry as **coal tar and asphalt**. These materials are distinctly different physically and chemically; but in appearance they are essentially identical black, thermoplastic, tar materials. Coal tar enamels, or pitches, are derived from the coking of coal. When coal is heated in the absence of air to a temperature of approximately **1093° C (2000° F)**, it decomposes partially into a gas and a coke.

12. Curing and Hardening Driers:

Driers are materials that promote or **accelerate** the **curing** or hardening of drying oil paints. Oil-based paints by auto-oxidation affect considerably the presence of certain catalysts due temperature. Driers act as a catalyst to aid in both surface and through drying of drying oil paints. Driers are considered metallic-organic materials and can be classified as **surface driers and through driers**.

- **Surface driers:** Are compounds as lead, cobalt, zinc, or manganese. The use of these materials will cause a surface of the drying oil paint to **rapidly set to a near solid**. The metal constituent is usually a naphthenate derived from naphthenic acid.
- **Through driers:** Are metallic-organic compounds of lead, cadmium, zinc, or zirconium. When used in conjunction with surface driers, through driers help cause **an auto-oxidative cross-linking** through the cross-section of the film.

13. Painting Procedures:

The surface preparation, **priming** and application of **finish coats** should be used along with shop priming and surface treatment specified in other procedures, as described above. Commonly, for a multi-layer coating scheme, the paints can be classified in:

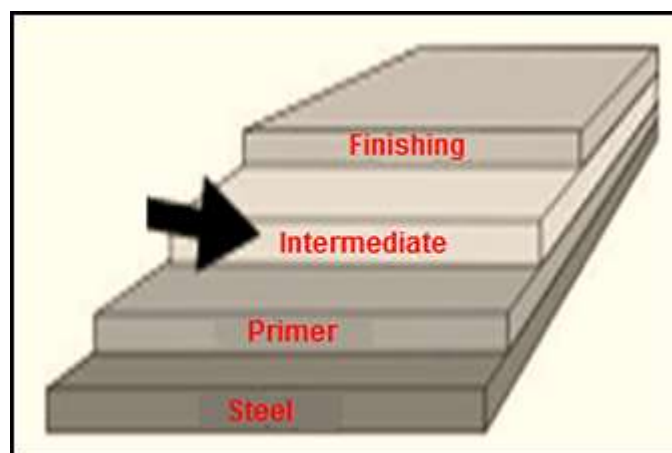

- a) **Primer:** responsible for adhesion to the substrate, schema may or may not contain pigments, corrosion inhibitors. Bottom or bottom finishes (dual function).
- b) **Intermediate Paint:** provide a better thickness to the coating scheme. The products are cheaper compared with primers and help to protect the substrate, also known as Tie Coat.
- c) **Topcoat or Finish Paint:** Responsible for protecting the complete system against the environment and give the desired finishing color.

14. Relative Humidity and Dew Point in Job Site:

There are two basic methods of measuring **Relative Humidity** and **Dew Point Temperatures**. One is with a **sling psychrometer** and the second is with **electronic meters**.

- a) **Sling Psychrometer:** The **sling psychrometer** measures two parameters, Dry Bulb (ambient temperature) and Wet Bulb. However, it is strongly suggested that electronic meters be used instead of **Sling Psychrometers** for the best accuracy. Consult ASTM E 337, Standard Method for Measuring Humidity with a Psychrometer (The measurement of Wet and Dry Bulb Temperatures).
- b) **Electronic Meters:** Also **measures**, Wet Bulb, Dry Bulb, Relative Humidity, Dew Point, and Surface Temperature, such as the TQC Dew check. The ΔT between the **surface** temperature and dew point can be calculated. The electronic time and date stamp data can be downloaded to a computer.
- c) **Dry Bulb Temperature (DBT):** Also called **ambient temperature** is the temperature of the air. This is the temperature that you would get in the shade and not the temperature in direct sun.
- d) **Wet Bulb Temperature (WBT):** Measures the temperature that results from **evaporation**. It is directly related with relative humidity. When moisture evaporates, it cools the environment, reducing the temperature slightly. The WBT will vary with Relative Humidity (RH).
- e) **Relative Humidity (RH):** Is the measure of how much **moisture is in the air** divided by the amount of moisture. The amount of moisture the air can hold is dependent on the atmospheric pressure. When the air is **100% saturated**, evaporation will stop and the Dry Bulb Temperature will be equal to the Wet Bulb Temperature, that is:

$$\text{DBT} - \text{WBT} = 0, \text{ then } \text{RH} = 100\%$$

Typically, most project requirements specify a Relative Humidity **below 85%** and a minimum 5 °F (-15 °C) between the surface temperature and the **dew point**. When the Relative Humidity is around **50%** and the Dew Point spread is 10 °F to 15 °F (-12 °C ~ -9 °C), accuracy in the tests are not critical.

- f) **Dew Point:** Is a water-to-air saturation temperature and is always associated with Relative Humidity. A Relative Humidity of **100%** indicates the Dew Point is equal to the current temperature and that the air reached its maximum water saturation. When the Dew Point remains constant and temperature increases, the Relative Humidity decreases.

V. COLOR SYSTEMS:

Henry Albert Munsell (1858 - 1918) was an artist and professor of art at the Massachusetts Normal Art School (now Massachusetts College of Art and Design, or Mass Art), wanted to create a “*rational way to describe color*” that would use decimal notation instead of color names (which he felt were “*misleading*”), which he could use to teach his students about color. He first started work on the system in 1898 and published it in full form in “*A Color Notation* in 1905”.

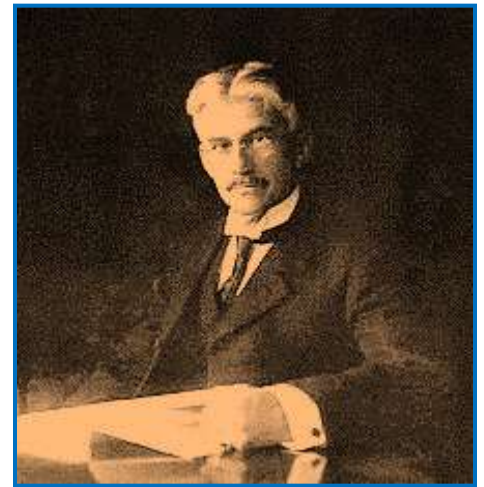

1. The Munsell Color System:

The Munsell's system is based on rigorous measurements of human subjects' and visual responses to color, putting it on a firm experimental scientific basis. The **Munsell color** identifies colours by its main three attributes: **Hue**, **Value (lightness value)**, and **Chroma (color purity)** which could be separated into perceptually uniform and independent dimensions, and was the first to systematically illustrate the colors in three-dimensional space.

a) Hue: Is divided into **five basic colors** represented in circle form, clockwise (see below): Each horizontal circle is divided into five principal hues: **Red**, **Yellow**, **Green**, **Blue**, and **Purple**, along with 5 intermediate hues (e.g., **YR**) halfway between adjacent principal hues. Each of these 10 steps, with a designated hue given as number 5, is then broken into 10 sub-steps, so that 100 hues are given integer values. In practice, the color charts conventionally specify only **40 hues**, in increments of 2.5, progressing as for example **10R to 2.5YR**.

b) Value or Lightness: Is defined in **eleven steps** from white to black and chroma has **fifteen steps**. Value refers to the amount of lightness or darkness of the colour, and varies vertically along the color solid, from **black** (value 0 at the bottom), to **white** (value 10 at the top). Neutral grays, lie along the vertical axis between black and white. The degree of reflectivity of the surface receiving the light governs this property and sometimes is also called reflectance value. Several color systems before Munsell's, plotted luminosity from black on the bottom to white on the top, with a gray gradient between them, but these systems neglected to keep perceptual lightness constant across horizontal slices.

c) Chroma or Color Purity: Is how vivid colour appears, measured in terms of the difference of a colour from the neutral grey with the same degree of brightness. Lower saturation, greyer the colour. The terms chroma and intensity, and sometimes weight, are also used. Note that there is no intrinsic upper limit to chroma. Different areas of the color space have different maximal chroma coordinates. For instance, **light yellow** colors have considerably **more** potential chroma than light purples, due to the nature of the eye and the physics of color stimuli. Vivid soil colors are in the range of approximately 8.

2. Munsell Color Identification:

This system is based on a **unique** color-solid arrangement which more accurately demonstrates hue, value and intensity of color. In this system, a color's hue is given a **number/letter** designation which locates it on the Munsell Color Wheel. When considering the aesthetics of a final coat of a paint system, colour is an important property, as gloss and opacity. White light, light emitted from the noonday sun is a combination of electromagnetic wavelengths from **400** nanometers to **700** nanometers, blue through to red. The Munsell System is used by the U.S. Bureau of Standards. In the Munsell System.

a) Primaries:

Red (R); Yellow (Y); Green (G); Blue (B); Purple (P).

b) Intermediates:

Yellow – Red (YR); Green – Yellow (GY); Blue – Green (BG); Purple – Blue (PB); Red – Purple (RP).

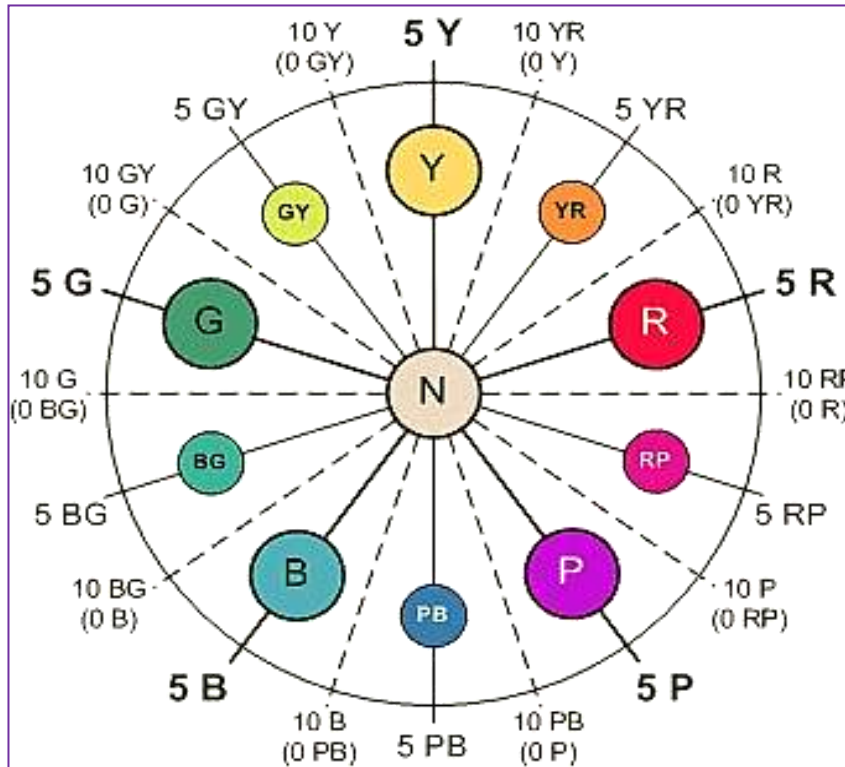

Note: The ASTM D-1729-74 describes visual color comparison methods against pre-established standards. In this standard are also fixed lighting conditions and observation.

The diagram below shows 40 evenly spaced Munsell hues, with complements vertically aligned.

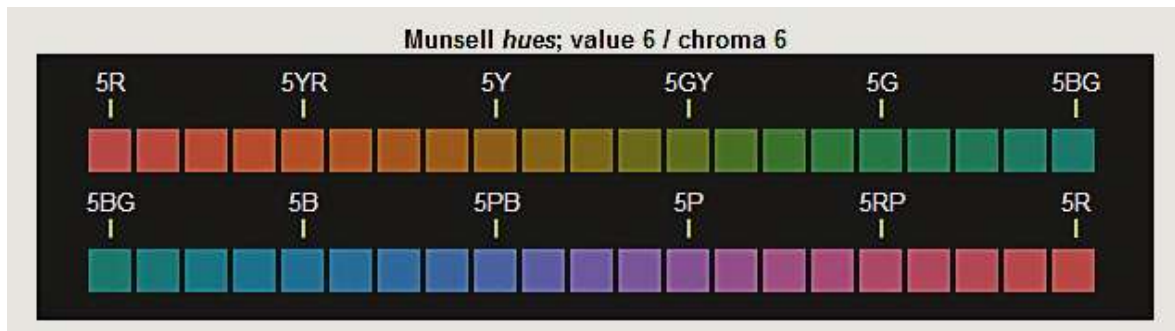

Black and white and the greys in **between** are called “achromatic” colours, they lack hue and saturation. Anything perceived as having colour is “chromatic”. The three attributes can be related to a three dimensional model of a helix are defined below:

c) **Value and Chroma:** A color is fully specified by listing the **three** numbers for hue, value, and chroma in that order. For instance, a purple of **medium** lightness and fairly saturated would be 5P 5/10 with 5P meaning the color in the **middle** of the purple hue band, 5 meaning medium value (lightness), and a chroma of 10.

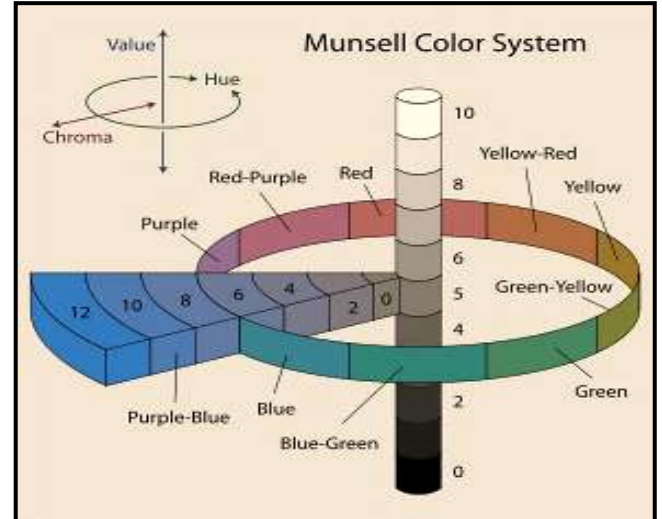
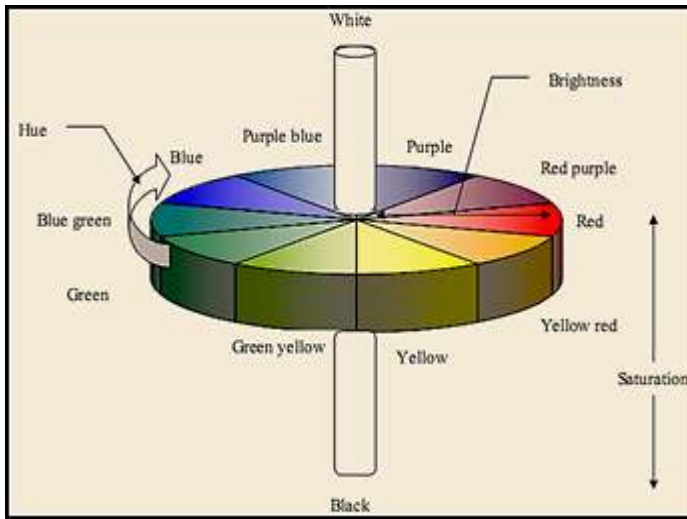

The below wheel shows respective primary colours. The value is designated by a number from 1-11 corresponding to a scale from black to white. Chroma or intensity or is designated by a number from 1-15 (the higher the number the greater the hue's intensity). For example, in the Munsell System, a **fairly bright yellow** would be notated as **3Y 8.0/14.3**.

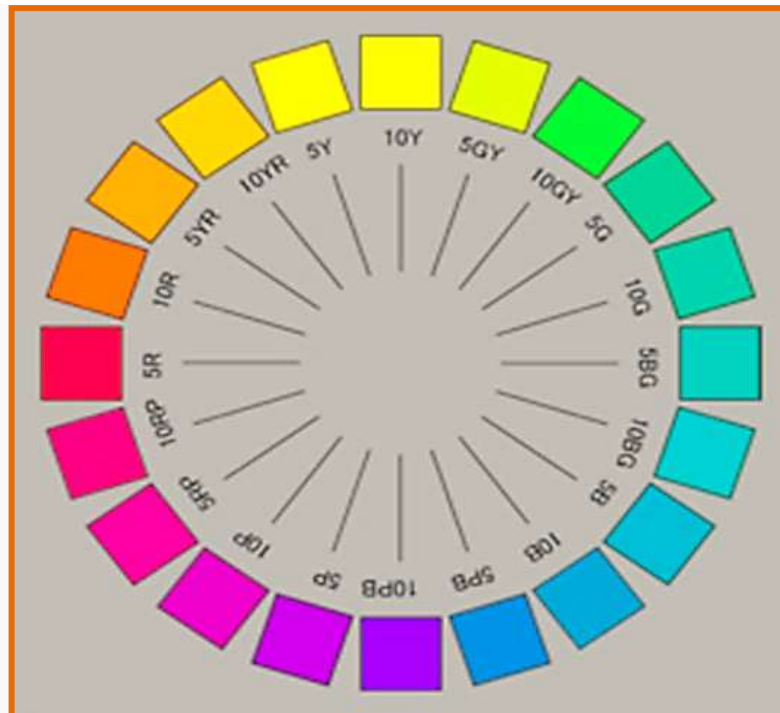

The hues of the Munsell color system, at varying values, and maximum chroma.

3. Industrial Color Identification:

The colors are standardized, as application to identification and visualization procedures. The most frequently used colors are:

- 1) **Aluminum**: For storage tanks, pressure vessels, piping (running the utilities), general steel structures, reactors, heat exchangers, etc.
- 2) **White (Munsell N. 9.5)**: For storage tanks of light oil and oil products, hydrocarbon gas facilities in particular the liquefied petroleum gas and steam; areas around aid emergency equipment or emergency facilities; areas for storage, etc.
- 3) **Blue (Munsell 2.5 PB 4/10)**: For compressed air pipes; moving equipment which must remain out of service, barriers or command panels; energy sources, etc.
- 4) **Brown (Munsell 2.5 YR 4/2)**: Fragmented materials (ores);
- 5) **Cream (Munsell 10 YR 6/7/2273)**: Heavy gases;
- 6) **Lilac (Munsell 10 4/10 RP)**: Alkali;
- 7) **Light Grey (Munsell N. 6.5)**: Vacuum;
- 8) **Dark Grey (Munsell N. 3.5)**: Electrical conduits;
- 9) **Black (Munsell N. 1)**: High viscosity fuel (fuel oil); asphalt, tar, bitumen, etc.;



Three-dimensional representation of the 1943 Munsell denotations.

4. Industrial Safety Colors:

The colors play an important role in industrial safety. The main uses of colors are:

- 1) **Red (Munsell 5 R 4/14)**: Pipes and firefighting facilities; valve stems of water sprinkler systems; transport with firefighting equipment; emergency exit doors, etc.

- 2) **Green (Munsell 10 GY 6/6):** Boxes of emergency rescue equipment; box containing gas safety masks; safety showers; general water (potable, not potable and return); stretchers; eye washer sources; etc.
- 3) **White and White with Black Bands:** Traffic marking.
- 4) **Yellow (Munsell 5 Y 12/8):** Where there is a need to draw attention; tracks on elevator entrance and loading platforms; floors and bottoms of stairs which present danger; platforms without hand-rails; tracks on elevator entrance and loading platforms; dead-end corridors walls; beams placed at low altitude; cabins, loaders, cranes, cranes, excavators, etc.;
- 5) **Yellow with Black Bands:** Dangerous areas.
- 6) **Orange (Munsell 2.5 YR 6/14):** Mobile and dangerous parts of machines and equipment; internal parts of machinery guards that can be removed or opened; protective enclosures of electrical appliances; outside of pulleys and gears.
- 7) **Blue (Munsell 2.5 PB 4/10):** For compressed air pipes; moving equipment which must remain out of service, barriers or command panels; energy sources, etc.
- 8) **Purple (Munsell 10 P 4/10):** Indication of hazards from electromagnetic radiation and nuclear particles; doors and openings that lead to places where stored radioactive materials or materials contaminated by radioactivity are.

5. Prang Color System:

Primary Hues: These are **red, blue and yellow** in the Prang color system. They are referred to as primary because (theoretically at least) they cannot be made by mixing other hues and because other hues can (again in theory) be made by mixing two of the primaries together.

Secondary Hues: These are **orange, green and violet** in the Prang system. These can each be produced by mixing together two primary hues.

Tertiary Hues: These are hues **intermediary** between primary and secondary hues. These are usually named and mixed by combining adjacent primary and secondary hues; e.g. red-orange is the tertiary between red and orange.

6. British Color System:

The British system specifies **100** colours selected from the **237** used in the **BS 5252**. The BS 4800 uses the same basic colours but expands to thirteen, including a neutral. The colours are **numbered** from 02 to 24, being 00 neutral, achromatic, using even numbers only.

Lightness is identified by capital letters **A to E**, where **A is maximum** lightness and **E is minimum** lightness. The **chroma** is given by number, the third part of the coding, from **01**, in single digit rises to **56**. The higher the number, the stronger the colour.

7. RAL Color System:

Germany in 1927 with the “*Imperial Commission for Delivery Terms and Quality Assurance*” invented a collection of **40 colors** under the name of “**RAL 840**”. The meaning of **RAL** is “*Reichs-Ausschuss für Lieferbedingungen*” (Reich Committee on Delivery). Prior to that date, manufacturers and customers had to exchange samples, to describe a **paint** type. The first digit relates to the shade of the color, as shown in the table below:

Range	Range Name	First	Last	Quantity
RAL 1xxx	Yellow	RAL 1000 Green Beige	RAL 1037 Sun Yellow	40
RAL 2xxx	Orange	RAL 2000 Yellow Orange	RAL 2013 Pearl Orange	14
RAL 3xxx	Red	RAL 3000 Flame Red	RAL 3033 Pearl Pink	34
RAL 4xxx	Violet	RAL 4001 Red Lilac	RAL 4012 Pearl Black Berry	12
RAL 5xxx	Blue	RAL 5000 Violet Blue	RAL 5026 Pearl Night Blue	25
RAL 6xxx	Green	RAL 6000 Patina Green	RAL 6038 Luminous Green	36
RAL 7xxx	Grey	RAL 7000 Squirrel Grey	RAL 7048 Pearl Mouse Grey	38
RAL 8xxx	Brown	RAL 8000 Green Brown	RAL 8029 Pearl Copper	20
RAL 9xxx	White/Black	RAL 9001 Cream	RAL 9023 Pearl Dark Grey	14

Note: Most of these standard colors are used on warning and **traffic signs** or are dedicated to government agencies and public services (for example: RAL 1004 - Swiss Postal Service).

a) RAL F9: This RAL Classic designation, was invented in 1984, and is made up of **only 3 colors** (RAL 6031 - bronze, RAL 8027 - leather, RAL 9021 - tar), used for military camouflage coating.

b) RAL Design: In 1993 a new **color** matching system was introduced, tailored to the needs of architects, designers and advertisers. It started with 1688 colors and was revised to 1625 colors, and its numbering follows a scheme based on the CIELAB color space. In 1993 the CIE described the CIELAB space (CIE + L + a + b) and the CIELUV space (CIE + L + u + v) in terms of calorimetric coordinates. The RAL DESIGN number is made of 3 parts:

H (Hue), an angle between 0 and 360; **L** (Lightness) 0-100; **C** (Chroma) 0-100.

c) RAL Effect: Comprises 420 solid colors and, as a particular highlight, seventy metallic colors, based on waterborne paint systems. No use is made of heavy metals such as lead, cadmium and chromates. The RAL Effect allows eco-efficient color production for all paint and lacquer producers.

d) RAL Digital: The software for architects, decorators and all who deal with colors in a creative way. It integrates the colors of RAL Classic, RAL Effect and RAL Design into graphics and CAD programs.

d) RAL Colour “Feeling 09/10”: Primarily designed as a professional tool for designers, architects, interior designers, interior decorators and painters, on how to creatively combine the main trend colors.

8. RAL Color Chart:

RAL 1000		Green Beige	RAL 4007		Purple Violet	RAL 7008		Khaki Grey
RAL 1001		Beige	RAL 4008		Signal Violet	RAL 7009		Green Grey
RAL 1002		Sand Yellow	RAL 4009		Pastel Violet	RAL 7010		Tarpaulin Grey
RAL 1003		Signal Yellow	RAL 5000		Violet Blue	RAL 7011		Iron Grey
RAL 1004		Golden Yellow	RAL 5001		Green Blue	RAL 7012		Basalt Grey
RAL 1005		Honey Yellow	RAL 5002		Ultramarine Blue	RAL 7013		Brown Grey
RAL 1006		Maize Yellow	RAL 5003		Sapphire Blue	RAL 7015		Slate Grey
RAL 1007		Chrome Yellow	RAL 5004		Black Blue	RAL 7016		Anthracite Grey
RAL 1011		Brown Beige	RAL 5005		Signal Blue	RAL 7021		Black Grey
RAL 1012		Lemon Yellow	RAL 5007		Brilliant Blue	RAL 7022		Umbra Grey
RAL 1013		Oyster White	RAL 5008		Grey Blue	RAL 7023		Concrete Grey
RAL 1014		Ivory	RAL 5009		Azure Blue	RAL 7024		Graphite Grey
RAL 1015		Light Ivory	RAL 5010		Gentian Blue	RAL 7026		Granite Grey
RAL 1016		Sulfer Yellow	RAL 5011		Steel Blue	RAL 7030		Stone Grey
RAL 1017		Saffron Yellow	RAL 5012		Light Blue	RAL 7031		Blue Grey
RAL 1018		Zinc Yellow	RAL 5013		Cobalt Blue	RAL 7032		Pebble Grey
RAL 1019		Grey Beige	RAL 5014		Pigeon Blue	RAL 7033		Cement Grey
RAL 1020		Olive Yellow	RAL 5015		Sky Blue	RAL 7034		Yellow Grey
RAL 1021		Rape Yellow	RAL 5017		Traffic Blue	RAL 7035		Light Grey

RAL 1016		Sulfer Yellow	RAL 5011		Steel Blue	RAL 7030		Stone Grey
RAL 1017		Saffron Yellow	RAL 5012		Light Blue	RAL 7031		Blue Grey
RAL 1018		Zinc Yellow	RAL 5013		Cobolt Blue	RAL 7032		Pebble Grey
RAL 1019		Grey Beige	RAL 5014		Pigeon Blue	RAL 7033		Cement Grey
RAL 1020		Olive Yellow	RAL 5015		Sky Blue	RAL 7034		Yellow Gre
RAL 1021		Rape Yellow	RAL 5017		Traffic Blue	RAL 7035		Light Grey
RAL 1023		Traffic Yellow	RAL 5018		Turquoise Blue	RAL 7036		Platinum Grey
RAL 1024		Ochre Yellow	RAL 5019		Capri Blue	RAL 7037		Dusty Grey
RAL 1027		Curry	RAL 5020		Ocean Blue	RAL 7038		Agate Grey
RAL 1028		Melon Yellow	RAL 5021		Water Blue	RAL 7039		Quartz Grey
RAL 1032		Broom Yellow	RAL 5022		Night Blue	RAL 7040		Window Grey
RAL 1033		Dahli Yellow	RAL 5024		Pastel Blue	RAL 7042		Traffic Grey A
RAL 1034		Pastel Yellow	RAL 6000		Patina Green	RAL 7043		Traffic Grey B
RAL 2000		Yellow Orange	RAL 6001		Emerald Green	RAL 7044		Silk Grey
RAL 2001		Red Orange	RAL 6002		Leaf Green	RAL 7045		Telegrey 1
RAL 2002		Vermillion	RAL 6003		Olive Green	RAL 7046		Telegrey 2
RAL 2003		Pastel Orange	RAL 6004		Blue Green	RAL 7047		Telegrey 4
RAL 2004		Pure Orange	RAL 6005		Moss Green	RAL 8000		Green Brown
RAL 2008		Bright Red Orange	RAL 6006		Grey Olive	RAL 8001		Ochre Brown
RAL 2009		Traffic Orange	RAL 6007		Bottle Green	RAL 8002		Signal Brown
RAL 2010		Signal Orange	RAL 6008		Brown Green	RAL 8003		Clay Brown
RAL 2011		Deep Orange	RAL 6009		Fir Green	RAL 8004		Cooper Brown

RAL 3012		Beige Red	RAL 6020		Chrome Green	RAL 9023		Orange Brown
RAL 3013		Tomato Red	RAL 6021		Pale Green	RAL 9024		Beige Brown
RAL 3014		Antique Pink	RAL 6022		Olive Drab	RAL 9025		Pale Brown
RAL 3015		Light Pink	RAL 6024		Traffic Green	RAL 9028		Terra Brown
RAL 3016		Coral Red	RAL 6025		Fern Green	RAL 9001		Cream
RAL 3017		Rose	RAL 6026		Opal Green	RAL 9002		Grey White
RAL 3018		Strawberry Red	RAL 6027		Light Green	RAL 9003		Signal White
RAL 3020		Traffic Red	RAL 6028		Pine Green	RAL 9004		Signal Black
RAL 3022		Salmon Pink	RAL 6029		Mint Green	RAL 9005		Jet Black
RAL 3027		Raspberry Red	RAL 6032		Signal Green	RAL 9006		White Aluminum
RAL 3031		Orient Red	RAL 7000		Squirrel Grey	RAL 9007		Grey Aluminum
RAL 4001		Red Lilac	RAL 7001		Silver Grey	RAL 9010		Pure White
RAL 4002		Red Violet	RAL 7002		Olive Grey	RAL 9011		Graphite Black
RAL 4003		Heather Violet	RAL 7003		Moss Grey	RAL 9016		Traffic White
RAL 4004		Claret Violet	RAL 7004		Signal Grey	RAL 9017		Traffic Black
RAL 4005		Blue Lilac	RAL 7005		Mouse Grey	RAL 9018		Papyrus White
RAL 4006		Traffic Purple	RAL 7006		Beige Grey			

Note: This Chart is to be used as a guide only. Colors may appear slightly different. Conversions between **Munsell** and **RAL** colors may also be slightly different, as shown below:

	Cinza-Claro N 6.5		Cinza RAL 7032
	Vermelho Segurança 5R 4/14		Vermelho Tráfego RAL 3020

VI. COATING & PAINTING INSPECTIONS:

The **Coating Inspector's role** is to verify if the quality of work being performed meets the **specifications** and complies with all contract documents for the project. In a strict sense, the judgment of the work should be based only on **documentations** and no variance should be made without the owner authorization or discussions with the **third** part manufacturer.

Often, quality control is in conflict with getting the job done and deadlines specified or required. However, it is generally better to put the priority on **quality control** instead of on time and money requirements. Corrosion brings a dangerous situation for any equipment.

Contractors sometimes want the manufacturing measurements to be more in line with what they want, instead of what is necessary for good quality. The moral and legal questions on putting incorrect numbers on painting inspection reports is beyond the scope of this manual, but, should be considered when working for a contractor.

It is also the **Coating Inspector's job** to verify that the work complies with the project documents and specifications. If the contractor does not have a quality control person, the inspector becomes both quality control and quality assurance. This can greatly increase the load on the inspector, mainly if the work is not running in correct way, so, other procedures may have to be inspected numerous times.

A **Coating Inspector's responsibility** is also to verify that the work is conforming to a set of specifications and activities must be documented. If it is not documented, the work can't happen. The inspection reports can become legal documents, then, should be complete, legible, signed and dated.

The Inspector should not require the contractor to perform a work that is **outside the specifications**, yet if it seems to make sense. Even when an inspector is NACE Certified or certified by some other training, does not make them qualified to make decisions outside the strict verification of the work, and if it complies with the specifications.

The Inspector should also **avoid** making judgments about the coatings that are not part of the specifications. If there are any concerns, they should be brought to the **attention** of the owner, the specifier, the coating supplier or other qualified person. Depending on the qualifications of the Inspector and the needs of the owner, sometimes the inspector is required to act as a **project manager** and have responsibilities beyond normal inspection. With increased authority, also come increased responsibility and possible liabilities, including warrantee issues and other legal liabilities.

1. Inspection Preparation Procedures:

It doesn't matter whether the Inspector is working **directly** for the owner or working for an inspection company, the inspection work should begin prior to the manufacturing job. It's necessary to determine the needs of the owner, the skill level of the contractor, study the contract documents, find out the coating systems to be applied. Most of this, the Coating Inspector should be **able** to find out, prior to showing up on the job. The following items are useful to gather.

1. All specifications related to the work, all addendums and appendices;
2. All applicable codes and standards;
3. Manufacturers Product Data Sheets (PDS) and Material Safety Data Sheets (MSDS);
4. Ink or paint manufacturer's application bulletins;
5. Equipment drawings and a sketch of the area where the work painting will be performed;

- **Useful Reference Procedures:**

NACE Recommended Practices;
SSPC Publication 91-12 - Coating and Lining Inspection Manual;
SSPC Redbook Volume 1;
SSPC Redbook Volume 2 (Surface Preparation Standards);
SSPC-VIS 1 - Reference Photographs for Steel Surfaces Prepared by Dry Abrasive Blast Cleaning;
SSPC-VIS 2 - Standard Method of Evaluating Degree of Rusting on Painted Steel Surfaces;
SSPC-VIS 3 - Reference Photographs for Steel Surfaces Prepared by Power- and Hand-Tool Cleaning;
SSPC-VIS 4/NACE VIS 7 - Reference Photographs for Steel Surfaces Prepared by Waterjetting;
SSPC-VIS 5/NACE VIS 9 - Reference Photographs for Steel Surfaces Prepared by Wet Blast Cleaning;
ISO 8501:2007;
ASTM Volume 6.01;
ASTM Volume 6.02

2. Inspection Hold Points:

The number and type of coatings **hold points** may vary according to the required design; however, some points are **standards** for most projects. These include:

- a. Before starting the inspection work:
 - Inspection of steel material ;
 - Check sharp edges welds and weld splatter;
 - Check abrasives;
 - Check air supply;
 - Check the blasting equipment.
- b. After surface preparation:
 - Check painting equipment;
 - Check surface contamination;
 - Visual cleanliness.
- c. Immediately before application of coatings:
 - Climatic conditions, wind, humidity, etc.;
 - Coating materials inspection;
 - Mixing coatings observation;
 - Validity of ink gallons;
 - Coating manufacturer bulletins.
- d. Following the application of each coat:
 - Wet and dry film thickness verification;
 - Holiday testing;
 - Recoat time;
 - Coating cure.
- e. Following the cure of the coating:
 - Final inspection and color verification;
 - Dry film thickness tests.

3. Inspection Reports:

The best way to maintain credibility as a Coating Inspector is to act in a **professional** manner and to present your documentation in a clear, fast and concise manner. It is alright to use a standard inspection form for most jobs, but customizing the forms to match the project can increase your professionalism in the eyes of the client and at the same time makes your job easier. Diagrams can prove useful in identifying areas of work and should be used when appropriate.

The inspection reports should be provided to the Contractor and the owner on a daily basis. It is useful to the contractor signs the **report** forward, so he cannot claim at a later time, he was not aware of any problems. It's important to discuss the signing of the inspection reports during the pre-construction **meetings**, so, if there are any objections they can be fixed in advance. It should be made clear that this is to protect both the contractor and the inspector.

4. Disagreements with the Contractor:

It is inevitable at some point in a coating inspector's career that disagreements will arise between the Inspector and the Contractor. Some Contractors are quick to try to argue their view **points**. The Coating Inspector should avoid arguing with the Contractor and make sure to **understand** their point of view. When the Inspector keeps the pre-construction meeting reports, many of these problems can be avoided and resolved using the contractors own submittal documents and procedures.

5. Non-conformance Reports (NCR):

Nonconformance reports can be a serious issue and should not be written **unless** absolutely necessary. In some places Nonconformance Reports can keep contractors from being **not eligible** to bid on some government projects. When a **deficiency** is found, as long as the contractor immediately corrects the deficiency, no **NCR** should be written up. A NCR should be issued when the contractor passes the point where the deficiency can be corrected, i.e., the Surface Profile is insufficient and the contractor has proceeded applying the prime coat without correcting the problem.

6. Instruments for Coatings Inspection:

To properly perform duties, the Coating Inspector should have proper working **inspection** apparatus that may vary, but the below list, should be **sufficient** for most projects.

1. Electronic Relative Humidity Temperature Meter (more accurate than a sling psychrometer);
2. Surface Temperature Gauge (if not included in Psychrometer -Thermocouple type or Infrared Type);
3. Dry Film Thickness Gauge:
 - a. Type 1 - Banana Gauge (Positest FM or equivalent with calibration plates or foils);
 - b. Type 2 - Electronic Gauge (Positector 6000 or equivalent with calibration foils);
4. Flashlight;
5. Inspection Mirror or Boroscope;
6. Magnifying Glass or Digital Microscope;
7. Salt Testing Equipment (Conductivity or Chlorides);
8. Black Light (for oil contamination - may not catch all oils and lubricants);
9. Blotter Paper (or clean white rag for testing air supply);

10. Surface Profile:
 - a. Test-Ex Tape & Spring Micrometer;
 - b. Surface Profile Gauge – Elcometer 224;
11. Holiday Tester (if appropriate for the project);
12. VIS Standards (if appropriate for the project);
13. Paint Thermometer;
14. Photographic Camera;
15. Optional - Blast Needle Gauge and Nozzle Orifice Gauge.

VII. DUTIES OF PAINTING INSPECTIONS:

The international terms, defines **inspection** as “Activities such as measuring, examining, testing, gauging, one or more characteristics of a product or service and comparing these with specified requirements, to determine conformity”. The job **specification** is the main tool of the Inspector and should be observed at all times. It is not the Inspector’s responsibility to rewrite a specification without permission and any deviation should be given in writing and retained by the inspector.

An inspector should keep adequate and **accurate** records of all stages of the work, materials used, ambient conditions etc., so that, in the event of illness or any other situation requiring a replacement, the new inspector will be in full possession of all relevant **information**. Documents available to an inspector could include, but not be limited to:

- a) Job Specification;
- b) Data Sheets for the paints/coatings;
- c) Procedures;
- d) Quality Plans;
- e) Plant Drawings;
- f) Site Plans.

The format of Daily Report Sheets varies but in general will require the following information:

1. Details about the contract and contractor, including plant on site and number of personnel.
2. Ambient conditions applicable during the work period, to be monitored as near as possible to the task location.
3. For surface preparation activities the information required will include, method used, original substrate condition, abrasive type, degree of cleanliness achieved, profile achieved, identity of plant and times of starting and completion.
4. For materials, the information required may include manufacturer, product number, expiry date, batch number, colour, reference number of thinners, **WFT** and resulting **DFT**, time of application and identity of plant. In the case of labour only contracts it will be required to record quantity used.
5. The comment part is a space left for the inspector to report on any irregularities, nonconformance or deviation from specification.

Typical examples of situations to reject inspection can be immediately reported are.

1. Substituting approved products with unapproved products.
2. Using solvents other than those approved by the manufacturer.
3. Not observing recommended over coating times.

4. Continuing with the next stage of operations without inspection of the substrate and approval.
5. Painting/coating over areas of inadequate surface preparation.
6. Working in conditions outside of specified requirements.

1. Painting Inspections:

Paints are applied to steel surfaces by many methods, but in all cases this produces a “*wet film*”. The thickness of the “*wet film*” can be measured, before the solvent evaporates, using a comb-gauge. As the solvent evaporates, film formation occurs, leaving the binder and pigments on the surface as a “*dry film*”.

The thickness of the “*dry film*” can be measured, usually with a digital electro-magnetic induction gauge. The relationship between the applied “*wet film*” thickness and the final “*dry film*” thickness is **determined by the percentage volume of solids** at the paint. In general the corrosion protection, afforded by a paint film, is directly proportional to its “*dry film*” thickness.

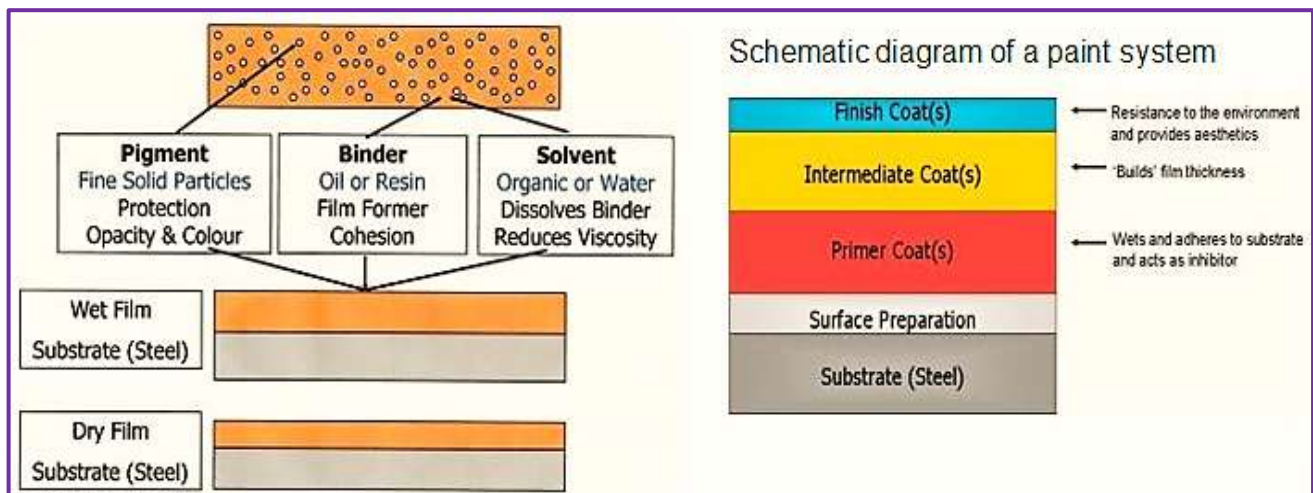

2. Visual Inspections:

The rating of **volume of solids** is evaluated by inspecting the overall part. This is a visual judgment call based on the following scales:

✓ Liquid Paint:

- 5: Perfect - 0 pinholes;
- 4: Excellent; very little pin holing - 0-10% of surface;
- 3: Good - 10-30% of surface has pinholes;
- 2: Fair - 30-60% of surface has pinholes;
- 1: Poor - 60-100% of surface has pinholes.

✓ Powder Coating:

- 4: Excellent; very little pin holing - 0-25% of surface;
- 3: Good - 25-50% of surface has pinholes;
- 2: Fair - 50-75% of surface has pinholes;
- 1: Poor - 75-100% of surface has pinholes.

✓ **Distinction of Image:**

- 5: Perfect - very shiny; great reflection
- 3: Some reduction in shine but still good reflection
- 1: Reject - little to no reflection

3. Gages Calibration:

Calibration of all coating thickness gages and measurement of coating thickness should be performed in accordance with ASTM D1186 or ASTM D1400.

- a) **Type 1 Gages:** Should be verified each time they are used. The SSPC Paint Application Standard No. 2 (SSPC-PA 2) specifies that the **Type 1** gages should be verified using “**calibration plates**” not shims or foils (but, in reality, calibrating with foils is just as accurate).
- b) **Type 2 Gages:** Should be verified each time they are used. The SSPC Paint Application Standard No. 2 (SSPC-PA 2) specifies that the **Type 2** gages should be verified with foils (shims) or “*calibration plates*”, before and after each shift.

Obs.: When using foils, calibrate with the **shim** on the prepared substrate. If the gage is calibrated to plates, then the actual **DFT** is the reading, minus, the **BMR** (Base Metal Reading). The **BMR** should be **subtracted** from each gage reading to get the proper coating thickness. When many readings are being taken throughout the day, it is recommended a **frequent** verification of the calibration. When the Coating Inspector takes **500** readings over the course of the day and final calibration is off, there is no way of knowing when it went wrong, then, he has to **back-track** all the readings until find the point.

Note: When using a Type 2 gage on **nonferrous metals**, it is essential to calibrate the meter to the base metal being tested. Calibrating the ferrous part of an **FNF gage** does not calibrate the nonferrous probe.

4. Weld Coating:

Welds can be contaminated from the welding process itself. Important checks for this are, spatters, slag, smoke and burn-back:

- ✓ **Spatters:** Are not removed totally by abrasive blasting. The contour of a spatter will produce both a too low DFT and a shading effect upon paint spraying.
- ✓ **Slag:** Is formed because of the high temperature during welding. Certain mechanical cleaning methods, e.g., wire brushing do not remove slag.
- ✓ **Smoke:** Electrodes may deposit an alkaline water-soluble substance, can cause osmosis (spontaneous movement of solvent molecules through a partially permeable membrane, into a region of higher salty concentration).
- ✓ **Burn-back:** Means the applied shop-primer or other coat deteriorates along or on the rear side of welded areas. The primer loses its adhesion, is partly destroyed, charred and oxidized, which may require more extensive surface preparation than specified.

Corrective Actions:

- Spatter must be removed by chipping or grinding.
- Slag must be removed by the use of a chipping hammer.

- If alkaline smoke has been exposed to open weather more than one month, no correction is required. Otherwise high pressure cleans the welds carefully with fresh water.
- Burn-back should be cleaned carefully to min **St 3**; ISO 8501-1 - 1988, if no better surface preparation is specified.

5. Material Safety Data Sheet (MSDS):

The Inspector must also evaluate the MSDS. The MSDS is an informational **sheet** required by the OSHA Hazard Communication Standard 29 CFR 1926.59 for each coating material, thinner, or other chemical stored at the jobsite. An MSDS must be **provided** with each shipment of chemicals received and inspected at the site. The MSDS must be current, and the worker must be instructed on how to read and interpret the information, easily accessible and available for viewing without request for permission. The MSDS can be used for several purposes such as:

1. Identifying chemical ingredients in coating materials.
2. Assessing technical data like flash point, LEL, OSHA PEL, odor, and health hazards.
3. Selecting proper personal protective equipment.
4. Establishing proper storage practices.
5. Measures to take to clean up spills or leaks.

6. Inspecting Coating & Painting Failures:

Failure description	Cause	Remedy
BLEEDING - Staining of top-coats.	Soluble resins or pigments in under-coat migrate to topcoat.	Seal undercoat with bleeding and insoluble components.
BLISTERING - Small to large (1/32 to 1 inch plus) hemispherical bubbles in the coating that contain gases or liquids. Bubbles may range from 1 per square foot to several hundred per square foot.	May be due to poor surface preparation, internal soluble materials (salts), or poor wetting of substrate. Osmosis causes absorption of gases into substrate or solvent entrapment (also referred to as "solvent blistering").	Select a coating with very strong adhesion strength and low moisture vapor transfer rate. Ensure clean substrate with proper surface preparation and reduced soluble salt levels to suit service exposure.
CAVITATION - Loss of coating and metal material. Appears as tiny craters overlain by multiple craters in metal surface, accompanied by significant metal loss.	Drop in water vapor pressure, forming air bubbles that repeatedly collapse at high pressure.	Select coating with strong adhesive properties and high cavitation resistance.
CONCRETE - Adhesion loss, blistering, or peeling of coating.	Chemically reactive and high moisture content. Formation of calcium salts under the coating. Pinholes, air, and water pockets in concrete surface. Water vapor transmission through concrete.	Abrasive blast or water jet blast (acid etching not recommended) to obtain clean and dry surface. Select a low molecular weight, high penetrating primer with high alkali resistance (coal tar epoxy or modified epoxy).
CRACKING - Small breaks in coating to substrate. May be linear, cross-hatched, or curved. Cracks may or may not be continuous.	Stress set up in coating because of continued polymerization and oxidation; improper pigmentation or improper coating system.	Select coating formulated from non-reactive, weather-resistant resins; reinforcing pigments; and nonreactive colored pigments. Primer must be compatible with intermediate and finish coats.

CRATERING - Small, uniform indentations in coating film (also referred to as "pitting").	Air pockets trapped in wet film during spray application.	Abrasive blast, water jet blast; ensuring removal of contaminants within craters; and reapply coating.
DISCOLORATION - Yellowing, graying, or coating darkening.	Resin or pigment color change caused by weather or chemical reaction.	Select coating formulated with both color stable resins and pigments.
ENVIRONMENTAL CONDITIONS - Blistering and poor adhesion caused by damp, humid conditions. Powdery, where drying occurred too rapidly (overspray). Soft, uncured coating.	Ice, moisture, condensation (above dew point), or standing moisture on surface before application. Lack of proper cure because the humidity were outside restrictive range.	Apply coatings using the manufacturer's environmental (temperature, humidity, dew point, and surface condition) restrictions or more restrictive requirements.
FLAKING or SCALING - Small to large (1/16 to 1 inch plus) pieces of coating, curling at edges. Easily removed from surface, leaving substrate exposed.	Normally, coating is brittle, with internal shrinkage characteristics and marginal adhesion strength. Oil type coatings may scale or flake from galvanized surface (never apply an alkyd to a galvanized surface).	Select a coating with strong adhesion and low moisture vapor transfer rate. Ensure clean substrate with proper surface preparation and reduced soluble salt levels to suit service exposure. For galvanized surfaces, use a primer compatible with zinc.
HOLIDAYS - Bare areas on the substrate were not coated by the applicator (also called "painter's holiday").	Improper and inconsistent application technique, reflecting a lack of care. Most often occurs in areas difficult to coat.	Apply coating in a careful and professional manner, consistent with industry standards.
INTERCOAT DELAMINATION Coatings that do not adhere to the previous coat. Failure is between the primer and the intermediate coat or between the intermediate coat and the top coat. The substrate is not normally exposed.	Coating material is not compatible with undercoat; undercoat surface may be contaminated with dust, dirt, overspray, or other contaminants; or undercoat may have cured beyond maximum recoat time.	Select a coating with good compatibility and adhesion between coats. Ensure that the undercoat surface is clean before applying the next coat. For epoxies, do not expose to moisture (water and humidity) or excessive sunlight before applying the next coat.
IMPROPER THINNING - Poor adhesion or pigment flotation, resulting in uneven color. Separation of pigment and vehicle after application, resulting in pinholing or blushing.	Thinner is incompatible with resins or pigments. Improper drying, resulting in tension change. Thinner evaporated too rapidly causing moisture to condense on liquid coating. Excessive thinner, resulting in flocculation of pigment.	Use only the manufacturer's recommended thinner for selected coating material in the amounts specified. Add thinners slowly and mix thoroughly.
IMPROPER THICKNESS Where coating is thin pinpoints corrosion areas result. Where coating is overly thick, checking, cracking, or flaking result.	Improper applicator technique: too close or too far away during spraying; incomplete or excessive spray passes. Difficult areas (restrictive accessibility or space).	Use proper application techniques for even passes and overlaps, follow the manufacturer's application instructions, and use the equipment recommended by the manufacturer.
ORANGE PEEL - Overall appearance is bumpy. Film surface is smooth but irregular. Resembles skin of an orange.	Caused by improper application techniques: gun too far from surface, solvent evaporation too rapid, spray pressure too low for proper atomization, paint particles falling outside of spray pattern, or paint too viscous.	Brush out excess paint before material cures. Correct spray technique. After material has cured, sandpaper the surface before applying another topcoat that reacts more slowly.
OVERSPRAY - Very rough coating surface. Surface may be dry, pebbly, or sandy. Some coated areas may have the appearance of dryness or feel dry (also referred to as "dry spray").	Improper application techniques: gun too far from surface, solvent evaporation too rapid, spray pressure too low, atomizing pressure too high, and paint particles falling outside of spray pattern, or material too viscous.	Before the material cures, remove the overspray by dry brushing, followed by solvent wiping. After the material has cured, wire screen and sandpaper the surface before applying another topcoat that reacts more slowly.

<p>PEELING - Coating may be smooth and lying on the surface or hanging in shreds. Little or no adhesion is evident.</p>	<p>Adhesion is less than the tensile strength of the coating. Coating peelings can easily be pulled from the surface down to bare substrate.</p>	<p>Select a coating with very strong adhesion strength and low moisture vapor transfer rate. Ensure that the substrate is clean, the surface has been cleaned properly, and salt has been reduced to levels suited to the service exposure.</p>
<p>PINHOLES - Small, tiny, deep holes (1/32 inch) in coating, normally through to the substrate. Generally, the distribution of holes appears to be random.</p>	<p>Improper application techniques: gun too far from surface, solvent evaporation too rapid, spray pressure too low, atomizing pressure too high, paint particles falling outside of spray pattern, or pigment settlement.</p>	<p>If pinholes already exist, apply additional coat by brushing into holes. If material has cured, apply an additional coat. If outside the recoat window, abrade surface and apply additional coat.</p>
<p>SPATTER COAT - DFT less than specified. Under good lighting conditions, coating appears continuous; under poor lighting, coating appears discontinuous. May develop pin-point corrosion at a later date.</p>	<p>Improper application techniques, causing a non-continuous coating over the surface: inconsistent spray passes not overlapping by 50 percent, spray gun flipped at end of spray pass, or spray gun not held perpendicular to the surface.</p>	<p>If material has not cured, apply additional coat. If material has cured but it is still within the recoat window, apply an additional coat. If outside the recoat window, abrasive blast or water jet blast all material off and recoat.</p>
<p>WELDS - Corrosion in weld gaps and between overlapping metal is causing undercutting of coating.</p>	<p>Impossible to apply coating in crevices in weld gaps and between metal surfaces.</p>	<p>Provide continuous weld in gaps and overlap areas before applying coating in any corrosive environment.</p>

7. Checking Relative Humidity and Dew Point:

a) Relative Humidity (RH): Typically, most project requirements specify a Relative Humidity **below 85%** and a minimum **5 °F (-15 °C)** between the **metal surface temperature and the dew point**. When the Relative Humidity is around **50%** and the Dew Point spread is **10 °F to 15 °F (-12 °C ~-9 °C)**, the tests accuracy are not critical. However, when the Humidity is close to **85%** (or whatever the requirement is) and the dew point/metal surface temperature is about **5°F**, it is important that the readings be accurate.

b) Dew Point: Is a **water-to-air** saturation temperature (or vapor saturation in the air), and is always associated with Relative Humidity. A Relative Humidity of **100%** indicates the Dew Point is **equal** to the current temperature and that the air reached its maximum water saturation. When the Dew Point remains constant and temperature increases, the Relative Humidity decreases.

There are two basic methods of **measuring Relative Humidity and Dew Point** Temperatures in the field:

- **Sling Psychrometer:** Is the first method according to ASTM E 337, Standard Method for Measuring Humidity with a Psychrometer;
- **Electronic Meters:** Is the second, with devices, such as the **TQC Dewcheck or the Elcometer 319** that measures, Wet Bulb, Dry Bulb, Relative Humidity, Dew Point and Surface Temperature.

8. Surface Roughness Concepts:

The surface roughness is given as the arithmetical mean value for a randomly sampled area. "**Ra**" means arithmetical mean roughness, "**Ry**" means maximum roughness height, "**Rz**" means ten-point roughness, "**Sm**" means spacing of profile irregularities, "**S**" means spacing of local peaks of the profile and "**Tp**" the profile bearing length ratio.

Each grain surface position is indicated as shown below. This includes **surface roughness**, cut-off value or reference length, processing method, symbol of direction of lay, surface waviness, etc. Experience shows that the method of comparing a machined surface with a known sample, by sight or touch, enables the quality of the finish to be **estimated** with a remarkable accuracy.

Indication symbol on drawings:

Example

a: Roughness value Ra in micrometers or microinches or Roughness grade number N1 to N11

b: Production method. Treatment or coating.

c: Sampling length

d: Direction of lay

e: Machining allowance

f: Other roughness values (in brackets)

Ra = 1,6

b milled

Reference : Relationship between arithmetical mean roughness (Ra) and conventional symbols

Arithmetical mean roughness Ra			Max. height Ry	Ten-point mean roughness Rz	Standard length of Ry · Rz $\bar{\lambda}$ (mm)	Triangular indication
Preferred number series	Current value λ (mm)	Indication of surface texture on drawings	Preferred number series			
0.012 a	0.08		0.05 s	0.05 z	0.08	
0.025 a			0.1 s	0.1 z		
0.05 a			0.2 s	0.2 z		
0.1 a			0.4 s	0.4 z		
0.2 a			0.8 s	0.8 z		
0.4 a	0.8		1.6 s	1.6 z	0.8	
0.8 a			3.2 s	3.2 z		
1.6 a			6.3 s	6.3 z		
3.2 a	0.25		12.5 s	12.5 z	0.25	
6.3 a			25 s	25 z		
12.5 a	8		50 s	50 z	8	
25 a			100 s	100 z		
50 a			200 s	200 z		
100 a	—		400 s	400 z	—	

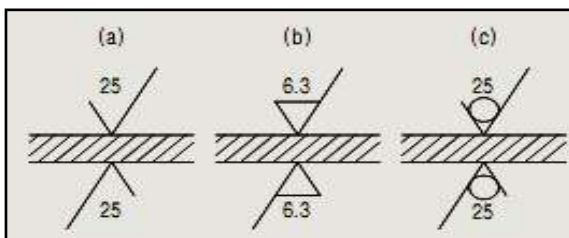

Examples indicating the upper limits of Ra.

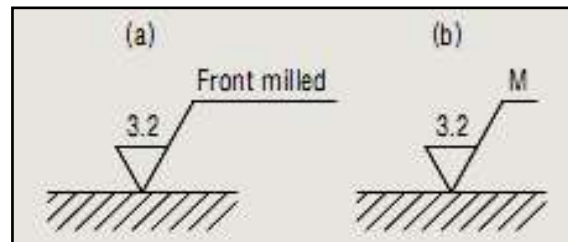

Examples indicating processing method.

VIII. WFT AND DFT RELATIONSHIP:

WFT means “**Wet Film Thickness**” and **DFT** means “**Dry Film Thickness**”. Many contractors wait until after the paint dries before determining its **thickness**. While it is not generally the inspector’s responsibility to monitor the Wet Film Thickness, it is generally a good idea **to check** it when possible. It is relatively simple to calculate the WFT that should be applied to get the proper DFT.

Theoretical Coverage: 1 mil of 100% solids coating covers 1604 ft²/WFT.

DFT = WFT x (% Solids)					
DFT = WFT $\left(\frac{\% \text{ Solids}}{(1 + \% \text{ Thinner})} \right)$					
WFT = $\frac{\text{DFT}}{\% \text{ Solids}}$			WFT = $\frac{\text{DFT}}{\left(\frac{\% \text{ Solids}}{100\% + \% \text{ Thinner}} \right)}$		
DFT	WFT	%S	DFT	WFT	%S
7	8	90%	5	8	60%
6.5	8	80%	4	8	50%
6	8	70%	3	8	40%

Obs: DFT and WFT in mils. 1.0 mil is equal to 0.001 of an inch (0.0254 mm) = 0.001 inch.

1. WFT and DFT Calculations:

Using certain formulae and information given on a materials data sheet, in conjunction with values determined from WFTs for example, calculations can give us the 'unknown' values. Four formulae can be used according to information provided.

1	WFT = $\frac{V}{A}$	3	DFT = $\frac{\text{WFT}}{1} \times \frac{\text{VS}}{100}$
2	WFT = $\frac{100}{\text{VS}} \times \frac{\text{DFT}}{1}$	4	VS% = $\frac{\text{DFT}}{\text{WFT}} \times \frac{100}{1}$

Example 1: If 12 liters of paint was used to cover an area of 10 m x 10 m (3ft x 3 ft) what would be the average WFT?

$$\text{WFT} = \frac{\text{Volume}}{\text{Area}} = \frac{12 \text{ Litres}}{10 \times 10} = 12 \text{ L}/100 \text{ m}^2$$

Example 2: What WFT would be needed to give a DFT of 0.50 mm, using a painting with a VS% of 65%?

$$\text{WFT} = \frac{100}{\text{VS}} \times \frac{\text{DFT}}{1} = \frac{100}{65} \times \frac{0.50}{1} = \frac{50}{65} = 0.769 \text{ mm}$$

Example 3: What would be the DFT if a paint with a VS content of 45% was applied at 1.20 mm WFT?

$$\text{DFT} = \frac{\text{WFT}}{1} \times \frac{\text{VS}}{100} = \frac{1.20}{1} \times \frac{45}{100} = \frac{54}{100} = 0.54 \text{ mm}$$

Example 4: What is the VS% (volume solids) of a paint applied at a WFT of 1.10 mm and the DFT was 0.63 mm?

$$\text{VS\%} = \frac{\text{DFT}}{\text{WFT}} \times \frac{100}{1} = \frac{0.63}{1.10} \times \frac{100}{1} = 57.27 \%$$

2. WFT Measurements:

When a Inspector measures a Wet Film Thickness coating, he is **measuring** the amount of paint above the peaks, as shown in figure below:

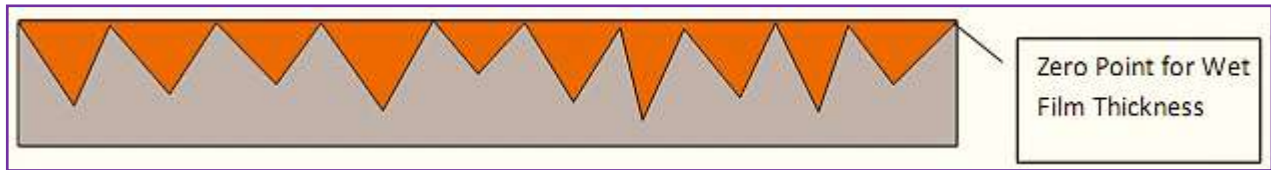

A surface with peaks and valleys, there is no clear line where the “Zero Point” is. There are areas in the profile that are “**less than the zero point**”. When measuring a Dry Film Thickness coating, the meter cannot **register** any paint applied to the surface, until it is **greater than the zero point**.

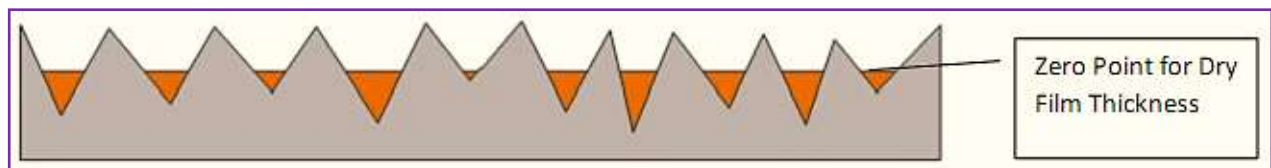

As a **rule of thumb** to determine the approximate extra paint required to fill a grit blast profile, is to multiply the peak to valley height **0.5 times** and add this to the Dry Film Thickness. For example, for a peak to **valley height of 10 mils**, an additional quantity of paint equal to a **full coat at 5 mils** will be required for the Dry Film Thickness. Since the shot blast profile is **smoother**, the amount of paint would be slightly less, then, may be used **0.25 times** the blast profile to calculate the additional amount of paint.

3. DFT Measurements:

The specification for a painting contract will state DFT criteria for each coat of paint applied. As it is the inspector’s main function to ensure that work is carried out to specification, he/she should perform as many checks as needed to ensure that the specification criteria is met. The DFT value can be determined by one of two methods.

- **Nondestructive Test Gages:** Nondestructive dry film thickness instruments fall into **three** basic categories: magnetic pull-off gages, electromagnetic probes, and eddy current probes.
- **Destructive Test Gages:** Destructive dry film thickness gages generally entail the **use** of the Tooke Gages (or paint inspection gages).

4. Measuring Surface Profiles:

There are currently **4 (four) accepted ways** to find surface profile and each one has advantages and disadvantages. The **first three methods** are detailed in ASTM D4417, “*Standard Test Method for Field Measurement of Surface Profile of Blast Cleaned Steel*”.

1. Surface Profile Visual Comparator (Method A);
2. Surface Profile Gage – Profilometer (Method B);
3. Press-o-film Testex Tape (Method C);
4. Surface Roughness Tester.

a.) Surface Roughness Comparators – Method A:

The Kean Tator comparators (most common in USA) are used for **shot and grit blasting**. The Rugotest TQC LD6010 no. 3 and the Rugotests TQC LD2040 and 2050 (are according to ISO 8503-1).

Note: The values should be the criteria “**Ra**” (roughness average measurement) in the ISO Standards 2632/I, 2632/II and ASTM D4417/A. In USA “**Ra**” is measured in **mils**. **1.0 mil is equal to 0.001 of 1.0 inch (0.0254 mm) = 0.001 inch or 25.4 microns**. Commonly **A** for Steel Shots, and **B** for Steel Grits.

- The **Kean Tator Profile Comparator** is a field instrument designed to quickly determine the surface profile of blast cleaned surfaces, consisting of a **reference disc**, a **5-X illuminated magnifier** with magnetic disc holder, with nominal anchor patterns of **1.5, 2.0, 3.0, 4.5 and 5.5 mils** (one mil = 0.001 inch or 25.4 microns). Three **reference discs** are available; the disc selected is based on the abrasive used to prepare the steel surfaces. Reference disc choices include one for surfaces prepared with sand, one for surfaces prepared with steel shot and a third for surfaces blast cleaned with a grit or slag abrasive.
- The TQC LD2040 is a comparator standard according to ISO 8503-1 made of quality steel. Indicates the surface condition of blasted steel according to ISO 8503 in grades of fine, medium, and coarse. Can be used in accordance with ASTM D4417/A, ISO 8503-1, ISO 8501-2.
- The Rugotest TQC LD6010 no. 3 is a comparator standard for blasted surfaces consisting of 6 examples of grit-blasting and 6 examples of shot-blasting. Complies with ASTM D 4417/A.

Kean Tator Comparator



TQC LD2040 Comparator



Rugotest TQC LD6010 no. 3



b.) Surface Roughness Comparators – Method B:

The original **surface** comparator is the Analog Surface Profile Gauge that sits on the peaks and has a needle that goes into the valleys. The **method B** requires a minimum of **10 readings** per spot averaged together. The meter must be zeroed to a smooth surface, such as glass. With a dial gage, readings must be recorded as they are made. The common examples of surface comparators – method B, are:

- ✓ The Elcometer 123 is an easy example of the Analog Surface Profile Gauge that measures the **peak-to-valley height** of a blast cleaned surface. The average of a series of measurements provides an indication of the surface roughness and allows the surfaces to be compared as blasting proceeds. See figure shown below:
- ✓ With the emergence of electronics, the **digital gages** record average, min and max readings and download to a computer for a permanent record, such as the CR-2931 and the PosiTector SPG Surface Profile Gauge measures and records peak to valley surface profile heights. These gages conform to ASTM D4417, Method B, AS 3894.5-C. See figures shown below:



c.) Surface Roughness Comparators – Method C:

The **Testex Tape** is probably the most **common** method used to determine surface roughness profile, method C. The Tape has a compressible foam layer with a **2 mil** Mylar covering. A “*burnishing tool*” (most people call this a swizzle stick), is used to **rub** the foam into the profile. Since the foam is covered with **2 mils** of Mylar, this must be subtracted from the reading to get the surface profile.



The foam side is **rubbed** into the surface providing a permanent mold of the profile. The foam takes on the shape of the profile and it is **measured** with a spring micrometer. The Elcometer 124 Gauge is then used to measure the peak-to-valley height of a surface profile formed in Elcometer 122 Testex Tape.

Measurements are made by **firstly zeroing the gauge on 50 μm (2 mils)**, to allow the film backing. Then, place the replicated area between the anvils and gently lower the moveable anvil onto the film. The reading can now be taken, giving you the average peak-to-valley height of the blasted profile, as show below:

Obs.: Testex comes in several grades:

Course E122-B - 50 Tape Roll - 0.8 - 2 mils; **X Course E122-C** - 50 Tape Roll - 1.5 - 4.5 mils;

X Course+ E122-F - X-Course Plus - 1.5 to 8 mils.

5. Nondestructive Test Gages:

There are two types of **nondestructive DFT** generally known as **Type 1** or “**Banana Gages**” or **Type 2** “**Electronic Gages**”. Advantages and disadvantages of both types are listed below.

a) Type 1:

Advantages: No batteries; not as easy to calibrate; relatively durable; 5% accuracy; no electronics.

Disadvantages: Easier affected by operator procedures; less accurate than electronic gages; cannot store readings or do statistics; more difficult to read; works only on magnetic substrates.

b) Type 2:

Advantages: Generally not zeroed to base metal; easy calibration to base metal; faster readings; menu driven; $\pm 1\%$ to $\pm 3\%$ accuracy; statistics and memory capabilities; downloadable to a computer; will work with ferrous and nonferrous metallic substrates.

Disadvantages: Requires batteries; not durable as Type 1 gages.

6. Coating Thickness - Gage Selections:

F: For ferrous metals (steel and cast iron);

N: For non-ferrous metals (aluminum, copper, etc.);

FN: For all metal substrates - automatically recognizes the substrate and takes a measurement.



a) Wet Film Gauges:

1) Comb Gauges: Supplied in many **forms**, square, rectangular, and triangular, in metal and in plastic used only for measuring WFTs. Disposable plastic gauges are supplied in small boxes containing several hundred. The **stainless** steel gauges are supplied in **sets** of four in a leather wallet. However, all comb gauges are used in a similar manner.



The stainless steel gauges are supplied with four gauges and have two working ends covering eight different **WFT** ranges. Above each **tooth** is engraved a value “*thou*” on one side and its equivalent in **microns** on the other side. This represents the value of the gap from tooth end to substrate when the gauge is placed firmly, perpendicularly onto the substrate. A procedure for this operation would be:

- Select the **appropriate** gauge with the **smallest** increment rise tooth to tooth.
- Apply the gauge firmly, perpendicular to the substrate into the paint film ensuring that the two end lands are firmly on the substrate.
- Withdraw the **comb** gauge and look at the **teeth**.
- Two values should be recorded.

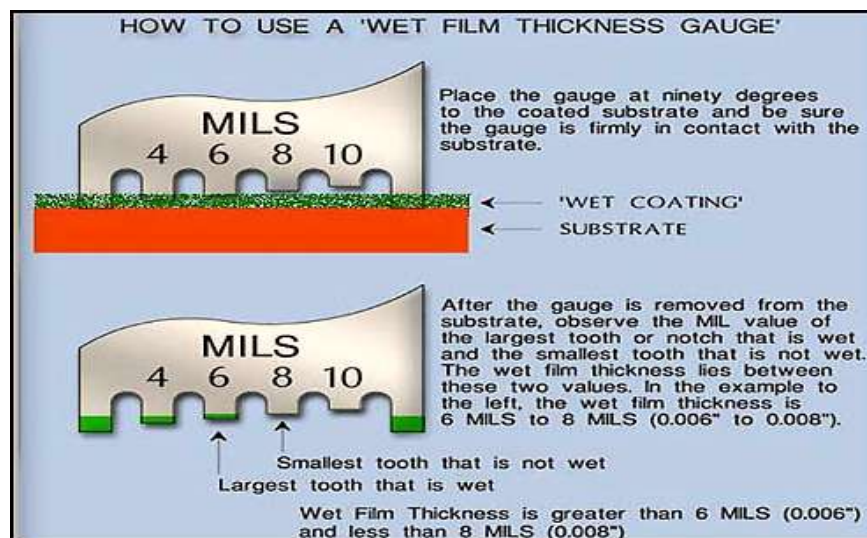

The wet-film comb can be a **flat aluminum, plastic**, or stainless steel plate with calibrated notches on the edge of each face, used on smooth surfaces, free from irregularities along the length, not the width, of curved surfaces. A wet-film gage on quick-drying coatings may show **inaccurate** measurements. The ASTM D4414 outlines a **standard** method for measurement of wet-film thickness by notch gages.

Before initiating surface **preparation** or coating operations, the temperatures (air and surface), dew point, relative humidity, and wind velocity must be checked to ensure that they conform to specification requirements. The SSPC-PA 1 Standard provides information on proper conditions for **shop** and **field** painting. ASTM E 337 dictates that the ambient condition test or environmental test should be done: “*before, during, and after*” the application and they must be monitored at least every four hour interval, even more when the conditions are unstable.

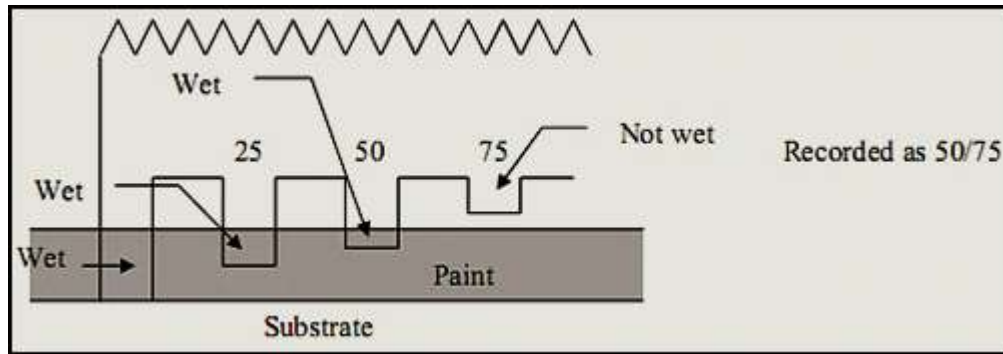

Note: The number above the **last** tooth wetted by the paint and the value of the next highest not wetted. The **WFT** is not an absolute value, but “*intermediate*”. Comb gauges should be used longitudinally on **curved** surfaces e.g. pipes.

2) Wet Film Eccentric Wheel: Consists of **three circles**. The middle circle is of smaller diameter and is eccentric of the two outer circles. By **rolling** the gauge through a wet coating, the centre disc eventually touches the film. This point on the scale indicates the thickness. Various measurement ranges from **0 to 25 µm**; 0 to 3000 µm (0 to 1 mil; 0 to 40 mils) are available. The Standard ISO 2808-7B, BS 3900-C5 method 7B, ASTM D4414-A specifies that the **wheel** must be perpendicular to the **substrate** and the thickness of the coating has to be stated as that indicated on the **central** wheel - ensuring that the wheel has been rolled from **maximum** thickness to **minimum** thickness.



3) Pfund Thickness Gage: Consists of two concentric cylinders, one sliding inside the other. A spherical glass lens is fitted to the end of the central cylinder and when pressed into the **wet** film. It **leaves a trace**. The diameter of this mark varies **depending on the thickness** of the coating, which can easily be assessed from the conversion table supplied with the instrument. This measuring range (13 to 1000 microns or 0.5 to 40 mils) is ideal for measuring total coating system thickness. Typical tolerance for this device is $\pm 3\%$. Standard methods are available in ASTM D 6132.



Obs: Ideal for measuring the thickness of **translucent** products (varnish, oils etc.). The measurement range is **2.25 – 360 μm** (0.09 - 14.17 mils).

2) Dry Film Gauges:

- **Steel substrates:** Dry coating thickness readings are commonly taken using **magnetic gages**.
- **Nonferrous metallic substrates:** Dry coating thickness readings are commonly taken using **non-magnetically** operated equipment.

1) Ultrasonic Gages: The ultrasonic pulse-echo technique of ultrasonic gages is also used to measure the **thickness of coatings** on **nonmetal substrates** (plastic, wood, etc.) without damaging the coating. Ultrasonic measurement of coating thickness works by sending an ultrasonic vibration into a coating using a probe with the assistance of a couplant applied to the surface. A 4 oz bottle of a common water-based glycol gel is included with every instrument. Alternatively, a **drop of water** can serve as couplant on smooth, horizontal surfaces. The echo waveform is digitized and analyzed to determine coating thickness. In some circumstances, individual layers in a multi-layer system can be measured. These gages have measuring ranges of **13 to 1000 microns** (0.5 to 40 mils) and are ideal for measuring **total coating** system thickness, (e.g., plastics).



2) Magnetic Thickness Gages: Magnetic gages use **one** of the two principles of operation: **Magnetic Pull-Off Gages** and **Electromagnetic Induction Gages (eddy current)**.

a) Magnetic Pull-Off Gages: Use permanent magnets as **source** of magnetic fields. One end of the spring is attached to the lever and the other end to the scale dial. The spring tension overcomes the attraction of the magnet to the substrate and lifts the magnet from the coating surface and this distance is converted to mils (or microns). Testing with magnetic gages is sensitive to surface roughness, curvature, substrate thickness, and the makeup of the metal alloy. Magnetic pull-off gages models are typically, **pencil-type** or **rollback dial**:

- **Pencil-Type:** Uses a magnet that is mounted to a helical spring that works perpendicularly to the coated surface (as shown below). A more accurate version has a tiny, precise magnet to **measure** on small, hot, or hard-to-reach surfaces. A **triple** indicator ensures accurate measurements when the gage is pointed down, up, or horizontally with a tolerance of $\pm 10\%$.



- **Rollback Dial:** Is the most common form of **magnetic pull-off gage**. By rotating the dial with a finger, the spring increases the **force** on the magnet and pulls it from the surface. These gages are easy to use and have a balanced arm to work in any position. They are **safe** in explosive environments and are commonly used by painting contractors and small powder coating operations. Typical tolerance is $\pm 5\%$.

These instruments (also called "**banana gages**"), commonly comes in 4 ranges:

- **PT-GM: 0-8 mils:** Electroplating, thin paint films, phosphating on steel.
- **PT-FM: 0-80 mils:** Hot dip galvanizing, chrome metalizing, paint, enamel, coatings on steel.
- **PT-G: 0-200 μ :** Electroplating, thin paint films, phosphating on steel.
- **PT-F: 0-2000 μ :** Hot dip galvanizing, chrome metalizing, paint, enamel, coatings on steel.



	English	Metric
Range	0.25 to 20 mils	5 to 500 microns
Tolerance	+/-10% and 0.1 mil	+/-10% and 2.5 microns
Temperature	-150° F to + 450° F	-100° C to + 230° C

b) Electromagnetic Induction Gages: Use alternating magnets as source of magnetic fields. These electronic gauges use **magnetic and eddy current principles** to measure the coating thickness on both **fer-**

rous and **non-ferrous** metals, accurately and quickly. Typical tolerance is $\pm 1\%$. Standard test methods are available in ASTM D 1186, D 7091-05, ISO 2178 and ISO 2808, SSPC-PA2. **Thinner coatings** will have stronger magnetic attraction while **thicker films** will have comparatively less magnetic attraction.

FNF Paint Gage: Is also a magnetic gage that **measures thickness of coatings on ferrous and nonferrous** metals and is an ideal instrument for **nondestructive** measurement of non-conductive coatings on non-ferrous substrates. The Paint Gage FNF probe is also designed for high resolution measurement of anodized coatings on aluminum. The device automatically recognizes the substrate and takes an accurate measurement. Gages that also include the "*pencil pull-off gages*" are very good for quick field checks but generally cannot be used for Quality Control Purposes. They are generally rated at $\pm 10\%$ to $\pm 15\%$ accuracy when used properly.

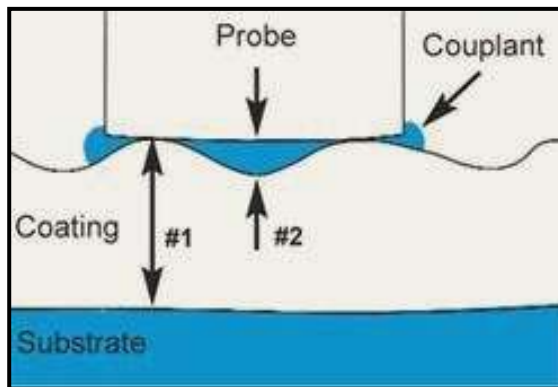

7. WFT and Holiday Testing Procedures:

Wet Film Thickness (WFT) Calculations:

Determining the **wet film thickness (WFT)** to achieve a desired dry film thickness (DFT). The **formulas are:**

a. Without Thinning the Coating Material:

$$WFT = \frac{DFT}{\% \text{ Solids by Volume}}$$

Note: Percent of solids by volume is expressed in **decimal** form.

Example:

The specified DFT is **8.0 mils**. The coating material contains 83.0 percent solids by volume. Determine the WFT to achieve an 8.0 mil DFT.

$$WFT = \frac{8}{0.83} = 9.64 \text{ mils}$$

Note: Basically, measuring and testing a **WFT of 9.64 mils** the painter will achieve a DFT of **8.0 mils**.

Holiday Testing Procedures (DFT):

To locate **pinholes** and other **defects** in **dry film thickness (DFT)** coatings using **low** or **high** voltage instruments.

a. Low Voltage for Coating Thicknesses of 20 Mils and Less:

A low voltage, normally between **5 and 90 volts DC**, battery powered device, commonly uses a **wet sponge electric probe** that is passed over the coated surface to locate discontinuities (pinholes). When discontinuities are found, an electric current will flow to the steel substrate with an **audible or visual alarm**.

Procedure:

1. Attach the electrical ground (negative) wire from the instrument to the steel substrate.
2. Wet the sponge probe with potable water.
3. Turn the instrument switch to the "on" position.
4. The sponge is to be moved over the coating surface at about 1 foot per second, the sponge should be kept saturated, but not dripping wet, while moving over the coating.
5. When a discontinuity is detected, the sponge is to be turned on edge to **determine the exact spot** of the defect, and the spot is **to be marked for repair**. Use a greaseless marker that can be easily cleaned off.

b. Thinning the Coating Material:

$$WFT = \frac{DFT}{(\% \text{ Solids by Volume})} (1 + \% \text{ by Volume of Thinners Added})$$

Note: The percent of solids and thinners added by volume is expressed in **decimal** form.

Example:

The specified DFT is **6.0 mils**. The surface areas require **5 gallons of thinned paint**. The coating material contains **86 percent solids**, by volume. The manufacturer's instructions state **1½ pints** of thinner is added to **each gallon** of coating materials (**8 pints = 1 gallon**). Determine the WFT to achieve a 6.0 mil DFT.

$$\text{Percent thinner added} = \frac{1.5 \text{ pints per gallon}}{16 \text{ pints per gallon}} (100) = 9.38\%$$

$$\text{expressed as decimal} = \frac{9.38}{100} = 0.09$$

$$WFT = \frac{6}{0.86} (1.09) = 7.60 \text{ mils}$$

Note: Basically, measuring and testing a **WFT of 7.60 mils** the painter will achieve a DFT of **6.0 mils**.

b. High Voltage for Coating Thickness Greater Than 20 Mils:

A high-voltage device, normally of **800 volts DC**, may also use a **wet sponge electric probe** that is passed over the coated surface to locate discontinuities (pinholes). When discontinuities are found, an electric current will flow to the steel substrate with an **audible or visual alarm**. A general rule-of-thumb for determining the required voltage is **100 to 125 volts** per each coating mil.

Procedure:

1. If moisture is present, dry the surface before testing because moisture will indicate invalid discontinuities.
2. Adjust the instrument to the proper voltage setting for the coating thickness.
3. Attach the electrical ground (negative) wire from instrument to the steel substrate.
4. Turn the instrument switch to the "on" position.
5. Touch the probe to a bare conductive (steel) substrate to verify that it is properly grounded. Electric sparks should be seen, or an alarm signal should be activated.
6. Using a single pass, move the probe over the coated surface at a rate of about 1 foot per second.
7. When a discontinuity is detected, **mark the spot for repair**. Use a greaseless marker that be easily cleaned off.

1. Types of **high voltage** holiday testers:
 - a. **Pulse type:** discharges a cycling, high-voltage pulse
 - b. **Direct current:** discharges continuous voltage.
2. Types of **electrodes and probes:**
 - a. Half or full-circle spring electrodes used for pipes;
 - b. Phosphor bronze brush probes;
 - c. Conductive rubber strip probes.

8. Adhesion & Destructive Testing Procedures:

Painting destructive tests are all coating and painting evaluation tests for permeability, hardness, penetration, adhesion, abrasion resistance, colour retention, gloss retention, bend, salt spray and other coating characteristics. The ASTM's **painting** and related **coating** standards specify and evaluate the physical and chemical properties of various paints and coatings that are applied to certain bulk materials to improve their surface properties. These painting and related coating standards **help** paint manufacturers and end-users in the appropriate testing and application procedures for the coating of their concern.

The destructive and adhesion testing includes:

- ✓ Tooke Gauge (Paint Inspection Gauge);
- ✓ Dolly Pull-Off Adhesion Testing;
- ✓ Knife or Tape Adhesion Testing;
- ✓ Cross Hatch Testing;
- ✓ Pencil Hardness.



Type 2 – Final Painting Thickness Measurement



Method A - X-Cut Test and Adhesion Tape



Method B – Cross-cut and Dual Guide Tool



Multi Use – Cross-cutter Tester



Adhesion Test Tapes ASTM D 3359



Heat Exchanger Final Painting Evaluation



Pull-off Adhesion Test Dolly Type II



Pull-off Adhesion Test Dolly Type III



Pull-off Adhesion Test Dolly Type III



Pull-off Adhesion Test Dolly Type IV



Pull-off Adhesion Test Dolly Type V

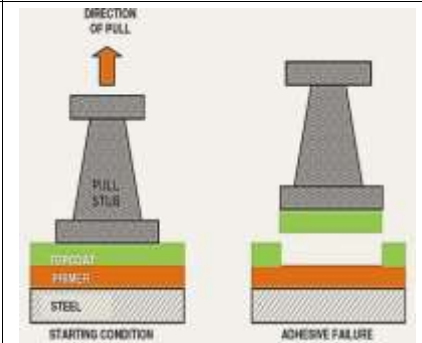

Dollies Cohesive Tests

Note: There is no standard design for these loading fixtures or “dollies”. The fixtures for the **Type 2**, **Type 4** and **Type 5** are **aluminum** and are generally used once then discarded. The **Type 3** fixture is **stainless steel** and the **Type 6** fixture is **carbon steel**.

1) Tooke Gauge: One destructive technique is to use a special cutting tool to make a small, precise **V-groove** through the coating and into the substrate with the **Tooke Paint Inspection Gauge** and measure the film thickness by viewing the cut microscopically (in accordance with ASTM D4138). These gages are available complete, with illuminated 50-power microscope with measuring reticle, and tungsten carbide cutting tips to be mounted for precise incision of the work surface.

- **Operation:** A special **cutting tool** (the “*cutting tip*”) integral to the gage is used to incise a small precision V-groove through the **paint film** and into the substrate. The gage in standard configuration mounts 1×, 2×, and 10× cutting tips. An optional 5× tip is also available. The gage can also be ordered with three tips of the same size or in any desired configuration (including a single cutting tip with two non-functioning blanks).

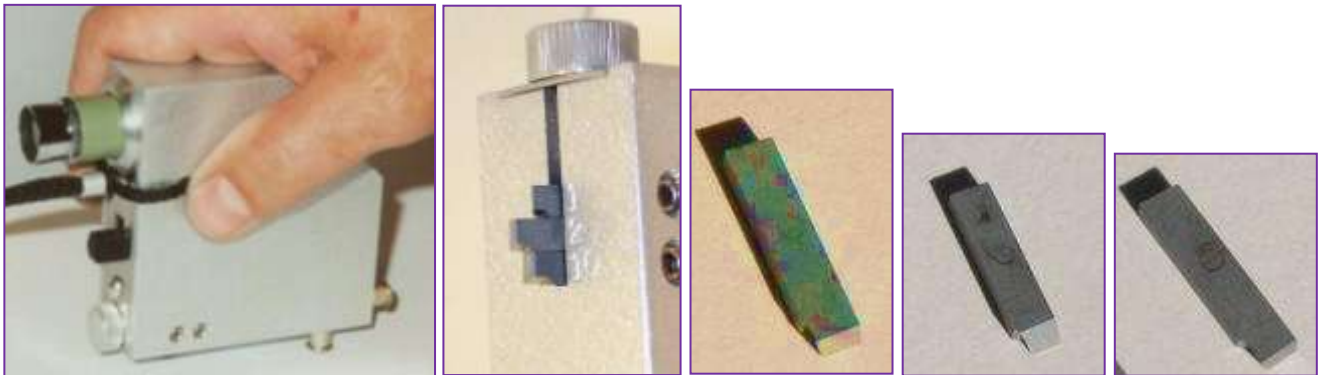

- **Principle:** The incised V-groove is observed vertically through an **illuminated microscope** bearing a measuring reticle (scale). An **English** version has the reticle marked in **mils**, and a **Metric** version has the reticle marked in **microns**. The use of this gage can be **tedious and slow**, and it creates voids (cuts) in the coating system that must be repaired. The **gage becomes impractical** on large field structures where paint thickness often lacks uniformity. However, the Tooke gage is often used as a final determination of thickness at specific, selected locations.

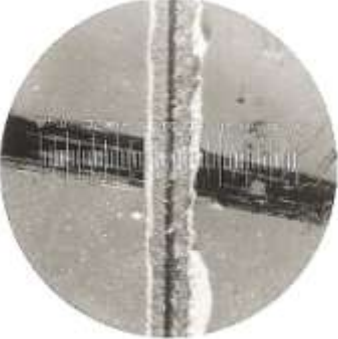
	English Reticle Specifications:			
	Cutting tip	Maximum Coating Thickness	Precision of thickness	One division on the reticle scale represents:
	1×	100 mils	± 0.25 mils	1.0 mil
	2×	20 mils	0.13 mils	0.5 mil
	10×	1.0 mil	0.025 mils	0.1 mil

Note: When is necessary to test the **adhesion** characteristics of the coating film after application, adhesion testing is commonly conducted by two field methods: **Dolly Pull-off and Tape Adhesion Testing**.

2) Dolly Pull-Off Adhesion Testing: A pull stub is **adhered** to the coating surface using an **epoxy** adhesive. The pulling force (in psi) required to disbond the pull stub measures the coating tensile adhesion. The break in the coating is described as: adhesion (a break between layers), cohesion (a break within a coat-

ing layer), or glue (failure of the pull stub to adequately bond to the surface of the coating). The pull-off adhesion **testing** is performed in accordance with ASTM D4541-89.



3) Knife or Tape Adhesion Testing: Requires making an **X-cut** or a series of parallel and perpendicular knife cuts through the coating (cross-hatch grid). Then pull the **tape** from the X or grid, and evaluating the percentage of disbanded coating. The **X-cut** (Method A) is used for coating thickness **above 0.125 mm** (5 mils). The **grid** or cross-hatch (Method B) is used for coatings **up to 0.125 mm** (5 mils).

- ✓ **Method A - Tape Adhesion Testing:** This method is used on coatings **above 5 mils thick**. An **“X” cut** is made in the coating to the substrate. Pressure sensitive tape is applied over the **“X”** cut and pulled off. Coating adhesion is assessed by a comparison scale of **0A** (lowest) to **5A** (highest), as described in the standard. This test is primarily intended for use at **job sites**.

Operation: Using a sharp razor blade, scalpel, knife or other cutting device, two cuts are made into the coating with a 30 – 45 degree angle between legs and down to the substrate which intersects to form an **“X”**. A steel or other hard metal straightedge is used to ensure straight cuts. Tape is placed on the center of the intersection of the cuts and then removed rapidly.

- Make a single **1.5 inch** cut through the coating system. Avoid multiple passes;
- Make a second cut to form an **“X”**;
- Consider a 30-45° angle at intersection of the **“X”**.

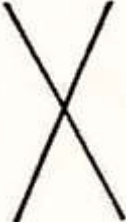
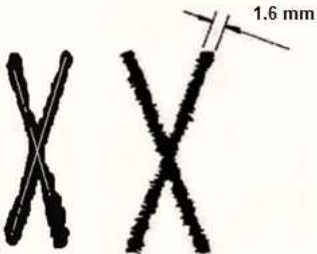
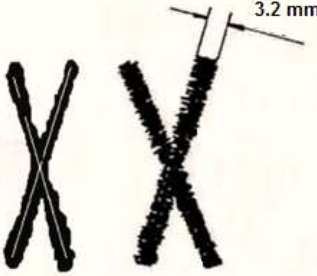
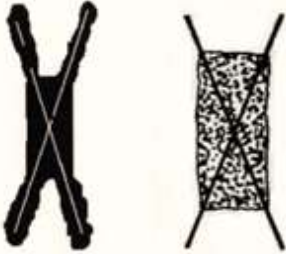
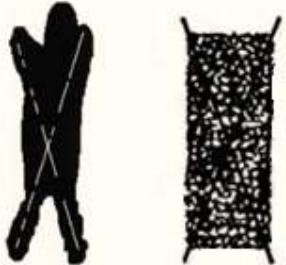

Tape adhesion X-cut classification - ASTM D 3359 – Method A:

	<p style="text-align: center;">5A</p> <p style="text-align: center;">No peeling or removal.</p>
	<p style="text-align: center;">4A</p> <p style="text-align: center;">Trace peeling or removal along incisions or at their intersection.</p>
	<p style="text-align: center;">3A</p> <p style="text-align: center;">Jagged removal along incisions up to 1/16" (1.6mm) on either side.</p>
	<p style="text-align: center;">2A</p> <p style="text-align: center;">Jagged removal along most of incisions up to 1/8" (3.2mm) on either side.</p>
	<p style="text-align: center;">1A</p> <p style="text-align: center;">Removal from most of the area of the X under the tape.</p>
	<p style="text-align: center;">0A</p> <p style="text-align: center;">Removal beyond the area of the X.</p>

- ✓ **Method B:** Is more suitable for use in the **laboratory**, and is considered suitable for films from **2 mils (50 µm) to 5 mils (125 µm)** thick. This test should be performed by qualified and experienced personnel according to ASTM D 3359.
- ✓ **Cross-Cut Procedures:** For coatings having a DFT up to and including **2.0 mils (50 µm)** space the cuts 1 mm and make eleven cuts unless otherwise agreed upon. For coatings having a **DFT between 2.0 mils (50 µm) and 5 mils (125 µm)**, space the cuts 2 mm and make six cuts. For films thicker than 5 mils use X – cut Test Method A.

Operation: Make all cuts about **20 mm (3/4 in.) long**. Cut the film to the substrate in one steady motion using sufficient pressure on the cutting tool until the cutting edge reaches the substrate. Making successive single cuts with the aid of a guide, place the guide on the uncut area. After making the required cuts brush the film lightly with a soft brush to remove detached flakes or ribbons of coatings. Place the center of the tape over the grid using a finger.

To ensure good contact with the film rub the tape firmly with aid of a pencil. The color under the tape is an indication of when good contact has been made. Within 90s of application, remove the tape by seizing the free end, rapidly, as close to an angle of 180° as possible. Inspect the grid area for removal of coating from the substrate or from a previous coating using the illuminated magnifier. Rate the adhesion in accordance with the following **scale illustrated below**:

- **5B** - The edges of the cuts are completely smooth; none of the squares of the lattice is detached.
- **4B** - Small flakes of the coating are detached at intersections; less than 5 % of the area is affected.
- **3B** - Small flakes of the coating are detached along edges and at intersections of cuts. The area affected is 5 to 15 % of the lattice.
- **2B** - The coating has flaked along the edges and on parts of the squares. The area affected is 15 to 35 % of the lattice.
- **1B** - The coating has flaked along the edges of cuts in large ribbons and whole squares have detached. The area affected is 35 to 65 % of the lattice.
- **0B** - Flaking and detachment worse than Grade 1.

Compact instruments for making 1.0, 1.5, 2.0, 3.0, 4.0, 4.5, 5.0 and 6.0 mm spaced cross-cuts on both smooth and flat surfaces as well as somewhat rough coated surfaces.

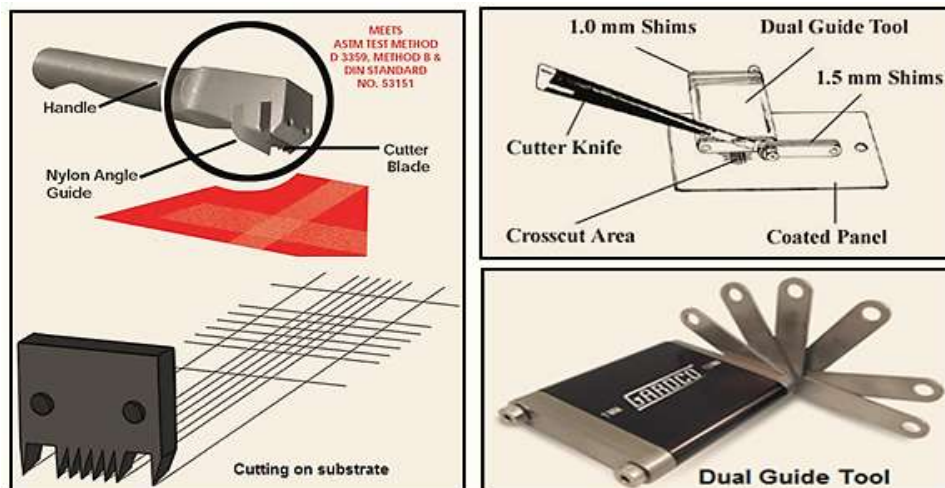

Tape adhesion cross-cut classification - ASTM D 3359 – Method B:

Cross Cut Test

Adhesion

The cross-cut test is a simple and easily practicable method for evaluating the adhesion of single- or multi-coat systems.

Procedure

- Make a lattice pattern in the film with the appropriate tool, cutting to the substrate
- Brush in diagonal direction 5 times each, using a brush pen or tape over the cut and remove with Permacel tape
- Examine the grid area using an illuminated magnifier

Cross-Cut Results

Adhesion is rated in accordance with the scale below.

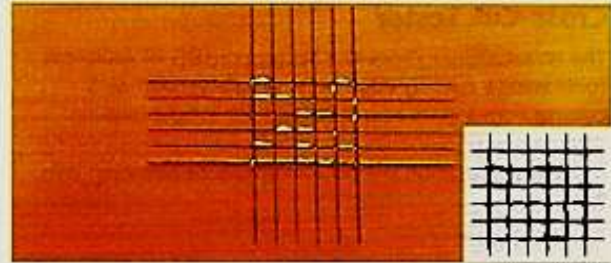

■ ISO Class.: 2 / ASTM Class.: 3 B

The coating has flaked along the edges and/or at the intersections of the cuts. A cross-cut area significantly greater than 5 %, but not significantly greater than 15 %, is affected.

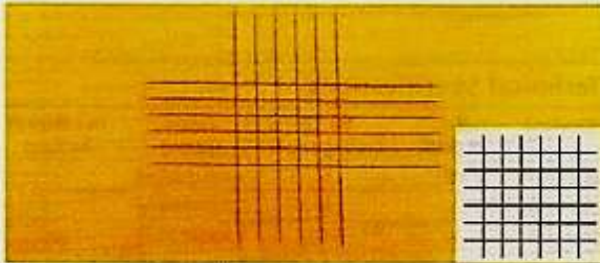

■ ISO Class.: 0 / ASTM Class.: 5 B

The edges of the cuts are completely smooth; none of the squares of the lattice is detached.

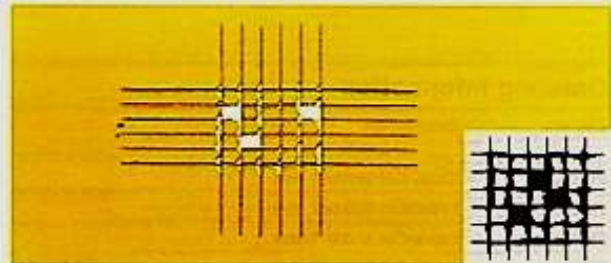

■ ISO Class.: 3 / ASTM Class.: 2 B

The coating has flaked along the edges of the cuts partly or wholly in large ribbons, and/or it has flaked partly or wholly on different parts of the squares. A cross-cut area significantly greater than 15 %, but not significantly greater than 35 %, is affected.

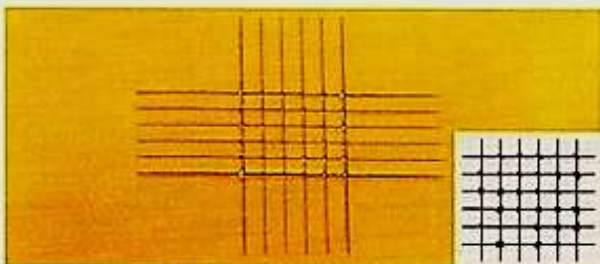

■ ISO Class.: 1 / ASTM Class.: 4 B

Detachment of small flakes of the coating at the intersections of the cuts. A cross-cut area not significantly greater than 5 % is affected.

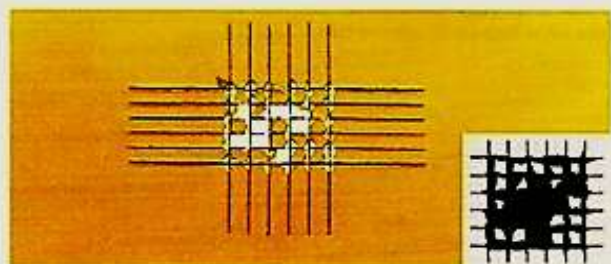

■ ISO Class.: 4 / ASTM Class.: 1 B

The coating has flaked along the edges of the cuts in large ribbons and/or some squares have detached partly or wholly. A cross-cut area significantly greater than 35 %, but not significantly greater than 65 %, is affected.

■ ISO Class.: 5 / ASTM Class.: 0 B

Any degree of flaking that cannot even be classified by classification 4.

Standards

ASTM	D 3002	D 3359
------	--------	--------

Cutter Standards Reference:

000/1	1mm Spacing Cross Hatch Cutter	6 cutting edges
000/2	1mm Spacing Cross Hatch Cutter	11 cutting edges
000/3	1,5mm Spacing Cross Hatch Cutter	6 cutting edges
000/4	2mm Spacing Cross Hatch Cutter	6 cutting edges
000/5	3mm Spacing Cross Hatch Cutter	6 cutting edges

9. Base Metal Reading (BMR):

All gages should be zeroed, due many factors can affect the magnetic properties of steel during its manufacture. There are areas in the profile that are “**less than the zero point**” (Blue Paint), and the meter cannot register any paint as being applied to the surface until it is greater than the zero point, as **showed in figure below**. Generally, the BMR is between 0.5 and 1 mil.

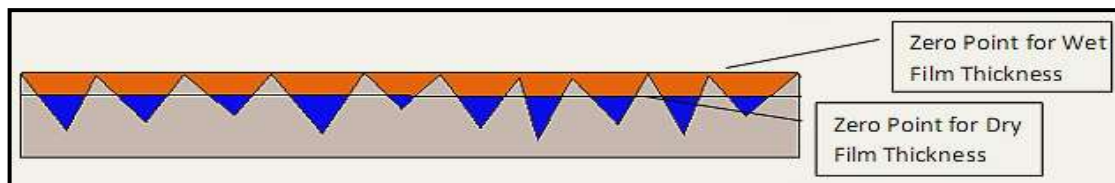

Obs.: This is probably one of the most misunderstood concepts in coating thickness testing. There are two separate properties that affect the BMR:

1. The magnetic properties of the steel;
2. The surface profile of the steel.

Holiday Testing: A **holiday** is a fail on the coating film, while a **pinhole** is typically a microscopic hole in the coating film. Pinholes can be present in any coating layer and should be closed before the next coat is applied. Pinhole testing is common when the coating is intended for immersion service. Holiday, pinhole, or spark testing can be used to find the nicks, scrapes, and pinholes in the coating film

Holiday testing may be required **after application** of either the next to the last coat of paint. Usually when such testing is specified, the test is **done when the coating is sufficiently dry** but before final cure has occurred so that repair material will successfully bond to the underlying coats.

There are **two types** of holiday testing: **low voltage wet sponge and high voltage**. The applied voltage is based on the coating thickness and the coating dielectric strength. Using voltages that are too high or leaving the instrument in one place too long may damage the coating by sparking or burning through the coating. Thin coatings are more susceptible to voltage damage.

- Low-voltage testers are used on thin films (20 mils and less);
- High-voltage testers are commonly used on high build films (20 mils or greater) or as determined by the manufacturer to prevent coating damage.

- ✓ **Low Voltage Wet Sponge:** Is used to detect cracks and damaged areas in coatings up to a maximum thickness of **500 microns**, by the application of a wet sponge to the coating. The wetting agent penetrates any pinhole and makes a conductive path through to the substrate.
- ✓ **Operation:** The holiday or pinhole detector automatically detects a conductive path and sounds an **audible alarm** and also gives a **visual warning** by a **flashing red** indicator that a pinhole fault has been detected. The flaw can now **be marked** for repair and further testing resumed. There are a range of **circular sponges** that can be used for testing internal pipework coatings. The selectable precision test voltages are **9, 67.5, and 90 Volt**, which comply with ASTM specifications. Generally **9 Volt** will test up to **300 μ** and **90 Volt** will test up to **500 μ** (micron).



- ✓ **High Voltage Holiday Detector:** As described are used to locate pinholes, air bubbles, and porosity in non-conductive coatings on conductive substrates, including concrete. A power supply within the instrument generates a **high DC voltage** that is supplied to a suitable probe. As the probe is passed over the coated surface, a **flaw is indicated by a spark** at the contact point with an **audible alarm** indicating a **visual alarm** in the probe handle. For example, the measuring ranges for Model DC15 and Model DC30 are: **0 to 15,000 V; 0 to 30,000 V**, respectively.
- ✓ **Porosity Detector:** Porosity detection of tanks, valves, pumps, pipeline field joints and general inspection and maintenance, suitable for a **broad range** of testing and inspection requirements, recommended that the integral probe be limited to a **5"** (125mm) wide flat **brush** or a **fan** brush electrode. Ranges: **0 to 10,000 V - 9V** battery.



Suggested voltages in NACE RP0188 are:

Mils	V
8 to 11	1,500
12 to 15	2,000
16 to 20	2,500
21 to 40	3,000
56 to 80	6,000
81 to 125	10,000
126 to 185	15,000

Obs.: Testing of coatings that contain electrically **conductive** pigments, such as **aluminum** flakes, graphite, or zinc **is not recommended** because an electric discharge may spark through the coating at conductive particles, **damaging** the coating or indicating discontinuities where none exist. The coating specifications reference is ASTM D 5162 for **holiday** testing, and NACE RP 0188, but the NACE version is **more** complete and easier.

Probes Types:

1. Wire Brush Probe: in various sizes up to **40 inches** and works well on large surfaces.
2. Rubber Brush Probe: is a conductive rubber strip that works well on large, smooth flat surfaces.
3. Internal Pipe Probe: diameters from 1.5 inches to 12 inches for testing internal pipe coatings.
4. External Pipe Probe: in sizes from 2 inches to 36 inches for testing up to 360° external coating.

Note: The **rule of thumb** for high-voltage testing is **100 to 125 V per mil**. For example, a **1.02 mm** (40 mil) coat will require a **test** voltage of **4,000 to 5,000 V**. Too high a test voltage may damage the coating film, as a **spark** may penetrate a thin, intact area of the coating and create a void that must be repaired.

10. DFT Rules:

The **DFT 80** means that not less than **80%** of the specified, be measured without **repair** being undertaken, and the **DFT 20** means that no more than **20%** of the measurements may be **below** of the specified DFT. The customer buys a certain dry film thickness according to a defined **specification**. In practice we know that a job is never perfect, but on the other hand insufficiencies should not be too large in quantity. The accuracy of making the correct decision is invariably linked to taking a certain amount of **readings**, at random, as an example, by the "**80-20**"- Rule, as shown below:

Area/length of inspection area m ² or m	Minimum number of measurements	Maximum number of measurements allowed to be repeated
up to 1	5	1
above 1 to 3	10	2
above 3 to 10	15	3
above 10 to 30	20	4
above 30 to 100	30	6
above 100*	add 10 for every additional 100 m ² or 100 m or part thereof	20% of the minimum number of measurements
Area above 1000 m ² or m should be divided into smaller areas		

Note: Several international, as well as, local standards are now paying interest to **statistical** methods, when checking **DFT**. However, currently both ISO and SSPC have issued standards. Below is showed the sampling plan described in ISO 19840. For details, refer to the **standard**. The defined formula for calculating the **volume solids** after the **thinning** is shown below. The paint thinning affects the volume solids. Calculate as follows:

$$VS\% \times \frac{100}{(100 + \%THINNING)} =$$

HIGH BUILD & HIGH SOLIDS PAINTS											
MICRON DRY	VOLUME SOLIDS %										
	50	55	60	65	70	75	80	85	90	95	100
40	80										
45	90										
50	100	91									
55	110	100									
60	120	109	100								
65	130	118	108								
70	140	127	117	108	100						
80	160	145	133	123	114	107	100				
90	180	164	150	138	129	120	113	106	100		
100	200	182	167	154	143	133	125	118	111	105	100
125	250	227	208	192	179	167	156	147	139	132	125
150	300	273	250	231	214	200	188	176	167	158	150
175		318	292	269	250	233	219	206	194	184	175
200			333	308	286	267	250	235	222	211	200
225				346	321	300	281	265	250	237	225
250				385	357	333	313	294	278	263	250
275					393	367	344	324	306	289	275
300					429	400	375	353	333	316	300
350						467	438	412	389	368	350
400							500	471	444	421	400
450								529	500	474	450
500									556	526	500

ENAMELS AND SHOPPRIMERS											
MICRON DRY	VOLUME SOLIDS %										
	15	20	25	30	35	40	45	50	55	60	
15	100	75	60	50	43						
20	133	100	80	67	57						
25	167	125	100	83	71	63	56				
30	200	150	120	100	86	75	67	60	55		
35		175	140	117	100	88	78	70	64	58	
40		200	160	133	114	100	89	80	73	67	
45			180	150	129	113	100	90	82	75	
50			200	167	143	125	111	100	91	83	

Dew Point Table: Dew point is the **highest** temperature at which airborne water **vapor** will condense to form liquid **dew**. A higher dew point means there will be more **moisture** in the air. Dew point is sometimes called "**frost point**" when the temperature is below freezing. The **measurement** of dew point is related to humidity. The relative humidity rises as the temperature falls. This is because more water vapor condenses as the temperature falls further beneath the dew point.

Dew point temperature is never **greater** than the air temperature because relative humidity cannot exceed 100%. Below is given dew points in **°C and °F** up to **50°C and 122°F**, for a number of situations, as determined by a Sling Psychrometer. When the Inspector **cannot find exact readings** on the Sling Psychrometer, this useful table shows both **%RH** and corresponding **temperature**. One step lower, may be **interpolated**, straight forward between them.

°C	0	5	10	15	20	25	30	35	40	45	50
°F	32	41	50	59	68	77	86	95	104	113	122

RELATIVE HUMIDITY %RH	DRY BULB TEMPERATURE °C										
	0	2,5	5	7,5	10	12,5	15	17,5	20	22,5	25
20	na	na	na	-14	-12	-9,8	-7,7	-5,6	-3,6	-1,5	0,5
25	na	na	na	-11	-9,1	-6,9	-4,8	-2,7	-0,6	1,5	3,6
30	na	na	na	-8,9	-6,7	-4,5	-2,4	-0,2	1,9	4,1	6,2
35	na	na	-9,1	-6,9	-4,7	-2,5	-0,3	1,9	4,1	6,3	8,5
40	na	na	-7,4	-5,2	-2,9	-0,7	1,5	3,8	6,0	8,2	10,5
45	na	na	-5,9	-3,6	-1,3	0,9	3,2	5,5	7,7	10,0	12,3
50	na	na	-4,5	-2,2	0,1	2,4	4,7	7,0	9,3	11,6	13,9
55	na	na	-3,3	-0,9	1,4	3,7	6,1	8,4	10,7	13,0	15,3
60	na	-4,4	-2,1	0,3	2,6	5,0	7,3	9,7	12,0	14,4	16,7
65	na	-3,4	-1,0	1,4	3,7	6,1	8,5	10,9	13,2	15,6	18,0
70	na	-2,4	0,0	2,4	4,8	7,2	9,6	12,0	14,4	16,8	19,1
75	na	-1,5	1,0	3,4	5,8	8,2	10,6	13,0	15,4	17,8	20,3
80	na	-0,6	1,9	4,3	6,7	9,2	11,6	14,0	16,4	18,9	21,3
85	na	0,2	2,7	5,1	7,6	10,1	12,5	15,0	17,4	19,9	22,3
90	na	1,0	3,5	6,0	8,4	10,9	13,4	15,8	18,3	20,8	23,2
95	na	1,8	4,3	6,8	9,2	11,7	14,2	16,7	19,2	21,7	24,1
100	0,0	2,5	5,0	7,5	10,0	12,5	15,0	17,5	20,0	22,5	25,0

RELATIVE HUMIDITY %RH	DRY BULB TEMPERATURE °C										
	25	27,5	30	32,5	35	37,5	40	42,5	45	47,5	50
20	0,5	2,6	4,7	6,7	8,8	10,8	12,9	14,9	17,0	19,0	21,0
25	3,7	5,8	7,9	10,0	12,1	14,2	16,3	18,4	20,5	22,6	24,7
30	6,3	8,5	10,6	12,8	14,9	17,1	19,2	21,4	23,5	25,7	27,8
35	8,5	10,7	13,0	15,1	17,3	19,5	21,7	23,9	26,1	28,3	30,5
40	10,5	12,8	15,0	17,2	19,5	21,7	23,9	26,2	28,4	30,6	32,8
45	12,3	14,6	16,8	19,1	21,4	23,6	25,9	28,2	30,4	32,7	34,9
50	13,9	16,2	18,5	20,8	23,1	25,4	27,7	30,0	32,3	34,5	36,8
55	15,4	17,7	20,0	22,4	24,7	27,0	29,3	31,6	33,9	36,3	38,6
60	16,7	19,1	21,4	23,8	26,1	28,5	30,8	33,2	35,5	37,8	40,2
65	18,0	20,4	22,8	25,1	27,5	29,9	32,2	34,6	36,9	39,3	41,7
70	19,2	21,6	24,0	26,4	28,8	31,1	33,5	35,9	38,3	40,7	43,1
75	20,3	22,7	25,1	27,5	29,9	32,4	34,8	37,2	39,6	42,0	44,4
80	21,3	23,8	26,2	28,6	31,1	33,5	35,9	38,3	40,8	43,2	45,6
85	22,3	24,8	27,2	29,7	32,1	34,6	37,0	39,5	41,9	44,4	46,8
90	23,3	25,7	28,2	30,7	33,1	35,6	38,1	40,5	43,0	45,5	47,9
95	24,1	26,6	29,1	31,6	34,1	36,6	39,1	41,5	44,0	46,5	49,0
100	25,0	27,5	30,0	32,5	35,0	37,5	40,0	42,5	45,0	47,5	50,0

Wind Measurements: Not only the humidity and air temperature **decides** the coating conditions, but for painting in the open, also **wind** may become an important **factor**. Below is given the standard wind scales used and comments regarding suitability for airless spray application.

Beaufort number (force)	Wind Speed				WMO Description	Comments
	s	mph	m/s	km/h		
0	<1	<1	0	<1	Calm	Painting possible with standard consumption factor.
1	1-3	1-3	1	1-5	Light air	
2	4-6	4-7	2-3	6-11	Light breeze	Painting may be possible Excessive consumption factor Severe risk of dry spray
3	7-10	8-12	4-5	12-19	Gentle breeze	
4	11-16	13-18	6-7	20-28	Moderate breeze	
5	17-21	19-24	8-10	29-38	Fresh breeze	Painting not possible
6	22-27	25-31	11-13	39-49	Strong breeze	
7	28-33	32-38	14-16	50-61	Near gale	
8	34-40	39-46	17-20	62-74	Gale	
9	41-47	47-54	21-24	75-88	Strong gale	
10	48-55	55-63	25-28	89-102	Storm	

11. Immersion Painting Cure Evaluation:

When a coating is designed for **immersion** service, the applied coating film must be allowed to cure **prior** to being placed into service. This curing time generally is shown on the manufacturer's product information. Alternately, forced-heat curing may be used to reduce the time between curing and service and solvent rub **tests** and sandpaper tests can be used to approximate the degree of cure. When most coatings are suitably cured, rubbing them with **sandpaper** will produce a fine dust. If the sandpaper gums up, depending on the coating, it may not be cured properly. A **solvent rub test** is frequently performed to check the cure of **inorganic zincs**. For this test, a **cloth** saturated with MEK (methyl ethyl ketone) is rubbed onto the coating a specific number of times.

Note: Epoxies, urethanes, and other generic coatings (catalyzed and non-catalyzed) can be evaluated for cure according to ASTM D1640, which describes procedures for conducting set-to-touch, dust-free, tack-free, dry-to-touch, dry hard, dry through, dry-to-recoat, and print-free dry/curing times.

Units of Measurements: The normal **standard** used in thickness measurements is the **mil**, where **1 mil = 0.001 inch** (or equal to a thousandth of an inch (1/1000"). So if the manufacturer's specified thickness is **2 to 5 mils**, the final cured thickness of the painting should be between **0.002 and 0.005 of an inch**. The metric unit of measurement is called the micron where **1 mil = 0.0254** (or equal to 25.4 microns).

IX. CONCRETE COATING INSPECTIONS:

The protection linings or coating of **concrete** is also daily used as a building material, but commonly experience coating **failures**. These failures greatly increase the potential for premature **degradation** of the substrate material and typically incur additional expenditure of resources to repair. Assuming the concrete surface has been determined to be sound, and is not compromised by **contaminants**, such as dust, oil and grease, the moisture level in the concrete should be **suitable** for painting, lining or coating and also must be part of a **quality** control program for coating application.



One of the first considerations in assuring **coating quality control** is the compatibility of the concrete's physical surface **texture** (also known as the anchor or surface "*profile*") with the coating to be applied. The recent ASTM standard D7682 "*Standard Test Method for Replication and Measurement of Concrete Surface Profiles Using Replica Putty*" references both **Method A** (visual comparison) and **Method B** (quantifiable measurement) as means to determine the qualitative concrete surface profile.

a) Concrete Coating Thickness: The primary purpose for measuring the coating **thickness** on concrete is to control coating costs, while ensuring adequate **protective** coverage. Commercial contracts often require an independent **inspection** of the work upon completion. Ultrasonic coating thickness gages are also utilized within the scope of **SSPC-PA 9** "*Measurement of Dry Coating Thickness on Cementitious Substrates Using Ultrasonic Gages*". This method **determines** the coating thickness by averaging a prescribed minimum number of **acceptable** (under the method) gage readings within separate **spot** measurement areas of a coated surface.

b) Concrete Floor Coatings: These elements are **special resins** (most often **polyurethane** or **epoxy**) that when properly applied create an **impenetrable** coating, or layer on cement preventing the transmission of water and **contaminants**, while also keep the structure safe. Installation of resinous **flooring** is commonly used for sealing, waterproofing, repairing, restoration and resurfacing of concrete. Flexible polymer coatings and **pre-cast** cement structures, such as parking ramps and mechanical rooms, waterproofing and protectors are commonly used **against** chemicals and physical abuse. Oil, salt and other chemicals can cause damage to structures, especially in high traffic areas.

c) Concrete Polishing: Concrete polishing is the process of mechanically and chemically transforming concrete to an **attractive** easy to **clean** finish with various levels of **gloss** options and aggregate exposure. Simply put, polishing concrete is similar to sanding wood. Heavy-duty concrete polishing machines equipped with progressively finer **grits** of diamond-impregnated abrasives are used to gradually grind down surfaces to the desired degree of shine and smoothness.



d) Concrete Coating Adhesion Tests: The “*pull-off adhesion testing*” is commonly used for measurement of the **resistance** of a concrete coating to separation from a substrate, with a device applied perpendicular tensile force. Portable **pull-off** adhesion testers (as shown below the Posi Test AT Automatic & Manual) measure the force required to pull a specified diameter of coating away from its substrate. The **major** components of a **pull-off** adhesion tester are; a pressure source, a pressure gage and an actuator. During **operation**, the flat face of a pull **stub** (dolly) is **adhered** to the coating to be evaluated. After allowing for the bonding adhesive to **cure**, a coupling connector from the actuator is attached to the dolly. By activating the pressure source, pressure is slowly increased to the actuator within the system.



e) Building Insulation: Polyurethane **spray** foam is rapidly becoming the product of choice for commercial, industrial and institutional entities looking for ways to limit energy consumption and maximize energy savings. Polyurethane spray **foam** eliminates air infiltration and actually increases the strength of a building, while creating an airtight “*envelope*” that will fill all the **cracks** and **voids** around windows, electrical outlets and plumbing **penetrations**. With the elimination of air infiltration, spray foam also helps control **moisture** and reduces HVAC equipment requirements and operational costs. A tight building envelope will reduce energy costs and provide better air quality inside your building. As energy costs continue to rise, it

is incumbent upon building owners to protect their pocketbooks by investing in proven, sustainable methods for conserving energy.



LINKS AND REFERENCES:

<https://nace.org/> - **NACE**: National Association of Corrosion Engineers.

<https://www.sspc.org/> - **SSPC**: Steel Structures Painting Council; **SSPC**: Painting Manual - 1991.

<https://www.awwa.org/> - **AWWA**: American Water Works Association.

<https://www.osha.gov/> - **OSHA 29 CFR 1926.16**: Rules of Construction.

<https://www.milspeccoating.com/>

SSPC No. 91-12, 1991: Coating and Lining Inspection Manual.

SSPC No. 91-12, 1997: The Inspection of Coatings and Linings, a Handbook of Basic Practice for Inspectors, Owners, and Specifiers.

MIL-C-18480A: Coating Compound, Bituminous, Solvent, Coal Tar Base.

MIL-C-83286B: Coating, Urethane, Aliphatic Isocyanate, for Aerospace Applications.

MIL-P-14105C: Paint, Heat Resisting, (for Steel Surfaces).

MIL-P-24441A: Paint, Epoxy-polyamide, General Specifications.

ASTM B499: "Measurement of Coating Thicknesses by the Magnetic Method: Nonmagnetic Coatings on Magnetic Basis Metals."

ASTM D1186: "Nondestructive Measurement of DFT of Nonmagnetic Coatings Applied to a Ferrous Base"

ASTM D1400: "Nondestructive Measurement of DFT of Nonconductive Coatings Applied to a Nonferrous Metal Base."

ASTM E376: "Measuring Coating Thickness by Magnetic-Field or Eddy-Current Test Methods."

ASTM G12, "Nondestructive Measurement of Film Thickness of Pipeline Coatings on Steel."

ASTM D714: "Standard Test Method for Evaluating Degree of Blistering of Paints"

ASTM D1475: "Test Method for Density of Paint, Varnish, Lacquer and Related Products".

ASTM D1640: "Drying Test Methods, Curing, Film Formation of Organic Coatings at Room Temperature".

ASTM D 3359: "Measurement of Adhesion by Tape Test".

ASTM D 6677: "Knife Adhesion Test".

ASTM D 4541: "Pull-off Strength of Coatings Using Portable Adhesion Testers".

ASTM D 7234: "Pull-off Strength of Coatings on Concrete Using Portable Pull-off Adhesion Testers".

ASTM D 7091: "Non-destructive measurements over metal substrates made with magnetic and eddy current coating thickness gages".

ASTM D 7378: "Measurement methods for applied, pre-cured coating powders to predict cured thickness".

ASTM D 4138: "Destructive measurements over rigid substrates made with cross-sectioning instruments".

ASTM D 6132: "Non-destructive measurements over non-metal substrates made with ultrasonic coating thickness gages".

Fed Spec TT-P-28: Paint, Aluminum, and Heat Resisting (1200 °F).

Fed Spec TT-V-109: Varnish, Interior, and Alkyd-Resin.

Fed Spec TT-E-489: Enamel, Semi gloss, Rust-Inhibiting.

Fed Spec TT-E-496: Enamel: Heat Resisting (400 °F), Black.

Fed Spec 595: Standard Colors Vol. 1.