



SPORTS RYDER



SportsRyder

Few companies have played such a significant role in the manufacture of aftermarket performance suspension and brake components like Pedders. Since the 1950's, Pedders has continually set new benchmarks in creating high quality, durable and cost effective vehicle steering, suspension and braking systems. After becoming a market leader in this highly specialised field, the late 1970's saw Pedders embrace a radical new approach to suspension development; a program geared toward putting the driver back in control.

Enter Pedders SportsRyder Suspension & Brake Components...

The Pedders SportsRyder range of performance products represents the pinnacle in high –performance, tuned sports suspension and brakes.

With the driving enthusiast in mind, each SportsRyder product has been precision engineered to realize the maximum potential from a vehicle's chassis. Directly aimed at fulfilling the needs of car owners who wish to extract the most of their vehicle's dynamics, Pedders SportsRyder products sharpen a vehicle's handling characteristics with the result equating to improved roadhandling, ride quality, traction, braking and control.

Our comprehensive range of SportsRyder coil springs, shock-absorbers, adjustable coilovers, suspension bushes, sway bar links, strut mounts, brakes and alignment products have been specifically designed to both enhance the vehicle's presence and put the driver in control of its on-road behavior.

After all, Pedders SportsRyder is "performance inspired by pit lane".



Coil Springs

Coil springs are the foundations of the modern suspension system. Their spring rate and 'loaded' or installed height are fundamental in influencing chassis dynamics, vehicle balance and ride quality. And of course, the loaded height determines the vehicle's ride height and its 'trim' or attitude.

Pedders SportsRyder coils are designed and engineered in Australia to the highest quality standards to deliver unrivalled performance, consistency and reliability.

Behind the superior performance of SportsRyder coil springs is Pedders' decades of experience in suspension development and tuning, combined with state-of-the-art manufacturing processes.

The primary function of performance springs is to provide suspension travel which allows the tyres to follow the bumps and depressions in the road surface, while maintaining dynamic camber, i.e. the angle of the tyres and wheels in relation to the road while the car is in motion.



Coil Springs

For precise vehicle balance and handling, the spring rate must be matched to the weight of the car and the other suspension component. It must also be matched with the rate of the shock absorbers or struts to provide the required degree of wheel and tyre control.

The handling of most vehicles is substantially improved by making a minor increase in the original spring rate to a rate which reduces body roll. This in turn aids tyre adhesion without causing undue harshness or rigidity. Sports Ryder coils will enhance the tyre footprint on the road, thus improving traction and will also improve performance and overall handling.

Pedders coil spring design and manufacture is undertaken at our Melbourne facility. Its a craft which requires strict adherence to a demanding series of procedures, all of which are critical to the performance of the final product.

- Premium quality grade steel.
- Stress relieved.
- 100% Quality inspected.
- Loaded height and rate tested.
- Powder-coated for longevity.
- 2 Year/40,000Km warranty.



Shock Absorbers

Pedders has built its reputation on the ability to fine tune shock valving for precision handling and ride control. Utmost durability is also part of Pedders' commitment to our customers. All Pedders shocks and struts are manufactured with features specially designed for long life performance and reliability.

Beyond all else, Pedders has a comprehensive range to meet the needs of all drivers and applications.

The gas-charged GSR SportsRyder shock range use tailored nitrogen gas pressure to enable precise control without compromising on ride comfort.

Gas SportsRyder sealed struts and cartridges are high performance, heavy duty replacement units which deliver a new standard of comfort and road holding ability for today's hi-tech vehicles.



Bushes and Wheel Alignment

Bushes are used to locate and align suspension and steering parts. Worn bushes can cause rapid tyre wear, loose or pulling steering and also lead to increased braking distances and unsafe handling.

Pedders' urethane bushes make an ideal replacement, offering a high capacity to bear tension, compression and friction. They are also well suited to applications that require firm suspension control.

And while your vehicle is being fitted with Pedders' urethane bushes, why not have the wheel alignment checked. Poor wheel alignment, while damaging to tyres, can also result in unsafe driving conditions.

Apart from uneven tyre wear, other warning signs of incorrect wheel alignment include play or slack in the steering wheel, vibration in the steering wheel at certain speeds, a tendency for the car to pull to one side when in motion and overly light or heavy steering.

If your vehicle is showing any of these symptoms, take it to your nearest Pedders Suspension store for a comprehensive Brake, Steering and Suspension Check. Pedders recommends a suspension inspection every 12 months.



eXtreme XA

Pedders SportsRyder shock absorbers and struts combine the most advanced technology with Pedders' renowned expertise in the fine tuning of damping rates for superior handling. At the forefront of sports suspension is Pedders eXtreme XA, height adjustable coil-over built to Pedders stringent quality standards.

Pedders eXtreme XA is the result of our commitment to being a leader in the steering and suspension industry with outstanding product success in both the motorsport arena and sports performance markets.

The Pedders SportsRyder eXtreme XA adjustable coil over features a 30 position adjustable bump and rebound damping setting at the **CLICK** of a button which enables you to fine **TUNE** your suspension for whenever you want to **PLAY**.



SuperCar Coilover Kit

Pedders SportsRyder Supercar Adjustable Coilover Kit offers eXtreme ride control for the hardcore enthusiast. SportsRyder Supercar Coilover kits are the most advanced solution for your Holden VT to VE Commodore and Ford BA to FG Falcon sedans.

The separate bump and rebound adjustment allows the driver to dial in the "setup" of the cars handling balance just like the race teams do.

Add to that full height adjustment from the base mounts that maintains bump and droop travel on all four corners and you have a premium suspension system, tuneable to individual needs.



GAME ON!

***Supercar performance
at your fingertips.***



The Pedders Racing 86 out in front at Bathurst.

Pedders Slotted and Geomet Coated Disc Brake Rotors

With a curved slotted design these brake rotors are the premium upgrade or replacement solution for your vehicle.

Features and Benefits:

- Made from the highest grade raw materials and manufactured with the highest precision.
- Curved slotted design.
- Designed for consistent brake pedal feel.
- Geomet coated for better anti-corrosion protection.
- High wear resistance.
- Improved heat dissipation.
- Premium upgrade performance Rotor.





Geomet Coating for better anti-corrosion protection.

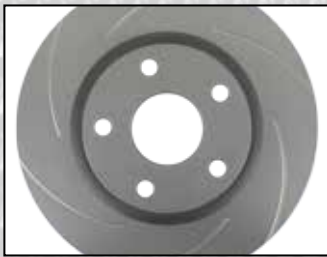

Made from the highest-grade raw materials and manufactured to the highest possible standards.



Slot designs developed to Improve performance, endurance and heat dispensation.



Improved cooling efficiency in high temperature conditions.



Pedders is Australia's Number 1 chain of under-car specialist stores. We offer a comprehensive range of products and services for all suspension, braking, towing, load carrying and steering needs to suit passenger cars, four-wheel drives, light commercials and high performance vehicles.

Since 1950 Pedders has been designing, manufacturing, selling, fitting and servicing its world class products through its own network of warehousing, service and authorised dealer centres throughout the world.

Every Pedders store offers the most comprehensive specialist under-car diagnosis and repairs with unmatched courteous advice and service. Pedders' range of high quality parts is backed by the commitment of our service centres and regional authorised dealers who are only too happy to offer advice on how you can improve your vehicle's ride, braking, towing, handling and steering.



Warranty

Pedders Suspension provides a comprehensive two-year, 40,000km nation wide warranty on Pedders brand-name products designed for road use, including shock absorbers, struts, springs, brakes and steering gears.#



PEDDERS

| SPRINGS

- Lowering •
- Raised •
- Standard •
- Heavy Duty •
- Ride Control •
- Load Carrying •

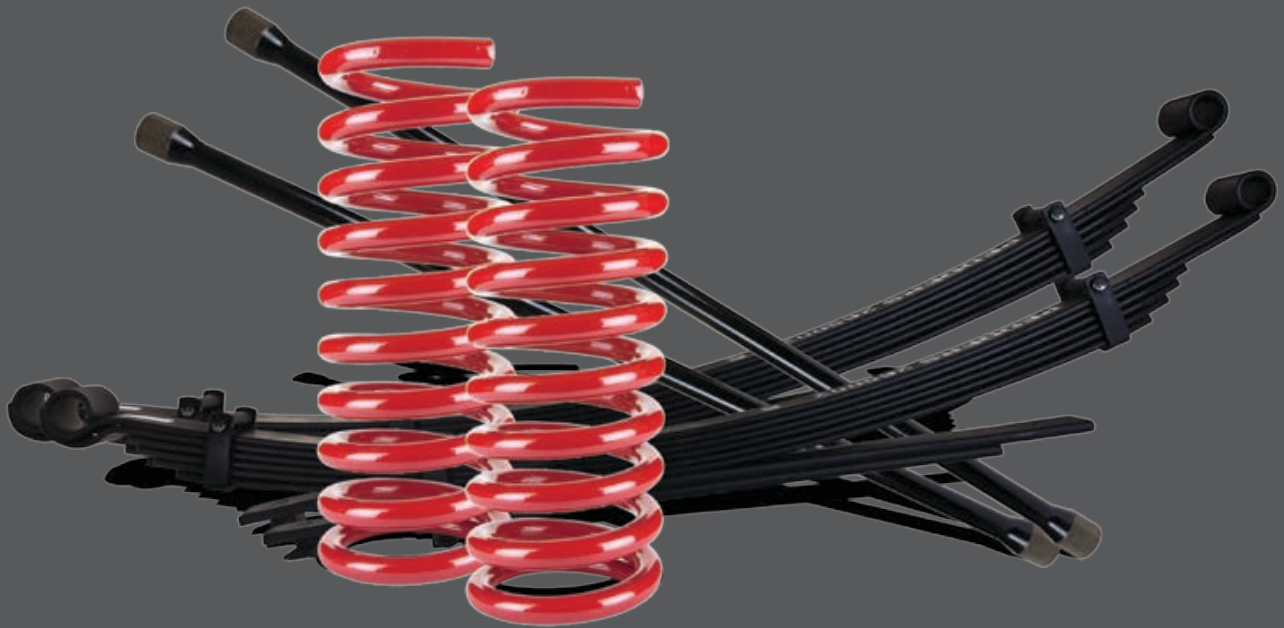

Springs - The Facts

The primary function of springs, whether they be Leaf, Coil or Torsion Bars, is to carry the load of the sprung weight and to absorb impacts created by the wheel when travelling over undulating or rough terrain.

The spring rate, or stiffness is to be matched to the weight of the vehicle resting on them in addition to other steering and suspension components. Spring Rate also controls "Roll Stiffness", or Body Roll. By reducing the amount of body roll, there is a reduction in the amount of wheel camber change. Excessive camber change can reduce the tyre's contact with the road surface, severely affecting the handling potential of the vehicle during cornering.

The handling of most vehicles is substantially improved by increasing the original spring rate to an optimum rate which will maximise tyre contact with the road and reduces body roll for improved handling. Increasing the spring rate beyond the optimum rate will detract from the handling potential, as this will possibly cause the tyres to become separated from the road surface through skipping over the bumps and therefore reducing grip and safety.

The springs of the vehicle perform many function: they absorb impacts, supply support for the vehicle, enhance handling and stability and offer ride control.



Coil Springs

Coil springs are the foundations of the modern suspension system with most car manufacturers, preferring coil springs due to their advantages of weight, tenability, space and ease of manufacture. Pedders research, design and manufacture their own range of coil springs from their own World-Class Manufacturing Plant in Victoria, Australia, to exacting ISO 9001 standards.

Unlike leaf springs, coil springs are not used to locate other steering or suspension components of the vehicle, they have only one function and that is to accept the sprung weight of the vehicle.

Coil Spring design and manufacturing is a craft which requires strict adherence to a demanding set of procedures, all of which are critical to the performance of the final product. Pedders undertakes the following key steps in relation to its Coil Spring Manufacturing Process.

- Hot Coiling
- Oil Quenching
- Furnace Tempering
- Shot Peening
- Scragging
- Load Height and Rate Testing
- Powder Coated
- 2 Year / 40,000km Nation Wide Warranty

What Is ISO 9001 Standard?

The Pedders Suspension Coil Spring Manufacturing Plant holds the Internationally recognised manufacturing quality standard of ISO 9001.

The ISO 9001 quality management systems standards is designed to help organizations ensure that they meet the needs of customers and other stakeholders while meeting statutory and regulatory requirements related to a product. ISO 9001 deals with the fundamentals of quality management systems, including the eight management principles upon which the family of standards is based.

WHAT DOES THIS MEAN TO THE CONSUMER?

The standard helps achieve consistent results and continually improving the process. This helps the holder of ISO 9001 make a good product all of the time.

What this means to the Pedders Suspension customers, is that they can be assured they are being supplied a product of significantly high quality.



Pedders Coil Spring Range

Pedders offer to its trade and retail customers, a range of four different branded coil springs.

- Heavy Duty
- SportsRyder
- Touring
- TrakRyder

PEDDERS HEAVY DUTY COIL SPRINGS

Pedders Heavy Duty Coil Springs are designed for standard and raised height replacement coil springs for passenger and light commercial vehicles. These coils offer unrivalled levels of ride control, handling and load carrying capabilities.

PEDDERS SPORTSRYDER COIL SPRINGS

Pedders SportsRyder Coil Springs are a premium range of lowered coil springs for sports and performance applications. They are built to standards with tolerance of only +/-2mm at loaded ride height Pedders SportsRyder Coil Springs are simply unrivalled in terms of handling, vehicle appearance and performance.



Straight advice, specialists you understand and... No Bull

PEDDERS TOURING COIL SPRINGS

Pedders touring coil springs are still built to the industry standards of ISO 9001, but are priced for the performance motorist with budget constraints. Pedders touring springs are simply the best quality budget coil springs available in the marketplace, these are for the motorist more interested in vehicle appearance than performance handling.



PEDDERS TRAKRYDER COIL SPRINGS

TrakRyder coils are heavy duty units that provide the precise rate needed to carry the mass of heavy 4WD vehicle bodies and wheel assemblies.

TrakRyder coils are made at Pedders' hi-tech spring manufacturing facility in Melbourne, Australia, from the highest quality spring steel and are produced according to a strictly controlled design. The manufacturing and testing process ensures Pedders coils exceed original tolerances and are equal to or exceed the best in the world in consistency of rate, loaded height and reliability.

Standard height and raised height coils for extra ground clearance are available for most 4WD vehicles and higher rated coils can be used to compensate for the extra weight of a bull bar, winch, rear step, or to improve a vehicle's load carrying or towing ability.



PEDDERS TORSION BAR SPRINGS

Like Pedders' coil springs, TrakRyder torsion bars are made from the highest quality alloy spring steel and are manufactured according to strict quality production procedures. TrakRyder torsion bars are fully tempered (heat treated) for high durability, hardness and long-term consistency. The ends (splined area) of the torsion bars are forged (shaped) to produce a stronger structure which assists in longer product life.

TrakRyder torsion bars are made to a larger diameter than most original bars, providing a firmer rate for greater control and improved load carrying ability.

Heavy-duty replacement units provide a permanent upgrade for the front suspension.

Whether your vehicle is in standard form or has been fitted with a bull bar, winch, dual battery system or any other heavy accessory, TrakRyder torsion bars provide extra control, stability and traction for enhanced performance.



PEDDERS REPLACEMENT LEAF SPRING PACKS

For heavy duty load carrying and towing, leaf springs remain the best performance suspension design, but there are disadvantages, such as becoming firmer as they age since they become less effective when they sag. This also may create noises and vibrations through the drive line.

Pedders offer full replacement leaf spring packs for Cars, Light Commercials, Dual Cab Utes and Four Wheel Drives.

Pedders Suspension has a variety of replacement leaf spring packs for a wide range of 4WD & 2WD vehicles designed specifically for load carrying applications. Pedders replacement leaf spring packs are durable whilst providing improved vehicle control and stability due to the fact that they feature redesigned spring rates. A number of these packs have a 2 stage design which provides a comfortable ride when un-laden whilst minimising height loss when load is applied.

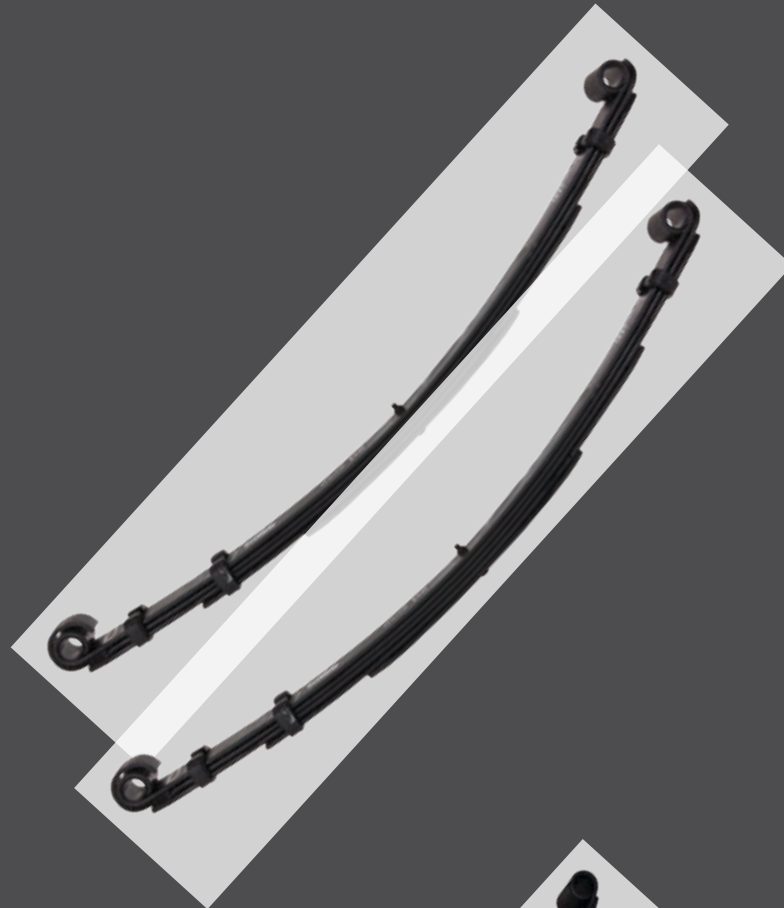

PEDDERS TRAKRYDER LEAF SPRING PACKS

Pedders replacement TrakRyder Leaf Spring Packs are durable whilst providing improved vehicle control and stability due to the fact that they feature redesigned spring rates.

A number of these packs have a 2-stage design which provides a comfortable ride when un laden whilst maintaining extra height when a load is applied. For heavy load carrying and towing, leaf springs remain the best performing suspension design, but can become harsh, noisier and less effective in absorbing bumps and vibrations.

Pedders offer full replacement TrakRyder leaf spring packs that feature inter-leaf friction pads and metal eye sleeves to minimise binding or noise. They are constructed from only the highest grade steels for maximum operational performance.

Pedders replacement TrakRyder leaf spring packs are durable whilst providing improved vehicle control and stability due to the fact that they feature redesigned spring rates.

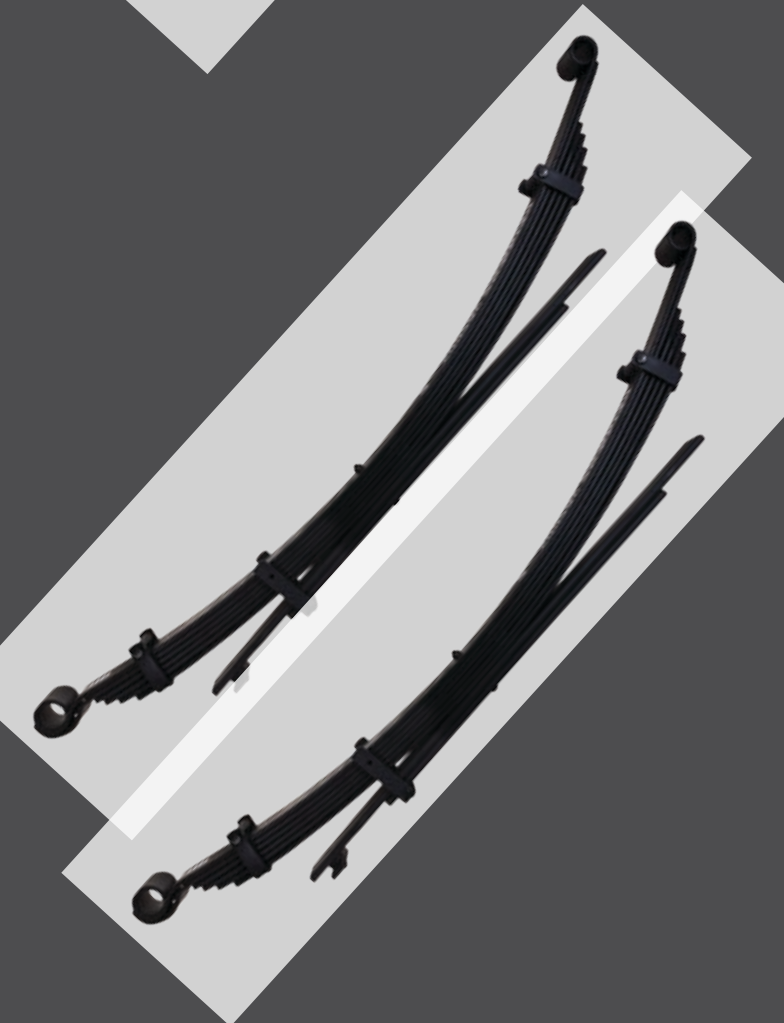

VARIABLE RATE LEAF SPRING PACKS

For most dual cab vehicles on our roads today, ride comfort vs. load carrying capacity is always a compromise. By today's standards, we are experiencing more consumers requesting a better ride characteristic from their load carrying dual cab utes. The general expectation is that they want more of a sedan style ride from their vehicle.

Through innovative design, Pedders have developed leaf springs in conjunction specially valved Foam Cell Shocks to achieve the best of both worlds, being the ability to improve ride quality and vehicle load carrying capabilities.

Because the modern dual cab utilities are used as both a work horse and a family vehicle, the spring design has a requirement to fulfil dual roles. Pedders have a product to deliver an outcome that will be pleasing to the consumer.

- Improved ride quality in laden and un laden situations as to O.E.M. recommendations
- Increased articulation with a raised ride height of 30 to 40mm
- Increased spring rate from O.E.
- Innovation in design and construction

THE RANGE IS AVAILABLE FOR THE CURRENT MODELS OF:

- | | |
|----------------|-----------------|
| • Toyota HiLux | • Ford Ranger |
| • Mazda BT50 | • Nissan Navara |
| • VW Amarok | • Colorado |
| • Triton | • D Max |

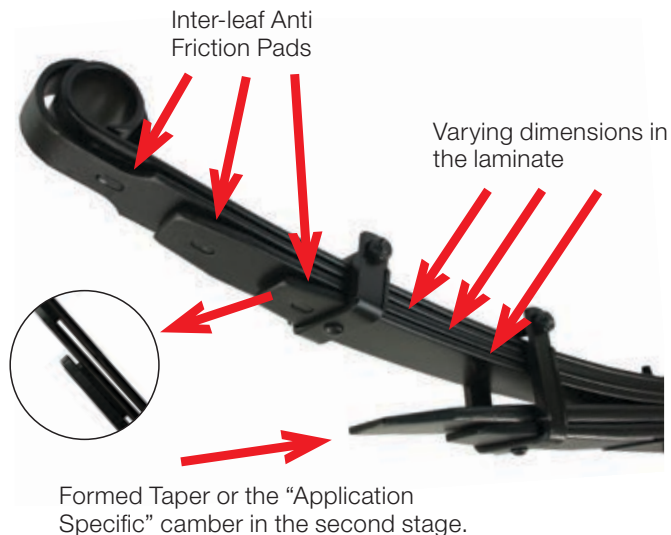

PEDDERS SUSPENSION WARRANTY

Pedders Suspension provides a comprehensive Two Year / 40,000km Nation Wide Warranty on all Pedders brand name products designed for road use, including Shock Absorbers, Struts, Leaf, Coil and Torsion Bar Springs.



How does the spring rate affect the steering? Can the shock absorber rate reduce the body roll? Why does increasing the rate of the rear sway bar induce more over steer?

These are just a few of the questions we will examine in this TechStop on handling. But first, we should ask, "What is handling?"

The technical definition of handling is generally accepted as, "the amount and percentage of traction each wheel and tyre has verses the feel to the driver of the car".

Even this technical definition allows room for different opinions on how well a car handles because of differing characteristics of the car.

A car must supply feel to the driver, and the most important element of handling is how well the tyres perform, remembering that in real terms the "foot print" of the tyre is not that big and it relies on how well the car is "set-up".

The ability of the tyres to maintain their grip is greatly influenced on the type, size and compound. If the car is fitted with the appropriate tyre for the intended use, fitted to the corresponding rims and the correct tyre pressure has been applied, then the car has good start to achieving the desired result. Handling is all

encompassing, Acceleration, Braking and Cornering. For a car to achieve its true potential, all three of requirements must have the ability to come together.

However the tyres will only work to their maximum effect if the steering and suspension allow them to. This is where we start to discuss the importance of dynamic geometry.

Though the wheel alignment geometry is adjusted while the vehicle is stationary, (static) it is important to note that it is for when the car is in motion (dynamic). Just about all the wheel angles alter when the car is in motion, this is where the suspension rate becomes active, you can have the best tyres money can buy, have the best wheel alignment performed on the car, but if the suspension is not right the car will not perform.

The dynamic changes of the geometry is effected by a number of factors, these including the general condition of the chassis and suspension, the static alignment angles, spring rates, shock absorber rates, sway bar rates and the balance of the car (corner weights and centre of gravity). This TechStop will examine how individual components impact on the overall package of a good handling car.



As we have touched on the importance of tyres and wheel alignment, the other major handling components of chassis tuning are: Springs, Shock absorbers, Anti sway bars (often called sway bars) and bushes

Springs

Springs, whether they are Coil, Leaf, Torsion Bars or Air Bags, serve two basic functions. First and foremost they take care of holding up the sprung weight of the car, obviously if there were no springs the car would sit on the bump stops and that does NOT make for good handling. The second one is to provide resistance to the movement of the mass, vertically, pitch and roll. The velocity of this movement is controlled by the shock absorbers. The springs and shock absorbers are a matched set-up, make a choice on springs first, then select the shocks that are best suited to obtain maximum control.

The spring has many functions, like:

- Controlling dynamic Camber setting.
- The Ride Height, which effects the car's Centre of Gravity and Roll Centres.
- The Roll Stiffness, which is the resistance for the body to roll when cornering.

To calculate what Spring Rate is required for the car the following data is required:

- Sprung weight of the car at each corner.
- Weight distribution, front to rear.
- Motion Ratio of the spring platform.
- Wheel Rate (Calculated spring rate at the wheel).
- Spring Angle, as mounted in the car.
- The compound of the tyres.



Shock Absorbers

Shock absorbers do not absorb shocks, they control the oscillations of the suspension movement, The stiffer the spring the stiffer the shock.

They do this by controlling the compression and the rebounding of the suspension as the car travels over a given surface. Also they will have an effect on the energy created associated with suspension travelling laterally created by cornering and longitudinal, created by accelerating and braking.

Without damping, the magnitude of the suspension movement would never stop increasing. In terms of energy, damping absorbs most of the energy the car receives as it moves, unlike springs, that store the energy and then releases it. Imagine a car with no damping effect or the wrong valving in the shock absorber. The subsequent impacts from the undulations on the tyres would make the suspension uncontrollable, which is not a good thing. Dampers absorb all the excess energy and allow the tyres to stay in contact with the road surface as much as possible.

This also indicates that the damping rate should always be matched to the spring rate.

Note: the damping only alters the speed at which the roll and pitching motions occur, it does not alter their extent. So if you want the vehicle to roll less, adjust the Anti-Roll bars or change the spring rate, leave the shocks last.

How to select the shock absorber

- Check the suspension travel, the shock must have the correct opened and closed length.
- Take into account the "Motion Ratio" when selecting the valve code.
- The angle that the shock absorber is mounted will also affect the valve rate.
- The shock absorber valve code is to be matched to the spring rate.



Anti-Sway Bars

Anti-sway bars are like “sideways springs, they work laterally. If one side of the suspension is compressed, one end of the bar is lifted. The other end will also want to go up, and in turn pulling the other side of the suspension up also, basically creating more resistance to body roll.

This effect is controlled by the torsional strength of the bar, smaller diameter less resistance, larger the bar, the greater the resistance.

When both sides are moving equally, down when the car is braking or up when the car is accelerating, the bar has no effect on the suspension. Anti- Roll Bars only effect the lateral balance of the car, not the longitudinal balance.



- Anti-Roll Bars aren't the only things that effect the car's roll stiffness, they work in conjunction with the springs and shocks.
- Stiffer in the front and softer in the rear, promotes understeer.
- Softer in the front and stiffer in the rear promotes oversteer.
- Anti –Sway Bars will restrict suspension travel, so be mindful of this when going off road with your 4 W.D.

Some anti-roll bars, particularly those intended for racing, are externally adjustable while the car is in the pit whereas some systems can be adjusted in real time by the driver from inside the car. This allows the stiffness to be altered, for example by increasing or reducing the length of the lever arms on some systems, or by rotating a flat lever arm from a stiff edge-on position to a more

flexible flat-side-on position on other systems. This lets a mechanic tune the roll stiffness for different situations without replacing the entire bar.

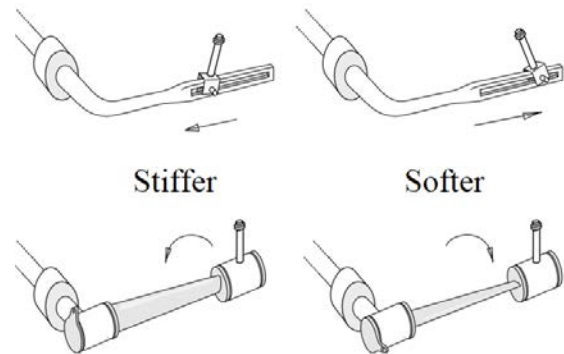

Suspension Bushes

Suspension bushes are one of the most poorly understood and undervalued components of a car's overall handling. It can be easy to discount the role that such an inconsequential looking piece of rubber can play in the proper operation of a car's suspension system. This is a huge mistake. Although a suspension bush looks simple, it is quite a complex component that fulfills a variety of important roles and if they become worn or damaged you will notice a variety of adverse effects.

The following are some of the classic symptoms:

- Excessive road noise.
- Poor steering response.
- Poor handling (Over or Understeer characteristics).
- Inaccurate wheel alignment.
- Not obtaining the full the effects of the tyre foot print.

The use of different types of materials for the bushes, do have their advantage:

- A high capacity to bear tension.
- Assist in more precise wheel alignments.
- The car becoming more reactive.
- Increase road holding.

When installing any suspension bushes, only tighten the mounting bolts finger tight. Do not proceed until the car's weight is resting on the wheels and the car is at natural ride height. Then fully tighten the bolts to the recommended torque. This procedure will prevent premature wear of the bushes caused by increased torsional stress placed on them. The ride height may also be affected if this process is not followed.



Bump Steer

Bump steer is the toe-in or toe-out of the front wheels as the suspension goes from normal ride height through full bump (suspension system moves up) to full droop (suspension system moves down). Measurement is usually limited to 75mm up and 75mm down from ride height. It is specified either by a graph or measurements at 25mm, 50mm and 75mm.

So, what does bump-steer do to a car's handling? There are a number of possibilities, depending on the severity of the problem in, including:

- Direction change under braking.
- Shake in the steering system (particularly at the steering wheel).
- Sudden loss of grip during any part of the cornering process (entry, middle, or exit).
- The car pulls to one side at certain points on the track (can be on straights too).

All of the above are directly related to suspension movement at a time when the driver did not input any steering angle change.

Although bump-steer is predominantly a front end geometry problem, certain suspension systems can produce similar problems on the rear of a car, for instance fully independent suspension systems.

In general, most high technology cars, have very little bump-steer. The accuracy of the design and build process on these cars ensures the geometrical accuracy.

Measuring bump-steer is simply a case of measuring the deviation a wheel takes when the suspension is compressed. Very accurate instruments such as a modern four wheel alignment machine can measure deviation as little as one mm. Changing the vertical position of the steering rack or rod-end pivots will change the bump-steer readings.

Causes of Bump Steer:

- Steering Rack not level.
- Drag link not level.
- Different length Ackerman arms.
- Different height or angle of the Ackerman arms.
- Tie rod and L.C.A. angles do not intersect.
- Height of steering gear.
- Bent or misaligned steering components.

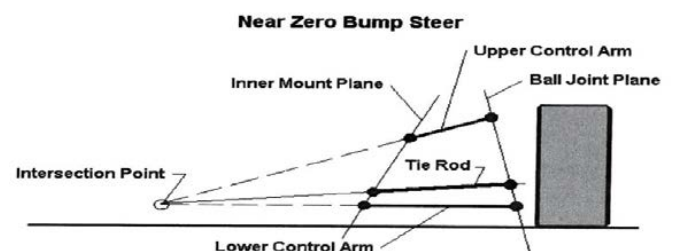

Wheel Alignment

The final operation of any modification, alteration or set up is the wheel alignment, why?

- Directional stability.
- Obtain maximum affect from the tyres.
- Stable braking.

A poor or no wheel alignment will result in a vehicle that will be lacking in the appropriate responses.

The tyre foot print is quite small in the scheme of things, it is all very well in having an engine that is developing good reliable horse power, but if the car can't put it on to the ground, then you are wasting your time.

Not all cars and drivers like the same settings, as there are too many variables.

- The balance of the car.
- The weight of the driver.
- The driving style.
- The tyre pressures.
- The type/compound of tyres.

When conducting the wheel alignment, it is very important to have the car at it's usual operating weight. All fluids, including fuel, oils, washer bottle, driver drink bottle etc., must be at their desired level. Tyre pressures correct, drivers weight, including clothing and helmet, is to be in the car.



If you are using your car for competition, make sure you set the geometry up for the car to suit the circuit. The toe setting will vary enormously from circuit to circuit. Is it short tight and twisty or open and fast. These are the considerations to be taken into account when setting up the vehicle.

A tyre temperature gauge is very handy as well. After a test session check the temperature across the foot print of the tyre, to see if there are any major variations and if there are alter the geometry to have a uniform temperature pattern across the tyre.

Pedders Wheel Alignment products

Pedders suspension have available an extensive range of aftermarket wheel alignment products. So now there is no need to put up with "close enough is good enough"

In the Pedders range, there are Eccentric Bushes, Eccentric Pivot Bearings, Camber Pins, Shim Replacement Kits and Adjustable front Radius Arm Bushes.



Handy Hints

Component	Reduce Under-steer	Reduce Over-steer
Weight distribution	C. of G. towards rear	C. of G. towards front
Front shock dampers	Softer	Stiffer
Rear shock absorber	Stiffer	Softer
Front sway bar	Softer	Stiffer
Rear sway bar	Stiffer	Softer
Front tyre selection ¹	Larger contact area	Smaller contact area
Rear tyre selection	Smaller contact area	Larger contact area ²
Front wheel rim width or diameter	Larger ²	Smaller
Rear wheel rim width or diameter	Smaller	Larger ²
Front tyre pressure	Lower pressure	Higher pressure
Rear tyre pressure	Higher pressure	Lower pressure
Front wheel camber	Increase negative camber	Reduce negative camber
Rear wheel camber	Reduce negative camber	Increase negative camber
Rear spoiler	Smaller	Larger
Front height (because these usually affect camber and roll resistance)	Lower front end	Raise front end
Rear height	Raise rear end	Lower rear end
Front in	Decrease	Increase
Rear toe in	Decrease	Increase

1) Tyre contact area can be increased by using wider tyres, or tyres with fewer grooves in the tread pattern. Of course fewer grooves has the opposite effect in wet weather or other poor road conditions.

2) These also improve road holding, under most conditions.

PEDDERS

SHOCK ABSORBERS



Get the ride that's right for you



Straight advice, specialists you understand and... No Bull

The function and operation of shock absorbers are widely misunderstood. Here we present the bare facts on shocks and your many options in shock absorbers.

The first lesson to be learnt about shocks absorbers is that their name is deceiving, for shock absorbers do not absorb shocks - or at least that is not their primary role. Shock absorbers are dampers that resist movement and their main function is to control unwanted movement of the car's springs maintaining tyre contact with the road surface

SHOCKS IN ACTION

When a tyre hits a bump in the road surface, the wheel and suspension moves upwards, causing the spring to compress. The spring absorbs the energy of the impact and then releases this energy by expanding.

This movement of the suspension is necessary to allow the tyre to pass over the bump without causing the body of the car to rise the same distance. However, further expansion and compression of the spring after the impact is unwanted and this is what a shock absorber is designed to prevent.

Shock absorbers, like springs, are generally mounted between the axle and the car body. When a spring expands and compresses, so does the shock absorber. The shock resists this movement by controlling the flow of oil inside the shock through a number of control valves.

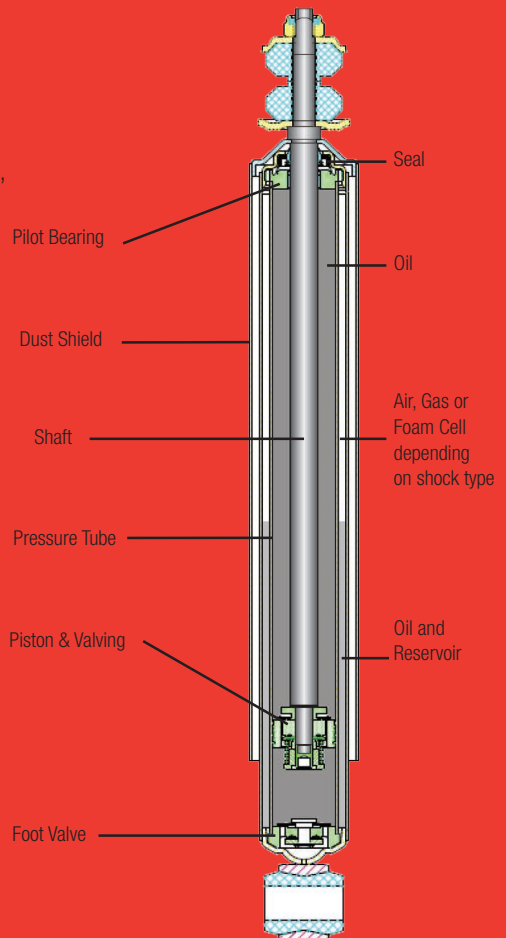

HOW A SHOCK ABSORBER WORKS

With each extension and compression of the shock, known as a 'stroke', a piston moves up and down inside the shock and oil flows between the inner and outer chambers of the shock, known respectively as the 'pressure cylinder' and 'reservoir'. The oil must pass through a complex valving system which opens and closes depending on the direction of the flow. The valves are precisely engineered to provide a measured resistance to the oil flow. The spring-loaded valve only opens to allow oil to pass through when enough force is supplied. This force is generated by the speed at which the shock is extending and contracting. As the stroking speed of the shock increases, more stages of the valving come into play to control the flow of the oil.

Thus the shock is sensitive to the length and speed of suspension movement and is designed to supply precisely the amount of damping resistance required at any time. This ensures that the suspension's spring remains in control, performing its intended role and promoting maximum tyre grip on the road surface.

PEDDERS SHOCK ABSORBERS

As the industry's leading Shock Absorber, Steering and Suspension Specialist, Pedders prides itself on being able to offer a complete range of quality shock absorbers through its store and dealer network throughout Australia and across the globe.

Pedders provides a comprehensive choice of shock absorber models from our range. Our brands include; Pedders Shock Absorbers, Pedders EziFit, SportsRyder and SportsRyder eXtreme XA Adjustable Coilovers. For motorists who drive European models - Bilstein Shock Absorbers are also available. You can count on Pedders to find the right shock to suit your driving needs.

PEDDERS

SHOCK ABSORBERS

Pedders Shock Absorbers are premium quality gas shock absorbers whose features include; precisely tuned valving, heavy duty construction and accurate nitrogen gas pressurisation. These key features deliver confident road holding with smooth ride characteristics. Pedders Shocks, Spring seated shocks and Struts are the ideal replacement for worn or leaking dampers.

Pedders
Shock Absorbers



TRAKRYDER

4WD SUSPENSION

For those owners of Four-Wheel Drive vehicles there is simply no better than TrakRyder. Two shock absorbers are available within the TrakRyder Range, Pedders 4WD Gas SportsRyder and Pedders 4WD Foam Cell. With TrakRyder shock absorbers and especially when incorporated with the other components of the TrakRyder range, 4WD owners can enjoy the best of both worlds. The benefits of owning a 4WD plus comfort and handling more like a family SUV.

TRAKRYDER
Gas Pressurised
Shock Absorbers



TRAKRYDER,
Foam Cell
Shock Absorbers

Pedders' TrakRyder steering dampers enhance driving feel and comfort by further reducing the jolts and impacts that feed back through the steering wheel caused by heavy off road wheels and rough conditions. TrakRyder steering dampers feature an extra large 35mm bore. This provides optimum performance via the Foam Cell technology that enables the steering damper to operate at any angle. TrakRyder steering dampers are available to replace original equipment on most 4WD models.

TRAKRYDER
Steering Dampers



EziFit

The Pedders TrakRyder EziFit range is supplied as a matched set of pre-assembled suspension components including Pedders TrakRyder Foam Cell Shock Absorber, Pedders TrakRyder Heavy Duty Spring and Pedders TrakRyder Strut Mount. Installation time is reduced as the components are supplied pre assembled and ready for direct bolt on fitment saving time and money and eliminating the need for spring compressors and other specialized equipment. The Heavy Duty twin-tube construction & reinforced double welded mountings provide long term durability. The large 40mm piston and precise internal valving deliver stability and ride comfort for touring, load carrying, towing and off road applications. The TrakRyder EziFit range is assembled with Pedders premium TrakRyder coil springs making them Ideal for standard height, raised or loaded raised applications to suit your varying needs.

TRAKRYDER
EziFit Shock Absorbers



Pedders EziFit
Shock Absorbers



Pedders Suspension also supplies a range of selected Bilstein shock absorbers to suit most European makes and models. Bilstein improves the comfort and handling performance of your European car, light commercial or SUV. That's why many of the world's finest automotive manufacturers choose Bilstein as their original equipment.



Bilstein
Shock Absorbers

For motorists who are after that extra level of performance and sports handling Pedders Suspension has a product range called SportsRyder. The gas-charged GSR SportsRyder shock range uses precise valve tuning and tailored nitrogen gas pressure for ultimate control without compromising on ride quality.

Gas SportsRyder sealed struts and cartridges are high performance, heavy duty replacement units which deliver a new standard of road holding ability for today's hi-tech, lighter vehicles. At the pinnacle of the SportsRyder range comes the eXtreme XA, a world class, height adjustable coil over unit featuring 30 position adjustable bump and rebound damping, set at the click of a button.

SPORTSRYDER
Shock Absorbers



SPORTSRYDER
eXtreme XA
Adjustable Coil Over



Pedders SportsRyder Supercar adjustable coilover kit offers eXtreme ride control for the hardcore enthusiast. The sophisticated driver will be able to tune their suspension like a pro. The incomparable benefits of the massive 52mm monotube body are definitely for the enthusiast. The larger piston and reservoir provides smoother ride with more control and the ability to adjust bump and rebound damping separately to 30 different positions allows you to click-tune-play, like a Supercar.

SPORTSRYDER SUPERCAR
Adjustable Coil Over





Bushes



PEDDERS

| SUSPENSION BUSHES

Suspension bushes play a vital role in car safety, ride comfort and handling. They are used to position and align suspension and steering components such as shock absorbers, sway bars, torsion bars and control arms which are critical for correct alignment of the wheels and tyres.

Bushes also assist in reducing Noise, Vibration and Harshness or NVH. As such, bushes must always be maintained to optimum condition. Worn bushes can cause rapid tyre wear, loose or pulling steering and can affect braking and handling.

To perform its intended role, a bush must be able to compress to absorb energy to a precise degree, and then return to its original state. If a bush is too hard, too soft, or damaged in any way, the ride and handling of a vehicle maybe compromised.

Bushes are made from a number of different types of materials, including rubber, urethane or a synthetic rubber compound. Each type is chosen for a particular application based on a number of characteristics, including its general performance, feel and response characteristics, noise and durability.

By upgrading original suspension bushes to suit specific purposes, a vehicle's general handling and its ability to perform in certain conditions can be dramatically improved.

Pedders has spent many years developing a comprehensive range of bushes for all applications, designed to allow flexibility of movement of the entire suspension, while maintaining correct mounting and alignment of individual parts.



Urethane Bushes

Pedders Urethane bushes have a high capacity to bear tension, compression and friction and retain their capabilities, even under the most adverse conditions.

This makes them well suited to the demands of heavy load carrying, accurate suspension control or where regular exposure to corrosive materials is expected.

Another major advantage of Pedders' urethane bushes is they can be used to solve wheel alignment problems. This is particularly relevant for most front-wheel drive vehicles, as they do not have provision for wheel alignment correction.

With all type of vehicles, as the suspension wears with age, vehicles can suffer from unnecessary tyre wear and compromised handling.

Other features of Pedders urethane bushes are:

- Hardened crush tubes for longer life and to eliminate slippage or creep.
- A double helix, used against the outer diameter of the crush tube. The double helix maintains axial location while allowing full rotation of the pivot. It also acts as a grease reservoir that further increases product life.
- Knurling. For extra protection against adverse wear in heavily laden bushings and high levels of lubricating grease retention.
- Bullet Grooves. These provide the correct pre-load while at the same time accommodating a wider variance in the size of the components they fit and maintaining free pivoting of the bushings.



Rubber Bushes

Despite major advances in synthetic bush materials, the natural performance characteristics of rubber bushes make them the most suitable material choice for a wide variety of applications.

Rubber bushes are generally more compliant than urethane bushes with superior elasticity and are selected for applications that require a more flexible response. Standard rubber is most effective in reducing NVH. Pedders range of aftermarket engineered rubber bushes provide excellent control and response with smooth quiet operation. Rubber is less suitable for applications that are exposed to high levels of corrosive chemicals and materials such as oils, waxes, solvents and pollution.



Warranty

As with all Pedders products even bushes come with our 2 year or 40,000km nationwide guarantee of quality, so ask your suspension expert which bush would be better suited to your application.





eXtreme XA Adjustable Coilover
SuperCar Adjustable Coilover



SPORTSRYDER
eXtreme
ADJUSTABLE COIL-OVER

At the forefront of sports suspension is Pedders eXtreme XA, height adjustable coil-over built to Pedders stringent quality standards. Pedders eXtreme XA features sports calibrated tunable damping, motorsport coil springs individually tuned to suit each application and a host of other high performance features including engineered mounting bracketry. The eXtreme XA is the pinnacle of performance suspension technology and the flagship of Pedders' SportsRyder range of specialist performance suspension products. Pedders eXtreme XA is the result of Pedders Suspensions commitment to being a leader in the steering and suspension industry with outstanding product success in both the motorsport arena and sports performance markets. The Pedders SportsRyder eXtreme XA adjustable coil over features a 30 position adjustable bump and rebound damping setting at the **CLICK** of a button which enables you to fine **TUNE** your suspension for whenever you want to **PLAY**.

Integrated dust boot to minimize contamination and protect shaft and seal

30 Position adjustable bump and rebound damping



Alloy steel motorsport coil springs

Fully threaded Mono-tube body

High grade T6 aluminium spring seats

Fully adjustable high grade steel lower mount for height adjustment

Factory style bracketry for direct fitment

....Click. Tune. Play



Pedders SportsRyder Supercar Adjustable Coilover Kit offers eXtreme ride control for the hardcore enthusiast. SportsRyder Supercar Coilover kits are the most advanced solution for your Holden VT to VE and Ford BA to FGX Falcon sedans.

The separate bump and rebound adjustment allows the driver to dial in the “setup” of the cars handling balance just like the race teams do.

Add to that full height adjustment from the base mounts that maintains bump and droop travel on all four corners and you have a premium suspension system, tuneable to individual needs.



Supercar Performance
At Your Fingertips.

SPORTSRYDER

Few companies have played such a significant role in street and performance car culture as Pedders. In its highly specialised field, Pedders has continually set new benchmarks for precise vehicle balance, optimum traction and maximum street appeal since the 1950s. Today, Pedders' **SportsRyder** range represents the ultimate in performance suspension, alignment products and brakes. **SportsRyder** products, when integrated into a fully balanced **SportsRyder** system make a great enhancement to a vehicle's handling and safety. **SportsRyder** coil springs, bushes, shocks, sway bars, sway bar links, strut mounts, struts and brakes improve traction, ride quality, turn-in and cornering ability with greater steering precision and stability under braking. With **SportsRyder** products, you can minimise body roll, reduce pitch and float, extend the life of your tyres and gain a greater safety margin in performance driving conditions.



Warranty

As with all Pedders products even coilovers come with our 2 year or 40,000km nationwide guarantee of quality, so ask your coilover expert which bush would be better suited to your application.



Learn more about Performance Suspension Parts we have.