

4.1 INTRODUCTION

Perimeter security is designed to protect employees, visitors, and building functions and services from threats such as unauthorized vehicles approaching close to or penetrating high-risk buildings. The key element in protecting buildings from a vehicular bomb is the establishment of appropriate stand-off distance, depending on the size of the threat and the building characteristics. This is accomplished by a protective barrier system placed to provide at least minimum required stand-off. In an urban situation, this is often not possible, and alternative measures must be taken. These are discussed in Chapter 6.

The barrier may be along the site property line or, within a large site or campus, placed independently of the property line. When along the property line, the barrier forms the interface between public and private space, and thus, in an urban setting, it may have major visual and functional impacts on city amenities. If the barrier is within the site, it may have a major impact on the visual appeal of the site and the experience of the approach to the building.

A perimeter security design involves two main elements: the **perimeter barrier** that prevents unauthorized vehicles and pedestrians from entering the site, and **access control points** at which vehicles and pedestrians can be screened and, if necessary, inspected before they pass through the barrier. Barrier system design and types of barriers are described in this chapter. Access control points are described in Chapter 5, Section 5.3, and Chapter 6, Section 6.5, for open and urban sites, respectively.

The following are suggested as some of the goals of perimeter security planning:

- To provide an appropriate **balance** between the need to accommodate perimeter security for sensitive buildings and their occupants, and the need to maintain the vitality of the public realm.
- To provide security in the context of **streetscape enhancement** and public realm beautification, rather than as a separate or redundant system of components whose only purpose is security.

- To expand the palette of elements that can gracefully or unobtrusively provide perimeter security in a manner that does not clutter the public realm, while avoiding the monotony of endless lines of jersey barriers or bollards which only evoke defensiveness (see Section 4.6.2 for an example of an innovative unobtrusive security element).
- To produce a **coherent strategy** for deploying specific families of streetscape and security elements in which priority is given to achieving aesthetic continuity along streets, rather than solutions selected solely by the needs of a particular building under the jurisdiction of one owner or agency.
- To provide perimeter security in a manner that does not impede the city’s **commerce and vitality**, nor excessively restrict or impede operational use of sidewalks or pedestrian and vehicular mobility, or impact the health of existing trees.

Perimeter protection may participate in all three layers of defense. The first layer applies when the access control is outside the property line. The second layer applies when there is controlled access around a building within the property line. The third layer applies to underground parking, or parking underneath a plaza (see Chapter 6, Section 6.4). It also applies when the access control is at the building face.

Perimeter security protection is accomplished by design strategies that use a variety of methods to protect the site. The two following sections provide some broad guidelines for the design of barrier systems and details of the characteristics of barriers currently in use.

4.2 BARRIER SYSTEM DESIGN

4.2.1 ISSUES OF BARRIER SYSTEMS DESIGN

The architecture and the landscaping of the site entry elements are the first part (and may be the only part) of the project that is visible. As such, they introduce the identity of the site and its architectural style and quality, and impart a sense of welcome or “stay away” (Figure 4-1).

Sidewalks should be open and accessible to pedestrians to the greatest extent possible, and security elements should not interfere with circulation, particularly in crowded locations.

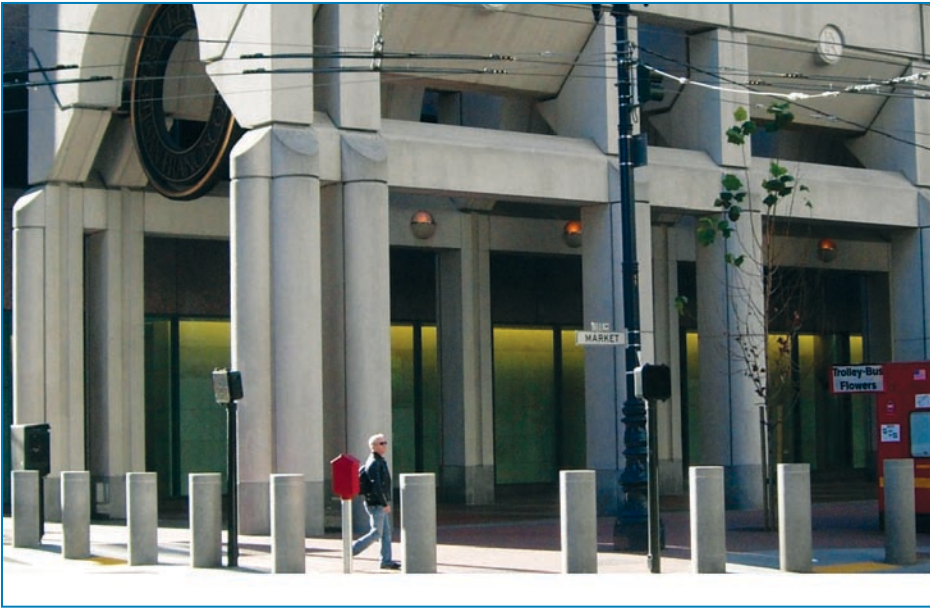

Figure 4-1:
Custom bollards match
the architecture at a
defended corner.

Issues to be considered in the design of the barrier system include:

- To ensure protection to the desired level, the design and selection of barriers should be based directly on the design base threat assessed for the project, as well as available countermeasures and their ability to mitigate risk.
- The barrier layout at sidewalks should be such that a constant clear path of 8 feet or 50% of the sidewalk, whichever is the greater, should be maintained.
- For buildings with a yard, security elements should be placed in or at the edge of the yard depending on available space and stand-off.
- All necessary security elements should be installed to minimize obstruction of the clear path. If it is necessary for space reasons to place elements at the curb they should be placed in an available amenity strip adjacent to most curbs, since this space is already designated for street furniture and trees and is not part of the existing clear path.
- Any security (or other) object placed on the curb should be at least two feet from the curb line to allow for door opening and to facilitate passenger vehicle pick-up and drop-offs, if this can be done anywhere along the curb. However, the most effective placement is at a maximum of two feet: this allows the barrier to engage the engine block and mass of an approaching vehicle before the tires have impacted the curb and begun to launch it over the barrier. Ideally, drop-off points should be located in pull-over or stopping points where the setback is greatest. At a distance of more than two feet, the curb can become a major factor in barrier height requirements and in reducing their effectiveness.

- A bollard barrier system is less intrusive if it is short in length and thoughtfully integrated into the entire perimeter security system. The bollard materials should harmonize with the building architecture.

Figure 4-2 shows a small row of bollards protecting a building entrance. The custom-designed stainless steel bollards harmonize well with the building architecture.

Figure 4-2:
Stainless steel covers on bollards harmonize with the building entrance.



- Monotonous repetition of a single element should be avoided. Block after block of the same element, no matter how attractive, does not create good design (Figures 4-3 and 4-4). When a continuous line of bollards approaches 100 feet, they should be interspersed with other streetscape elements, such as hardened benches, planters, or trees.

Figure 4-3:
Monotonous repetition of bollards





Figure 4-4:
 These bollards resemble a wall.
 SOURCE: NCPC)

- Hydraulic barriers, drop arm beams and the complete system including security gatehouses are visually intrusive. Wherever possible, such entry controls should be located in access roads and service alleys.
- The use of a combination of barrier types establishes a flexible design palette that responds to security requirements in accordance with diverse perimeter conditions (Figure 4-5).



Figure 4-5:
 Top: Combination of low retaining walls and low bollards.
 Bottom, left: Combination of oversized bollard and large planters placed on very wide sidewalk. Bottom, right: Combination of tree and bollards.

Opportunities to add a palette of elements, such as varied bollard types, engineered sculptured forms, hardened street furniture, low walls, and judicious landscaping can all assist in creating a functional yet attractive barrier that will enhance the setting. Solutions that integrate a number of appropriate perimeter barriers into the overall site design will be more successful (Figure 4-6).

Figure 4-6:

A combination of barrier types for a variety of threat conditions. Vehicle access to this building is prevented by custom designed bollards, a sculptured concrete barrier, fences and trees

SOURCE: DESIGN: DELLA VALLE + BERNHEIMER ARCHITECTS



The graphic box following shows varied bollard sizes combined with other elements to reduce the monotony of a long curbside barrier system.

BOLLARD VARIATIONS AS PART OF THE STREETScape

Small and large bollards, trees and plants. In a few years the trees will dominate the streetscape (right).

Bollards, trees, and lamp standards (below).



- The placement of barriers at corners, driveways, sally ports, stairs, and handicapped ramps requires careful attention.
- Barriers at the edges of soil slopes need to be investigated carefully.
- Corners need creative design, for example, to increase the area to account for pedestrian queuing while interspersing effective barriers that can consist of non-obvious objects, such as traffic signals, signs, lighting, etc. In addition, corners can offer the opportunity to consider barrier design in depth to facilitate pedestrian flow and protection while preventing vehicle entry.

Corners can be vulnerable points for vehicle bomb attacks. They are often the area of greatest approach speed, greatest number of approach avenues, and most perpendicular impact. Unless they are carefully designed to impede bomb-laden vehicles, it may be possible for an attacker to drive onto the sidewalk and proceed unimpeded to an intended target.

Space for several functions are important considerations: (1) pedestrians to circulate during the green signal phase, (2) a pedestrian holding area during the red signal phase, (3) vehicles turning the corner, and (4) people joining in the queue at the red signal phase. These space requirements demand that sidewalk corners be kept clear of obstructions. Reduction of corner space can lead to people using the roadbed as a waiting area. Sidewalk corners (defined as the space created by extending lines to the edge of the sidewalk) should be free of objects. No part of a corner curb cut should have any security elements. Wrap-around corners (stretches from the edge of one curb cut to the edge of the adjacent one) at rounded sidewalk corners should not be permitted.

- Emergency evacuation and access are important considerations. The primary goal of perimeter security is to provide facilities with a layer of barrier protection. However, the same protection that keeps dangerous vehicles or people away could also keep first responders from approaching the building quickly and enabling people to exit rapidly.
- Landscape materials can soften and naturalize the appearance of many types of constructed barriers, improving their appearance and compatibility with the surrounding areas (Figure 4-7).
- When possible, position gates and perimeter boundary fences outside the blast vulnerability envelope.
- For high-risk buildings, barriers should be provided at site and building entries. Vehicles should not be permitted to park next to the perimeter walls of the secured area.

Figure 4-7:
Low and high walls softened with landscaping.



- In case of an elevated risk, vehicles can be used as very temporary physical barriers when placed in front of buildings or across access roads, but they are very detrimental to the character of an entry when used as a long-term risk mitigation measure.

Case Study 5 describes a large agency complex in Washington, D.C., that features an arcaded crescent that wraps around two sides of the building and encloses an internal garden space. This creative security barrier makes a positive contribution to the urban environment.

CASE STUDY 5: A MAJOR GOVERNMENT BUILDING

1.0 INTRODUCTION

This new government building using innovative security barriers is located at the intersection of two major streets in a city's industrial area that is undergoing urban renewal. The complex is designed to engage the street edges, with an entrance across from a nearby transit center. Retail facilities border to the east, while a trellised garden wall to the south animates the street edges in addition to enhancing the perimeter security.



CASE STUDY 5: A MAJOR GOVERNMENT BUILDING (continued)

1.1 Project Scope

The building program includes general office space, training rooms, laboratories, a library, an auditorium, underground parking, and auxiliary services. A three-story, planted, arcaded crescent wraps around the north and west boundaries, enclosing an internal garden space. Loading docks and an inspection booth are integrated into the architecture and garden walls.

1.2 Project Team

Moshe Safdie and Associates with OPX Architecture, Associate Architects

1.3 Project Schedule

Completed in 2007

2.0 DESIGN APPROACH

2.1 Issues Addressed

- Security needs of a major government building
- Limited space in existing urban context

2.2 Security Strategy

First Layer of Defense

- Unusual perimeter arcade, which provides attractive, integrated security
- Entry controls and screening

Second Layer of Defense

- Walls with attractive security fencing

Third Layer of Defense

- Building architecture incorporates risk mitigation measures



3.0 BLENDING WITH THE NEIGHBORHOOD CONTEXT

- Nice transition from neighborhood low-rise buildings
- Arcade and landscaped plaza adds amenity

4.0 INNOVATIONS AND BEST PRACTICES

- A mix of barriers and deterrents designed within the context of the site and its surroundings provides multiple layers of protection and creates an amenity for the neighborhood
- Security is part of the aesthetic of the architectural design, an integral component, instead of an afterthought

4.2.2 BARRIER CRASH TEST STANDARDS

There is a wide variety of design methods and devices that can be used to provide protection. The site risk analysis (see Chapter 2) will provide information on the nature of the threat to be mitigated, and the designer needs to know the relative performance of the methods that are available so that appropriate choices can be made for the various conditions that will be encountered. Since this publication is primarily concerned with protecting buildings from bomb-carrying vehicles, effectiveness in stopping vehicle entry is a critical performance parameter.

The crash testing standard in common use was developed by the Department of State (DOS). To obtain DOS certification, the vehicle barrier must be tested by an independent crash test facility to meet DOS standards. The test specifies perpendicular barrier impact by a 15,000-lb. (6810 kg.) diesel truck.

Initially, the DOS standard provided for three levels of intrusion:

- **Level 3:** Allows intrusion of the vehicle 36 inches (0.91 m) into the barrier
- **Level 2:** Allows intrusion of the vehicle 20 feet (6.1 m) into the barrier
- **Level 1:** Allows intrusion of the vehicle 50 feet (15.2 m) into the barrier

In February 2003, the standard was revised, and levels 1 and 2 were deleted. The standard currently provides certification for three classes of protection:

Certification Class	Speed (mph)	Speed (kph)
K12	50 mph	80 kph
K8	40 mph	65 kph
K4	30 mph	48 kph

To become certified with a DOS “K” rating, the 15,000-lb. vehicle must achieve one of the K-rating speeds, and the bed of the truck must not penetrate the barrier by more than 36 inches. The test vehicle is a medium-duty truck such as those that any driver with a commercial license and a credit card can buy or rent. Note that the amount of intrusion is measured to the front of the cargo bed of the truck, where explosives would typically be located (Figure 4-8).

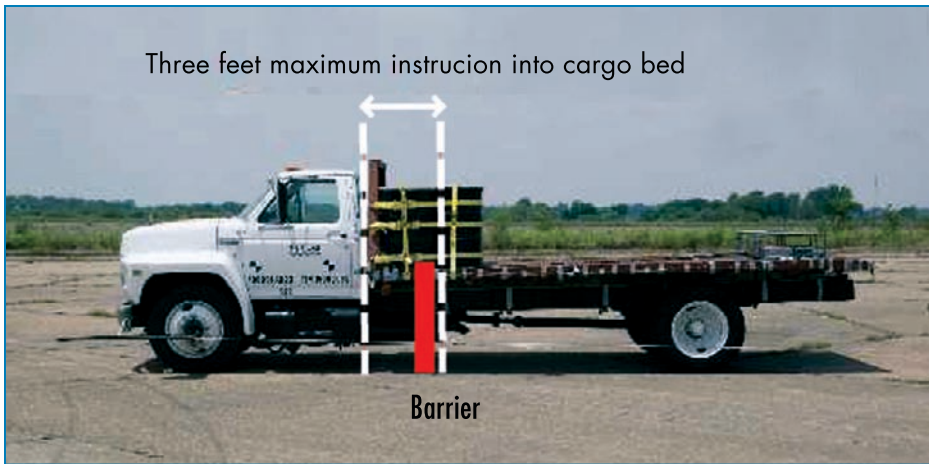

Figure 4-8:
Barrier test intrusion
limit.

This limited penetration is appropriate for the DOS because their facilities have usually been located in high-density areas with little or no setback. In open sites with more adequate setback, deeper penetration may be acceptable, and agencies, such as the DoD or the DOE, or the private sector, may reinstate deeper penetration levels in the new ASTM standard under development (see below). Where the setback is extremely limited, every foot of penetration is critical.

Recent experience has shown that terrorists are making increasing use of a “double tap” tactic in which the first vehicle is intended to breach the barrier so that a second vehicle can pass through and get close to the building. Careful design and control is necessary to prevent the first or second vehicle from entering the setback area.

The lack of a universally accepted testing and certification process for barriers has hindered the development of components that are uniquely designed and appropriate for well-planned streetscapes. Typical testing methods today include a computer simulation, using finite-element analysis, followed by an actual crash test at a controlled facility. Computer simulations can help refine design details and reduce overall costs. However, the live crash tests are generally needed to verify the performance of the barrier.

Oftentimes, security projects are designed under tight deadlines with limited budgets, so that few tested barriers are readily available. The result is that only a limited number of “off-the-shelf” items, such as bollards and concrete barriers, are available, and they may not be appropriate for every location. To prevent such occurrences, the design effort in a major project should include time and money for the design and testing of custom perimeter security elements in the early stages of the planning process.

A key aspect of testing an element is the availability of a proper standard by which to measure its effectiveness. Until recently, the general standard used was one created by the Department of State for overseas locations, utilized for domestic purposes. The standard does not provide for much flexibility in design. To address this, ASTM International has developed

a new standard (*WK 2534, Standard Test Method for Vehicle Crash Testing of Perimeter Barriers and Gates*) to expand upon the DOS crash test standard. To meet the diverse needs of the various groups that will use the new anti-ram standard, the types of test vehicles and test conditions included in the standard need to be expanded, and longer stopping distances will be reinstated for use on open sites where more space is available for greater stand-off distance.

The new standard will include additional vehicle sizes. The smallest will be a uni-body sedan that might be able to slip between bollards that would stop a larger and heavier vehicle, such as a single-unit truck or tractor-trailer. Another vehicle to be considered in the standard is a 3/4-ton (2000 kg) pickup truck. The largest vehicle will be a 60,000-lb. (27 metric ton) tractor-trailer or dump truck, which would test the limits of the barrier.

4.2.3 DETERMINING BARRIER DESIGN CRITERIA

The security design criteria required for a barrier are largely determined by key information obtained in the following steps in the risk assessment process:

1. Threat analysis should provide the following **Design Basis Threat** (see Chapter 2, Section 2.2.2, Step 1 of the FEMA Risk Assessment Steps) :
 - Vehicle size, weight, speed.
 - Bomb size (weapon yield in pounds of TNT equivalent) and worst-case stand-off distance.
2. Vulnerability analysis provides:
 - Building envelope and structural information that contribute to the determination of the appropriate stand-off distance, and that enable possible tradeoff between alternative building characteristics and stand-off distances to be evaluated and costed.
 - Information on available stand-off distances.
 - Information on the possible reduction of vehicle speed through the existing or modified characteristics of approach roads.
 - Limitations imposed by underground utilities.
 - Information on the types of soil, which affect barrier standards.

Other criteria relating to planning, architectural, and streetscape issues are discussed in the following sections.

4.3 BARRIER MATERIALS AND TYPES

4.3.1 MATERIALS

There are four commonly used building materials for perimeter barriers: steel, cast iron, reinforced concrete, and cast stone. Natural materials such as rocks, trees, plants and earth forms may also be incorporated in a barrier system.

- Steel or cast iron can be used in almost any design and are usually easier to install than other materials. They are very strong and, compared to concrete, permit a smaller barrier to stop a vehicle. Steel and cast-iron barriers require more maintenance than other materials, such as concrete, and routine painting is necessary to prevent rust.
- Reinforced concrete barriers take more time and manpower to install, but require little maintenance and are typically less expensive than steel or cast iron. Because concrete structures are commonly found in urban environments, this material is often more compatible with the surrounding context. Reinforced concrete barriers can be both poured-in-place and precast.
- Stone or granite security elements must be larger than steel or reinforced concrete elements and are often used in enclosed earthen walls or as benches. Granite is very durable and attractive, complementing the architecture of many buildings.

4.3.2 BARRIER TYPES

There are two basic categories of barriers: **passive** (fixed) and **active** (operable).

Passive barriers are fixed in place, do not allow for vehicle entry, and are used to provide perimeter protection away from vehicle access points. For jurisdictional purposes, they may typically be categorized into four types:

- Devices placed within the property lines of a building; they are usually not subject to city rules or regulations.
- Devices that are installed in the public right-of-way and that are under the jurisdiction of local planning and transportation regulations.
- Devices installed in privately maintained and privately owned public spaces (such as plazas built on private property in exchange for floor area bonuses) are usually under the jurisdiction of the local planning department.

- Devices installed on federal and state land are not required to comply with local regulations, although typically federal and state agencies work cooperatively with local departments.

Passive barriers include:

- Walls, berms, and ha-ha barriers
- Engineered planters
- Fixed bollards, heavy objects, reinforced street furniture, fixtures, and trees
- Water obstacles
- Jersey barriers in fixed and anchored installations
- Fences

These are listed in approximate order of typical impact ratings, with the highest first. Examples of crash ratings for engineered barriers are given in the type descriptions below.

Active barriers are used at vehicular access control points within a perimeter barrier system, or at the entry to specific buildings within a site, such as a parking structure or a parking garage within an occupied building, to provide a barrier for vehicle screening or inspection; they can be operated to allow vehicle passage. Catalog items can be obtained with DOS system ratings to resist various levels of impacts. The descriptive terminology varies among manufacturers.

- Rotating wedge systems
- Rising-wedge barricades
- Retractable bollards
- Crash beams
- Crash gates
- Surface-mounted wedges and plates

These are listed in approximate order of typical impact ratings, with the highest first. Examples of crash ratings for each type of barrier are given in the type descriptions below.

Active barriers are mechanical devices produced by a number of specialized manufacturers. Examples of each type are illustrated below to show designers their typical characteristics. Active devices must be used in conjunction with signage, light signals, gatehouses and security personnel:

these provide a challenging task to design an integrated grouping of objects that are in tune with the building and site.

In addition, some innovative barrier systems have been developed in response to design and cost-related demands. These include both active and passive devices:

- The NOGO system
- The Tiger Trap
- The Turntable

4.4 PASSIVE BARRIERS

4.4.1 WALLS, EXCAVATIONS, BERMS, DITCHES, AND HA-HA'S

Description, Purpose, and Performance

The hardened (or engineered) wall group includes retaining walls and freestanding walls. These may be constructed of reinforced or mass concrete, concrete masonry, brick, and natural stone, or other materials typically reinforced with steel. Walls may be designed to include sections of perforated walls or discontinuous walls to achieve improved appearance while still satisfying security requirements.

Figure 4-9 shows a reinforced concrete barrier wall that incorporates art work on its face, and Figure 4-10 shows a barrier wall integral with the building face in an urban site.



Figure 4-9:
Reinforced wall barrier
with artwork.

SOURCE: PHOENIX, ARIZONA,
POLICE DEPARTMENT, TODD
WHITE

Figure 4-10:
Reinforced concrete
barrier wall with
artwork at the Scottish
Parliament, Edinburgh.

SOURCE: ENRIC, MIRELLES,
BENEDATTA, TAGLIABUE
(EMBT) AND RMJM, JOINT-
VENTURE ARCHITECTS,
PHOTO: DUCCIO
MALAGAMBA



Walls can be engineered to provide any desired level of performance. It should be noted that concrete can become fragmented by an explosion and turn into projectiles that may cause serious damage to life and property.

Berms, excavations, and ditches can be effectively used to stop vehicles from penetrating the restricted territory. Triangular ditches and hillside cuts are easy to construct and can be effective against a wide range of vehicle types. Side hill cuts are variations of the triangular ditch, adapted to side hill locations, and have the same advantages and limitations. With this type of construction, a vehicle will be trapped when the front end falls into the ditch and the undercarriage is hung up on the leading edge of the ditch. Although untested, soil and rock can absorb large amounts of kinetic energy. Typical configurations and dimensions are shown in Figure 4-11. Both the configurations and dimensions should be carefully studied in relation to the types of vehicles expected to be encountered and the desired level of protection.

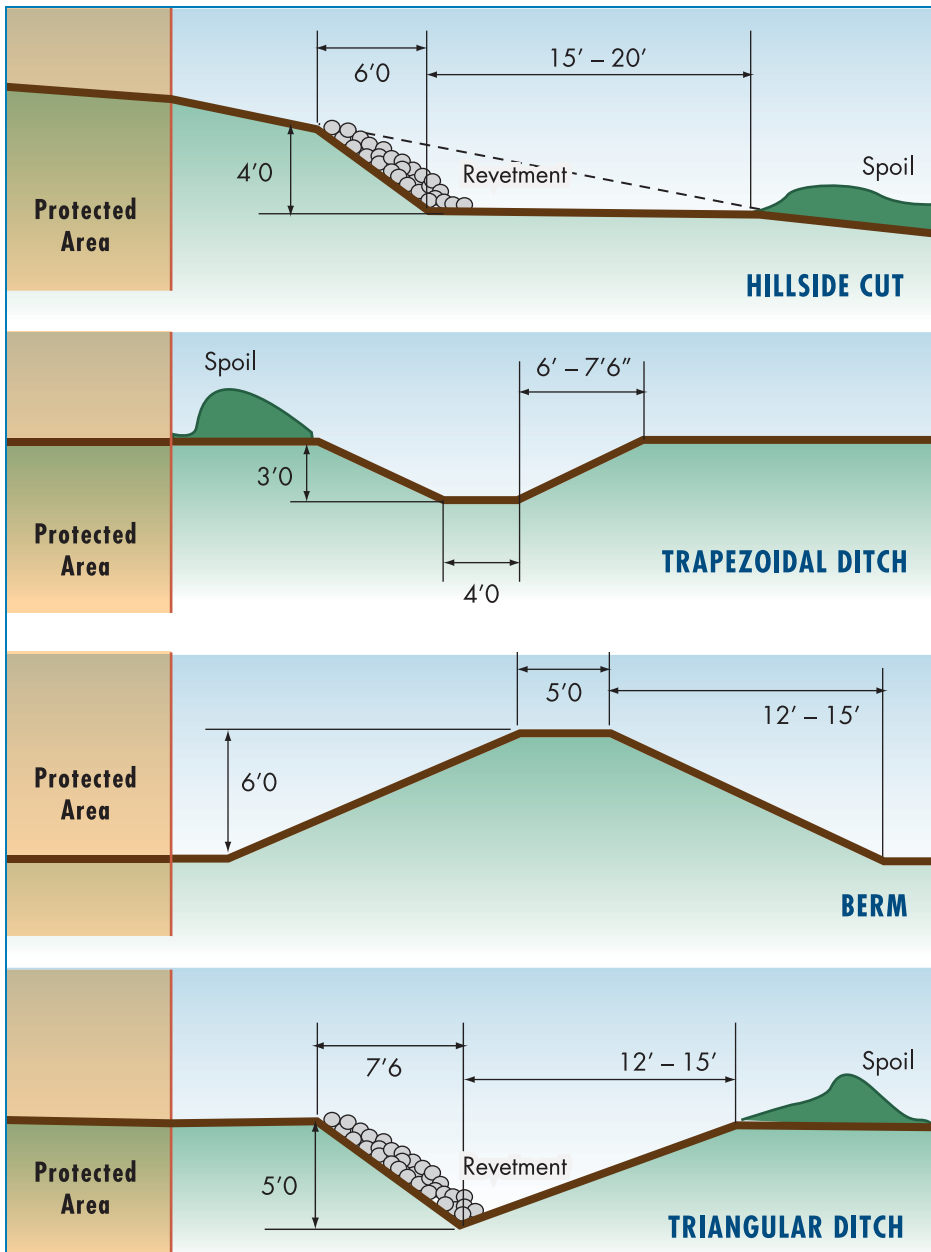

Figure 4-11:
Excavations, berms,
and ditches.

SOURCE: AFTER DOD
HANDBOOK:
SELECTION AND APPLICATION
OF VEHICLE BARRIERS, MIL-
HDBK-1013/14, 1999

The ha-ha is a form of barrier that originated for aesthetic purposes in 17th century England. The barrier was used to prevent cattle from wandering up to a country mansion, while at the same time the barrier wall was invisible to the house. This strategy has been adapted for use as a security barrier, most notably around the new setting for the Washington Monument. Here it replaces an unsightly circle of Jersey barriers and allows an unimpeded view of its surroundings from the base of the monument. Viewed from outside the site from below, the Jersey barriers are replaced by an elegantly detailed masonry wall. A happy historical reference is that Washington's home at Mount Vernon used ha-ha's for their original purpose (Figure 4-12)

Figure 4-12:

Top: Ha-ha diagram
(SOURCE: NCPC).

Center left: Jersey barriers at the Washington Monument.

Center right and bottom: Ha-ha's at the Washington Monument.



Installation

Although mass may provide an effective barrier in such walls as heavy masonry installed in a ha-ha, typical concrete walls require heavy reinforcing. Figure 4-13 shows a typical engineering detail of a low anti-ram wall and indicates the necessary dimensions and reinforcing for effective performance.

Design Implications

Unless carefully placed and designed, barrier walls can be intrusive elements. They should, as far as possible, only be used where a wall is essential, and where efforts are made by design and materials to reduce the negative impact. Ha-ha's are an effective way of providing a non-intrusive barrier that can be integrated into the landscape.

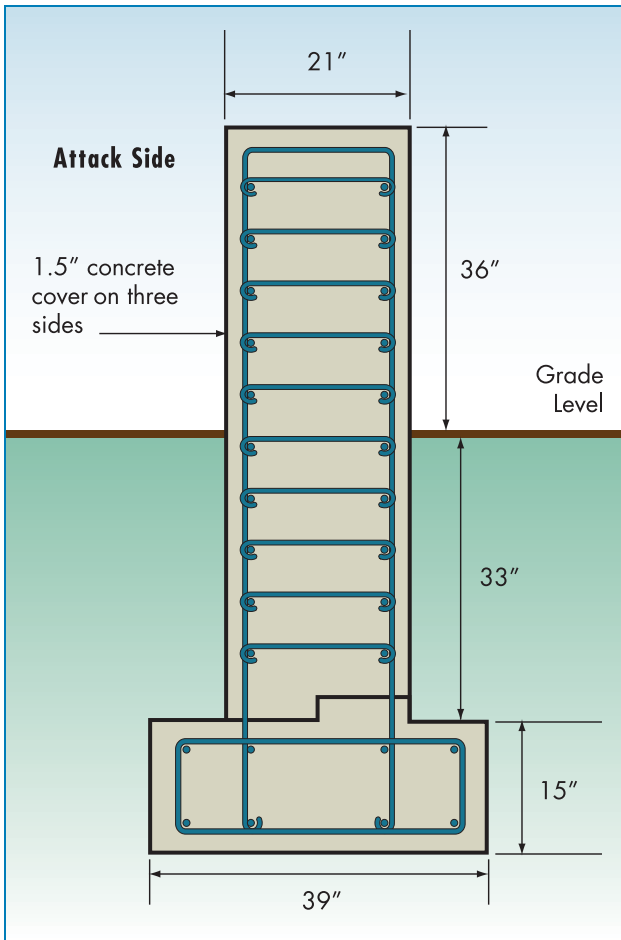

Figure 4-13:
Engineering detail of anti-ram low wall, to illustrate concept only; dimensions and reinforcing will vary.

SOURCE: DOS

4.4.2 ENGINEERED PLANTERS

Description, Purpose, and Performance

Well-designed planters can form an effective vehicle barrier. Planters located on the surface rely on friction to stop or delay a vehicle, and will be pushed aside by any heavy or fast-moving vehicle; displaced planters may become dangerous projectiles. Engineered planters need considerable reinforcing and below-grade depth to be effective and become fixed elements in the landscape design. The planter shown provides DOS K12 performance (Figure 4-14).

Protection may also be enhanced by the use of crash-rated bollards concealed in planters (Figure 4-15).

Figure 4-14:
Typical engineering detail of reinforced planter with DOS K12 performance, to illustrate concept only; dimensions and reinforcing will vary.
SOURCE: DOS

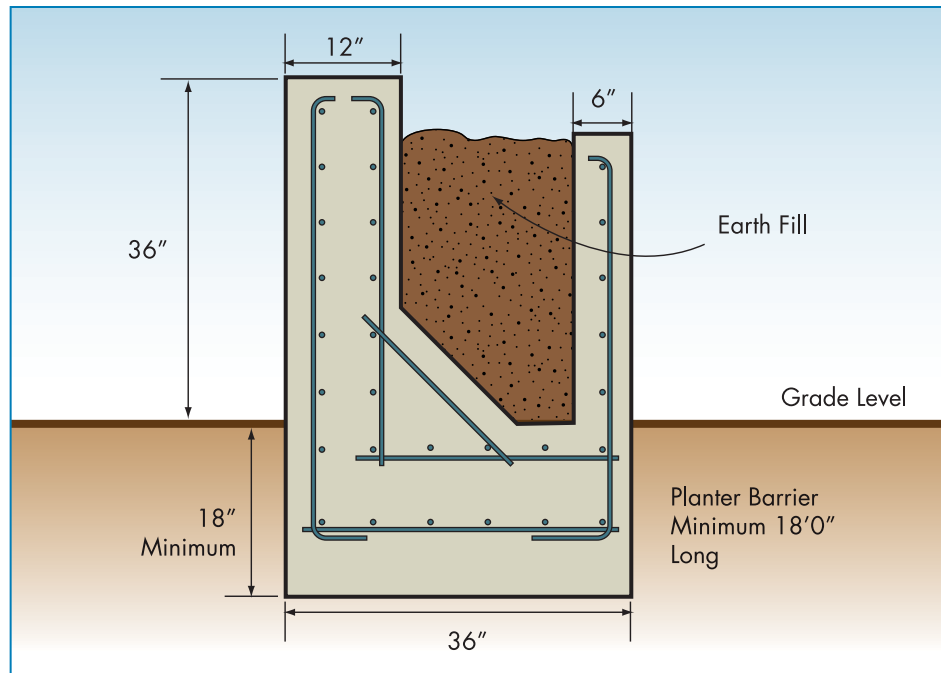

Figure 4-15:
Planter with concealed crash-rated bollards.
SOURCE: WAUSAU TILE



Installation

Some security guidelines for planter system installation are:

- Rectangular planters should be no more than two feet wide, and circular planters should be no more than three feet wide. The horizontal dimension of rectangular planters should not exceed six feet. These, however, are not the best sizes for viable plantings.

- A maximum distance of four feet, depending on the kind of traffic anticipated, should be maintained between planters and other permanent streetscape elements including, but not limited to, fire hydrants, light poles, mailboxes, trees etc. Any greater distance will allow a small car with a few hundred pounds of explosives to pass through.
- Planters should be oriented in a direction parallel to the curb or primary flow of pedestrian traffic. In no case should a planter or line of planters be placed perpendicular to the curb.
- Landscaping within planters should be kept below two-and-a-half feet, except when special use requirements call for increased foliage (Figure 4-16). In addition, planters should not have enough vegetation to hide a package six inches thick, a briefcase, or a knapsack.



Figure 4-16: Large planters as a barrier. The small planters de-emphasize the scale for the open-air restaurant. Despite the large planters, the effective sidewalk width remains wide.

- Planters should contain live landscaping at all times and be regularly cleaned of trash and debris.
- Planters should not be used in high pedestrian traffic areas. In these locations, bollards or other less obtrusive objects are appropriate.
- Planter design, location, and maintenance should create viable conditions for healthy plants. These include adequate water or irrigation, appropriate soil mixture, and selection of plants appropriate to be grown in planters. Seasonal characteristics and ultimate size of plant material shape the choices.

Design Implications

Planters can have a heavy impact on pedestrian movement, reducing the effective sidewalk width — the portion of the sidewalk that can be effectively used by pedestrians, defined as the width of the sidewalk minus the width of obstructions and the distance people stay away from them. However, well-designed and placed planters can have multiple functions and be civic amenities.

4.4.3 FIXED BOLLARDS

Description, Purpose, and Performance

A bollard is a vehicle barrier consisting of a cylinder, usually made of steel and filled with concrete placed on end in a deep concrete footing in the ground to prevent vehicles from passing, but allowing the entrance of pedestrians and bicycles. Bollards are also constructed of steel sections and reinforced concrete. An anti-ram bollard system must be designed to effectively arrest the vehicle and its cargo as quickly as possible and not create an opening for a second vehicle.

A typical fixed anti-ram bollard consists of a ½-inch thick steel pipe, eight inches in diameter projecting about 30 inches above grade and buried about 48 inches in a continuous strip foundation (Figure 4-17).

Figure 4-17:
Diagram of typical bollard installation. To illustrate concept only: dimensions and reinforcing will vary.
SOURCE: DOS

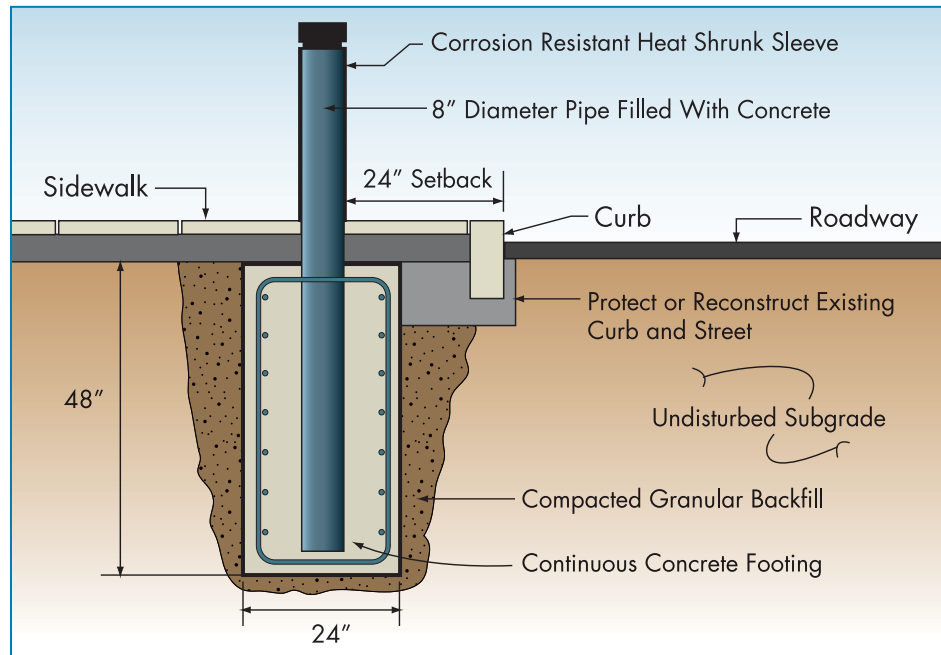

The bollard shown in Figure 4-17 would be capable of stopping a 4,500-lb. vehicle traveling at 30 mph. Rated bollards are also available that would provide protection up to DOS K12 level.

Bollards can be specified with ornamental steel trim attached directly to the bollard or with selected cast sleeves of aluminum, iron, or bronze that slip over the crash tube. Bollards can be galvanized against corrosion and fitted with internal illumination for increased visibility. Figure 4-18 shows a number of decorative bollards with high-performance ratings. Bollards may be custom designed for an individual project to harmonize with the materials and form of the building, but to ensure adequate protection, they would need to be tested by an independent laboratory (Figure 4-19).



Figure 4-18:
Decorative bollards with high-performance ratings.

SOURCES: TOP LEFT AND RIGHT: SECUREUSA, INC.
BOTTOM LEFT: DELTA SCIENTIFIC CORP.



Figure 4-19:
Custom-designed steel bollards that match the design of their buildings

Commonly used decorative bollards without deep foundations do not have anti-ram capacity, though they may provide some deterrence value by making the building look more protected than it is.

Installation

The need for bollards to penetrate several feet into the ground may cause problems with below-ground utilities whose location may not be known with certainty (Figure 4-20).

Figure 4-20:
Installation of fixed bollard line. Note the depth and size of the excavation.

SOURCE: SECUREUSA, INC.



If underground utilities make the installation of conventional bollard foundations too difficult, a possible solution is to use bollards with a wide shallow base and a system of beams below the pavement to provide resistance against overturning (Figure 4-21).

Figure 4-21:
Example of bollards with a wide shallow base and a system of beams.

SOURCE: RSA PROTECTIVE TECHNOLOGIES

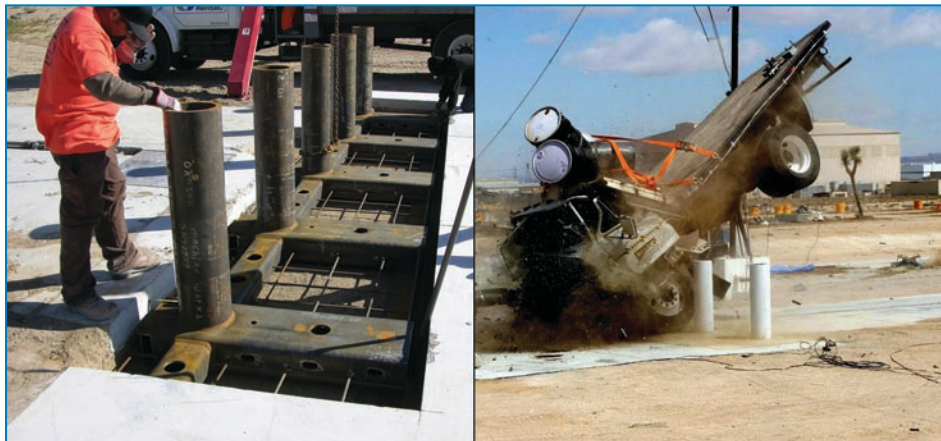

Design Implications

Bollards are by their nature an intrusion into the streetscape. A bollard system must be very thoughtfully designed, limited in extent and well integrated into the perimeter security design and the streetscape in order to minimize its visual impact

The visual impact of bollards can be reduced by limiting height to no more than 2 feet 6 inches. However, the height of the curb and its position relative to the bollard also relates to the bollard height. This and other site specific conditions such as road surface grade, may help to maintain an effective bollard for impact while making the bollard appear visually less obtrusive. In addition, the design basis threat, in terms of vehicle size and speed, also influences bollard height. In no case should bollards exceed a height of 38 inches inclusive of any decorative sleeve.

A bollard reduces the effective sidewalk width in a pedestrian zone by the width of the curb to bollard (typically 24 inches, plus the width of the bollard). In several high-pedestrian and narrow-sidewalk areas of a central business district, the reduction in effective sidewalk width can prove critical.

Other bollard system guidelines are:

- Spacing between 36 and 48 inches depending on the kind of traffic expected and the needs of pedestrians, people with strollers and wheel chairs and the elderly must be considered.
- In long barrier systems, the bollards should be interspersed with other streetscape elements such as hardened benches, light poles, or decorative planters.
- They should be kept clear of ADA access ramps and the corner quadrants at streets.
- They should be arranged in a linear fashion in which the center of the bollards is parallel to the center line of existing streets.

4.4.4 HEAVY OBJECTS AND TREES

Description, Purpose, and Performance

Heavy objects, such as large sculptural objects, massive boulders, earthen berms or concrete forms with unassailable slopes, and dense planting and trees can be used in a similar way to bollards to prevent vehicles from passing, while allowing the passage of pedestrians and bicycles. To ensure that such barriers can effectively reduce the threat level, engineering design and/or evaluation is necessary. For example existing dense thickets of mature trees can be incorporated into a perimeter system (Figure 4-22).

Figure 4-22:
Groups of mature
palm trees as
protection from
vehicular intrusion.

SOURCE: PHOENIX
POLICE DEPARTMENT,
ARIZONA CENTER, ROUSE
DEVELOPMENT CO.



Specially designed objects that also serve a practical and aesthetic purpose can be used as effective barriers (Figures 4-23, 4-24, 4-25, and 4-26).

Figure 4-23:
Combination low
retaining wall and
sculptural object as a
barrier system.





Figure 4-24:
Decorative obelisk at the approach to a Civic Plaza.

SOURCE: PHOENIX, ARIZONA, POLICE DEPT., TODD WHITE.



Figure 4-25:
Group of engineered sculptured objects as a barrier.

SOURCE: PHOENIX, ARIZONA, POLICE DEPT., TODD WHITE.

Figure 4-26:
An array of rocks form
an effective barrier.

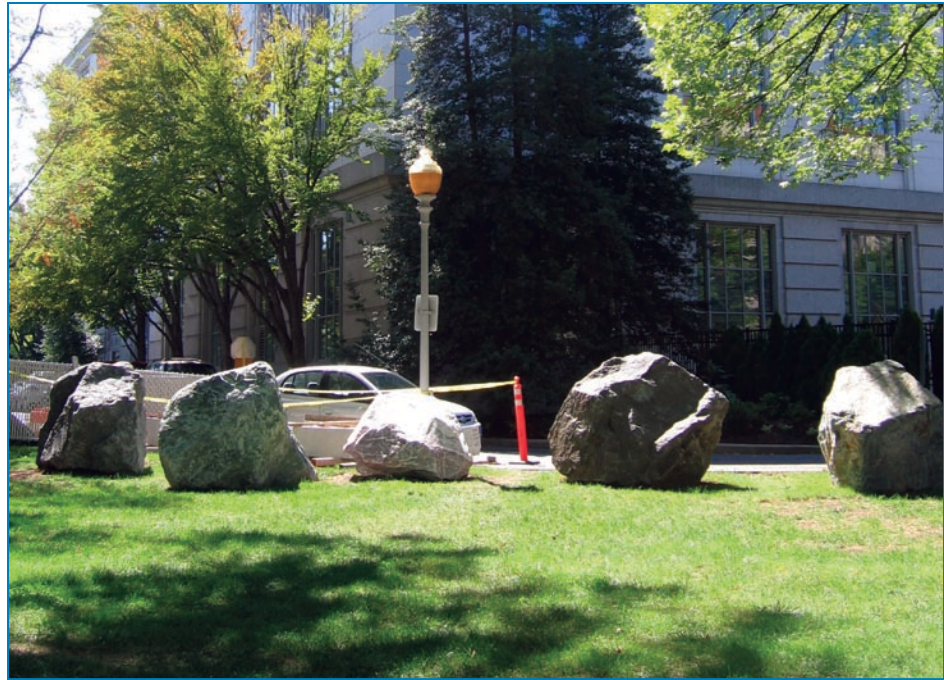

Figure 4-27 shows the use of custom bollards in combination with large rocks. The rocks have symbolic meaning as part of the landscaping of the space but are also engineered barriers.



Figure 4-27:
Selected rocks and custom bollards as
barriers: scale and placement provide
nonintrusive security.



Installation

Objects used as barriers will need varying degrees of embedment and reinforcement, depending on their weight, footprint, and height/width ratio.

Design Implications

The use of natural features such as rocks, or man-made objects such as sculpture, provides opportunities for creating barriers that can enhance the visual environment, effectively delineate pathways, clarify public and private space, and provide protection in an unobtrusive manner.

4.4.5 WATER OBSTACLES

Description, Purpose, and Performance

One of the oldest forms of site security design is that of water. Used in the form of artificial or natural lakes, ponds, rivers, and fountains, water can be an effective and beautiful choice for a barrier. The configuration of the channel can be designed as an effective "tank trap," or walls of the pool or mass of the fountain can be engineered to stop a vehicle. The water can be presented in a variety of ways — flat and smooth or enhanced with movement by falls or fountains. Water features generally require ongoing maintenance with filters, pumps, cleaning, etc. (Figure 4-28).



Figure 4-28:

This proposal for the re-design of the Washington Monument grounds uses water to create a barrier. The meandering canal is quite beautiful as well as functional.

SOURCE: MICHAEL VAN VANDENBURGH AND ASSOCIATES

An example of a water barrier in an urban setting is also shown in Chapter 6, Section 6.4, Figure 6-19.

4.4.6 JERSEY BARRIERS

Description, Purpose, and Performance

A Jersey barrier is a standardized precast concrete element originally developed in the 1940s and 1950s by New Jersey, California, and other states as a median barrier to prevent vehicle crossovers into oncoming traffic. The New Jersey barrier became the most widely used and gave its name to the generic barrier type. Subsequently, the barrier was widely used for temporary protection in highway and other construction projects, and came into wide use after September 11, 2001, as an anti-ram and traffic control barrier against terrorist attack.

The barriers are not easily adaptable: they come in standard lengths of 12.5 and 20 feet, making their use somewhat inflexible, and they must be carefully installed or they may create undesirable spaces where they overlap, and reduce sidewalks to non-navigable widths (Figure 4-29).



Figure 4-29: Jersey barriers: pedestrian disruption at the White House (left) and on a D.C. Street (right).

Jersey barriers were thought to provide protection through their mass — a 12-foot barrier weighs approximately 5,700 pounds — but if placed on the surface, they are ineffective against vehicular attack. To be effective, they need embedment and vertical anchorage by steel reinforcing through the foundation.

The Jersey barrier shown in Figure 4-30 is capable of stopping a 4,000-lb. vehicle traveling at 50 mph and a 12,000-lb. vehicle traveling at 25 mph. Note that the barrier is embedded about 12 inches and anchored to the concrete slab with reinforcing bars: in this installation, the barriers essentially become permanent (Figure 4-30).

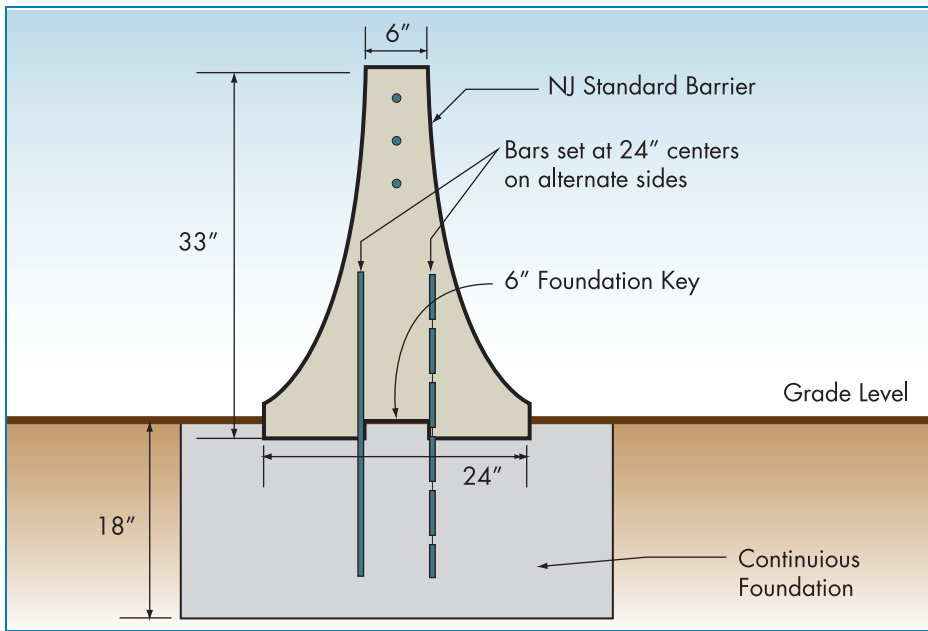

Figure 4-30:
Jersey barrier
dimensions and
installation for high
level of protection.

SOURCE: DOD
HANDBOOK: *SELECTION
AND APPLICATION OF
VEHICLE BARRIERS*, MIL-
HDBK-1013/14, 1999

Installation

When installed on a sidewalk, a Jersey barrier reduces the effective sidewalk width by three-and-a-half feet, plus whatever distance it is placed from the curb. Some installations can be dangerous in the event of an emergency evacuation, particularly when several barriers are connected without breaks, because there is no easy way for pedestrians to move past them.

Design Implications

Relatively inexpensive and readily available, Jersey barriers became ubiquitous in the protection of public buildings and monuments in Washington, New York, and elsewhere. However, their often awkward placement may degrade the beauty of the urban scene and disrupt access and movement for those on affected streets and sidewalks. Their most effective use is on a temporary basis.

4.4.7 FENCES

Description, Purpose, and Performance

Fences are a traditional choice for security barriers, primarily intended to discourage or delay intruders or serve as a barrier against stand-off weapons (e.g., rocket-propelled grenades) or hand-thrown weapons such as grenades or fire-bombs. Familiar fence types include:

- Chain-link
- Monumental fences (metal)

- Anti-climb (CPTED) fence
- Wire (barbed, barbed tape or concertina, triple-standard concertina, tangle-foot)

Descriptions of these fence types can be found in FEMA 426, Section 2.4.1.

These fencing types are primarily intended to delay intrusion; they provide limited protection against vehicles unless specially designed to be crash-rated.

Fencing can also incorporate various types of sensing devices that will relay warning of an intruder to security personnel. Concealed intrusion detection systems are also available, incorporating buried field units and sensor cables.

Fences can also be constructed as engineered anti-ram systems. A typical solution is to use cable restraints to stop the vehicle: these can be placed at bumper height within the fence, hidden in planting. The cable needs to be held in place using bollards and anchored to the ground at the ends (Figure 4-31).

Figure 4-31:
Layout of cable barrier, used in conjunction with fence or planting.

SOURCE: DOD HANDBOOK:
SELECTION AND APPLICATION
OF VEHICLE BARRIERS, MIL-
HDBK-1013/14, 1999

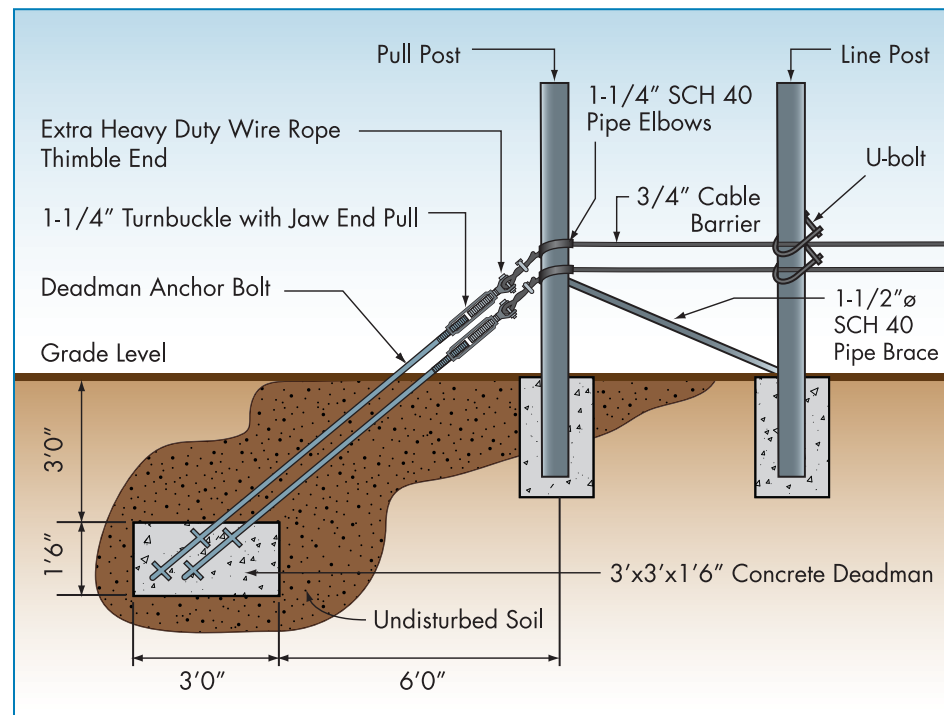

High-security cable fencing is available that can provide protection to the original DOS Standards of providing an L1 rating (20 to 50 feet penetration) or L2 rating (3 to 20 feet penetration).

Installation

Cable system fences allow considerable deflection before vehicles are stopped; vehicles will be able to partially penetrate the site before resistance occurs. The amount of deflection is based upon the distance between the concrete “deadmen” — typically about 200 feet. As a result, the siting requirements for fences and gates that incorporate a cable system differ slightly from other types of walls and fences. The designer should take this into consideration when these types of systems are being considered. Conventional fences with crash ratings can also be provided (Figure 4-32).



Figure 4-32:
Crash-rated fence.

SOURCE: AMERISTAR FENCE PRODUCTS INC.

Design Implications

Fences for the protection of property have a long history and have also often been elements of great beauty. Modern fences are governed more by function and cost, but variations of historic fence design have been used as barriers for important historic buildings. The appearance of less attractive fencing can be improved by planting.

4.4.8 REINFORCED STREET FURNITURE AND FIXTURES

Description, Purpose, and Performance

Common streetscape elements can be reinforced to serve as anti-ram barriers. These elements can be designed to be “hardened” so that they function both as amenities and as components of physical building perimeter security. The structural design, spacing, shape and detailing of the perimeter security components must be designed to address the required

level of protection for a particular building. Typical elements that lend themselves to this approach include hardened street furniture, fences or fence walls, plinth walls (low retaining walls), bollards, planters, light standards, bus shelters etc (Figure 4-33).

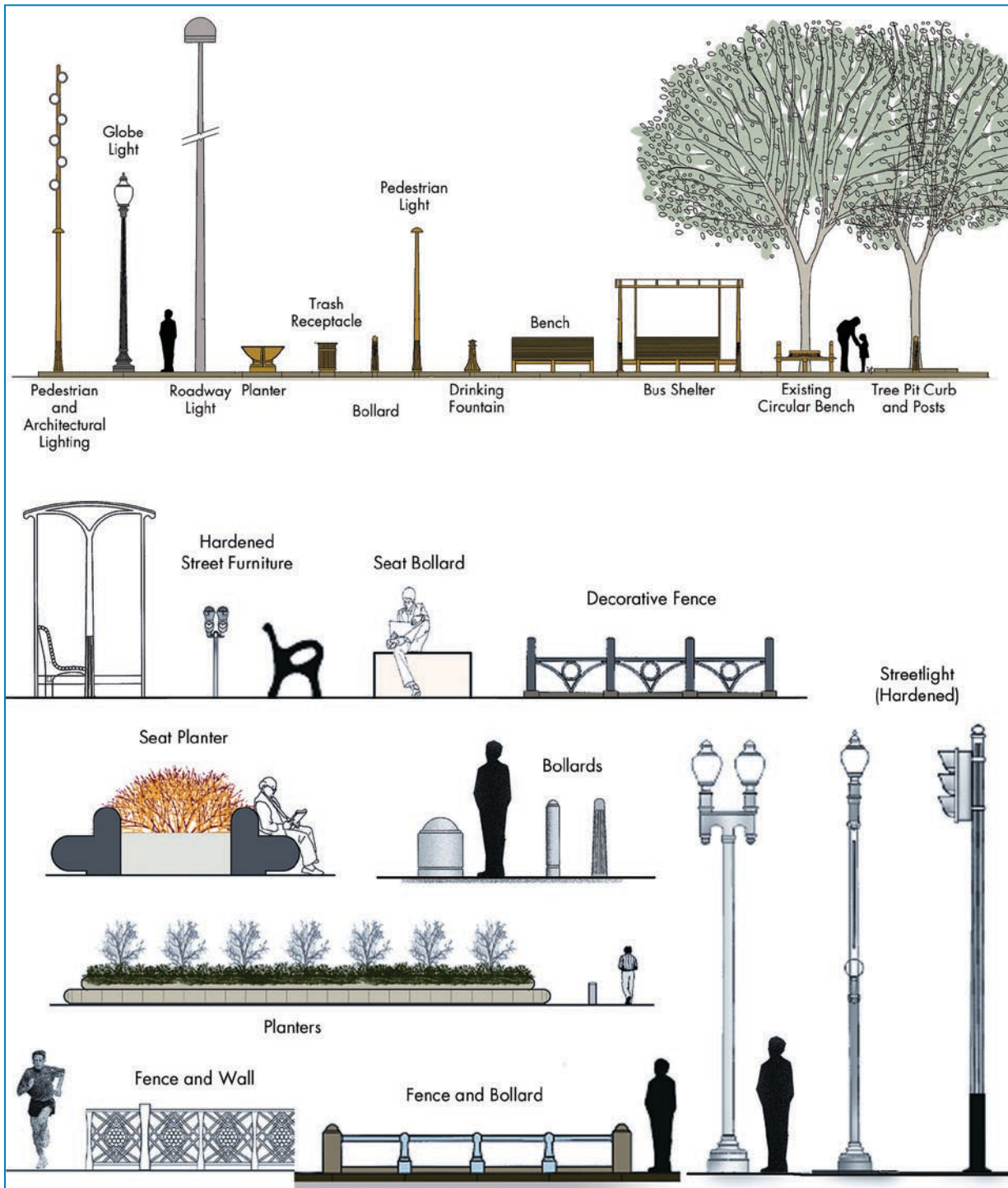

Figure 4-33: Streetscape elements suitable for hardening as security elements

SOURCE: NCPD

To date, bollards have tended to become ubiquitous as perimeter barrier systems. Security device manufacturers have found sufficient demand to justify development and testing of active and passive bollards. They have also responded to design demands by providing decorative covers in a number of materials, which has greatly improved their appearance, but there is need for more variety in barrier system design. This variety can be provided by the use of hardened streetscape elements, but this approach has been limited due to the lack of tested and certified examples. Development of such elements is important to enable the design of an attractive and secure urban environment. An improvised example of this approach, using crash rated bollards concealed between two benches, is shown below ((Figure 4-34).



Figure 4-34:
Outdoor seating reinforced with hidden bollards.

SOURCE: SECURE USA, INC.

Supplementing bollards with common other reinforced streetscape components such as lamp standards, bus shelters, and kiosks can assist in relating security design to the community context. Such components would need testing to ensure acceptable performance, but the use of custom-designed components would enhance the streetscape and add an additional level of safety to pedestrians against everyday traffic accidents. Some example of these applications are shown in the following graphic boxes.



CUSTOM STREET FURNITURE BARRIERS (continued)



CUSTOM STREET FURNITURE BARRIERS (continued)



An example of a custom-designed streetscape feature is that of reinforced glass seating that provides a considerable level of protection, looks attractive, and can be illuminated to provide additional night protection at locations such as bus stops (Figure 4-35).

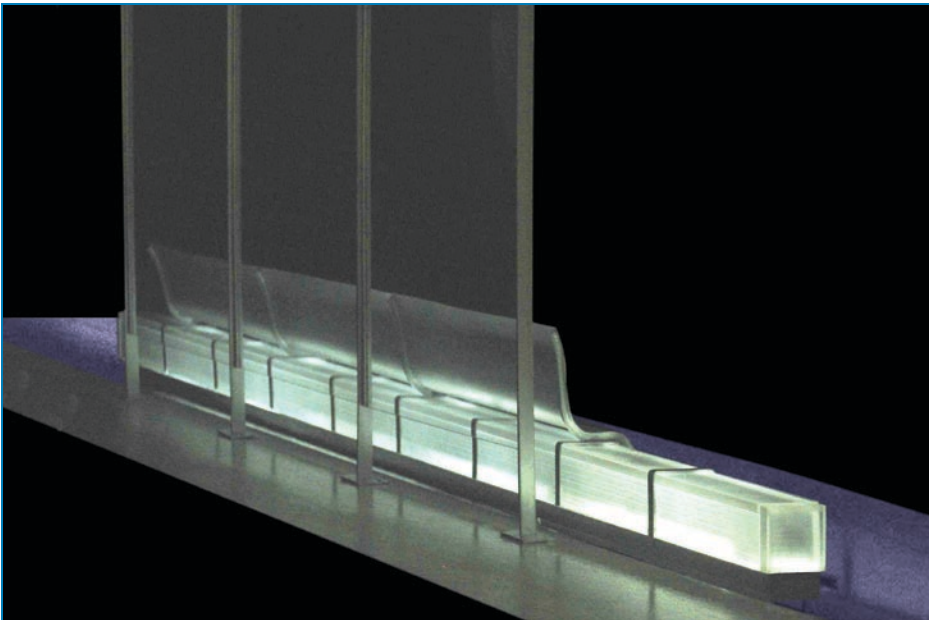

Figure 4-35:
Reinforced and illuminated glass bench model.

SOURCE: ROGERS MARVEL ARCHITECTS, LLC

4.5 ACTIVE BARRIERS

4.5.1 RETRACTABLE BOLLARDS

Description, Purpose, and Performance

A retractable bollard system consists of one or more rising bollards operating independently or in groups of two or more units. The bollard is a below-ground assembly consisting of a foundation structure and a heavy cylindrical bollard that can be raised or lowered by a buried hydraulic or pneumatic power unit, controlled remotely by a range of access control devices. Manually operated systems are also available: these are counter-balanced and lock in the up or down position. Typical retractable bollards are 12 to 13 inches in diameter, up to 35 inches high, and are usually mounted about three feet apart, depending on the type of traffic. Figure 4-36 shows typical installations of retractable bollards, with fixed bollards to each side of the retractable array.



Figure 4-36:

Typical retractable bollard systems at a service entry (left) and a parking garage (right). Note the fixed bollards to each side of the retractable arrays.

Retractable bollards are used in high-traffic entry and exit lanes where vehicle screening is necessary, at site entrances, and at entries to parking garages and building services. Unlike rising or rotating wedge barriers, the entry is freely accessible to pedestrians when the bollards are raised.

Normal bollard operating speed is field adjustable and ranges from 3.0 to 10.0 seconds. Emergency operating systems can raise bollards to the guard position from fully down in 1.5 seconds.

Retractable bollards are available crash rated up to DOS K12 standard.

Installation

Retractable bollards are expensive because they need deep and broad excavation for the bollards and operating equipment. Figure 4-37 shows a single bollard installation and the installation requirements for a set of bollards.

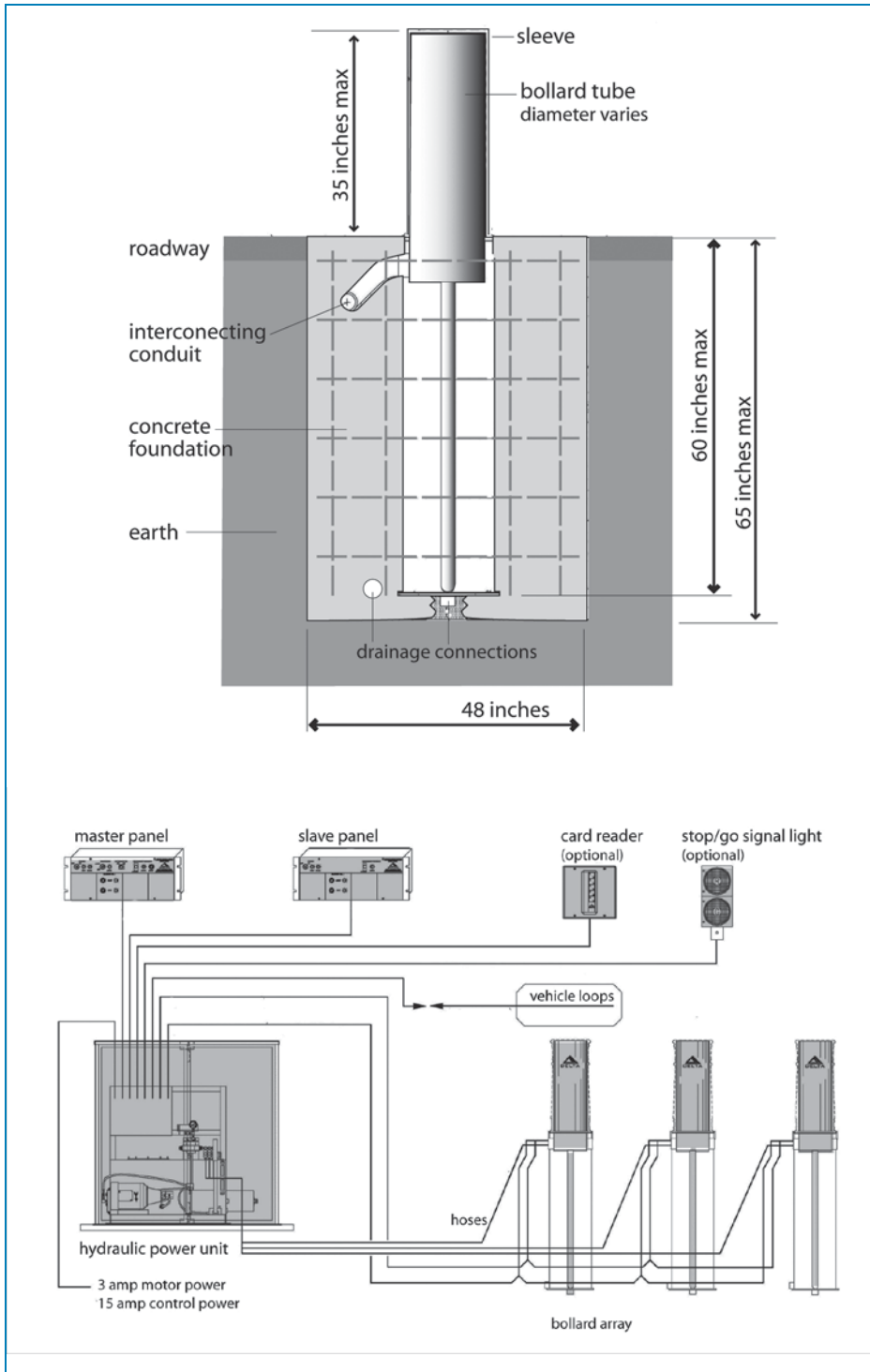

Figure 4-37: Retractable bollard installation section (top) and installation requirements for power and control of a set of bollards (bottom).

SOURCE: DELTA SCIENTIFIC CORP.

- Retractable bollards are a relatively unobtrusive barrier, which need only be raised when screening is necessary, although at a time of heightened threat they can remain in their raised position. A variety of ornamental sleeves can be provided. Retractable bollards are generally accompanied by fixed bollards at the sides, and a secure control booth is necessary for security personnel.

4.5.2 RISING WEDGE BARRIERS

Description, Purpose, and Performance

Wedge barriers, sometimes called rotating plate barriers, consist of a metal plate installed in a roadway that can be raised or lowered by an attendant usually located in a booth next to the metal plate, thus regulating vehicle access to the street across which it is installed. These barriers can be crash rated and can effectively stop vehicles. Their primary purpose is to create a restricted area by regulating vehicle access, rather than to block an area from all vehicles. Shallow foundation systems are available rated to DOS K12 standard. Raised height is from about 21 inches to 38 inches, and a standard width is 10 feet. In the retracted position, the heavy steel ramp will support any permitted road transport vehicle axle loadings. The moving plate is raised and lowered by a hydraulic or pneumatic system (Figure 4-38).

Figure 4-38:
Rising wedge barriers.

SOURCE: DELTA SCIENTIFIC
CORP.

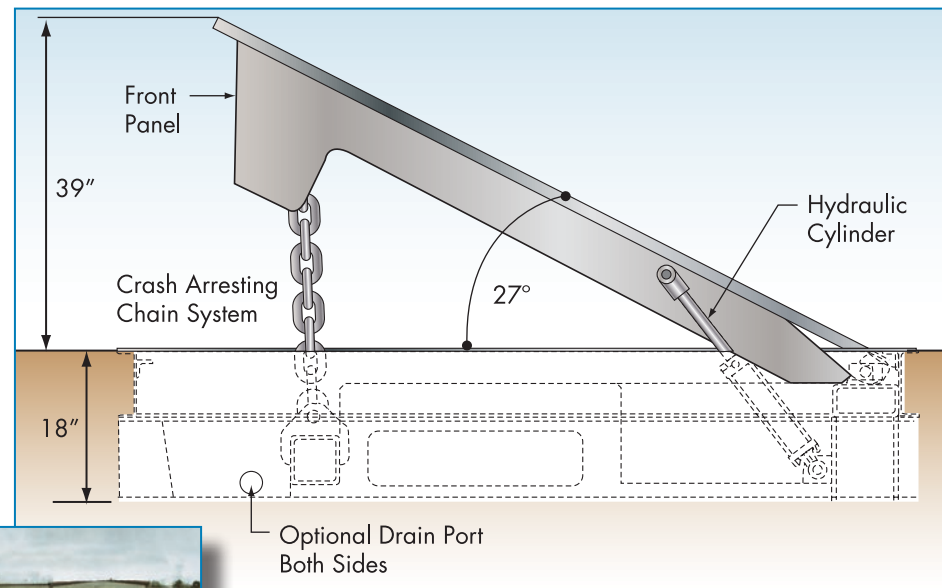

Installation

Wedge barriers can be surface mounted, or mounted in a shallow excavation about 18 inches deep. In the latter installation, the barricade plate is flush with the road surface when retracted. The power unit can be configured to operate one or more barricades and can be operated by a range of optional remote control inputs. In surface-mounted installations, all components are mounted above grade; no cutting or excavation is required on good concrete surfaces.

Mobile wedge barriers are also available that can be moved into position by a medium-sized pickup truck in 15 minutes. These can form an effective element of a planned temporary barrier to respond to a heightened threat level (Figure 4-39).



Figure 4-39:

Mobile wedge barrier.

SOURCE: DELTA SCIENTIFIC CORP.

Design Implications

Rising wedge barriers were one of the earliest active barrier systems to be developed. They are somewhat utilitarian in appearance, compared to retractable bollards or rotating wedge systems.

These barriers effectively restrict vehicular through movement, but care must be taken to ensure that limitations on the passage of screened bicycles, cars and emergency vehicles are minimized. Like all active barriers, mobile wedge barriers must be attended at all times.

4.5.3 ROTATING WEDGE SYSTEMS

Description, Purpose, and Performance

These systems are similar in action to the rising wedge blocker outlined in Section 4.5.2 but have a curved front face, providing a better appearance, and are embedded to a greater depth. The height of the obstacle is between 24 and 28 inches, and a standard width is 10 feet. The obstacle is operated hydraulically by heavy duty rams. Operating time is about three seconds per movement (Figure 4-40).

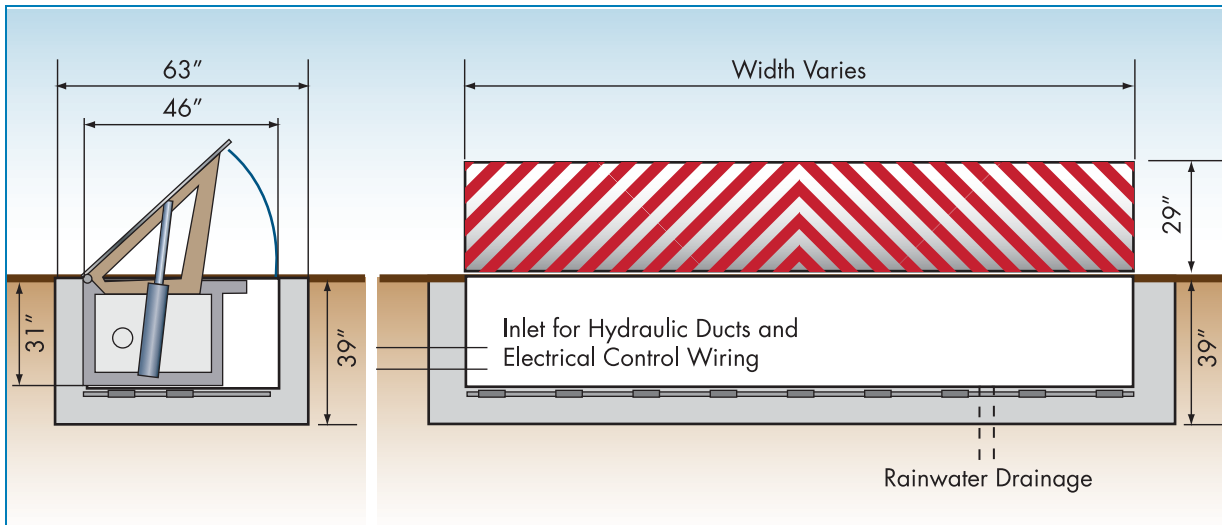

Figure 4-40: Typical rotating wedge barrier dimensions and installation requirements.

SOURCE: DELTA SCIENTIFIC CORP.

Installation

The pit to receive the system is approximately 5 feet wide, 40 inches deep, and about 6 inches wider than the width of the obstacle. The hydraulic mechanism can be located up to 50 feet away from the barrier.

Design Implications

Appearance depends on the layout and design of any accompanying fixed barriers and control booths, the design of operating buttresses, and the color and pattern of the barrier (Figure 4-41).



Figure 4-41: Rotating wedge installation with typical manufacturer’s jazz pattern (left), rotating plate barrier with stop sign in an elegant font combined with well-designed fixed low bollards (right).

4.5.4 DROP ARM CRASH BEAMS

Description, Purpose, and Performance

Drop-arm crash beams are a greatly strengthened version of barriers familiar at parking garage entries and the like. To create a crash barrier, the assembly consists of a steel crash beam, support and pivot assembly, cast-in-place concrete buttress, and locking and anchoring mechanisms. In addition, crash-rated beams incorporate a high-strength steel cable, which is attached to both buttresses when the arm is in a down position. Clear opening range is from about 10 to 24 feet. The arm is raised and lowered using a hydraulic or pneumatic system, or manually with a counter-balanced arm (Figure 4-42).



Figure 4-42: Drop-arm crash beam.

While crash-rated drop beams can be obtained, their performance is typically less effective than other active systems, although barriers can be obtained with a certified K12 performance rating.

4.5.5 CRASH GATES

Description, Purpose, and Performance

Crash-rated gates can be obtained that operate without contact with the ground, while others use a rack-and-pinion drive across a V-groove. Swing versions are also available. Clear opening range is from about 12 feet to 30 feet. Typical heights are 7 feet to 9 feet (Figure 4-43). Crash ratings up to DOS K12 can be obtained.

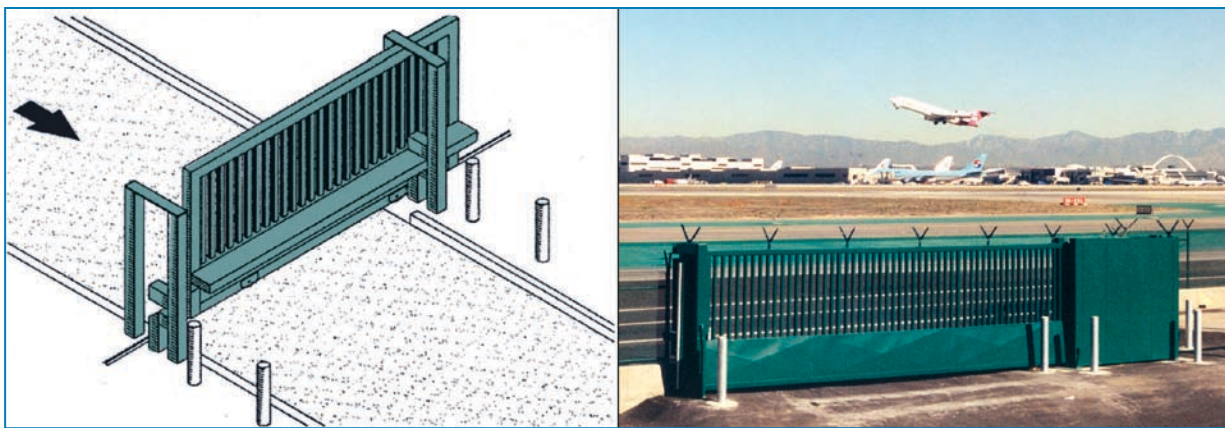

Figure 4-43: Typical gate installation (left); sliding gate with K12 crash rating (right).

SOURCE: DELTA SCIENTIFIC CORP.

4.5.6 SURFACE-MOUNTED ROTATING PLATES

Description, Purpose, and Performance

Surface-mounted wedges and plates are modular bolt-down barrier systems in which all components are mounted above grade, and no cutting or excavation is needed on most concrete surfaces. The moving plate or wedge is raised and lowered by a hydraulic, pneumatic or electro-mechanical drive. A typical unit incorporates a single buttress with a ramp width of 10 feet and a raised height of 21 to 28 inches. Dual buttress systems have a width of about 18 feet. These systems can be installed quickly and removed easily. Some systems incorporate a drop arm and traffic lights for additional safety (Figure 4-44).

Typical cycle time is three to four seconds with a 1.5 second emergency cycle. High-performance systems are capable of a DOS K4 rating.



Figure 4-44:
Surface-mounted wedges: single butress with lighting (left); dual butress with drop arm (right).
SOURCE: SECUREUSA INC.

4.6 INNOVATIVE BARRIER SYSTEMS

After September 11, 2001, designers outside the traditional security industry began to develop systems that combine functionality with better appearance and, in some cases, lower cost. The use of the ha-ha, described in Section 4.4.1, is an example of a traditional barrier imaginatively adapted to meet a contemporary and quite different need. Three innovative systems are described in Section 4.6.1. The NOGO barrier and “TigerTrap” are passive systems, while the “Turntable” is an active barrier.

4.6.1 THE NOGO BARRIER

Originally designed for the Wall Street area of New York City, the NOGO barrier is an example of a device that provides an effective vehicle barrier, while also being visually attractive and useful to lean on, socialize or enjoy a lunch around, and as such makes a positive contribution to the streetscape. The NOGO barrier is part security device and part a public art object and has been exhibited at the New York Museum of Modern Art. While more expensive than bollards, these simple yet subtle bronze forms of a beautiful material provide a lasting benefit to the street scene (Figure 4-45). Combined with the Turntable (see below) the NOGO, can also be part of an active anti-ram system.

Figure 4-45:
NOGO bronze
sculptured barriers.

SOURCE: ROGERS MARVEL
ARCHITECTS, LLC



4.6.2 THE TIGERTRAP

The TigerTrap is a collapsible sidewalk and planting system designed to reduce the impact of force protection on public space while maintaining a high level of security. The TigerTrap employs a sub-grade collapsible material, installed below at-grade paving or planting. The installation is designed to withstand pedestrian traffic but fail under the weight of a loaded vehicle. The collapsible material lowers the elevation of an attacking vehicle, so that it may be stopped by a low bench or underground foundation wall. The system employs a compressible concrete technology developed as an aircraft arrestor system that is installed at the end of the overrun section of runways, instead of net systems commonly used.

The system is designed for use in sites where there is considerable space available. The TigerTrap has been crash tested by the U.S. Army Corps of Engineers and has been demonstrated to be approximately equivalent to the DOS K12 standard.

The system needs careful design to be effective against design threat vehicles without blocking lighter vehicles such as golf carts and motorized wheel chairs; it needs considerable length to be effective (Figures 4-46, 4-47).

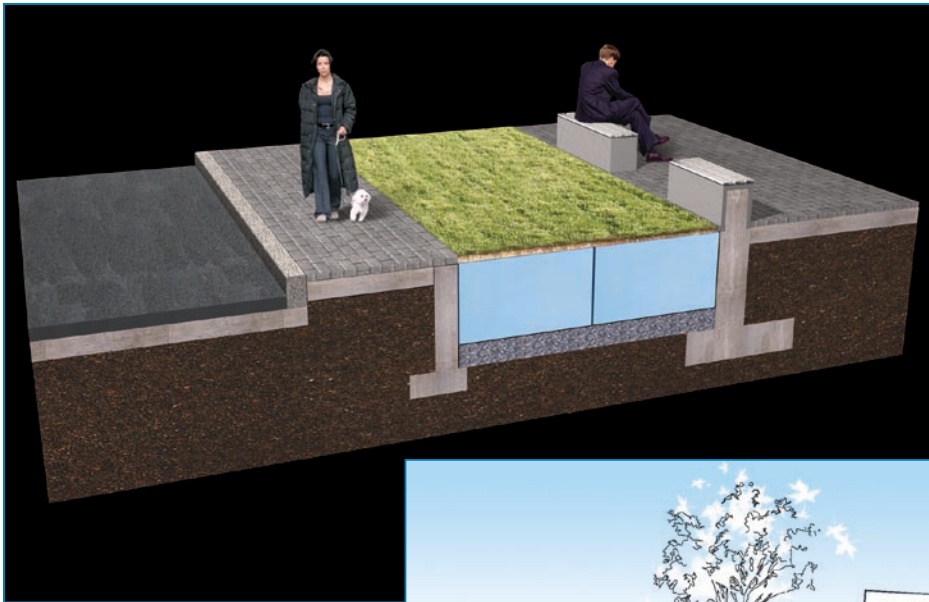

Figure 4-46:
The TigerTrap concept.
SOURCE: ROCK 12 SECURITY ARCHITECTURE



Figure 4-47:
Planting cover layer creates a TigerTrap planting with a rear bench.
SOURCE: ROCK 12 SECURITY ARCHITECTURE

4.6.3 THE TURNTABLE VEHICLE BARRIER

The Turntable Barrier concept was designed specifically to overcome difficulties of installation in an urban environment, by use of a state-of-the-art technology in operable anti-ram devices, while fostering a positive pedestrian environment (Figure 4-48).

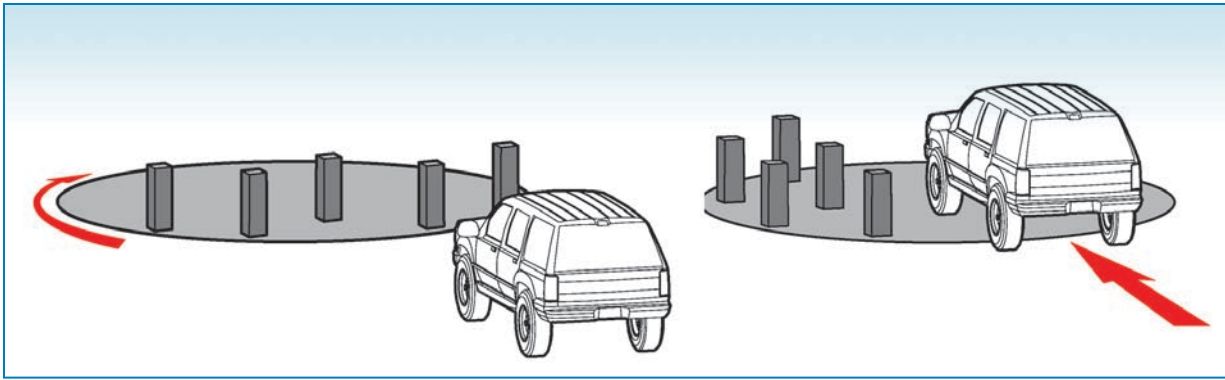

Figure 4-48:

Turntable designed for conditions where security devices do not fit easily amid the tangle of underground utilities and infrastructure.

SOURCE: ROCK 12 SECURITY ARCHITECTURE

The Turntable Vehicle Barrier is a shallow-foundation operable device designed to provide the function of retractable bollards without deep foundations. The foundation requires less than 2 ½ feet of depth, placing the installation above most underground utilities. The turntable employs a non-hydraulic friction wheel drive system, a proven technology used in rotating structures all over the world that alleviates many of the operational and maintenance difficulties associated with hydraulic devices. The rotational movement, while rapid enough for security purposes, does not pose a pedestrian danger.

The turntable is presently undergoing an extensive program of crash testing to obtain certification.

The surface of the turntable is designed to accept a paving layer to match surrounding materials, and the impact posts can accept covers of any shape and size, such as architectural metals, walls, or planters (Figure 4-49).



Figure 4-49:

Shallow depth allows the turntable to avoid underground utilities. Impact posts keep the street open to pedestrians (top), and the turntable can accept architectural covers on the impact posts and matching paving to the surrounding roadway (right).

SOURCE: ROCK 12 SECURITY ARCHITECTURE

4.7 CONCLUSION

The design of the perimeter barrier system is one of the most important aspects of providing building security. Design practice has evolved rapidly from the hasty installation of Jersey barriers after September 11, 2001, to the more considered designed systems that represent today's best practice.

Today's best practices often involve imaginative use of both traditional and new concepts and materials, in the attempt to balance the needs of security with those of site amenity and everyday function. They have been developed in response to the perceived shortcomings of initial solutions. Too often these solutions, conceived to be temporary, lasted for many years, and some have become all but permanent. To the extent that this has happened, and the visual and functional quality of our environment has been de-humanized, it can be said that the terrorists have gained a victory.

Access and egress control points need careful design and location, because they weaken the security of the perimeter. On the other hand, a second point of egress is necessary in case an egress point is shut down by police action, bomb squad activities, or other incidents.

The examples in this publication show that imaginative design of barrier systems can provide positive enhancement of the urban environment, by more clearly defining the types of public and private space and by providing city goers with more protection from everyday traffic. Innovation in barrier design is also underway, spurred on by the needs of special situations such as the New York financial district, which is both high risk and historic. The aim should be to develop building protection methods that are unobtrusive elements in a safe and attractive streetscape.