

Pharmacology/Therapeutics I Block 1 Lectures – 2013-14

1. Introduction to Pharmacology – Clipstone
2. Principles of Pharmacology – Fareed
3. Drug Absorption & Distribution – Byron
4. Drug Elimination & Multiple Dosing – Byron
5. Clinical Pharmacokinetics – Quinn
6. Drug Metabolism – Marchese
7. Pharmacogenomics – Marchese
8. Drug Toxicity – Marchese
9. Pharmacodynamics I – Battaglia
10. Pharmacodynamics II – Battaglia
11. Drug Discovery & Clinical Trials – **To Be Posted Later**

PHARMACOLOGY & THERAPEUTICS COURSE INTRODUCTION

I. INTRODUCTION

Overview

- (i) The word Pharmacology is originally derived from the Greek: *pharmakon* –meaning drug and *logos*-meaning knowledge.
- (ii) **Pharmacology can be defined as “the study of the effects of drugs on the function of living organisms”.** In a broader sense, Pharmacology deals with the actions, mechanism of action, clinical uses, adverse effects and the fate of drugs in the body.
- (iii) Drugs are defined as chemical substances, other than nutrients or essential dietary ingredients, that when administered to a living organism result in a distinct biological outcome.
- (iv) Drugs maybe purified chemicals, synthetic organic chemicals, substances purified from either plant or animal products or recombinant proteins generated by genetic engineering.
- (v) In order for a drug to be effective it has to be administered by an appropriate route (i.e. oral, intravenous or intramuscular etc) capable of achieving a sufficiently high enough concentration within its target tissue(s) in a chemical form that allows it to interact with its biological target to achieve its desired effect.
- (vi) The factors that determine the ability of a drug to reach its target tissue and achieve its desired therapeutic effect are determined by its inherent Pharmacokinetic and Pharmacodynamic properties.
- (vii) While drugs are intended to have a selective beneficial action, there is always the risk that a drug may have unanticipated, undesirable, and in some cases, harmful, side effects.
- (viii) The effective use of drugs in the clinical practice of medicine requires a thorough understanding of both the basic concepts of pharmacology and the specific pharmacology of any specific prescribed drug.

II. Pharmacology and Therapeutics: Course Goals and Objectives

Overview.

The central goal of the Pharmacology and Therapeutics course is two-fold. First, to provide students with a solid grounding in the basic concepts and scientific underpinnings of Pharmacology. Second, to provide students with a comprehensive introduction to the fundamental Pharmacology and uses of the major classes of clinically important drugs currently used in medical practice.

Specific key concepts and learning objectives will be provided for each individual lecture topic. However, the general course goals are as follows:

(A) To learn basic scientific concepts and principles that will serve as the foundation for understanding the pharmacology of specific drugs.

Specifically:

- To understand the fundamental scientific principles of drug action and the various mechanisms by which drugs can mediate their pharmacological effect
- To understand the fundamental principles of pharmacokinetics that underly the absorption, distribution, metabolism and elimination of drugs in the body and thereby affect drug effectiveness
- To understand the biochemical reactions that result in the metabolism of drugs within the body
- To understand the rationale behind designing different dosing regimens of particular drugs in specific patient populations
- To understand how specific patient characteristics and genetics can affect the clinical response to a particular class of drugs
- To understand the scientific basis underlying how two different drugs can interact within the body and can have undesirable effects either on drug concentrations or drug clinical effects
- To understand the process by which new drugs are discovered and approved for use in the clinic
- To understand the basic principles of toxicology; the mechanisms by which excess exposure of certain drugs, toxins, chemicals, heavy metals and poisons can lead to adverse toxicological effects; and the basic principles of clinically managing the poisoned patient.

(B) To understand the Pharmacology and clinical use of the major class of clinically important drugs.

These include drugs affecting the autonomic nervous system; anesthetics and analgesics; drugs to treat the heart and diseases of the cardiovascular system; drugs affecting the pulmonary system; antibiotics; drugs used to treat psychiatric disorders; drugs of abuse and drugs use to treat addiction; drugs that affect the immune system; drugs that affect the endocrine system; dietary supplements and herbal medications; antiviral drugs and chemotherapeutic drugs used in the treatment of cancer

For each drug/drug class you should know the following:

- | | |
|------------------------|--|
| a) INDICATIONS | - under what circumstances is the drug used. |
| b) DRUG ACTION | - what clinical effect does the drug have. |
| c) MECHANISM OF ACTION | - what is the scientific basis for how the drug works. |
| d) ADVERSE EFFECTS | - are there clinically relevant side effects of the drug that may adversely affect the health of the patient |
| e) CONTRAINDICATIONS | - are there circumstances in which the drug should not be administered to certain patient populations due to significantly increased risk of adverse effects e.g. the elderly, those with renal insufficiency, pregnant women etc. |
| f) PHARMACOKINETICS | - are there any factors such as absorption, distribution, metabolism or elimination that might affect the clinical effectiveness of the drug in a given patient population e.g. renal excretion of a drug with a narrow therapeutic window in patients suffering from renal insufficiency. |
| g) DRUG INTERACTIONS | - are there any possible interactions with other concomitantly administered drugs that might affect the clinical efficacy, bioavailability or toxicity of either drug. |

II. ORGANIZATION OF THE COURSE.

A. Syllabus

The Pharmacology & Therapeutics course is year-long and is divided into two semesters.

Semester III (Part 1); August 6th – December 16th, 2013

Semester IV (Part 2); January 6th – April 29th, 2014

You will receive an **individual** grade for **each** semester.

Semester III:

There are five major areas of emphasis in Semester III:

(i) Basic Principles –in this series of lectures you will be introduced to the fundamental concepts of Pharmacology including pharmacokinetics, pharmacodynamics, pharmacogenomics, drug metabolism, and drug interactions.

(ii) Autonomic Pharmacology/Anesthesia/Pain medications- this section of the course will introduce you to the pharmacology of the autonomic nervous system. You will also be introduced to the pharmacology of anesthetics and analgesics.

(iii) Antimicrobial agents –this section of the semester will provide an introduction to the pharmacology and clinical use of antibiotic drugs used in the treatment of infectious diseases.

(iv) Cardiovascular Pharmacology – in this series of lectures you will be introduced to the major drug classes that are used to treat diseases of the cardiovascular system. These drug classes include those involved in the regulation of blood coagulation, as well as drugs used to control hyperlipidemia, hypertension, angina, cardiac arrhythmias and congestive heart failure.

(v) Miscellaneous Pharmacology Topics- this final section will deal with a number of topics including, pharmacotherapy of anemia, immunomodulation therapy, treatment of allergies and pharmacotherapy of mycobacterial and fungal infections

There will be a total of **FIVE** exams in Semester III on the following dates:

August 19th; September 3rd; September 20th; October 28th; December 16th.

Note: The Pharm course will not have questions on the MHD exam scheduled for November 18th

Semester IV

There are four major areas of emphasis in Semester IV:

(i) Psychopharmacology – the first series of lectures in the semester will provide an introduction to the pharmacology of drugs used in the treatment of common psychiatric illnesses, including the antidepressants, mood stabilizers, anxiolytics, and anti-psychotics. There will also be lectures on sedative hypnotic drugs and drugs used to treat drug abuse.

(ii) The endocrine system – this section of the course will discuss the pharmacology of drugs used to treat disorders of the endocrine system. Topics included are hypothalamic and pituitary hormones; estrogens, progesterones and androgens; Adrenocorticosteroids; drugs used to treat thyroid disorders; drugs to treat osteoporosis, and drugs to treat diabetes.

(iii) Chemotherapy – the final section of the semester will focus on the pharmacology of drugs used in chemotherapy and the treatment of cancer. Other topics will include drugs to treat HIV and other viral infections, the principles of clinical toxicology, and the pharmacology of common botanical medications and alternative medicine supplements.

(iv) Other topics- Other lecture topics that will be introduced throughout the semester include drugs to treat Parkinsonism and dementia, drugs to treat parasitic infections; drugs to treat Rheumatoid Arthritis; drugs used in the management of GI disorders; and Herbal Medications and Drug Supplements.

There will be **FOUR** exams in Semester IV on the following dates:

February 1st; March 7th; April 7th; April 29th.

B. Integration with other courses

The Pharmacology and Therapeutics course will run concurrently with Mechanisms of Human Disease. You will find that the lecture topics in these have been integrated so that related topics are coordinated and will be taught in a contemporaneous fashion. This will ensure that you will first hear about the underlying scientific basis of a disease process, its associated pathologies, and symptoms, prior to being introduced to the Pharmacology of the drugs used to treat that specific disease process. The topic areas are further integrated in small group sessions within both the Mechanisms and Pharmacology courses that aim to dovetail knowledge gained from both courses into addressing specific clinical scenarios. It is hoped that by integrating the course material in this way, it

will aid the overall educational experience and will greatly facilitate the learning process.

C. Lectures

All Pharmacology lectures will be 50 min in duration and will be presented in SSOM Rm. 390. A PDF printout of the powerpoint presentation of each lecture will be made available for download shortly before each lecture. As always, appropriate and professional behavior in the lecture hall is expected. Distracting classmates and/or faculty with conversation is unprofessional and is not acceptable.

D. Learning objectives and Handouts

A handout that can be used as a study guide for each lecture topic will accompany each lecture and will be posted on the web, where it can be accessed through the calendar for each specific date.

These handouts will include:

- a) A list of suggested reading assignments.
- b) A list of key concepts and learning objectives for each lecture topic.
- c) A list of the important drugs that will be covered during the lecture.
- d) A detailed overview of the material that will be covered in the lecture.
- e) Charts illustrating key Pharmacological features of each drug covered in the lecture, and/or a brief review of key points made in the lecture.

E. Small Group Case Studies

In addition to lectures the course also includes a variety of small group case studies. These small group case analyses will typically last 90 min and will take place in assigned locations within the sit-down-labs of SSOM. They will use various clinical case vignettes to illustrate important pharmacological concepts and will attempt to facilitate learning of critical pharmacological information covered in the related lectures. In the first semester the small group cases will be focused on basic pharmacological concepts such as pharmacokinetics, pharmacodynamics drug dosing, drug metabolism, and drug interactions. In the second semester there will be four small group cases that will each focus on the pathophysiology and drug management of an individual psychiatric condition (e.g. bipolar disorder, schizophrenia, depression and drug abuse). The case vignettes and associated study questions will be made available online. During the small group session, the facilitators will not only solicit your input regarding a given case based on the study questions, but will also pose additional

questions that stem directly from the discussion. Individual small group assignments, room numbers, and the names of the group facilitators will be posted, both on the web and outside Rm. 320. Note that in many cases, Pharmacological topics and the use of drugs in the treatment of specific diseases will be discussed in small group cases delivered within the Mechanisms of Human Disease course.

In addition to the small group cases there will also be two pharmacology demonstrations that will use clinical simulators and standardized patients to illustrate important aspects in the use of autonomic and cardiovascular drugs. These demonstrations will take place at the assigned times in SSOM Rm. 390. You will be expected to have reviewed the cases prior to the class and to come to these sessions ready to fully participate in the discussions.

In line with current school policy attendance at Small Groups is Mandatory- there will be sign up sheets for each separate small group session. Failure to attend and participate in small groups will result in an evaluation of NOT MEETING EXPECTATIONS in your Professional competency component of the course. If, for whatever reason you find that you have a legitimate reason for being unable to attend a particular small group session you should seek advance permission from the Course Director.

F. Tips on learning/understanding the Pharmacology of specific drugs

As indicated above, the first section of semester III will introduce you to the basic scientific principles of Pharmacology. By its very nature this section of the course is very conceptual and deals with very basic fundamental aspects of Pharmacology. However, the remainder of the course will quickly become very specific and is organized in a stepwise fashion to introduce you to the different classes of currently available drugs that are used to treat specific diseases and clinical conditions. This will expose you to a very large amount of information. In order to facilitate your learning and understanding of this material it is helpful to consider the following specific pieces of information for each drug or class of drugs that is covered.

For each drug/drug class you should know the following:

- a) **INDICATIONS***** - under what circumstances is the drug used.
- b) **DRUG ACTION***** - what clinical effect does the drug have.

- c) **MECHANISM OF ACTION***** - how does the drug work at the biochemical level.
- d) **ADVERSE EFFECTS***** - are there clinically relevant side effects of the drug.
- e) **CONTRAINDICATIONS***** - are there circumstances in which the drug should not be administered to certain patient populations e.g. the elderly, those with renal insufficiency, pregnant women etc.
- f) **PHARMACOKINETICS** - are there any factors such as absorption, metabolism, excretion or half-life that might affect the drug action.
- g) **DRUG INTERACTIONS** - are there any interactions with other potentially concomitantly administered drugs that might affect the clinical efficacy, bioavailability or toxicity of either drug.

***- indicates most relevant HIGH YIELD information that is essential to master in order to perform well on the USMLE Step 1 exam.

This information will be discussed for each drug and/or drug class discussed throughout the course. In many cases, the information will be summarized in the charts that will accompany your lecture handouts. By learning this information for each drug/drug class, you will gain a greater appreciation for both the uses and limitations of these drugs in the effective treatment of specific patient populations. Knowing, understanding and being able to apply this information will also be critical for performing well in examinations both in the Pharmacology course and in the USLME-step 1 exam.

IV. EXAM FORMAT & GRADING POLICY.

- A. There will be a total of **NINE** exams throughout the year that contain Pharmacology and Therapeutics questions. All exams will be computerized and will be administered in the Sit-Down Labs.
- B. The dates of the exams are:

Semester III- **August 19th; September 3rd; September 20th; October 28th; December 16th.**

Note: The Pharm course will not have questions on the MHD exam scheduled for November 18th

Semester IV- **February 1st; March 7th; April 7th; April 29th.**

- C. The total number of questions containing Pharmacology material will vary from exam to exam and will depend on the total number of Pharmacology lectures given during that period of the course.
- D. The exams are **NOT** cumulative. Each exam will consist of **three questions per lecture and one question per small group session that were delivered during the corresponding section of the course.** All questions will all be multi choice format in the style of the United States Medical Licensing Exam (USMLE-Step 1). Total time allowed for each exam will vary depending on the number of exam question- the average time allotted to answer each question will be 1 min 20 sec.
- E. Your **final** semester grade will be based on the **total percent correct** of your answers from all of the questions answered in each exam throughout the entire semester.

The final grade for each semester will be compiled as follows:

Honors: a score greater than **92%**.

High Pass: a score greater than **85%** and less than **92%**.

Pass: a score greater than **70%** and less than **85%**.

Fail: a score less than **70%**.

Note: Scores within 0.5 percentage points of a grade cut off will be rounded up to the higher grade

- G. In order to pass the entire course you will need to score **AT LEAST** a **PASS** or better in **BOTH** Semester III **AND** Semester IV.

V. PREPARATION FOR EXAMINATIONS.

- A. As part of the handouts for each lecture you should also receive a chart(s) illustrating the major features of the drugs discussed during that lecture (i.e. indications, mechanism of action, adverse effects, contraindications, drug interactions). Alternatively, some lectures may supply you with a list of key review points for the lecture. In either case, these materials should be invaluable resources in your preparations for each exam.

- A.B. USMLE type questions with explanations can be found at the end of each chapter in Katzung and Trevor's *Examination and Board Review (9th Edition)*.
- C. An online student Resource Center accompanies the 12th edition of Katzung "Basic & Clinical Pharmacology". This includes chapter questions and answers with detailed rationales.
- D. The following represent Pharmacology-related exam questions that are available online:
URL <http://www.pharmacology2000.com/learning2.htm>
URL http://www.medtrng.com/pharmacology_quizzes.htm

Formatted: Bullets and Numbering

VI. MISSED EXAM POLICY.

If circumstances arise that may prevent you from taking a scheduled examination (e.g. serious illness) you should immediately contact **BOTH** the course directors **AND** the Associate Dean of Student Affairs, so that a timely adjudication can be made. Students who are forced to miss exams for **legitimate** reasons, as ascertained by the Associate Dean of Student Affairs, will be given the opportunity to take a make-up exam on an individual basis.

VII. REMEDIATION POLICY

Students who receive a failing grade for either Semester III or Semester IV will be required to take a **Remediation exam**. The course director will notify those students that failed a semester after the last exam of that semester. Remediation Exams are administered with the assistance of the Associate Dean of Student Affairs in **May/June at the end of the entire course**. The purpose of the remediation exam is for the student to demonstrate competence of the material presented in the course. The composition of the exam will be decided by the course director and will consist of representative questions reflecting material that was presented throughout the semester. **Students must earn at least a 70% score to pass the remediation exam**. The course director will notify the student of the remediation exam grade.

VIII. PROFESSIONALISM.

Personal responsibility and professionalism are two key areas in the development of a physician. Professionalism is actually a separate category on the required evaluations for the American College of Graduate Medical Education. It is expected that professionalism will be extended in all aspects of your conduct in this course. This includes appropriate and professional interactions with the

course directors, lecturers, educational specialists and other students. Any serious lack in professional conduct will be reported to the Dean.

It is further expected that all students will maintain personal integrity and honesty during the examination process. Once an exam has started there should be no verbal or non-verbal communication with other students. If a problem arises this should be brought to the attention of the examination proctor. Lecture handouts, textbooks, telephones, personal computer devices and any written material should not be taken into the exam room. Neither should these materials be accessed during authorized bathroom breaks. Any student that attempts to gain an unfair advantage over other students in an examination by attempting to gain access to pharmacology resource material by any of these unauthorized means will be guilty of academic misconduct and will be promptly reported to the Dean.

IX. TEXTBOOKS

Recommended: EITHER

Katzung, B. G., Masters, S.B. and Trevor, A.J. Basic and Clinical Pharmacology 12th Edition. McGraw Hill: Norwalk, CT. 2011.

- Available in the Inkling Format for iPad
- Also available through Access Medicine

This is a textbook that is used by many Pharmacology courses at other Medical Schools around the country- it is the companion textbook to the Board Review book listed below. It offers an in-depth detailed discussion of each topic and can be used as a primary resource textbook. It contains excellent summary charts of points at the end of each chapter.

OR

Katzung, B.G. and Trevor, A.J. Pharmacology: Examination and Board Review 9th Edition. McGraw Hill: Norwalk, CT., 2010.

This Board Review book has previously been recommended by past students of the course. It offers a user-friendly brief synopsis of most pharmacological topics with plenty of diagrams, figures and tables. It also includes a list of practice exam questions complete with annotated answers at the end of each section. However, you should be aware that this book provides only a brief review of each topic, not a comprehensive in-depth coverage.

X. ADDITIONAL TEXTBOOKS AND E-RESOURCES

A. Textbooks.

1. Goodman & Gilman's The Pharmacological Basis of Therapeutics 12th Edition. McGraw Hill: NY 2010.

This voluminous textbook provides a very comprehensive and in depth discussion of all areas of modern clinical pharmacology. It is considered as the "gold standard" of Pharmacology textbooks. However, it would probably be overkill for the course for all but the most interested students.

- available in the InKling format for iPad
- also available through Access Medicine

2. Goodman & Gilman's Manual of Pharmacology and Therapeutics 1st Edition. McGraw Hill Professional NY 2007.

Note: The 2nd Edition will be released December 2013

This is a condensed readily portable paperback version of the main Goodman & Gilman Reference textbook highlighted above. Highly recommended for those students that want a comprehensive user-friendly Pharmacology resource that can easily be carried in either a pocket or backpack.

3. Howland & Mycek. Lippincott's Illustrated Reviews, Pharmacology 5th Edition., Lippincott Williams &Wilkins, 2011.

A "user friendly" textbook that provides a basic outline of each topic. Provides just about the right amount of detail for easy review of any given topic. Includes many excellent tables, charts and illustrations for easy review of the material.

B. Review Books

4. Pazdernik & Kerecsen Rapid Review: Pharmacology, 3rd Edition Elsevier, 2010.

An excellent review book that provides essential facts and information for each of the major drug classes in a succinct user-friendly format- includes many excellent charts and figures. Highly recommended as a board review study aid to complement the lecture handouts provided in the course.

Formatted: Bullets and Numbering

Formatted: Bullets and Numbering

Formatted: Bullets and Numbering

5. Gleason, DejaReview Pharmacology, 2nd Edition, McGraw Hill, 2010.
An excellent resource for exam preparation. Essentially Pharm flash cards in a book format. Provides numerous active recall questions on each of the key topics that allows the student to gauge their study progress.

C. E-Resources

1. **ACPMedicine (Scientific American Medicine)**

~~2.~~ *This Online Textbook is available through the library e-books collection. It contains a series of excellent up-to-date chapters on a variety of disease process, detailing the underlying biology and pathology of each disease. Most importantly, each chapter ends with a discussion of the available therapeutic approaches to treat each disease, as well as a succinct review of the most important pharmacological aspects of each of the highlighted medications.*

Formatted: Bullets and Numbering

4-2. **Up-to-Date**

URL <http://www.utdol.com/application/search.asp>

This website is available through computers on campus and can be accessed via the library web site (under quick links). It provides access to an extensive searchable and clickable database of excellent articles and monographs on specific disease conditions and the medications used to treat them. Provides excellent discussion on all aspects of specific medications including indications, mechanism of action, side effects and drug interactions. An excellent resource of current up-to-date pharmacological information that is widely used on the clinical floors.

Formatted: Bullets and Numbering

3. **Medical Pharmacology- Online Pharmacology content & Practice questions**

URL <http://www.pharmacology2000.com/learning2.htm>

This is a privately run web site that provides concise review notes on a comprehensive list of Pharmacological topics and specific medications. In addition, it offers the chance to take a number of different online practice exams for each topic. Although I cannot attest to the complete accuracy of the material, it seems that this site would be a good resource for exam preparation.

4. **The Knowledge Objectives in Medical Pharmacology.**

URL

http://www.aspet.org/AMSPC/Knowledge_Objectives/default.asp

This is the official list of important medications that every US medical student should be familiar with as defined by the Association for Medical School Pharmacology.

X. KEY CONTACTS

COURSE DIRECTOR

Name: Neil A. Clipstone, Ph.D.
Associate Professor of Pharmacology
Location: SSOM Rm 320
Phone/Contacts: Office- x66195
Email – nclipstone@lumc.edu

ASSISTANT COURSE DIRECTOR

Name: Debra Hoppensteadt, Ph.D.
Associate Professor of Pathology and Pharmacology
Location: Bldg 102, Room 2643
Phone/Contacts: Office – x64625
Email – dhoppen@lumc.edu

EDUCATION SPECIALIST

Name: Jackie Greer
Location: Bldg 120, Room 320
Phone/Contacts: Direct – x68083
Email – jgreer@lumc.edu

REMEMBER TO CHECK YOUR E-MAIL ON A REGULAR BASIS. UPDATES AND CHANGES WILL BE ONLY POSTED THROUGH E-MAIL. ALSO CHECK THE WEEKLY COURSE SCHEDULE FOR ANY CHANGES.

PHARMACOLOGY & THERAPEUTICS FACULTY

SEMESTER III & IV 2013-2014

Instructor	Department Address	Phone	E-mail address
Asconape, Jorge M.D.	Neurology,		jasconape@lumc.edu
Bakowska, Joanna Ph.D.	Pharmacology, Bld 102 Rm 3636	6-8427	jbakowska@lumc.edu
Battaglia, George Ph. D.	Pharmacology, Bld. 102, Rm. 3631	6-5680	gbattag@lumc.edu
Byram, Scott M.D.			sbyram@lumc.edu
Byron, Ken, Ph. D.	Pharmacology, Bld. 102, Rm. 2720	7-2819	kbyron@lumc.edu
Clipstone, Neil, Ph. D.	SSOM Rm 320	6-6195	nclipstone@lumc.edu
Cuevas, Bruce Ph.D.	Pharmacology, Bld. 102, Rm. 3657	6-6408	bcuevas@lumc.edu
Fareed, Jawed, Ph. D.	Pathology, Bld. 102, Rm. 2652	6-5581	jfareed@lumc.edu
Gallagher, Thomas, Ph.D.	Microbiology, Bld. 105, Rm. 3812	6-4850	tgallag@lumc.edu
Hoppensteadt, Debra, Ph.D.	Pathology, Bld. 102, Rm 2643	6-4625	dhoppen@lumc.edu
Gentile, Saverio, Ph.D.	Pharmacology, Bld 102	6-3263	sagentile@lumc.edu
Hecht, David M.D.			dhecht@lumc.edu
Johnson, Stuart, M.D.	Inf. Disease, Bld. 54, Rm. 149	6-3232	sjohnson@lumc.edu
Kennedy, Richard, Ph. D.	Research Svcs., Bld. 120, Rm. 411	6-8434	rkennedy@lumc.edu
Kini, Ameet, M.D.	Pathology, Bld. 110, Rm. 2220	7-2611	akini@lumc.edu
Kristopaitis, Theresa, M.D.	Medicine, Bld. 54, Rm. 109	6-8757	tkristo@lumc.edu
Marchese, Adriano, Ph. D.	Pharmacology, Bld. 102, Rm. 2720	6-3456	amarchese@lumc.edu
Majetschak, Matthias, M.D., Ph.D.	BSTI, EMS 110	7-2472	mmajetschak@lumc.edu
Micetich, Kenneth, M.D.	Hematology/Oncology, Bld. 112, Rm. 246	7-3144	kmiceti@lumc.edu
Michelfelder, Aaron			amichel@lumc.edu
O'Keefe, Paul M.D.			pokeefe@lumc.edu
Pachucki, Constance, M.D.	Infectious Disease Hines	(7) 241-6635	constance.pachucki@med.va.gov
Patel, Tarun, Ph. D.	Pharmacology, Bld. 102, Rm. 3621	6-3261	tpatel7@lumc.edu
Quinn, Andrea, Pharm. D.	Hickory Hills Primary Care Center	(7) 233-6897	aquinn@lumc.edu
Rana, Ajay Ph.D.	Pharmacology, Bld, 101 Rm 2700	6-5761	arana@lumc.edu
Rana, Basabai Ph.D.	Gastroenterology, Bld 102 Rm 6631	6-8476	brana@lumc.edu
Robinson, John, M.D.	Rheumatology, Bld. 54, Rm. 113	6-5139	jrobins@lumc.edu
Samarel, Allen, M.D.	Cardiovasc. Research Bld. 110, Rm. 5222	7-2821	asamare@lumc.edu
Schilling, David, M.D.	Psychiatry, Bld. 105, Rm. 1940	6-5073	dschil1@lumc.edu
Scrogin, Karie, Ph. D.	Pharmacology, Bld. 102, Rm. 2723A	6-5652	kscrogi@lumc.edu

Jackie Greer
Education Specialist
Bld. 120, Rm
68083
jgreer@lumc.edu

PRINCIPLES OF PHARMACOLOGY: AN OVERVIEW

Date: August 6, 2013 – 8:30 am

KEY CONCEPTS AND LEARNING OBJECTIVES

1. To know the major drug classes for the treatment of various diseases.
2. To know the different formulations of drugs.
3. To describe the various routes of administration of a drug to the patient.
4. To list the various factors that affect drug absorption, drug distribution and drug excretion in a patient.
5. To know that drugs are derived from various sources and exhibit molecular and functional diversity.
6. To define receptors and their role in the mediation of drug response.
7. To differentiate between an agonist and antagonist.
8. To become aware of the generic versions versus the branded product.
9. To understand the differences in the chemical equivalence, biological equivalence and therapeutic equivalence of a drug product as related to generic drug substitution.
10. To define bioavailability of a drug.
11. To have an understanding of the drug approval process.
12. To understand the toxic effects of drugs.

PRINCIPLES OF PHARMACOLOGY: An Overview

A. WHAT IS PHARMACOLOGY?

Pharmacology represents an integrated body of knowledge that deals with the actions of chemical and biologicals on cellular functions.

1. Medical Pharmacology is the area of pharmacology that covers the use of drugs in the prevention (prophylaxis) and treatment of diseases.
2. Toxicology is the area of pharmacology concerned with the undesirable effects of chemicals and biologicals on cellular functions.
3. Pharmacokinetics describes the effects of the body on drugs (absorption, distribution, excretion) and pharmacodynamics describes the action of drugs on the body such as the mechanism of action and therapeutic and toxic effects.
4. Pharmacology is the most integrated multidisciplinary science. It requires knowledge of all of the basic and clinical sciences to understand the mechanism of action of drugs.

B. MAJOR DRUG CLASSES FOR THE TREATMENT OF VARIOUS DISEASES

1. Autonomic drugs- These drugs target the autonomic system which is the major involuntary, unconscious autonomic portion of the nervous system.
 - a. Cholinceptor-activating and cholinesterase-inhibiting drugs
 - b. Cholinceptor blockers and cholinesterase regenerators
 - c. Sympathomimetics
 - d. Adrenoreceptor blockers
2. Cardiovascular drugs
 - a. Antihypertensive agents
 - b. Drugs used in the treatment of acute coronary syndrome
 - c. Drugs used in the treatment of heart failure
 - d. Anti-arrhythmic drugs
 - e. Diuretic agents
3. Drugs effecting smooth muscle cells
 - a. Histamine, serotonin and ergot alkaloids
 - b. Vasoactive peptides
 - c. Prostaglandins and their modulators
 - d. Nitric oxide donors and inhibitors

- e. Bronchodilators

- 4. Drugs that act on the central nervous system
 - a. Sedative/hypnotic drugs
 - b. Alcohols
 - c. Anti-seizure drugs
 - d. General and local anesthetics
 - e. Skeletal muscle relaxants
 - f. Anti-parkinsonian drugs
 - g. Anti-psychotic drugs
 - h. Anti-depressant drugs
 - i. Opioids analgesics and antagonists
 - j. Drugs of abuse

- 5. Drugs with actions on blood, inflammation and gout
 - a. Anti-anemia drugs and hematopoietic growth factors
 - b. Drugs used in the management of thrombosis
 - c. Anti-hyperlipidemic agents
 - d. Non-steroidal anti-inflammatory agents

- 6. Endocrine drugs
 - a. Hypothalamic and pituitary hormones
 - b. Thyroid and anti-thyroid drugs
 - c. Corticosteroids and antagonists
 - d. Gonadal hormones and inhibitors
 - e. Pancreatic hormones, anti-diabetics and hypoglycemic drugs
 - f. Drugs that affect bone mineral homeostasis

- 7. Chemotherapeutic agents

- a. Antibiotics
 - b. Anti-fungal agents
 - c. Anti-viral chemotherapy
 - d. Anti-protozoal drugs
 - e. Anti-helmentic drugs
 - f. Cancer chemotherapy
 - g. Immuno-modulators
8. Drugs used in the treatment of gastrointestinal disorders
 9. Vaccines, complex biologic drugs and immune globulins
 10. Stem cell therapy

C. **THE NATURE OF DRUGS**

1. Inorganic ions
2. Non-peptide organic molecular and organomimetics
3. Small peptides and peptidomimetics
4. Natural and recombinant proteins
5. Nucleic acids and their analogues
6. Lipids and lipid derived agents
7. Carbohydrates and their derivatives

The molecular weight of drugs varies from 7 daltons (Li^+) to > 100,000 daltons (antibodies, vaccines, enzymes)

D. **ORIGIN AND SOURCE OF DRUGS**

1. Microbes
2. Plants
3. Animals
4. Inorganic elements and compounds
5. Synthetic organic compounds

6. Synthetic organomimetics
7. Biotechnology derived products
8. Biologics and products of human origin/recombinant equivalents

E. **DRUG FORMULATIONS**

1. Liquid
2. Tablets-
3. Suppositories
4. Sprays and inhalants
5. Ointments
6. Transdermal patches
7. Drug coating on medical devices (stents, catheters, extracorporeal circuits)
8. Drug implants
9. Micro and nanoparticles
10. Targeted drug delivery

F. **MOVEMENT (TRANSPORTATION) OF DRUGS IN THE BODY**

1. Permeation
 - a. Aqueous diffusion
 - b. Lipid diffusion
 - c. Transport by special carriers
 - d. Endocytosis
2. Fick's law of diffusion
Predicts the rate of movement of molecules across a barrier; the concentration gradient ($C_1 - C_2$) and permeability coefficient for the drug and the thickness of the barrier.

$$\text{Rate} = (C_1 - C_2) \times \frac{\text{Permeability coefficient}}{\text{Thickness}} \times \text{Area}$$

G. **AQUEOUS AND LIPID SOLUTION OF DRUGS**

1. Aqueous diffusion

2. Lipid diffusion
The pH of the medium determines the fraction of drugs charged (ionized) versus uncharged (non-ionized). If the pK_a of the drug and pH of the medium are known, the ionized drug can be predicted by means of Henderson-Hasselbalch equation.
3. Ionization of weak acids and bases
 $\text{RNH}_3^+ \leftrightarrow \text{RNH}_2 + \text{H}^+$
 $\text{RCOOH}^+ \leftrightarrow \text{RCOO}^- + \text{H}^+$

H. ABSORPTION OF DRUGS

1. Route of absorption
 - a. Intravenous
 - b. Intramuscular
 - c. Subcutaneous
 - d. Buccal and sublingual
 - e. Rectal
 - f. Inhalation
 - g. Transdermal
 - h. Other
2. Blood flow
3. Concentration

I. DISTRIBUTION OF DRUGS

1. Determinants of distribution
 - a. Size of the target site (organ)
 - b. Blood flow
 - c. Solubility
 - d. Binding
2. Apparent volume of distribution and physical volume

J. METABOLISM OF DRUGS

1. Drug metabolism as a mechanism of termination of drug action
2. Drug metabolism as a mechanism of drug activation
3. Drug elimination without metabolism

K. ELIMINATION OF DRUGS

1. First order elimination

First order elimination implies that the rate of elimination is proportional to the concentration. The higher the concentration of drug the greater amount drug is eliminated per unit time.

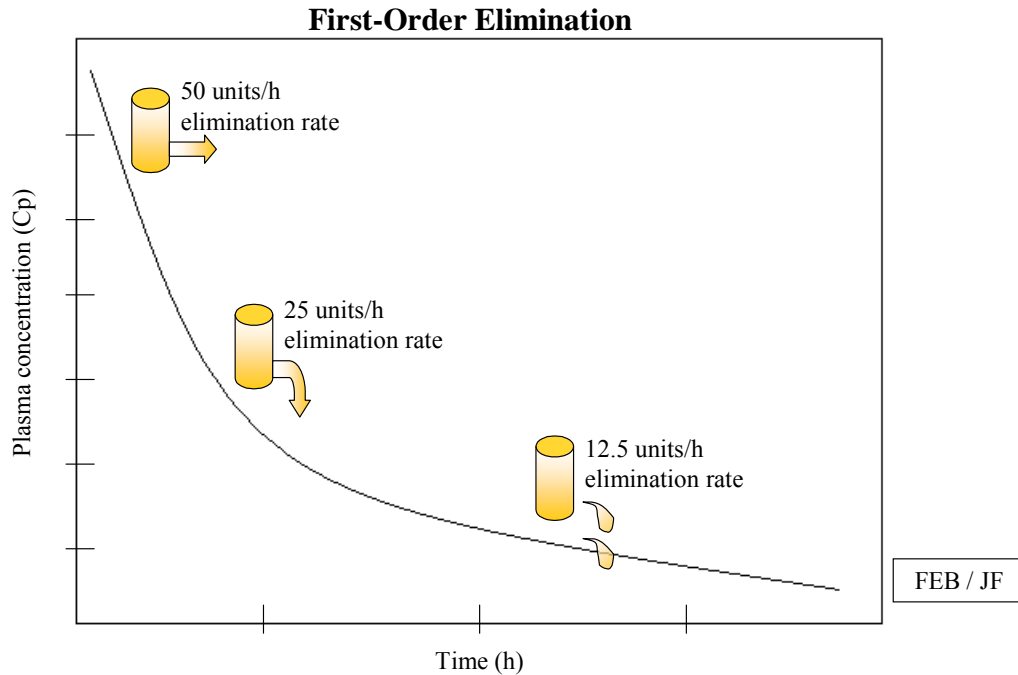

Figure 1. First-order kinetics of drug elimination. The rate of elimination is proportional to the circulating levels of the drug. (more common)

2. Zero order elimination

Zero order elimination implies that the rate of elimination is constant regardless of the concentration.

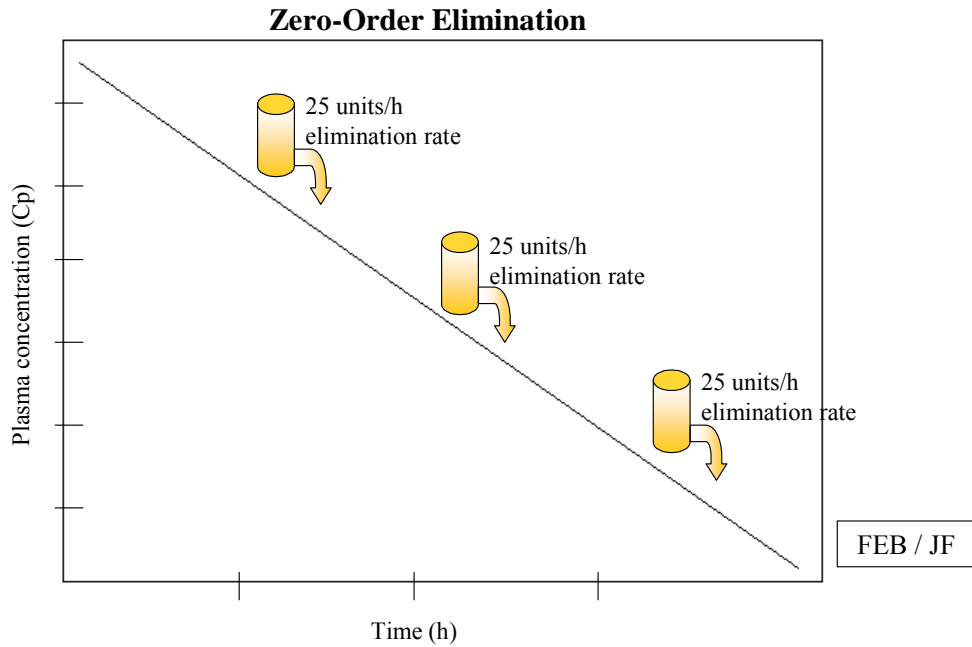
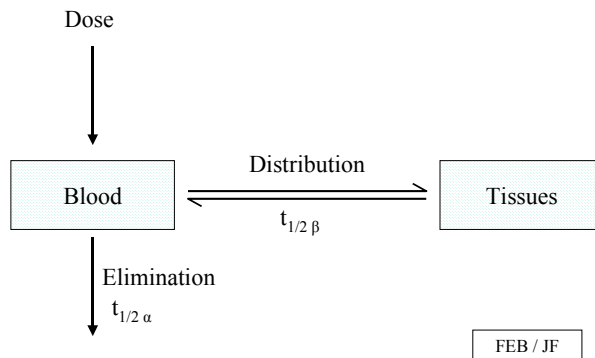

Figure 2. Zero-order kinetics of drug elimination. The rate of elimination is constant and independent of circulating levels of the drug. (less common)

L. **PHARMACOKINETIC MODELS**

1. Multicomponent distribution

Many drugs undergo an initial distribution phase followed by a slow elimination phase. Mathematically this process can be modeled by means of a two compartment model.



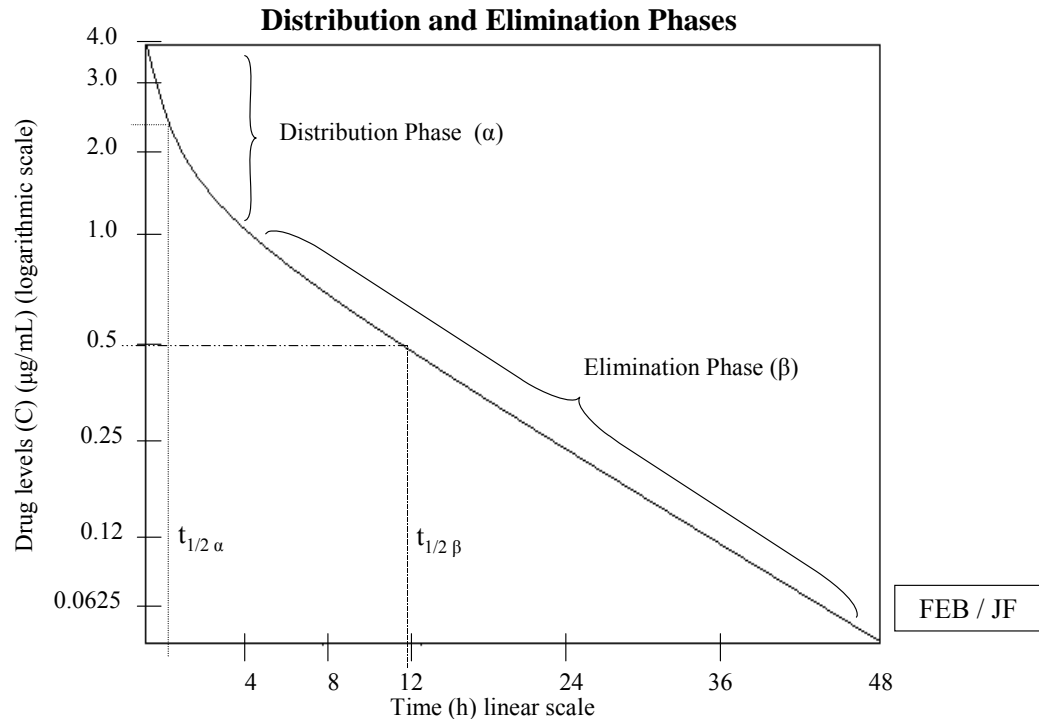

Figure 3. Circulating levels of a drug after an intravenous bolus. The initial curvilinear portion of the data represents the distribution phase (α), whereas the linear portion of the curve represents the elimination phase (β).

2. Single compartment distribution

A few drugs may behave as they are distributed to only one compartment (vascular compartment). Others have more complex distributions that require more than two compartments for construction of accurate models.

M. RECEPTORS FOR DRUGS

Drug effects result from their interactions with endogenous macromolecules in the patients that are called receptors. Upon interaction with the receptor, a drug can initiate biophysical and biochemical events leading to the observed drug effects. Drugs can bind to receptors with a variety of different bonds, which include covalent, electrostatic, and weaker bonds (hydrophobic, Van der Waals and hydrophilic).

1. Types of receptors

- a. Type I receptors: plasma membrane
- Acetylcholine and norepinephrine
- a. Type II receptors: cytoplasm
- Steroid hormones
- c. Type III receptors: nucleus
- Anticancer drugs

2. Agonists: is a drug capable of fully activating the effector system when it binds to the receptor.

3. Antagonists: structural similarity to agonist and interact with receptor but does not cause same molecular change in receptor, therefore inhibits interaction of agonist with receptor.
4. Chain of events following a drug – receptor interaction

Ach + receptor → Na⁺ influx → action potential → increased free Ca²⁺ → contraction

- Depends on particular receptor and particular type of cell.
5. Exceptions to drug actions mediated by specific receptors
 - a. Volatile anesthetics
 - b. Metal chelating agents
 - c. Osmotic diuretics
6. Regulation of receptors
 - a. Down-regulation (pharmacodynamic tolerance or desensitization): repeated administration of catecholamines decreasing number of alpha-receptors.
 - b. Up-regulation (pharmacodynamic sensitization): thyroid hormone increasing number of beta-receptors in myocardium.
7. Receptor Changes In Diseases
 - a. Antibodies to acetylcholine receptors in motor end-plates.
Clinical application: Myasthenia gravis.
 - b. Decreased number of receptors for plasma LDL (low density lipoproteins)
Clinical application: Familial hypercholesterolemia.

N. **DRUG ANTAGONISMS**

1. Competitive antagonism: reversible competition for agonist receptor binding sites without inducing a biological response, such as:
2. Non-Competitive antagonism: Irreversible binding with receptor preventing agonist binding to receptor, such as DFP which combines with acetylcholinesterase to prevent acetylcholine from binding to acetylcholinesterase.

O. **DRUG NOMENCLATURE**

1. Type of drug names
 - a. Chemical name: utilizes rules of organic chemistry.
 - b. Code name: assigned to drug by pharmaceutical manufacturer.
 - c. Generic name (nonproprietary name): if drug is admitted to United States Pharmacopoeia, the generic name becomes the official name of drug.
 - d. Tradename (proprietary name) (trademark) (registered name): a superscript R or TM follows trade name.
 - 1) If drug is marketed by more than one pharmaceutical company, then the same drug may have several trade names but only one official generic name.
2. Use of generic or tradename of a drug
 - a. Textbooks
 - b. Lectures, handouts and examinations in this course
 - c. National Board Examinations (USMLE)
 - d. Prescription of drugs

- 1) A pharmacist may substitute a generic drug for a trade name drug unless the physician indicates "no substitution" on the prescription.
 - 2) The physician can indicate the manufacturer for a generic drug.
 - 3) Clinical application: Advantage of generic drugs is saving the patient money. Disadvantage of generic drugs is patient may receive a preparation of drug that is of inferior quality to a trade name drug.
- e. Expressions of drug product equivalence related to generic drug substitution
- 1) Chemical equivalence: related to amount of drug per tablet.
 - 2) Biological equivalence: related to pharmacokinetics involving bioavailability.
 - 3) Therapeutic equivalence: related to clinical response that will provide same efficacy and toxicity (hopefully same lack of toxicity).
Clinical Application: very few generic drugs have been found to be therapeutically in equivalent to their trade name counterparts.

P. **DRUG-TESTING AND APPROVAL**

1. Pre-clinical testing and toxicology screen
2. Phase I: 10 normal volunteers receive small doses and observed for efficacy and safety
3. Phase II: Small group of patients with disease and observed for efficacy and safety
4. Phase III: large-scale clinical trial in patients with disease and observed for best dosage for treatment of disease.
5. NDA (New Drug application): If the FDA approves the NDA, then the drug goes on the market for general use.

REVIEW QUESTIONS

1. The property that characterizes the effect of a drug on the body is called
 - A. Distribution
 - B. Permeation
 - C. Pharmacokinetics
 - D. Pharmacodynamics
 - E. Elimination

2. The property that characterizes the effect of the body on the drug is called
 - A. Distribution
 - B. Permeation
 - C. Pharmacokinetics
 - D. Pharmacodynamics
 - E. Elimination

PHARMACOKINETICS I: ABSORPTION AND DISTRIBUTION

Learning Objectives

By the end of the lecture, you should:

1. Be able to define pharmacokinetics according to the acronym ADME.
2. Understand the mechanisms (aqueous & lipid diffusion, active transport, etc.) by which drugs are absorbed in the body to reach their sites of action.
3. Know chemical characteristics of drugs (e.g. solubility, pKa) and other factors (e.g. regional differences in blood flow, transporters, non-specific binding) that influence drug absorption.
4. Know common routes of drug administration, their uses and their limitations.
5. Understand what is meant by a one-compartment and a two-compartment model of drug distribution.
6. Be familiar with the concept of Volume of Distribution and the effect of plasma protein binding on drug distribution.
7. Understand how differential drug distribution can create drug reservoirs that affect the time course and magnitude of drug effect.

Drugs used as examples: digoxin, lidocaine, gentamicin, tobramycin, vancomycin, theophylline, warfarin, phenytoin, lidocaine, procainamide, penicillin G, aspirin, ethyl alcohol, propranolol

Recommended Reading:

The Merck Manual Online

Robert S. Porter, MD, Editor, Justin L. Kaplan, MD, Senior Assistant Editor

<http://www.merck.com/mmpe/sec20/ch303/ch303a.html>

Goodman & Gilman's Manual of Pharmacology and Therapeutics

Laurence Brunton, PhD, Keith Parker, MD, Editors

An Outline of Topics for Review

1. Definition of Pharmacokinetics
2. Significance of pharmacokinetic principles in therapeutics:
 - a. Design of rational therapeutic regimens.
 - b. The time-course of drug action.
 - c. Dose- (and/or plasma concentration-) related efficacy and toxicity. How to adjust dosage to achieve therapeutic efficacy and avoid toxicity.
 - d. Significance of the area under the plasma concentration vs. time curve.
3. Factors affecting drug absorption:
 - a. membrane permeability.
 - b. availability of transport processes (active or passive).
 - c. available surface area.
 - d. pH and concentration gradients.

4. Routes of administration:

- a. oral
 - b. sublingual/buccal
 - c. rectal
 - d. inhalation
 - e. topical
 - f. transdermal
 - g. subcutaneous
 - h. intramuscular
 - i. intravenous
 - j. intrasynovial
 - k. intrathecal
 - l. vaginal
 - m. urethral
 - n. ocular
 - o. nasal
 - p. aural
 - q. intra-peritoneal
 - r. epidural
- } enteral (administration through the digestive tract)
- } parenteral (given by routes other than the digestive tract, usually injected)

5. Factors affecting drug distribution:

- a. regional differences in blood flow
- b. tissue mass
- c. transport mechanisms
- d. permeability characteristics
- e. ion-trapping
- f. protein binding

6. One-compartment vs. Two-compartment distribution:

- a. One-compartment: a rapid equilibrium is achieved between plasma and tissue distribution following drug administration. Plasma concentration-time profile declines mono-exponentially.
- b. Two-compartment: rapid distribution to a central compartment is followed by slow distribution to other tissues/binding sites (second compartment). This results in a bi-exponential plasma concentration-time profile. With repetitive administration, steady-state concentrations are achieved only after 5-6 elimination half-lives ($t_{1/2}$). Digoxin, lidocaine, and phenytoin are examples of drugs that display two-compartment pharmacokinetics.

7. Volume of Distribution (V_d)

V_d describes how large a blood volume would be required to contain the entire administered dose at the measured concentration of drug in the blood.

8. Drug Reservoirs

Accumulation of drugs in tissues (e.g. fat & muscle) can prolong drug action.

DEFINITION OF PHARMACOKINETICS

Pharmacokinetics relates the time courses of a drug's absorption, distribution, and elimination (metabolism & excretion) to the intensity and time course of its pharmacological (therapeutic and/or toxic) effects.

CONSIDERATIONS FOR RATIONAL DESIGN OF A THERAPEUTIC REGIMEN:

- Dose
- Absorption
- First-pass Metabolism
- Area under the curve (AUC)
- Volume of Distribution and Elimination clearance
- Compliance

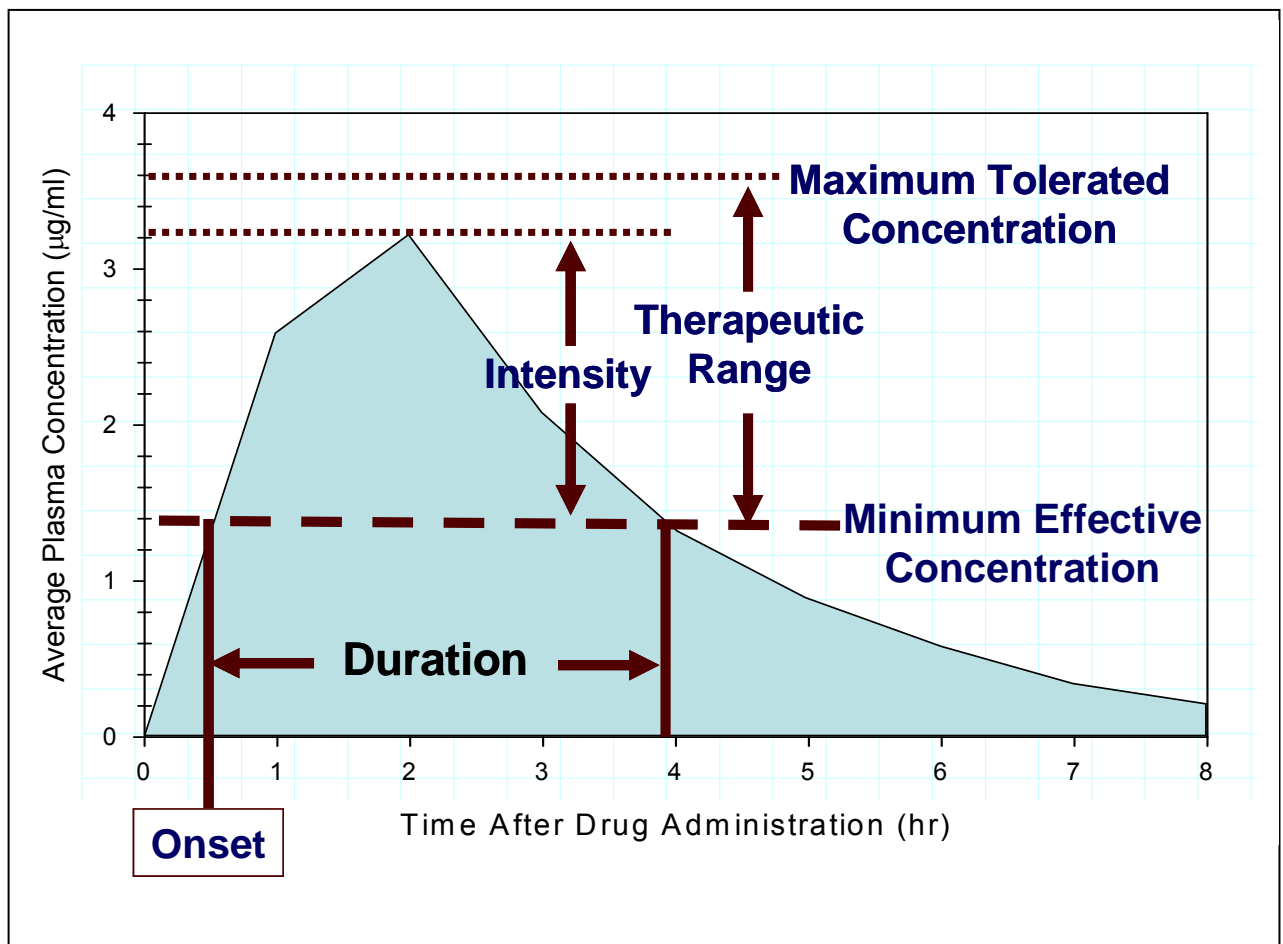

AREA UNDER THE CURVE (AUC)

Clinical Significance:

$$CL = \frac{\text{DOSE i.v.}}{\text{AUC}}$$

$$CL/F = \frac{\text{DOSE p.o.}}{\text{AUC}}$$

- Used to compare amount of drug that reaches the systemic circulation by different routes of administration: determine bioavailability (F).
- Used to compare clearance (CL) of a drug in different individuals after administration of the same dose via the same route.

DRUG ABSORPTION

Definition:

The processes by which drugs move from their site of administration to the plasma.

Processes following oral drug administration:

- disintegration of solids and dissolution of drug in fluids of gastrointestinal tract
- passage of drug across or between cells to reach the systemic circulation.

Factors affecting drug absorption:

- chemical composition of drug and delivery formulation (tablet, capsule, solvent, etc)
- regional differences in blood flow
- transport mechanisms
- permeability characteristics
- ion-trapping
- nonspecific binding

I. Passage of drugs across membranes

A. Aqueous diffusion

1. small molecules (<100 kD mol. weight)
2. passive process

B. Lipid diffusion

1. passive process
2. driven by concentration gradient:
the greater the difference across the membrane the more rapid the rate of crossing
3. lipid solubility is important
 - a. the more lipid soluble the faster the rate of transport
 - b. lipid solubility is affected by the degree of ionization
 - c. degree of ionization is dependent upon pH

i. can be determined at a given pH by using the Henderson-Hasselbalch equation

For Acids	For Bases
$pK_a = pH + \log \frac{[AH]}{[A^-]}$	$pK_a = pH + \log \frac{[BH^+]}{[B]}$

ii. this is not a linear relationship

iii. important to remember that the pH at which 50% of the compound is ionized is by definition the pK_a

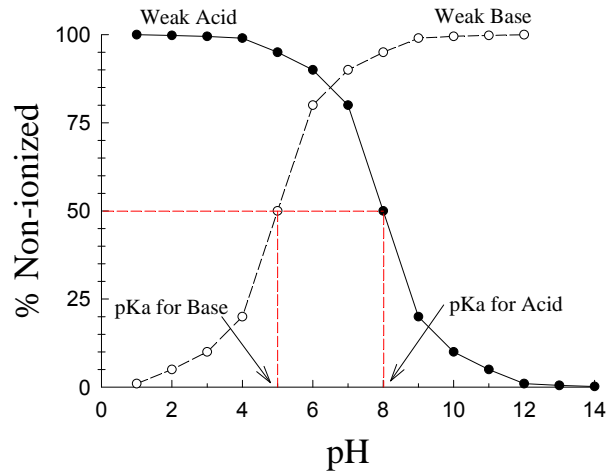

KLB

Ion trapping:

The concentration of the non-ionized form of a drug will tend to equilibrate across compartments because this form can permeate lipid membranes. However, the fraction of ionized drug described in the Henderson-Hasselbalch relationship will be established within each compartment based on the difference between compartmental pH and drug pK_a . Because the ionized form cannot readily permeate lipid membranes, the drug can become trapped, resulting in a greater concentration in compartments that favor its ionized form. Weak acids become more concentrated in more alkaline compartments; weak bases tend to concentrate in more acidic compartments.

4. surface area:

the greater the surface area the faster the rate of transport

C. Active transport

1. requires expenditure of cellular energy
2. unidirectional
3. structural specificity

D. Minor mechanisms

1. facilitated diffusion
2. pinocytosis

II. Different routes of drug administration

A. Enteral

1. Oral

- a. Physical form of drug can be of many types.
- b. Local differences in pH affect absorption.
- c. Differences in surface area can determine primary sites of absorption.
- d. The fraction (F) of the orally administered dose that reaches the systemic circulation in its active form is called its oral **bioavailability**.

A drug may have less than 100% bioavailability if it is incompletely absorbed or if it undergoes metabolism, e.g. while going through the liver via the portal circulation (first-pass metabolism).

Oral bioavailability may be estimated by comparing AUC for the orally administered drug with AUC for the same dose of drug given to the same patient intravenously.

$$F_{\text{oral}} = \frac{\text{AUC}_{\text{p.o.}}}{\text{AUC}_{\text{i.v.}}}$$

First-pass effect:

Some drugs have such a high rate of metabolism that no drug ever enters the systemic circulation even though it is completely absorbed.

Oral doses may be higher than parenteral doses because of reduced bioavailability ($F < 1$)¹:

$$\text{Dose}_{\text{p.o.}} = \frac{\text{Dose}_{\text{i.v.}}}{F_{\text{oral}}}$$

e. Enterohepatic circulation:

Some drugs are absorbed, transported to the liver, and secreted into the bile. They are then deposited back into the intestine and can be reabsorbed.

f. Alterations in gastric emptying time can delay or speed up absorption.

Prolonged times to gastric emptying time will generally result in delayed absorption.

Some drugs can directly affect emptying time.

¹A similar dosage adjustment is required when a drug is prepared in a formulation that provides a fraction of the total weight of drug as active drug and the remainder as an inactive salt. The fraction of total drug that will be delivered as active drug to the systemic circulation is called the "salt factor" (S). The appropriate dose is determined by dividing the desired dose of active drug by the salt factor.

2. Sublingual/buccal

a. advantages

will not be absorbed into the portal system

a higher pH than found in the stomach

b. disadvantages

drug taste

3. Rectal

a. advantages

50-60% will by-pass the portal vein & avoid first-pass hepatic metabolism

useful in cases of nausea and vomiting

b. disadvantages

discomfort, inconvenience, etc.

B. Inhalation

1. passive diffusion

2. large surface area

3. volatile gases

driven by differences in partial pressures

4. aerosol preparations

site of absorption dependent on particle size

5. drug absorption varies with depth and duration of inspiration

may be necessary to titrate to desired effect or use metered inhaler

C. Topical

1. mostly for non-systemic use

2. highly lipid soluble compounds will reach general circulation

3. common forms include creams, lotions, gels, ointments, shampoos

D. Transdermal

1. passive diffusion of drugs across the skin—driven by concentration gradient
2. potential benefits:
 - a. controlled release of the drug into the patient—enables a steady blood-level profile
 - b. user-friendly, convenient, painless, multi-day dosing—improved patient compliance
 - c. bypassing the gastrointestinal (GI) tract obviates GI irritation that occurs with some drugs and avoids partial first-pass inactivation by the liver
3. limitations/risks:
 - a. skin barrier limits the number of drugs that can be delivered by passive diffusion from an adhesive patch
 - b. potential skin irritation, discomfort

E. “Parenteral” (not via the digestive tract), often used to describe administration of drugs by injection

importance of blood flow:

blood flow to the area maintains the concentration gradient (the drug is removed by the circulating blood, so its concentration will remain lower in the local blood vessels than on the tissue side at the site of injection).

advantages

greater degree of reliability and precision of administered dose

fewer problems with absorption

do not have to worry about presence or absence of food in the stomach

do not have to worry about "first-pass effect"

disadvantages

- sight of the needle
- pain
- tissue damage and irritation
- drug must be in solution form

1. subcutaneous (sc)

a. advantages

- i. a slow even absorption*
- ii. may be used as a depot*
- iii. rate of absorption can be modified by altering blood flow*

b. disadvantages

- i. is of little value in peripheral circulatory failure (shock)*
- ii. only small volumes can be accommodated*

2. intramuscular (im)

a. advantages

- i. a more rapid absorption than seen with sc*
- ii. as with sc administration, rate of absorption can be modified by altering blood flow*

b. disadvantages

- i. potential infection and/or nerve damage*
- ii. danger of inadvertent iv administration*

3. intravenous (iv)

a. advantages

- fastest and most reliable way of achieving a specific blood level*

b. disadvantages

- to avoid a bolus effect (an excessively high plasma concentration achieved by rapid i.v. drug administration) it may be necessary to administer the dose over a longer period of time*

F. Other parenteral:

1. intrasynovial (within the synovial sac of a joint, or the synovial sheath of a tendon)
2. intrathecal (through the theca of the spinal cord into the subarachnoid space)
3. vaginal
4. urethral
5. ocular
6. nasal
7. aural
8. intraperitoneal
9. epidural (into the epidural space of the spinal column)

III. Distribution of absorbed drug

A. Factors influencing distribution

1. regional differences in blood flow
2. tissue mass
3. transport mechanisms
4. permeability characteristics

some membranes are more resistant to drug passage than others, e.g. blood-brain barrier, blood-testis barrier, and placental barrier

5. ion-trapping

drug can be trapped in a body compartment due to a local pH differences

6. protein-binding

- many drugs bind reversibly to plasma proteins.
 - *albumin binds acidic drugs*
 - *α 1 acid glycoprotein binds basic drugs*
- protein-bound drugs are retained in the plasma.

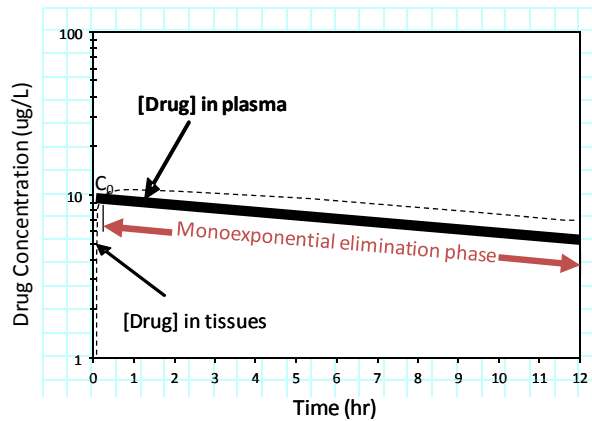

One-compartment Distribution. Plasma (solid line) and tissue (broken line) concentrations after i.v. administration of a loading dose of drug.

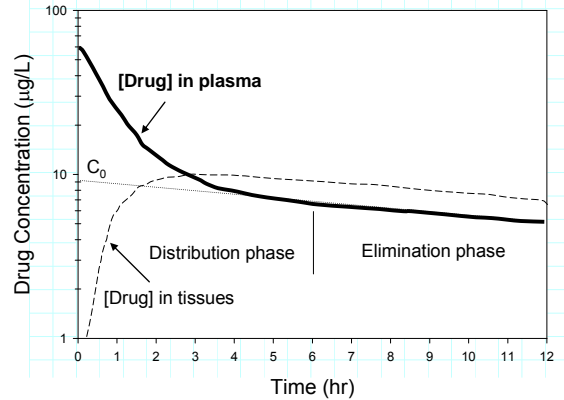

Two-compartment Distribution. Plasma (solid line) and tissue (broken line) concentrations after i.v. administration of a loading dose of drug. C_0 is estimated by back extrapolation (dotted line) of the elimination phase plasma concentrations.

B. One- vs. Two-compartment Distribution

1. One-compartment: a rapid equilibrium is achieved between plasma and tissue distribution following drug administration. Plasma concentration-time profile declines mono-exponentially.
2. Two-compartment: rapid distribution to a volume represented by a central compartment (usually plasma, V_P) is followed by slow distribution to tissues/peripheral binding sites (second compartment; V_T). This results in a bi-exponential plasma concentration-time profile. With repetitive administration, steady-state concentrations are achieved only after 5-6 elimination half-lives ($t_{1/2}$). Digoxin, lidocaine, and phenytoin are examples of drugs that display two-compartment pharmacokinetics.

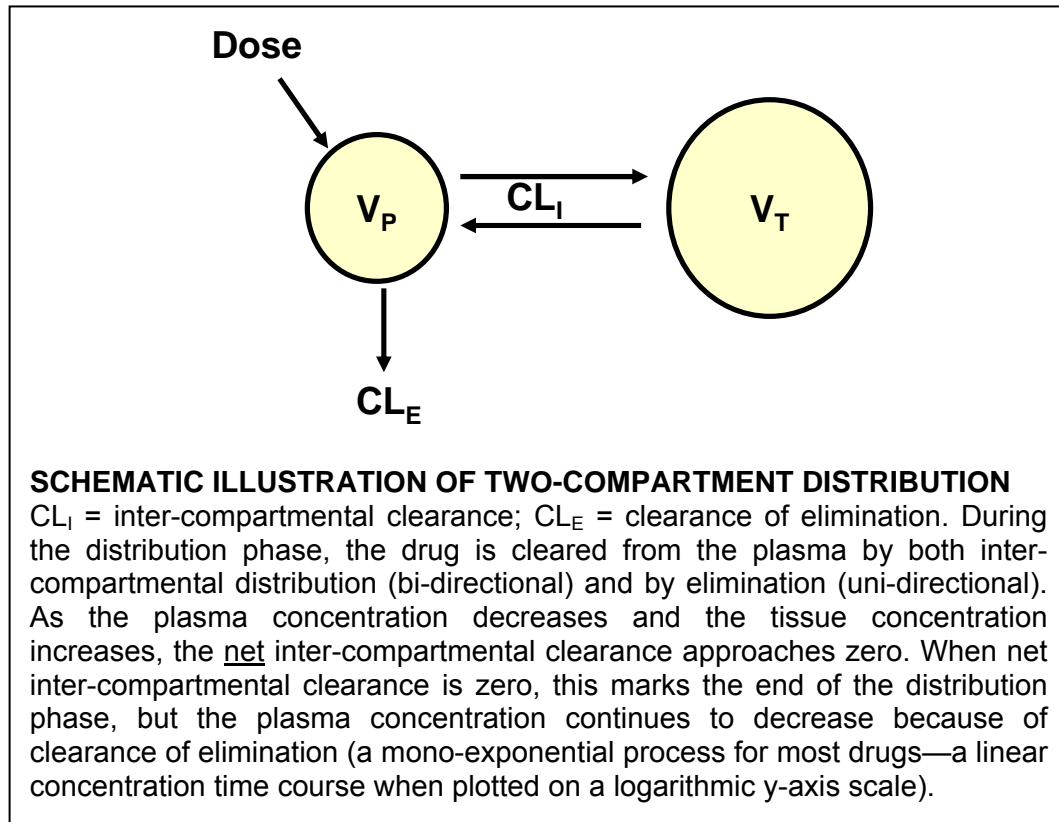

C. Volume of distribution

1. When a drug is administered it distributes to various body compartments.
2. Volume of distribution (V_d) is a measure of how much of the administered dose distributes outside of the plasma.
3. V_d describes how large a blood volume would be required to contain the entire administered dose at the concentration of drug in the plasma (C_0).
4. A drug which passes through cell membranes, is not bound to any tissue constituent or taken up into any particular cells (i.e. it is evenly distributed in total body water) would have a $V_d = 0.6 \text{ L/kg}$ (42 L/70 kg).
5. A drug which passes through capillary endothelium but not through cell membranes, and is not protein-bound or extremely lipid soluble may only be distributed in extracellular fluid and have a $V_d = 0.14\text{-}0.2 \text{ L/kg}$ (10-15 L/70 kg).
6. A drug which is tightly bound to plasma protein, would have a V_d equivalent to that of plasma water, $V_d = 0.06 \text{ L/Kg}$ (4 L/70 kg).
7. An increase in the unbound fraction of total [drug] (e.g. in hypoalbuminemia) will result in an increase in the apparent volume of distribution (V_d).

$$V_d = \frac{\text{Dose}}{C_0}$$

$$V_d = V_P + \left[V_T \times \frac{\text{fraction unbound in plasma}}{\text{fraction unbound in tissues}} \right]$$

where V_d = volume of distribution, V_P and V_T are plasma and tissue volumes, respectively. Note: V_T and fraction unbound in tissues (f_{uT}) cannot be determined easily. A reasonable approximation of V_T can be made by estimating tissue water volume (V_{TW}). For a 70 kg man, V_{TW} = total body water - plasma water $\approx 42L - 4L = 38L$

For example, consider a drug that is 90% bound to plasma albumin (10% unbound in the plasma). If the volume of distribution under these conditions is **14L**, the value of V_T divided by f_{uT} will be 100L (assume $V_P = 4L$). Assuming no other parameters change, a drop in plasma [albumin] that decreases the fraction of bound drug to 80% (20% unbound in plasma) will increase V_d to **$\approx 24L$** :

$$V_d = V_P + [(V_T/f_{uT}) \times f_u]$$

$$14L = 4L + [(V_T/f_{uT}) \times 0.1]$$

$$10L = [(V_T/f_{uT}) \times 0.1]$$

$$(V_T/f_{uT}) = 100L$$

$$V_d = V_P + [(V_T/f_{uT}) \times f_u]$$

$$= 4L + (100L \times 0.2) = 24L$$

D. Drug Reservoirs

- Following absorption, drugs in the systemic circulation are distributed to peripheral tissues.
- Distribution is bi-phasic: an initial distribution to organs with rich blood supply (kidney, liver, heart, lungs, brain), followed by distribution to other tissues with less rich blood supply (fat, muscles, bone, bladder).
- Different drugs distribute differently. For example, the anesthetic thiopental, a highly fat-soluble drug, rapidly enters the brain, but the antibiotic penicillin, a water-soluble drug, does not. Fat-soluble drugs such as thiopental tend to concentrate in adipose tissue. Bone can accumulate environmental toxins such as lead or drugs such as tetracycline antibiotics. Some drugs have a very narrow distribution profile, because specific tissues have a particularly high affinity for the drug (for example, iodine concentrates mainly in the thyroid gland).
- Fat and muscle in particular can act as **drug reservoirs**. Ultimately large amounts of a drug can accumulate in these tissue reservoirs, especially in obese patients. In some cases more drug may be stored in these tissues than remains in the systemic circulation.
- Deposition into any reservoir limits the fraction of the drug available for diffusion from the plasma to site of action as well as to sites of excretion (or metabolism).
- When plasma levels of the drug decline due to metabolism or excretion, they are replenished by diffusion from the reservoir. Gradual release of drug from these sites can prolong the therapeutic effect or result in toxicity if drug administration is continued.
- A reservoir may need to be saturated with the drug before a therapeutic effect is manifest. In this case a large dose may be needed to provide an effective concentration at the site of action of the drug.
- Plasma proteins can also serve as a drug reservoir. For a highly protein-bound drug, a large fraction of administered drug may be retained in the plasma because only the unbound drug molecules can cross cell membranes. In its protein-bound state the drug may not be distributed to its site of action. When the drug dissociates from plasma protein (the dissociation rate will depend primarily on its affinity for the protein) it will then be free to distribute to exert its effects.
- Many different drugs bind to sites on plasma albumin, so competition can occur between them. Theoretically, administration of drug B can reduce the protein binding, and hence increase the free plasma concentration of drug A. To do this, drug B needs to occupy an appreciable fraction of the protein binding sites. Few therapeutic drugs affect the binding of other drugs to albumin because they occupy, at therapeutic plasma concentrations, only a tiny fraction of the available sites. Sulfonamides are an exception because they occupy about 50% of the binding sites at therapeutic concentrations and so can cause unexpected effects by displacing other drugs.

PHARMACOKINETICS II: DRUG ELIMINATION & MULTIPLE DOSING

Learning Objectives

By the end of the lecture, you should be able to:

1. Explain the difference between first-order, zero-order and dose-dependent kinetics of drug elimination.
2. List examples of commonly prescribed drugs that follow zero-order, first-order and dose-dependent kinetics.
3. Understand the concept of steady-state with regard to plasma drug concentrations.
4. Explain the importance of different pharmacokinetic parameters on the duration of drug action.
5. Know the primary pharmacokinetic parameters and how they are used to determine appropriate loading dose and maintenance dose.
6. Understand how repetitive drug administration or continuous drug infusion can attain therapeutic drug concentrations.
7. Know the roles of the kidney and liver in the elimination of drugs from the body.

Recommended Reading:

The Merck Manual Online

<http://www.merck.com/mmpe/sec20/ch303/ch303a.html>

Goodman & Gilman's Manual of Pharmacology and Therapeutics

Brunton & Parker, eds., McGraw-Hill, Copyright © 2008

An Outline of Topics for Review

1. Review the plasma concentration versus time curve.
 - a. Distribution phase.
 - b. Elimination phase.
2. Review the apparent volume of distribution (V_d).
 - a. The dilution principle
 - b. Why is V_d larger than anatomically possible (for some drugs)?
3. The loading dose.
 - a. Definition
 - b. Rationale
 - c. Dependence on V_d
4. The maintenance dose.
 - a. Definition
 - b. Rationale
 - c. Dependence on CL_E

5. The concept of steady-state.
 - a. The plateau principle.
 - b. Dependence of eventual steady-state levels on the maintenance dose and not on the loading dose.
6. Drug administration by continuous infusion.
Estimation of clearance from the infusion rate and the steady-state plasma concentration ($CL = I / C_{ss}$).
7. Kinetics of drug elimination.
 - a. First-order kinetics.
 - b. Zero-order kinetics.
 - c. Dose-dependent kinetics.
 - d. Examples of drugs that are eliminated by these types of kinetics.
8. Elimination clearance (CL_E).
 - a. Definition.
 - b. The relationship of k and $t_{1/2}$ to clearance.
9. Elimination half-life: Clearance and Volume of Distribution as primary pharmacokinetic parameters
 - a. k a dependent parameter ($k = CL/V_d$)
 - b. $t_{1/2}$ a dependent parameter ($t_{1/2} = 0.69 V_d/CL$)
10. Renal Insufficiency.
 - a. Affects on Clearance
 - b. Adjustment of dosing rate.
11. Hepatic Clearance.
 - a. Determinants: hepatic blood flow, protein binding, intrinsic clearance.
 - b. Restrictive hepatic clearance ($CL_H = f \cdot CL_{int}$).
 - c. Non-restrictive hepatic clearance ($CL_H = Q$).

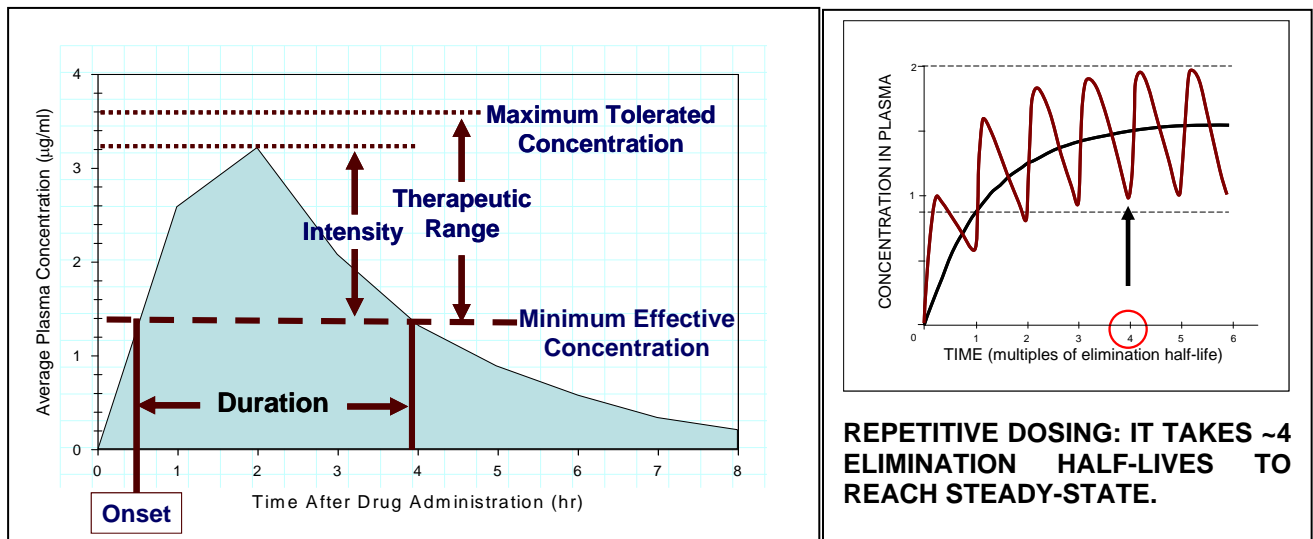

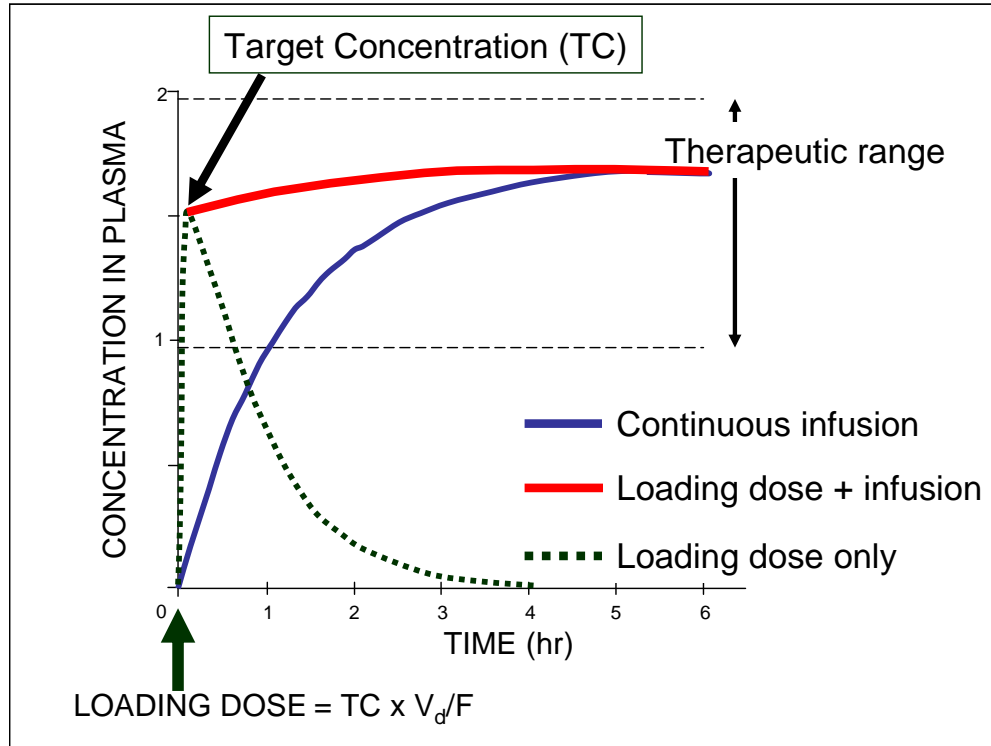

A LOADING DOSE MORE RAPIDLY ACHIEVES A THERAPEUTIC DRUG LEVEL. Loading dose is dependent on the Volume of Distribution.

$$LD = TC \times V_d / F$$

LD = Loading Dose (e.g. in mg)
 V_d = Volume of Distribution (e.g. in L)
 TC = Target Concentration (e.g. in mg/L)
 F = Bioavailability

MAINTENANCE DOSING

- Dosing strategy to maintain a steady-state concentration of drug in the body.
- Dose is based on replacing the amount of drug cleared from the body since the previous drug administration.

$$MD = CL \times TC \times T / F$$

MD = Maintenance Dose (e.g. in mg)
 CL = Clearance (e.g. in L/hr)
 TC = Target Concentration (e.g. in mg/L)
 T = Dosing interval (e.g. in hr)
 F = Bioavailability

- Clearance is the primary determinant for calculating the maintenance dose.

STEADY-STATE CONCENTRATION

- A function of dosing rate and elimination clearance
- Rate of drug administration = rate of drug elimination
- Continuous I-V infusion:
 - Steady-state attained after approximately four elimination half-lives
 - Time to steady-state independent of dosage

$$C_{ss} = \frac{\text{Dosing Rate} \cdot F}{\text{Clearance}}$$

$$\text{Infusion rate} = CL \times C_{ss}$$

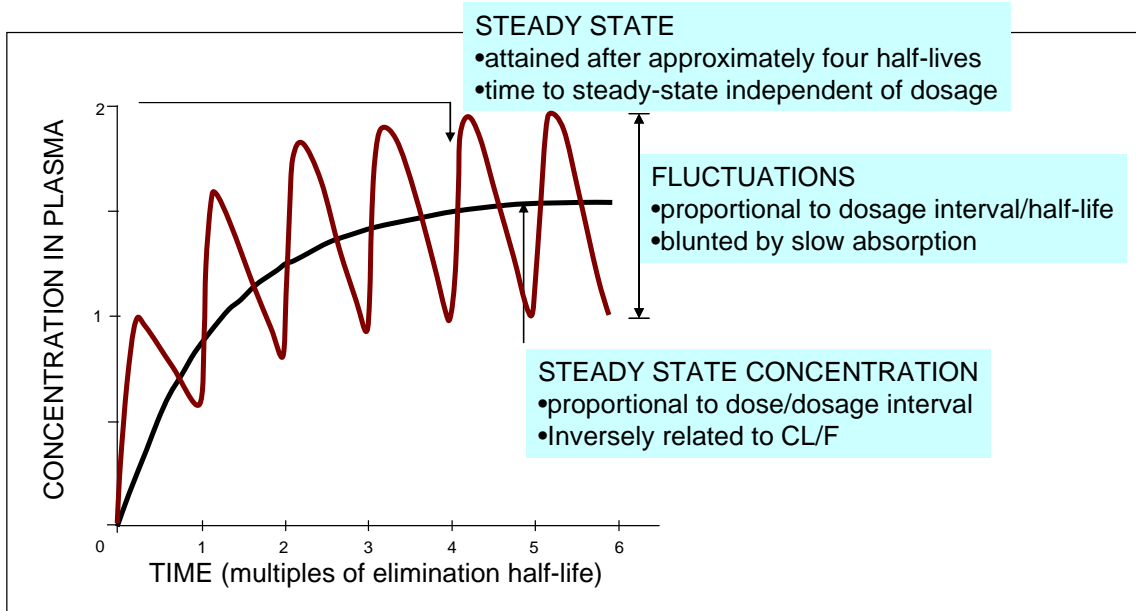

KINETICS OF DRUG ELIMINATION

FIRST-ORDER KINETICS OF DRUG ELIMINATION

- 1st-order elimination (or kinetics): the elimination rate of the drug is a constant fraction of the drug remaining in the body (rather than a constant amount of drug per hour).
- Elimination half-life ($t_{1/2}$) is constant.
- Most drugs used clinically obey 1st order kinetics.

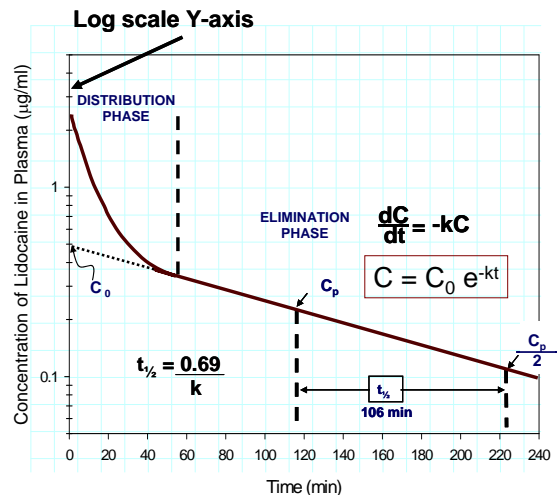

First-order Elimination of Lidocaine

ZERO-ORDER KINETICS OF DRUG ELIMINATION

- Drugs that are eliminated primarily by metabolism may display zero-order kinetics of elimination.
- When metabolic pathways are saturated, metabolism occurs at a fixed rate, i.e. it does not change in proportion to drug concentration.
- A fixed amount of drug is metabolized per unit time (zero-order kinetics).

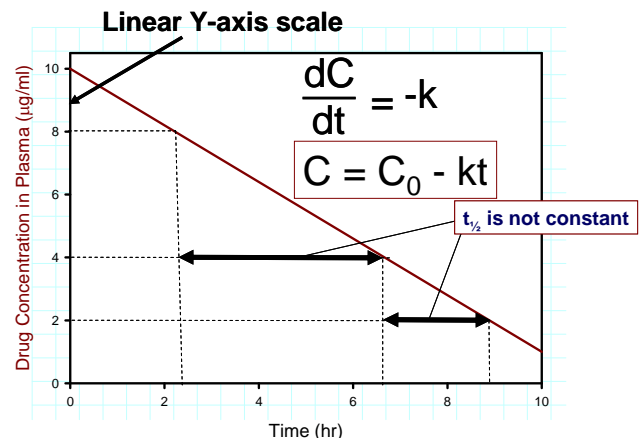

ZERO-ORDER ELIMINATION

DOSE-DEPENDENT KINETICS OF DRUG ELIMINATION

- When a drug's elimination is mediated predominantly by metabolism, its elimination will tend to follow first-order kinetics when concentrations are well below the K_M of the metabolic enzymes, but will follow zero-order kinetics at doses that greatly exceed the K_M of the metabolic enzymes.
- Common examples include phenytoin, ethanol, and aspirin.

DOSE-DEPENDENT ELIMINATION RATE

$$\frac{dC}{dt} = -\frac{V_{MAX} \cdot C}{K_M + C}$$

ELIMINATION CLEARANCE

- Volume of plasma cleared of drug per unit time. Units are ml/min or L/hr ("flow").
- Drug elimination may occur through the kidneys, the liver, the lung, and other organs.
- Total Clearance is equal to the sum of all these individual and simultaneously occurring organ clearances:

$$CL_{total} = CL_{renal} + CL_{hepatic} + CL_{other}$$

ELIMINATION HALF-LIFE

Time to eliminate 50% of the body content of the drug—it is a function of both Clearance and Volume of Distribution.

$$t_{1/2} = \frac{0.69 V_d}{CL} = \frac{0.69}{k}$$

RENAL FAILURE

- Impaired renal function often results in reduced clearance of drugs that are eliminated primarily by the kidneys.
- Dosing rate must be reduced by the ratio of measured clearance in renal failure (CL_{RF}) to expected normal, average clearance (CL_N).
- The dosing rate may be reduced by decreasing the dose, increasing the dosing interval, or both.

$$\text{Dosing Rate}_{RF} = \text{Dosing Rate}_{Normal} \times \frac{CL_{RF}}{CL_N}$$

- Creatinine clearance (CrCL), estimated using the Cockcroft & Gault equation, can provide an assessment of renal function. The ratio of CrCL in renal failure to CrCL

Cockcroft & Gault Eq:

$$\text{CrCL (ml/min)} = \frac{(140 - \text{age}) \times \text{wt (kg)}}{72 \times [\text{serum Cr}] \text{ (mg/dL)}} \times \begin{cases} 1 & \text{if male} \\ 0.85 & \text{if female} \end{cases}$$

in a patient with normal renal function can also be used to adjust the dosing rate. **Creatinine clearance is not the same as clearance of a drug.**

HEPATIC CLEARANCE

Determined by:

1. Hepatic Blood Flow (rate of drug delivery to the eliminating organ).
2. Plasma Protein Binding (fraction of drug available for clearance).
3. Intrinsic Clearance (hepatocellular metabolism and/or biliary excretion).

1. RESTRICTIVE HEPATIC CLEARANCE

- Drugs with low hepatic extraction ($Q \gg f \cdot CL_{int}$)
- Little "first pass metabolism" when given orally.
- A change in binding or drug metabolism/excretion activity will have a greater effect on hepatic clearance than changes in liver blood flow. Capacity-limited clearance.
- Examples: warfarin, phenytoin

$$CL_H = f \cdot CL_{int}$$

The Rowland's Equation:

$$CL_H = Q \left[\frac{f \cdot CL_{int}}{Q + f \cdot CL_{int}} \right]$$

Q = Liver blood flow
f = Free Fraction (unbound)
CL_{int} = Intrinsic Clearance

2. NON-RESTRICTIVE HEPATIC CLEARANCE

- Drugs with high hepatic extraction ($Q \ll f \cdot CL_{int}$)—extensive first pass metabolism.
- Hepatic clearance is sensitive to changes in liver blood flow and less sensitive to alterations in binding or intrinsic clearance. Flow-dependent clearance: conditions that reduce hepatic blood flow (CHF, hypotension) will reduce hepatic clearance.
- Examples: lidocaine, propranolol

$$CL_H = Q$$

BASIC CONCEPTS IN PHARMACOKINETICS

Pharmacodynamics: A major subdivision of pharmacology dealing with the actions and the mechanisms of action of drugs (i.e., the concepts of drug-receptor interactions and the dose-response relationship are studied under pharmacodynamics).

Pharmacokinetics: The other major subdivision of pharmacology, dealing with the quantitative description of absorption, distribution, metabolism and elimination of drugs (i.e., pharmacokinetics provides the scientific basis for dose selection and also deals with the time-course of drug action).

Bioavailability: For drugs given orally, it is defined as the fraction of the administered dose that reaches the systemic circulation unchanged. A drug may have incomplete bioavailability (less than 100%) if it is incompletely absorbed or if it undergoes metabolism while going through the liver via the portal circulation (first-pass metabolism). Some drugs have high bioavailability (e.g., 90-100% of a dose of warfarin, phenytoin, theophylline or digitoxin will reach the systemic circulation unchanged after oral administration). Other drugs will undergo extensive first-pass metabolism in the liver and will have a low bioavailability when given orally (e.g., about 30-35% of a dose of lidocaine or propranolol will reach the systemic circulation unchanged after oral administration).

Apparent Volume of Distribution: A primary pharmacokinetic parameter used to relate the dose administered to the resulting plasma concentration of drug. This parameter is calculated in reference to plasma concentration of drug, and may be large or small (sometimes much larger than anatomically possible), depending on the tissue:plasma partition ratio for the drug in question (e.g. the apparent volume of distribution for digoxin is of the order of 9.8 liters/kg body weight, which in a 70 kg individual would amount to a total apparent volume of distribution of 686 liters, reflecting the much higher affinity of digoxin for tissues than for plasma). Knowledge of the apparent volume of distribution is important for the appropriate calculation of loading doses. The apparent volume of distribution is also a primary determinant of the drug's elimination half-life ($t_{1/2}$).

Apparent Volume of Distribution (V_d) = Loading Dose/ C_0 (initial concentration)

When given intravenously, some drugs distribute rapidly from the intravascular compartment to the peripheral target tissues (e.g. plasma lidocaine is in equilibrium with tissue lidocaine in a matter of minutes), whereas other drugs distribute rather slowly (e.g. plasma digoxin does not reach equilibrium with tissue digoxin for at least 6-8 hours after an i.v. dose). This is relevant to the proper interpretation of plasma concentrations of drugs. For drugs that distribute slowly, the elimination phase of the plasma concentration vs. time plot should be extrapolated back to the zero time axis to determine C_0 for V_d calculations.

Clearance: The other primary pharmacokinetic parameter, clearance determines the rate of drug elimination. Just as, for example, creatinine clearance, the clearance of a drug may be defined as the volume of plasma that is cleared of drug per unit time. Some drugs undergo only renal clearance (e.g. gentamicin, tobramycin, vancomycin), some are eliminated only via hepatic clearance (e.g. theophylline, warfarin, phenytoin, lidocaine), and others undergo both renal and hepatic clearance (e.g. digoxin, procainamide, penicillin G). The term nonrenal clearance is often used to include hepatic clearance and any other extrarenal route of clearance for a drug. Renal and nonrenal clearances are additive, such that:

$$\text{Clearance of elimination} = \text{Renal clearance} + \text{Nonrenal clearance}$$

Clearance of elimination is another major determinant of a drug's elimination half-life ($t_{1/2}$).

Elimination Half-Life ($t_{1/2}$): This concept is applicable to drugs that follow first-order (exponential) kinetics of elimination. It is defined as the time required to eliminate one-half (50%) of the body content of a drug. It is important to note that elimination half-life is dependent on both the apparent volume of distribution and the clearance of elimination, according to the following relationship:

$$t_{1/2} = \frac{0.69 \times \text{Apparent Volume of Distribution}}{\text{Clearance of Elimination}}$$

Volume of distribution and clearance are the primary parameters and are biologically independent of each other. Thus, half-life could change if either or both volume of distribution and clearance change. Consequently, $t_{1/2}$ reflects rate of drug clearance only when volume of distribution is constant (congestive heart failure appears to reduce both the apparent volume of distribution and the clearance of lidocaine, so that the $t_{1/2}$ of this drug may appear normal and may be misleading in the choice of the proper infusion rate; the reduced volume of distribution also requires a reduction in the loading doses).

Steady-State Concentrations: With continuous drug administration (maintenance therapy) by either constant rate i.v. infusion or constant oral dosing rate (e.g., lidocaine infused at a rate of 2 mg/min i.v., or digoxin given orally at a dosing rate of 0.25 mg/day), most drugs will accumulate exponentially until a plateau or steady-state concentration is reached. With dosing at a constant interval, concentrations will fluctuate above and below the steady-state concentration. Once steady-state has been achieved (the rate of drug administration is equal to the rate of drug elimination), the following relationship applies:

$$\text{Steady-State Concentration} = \frac{\text{Dosing Rate}}{\text{Elimination Clearance}}$$

Thus, there is a directly proportional relationship between the dosing rate and the steady-state plasma concentration. This is true for most drugs used in clinical medicine, since most drugs follow **first-order kinetics** of elimination (the rate of drug elimination is proportional to the amount of drug present in the body).

Some drugs like phenytoin, aspirin and ethyl alcohol are exceptions to the rule in that they follow **dose-dependent kinetics** of elimination. At low doses and plasma concentrations, they

follow apparent first-order kinetics, but at higher doses and plasma concentrations the metabolic pathways become saturated and the drugs exhibit zero-order kinetics of elimination (a constant amount of drug is eliminated per unit time; drug metabolism is capacity-limited and is not proportional to the amount of drug present in the body). Thus, changes in the dosing rate may result in disproportionate, non-linear changes in drug concentrations, and toxicity may develop.

With first-order kinetics, if the dosing rate is doubled, the steady-state concentration will double. With dose-dependent kinetics, doubling the dose may result in tripling or quadrupling the steady-state concentration, with the attendant risk of toxicity.

Maintenance Dosing: Maintenance dosing is a regimen whereby a drug is administered at regular intervals (or continuously infused) to achieve a steady-state plasma concentration. Once steady-state is achieved, the maintenance dose matches the amount of drug cleared since the previous dose was administered (or the infusion rate matches the rate of elimination). Maintenance dosing is therefore dependent on the clearance of elimination according to the formula:

$$MD = CL \times TC \times T/F$$

where MD = maintenance dose (e.g. in mg), CL = clearance of elimination (units of flow, e.g. L/hr), TC = target concentration (at steady-state; units of concentration, e.g. mg/L), T = interval (units of time, e.g. hr), and F = bioavailability.

An alternative representation of this relationship is that the maintenance dosing rate (dose/interval) equals the product of clearance and target concentration:

$$F \times MD \text{ rate (mg/hr)} = CL \times TC = \text{infusion rate (for continuous i.v. administration)}$$

The time to reach the steady-state target concentration is approximately 4-6 elimination half-lives. At steady-state the plasma concentration can be adjusted by a proportional change in maintenance dose (if the clearance and interval are constant and assuming first-order kinetics of elimination). For example, doubling the maintenance dose would double the plasma concentration (but it would take 4-6 elimination half-lives to achieve the new steady-state).

When the drug is administered at regularly spaced intervals, the plasma concentrations will fluctuate above and below the steady-state concentration. The magnitude of the fluctuations will be directly proportional to the ratio of interval to the elimination half-life.

In some cases, a **loading dose** may be given to more rapidly achieve a therapeutic plasma concentration. The loading dose is dependent on volume of distribution rather than clearance and is intended to rapidly achieve a specific concentration of drug:

$$LD = V_d \times TC/F$$

where LD = loading dose (e.g. in mg), V_d = volume of distribution (e.g. in L), TC = target concentration (e.g. in mg/L), and F = bioavailability.

If drug levels are measured and found to be inadequate, a new target concentration can be rapidly achieved using an adjusted loading dose formula:

$$LD = V_d \times (TC - C_{\text{measured}})/F$$

There is no interval specified in the loading dose formula because it does not take into account the clearance of elimination. Therefore the loading dose formula cannot strictly be used to specify a maintenance dosing regimen—the time it takes for the concentration to decline from the calculated target concentration is not figured into the equation. A maintenance dosing regimen, based on the clearance of elimination, is normally initiated at its specified dosing interval (T) after the loading dose.

Time to Reach Steady-State: With continuous or repetitive drug administration, it is useful to know that 90% of the eventual steady-state concentrations will be achieved in a time equal to 3.3 elimination half-lives ($t_{0.90} = 3.3 t_{1/2}$). The longer the $t_{1/2}$, the longer it will take to reach steady-state.

If the clearance of a drug is decreased and the $t_{1/2}$ prolonged, for example, due to renal or hepatic disease, it will take longer to achieve steady-state concentrations, in proportion to the increase in $t_{1/2}$. Note that we are talking about the time required to reach steady-state, not the actual steady-state concentration that will be reached. The actual steady-state concentration will be a function of the dosing rate (i.e. mg/min, mg/day, etc.) and the elimination clearance (see above).

Drug	Use	Some pharmacokinetic characteristics
aspirin	Analgesic, antipyretic, anti-inflammatory.	Approximates zero order kinetics of elimination at high concentrations.
digoxin	Atrial fibrillation, atrial flutter and congestive heart failure	Narrow therapeutic index, large Volume of Distribution (V_d), high bioavailability, two-compartment distribution profile.
ethyl alcohol	Makes you drunk.	Concentration-dependent kinetics of elimination; zero-order at high concentrations.
gentamicin tobramycin	Aminoglycoside antibiotics, used to treat many types of bacterial infections, particularly Gram-negative bacterial infections	Cleared exclusively by the kidney, both can be highly nephrotoxic, particularly if multiple doses accumulate over a course of treatment—usually dosed by body weight and serum levels are monitored during treatment. Tobramycin does not pass the gastro-intestinal tract, so for systemic use it can only be given intravenously or intramuscularly.
lidocaine	Local anesthetic and antiarrhythmic	Low bioavailability (extensive first-pass metabolism in the liver). Lidocaine hydrochloride is available in various forms including: injectable (for i.v. injection/infusion or as local anesthetic), dermal patch, nasal instillation/spray, oral (gel, liquid), topical (gel, liquid, or patch). Given i.v. it distributes rapidly to tissues. Eliminated primarily by metabolism in the liver. Two-compartment distribution profile.
penicillin G	Antibiotic used in the prophylaxis and treatment of infections caused by Gram-positive bacteria.	Elimination rate is dependent on renal function and is greatly reduced in renal failure: $t_{1/2}$ can increase as much as 20-fold.
phenytoin	Antiepileptic—acts by stabilizing the inactive state of voltage gated sodium channels.	Approximates zero-order kinetics of elimination at therapeutic concentrations. High bioavailability. Eliminated primarily by metabolism in the liver. Highly protein-bound.
propranolol	β -blocker, mainly used in the treatment of hypertension.	Extensive first-pass metabolism (low bioavailability), lipid soluble, large V_d .
theophylline	A methylxanthine drug used in therapy for respiratory diseases such as COPD or asthma	Theophylline has a narrow therapeutic index. It approaches zero-order kinetics of elimination at high concentrations. High bioavailability. Eliminated primarily by metabolism in the liver.
vancomycin	A glycopeptide antibiotic used in the prophylaxis and treatment of infections caused by Gram-positive bacteria.	Vancomycin must be given intravenously, because it is not absorbed orally (it is a large hydrophilic molecule which partitions poorly across the gastrointestinal mucosa). It is eliminated by the kidney.
warfarin	Anticoagulant	Warfarin has a long half life. It may be given orally once per day, but it is highly protein-bound and often takes several days to reach therapeutic effect. High bioavailability. Eliminated primarily by metabolism in the liver.

#6 - Clinical Pharmacokinetics: Individualizing Therapy

Andrea L. Quinn
PharmD
Clinical Pharmacist
Pharmacy Clinical Education Coordinator
Loyola University Health System
(708) 216-9545
aquinn@lumc.edu

Learning Objectives:

Upon completion of this lecture, the student should be able to:

1. Describe how patients' characteristics can influence the four basic pharmacokinetic parameters of medications (Absorption, Distribution, Metabolism, and Elimination).
2. List the factors involved in designing individualized dosing regimens and describe how deviations from standards can be anticipated.
3. Describe why steady state is essential for effective therapy / accurate dose adjustment.
4. Describe how drug interactions can be associated with protein binding, metabolic pathways and/or patient disease states (different types of drug interactions).
5. Describe which pharmacokinetic parameter is impacted when given a nonspecific medication nonspecific drug interaction scenario.



I. Pharmacokinetic Principles

- A Four main principles are associated with every pharmacological agent (see section I C).
 - 1 Familiarity with these principles for each medication is essential to ensure accurate patient dosing (HINT: memorize general rules with *exceptions* for specific drugs).
 - 2 Assess your patient (use your eyes!) and use available information.
 - (i) Physical
 - (ii) Laboratory
 - (iii) Radiological
 - (iv) Overall clinical response
- B These principles provide a basis for “usual” doses but deviations occur within patients.
- C Four pharmacokinetic principles:
 - 1 Absorption (A)
 - (i) How the drug gets into the body from the site of administration
 - (ii) Oral / Enteral: can the drug be absorbed?
 - (a) Bioavailability: what percent of the active drug reaches the systemic circulation when compared to IV administration of the same dose?
 - (b) First Pass Metabolism (Effect): drugs absorbed by the digestive system enter the hepatic portal system and are metabolized by the liver before reaching the systemic circulation.
 - (c) PKa and PKb
 - (i) Ionized versus nonionized form
 - (ii) Nonionized (non protonated) forms distribute more readily
 - (iii) pH of environment
 - 1. Certain drugs require an acidic or basic environment for absorption
 - a. Itraconazole (azole antifungal) requires an acidic environment
 - b. Didanosine (nucleoside reverse transcriptase inhibitor) requires a basic environment
 - (d) Function of GI tract
 - (i) Ileus (lazy or sluggish bowel tract)
 - (ii) Bowel obstruction
 - (iii) Gastric resection, small versus large bowel resection
 - 1. Most drugs are absorbed in stomach or first part of duodenum
 - 2. Intact versus impaired
 - (iv) Tube feeds – where is the tip of the feeding tube located
 - 1. Gastrostomy tube
 - 2. Duodenal
 - 3. Jejunal tube (hint: not great for enteral absorption)
 - 4. Can the medication be given via a feeding tube?
 - a. Liquid formulations preferred
 - b. Not all tablets may be crushed & not all capsules may be opened.
 - c. Generally, cannot crush sustained release/controlled release drugs
 - (iii) Parenteral
 - (a) Intravenous
 - (i) 100% bioavailability
 - (ii) Avoids first pass effect

- (b) Intramuscular
 - 1. $\leq 100\%$ bioavailability
 - 2. Avoids first pass effect
- (c) Less common parenteral routes
 - (i) Intrathecal, intraventricular
 - (ii) Intraocular
 - (iii) Intra-articular
- (iv) Topical/Transdermal/ Subcutaneous
 - (a) $\leq 100\%$ bioavailability
 - (b) Avoids first pass effect
 - (c) Thick skin versus thin skin impairs topical absorption
 - (d) Intact versus non-intact impairs topical absorption
 - (e) Skin temperature will affect absorption (i.e. fentanyl transdermal patches)
- 2 Distribution V_d (L/kg) (D)
 - (i) Will the drug reach the target site?
 - (ii) Perfusion rate
 - (a) Normal perfusion allows for organs such as the liver, kidney, heart, brain etc to be exposed to the medication
 - (b) Impaired perfusion limits exposure
 - (i) Ischemia (physiologic versus pharmacologic)
 - (ii) Higher doses may be required
 - (iii) Properties of the medication
 - (a) Lipophilic - Adipose (i.e. vancomycin)
 - (b) Hydrophilic - Extracellular fluid (i.e. aminoglycosides)
 - (c) Other areas – Bone, eye
 - (iv) Physiologic barriers
 - (a) Protein binding
 - (i) Low protein binding \rightarrow generally large V_d
 - (ii) High protein binding \rightarrow V_d may be challenged
 - (iii) Changes can potentially affect clinical response & drug disposition
 - (iv) Albumin is often used as a clinical marker
 - (b) Blood Brain Barrier (BBB)
 - (i) Noninflamed meninges: tight web, minimal penetration
 - (ii) Inflamed meninges: increased spaces, possibly better penetration
 - (iii) Medications with decreased protein binding cross BBB easier
 - (iv) Maximize dosing or consider alternate routes of administration (i.e. intraventricular)
 - (c) Bone, Eye, Placenta
- 3 Metabolism (M): How a drug is broken down
 - (i) Many drugs undergo some form of hepatic metabolism with breakdown into active or inactive metabolites.
 - (ii) Competition for metabolic pathway (CYP₄₅₀ systems)
- 4 Elimination (E)
 - (i) Affects half-life ($t_{1/2}$)
 - (ii) Most drugs are renally eliminated.
 - (a) Renal function deteriorates with age.

- (i) Estimate of renal function made via Creatinine Clearance (CrCl)
 - 1. Cockcroft & Gault most common formula (ml/min)
 - 2. Most drug references list renal dose adjustment per CrCl (ml/min) as defined above and NOT MDMR (modification of diet in renal disease) GFR (ml/min/1.73m²)
- (ii) CrCl will be different for healthy 30yo and healthy 80yo.
- (iii) Creatinine also comes from muscle.
- (iv) Calculation using actual serum creatinine in elderly patients may overestimate true renal function.
- (b) Acute versus chronic renal insufficiency
- (c) Hemodialysis and hemofiltration
 - (i) May filter out drug
 - 1. Hydrophilic
 - 2. Small molecular size
 - (ii) CrCl <10ml/min
- (d) Anticipate dose adjustment with deviations from 'normal' renal function (CrCl < 70-100 ml/min-clinically) due to prolonged t_{1/2}
- (iii) Biliary and fecal elimination
 - (a) Less common
 - (b) Ceftriaxone (3rd generation cephalosporin antibiotic)– primarily eliminated via the bile
 - (c) Linezolid (oxazolidinone antibiotic) – primarily fecal elimination
 - (d) Dose adjustments are generally not needed
- (iv) Useful equations
 - (a) $t_{1/2} = 0.693 / K$ (hr⁻¹)
 - (b) Cl (L/hr) = K (hr⁻¹) x V_d (L)

II Population pharmacokinetics

A "Textbook" pharmacokinetics

- 1 General pharmacokinetic parameters based on clinical trials.
- 2 Basis for recommended dosing
- 3 Provide standard pharmacokinetic information with ranges
 - (i) Gentamicin
 - (a) V_d 0.25L/kg (0.2-0.3L/kg); t_{1/2} 2h; <30% protein binding
 - (b) Interpatient variability: renal function, hydration status
 - (c) Inpatient variability: clinical status
 - (ii) Phenytoin (Dilantin[®])
 - (a) V_d varies with age
 - (b) Protein binding 90% - binds to albumin (variances with neonates/infants)
 - (c) Interpatient variability: protein binding, metabolism

B Patients do not always behave like textbooks!!

- 1 You must assess patient's individual pharmacokinetic parameters.
 - (i) What is the best route? Will the patient absorb the medication?
 - (ii) Will the drug get to where I want it to go? Is my patient dehydrated, edematous, cachectic or obese?
 - (iii) How is his/her renal or liver function? Do I need to adjust the dose?

- 2 Reference books / Internet health care information sites to serve as guides
 - (i) Clinical pharmacology®
 - (ii) Epocrates®, Rxlist®
 - (iii) Lexicomp Drug Information
 - (iv) Micromedex®, Medscape®
 - (v) Other reputable sources
- C Examples of variations in pharmacokinetic parameters per age group
 - 1 Neonates (<30 days of life)
 - (i) Immature skin, increased skin hydration → increased absorption of topical products
 - (ii) Increased extracellular fluid → higher volume of distribution of water soluble drugs (i.e. aminoglycosides)
 - (iii) Metabolic pathways mature at different times
 - (iv) Glomerular filtration, tubular secretion and reabsorption immature at birth
 - 2 Elderly
 - (i) Skin thinning → increased topical absorption
 - (ii) Increased adipose tissue → increase in volume of distribution of fat soluble drugs
 - (iii) Decreased extracellular fluid → decrease in volume of distribution of water soluble drugs
 - (iv) Age related decrease in renal function

III Therapeutic Drug Monitoring (TDM)

- A Starting dose for drugs requiring TDM are designed based on population pharmacokinetics. Adjustments are made utilizing patient specific pharmacokinetic parameters calculated from patient specific drug levels.
- B Depending on the drug, a Loading Dose (LD) may be given to help achieve an immediate therapeutic response by reaching levels that are seen at steady state quickly. However, steady state is not reached any faster—3 to 5 half-lives are still needed. .
- C Dose adjustments are best made when the patient is at steady state
 - (i) Steady state is dependent only on half life ($t_{1/2}$)
 - (ii) Pharmacokinetic parameters must remain stable for accurate dosing.
 - (i) Renal function for renally eliminated drugs
 - (ii) Hepatic function for hepatically eliminated drugs
 - (iii) Why is being at steady state important?
 - (a) Minimizes potential for over/under dose adjustment
 - (b) Assumes maximum and stable distribution
 - (iv) Level interpretation
 - (a) The adjustment is only as good as the drug level assessment
 - (b) Was the level drawn appropriately in relation to the dose and from the appropriate IV line?
 - (c) False levels may lead in inappropriate dose changes
- D Dosing is not always “one stop shopping”
 - 1 Different doses may be needed to treat the same indication for different patients
 - 2 Patients with similar age, height, weight may still require different dosing

- E Examples of drugs that require TDM include select antibiotics (Aminoglycosides, Vancomycin), antiepileptic agents (i.e. carbamazepime, phenytoin), anticoagulants (warfarin, heparin---monitor coagulation times not drug levels per se)

F Clinical Scenario

- 1 LC is a 41 year old female who is being treated for E. Coli urosepsis. She is allergic to many medications and her only treatment option at this time is tobramycin. She is 64inches tall and weighs 62kg on admission. Her usual weight is 57kg (IBW 55kg). Renal function is within normal limit with BUN of 10 and Cr of 0.8mg/dl. She has marked edema and has not yet received any diuretic. Based on this information, her estimated CrCl is 78.3ml/min using her actual weight. You calculate her estimated PK parameters using population data.
 $V_d = 0.25l/kg = 14.25L$ Dosing interval 8 hours

You use her usual weight and recommend starting tobramycin 115 mg (~2mg/kg iv x 1 loading dose b) then 8 hours later start 85mg iv q8h. Your desired peak is 6mcg/ml and trough is <2mcg/ml for treatment of urosepsis.

You check tobramycin levels with the 4th dose and find that the peak is reported at 4mccg/mL and the trough 0.5mcg/mL. Serum creatinine is stable at 0.8mg/dl but her weight is now 64kg and she has 3+ pitting edema. What happened?

- 2 Aminoglycosides readily distribute into extracellular fluid. When dosing was initiated in this patient, she was dosed based on a euvolemic status. However, as she was fluid overloaded at the time of medication initiation and is even more fluid loaded at present, the tobramycin readily distributed into the extracellular fluid resulting in lower serum levels. Slightly increasing the milligram amount of the dose would have accounted for some of the extracellular shifting. However, if the patient were to have been diuresed, the levels would have been right on target. the

IV Drug Interactions

- A Up to 2.8% of hospital admissions have been attributed to Drug-Drug Interactions (Jankel CA, Fitterman LK. Drug Safety 1993; 9(1): 51-9.)
- B Why is this important?
- 1 Patient safety
 - 2 Health Care Reform
 - 3 Medicare and Medicaid reimbursement
- C Drug interactions are often correlated with pharmacokinetic parameters
- 1 Absorption
 - (i) Will drug A affect absorption of drug B
 - (ii) Chelation
 - (iii) Changes in stomach pH
 - 2 Distribution
 - (i) Competition for binding sites
 - (ii) Changes in protein binding due to disease states
 - (iii) Changes in extracellular fluid or adipose

- 3 Metabolism
 - (i) Hepatic metabolism
 - (a) Inducer of CyP₄₅₀
 - (b) Inhibitor of CyP₄₅₀
 - (c) Major enzymes: 1A2, 2C9, 2C19, 2D6, 3A4
 - (ii) Other metabolic pathways
 - 4 Elimination
 - (i) Competition for elimination pathways
 - (ii) Renal elimination is the most common
- D Types of interactions
- 1 Drug-Drug interaction: prescription, nonprescription, herbal
 - (i) Drug A causes sub/supratherapeutic effect of drug B or vice versa
 - (ii) Drug A causes toxic effect of drug B or vice versa
 - (iii) Augmentation of adverse effects
 - 2 Drug-nutrient interaction
 - (i) Primarily with oral agents
 - (ii) Affect bioavailability/ metabolism/ efficacy
 - 3 Drug-Disease State interaction
 - (i) Drug may worsen disease state
 - (ii) Disease state may result in sub/supratherapeutic effect of drug
 - (iii) Risk versus benefit
 - 4 Intentional versus unintentional interaction
 - (i) Do we wish to use the interaction to achieve a desired clinical response
 - (ii) Example: amoxicillin plus probenecid
- E Examples of interactions
- 1 Drug-Drug Interaction
 - (i) Absorption
 - (a) Sucralfate (Carafate®) (GI medication) + levothyroxine (Synthroid®) (thyroid medication)
 - (i) Sucralfate (antacid: coats stomach, decreases levothyroxine absorption
 - (ii) Subtherapeutic levothyroxine levels
 - (iii) Space doses
 - (b) Ciprofloxacin (Cipro®) (Quinolone antibiotic) + Calcium Carbonate (Tums®)
 - (i) Chelation
 - (ii) Decreased absorption of ciprofloxacin may lead to clinical failure
 - (iii) Space dose by at least 2h, take antibiotic first
 - (c) Itraconazole (Sporonax®) (azole antifungal) + pantoprazole (Protonix®) (proton pump inhibitor)
 - (i) Pantoprazole increases stomach pH
 - (ii) Decreases absorption of itraconazole- possible clinical failure
 - (iii) Choose alternative acid reducing agent if possible
 - (ii) Distribution
 - (a) Aspirin + Warfarin (Coumadin®)
 - (i) Aspirin competes for protein binding sites of warfarin
 - (ii) Increased free warfarin concentrations = increased active drug
 - (iii) Increased efficacy of warfarin therefore adjust warfarin dose

- (iv) Generally recommend discontinuation of aspirin
 - 1. Note: Aspirin plus warfarin may be used in patients with extensive cardiac history or severe coronary artery disease and/or cerebral vascular disease per clinical judgment
- (v) Itraconazole and warfarin
- (iii) Metabolism
 - (a) Carbamazepime (Tegretol®) (antiepileptic) + Oral Contraceptives (OCP)
 - (i) Carbamazepime is a CYP₄₅₀ inducer
 - (ii) Increased OCP metabolism
 - (iii) Decreased OCP concentrations = clinical failure
 - (b) Saint John's Wort + cyclosporine (immunosuppressant) (Neoral®, Sandimmune®)
 - (i) St. John's Wort is a CYP₄₅₀ inducer
 - (ii) Decreased cyclosporine concentrations may lead to clinical failure
 - (c) Voriconazole (VFend®) (azole antifungal) + Tacrolimus (Prograf®) (immunosuppressant)
 - (i) Voriconazole is a CYP₄₅₀ inhibitor
 - (ii) Increased tacrolimus concentrations = supratherapeutic effect
 - (iii) Black Box warning but in clinical practice, levels are monitored with adjustments as needed
 - (d) Disulfiram (Antabuse®) + Pinot Grigio (wine)
 - (i) Disulfiram inhibits aldehyde and alcohol dehydrogenase leading to increased alcohol concentrations = SICK
 - (ii) Intentional interaction
 - (iii) Other drugs can cause a disulfiram like reaction: metronidazole
 - (e) Grapefruit and atorvastatin (Lipitor®)
 - (i) Atorvastatin is a HMG CoA reductase inhibitor used to treat high cholesterol and grapefruit is an inhibitor of CYP450 enzyme system and p-glycoprotein in the gut.
 - (ii) Increased atorvastatin levels---potential toxicity
 - (iii) Spacing grapefruit juice/fruit and the drug has NO effect and it may take up to 3 days for grapefruit effects on the CYP450 system to resolve
 - (iv) Controversial: whole fruit versus juice
 - (f) Itraconazole and warfarin
 - (i) Itraconazole is a strong inhibitor of CYP 3A4 (and bound to albumin)
- (iv) Elimination
 - (a) Probenecid + amoxicillin
 - (i) Probenecid blocks tubular secretion of amoxicillin
 - (ii) Increased amoxicillin concentrations = increased effect
 - (iii) Intentional
 - (b) Tobramycin (aminoglycoside antibiotic) + Cyclosporine (Neoral®, Sandimmune®) (immunosuppressant)
 - (i) Both agents are renally eliminated and known to be nephrotoxic
 - (ii) Augmentation of adverse effects
- 2 Drug-Nutrient Interaction
 - (i) Ciprofloxacin (Quinolone antibiotic)+ Boost® Nutritional supplement

- (a) Divalent and Trivalent cations in Boost® bind to ciprofloxacin (chelation)
- (b) Decreased absorption of ciprofloxacin resulting in potential subtherapeutic levels
- (ii) Warfarin and vitamin K containing vegetables
 - (a) Warfarin affects vitamin K dependent clotting factors to prolong bleeding time
 - (b) Consumption of vitamin K negates this effect leading to decreased warfarin efficacy (decreased PT/INR)
 - (c) Patients CAN eat vitamin K containing products, but must be consistent with vitamin K content ingestion (not necessarily consistent with source types)
- 3 Drug-Disease State Interaction
 - (i) Dronaderone (antiarrhythmic agent) and Class IV CHF
 - (a) Dronaderone can worsen heart failure
 - (ii) Gentamicin (aminoglycoside antibiotic) and severe liver disease
 - (a) Gentamicin is renally eliminated and has been known to cause nephrotoxicity.
 - (b) Renal insufficiency in patients with severe liver disease impacts elimination pathways
 - (c) Monitor levels (risk vs. benefit)
 - (iii) Phenytoin (Dilantin®) (antiepileptic agent) in a burn patient
 - (a) Decreased albumin stores
 - (b) Decreased bound phenytoin concentrations
 - (c) Measured total level may appear low
 - (d) Increased free phenytoin = possible supratherapeutic effect if dose increase made
 - (e) Monitor, correct for albumin level and adjust dose
 - (i) $\text{Corrected phenytoin} = \frac{C_{\text{measured}}}{0.2 \times \text{albumin}} + 0.1$
 - (iv) Vitamin A supplement in a hemodialysis patient
 - (a) Vitamin A is a lipid soluble vitamin not removed by HD
 - (b) May result in toxicity
 - (v) Propranolol and asthma
 - (a) Propranolol is a nonselective beta blocker (β_1 and β_2)
 - (b) May cause lung constriction secondary to β_2 effects
 - (vi) Corticosteroids in a diabetic patient
 - (a) Corticosteroids (prednisone, methylprednisolone, prednisolone) may increase blood sugars.
 - (b) Although not a contraindication for use, per se, careful monitoring of blood glucose levels with medication adjustment is needed.
 - (vii) Codeine and rapid or slow 2D6 metabolizers
 - (a) Codeine is metabolized by Cyp 2D6 to morphine
 - (b) Morphine elicits the pain relief
- 4 Intentional vs. unintentional interaction
 - (i) Often, interactive properties of drugs may be used to enhance dosing regimen
 - (a) Amoxicillin + probenecid (refer to IV, D, 4, ii)
 - (b) Ritonavir + lopinavir
 - (i) HIV protease inhibitors

- (ii) Ritonavir is a CYP450 inhibitor
 - (iii) Increased lopinavir concentrations
 1. Resulting in decreased dose
 2. Decreased frequency of administration
- 5 How can drug interactions be avoided?
- (i) Know YOUR most commonly prescribed drugs
 - (ii) Know which references to utilize for drug information
 - (iii) Educate patients use only one pharmacy and maintain accurate medication histories
 - (iv) Reconcile patient medication at each clinic visit, upon hospital admission AND discharge.

V Clinical scenarios

- A MQ is a 36yo F s/p gastric bypass surgery currently followed in the nutrition clinic for management of iron deficient anemia. She has been taking oral iron sulfate 324mg three times a day for the past 2 months, yet her hemoglobin is 8.2mg/dl and her CBC results and iron studies show no improvement in the iron deficiency. She states that she is compliant with the medications and even takes the iron in liquid format with a vitamin C tablet to help “boost absorption”.

What could explain the low iron levels?

- B LJ is a 70yo female with a history of hypertension and penicillin allergy (hives) who was admitted with severe chest pain and subsequently diagnosed with 3 vessel cardiac disease. A TTE was done which showed new onset mitral regurgitation. Blood cultures were drawn. TEE the following day revealed mitral valve endocarditis and blood cultures became positive for gram positive cocci in pairs and chains. The ID team wishes to start vancomycin and synergy dose gentamicin.

60kg, 5'1.5" Na 137 K 3.9 Cl 102 CO2 28 BUN 8 Cr 1.01
Patient has central IV access and appears euvolemic.

Patient was started on gentamicin 60mg IV q8h and vancomycin 1g iv q12h based on standard doses. Her CrCl is ~49ml/min body actual weight and 38ml/min using IBW.

Levels were drawn on Day 2 of therapy and reported as follows:

Gentamicin peak: Not drawn

Gentamicin trough: 2.9mcg/ml (desired <2)

Vancomycin trough: 24.3mcg/ml (desired <15)

Creatinine: 1.24mg/dL

What happened? Explain.

Hint: no math is needed

- C. 69yo M with a PMH including CVA resulting in paralysis, PVD, DM, CHF, seizure disorder, CAD. He was recently admitted for a CHF exacerbation and a *pseudomonas* UTI. He was treated with piperacillin/tazobactam (Zosyn®) IV while admitted x 3 days and was discharged on oral ciprofloxacin (Cipro ®) per sensitivities to complete a 14 day total treatment course. He was readmitted 4 days after discharge for urosepsis. Blood and urine cultures reveal the same strain of *pseudomonas*. You are the intern admitting him. His daughter stated that he is complaint with the medications and you reconcile his home medications from a chart she provided.

Ciprofloxacin 500mg: 1 tab at 8am 8pm
MVI+ minerals: 1 tab daily 8am
Calcium Carbonate 500mg: 2 tablets at 8am
Enalapril 20mg tab: 8am 8pm
Phenytoin 300mg tablet at 10pm

What factor(s) could account for the clinical failure?

- E. SU is a 60yo F with Type II diabetes (medically managed) and severe osteoarthritis of knees and ankles. She recently fell down the stairs and further injured her knee. Her internal medicine physician prescribed a prednisone (corticosteroid) taper for 5 days to decrease the inflammation. Day 2 of therapy, she complains of increased thirst and urination and reports her blood sugars to be in the 300's despite no diet or other medication changes.

What happened?

- F. SQ is being treated for acne rosacea with topical metronidazole (Metrogel ®). He declined medication counseling when he picked up his prescription. He always applies the medication immediately after showering and shaving. He has come down with a cold and bought Nyquil® and some vitamin C tablets. After his first dose of both medications, he becomes diaphoretic and experiences nausea and vomiting.

What happened?

- G. A 35 year old female is status post ACL repair. Pain was controlled with IV morphine is to be discharged on oral codeine as needed for pain relief. She sees you in clinic 3 days later and states that she is still experiencing pain despite taking the medication as prescribed.

What could potentially explain this situation?

Drugs listed throughout this lecture.			
Drug	Class	Context	Page #
Amoxicillin	Beta lactam Antibiotic Aminopenicillin	Drug Interaction	7, 8, 9
Aspirin	Salicylate	Drug Interaction	8
Atorvastatin	HMG CoA reductase inhibitor Antihyperlipidemic	Drug Interaction	7
Calcium Carbonate	Calcium Salt, antacid	Drug Interaction, Case	7, 12
Carbamazepime	Antiepileptic agent	Drug Interaction	5, 8
Ceftriaxone	Beta lactam antibiotic 3 rd generation cephalosporin	Biliary elimination	4
Ciprofloxacin	Quinolone antibiotic	Drug Interaction, Case	7, 8, 12
Codeine	Opioid (mu agonist)	Drug Disease state interaction	9
Cyclosporine	Immunosuppressant, IL II inhibitor	Drug Interaction	8
Didanosine	HIV. NRTI	Requires basic environment for absorption	2
Disulfiram	Aldehyde dehydrogenase inhibitor	Drug Interaction	8
Dronaderone	Antiarrhythmic	Drug interaction	9
Enalapril	ACE inhibitor	Case	12
Fentanyl Patches	Opioid analgesic	Absorption and skin temp	3
Gentamicin	Aminoglycoside antibiotic	Population PK example, Vd changes with increased ECF, TDM, Case	4, 9, 11
Heparin	Anticoagulant	TDM	5
Iron Sulfate	Mineral	Case	11
Itraconazole	Azole antifungal	Requires acidic environment for absorption, Drug Interaction	2, 7, 8
Levothyroxine	Thyroid agent	Drug Interaction	7
Linezolid	Oxazolidanone antibiotic	Fecal elimination	4
Lopinavir/Ritonavir	HIV Protease Inhibitors	Drug Interaction	9
Methylprednisolone	Corticosteroid	Drug Interaction	9
Metronidazole	Amebicide/antiprotozoal antibiotic	Drug Interaction, Case	8, 12
Oral Contraceptives (OCP)	Contraceptive	Drug Interaction	8
Pantoprazole	Proton Pump Inhibitor	Drug Interaction	7
Phenytoin	Antiepileptic agent	Population PK example, Drug interaction	4, 5, 9
Piperacillin/Tazobactam	Extended spectrum Penicillin/beta lactamase inhibitor combination Beta lactam antibiotic	Case	12
Prednisolone	Corticosteroid	Drug Interaction	9
Prednisone	Corticosteroid	Drug Interaction, Case	9, 12
Probenecid	Uricosuric agent (for gout)	Drug Interaction, Case	7, 8, 9
Propranolol	Non selective Beta Blocker	Drug Interaction	9
St. John's Wort	Herbal agent	Drug Interaction	8
Sucralfate	Gastrointestinal agent	Drug Interaction	7
Tacrolimus	Calcineurin inhibitor, immunosuppressant	Drug Interaction	8
Tobramycin	Aminoglycoside antibiotic	TDM	6, 8
Vancomycin	Glycopeptide antibiotic	Drug reservoir (adipose) TDM	3, 5, 11
Vitamin A	Vitamin	Drug Interaction	9
Voriconazole	Extended spectrum Azole antifungal	Drug Interaction	8
Warfarin	Anticoagulant	TDM, Drug Interaction	5, 7, 8, 9

DRUG METABOLISM

Date: August 9, 2013 – 9:30 am

Reading Assignment: Katzung, Basic and Clinical Pharmacology, 9th Ed., pp. 51-63

KEY CONCEPTS AND LEARNING OBJECTIVES

1. To understand the consequences of metabolic transformation of drugs.
2. To know the sites of drug metabolism at the organ, cellular and subcellular levels.
3. To understand why a drug is metabolically transformed following its administration to a patient.
4. To understand the differences between phase I and phase II drug metabolism reactions.
5. To understand the four main elements required for drug metabolism mediated by the mixed-function oxidase (MFO) system as shown in Figure 1.
6. To understand the therapeutic implications of drug metabolism to the patient.
7. To understand factors that affect drug metabolism.
9. To understand how enzyme induction and inhibition affects drugs metabolism.

#6 - DRUG METABOLISM

Drug Metabolism (also known as drug biotransformation): chemical transformation of a xenobiotic within a living organism

- enzyme-catalyzed reactions (most drugs)
- noncatalyzed chemical reactions (some drugs)

A. CONSEQUENCES OF METABOLIC TRANSFORMATIONS OF DRUGS

1. **INACTIVATION:**

- foreign compound (i.e. xenobiotic) is inactivated
- facilitate elimination - inactive metabolite is more easily eliminated
- lipid-soluble (hydrophobic) drugs converted to water soluble (hydrophilic) metabolite
 - lipid soluble drugs are easily reabsorbed in renal tubules whereas water soluble drugs are not
 - drug metabolite ("key") will not fit receptor site ("lock") - drug action will be terminated
 - **important point** - drugs may be considered poisons:
 - a. high doses can be harmful (**toxic effects**)
 - b. therapeutic doses can also be harmful (**side effects**)

2. **ACTIVATION:**

- inactive drug converted to an active form
- **wanted effect:** pro-drug L-dopa (inactive) is converted to dopamine (active)
- **unwanted:** production of a more toxic metabolite from a non-toxic compound (**LETHAL SYNTHESIS**)
Example: insecticide parathion (inactive) is converted into toxic agent paraoxon (active) - stable metabolite that binds to and inactivates cholinesterases

3. **MAINTENANCE OF ACTIVITY**

- active drug converted to active metabolite with same activity
Example: diazepam (active) is converted to oxazepam (active)

B. ANATOMICAL SITE OF DRUG METABOLISM

Organ: liver - most important organ for drug biotransformation
- gastrointestinal tract, lungs, skin, and kidneys display some activity

First-pass effect: many orally administered drugs will be extensively biotransformed before they reach the systemic circulation due to biotransformation in the G.I. tract and liver

Subcellular level: - endoplasmic reticulum, mitochondria, cytosol, lysosome, nuclear envelope, plasma membrane
- enzymes responsible for phase I reactions are mainly in the endoplasmic reticulum
- enzymes responsible for phase II reactions are mainly in the cytoplasm

C. MAIN CHEMICAL PATHWAYS OF DRUG METABOLISM: PHASE I and PHASE II REACTIONS

- drug metabolism reactions can be classified into two categories: phase I and phase II
- most drugs undergo phase I reactions first followed by phase II reactions
- phase I reactions: small chemical change makes drugs more hydrophilic and also provides functional group used to complete phase II reactions
- phase II reactions: conjugation with small, endogenous substance on functional group added during phase I reaction

NET EFFECT: lipophilic drug is converted to more hydrophilic metabolite that is easily eliminated in urine

PHASE I REACTIONS:

- referred to as functionalization reactions
- parent drug is converted to a more polar metabolite by introducing or unmasking a functional group on the molecule
- polar molecules are more water soluble and less likely to be reabsorbed by the glomeruli in the kidney and are excreted

There are four main Phase I reactions:

I. MICROSOMAL OXIDATIONS: 1. Aromatic hydroxylation; 2. N-dealkylation; 3. O-dealkylation; 4. S-demethylation; 5. Sulfoxide Formation; 6. N-oxidation; 7. N-hydroxylation

II. NON-MICROSOMAL OXIDATIONS: 1. Alcohol oxidation.

III. REDUCTIONS:

IV. HYDROLYSES: 1. Esterases; 2. Amidases; 3. Peptidases

SPECIFIC EXAMPLES OF DRUG METABOLISM

I. MICROSOMAL OXIDATIONS

Smooth endoplasmic reticulum - rich in enzymes responsible for oxidative drug metabolism;

Microsomal fraction – microsomes contain drug metabolism enzymes

- pellet obtained by centrifuging a tissue homogenate at $100,000 \times g$ for 1 hour
- forms vesicles from the membranes of the endoplasmic reticulum
- **purpose:** to study drug biotransformation *in vitro*.

Mixed-function oxidase (MFO) system mediates Phase I reactions

- most common *in vivo* system mediating drug oxidation reactions
- capable of wide variety oxidation reactions
- Figure 1 illustrates a common oxidation reaction known as a hydroxylation reaction - i.e. an hydroxyl group is introduced
- multistep reaction requires:
 - i. cytochrome P450 hemoprotein
 - ii. NADPH-cytochrome P450 reductase
 - iii. NADPH (reduced nicotinamide adenine dinucleotide phosphate)
 - iv. molecular oxygen (O_2)
- mediated by two distinct membrane proteins of the endoplasmic reticulum:
 - i. **cytochrome P450** - hemoprotein - terminal oxidase - name derived from the fact that reduced ferrous form of protein binds carbon monoxide, forming a complex with a unique absorption spectrum with a maximum at 450 nm
 - ii. **NADPH-cytochrome P450 reductase** - transfers reducing equivalents from reducing cofactor NADPH to hemoprotein
- net effect = one oxygen atom incorporated into drug substrate and one into water
- balanced equation: $RH + O_2 + NADPH + H^+ \rightarrow ROH + H_2O + NADP^+$
- can catalyze 60 different types of reactions on thousands of substrates
- cytochrome P450 (CYP) encoded by large gene family - multiplicity (57 isoforms) and promiscuity (broad substrate specificity)
- cytochrome P450 enzymes can be divided into families based on amino acid sequence identity
 - 3 main families mediate majority of drug biotransformations: CYP1, CYP2 and CYP3
 - other cytochrome P450 families important for metabolism of endogenous compounds
 - examples: cholesterol, steroids;

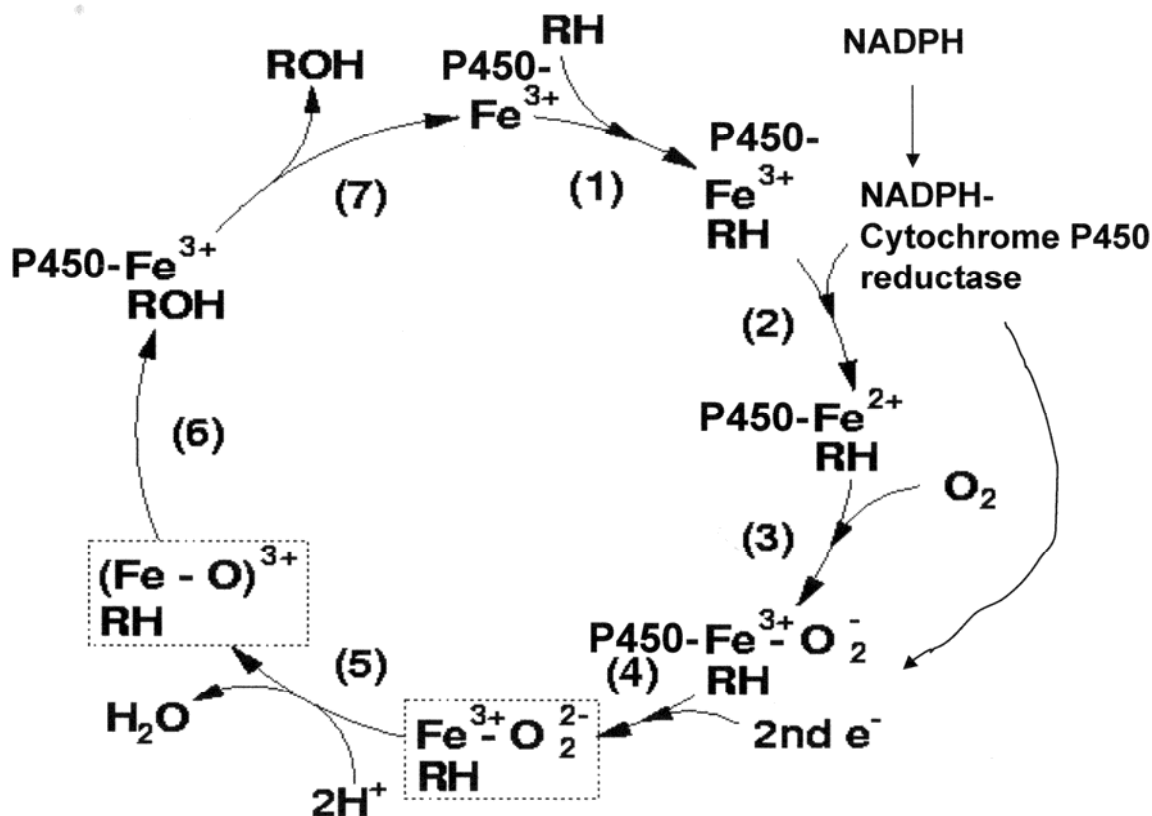
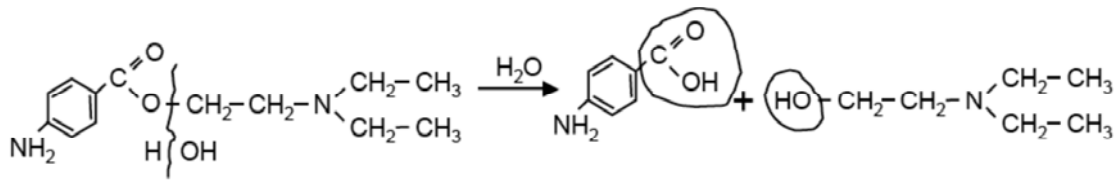

Figure 1. Cytochrome P450 isozymes catalyze xenobiotic metabolic reactions such as hydroxylation. Microsomal enzymes are responsible for oxidative drug metabolism and are known as **mixed functional oxidases (MFOs)**. These enzymes are also known as **monooxygenases** because one atom of oxygen is incorporated into drug substrate while the other atom of oxygen is used in the formation of water. The cytochrome P450 cycle:

1. The drug (RH) binds with cytochrome P-450 - hemoprotein enzyme in its oxidized ferric form (Fe^{3+}).
2. The resulting drug-cytochrome complex is then reduced by the flavoprotein NADPH-cytochrome P-450 reductase to its ferrous form (Fe^{2+}). NADPH serves as primary electron donor.
3. Molecular oxygen reacts with the reduced cytochrome P450-drug complex to generate a ternary complex.
4. A second electron transfer occurs probably via the same NADPH-cytochrome P-450 reductase.
5. The oxygen-oxygen bond is broken with the uptake of two protons. Water is released and activated oxygen is generated $(\text{Fe} - \text{O})^{3+}$.
6. The Fe-ligated O atom is transferred to the substrate forming a hydroxylated form of the substrate (ROH).
7. The product is released from the active site of the enzyme that returns to its original oxidized form.



Procaine (Novocaine®)

PABA

Diethylaminoethanol

2) AMIDASES



- mostly found in liver; located in endoplasmic reticulum

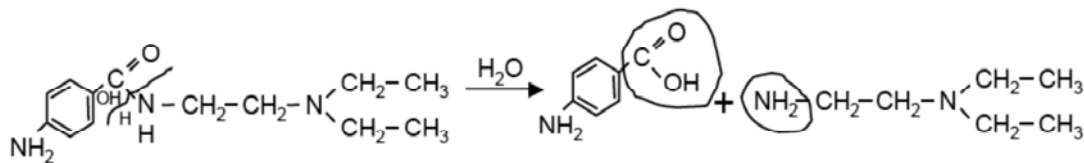

Procaine amide (Pronestyl®)

PABA

Diethylaminoethylamine

| Antimicrobial drug:

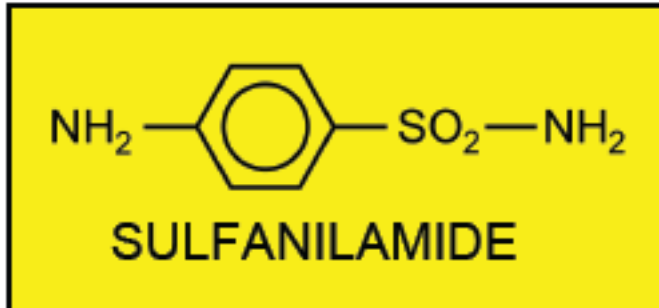

CLINICAL

SIGNIFICANCE: Do not use procaine for local anesthesia when treating an infection with a sulfa drug (sulfonamide). PABA (p-aminobenzoic acid) is structurally similar to sulfonamide drug.

PABA competes with sulfonamide at the site of action and is able to overcome the antibacterial inhibition of the sulfa drug, resulting in a loss of the therapeutic effectiveness.

CLINICAL APPLICATION: Substitute another antiarrhythmic agent instead of procainamide in patients receiving sulfa drug therapy.

PHASE II REACTIONS:

- typically involve biosynthetic reactions
- some phase I metabolites are not eliminated rapidly and these phase I metabolites are subject to subsequent phase II reaction
 - endogenous substrate combines with the functional group derived from phase I reactions through a covalent linkage
 - examples of endogenous substrates:
 - glucuronic acid, sulfate, glutathione, amino acids, acetate
 - **result** = highly polar conjugate - easily excreted in urine
 - some drugs already possess functional group that can form phase II conjugate directly without undergoing a previous phase I reaction

Examples Phase II Reactions: 1. Glucuronide formation; 2. Amino acid conjugation; 3. Acetylation; 4. Methylation; 5. Sulfation; 6. Mercapturic acid formation; 7. Transsulfuration; 8. Synthesis of ribonucleotides

PHASE II REACTIONS: CONJUGATIONS: SELECT EXAMPLES

1. GLUCURONIC ACID CONJUGATION

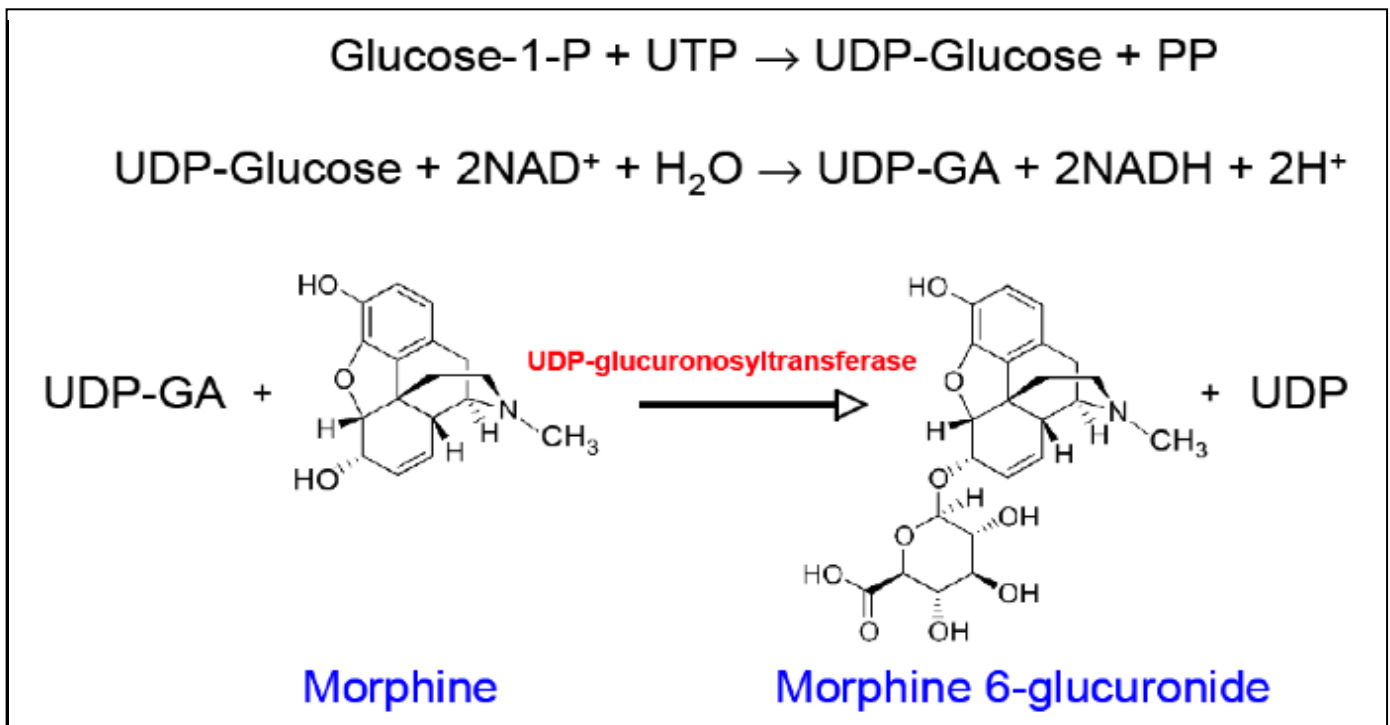

[UDP-GA = uridine diphosphate glucuronic acid (activated GA); UGT = UDP-glucuronosyltransferase;
PP = pyrophosphate]

- glucuronidation: most common conjugation reaction
- glucuronic acid is attached by UDP-glucuronosyltransferase (UGT) to aromatic and aliphatic alcohols, carboxylic acids, amines and free sulfhydryl groups
- metabolites can have O-, S- and N-glucuronide conjugates
- free glucuronic acid does not couple to drugs; it has to be activated to uridine diphosphate glucuronic acid (UDP-GA)
- UDP-GA is formed by a two-step process in the cytoplasm (active glucuronyl donor)
- glucuronide conjugates are more water soluble and are secreted in urine and bile
- UGT superfamily of enzymes has 16 members
- mostly expressed in liver; lesser degree in kidney, lung, skin, adrenal gland and spleen
- endogenous substances that are subject to glucuronidation: bile acids, bilirubin, steroids
- UGT is a microsomal enzyme (although most phase II reactions occur in cytoplasm)
- UGT is proximal to phase I metabolites, also formed in endoplasmic reticulum

2. ACETYLATION

- acetate from acetyl-coenzyme A is transferred to two types of functional groups
 - aromatic amines → acetamides
 - hydrazine → hydrazides
 - aromatic amine carcinogens are notable chemicals that are biotransformed by acetylation (e.g. 4-aminobiphenyl and 2-naphthylamine in cigarette smoke)
 - NAT1 and NAT2 are only known drug acetylation enzymes
- Sulfanilamide Acetyl Coenzyme A N-Acetylsulfanilamide

- **CLINICAL APPLICATION:** N-acetylsulfanilamide is less soluble in urine than parent compound, therefore producing crystalluria (precipitation of drug in urine)

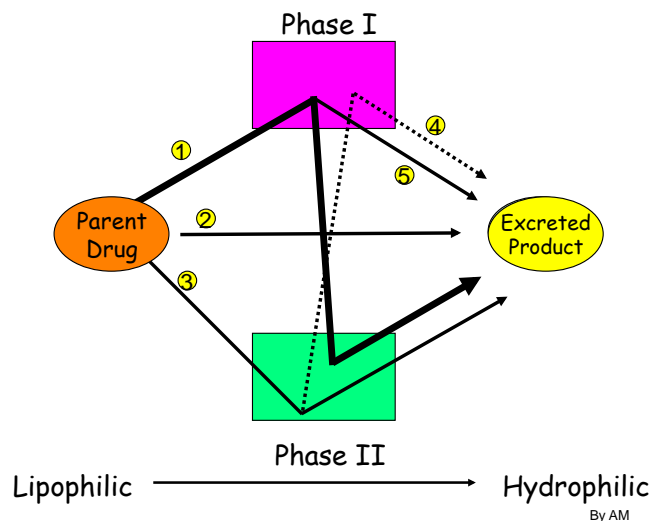

Figure 2. The possible sequential steps for Phase I and Phase II reactions that mediate drug biotransformation.

1. Most drugs undergo the sequential process of phase I reaction followed by phase II reaction before being eliminated.
2. In some cases, the parent drug may be eliminated unchanged without the need for any biotransformation.

3. In some cases, phase II reaction may precede phase I reaction.
4. A drug may possess a functional group that can be conjugated directly via a phase II reaction without the need for a phase I reaction.
5. In some cases, the product of a phase I reaction may be sufficiently polar and eliminated without the need of a phase II reaction.

C. FACTORS AFFECTING DRUG METABOLISM

1. Drug-age interactions

- a. - slow biotransformation in neonates and elderly patients
risk: increased susceptibility to drug toxicity
- neonates: differential developmental expression of drug metabolism enzymes
- elderly: decrease in liver mass, reduced hepatic blood flow, reduced enzyme activity

2. Drug-drug interactions (Drug incompatibilities)

- especially relevant to cytochrome P450 enzymes

- a. **competition** - drug may competitively inhibit metabolism of simultaneously administered drug -
RESULT: accumulation of both drugs, may lead to toxicity
- b. **induction – pharmacokinetic tolerance** - enzyme inducer may stimulate metabolism of simultaneously administered drug
RESULT: decrease in the therapeutic effectiveness of drug

NOTE: **pharmacodynamic tolerance** involves down-regulation of drug targets (e.g. receptors, ion channels, enzymes)

3. Drug-endogenous substrate interactions

- a. two drugs given together compete for the same endogenous substrate such as glucuronic acid for conjugation - faster-reacting drug may deplete the glucuronic acid level - inhibit the metabolism of the slower reacting drug

4. Drug-disease interactions

- a. Liver disease (e.g. cirrhosis; cancer; sepsis) can impair hepatic microsomal oxidases and therefore slow down drug metabolism.
- b. Cardiac disease: compromised blood flow and subsequent delivery to the liver can impair hepatic metabolism of a drug

5. **Drug-genetic interactions**

Genetics factors contribute to the ability of an individual to metabolize drugs

- a. Mutation in genes coding for enzymes that metabolize drugs
 - poor metabolizers - toxic accumulation of unmetabolized drug
 - rapid metabolizers - dosage modification to achieve target concentration

D. INDUCTION AND INHIBITION OF DRUG BIOTRANSFORMATION

i. INDUCTION

- a. upon repeated administration chemically dissimilar drugs can "induce" cytochrome P450
 - mechanism - transcriptional or posttranscriptional
 - **enhance rate of mRNA synthesis or reduce rate of protein degradation**
 - many drugs and environmental chemicals can promote induction

Examples:

- o Drugs can induce the expression of cytochrome P450

| - **phenobarbital** - induces CYP2B expression by increasing its transcription

- **grapefruit juice** - contains compounds that can inhibit CYP3A4

- **benzo(a)pyrene**, present in tobacco smoke, charcoal-broiled meat, and other organic pyrolysis products, is known to induce cytochrome P4501A1

- alter rates of drug metabolism in both experimental animals and in humans

- other environmental chemicals known to be cytochrome P450 inducers - **polychlorinated biphenyls (PCBs)** (used as insulating materials plasticizers),

- **2,3,7,8-tetrachlorodibenzo-p-dioxin (dioxin, TCDD)** (by-product of the chemical synthesis of the defoliant 2,4,5-trichlorophenol

- binds to aryl hydrocarbon receptor to induce cytochrome P450s CYP1A1, CYP1A2 and CYP1B1

RESULT: increased metabolism - dose adjustment to obtain desired effect

- NB: sometimes genetically determined - varies among individuals

ii. INHIBITION - cytochrome P450 enzyme activity inhibition by some drugs

- i. **Reversible inhibition** - non-covalent; competitive
 - e.g. cimetidine

- ii. **Irreversible inhibition** - covalent; non-competitive
e.g. spironolactone; chloramphenicol

E. GENERAL SUMMARY OF DRUG METABOLISM

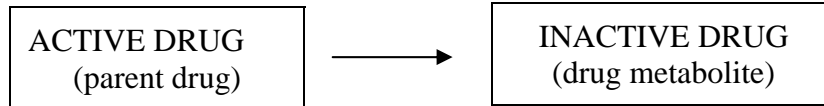

- 1) very lipid-soluble
- 2) less polar
- 3) less ionized
- 4) weak electrolyte
- 5) more able to penetrate cell membrane

- 1) less lipid-soluble
- 2) more polar
- 3) more ionized
- 4) strong electrolyte
- 5) less able to penetrate cell membranes

FINAL OUTCOME: Properties of drug metabolite serve to prevent the renal reabsorption of the drug metabolite, thereby allowing the body to eliminate the foreign compound

PHARMACOGENOMICS

Date: August 9, 2013 – 10:30 AM

Reading Assignment: None

KEY CONCEPTS AND LEARNING OBJECTIVES

1. Know definitions that are relevant to pharmacogenomics.
2. Understand the concept of drug response variability among general population. Know how to interpret Fig. 1.
3. Adverse Drug Reactions
 - a. Understand how to interpret Figure 2.
 - b. Know how polymorphic variants of CYP2D6, N-Acetyltransferase 2, CYP2C9, CYP2C19, CYP3A4, VKORC1 may impact drug responses in the general population.
4. Understand how pharmacogenomics impacts diseases that are directly hereditary and those that are in part environmentally dependent
5. Understand the power of pharmacogenomics as it relates to the following:
 - a. clinical trials
 - b. clinical practice
6. Know two examples of DNA based diagnosis that is coupled to targeted therapy:
Understand how decision to use trastuzumab and imatinib is achieved

Drugs that you are required to know:

none

PHARMACOGENOMICS

I. Overview:

Pharmacogenomics - the study of how an individual's genetic inheritance affects the body's response to drugs

Diagnostic and Therapeutic Goals:

- identify genomic, genetic, and proteomic data
- develop associations between these data and drug response patterns
- aid clinicians in their ability to prescribe proper medications
- predict therapeutic efficacy – regimen (medicine, dose, frequency)
- predict ADRs based on **genetic make-up**

GOAL: INCREASED PROBABILITY OF POSITIVE CLINICAL OUTCOME

Pharmacogenomics can be divided into four general areas:

- I. Avoiding adverse drug reactions
- II. Identifying causes of disease
- III. Designing clinical trials
- IV. Treating specific diseases

I. AVOIDING ADVERSE DRUG REACTIONS (ADRs)

Important definitions relevant to pharmacogenomics:

Mutation – an alteration of DNA sequence that is present only rarely in the population

Polymorphism – an alteration of DNA sequence that is present commonly in the population (>1% of the population)

- difference between mutation and polymorphism lies only in the frequency of occurrence

Single Nucleotide Polymorphism (SNP)

- a polymorphism due to a change in a single nucleotide
- human genome = 3×10^9 nucleotides
- average frequency of 1 per 1000 base pairs = interindividual difference 3×10^6 base pair
- useful for genome wide association studies
- can occur in coding and non-coding regions
- SNP in coding region may change amino acid = nonsynonymous coding SNP (cSNP)
- SNP in non-coding region may be in promoters, enhancers, splice sites, or other sites that control gene transcription or mRNA stability

Drug Response Variability in the Population

SNPs plus other changes in DNA (i.e. deletions, insertions, duplications, reshufflings) may affect an individual's response to medicines - see Figure 1 for how this would look graphically

- large variability of responses to medicines across the population (Figures 1 and 2)
 - e.g. dosage regimen will vary among individuals – clinical challenge
- many environmental factors will influence drug responses among individuals: age, lifestyle, health
- heredity plays a large role in heterogeneity of drug responses in the population
- drug metabolism enzymes are polymorphic → variability in responses: efficacy and ADRs
- **cytochrome P450 gene family** (phase I enzyme) – many polymorphic variants – large gene family with nearly 60 members
- drug metabolism genotypes: polymorphisms in drug biotransformation enzymes
 - impaired ability to effectively metabolize drugs – inactivating polymorphisms
 - increased drug bioavailability - increased risk for side effects – increased toxicity
 - enhanced drug metabolism – activating polymorphisms – reduced drug efficacy
- phase II enzyme polymorphisms: examples: NAT and TPMT
- polymorphisms in genes encoding the site of drug action (e.g. receptors, enzymes, ion channels, etc.)
 - reduced or enhanced efficacy and/or toxicity
- polymorphisms in metabolizing enzymes + site of drug action = increased probability for variability: efficacy and toxicity

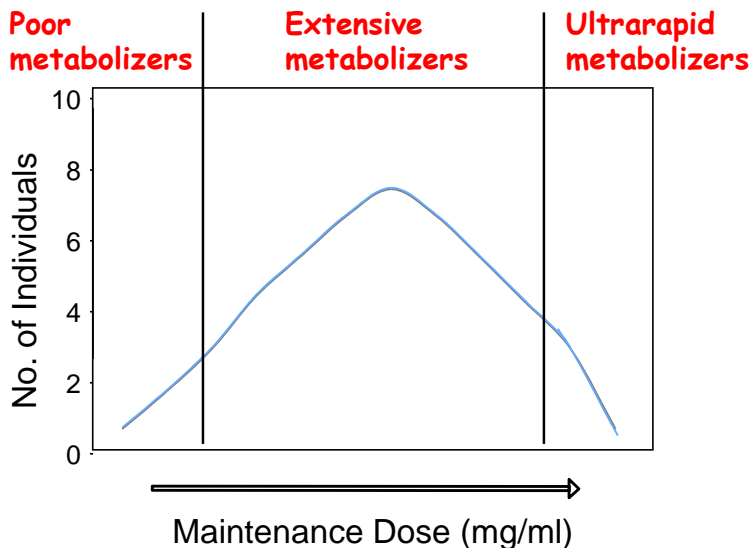

Figure 1. Population Distribution. Number of individuals for a given maintenance dose of drug required to achieve therapeutic efficacy.

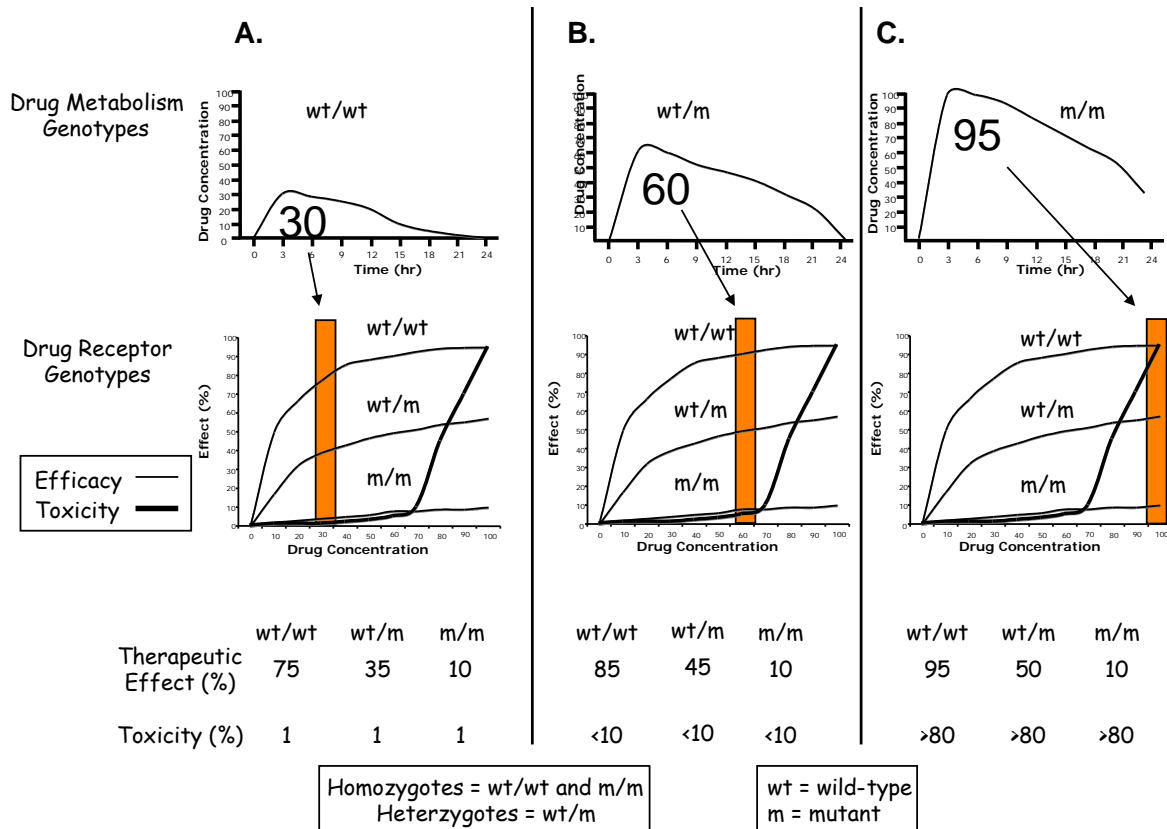

Figure 2. Consequences of polymorphisms affecting drug metabolism and receptor targets on drug action. Drug effects (therapeutic and toxic effects) may ultimately be determined by polymorphisms in drug metabolizing enzymes and/or polymorphisms at the site of drug action (eg. receptor). Genetically regulated heterogeneity in drug effects are due to genetic polymorphisms of drug exposure (drug metabolism) and/or genetic polymorphisms of drug sensitivity (site of drug action).

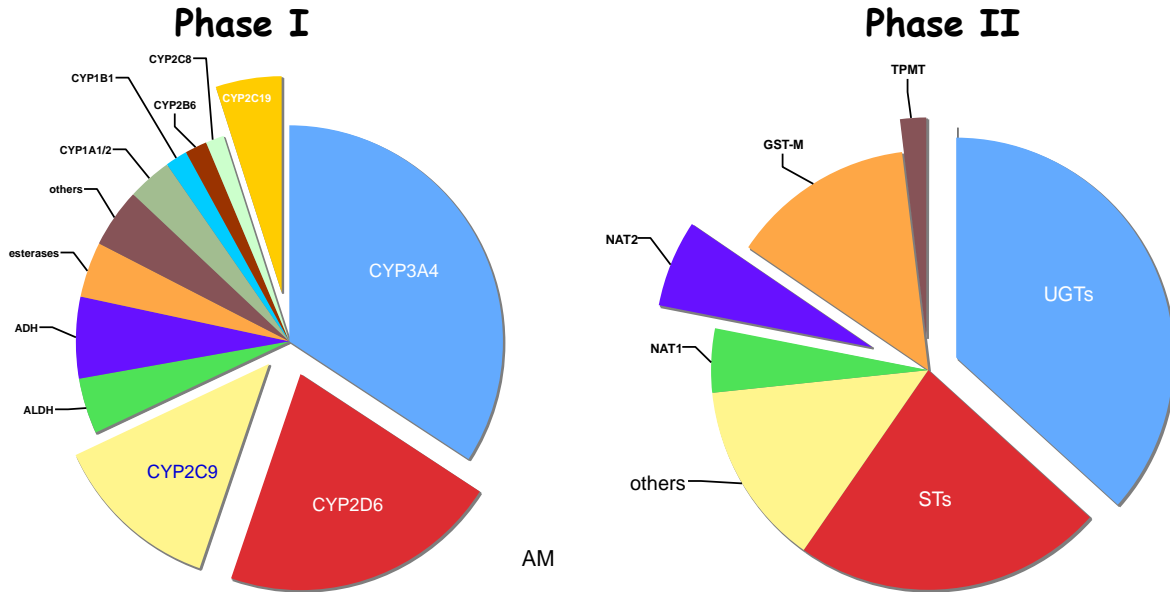

Figure 3. Fraction of all drugs associated with metabolism by any particular enzyme belonging to phase I and phase II type reaction. The relative size of each section serves to illustrate the fraction that each of the phase I and phase II enzymes contributes to drug metabolism. Polymorphisms that contribute to altered drug metabolism are indicated by sections that are separated from the pie chart. Phase I enzymes are responsible for modification of functional groups on drugs and phase II enzymes are responsible for conjugation reactions. Specific examples are discussed below. ADH, alcohol dehydrogenase; ALDH, aldehyde dehydrogenase; CYP, cytochrome P450; DPD, dihydropyrimidine dehydrogenase; GST, glutathione *S*-transferase; NAT, *N*-acetyltransferase; STs, sulfotransferases; TPMT, thiopurine methyltransferase; UGTs, uridine 5'-triphosphate glucuronosyltransferases.

SELECT EXAMPLES OF SPECIFIC SLOW METABOLIZING POLYMORPHISMS:

CYP2D6:

phase I enzyme – metabolizes 20 - 25% of all drugs

- first discovered to affect the metabolism of debrisoquine and sparteine
- other classes of drugs include **anti-depressants (Tricyclics), anti-arrhythmics, beta-blockers, neuroleptics**
- inactive in 2-10% of the population
- enhanced toxicity to drugs that are metabolized by this enzyme
- Roche Diagnostics - DNA sequence microarray - pharmacogenomic profiling of CYP2D6

CYP2C9:

phase I enzyme - metabolizes ~ 15% of all drugs

- 40% of Caucasian population carry defective alleles

- Examples: **tolbutamide, warfarin, phenytoin and nonsteroidal anti-inflammatories**
- **warfarin** - anticoagulant - used to prevent clotting after a heart attack, stroke or major surgery – highly variable responses among individual – danger for excessive bleeding
- CYP2C9 alleles account for 10% of warfarin variability
- other variability factors – site of drug action
- **vitamin K epoxide reductase (VKORC1)** – key warfarin target – clotting factor
- 25% of warfarin variability due to VKORC1

CYP2C19:

Phase I enzyme - metabolizes \approx 5% of all drugs

Common inactive allele: CYP2C19*2

Incidence: \sim 24% of white population has one CYP2C19* allele

\sim 33% of African American population has one copy

\sim 54% of Asian population has one copy

Homozygote mutant \approx 1%

Drug associated ADRs:

Clopidogrel (Plavix) - prodrug converted to active metabolite

Patients with two CYP2C19*2 alleles are unresponsive to this drug

N-Acetyltransferase 2 (NAT2):

phase II enzyme

- inactive in small percentage of general population; Caucasian population makes up 50% of slow acetylator phenotype
- slow acetylator phenotype – poor conjugation
- two mutant alleles identified – represent \sim 90% of the slow acetylator phenotypes
- identified by restriction-fragment length polymorphisms
- danger – increased toxicity
 - Examples: isoniazid - peripheral neuropathy
 - hydalazine - lupus
 - sulfonamide - hypersensitivity reactions

Many more specific examples can be found at the web site: www.pharmgkb.org. At this site, type of drug, disease, phenotype or enzyme with links to information about pharmacogenomic variation.

II. IDENTIFYING CAUSES OF DISEASE

A. GENOMICS: the study of the genomes of organisms

- facilitated by completion of human genome - human genome project

- Possible because of technological advances (e.g. sequencing, cloning, bioinformatics, etc.)
- markers identified - SNP map: mapping disease loci easier once family identified and identifying genes near disease loci much easier
- facilitates genome wide association studies
- most genes encoding proteins involved in molecular pathways identified - genes cloned and characterized
- preclinical testing - animal models → physiology/pathology for link to human disease

Many Diseases are directly linked to genetic polymorphisms or mutation

- environmental factors contribute (e.g. diet, age, lifestyle), but susceptibility is hereditary

i. directly hereditary diseases:

- Examples: Huntington's Chorea (autosomal dominant)
 Cystic fibrosis (autosomal recessive)

ii. environmentally dependent diseases

- genetic component - influenced by **genetic risk factors**
 - polymorphism or mutation in a particular gene or genes that increases the risk that a person will develop a disease if exposed to certain environmental conditions
- genetic association poorly understood
 - some contributing genes are known
 - regions on chromosomes have been identified
 - **susceptibility loci** - associated with disease

- Examples: Type II diabetes mellitus
 Parkinson's disease
 Hypertension – 50 different genes
 Alzheimer's disease (late-onset; Cholesterol genes – ApoE)
 Cancer

B. Pharmacogenomic Therapies RECOMBINANT PROTEINS:

- researchers have identified many useful therapeutic targets
- not all molecular targets are amenable to classical pharmacological intervention (i.e. design of small molecule therapeutics)
- with recombinant DNA technology and protein expression advances peptide hormones can now be routinely synthesized in the laboratory in mass production
- recombinant protein hormones used as therapeutic agents
- limitation - delivery

Example: **Epogen® (erythropoietin)** - used to treat chronic kidney failure on dialysis

- stimulates production of red blood cells
- contraindicated in patients with uncontrolled hypertension
- caveat: delivery

III. Designing clinical trials: PharmacoGenomics and Drug Approval

- DNA technology advances - human genome project – identify disease causing gene
- many potential targets have been identified
- drug development costs hundreds of millions of dollars and many years in pre-clinical studies
 - new small molecules identified in screen of compound libraries
 - additional tests to assess potency and efficacy - *in vitro* assays
 - "hits" tested in various animal models: *in vivo* potency and efficacy
 - safety concerns - drug kinetics (e.g. metabolism) and toxicology (e.g. ADRs)
 - final test molecules in humans – clinical trials
 - o **Phase I**
 - human subjects
 - healthy volunteers – small sample size - usually healthy volunteers
 - safety profile and dosage levels → pharmacokinetic analysis
 - o **Phase IIA**
 - drug tested for desired clinical effect
 - safety concerns are examined
 - relatively small sample size (100 patients)
 - costly: millions of dollars.
 - o **Phase IIB**
 - further efficacy and dose ranging are examined
 - larger sample size
 - o **Phase III**
 - very large sample size – hundreds - thousands of individuals
 - cost: tens of millions of dollars
 - could take years before the drug is marketed as a medicine to treat patients
 - o **Phase IV**
 - Post marketing follow-up – adverse events –
advantage: potentially large sample size

PharmacoGenomics and clinical trials

- use pharmacogenetic data to determine who would be good responders
- smaller clinical trials, less time to complete, reduce cost
- get medicines to patients faster
- reduce number of failed trials - focused clinical trials - **greater chance of obtaining statistically significant results with reduced side-effects**

Example: lapatinib

- small molecule inhibitor of EGFR and HER2 receptor tyrosine kinases
- used to treat specific cancers
- phase I trial revealed 16 of 107 individuals had diarrhea and/or skin rash - not considered severe to treat cancer
- mainly metabolized by CYP3A4 and CYP3A5; some metabolized by CYP2C19
- DNA microarray of the genes encoding these enzymes revealed association of diarrhea and rash with CYP2C19*2 genotype
- 3 subjects had severe reaction; had to discontinue trial

- take home message: perform trial using lower dose in order for patients to tolerate drug

Translation into clinical practice:

pharmacogenomics - applied to already marketed drugs

- improve safety and efficacy – **“personalized medicines”**
- **Example:** hydralazine
 - an "old" anti-hypertensive drug that fell out of favor due to availability of newer drugs
 - metabolized by N-acetyltransferase 2 (NAT-2)
 - recent study revealed that hydralazine may be useful in African Americans
 - often prescribed in favor of newer medicines

Caveats:

- unknown why African Americans respond well to hydralazine
 - many factors (genetic, environment) contribute to hypertension/cardiovascular disease
- beware of adverse drug responses
 - causes excessive excretion of vitamin B6, which may lead to vitamin B6 deficiency and neuropathies;
 - in some patients it may lead to niacin deficiency and to pellagra, a rash with rough looking skin

IV. Treating Specific Diseases: Identifying New Therapeutic Targets

DNA tests that have been used for analysis of patient samples:

PCR – DNA amplification - polymerase chain reaction

- commercially synthesized DNA primers are used to amplify specific genes or mRNA
- useful for rapidly and accurately screening small number of genes or mRNA
- readily allows for identification of mutations - deletions and insertions
- may be coupled with DNA sequencing analyses
- ideal for detecting leukemias caused by chromosomal rearrangements and viral infections

FISH – fluorescent *in situ* hybridization - identify gene location on chromosome - useful for detecting amplifications, translocations

- fluorescently labeled DNA probes are hybridized to human chromosomes to identify particular genes that might be in the wrong place, or might be amplified
- useful for rapidly and accurately screening tissue samples to identify gene translocations or amplifications

Targeted Therapeutics

A. Therapeutics based on the molecular identification of disease

- targeted therapy – target specific gene or gene product

- advantage: fewer side effects than were previously seen with broader spectrum therapeutics
- Example: FISH is used at Loyola to examine two different genes:

Example 1: Her2-Neu - human epidermal growth factor receptor 2.

- elevated in 25 – 30% of breast cancer patients
- FISH analysis used to identify gene amplification
- patients with Her2 amplification are treated with **Herceptin[®] (trastuzumab)**
- humanized monoclonal antibody directed against Her2
 - used to treat metastatic breast cancer in patients who show HER2/Neu amplification/overexpression
 - slows disease progression and improves survival
 - used in combination with other chemotherapy agents
 - increases risk of congestive heart failure (HER2 expressed in heart)

Example 2: Bcr – Abl:

- formed by translocation between chromosomes 9q34 and 22q11
- cause of chronic myelogenous leukemia (CML)
- abnormal karyotype showing a chromosomal rearrangement due to a translocation designated **t(9;22)**
- one chromosome 9 longer than normal and one chromosome 22 shorter than normal
- **Philadelphia chromosome** (Ph) – short chromosome 22
- recombinant DNA techniques - exact location where the translocation occurs is known
- translocation leads to the fusion of two genes, *bcr1* and *abl* (*abl* encodes is a non-receptor tyrosine kinase)
- new protein formed: Bcr-Abl fusion protein
- protein kinase: constitutive protein kinase activity
 - phosphorylates several cytoplasmic substrates, activating signal transduction cascades that control growth and differentiation
- **Gleevec[®] (imatinib)** - inhibits **Bcr-Abl tyrosine kinase**
 - reduces proliferation and activates apoptosis in the cancerous white blood cells associated with CML

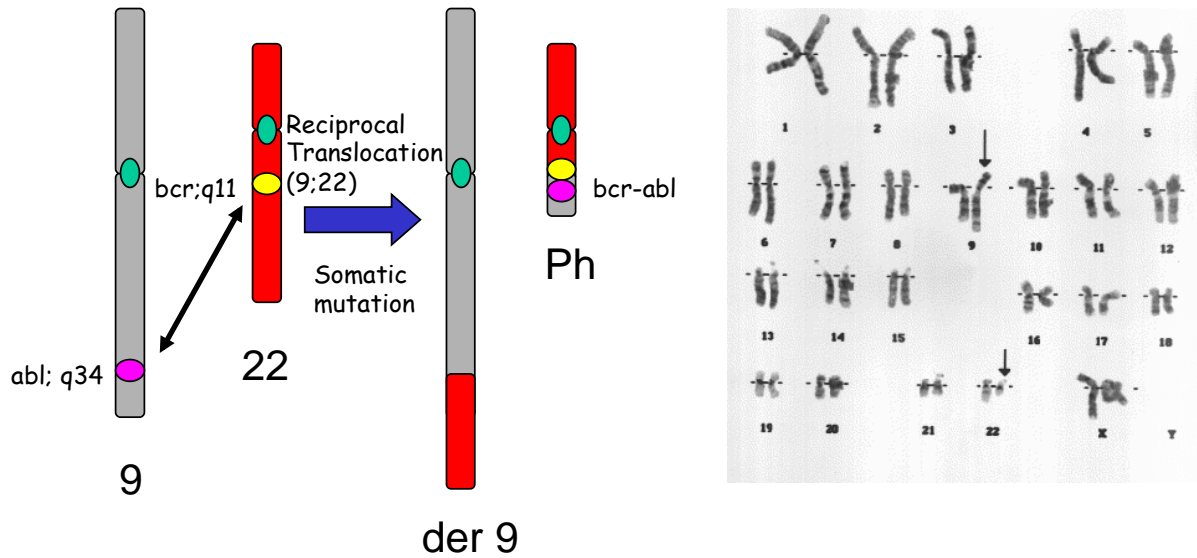

Figure 4. The Bcr-Abl translocation that produces the 'Philadelphia' Chromosome. **Schematic representation of metaphase spread chromosomes. A reciprocal translocation between chromosome 9 and chromosome 22 results in an extra-long chromosome 9 and a shorter chromosome 22 containing the new fused abl-bcr gene. By Adriano Marchese 2010 Loyola University Chicago.**

References:

WE Evans and MV Relling (1999). Pharmacogenomics: Translating functional genomics into rational therapeutics. *Science* 286: 487-491.

AD Roses (2004). Pharmacogenetics and drug development: The path to safer and more effective drugs. *Nature Rev Genetics* 5: 645-656.

UA Meyer (2004). Pharmacogenetics – five decades of therapeutic lessons from genetic diversity. *Nature Rev Genetics* 5: 669-676.

SD Undevia, G Gomez-Abuin and MJ Ratain (2005). Pharmacokinetic variability of anticancer agents. *Nature Rev Cancer* 5: 447-458.

MJ Rieder, AP Reiner, BF Gage, DA Nickerson, CS Eby, HL McLeod, DK Blough, KE Thummel, DL Veenstra and AE Rettie (2005). Effect of VKORC1 haplotypes on transcriptional regulation and warfarin dose. *N Engl J Med* 352:2285-2293.

KA Phillips, et al., Potential role of pharmacogenomics in reducing adverse drug reactions: a systematic review. *JAMA*. 2001 Nov 14;286(18):2270-9

FS Collins and VA McKusick, Implications of the Human Genome Project for medical science. *JAMA*. 2001 Feb 7;285(5):540-4.

AD Roses, Pharmacogenetics and future drug development and delivery. *Lancet*. 2000 Apr 15;355(9212):1358-61.

- Yauch, R. L., Dijkgraaf, G. J., Alicke, B., Januario, T., Ahn, C. P., Holcomb, T., Pujara, K., Stinson, J., Callahan, C. A., Tang, T., Bazan, J. F., Kan, Z., Seshagiri, S., Hann, C. L., Gould, S. E., Low, J. A., Rudin, C. M., de Sauvage, F. J., 2009. Smoothed mutation confers resistance to a Hedgehog pathway inhibitor in medulloblastoma. *Science*. 326, 572-4. PMID: 19726788
- Rudin, C. M., Hann, C. L., Laterra, J., Yauch, R. L., Callahan, C. A., Fu, L., Holcomb, T., Stinson, J., Gould, S. E., Coleman, B., LoRusso, P. M., Von Hoff, D. D., de Sauvage, F. J., Low, J. A., 2009. Treatment of medulloblastoma with hedgehog pathway inhibitor GDC-0449. *N Engl J Med*. 361, 1173-8. PMID: 19726761

DRUG TOXICITY

Key concepts and learning Objectives:

1. Understand the concept of toxicology and know what causes drug toxicity.
2. Understand how to distinguish between toxicity due to on-target, off-target or idiosyncratic effects.
3. Know how drug interactions occur and be able to explain their distinctive features.
4. Understand the concepts and various examples from lecture and handout of organ and tissue toxicity.
5. Understand the classification of drug interactions.
6. Know how drugs can cause organ and tissue damage and know the physiological consequences.
7. Understand teratogenesis and know the classification into pregnancy categories.

DRUG TOXICITY

Toxicology is the science of poisons or poisoning

- poison is any substance, that has the capacity to harm a living organism
- every drug has the potential to harm

Drug toxicity – physiological response to drug is an adverse effect

law of unintended consequences = side effects (adverse effects or toxic effects)

I. Mechanism of Drug Toxicity

Cause of drug toxicity due to the following factors:

1. MECHANISM OF DRUG ACTION – pharmacological toxicity
2. SIZE OF DRUG DOSE
3. CHARACTERISTICS AND HEALTH STATUS OF PATIENT

A. On-target effects

1. adverse effect may be an exaggeration of the desired pharmacological action, such as observed in drug overdose
 - e.g. CNS depression is predictable in dose-dependent fashion
 - progression of clinically effects go from anxiolysis to sedation to somnolence to coma
2. duration of exposure can impact toxicity
 - e.g. tardive dyskinesia, an extrapyramidal motor disorder associated with use of antipsychotic medications, may be dependent upon duration of exposure

B. Off-target effects

1. drug designed to bind to target A for therapeutic efficacy, but also binds to target B leading to toxicity
 - e.g. antihistamine terfenadine – H₁ antagonist – therapeutic site
 - also binds to hERG (human subunit of I_{Kr} potassium channels; ether-à-go-go-related gene) and inhibits potassium currents
 - increase in heart-rate corrected QTc interval
 - can lead to cardiac arrhythmias, including *torsades de pointes* and sudden death
 - all new drug candidates tested for binding to hERG *in vitro* and if drug makes it to clinical trial evaluated for ability to prolong QT interval in individuals
2. enantiomers (mirror image isomers)
 - lock – key: drug receptors sensitive to 3-dimensional structure of drugs
 - e.g. thalidomide
 - racemic mixture of [R] and [S] enantiomers
 - used to treat morning sickness in pregnant women

- [R]-enantiomer effective sedative
- [S]-enantiomer potent teratogen that led to birth defects
 - amelia – absence of limbs
- 10, 000 newborns affected – but not in US because not approved by FDA
- enantiomers are NOW evaluated by FDA as separate entities

3. Unintended activation of different receptor subtypes

- drugs non-selectively target receptor subtypes
- e.g. β -blockers
- cardiac β_1 -adrenergic receptors control heart rate and myocardial contractility
 - β_2 -adrenergic receptors expressed in smooth muscle cells in airways and vasculature
 - activation leads to relaxation and dilation of these tissues
 - β -blockers (β_1 -antagonists) often prescribed to control heart rate and reduce myocardial oxygen demand in patients with angina or heart failure
 - not all are selective for β_1 AR and can target β_2 AR
 - β_2 AR blockade will lead to bronchoconstriction
 - non-selective β -blockers are contraindicated in asthmatics

C. Idiosyncratic toxicity

- toxicity that is unpredictable and mechanism is unknown
- not observed in preclinical and clinical testing
-

II. Drug-drug interactions

1. Interaction of absorption

- A drug may cause increase or decrease in absorption of a second drug from the intestinal lumen

2. Interaction with protein binding

- drugs can be highly protein bound in the plasma – remember that it's the free drug that produces the clinical effect
- binding sites can become saturated in physiological states that lead to hypoalbuminemia, or when displaced from plasma proteins by other drugs, and toxicity can result

3. Interaction of metabolism

- drug can influence the metabolism of another drug – especially notable with hepatic cytochrome P450s
- e.g. example **ethanol**: metabolized mainly ADH (alcohol dehydrogenase) but some is metabolized by CYP2E1 - it also induces the expression of CYP2E1 at the transcriptional level
- this impacts the metabolism of common over-the-counter drug **acetaminophen** (used as an analgesic and to treat fever)

- acetaminophen is primarily metabolized in phase II reactions: glucuronidation and sulfation reactions
- a small amount is metabolized by CYP2E1 to **N-acteyl-*p*-benzoquinoneimine (NAPQI)**
- NAPQI is toxic, but is rapidly conjugated with glutathione to a non-toxic metabolite that is easily excreted when normal doses of acetaminophen are taken
- glutathione can be easily depleted and NAPQI can accumulate - NAPQI is highly reactive and can form protein adducts leading to cell death - i.e. liver damage
- of CYP2E1 by approximately 22% (NB: chronic alcohol consumption leads to high
- alcohol consumption (e.g. 6 cans of beer with 6-7 hr period) can induce expression levels of CYP2E1)
- this will lead to increased production of NAPQI if acetaminophen is taken at this time - increased risk of toxicity
- acetaminophen overdose is common and a common cause of liver failure (35% of all liver failure cases)
- alcohol, at least in part, is also metabolized by CYP2E1 and thus can competitively inhibit acetaminophen metabolism and be protective if consumed at the same time or shortly after taking an acetaminophen dose

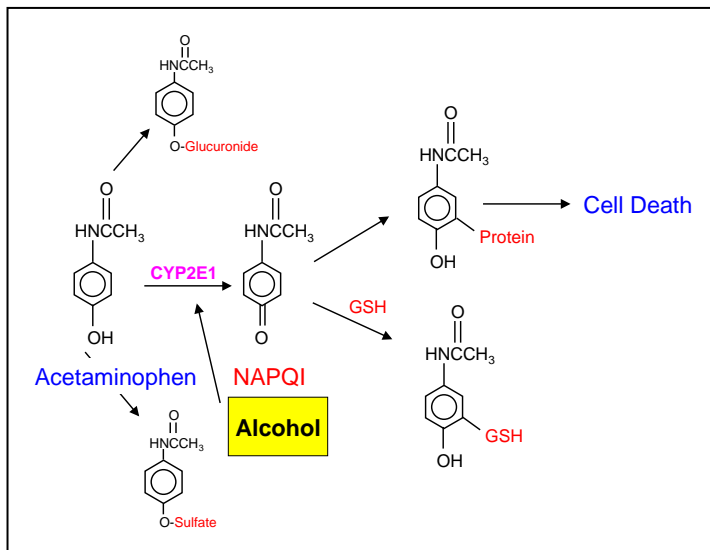

Figure 1. Mechanism of acetaminophen overdose.

4. Interaction of receptor binding

antagonists, for example, can be used to block action of agonist drugs

5. Interaction of therapeutic action

Aspirin blocks platelet activation and heparin is an anticoagulant; given together may increase risk of bleeding

Classification of various drug interactions:

Additive – combined effect of two drugs equals sum of effect of each drug given alone

Synergistic – combined effect exceeds the sum of effects of each drug given alone

Potentiation – creation of a toxic effect from one drug due to presence of another drug

Antagonism – interference of one drug with the action of another

Function or physiological antagonism – two drugs have opposite effect on the same physiological function

Chemical antagonism – chemical reaction between two drugs to neutralize their effects – chelation therapy

Dispositional antagonism – alter absorption/distribution/excretion (i.e. disposition) so that less drug gets to site of action

Receptor antagonism – block drug binding to receptor with another drug

III. ORGAN AND TISSUE TOXICITY

A. IMMUNOTOXICITY

Toxicity of some drugs and drug classes can be due to stimulating the immune system

- immune reaction classed into type I – IV
- syndromes that mimic some features of the immune response
- skin rashes (eruptions)

- drugs can cause immunotoxicity and compromise of immune system and have secondary effects leading to increased risk of infection

i. Type I hypersensitivity response

- immediate hypersensitivity or anaphylaxis
- due to antigen-binding IgE on mast cells
- antigen may be foreign protein or endogenous protein modified by hapten
- manifest as wheal-and-flare reaction in the skin; hay-fever like symptoms may develop in upper respiratory tract; asthmatic bronchoconstriction may occur in lower respiratory tract

ii. Type II hypersensitivity response

- antibody-dependent cytotoxic hypersensitivity
- drugs bind to cells – usually red blood cells and is recognized by IgG
- IgG binding triggers cell lysis
- Rare: can be caused by penicillin and quinidine

iii. Type III hypersensitivity response

- immune complex mediated hypersensitivity
- usually occurs when IgG or IgM form against soluble antigens
- antigen-antibody complexes are deposited in tissues such as kidney, joints and lung vascular endothelium

- complexes activate leukocytes and complement in tissue – cause serum sickness, leading to damage

iv. Type IV hypersensitivity response

- due to activation of T_H1 and cytotoxic T cells
- presents as contact dermatitis
- first exposure not a problem; second dermal exposure could activate T cells that go to skin
- examples: reaction to poison ivy

v. Autoimmunity

- immune cells attack own cells
- some drugs can induce lupus-like syndrome

vi. Red man syndrome

- drugs acting directly on mast cells, causing cell to degranulate
- linked to i.v. infusion of drugs (e.g. antibiotic vancomycin)
- not caused by IgE
- like type I response: cutaneous wheals and urticarial to neck, arms, upper trunk
- can proceed to angioedema and hypotension in rare cases
- cause is linked to infusion rate; can give antihistamines prophylactically

vii. Skin rashes

- somewhat common
- erythema multiforme
 - can be severe and life-threatening: severe rashes known as Stevens-Johnson syndrome and toxic epidermal necrolysis
 - morphologic appearance of mucous membrane and skin inflammation, with the development of blisters and separation of the epidermis from the dermis

viii. Immunotoxicity

- immune system can be targeted indirectly
 - cancer drugs are designed to target or kill proliferating neoplastic cells but will damage the cells in the bone marrow, lymphoid tissues, intestines and hair follicles at therapeutic doses
 - typically, safety margin is low with cancer drugs; always risk to damage normal tissues
 - increased risk of infection if white blood cells are compromised
- immune system can be targeted directly, especially if immune response needs to be dampened
 - inhaled corticosteroids used to treat patients with frequent and severe exacerbations of chronic obstructive pulmonary disease – can damage white blood cells – reduces overall inflammatory response – may lead to infections

B. DRUG-INDUCED LIVER TOXICITY

- most drug are metabolized in the liver

- some drug metabolites can be toxic to the liver
 - example: acetaminophen over dose can lead to glutathione depletion, which can lead to accumulation of toxic metabolite NAPQI – this metabolite can attach to cellular and mitochondrial proteins resulting in necrosis of hepatocytes
 - N-acetylcysteine can be used as an antidote if given within 10 hrs of overdosing
 - acetaminophen overdosing accounts for over 50% of acute liver failure in US per year
- idiosyncratic hepatotoxicity – mechanism unknown – drugs have to be removed from market
 - troglitazone (insulin sensitizing agent) removed from market when discovered that 1 in 10,000 patients taking drug died from acute liver failure – large sample size key to revealing toxicity

C. DRUG-INDUCED RENAL TOXICITY

- many drugs and their metabolites are eliminated from the kidney
- nephrotoxicity can lead to changes in renal hemodynamics, tubular damage, and obstruction, glomerular nephropathy or interstitial nephritis
- progressive renal failure will occur as a result of loss of nephron function
- certain antibiotics, NSAIDs, may cause renal failure
 - Example: gentamicin – aminoglycoside antibiotic
 - renal toxicity may be due to its inhibition of lysosomal hydrolases in proximal tubules
 - due to renal phospholipidosis - lysosome structural changes occur; contain undegraded phospholipids; lysosomes burst; cells die by necrosis; may be reversible by stopping treatment

D. DRUG-INDUCED NEUROTOXICITY

- mainly caused by certain anti-cancer drugs
- associated with peripheral nerves, but CNS can be affected too
- peripheral neuropathy has been linked to vinca alkaloids (e.g. vincristine, vinblastine), taxanes (e.g. paclitaxel) and platinum compounds (e.g. cisplatin)
 - vinca alkaloids and taxanes work by disrupting microtubules, thereby altering axonal trafficking in motor and sensory neurons, which explain why they cause peripheral neuropathies

E. DRUG-INDUCED SKELETAL MUSCLE TOXICITY

- drug class that cause skeletal muscle injury include statins, corticosteroids and zidovudine
- statins affect geranyl-geranylation of muscle proteins – likely cause of muscle damage
- corticosteroids affect many cellular processes which can impact muscle growth/structure - reversible
- zidovudine – used to treat HIV- HIV can cause myopathy – drug causes myopathy in preclinical trials – mechanism leading to myopathy unknown

F. DRUG-INDUCED CARDIOVASCULAR TOXICITY

- can be divided into three major class
 1. many drugs interact with cardiac potassium channels to cause QTc prolongation
 2. drugs can directly act on myocytes and lead to toxicity
 3. some drugs are toxic to heart valves

F. DRUG-INDUCED PULMONARY TOXICITY

- injury can be acute and reversible exacerbations of asthmatic symptoms or chronic injury due to remodeling and/or fibrosis
- beta-agonists can cause reversible obstruction of airways
- chronic injury has been linked to bleomycin (chemotherapeutic agent) and amiodarone (antiarrhythmic)
- repeated insult to lung epithelial cells lining conducting airways and alveoli may be followed by regeneration
- repeated cycles of epithelial injury can lead to fibrosis where excessive collagen is deposited into alveolar space leading to loss of function

G. CARCINOGENESIS DUE TO DRUG THERAPY

- drugs can damage DNA – leading to uncontrolled growth – carcinogenesis is a complex process that can take years to develop – drugs that cause DNA damage are avoided
- but to treat neoplasias – DNA damaging drugs are used
- these drugs can affect blood cell progenitors and cause myeloid dysplasia and/or acute myeloid leukemia (AML) – 10-20% of AML in US caused by such anticancer drugs

H. TERATOGENESIS DUE TO DRUG THERAPY

- drugs given to pregnant women can adversely affect fetus
- teratogenesis is the induction of structural defects in the fetus caused by a teratogen
- maternal absorption, distribution, metabolism and excretion will dictate drug exposure to fetus
- Drugs can be classed into pregnancy categories
 - Category A – well controlled studies in women in which risk to fetus in first trimester has not been observed and no evidence of risk throughout pregnancy
 - Category B – no risk observed in preclinical studies, but no studies in women have been done
 - Category C – risk observed in preclinical studies, but no studies have been done in women, but benefit may outweigh risk
 - Category D – some evidence of risk to women, but benefit may outweigh risk
 - Category X – clear evidence of risk to fetus, but risk clearly outweighs risk

SUGGESTED READING

Brunton, L., Chabner, B. and Knollman, B. Goodman and Gilman's The Pharmacological Basis of Therapeutics. 12th Edition, Chapter 4, Drug Toxicity and Poisoning. Pg. 73-82.

#9 - PHARMACODYNAMICS I: DRUG - RECEPTOR INTERACTIONS

Date: August 13, 2013 – 8:30 a.m.

Reading Assignment: Katzung 11th Edition, Chapter 1, pp. 1-8 & Chapter 2.

KEY CONCEPTS AND LEARNING OBJECTIVES

1. You should understand the pharmacological characteristics of receptors and how receptors differ from drug binding sites.
2. You should understand the non-linear nature of the relationship between drug dose (or concentration) and receptor occupation and know that for any drug, the fraction of a receptor population occupied by a drug will be dependent only on the drug concentration and its affinity and for the receptor.
3. You should understand the concept of drug selectivity and that it is based on the drugs relative affinities for different receptors.
4. You should know the difference between the potency and the maximal efficacy of a drug and that the clinical effectiveness is dependent on its maximal efficacy.
4. You should understand the pharmacological characteristics of full agonists, partial agonists, neutral antagonists and negative antagonists (inverse agonists).
5. You should know the difference between competitive and non-competitive antagonists and how each will affect the dose-response curve in receptor systems with or without spare receptors.
6. You should know that the therapeutic consequences of administering a full agonist together with a partial agonist that acts via the same receptor results in an attenuation of the effects of the full agonist.
7. You should understand the concept of pharmacological antagonism and the different non-pharmacological means to antagonize a drug's effect.
8. You should understand the concept of spare receptors (aka receptor reserve), how it can be experimentally demonstrated, how it may be reflected in the shape of the dose-response curve and the therapeutic consequences with respect to response.
9. You should understand the difference between graded and quantal dose response relationships and the specific information that each type of curve can provide.

#9 - PHARMACODYNAMICS I: DRUG-RECEPTOR INTERACTIONS

I. INTRODUCTION

Overview of Main Phases in Drug Action

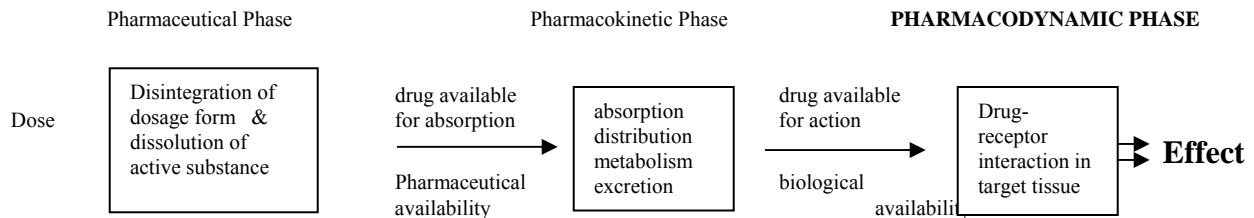

Adapted from: T.P. Kenakin, Analysis of Drug Receptor Interactions, 1987

A. DRUG - defined as any substance that affects living processes

- most, but not all, drugs produce their effects by interacting with specific receptors
- biologic responses to drugs are graded. Increasing the dose increases the effects
- their biologic effects, which can be therapeutic or toxic, depends on the drug, dose and "selectivity"

Drug Nomenclature: A drug is often referred to by a name that reflects its most prominent site of action or clinical effect, although it may interact with many other receptors within a given dose range. This "label" attached to a drug often determines how the drug is used or sometimes misused. Remember...

****Drug interactions with a receptor or receptors are dictated by the drug's chemical and structural properties, not by the name ascribed to it by humans.***

Chemical forces involved in drug binding include:

1. Electrostatic forces
2. Hydrogen Bonding
3. Van der Waals Forces (at closer distances)
4. Hydrophobic bonds

****Most Drug Receptor Interactions are REVERSIBLE**

Most Drug Binding Interactions DO NOT form Covalent Bonds

The reversible interaction (i.e. binding) of a drug with a receptor can be thought of as a dynamic equilibrium process. That is, the drug is either "on" or "off" the receptor at any point in time.

Implication: ***ANY DRUG CAN INTERACT ONLY WITH UNOCCUPIED ("FREE") RECEPTORS***

- Drug "displacement" does not generally occur in drug-receptor interactions

B. RECEPTORS versus "BINDING SITES"

RECEPTOR - any component that is "receptive" to interacting with drugs or endogenous substances and is **capable of initiating a subsequent response**

BINDING SITES- "receptive" components that can interact with (or "bind" to) substances but are not capable of initiating any subsequent response are often referred to as "acceptor" sites or "binding" sites. (e.g. albumin and α_1 acid glycoprotein).

RECEPTOR SYSTEMS - The receptor is only the first step in the transfer of drug "information" to the system. This is shown in the figure below.

DRUG + RECEPTOR
(Discriminator)

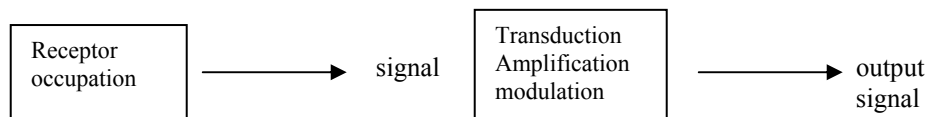

Main steps in the pharmacodynamic phase of action.

II. **RELATIONSHIP BETWEEN DRUG CONCENTRATION AND RECEPTOR OCCUPATION**

The principles that apply to the binding of drugs to receptors are similar to those that govern chemical reactions and are analogous to the parameters observed in enzyme kinetics. Let's see how:

Briefly: $D + R \rightleftharpoons DR$ $D =$ free drug
 $R =$ free receptors
 $DR =$ drug-receptor complex

The rate of formation of DR complex with time is:

$$d[DR]/dt = k_1 [D][R]$$

and the rate of breakdown of the DR complex with time is:

$$-d[DR]/dt = k_2 [DR]$$

At equilibrium, these two rates are equal.

Therefore:

$$k_1 [D][R] = k_2 [DR] \quad \text{or} \quad k_2/k_1 = \frac{[D][R]}{[DR]}$$

The term k_2/k_1 is the

K_D (i.e., the equilibrium dissociation or affinity constant)

This K_D value of a drug for a given receptor reflects the propensity of a drug to bind to that receptor. This propensity to interact with a receptor (i.e., form [DR]) is referred to as the drug's affinity for the receptor and it is typically expressed by the K_D value for a given receptor. Consequently, if a drug has a high affinity for a receptor, [DR] will be large. From the above equation, if [DR] is large, the value of K_D will be small.

Thus, for any drug, **the K_D value and affinity are inversely related**.

Also, the K_D value for any drug is the concentration of that drug that will occupy 50% of a receptor population (see eqn below).

You (yes, I mean YOU) can determine the fraction of any receptor population that will be occupied by any concentration of any drug by using the simple **Receptor Fractional Occupancy Equation (shown below)**

$$\text{Fractional Occ.} = \frac{1}{1 + \frac{K_D}{[D]}}$$

Thus, for any drug, the FRACTION of a receptor population that it will occupy will depend ONLY on it's: (1) *affinity* and (2) *concentration* (i.e. dose).

- Note that the fraction of receptors occupied by any drug will be independent of the number of receptors present in a tissue.
- However, the total number of receptors occupied by a drug will depend on both: (1) *fraction of the receptor population occupied* & (2) *the number of receptors in a given tissue*, (i.e., B_{max})

The magnitude of the RESPONSE will be some function (i.e. α) of the total number of receptors occupied.

$$\text{Response} = \alpha (\text{fractional occupancy}) (\text{Receptor } \#)$$

Relationship between Drug Dose (concentration) and Receptor Occupancy: Increasing dose will increase receptor occupation in a non-linear fashion over most of the dose range (fig. below).

As the concentration of a drug increases, the fraction of receptors occupied by the drug will increase from 1 - 91% over approximately 3 orders of magnitude (3 log units of drug concentration) about its K_D value, as shown in the figure below.

In the figure below, drug concentration is expressed as a function of its affinity (i.e. K_D units of concentration) so that the receptor occupation curve shown applies to any drug.

For example: if the K_D for a drug is 5nM, then a 5nM concentration of the drug could be expressed as $1K_D$ unit of concentration, 10nM would be $2K_D$ units, etc.

Non-Linear Occupation of Receptors

GB

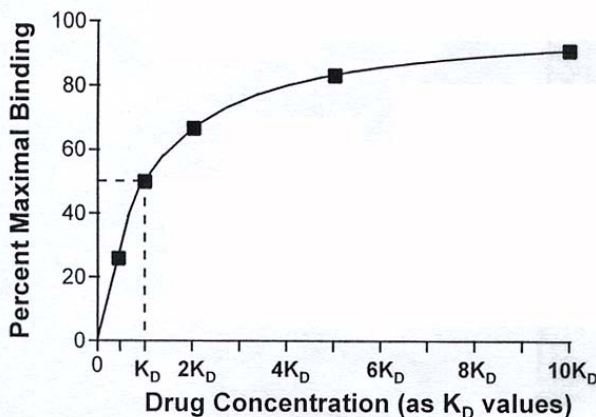

Conc. As K_D Units	Fractional Occupancy %
0.01	1
0.10	9
1.00	50
10.00	91
100.00	99

Drug Selectivity: Since most drugs have comparable affinity for a number of receptors, the selectivity of a drug refers to its ability to interact with one type of receptor versus other receptors. For any drug, *selectivity* will decrease as dose is increased. This is shown in the figure below:

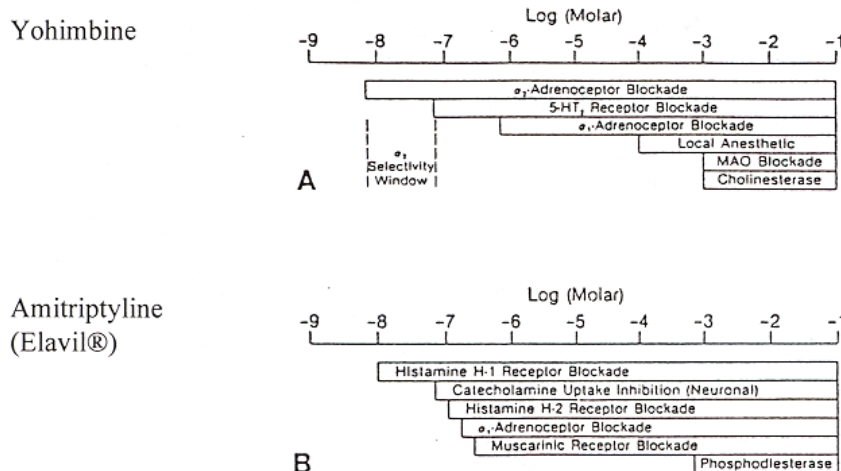

FIG. 1.1 The necessity for a procrustean approach to specificity. A: Yohimbine concentration ranges (on a logarithmic molar scale) necessary for activity for a series of autonomic receptors and functions. B: Similar data for amitriptyline.

Adapted from: T.P. Kenakin, *Pharmacological Analysis of Drug Receptor Interactions*, 1987

The “selectivity window” of a drug is dependent on the drug dose or concentration range employed. It can be difficult to obtain this range in vivo where numerous other factors are operative (e.g. drug distribution, metabolism, tissue receptor heterogeneity, etc.).

III. GRADED DOSE RESPONSE CURVES – The Relationship Between Drug **DOSE**, Receptor Occupation and the magnitude of the **RESPONSE**

The Dose-Response Relationship: *This is the correspondence between the amount of a drug and the magnitude of the effect produced.* The initial step in producing any effect is the binding (i.e. interaction) of a drug with a receptor.

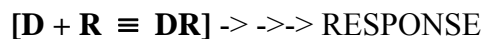

Simple Occupancy Theory – predicts that there is a one to one relationship between receptor occupation and response. Thus:

- 1) the magnitude of the pharmacological effect is linearly proportional to the number of receptors occupied by the drug
- 2) the maximum response is obtained only when all receptors are occupied.

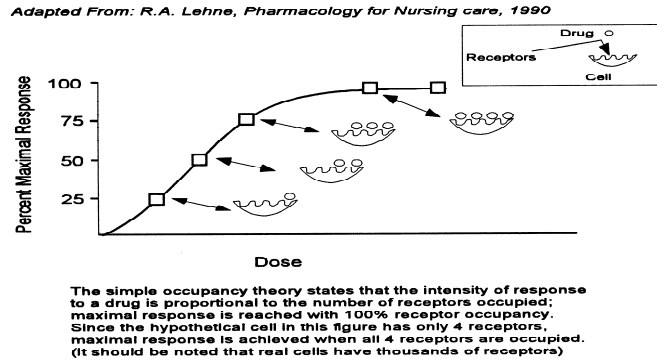

Modified Occupancy Theory - Expansion of simple occupancy theory to account for experimental findings that could not be explained by the original theory. Thus:

1. The response of a drug was some positive function of receptor occupancy (i.e., not necessarily linearly proportional to the percent of receptors occupied).
2. Maximum effects could be produced by an agonist occupying only a small proportion of receptors.
3. Different drugs may have varying capacities to initiate a response.

These findings resulted in the concepts of Drug Efficacy and Potency

Efficacy (a.k.a. maximal efficacy, intrinsic activity) - this can be determined directly from the graded dose-response curve and is the limit (or plateau) of the dose-response curve on the response axis

Thus: **Full** agonists would have an intrinsic activity = 1 **Partial** agonists would have an intrinsic activity < 1 and **Neutral Antagonists** that bind but produce no biologic effect would have an intrinsic activity of 0. **Negative Antagonists** (Inverse Agonists) reduce the response produced by constitutively active receptors (active in the absence of agonist) and have a negative intrinsic activity.

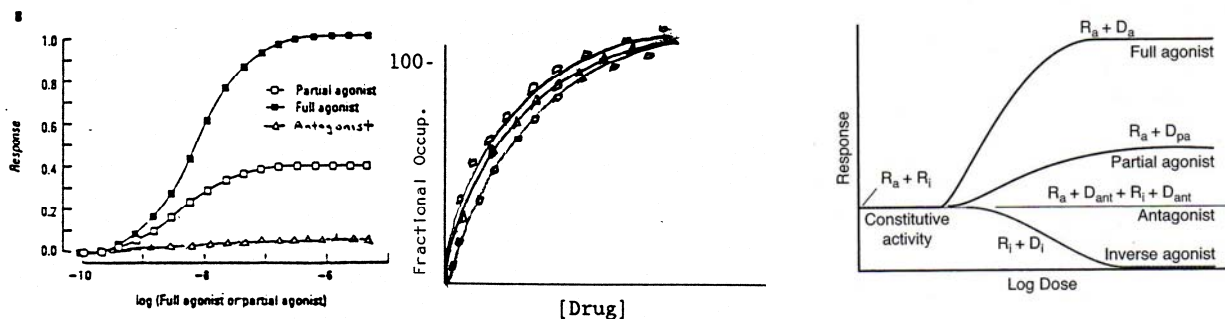

Modified from: R.R. Ruffolo, *J. Auton. Pharmacol.* 277-295, 1982; *Katzung's Basic & Clinical Pharmacology*, page 8, 11th ed, 2009.

Potency - refers to the concentration or dose of a drug necessary to produce 50% of that drug's maximal response and is expressed as an ED₅₀ value. The potency of a drug depends in part on: (1) its affinity for the receptor (i.e., its K_D value), and (2) the efficiency with which drug-receptor interaction is coupled to response.

THE CLINICAL EFFECTIVENESS OF A DRUG DEPENDS ON ITS MAXIMAL EFFICACY (E_{max}) NOT ON ITS POTENCY (ED₅₀).

Dose-Response Curves Demonstrating Efficacy and Potency

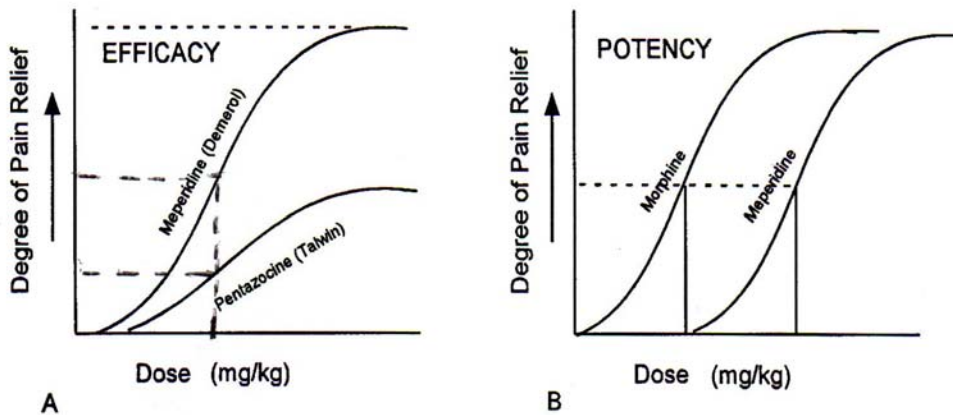

Adap. from: R.A. Lehne, *Pharmacology for Nursing Care*, 1990

Comparison of drugs differing in efficacy and potency

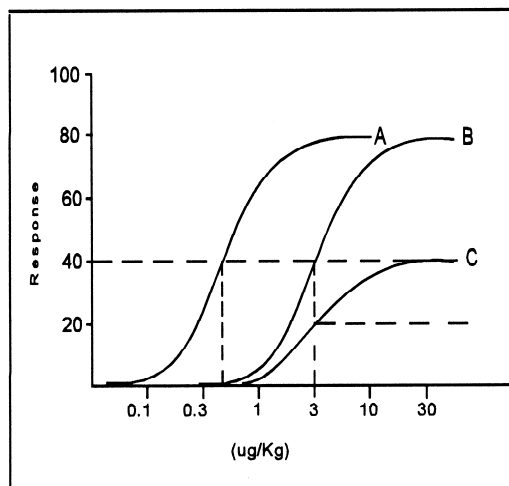

1. A is more potent than B and C.
2. A and B have equal efficacies.
3. B and C are equipotent but b is more efficacious than C.
4. A is more potent and more efficacious than C.

Adapted from: R.A. Lehne, *Pharmacology for Nursing Care*, 1990.

Spare Receptors (Receptor Reserve)

In most systems, a maximum response can be obtained using doses of agonists that occupied only a small percentage or fraction of receptors. Such a system is referred to as having “receptor reserve” or containing “*spare receptors*”.

Shape of Graded Dose Response Curve – sometimes provides information about spare receptors. If it takes 3 log units of concentration (dose) for a drug to occupy 91% of any receptor population yet a maximal response occurs over a more narrow dose range (e.g. < 3 log units), not all receptors need to be occupied to produce that maximal response (i.e. there are “spare receptors”).

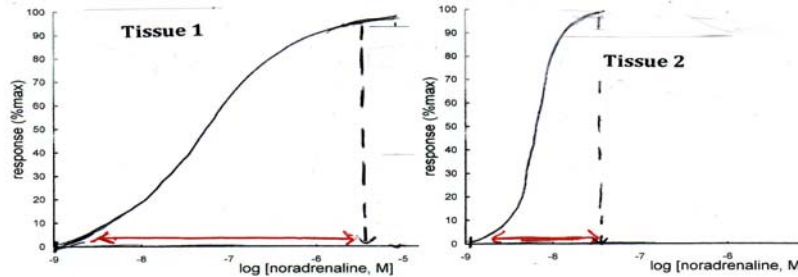

Note the difference in range of concentrations for the same agonist, noradrenaline, to produce an E_{max} response in Tissue 1 (> 3 log units) versus Tissue 2 (~1.5 log units). This large difference in DR range indicates large differences in receptor reserve (or spare receptors) for the same receptor in tissue 1 versus tissue 2. Smaller differences in receptor reserve may not be revealed by such obvious visual differences in the DR curves. (figure provided by GB)

Experimentally, spare receptors can be demonstrated using increasing concentrations of a non-competitive (irreversible) antagonist to eliminate an increasing number of the available receptors. Curve A is the effect of the agonist alone. Curves B - E show the effect of the same agonist in the same system with fewer and fewer receptors.

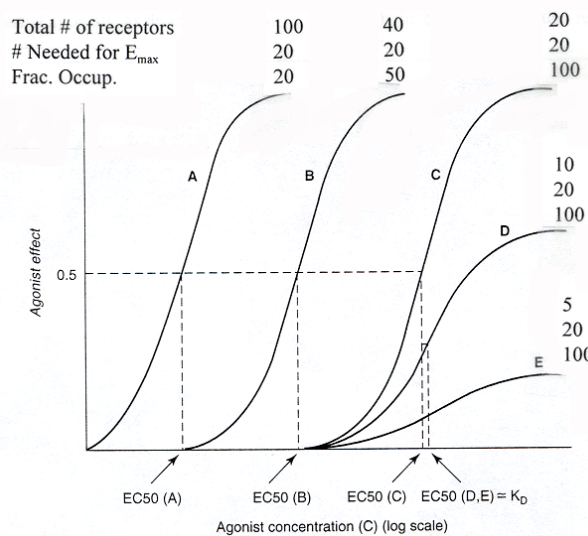

Modified from B.G. Katzung, ed. Basic and Clinical Pharmacology p14, 2004

ANTAGONISM OF DRUG EFFECTS

1. Pharmacological Antagonism

A. Competitive Antagonists: (*Surmountable* Antagonism)

Since an antagonist will "bind" but not elicit a response, higher concentration of agonist are required to occupy the same number of receptors to produce an equivalent response to that observed at lower concentrations in the absence of antagonist. Competitive antagonists will change the ED_{50} of the agonist for the receptor rather than reduce the maximal response (E_{max}).

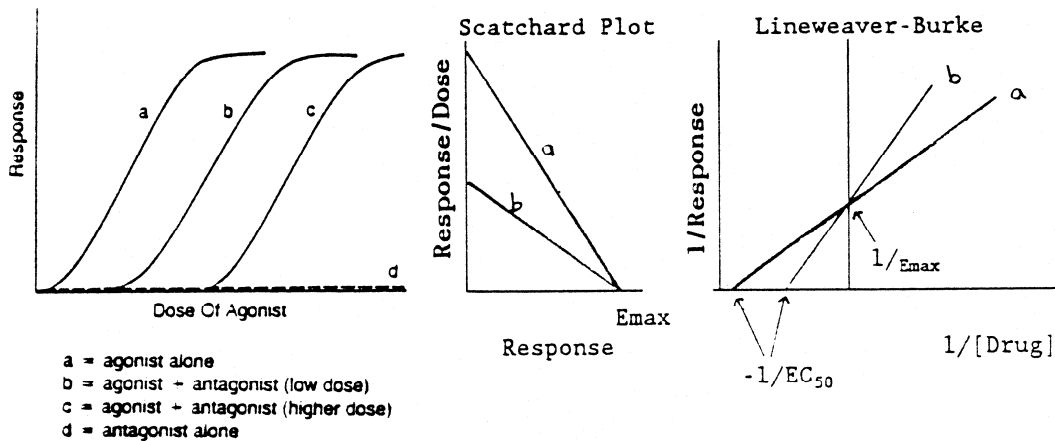

Modified from: R.A. Lehne, *Pharmacology for Nursing Care*, 1990

B. Non-Competitive Antagonists: (*Insurmountable* Antagonism)

Non-competitive antagonists bind to the receptor and cause a change in the receptor that effectively removes it from the sites available to interact with the drug (this process could be reversible or irreversible). Consequently, if there is no receptor reserve, there would be a decrease in the maximal response (E_{max}) due to the loss of available receptors to be activated. However, the remaining receptors would exhibit the same affinity (K_D) for the drug and thus the ED_{50} would not be altered.

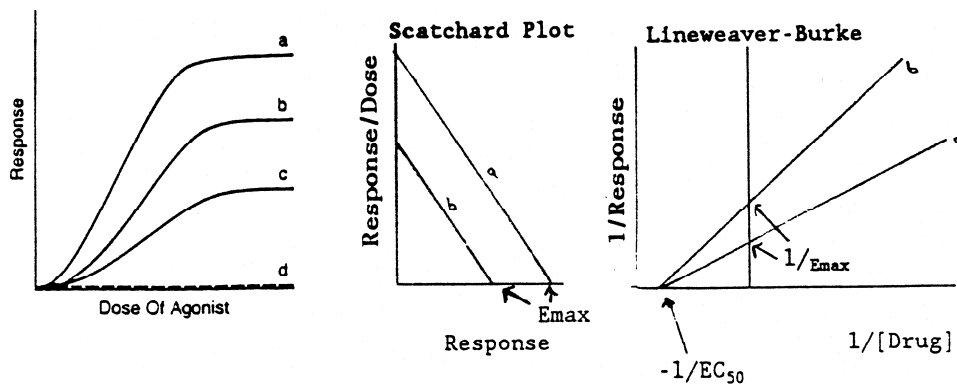

Modified from: R.A. Lehne, *Pharmacology for Nursing Care*, 1990

C. Antagonism by Partial Agonists

Since partial agonists can bind to the full complement of a receptor population but cannot produce the maximal response of full agonists, *they can reduce the maximal response of full agonists* when both drugs are administered together.

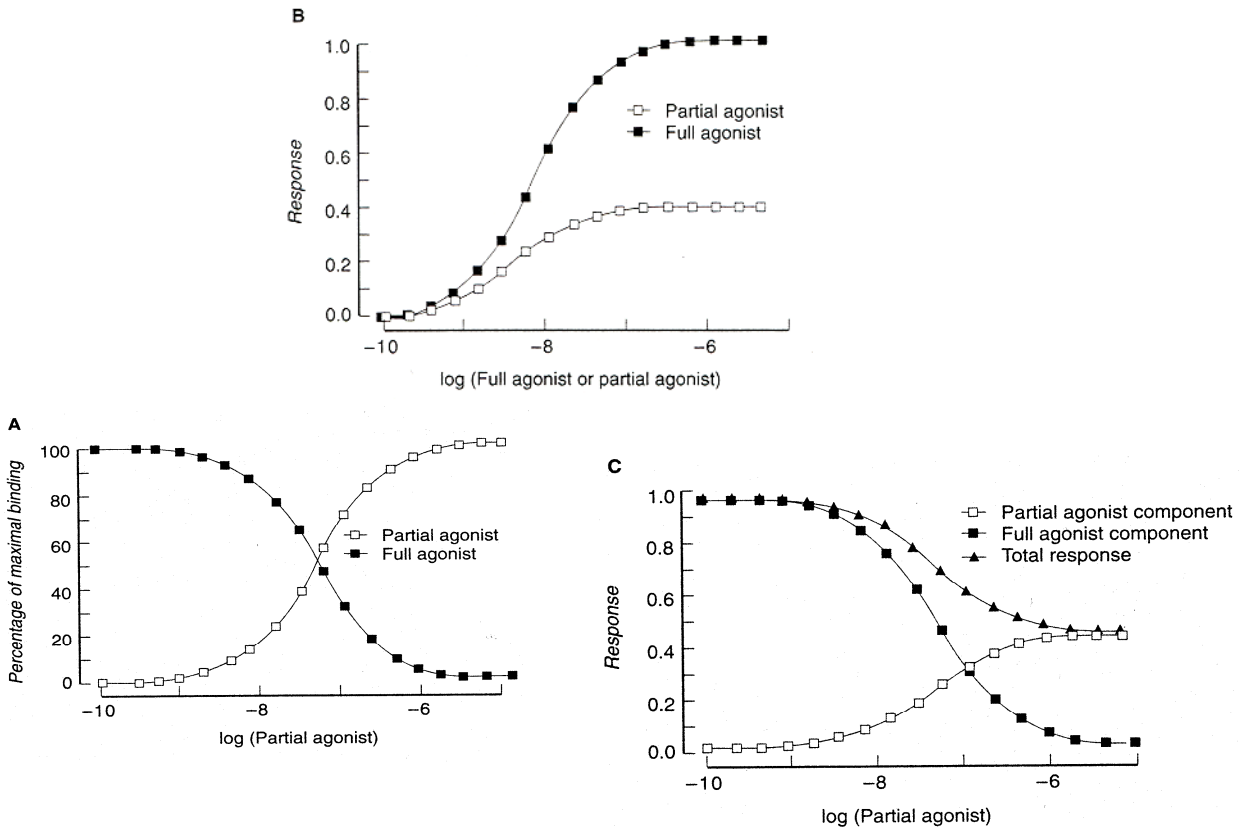

From: B.G. Katzung, ed., Basic and Clinical Pharmacology p 19, 2009

Other Types of Non- Pharmacological Antagonism

- Chemical antagonists- chemical inactivation of a drug
e.g., protamine (positively charged) inactivation of heparin (negatively charged)
- Physiologic antagonism- the use of opposing regulatory pathways to antagonize the effects of a drug. These effects are less specific and less easy to control than the effects of a receptor specific antagonist.

IV. **THE QUANTAL DOSE RESPONSE CURVE -the Relationship between Drug DOSE & a SPECIFIED EFFECT produced in a Patient or Animal Population**

Obtained from the cumulative frequency distribution of doses of drug required to produce a specified (i.e. quantal) effect in a large number of patients or experimental animals.

Can be used to obtain the median effective dose (ED_{50}). This is the dose at which 50% of individuals will exhibit a specified effect.

Can be used to obtain an index of the selectivity of a drug's actions by comparing its ED_{50} for different specified effects.

Can be used to determine the **therapeutic index**, representing some estimate of the safety of a drug. It is the ratio of the TD_{50} or LD_{50} to the ED_{50} determined from quantal dose response curves.

This is illustrated in the figures below:

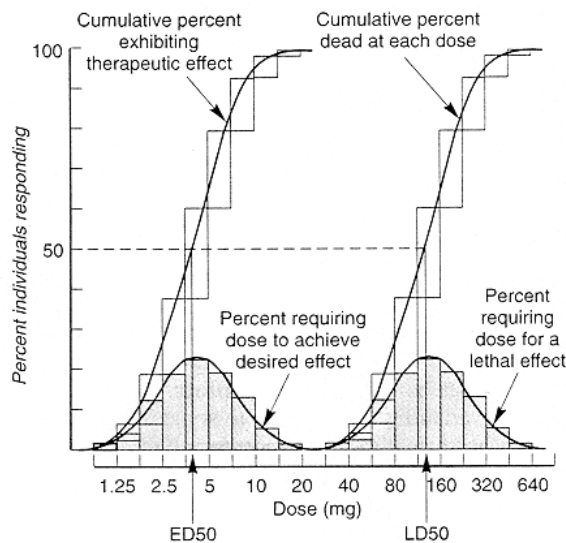

From: B.G. Katzung, ed.,

Pharmacology p 31, 2009

Basic and Clinical

Therapeutic window – the dosage range between the minimum effective therapeutic dose (or conc.) and the minimum toxic dose (or conc.). This is a more clinically relevant index of safety.

#10 - **PHARMACODYNAMICS II: DRUG-RECEPTOR INTERACTIONS**

Date: August 14, 2013 – 8:30 a.m.

Reading Assignment: Katzung 11th Edition, Chapter 1, pp. 1-8 & Chapter 2.

KEY CONCEPTS AND LEARNING OBJECTIVES

1. You should understand that receptors can exhibit stereospecificity for drugs, saturability and they are subject to regulation by physiological, pharmacological and pathological factors.
2. You should know that the response to a drug is dependent on factors such as the amount of drug reaching the receptor, the nature of the drug-receptor interaction and the functional status of the receptor and target cell.
3. You should understand the key aspects of the 5 major types of receptor signaling mechanisms, the conceptual similarities and differences and how they differ in response times.
3. You should understand the role of G proteins in signal transduction and the means by which amplification of signal transduction can occur.
4. You should understand the process by which guanine nucleotide regulatory proteins mediate the effects of a drug on the second messenger system.
5. You should understand the similarities and differences between the adenylyl cyclase and the phosphoinositide signal transduction systems.
6. You should understand the different means by which drugs can produce beneficial versus toxic effects and the different strategies that may be used to maximize the beneficial effects.
7. You should understand the concept of desensitization and know how it affects the agonist dose-response curve.
8. You should know difference between homologous and heterologous desensitization with respect to the mechanisms involved and the therapeutic consequences of the altered responsiveness to drugs.
9. You should understand the phenomenon of receptor supersensitivity, how it affects the dose response curve and that this can result in increased responsiveness to drugs or neurotransmitters.

#10 - PHARMACODYNAMICS II: DRUG-RECEPTOR INTERACTIONS

I. RECEPTORS - IMPORTANT GENERAL FEATURES

1. **Structural Specificity:** Receptors exhibit some degree of specificity for the drug molecule. The component of the receptor that "recognizes" and "binds" the drug is known as the receptor recognition site or pharmacophore.
2. **Stereospecificity:** Receptors generally exhibit stereospecificity for drugs containing asymmetric carbon atoms.

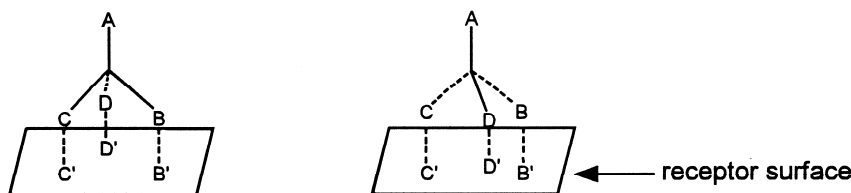

A pair of optical enantiomers showing the different patterns of projection of three functional groups onto a receptor surface

Adapted from: Goldstein, Aronow and Kalman, *Principles of Drug Action*, 2nd ed., 1974.

3. **Saturability:** Receptors exist in finite numbers and as such can be saturated by high concentrations (i.e. doses) of drug. Therefore, increasing the dose after saturating (occupying) all receptors will not increase its response any further.
4. **Response:** There will be some quantitative relationship between the magnitude of a pharmacological response and the number of receptors occupied.

The response to a drug depends on:

- (1) the amount of drug reaching its site of action (pharmacokinetic consideration)
 - (2) the drug-receptor interaction at that site
 - (3) the functional status of the receptor and/or target cell
5. **Regulation:** Receptors are dynamic entities that can be affected by physiological, pharmacological and pathological factors. (e.g. pharmacodynamic tolerance, supersensitivity, etc.)

II. TYPES OF DRUG RECEPTORS AND SIGNALING MECHANISMS

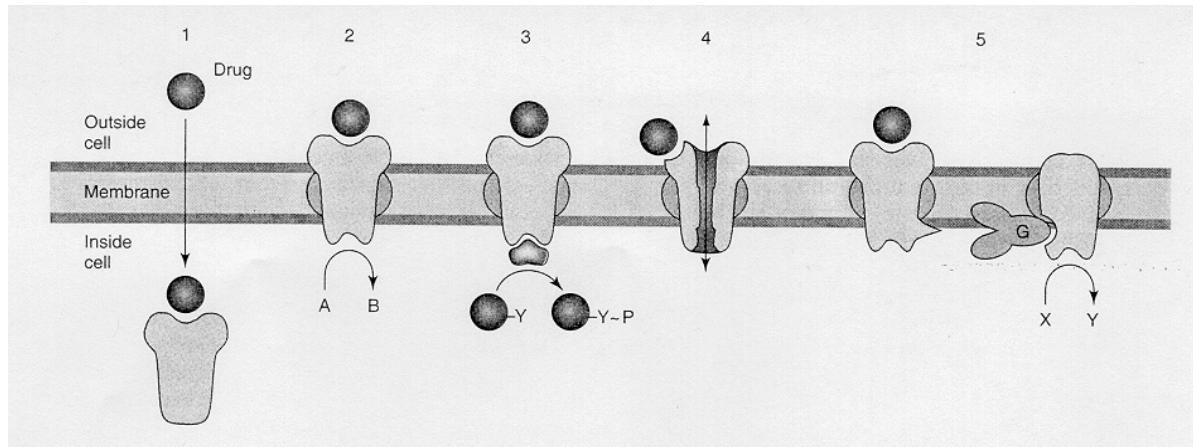

From: B.G. Katzung, ed. *Basic and Clinical Pharmacology*, page 25, 2009

A INTRACELLULAR RECEPTORS

These receptors are not bound to a membrane. They exist in the cytosol and can bind biologic compounds that are sufficiently lipid soluble to cross the plasma membrane.

The binding of the compound may:

- (1) stimulate an intracellular enzyme (e.g. soluble guanylyl cyclase) or
- (2) regulate cellular localization of the receptor and alter transcription of genes (e.g. the glucocorticoid receptor).

The latter receptors are considered "GENE ACTIVE" receptors since they bind to promoters to stimulate the transcription of genes in the nucleus.

Therapeutic Consequences of Gene Active Receptors

1. There is a lag period of 30 minutes to a few hours, the time required for new protein synthesis.
2. The effects of these agents can persist for hours or days after the agonist is no longer present.

Implication: The therapeutic or toxic effects of gene-active agents will decrease slowly. There is no simple temporal correlation between plasma hormone concentrations and effects.

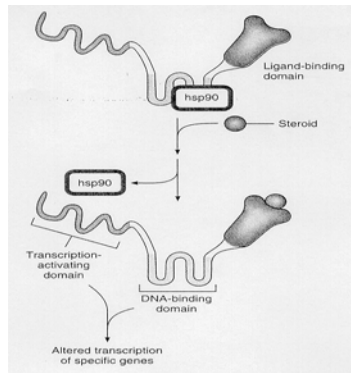

From: B.G. Katzung, ed. *Basic and Clinical Pharmacology*, page 22, 2009

B. PLASMA-MEMBRANE BOUND RECEPTORS

1. *Ligand-Regulated Transmembrane Enzymes Including Protein Tyrosine Kinase -*

Receptor polypeptides that cross the plasma membrane & consist of an extracellular hormone binding domain and a cytoplasmic enzyme domain. The enzymatic domain may be *tyrosine* or *serine kinase* or *guanylyl cyclase*. Drug binding initiates an allosteric activation of the cytoplasmic enzyme domain. Once activated, these receptors can phosphorylate downstream substrate proteins.

The autophosphorylation of tyrosine residues on the receptor's cytoplasmic domain can intensify or prolong the duration of activation of the receptor.

These types of receptors are subject to receptor down-regulation via endocytosis of receptors from the cell surface followed by degradation of the receptors and their bound ligand.

Examples of endogenous substances that utilize tyrosine kinase receptors are: insulin, epidermal growth factor (EDF), and platelet-derived growth factor (PDGF).

From: B.G. Katzung, ed. *Basic and Clinical Pharmacology*, page 23, 2009

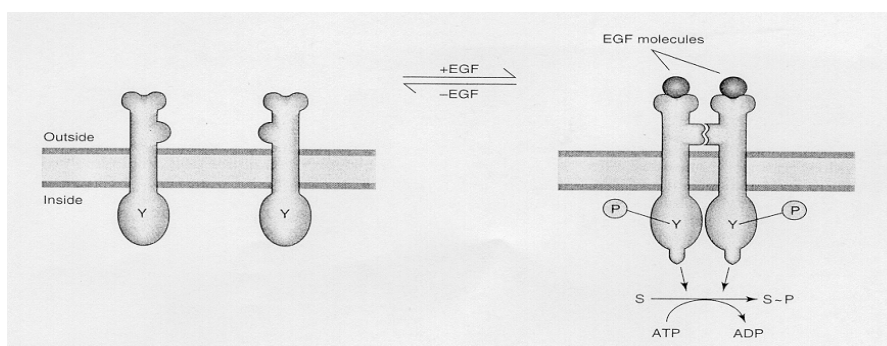

Cytokine Receptor Mechanism

- closely resembles receptor tyrosine kinase but utilizes a separate protein tyrosine kinase that binds non-covalently to the membrane.

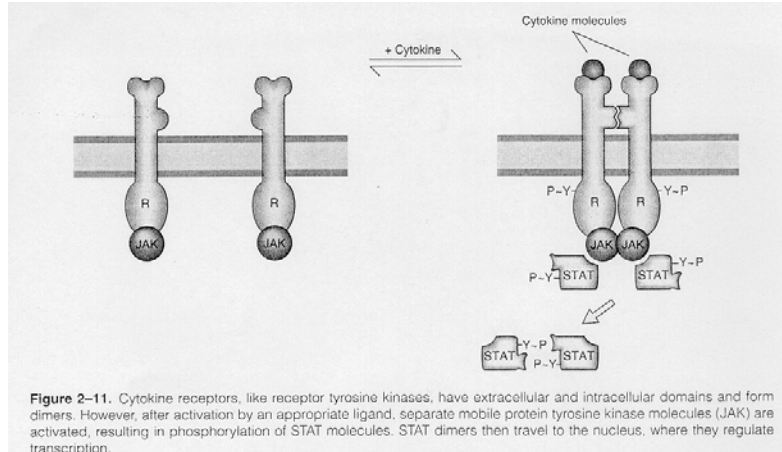

From Katzung, pg 24, 2009

2. Ligand Gated Channel Receptors - These receptors transmit their signals by increasing the flow of relevant ions and altering the electrical potential across the membrane. Examples of transmitters utilizing this mechanism include: (1) acetylcholine, (2) GABA and (3) the excitatory amino acids (e.g. glutamate, aspartate).

The Nicotinic Cholinergic Receptor (a prototypic channel receptor) - a pentamer composed of four types of glycoprotein subunits in the molar ratio $\alpha_2\beta\delta\gamma$. The homologous subunits form a cylindrical structure that contains a cation channel whose opening is regulated by acetylcholine binding. The α -subunits contain the binding sites for acetylcholine.

Acetylcholine binding produces a conformational change that results in the transient opening of a channel through which sodium ions can pass from the extracellular fluid into the cell.

Time between binding and response can be measured in milliseconds.

The rapidity of this signaling mechanism provides rapid information transfer across the synapse.

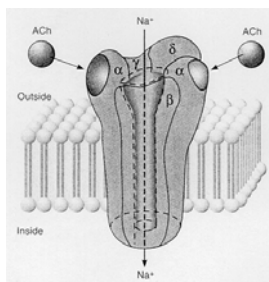

From: B.G. Katzung, ed. Basic and Clinical Pharmacology, page 24, 2009

3. G-Protein Family of Transmembrane Receptors:

Receptors coupled to guanine nucleotide regulatory proteins (G-proteins), comprise a structurally related family. The single polypeptide chain of these receptors traverse the plasma membrane 7 times. The *amino terminus* in the extracellular space and the *carboxy terminus* in the cytoplasm. The extracellular region contains the ligand or drug recognition site while the third intracellular loop of these receptors regulates the ability of the receptor to interact with specific G-proteins.

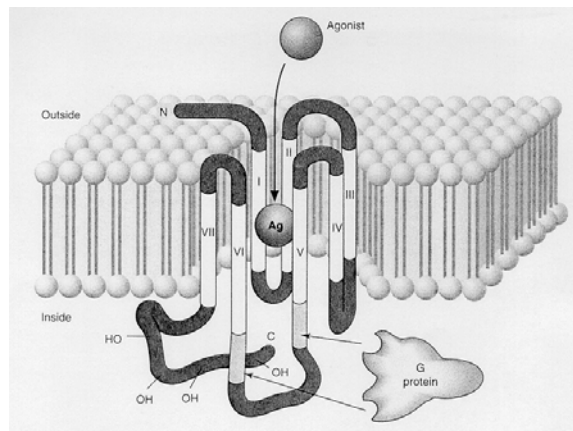

From: B.G. Katzung, ed *Basic and Clinical Pharmacology*, page 26, 2009

Guanine Nucleotide Regulatory Proteins (G-Proteins) - proteins that act as **intermediates** in the transfer of information between the receptor and the second messenger. They are composed of alpha, beta and gamma subunits that exist together as a trimer. Different G proteins mediate the stimulatory and inhibitory effects on adenylyl cyclase and the activation of phospholipase C. These G proteins are referred to as G_s, G_i and G_q and differ primarily in their alpha subunits (α_s and α_i and α_q , respectively).

Activation of G-Protein Coupled Receptors:

- a) Agonist binds to receptor and facilitates its association with a G-protein (i.e. formation of a ternary complex)
- b) Formation of the Ternary Complex facilitates the binding of GTP rather than GDP to the G-protein.
- c) Binding of GTP to the alpha subunit dissociates it from the beta-gamma subunits, receptor and agonist.
- d) The GTP-bound G-protein is the active intermediate which changes the activity of the effector component, usually an ion channel or enzyme such as adenylyl cyclase or phospholipase.
- e) The G-protein remains active until a GTPase converts GTP to GDP reforming the original non-reactive G-protein.

The separation of receptor activation from G-protein mediated activation of the effector facilitates amplification of the transduced signal.

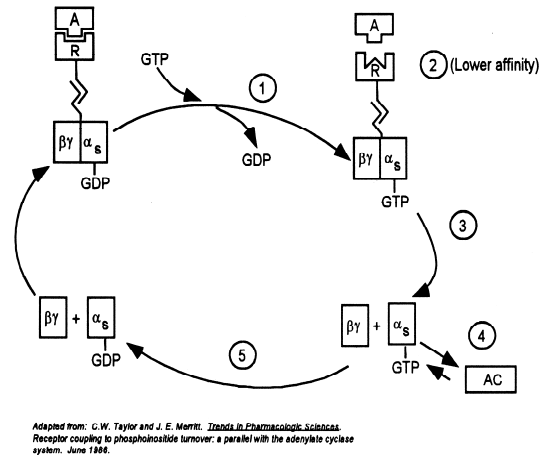

Two Well Established G-protein Signaling Pathways

Adenylyl Cyclase

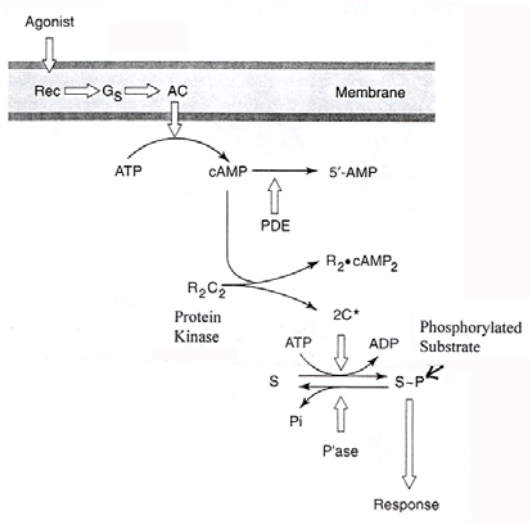

Phosphoinositide Hydrolysis

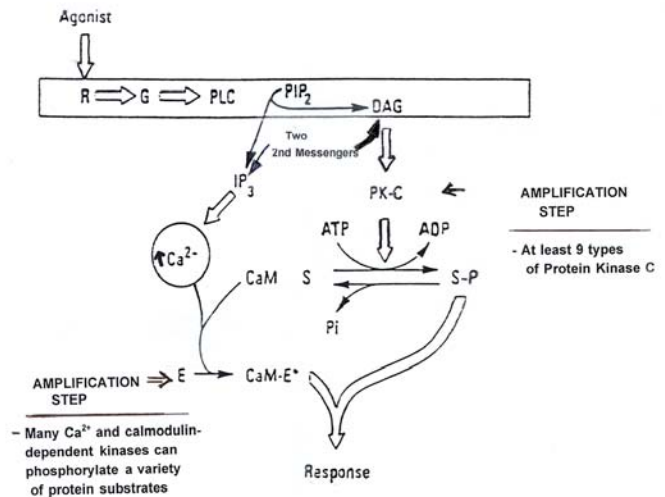

Modified from B.G. Katzung, ed., Basic and Clinical Pharmacology, page 28, 2009

Note that reversible phosphorylation is a common theme in these signaling mechanisms that provides for amplification (activation of multiple substrates) and flexible regulation (e.g. via cellular availability of particular kinases or kinase substrates).

Activation of Multiple Second Messengers

GB

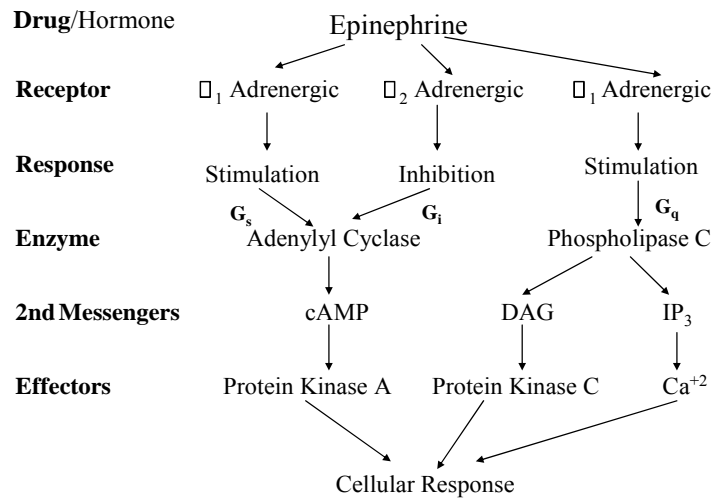

Beneficial Versus Toxic Effects of Drugs

Because no drug causes only a single specific effect, drugs are classified according to their PRINCIPAL action.

Since drugs are selective rather than specific in their actions, their selectivity can be considered with respect to two categories: *therapeutic* versus *toxic* effects.

The term "*side effect*" is often used to identify some toxic or unwanted effect of a drug.

Beneficial versus toxic effects of drugs may result via 3 different means.

1. Actions at the same receptor - direct pharmacologic extension of the therapeutic actions of the drug (e.g. excessive bleeding caused by anticoagulant therapy).

- toxicity may be minimized or prevented by careful management of dose and monitoring of effect, or by not administering the drug at all.

2. Actions at identical receptors but in different tissues or affecting different effector pathways - e.g. Glucocorticoid congeners used to treat asthma or inflammatory disorders can produce protein catabolism, psychosis, etc. (all mediated by similar or identical glucocorticoid receptors)

-3 strategies to avoid or mitigate these effects:

- a) administer the lowest dose that produces an acceptable benefit
- b) administer adjunctive drugs - may allow lowering the dose of the first drug
- c) limit the drugs effects to specific parts of the body (e.g. aerosol administration of a glucocorticoid to the bronchi)

3. Actions Mediated by Different Types of Receptors - minimize toxic or side effects by prescribing drugs with greater receptor selectivity (e.g. selective serotonin uptake blockers rather than tricyclic antidepressants)

These 3 possible relationships between beneficial versus toxic effects of a drug are shown below.

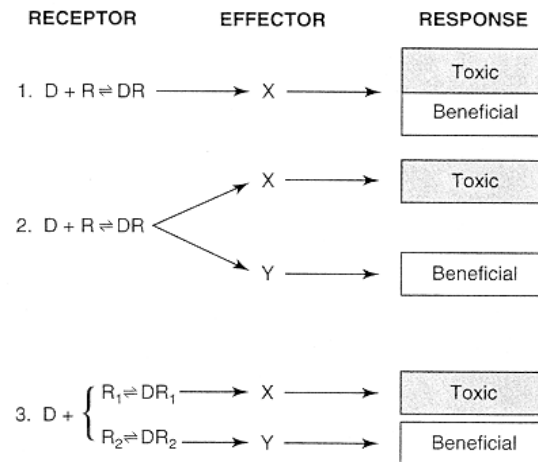

From: B.G. Katzung, ed. Basic and Clinical Pharmacology, 1998

III. VARIATION IN DRUG RESPONSIVENESS

Idiosyncratic drug response - an unusual response that is not frequently observed in the majority of patients.

Quantitative Variations in drug response - more common and more clinically important

- the intensity of effect for a given dose of a drug may be increased (*hyperreactive*) or diminished (*hyporeactive*) in comparison with the effect observed in most individuals.
- The intensity of response to a drug dose may change during the course of therapy.
- response may be decreased (desensitization) or increased (supersensitivity)

Reduced Responsiveness Upon Drug Exposure

Pharmacodynamic tolerance (Desensitization Phenomenon) - a decreased responsiveness to pharmacologic or hormonal stimulation that occurs slowly with time.

Tachyphylaxis - a term used to describe the rapid development of diminished responsiveness after administration of a drug.

These are general mechanisms of cellular adaptation that can markedly limit the therapeutic effectiveness of a number of drugs. Familiar examples include:

- the loss of bronchiodilating effects of β -adrenergic agonists in asthmatics;
- the decreased vasoconstricting response to α -adrenergic agonists used as decongestants.

Some Mechanisms Involved:

- 1) Agonist-induced phosphorylation of the activated receptor and binding of β -arrestin (readily reversible).
- 2) Receptor Down-Regulation - there is a loss of membrane bound receptors responsible for eliciting the response.
- 3) Post-Receptor Adaptations – receptors also may become functionally "uncoupled" from post receptor moieties due to functional modification of G-proteins and/or subsequent second messenger enzymes.
- 4) Agonist dose-response curves will be shifted to the right (\uparrow ED50) and Emax may be reduced if receptor reserve is exceeded.

Homologous Desensitization of β -Adrenergic Receptors

β -adrenergic receptors are phosphorylated via β -adrenergic receptor kinases (aka GRK2, GRK3) that functionally uncouple the receptors and can trigger their sequestration from the cell. There is a loss of activity only to agonists interacting with the modified receptor.

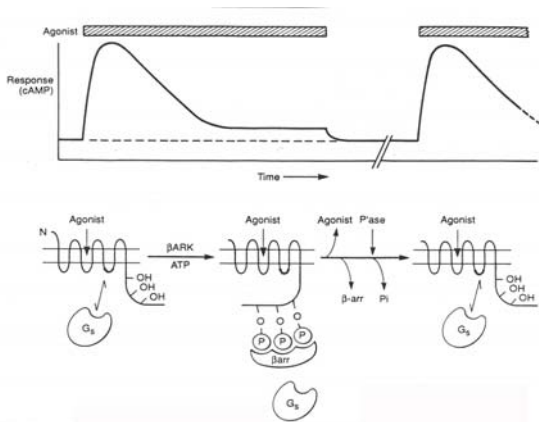

From Katzung, Basic and Clinical Pharmacology, page 21, 2009

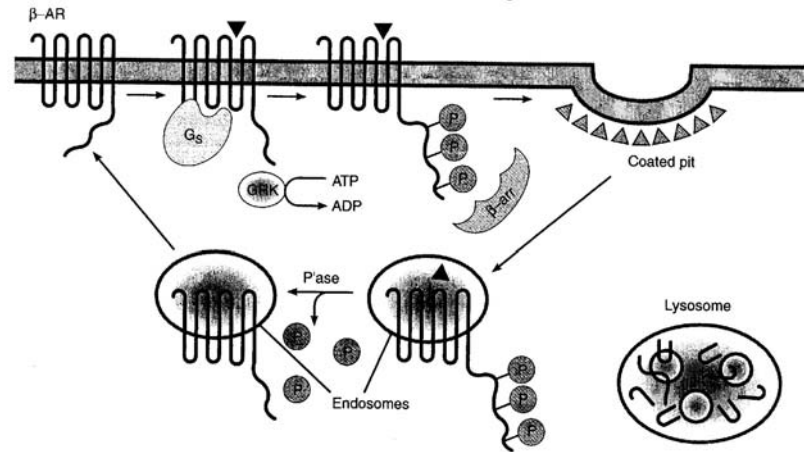

HOMOLOGOUS DESENSITIZATION (only the activated receptor affected)

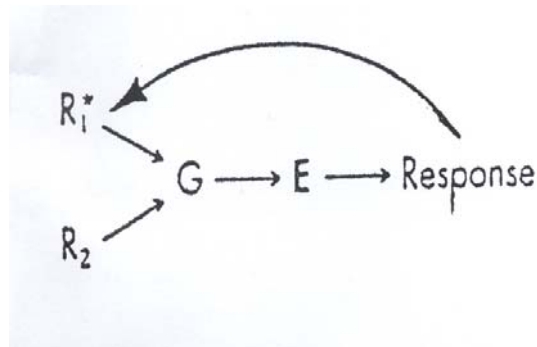

Modified from: The Pharmacological Basis of Therapeutics., 8th Ed., pg. 41, 2-5C. Goodman & Gilman, 1990.

Heterologous Desensitization: agonist activation of a single receptor subtype results in a decreased responsiveness of one or more other receptor subtypes (i.e. receptors that were not directly activated by the drug). Thus, drugs that produce heterologous desensitization will have more widespread effects in a system. This may be due to modification of receptors other than the specific type that was directly activated by the drug.

Several protein kinases seem to be capable of promoting phosphorylation of the receptors including: cAMP dependent protein kinase (PKA) and protein kinase C (PKC).

Receptor function is regulated by phosphorylation in the absence of receptor sequestration or down regulation. This modification serves to functionally uncouple these receptors and impair their interactions with guanine nucleotide regulatory proteins.

In addition, heterologous desensitization may be associated with functional modifications at post-receptor intermediate(s) in the effector pathway (e.g. guanine nucleotide regulatory proteins).

HETEROLOGOUS DESENSITIZATION (multiple receptors and signaling affected)

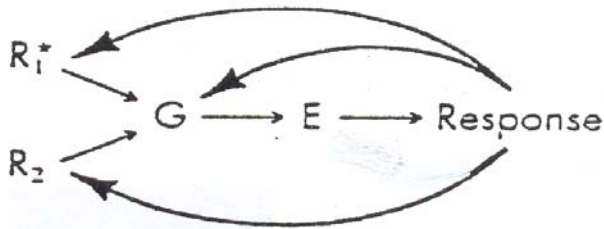

Modified from: The Pharmacological Basis of Therapeutics., 8th Ed., pg. 41, 2-5C. Goodman & Gilman,. 1990.

Increased Responsiveness to Drugs

Supersensitivity (aka “denervation supersensitivity”)

- a compensatory receptor mechanism in which the loss of hormonal activity on receptors leads to an increase in the number of receptors and/or an enhanced receptor-effector coupling.

Thus, any given dose or concentration of drug will produce a greater response than in the control situation. This results in a shift to the left in the agonist dose-response curve.

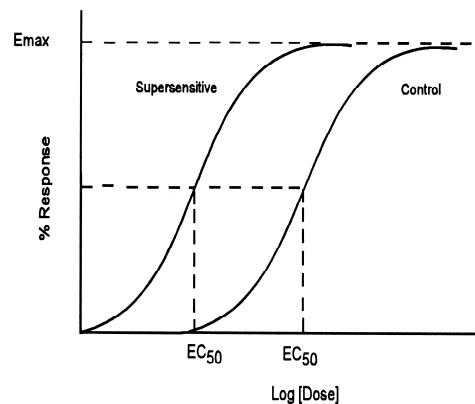

GB