

Keysight Technologies Phase Noise Measurement Solutions

Selection Guide

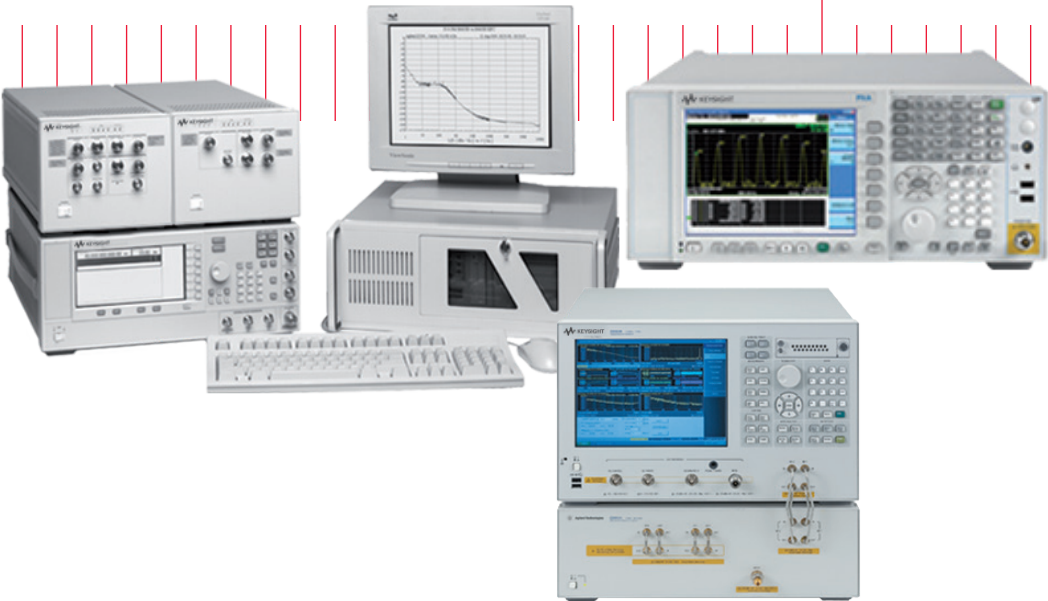

Table of Contents

Introduction.....	03
Finding the Best Fit for Your Test Requirement.....	03
Phase Noise Overview.....	03
Summary Comparison of Measurement Techniques.....	04
Primary Phase Noise Measurement Techniques.....	05
Direct spectrum technique.....	05
Phase detector techniques.....	06
Two-channel cross-correlation technique.....	11
Keysight's Phase Noise Measurement Solutions.....	12
Direct spectrum technique-based solutions.....	12
Phase detector technique:.....	14
Two-channel cross-correlation technique: E5052B signal source analyzer.....	18
Comparison of Keysight phase noise measurement solutions.....	21
Selecting the Right Phase Noise Solution.....	22
Additional Resources.....	23
Web Resources.....	23



Introduction

Finding the Best Fit for Your Test Requirement

Built upon 40 years of RF design and measurement experience, Keysight Technologies, Inc. continues to offer a wide range of the phase noise measurement solutions based on a variety of test and measurement techniques. However, finding the right solution can be a challenge.

This document will help guide you in selecting the solution that best fits your specific measurement requirements. More information about phase noise can be found in the Additional Resources section in the back of this document.

Phase Noise Overview

Phase noise is one of the most important figures of merit of a signal generating device and can well be a limiting factor in a mission-critical application in aerospace and defense, as well as in communications.

The basic concept of phase noise involves frequency stability, which is defined as the degree to which an oscillating source produces the same frequency throughout a specific period of time. Frequency stability consists of two components: long term and short term.

Long-term stability describes the frequency variations that occur over hours, days, months, or even years. By contrast, short-term frequency stability is about changes in the nominal carrier frequency of less than a few seconds duration. The focus of this document is on short-term frequency stability.

While there are many technical terms to quantify phase noise, one of the most commonly adopted measures is the "single side-band (SSB) phase noise", $\mathcal{L}(f)$. Mathematically, the US National Institute of Standard and Technology (NIST) defines $\mathcal{L}(f)$ as the ratio of the power density at an offset frequency from the carrier to the total power of the carrier signal.

Summary Comparison of Measurement Techniques

A variety of measurement techniques have been developed to meet various requirements for phase noise measurements. The three most widely-adopted techniques are: direct spectrum, phase detector and two-channel cross-correlation. While the direct spectrum technique measures phase noise with the existence of the carrier signal, the other two remove the carrier (demodulation) before phase noise is measured.

Table 1. Phase noise (PN) measurement technique

Summary comparisons	Direct spectrum N/W9068A	PLL/cross correlation E5052B	Phase detector E5500A
Main features			
Ease of operation, including setup and calibration	○	○	●
Quick check of phase-locked signals	○	○	●
Dedicated to phase noise (PN) or multi-purpose	multi	multi	dedicated
Separation of PN from AM noise	●	○	○
Measure drift signal sources such as YIG oscillators	●	○	○
Low noise built-in DC sources for VCO test		○	
Investment budget	low	medium	medium/high
Devices under test			
Non-drifty signal sources	○	○	○
Phase-locked VCOs	○	○	○
Non-phase-locked VCOs		○	○
Signal sources with low AM noise	○	○	○
SAW oscillators	●	○	○
DROs	●	○	○
PLL synthesizers	●	○	○
Transmitters	●	○	○
Crystal oscillators		○	○
Amplifiers (residual/additive noise)			○
Converters (residual/additive noise)			○
Mixers (residual/additive noise)			○
Measurement requirements			
PN on CW carriers	○	○	○
PN on pulsed carriers (residual and absolute noise measurements)			○
Offset range	100 Hz to 10 MHz	1 Hz to 100 MHz	0.01 Hz to 100 MHz
Spot frequency (PN change/carrier drift vs. time)	○		
Quick check DUT w/poor PN	○		
Very low PN at far-out offset	●	○	○
Very low PN at very close-in carrier offset		●	○
Frequency, phase and power transient over time		○	
AM noise		○	○
Spectrum monitor	○	●	●
Baseband noise	●	○	●
Absolute PN	●	○	○
Extended frequency to 110 GHz	○	○	○

○ Indicates most applicable, advisable, or suitable to the attribute.

● Indicates less applicable, advisable, or suitable.

Blank indicates least applicable, advisable, or suitable.



Primary Phase Noise Measurement Techniques

Direct spectrum technique

This is the simplest and perhaps oldest technique for making phase noise measurements. As shown in Figure 1, the signal from the device under test (DUT) is input into a spectrum/signal analyzer tuned to the DUT frequency, directly measuring the power spectral density of the oscillator in terms of $\mathcal{L}(f)$. As the spectral density is measured with existence of the carrier, this method can be significantly limited by the spectrum/signal analyzer's dynamic range.

Though this method may not be useful for measuring very close-in phase noise to a drifting carrier, it is convenient for qualitative quick evaluation on sources with relatively high noise. The measurement is valid if the following conditions are met:

- The spectrum/signal analyzer's inherent SSB phase noise at the offset of interest must be lower than the noise of the DUT.
- If the phase noise measurement implementation does not differentiate amplitude (AM) noise from the phase noise (PN), like in most of the legacy spectrum/signal analyzers, then the AM noise of the DUT must be significantly below its PN (typically 10 dB will suffice). The innovative Keysight X-Series phase noise measurement application (N/W9068A), differentiates the AM noise from PN and implements the AM rejection (at offset frequency below 1 MHz) effectively removing the impact of the AM noise to the PN measurement results.

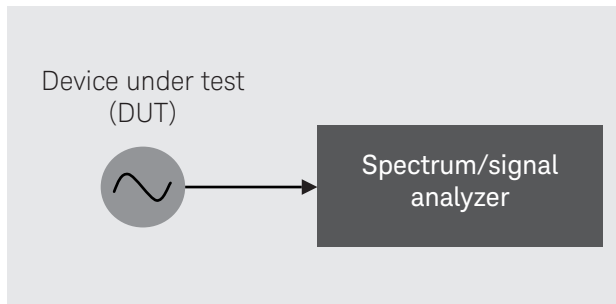

Figure 1. Direct spectrum measurement technique



Phase detector techniques

To separate phase noise from amplitude noise, a phase detector is required. Figure 2 depicts the basic concept for the phase detector technique. The phase detector converts the phase difference of the two input signals into a voltage at the output of the detector. When the phase difference is set to 90° (quadrature), the voltage output will be zero volts. Any phase fluctuation from quadrature will result in a voltage fluctuation at the output.

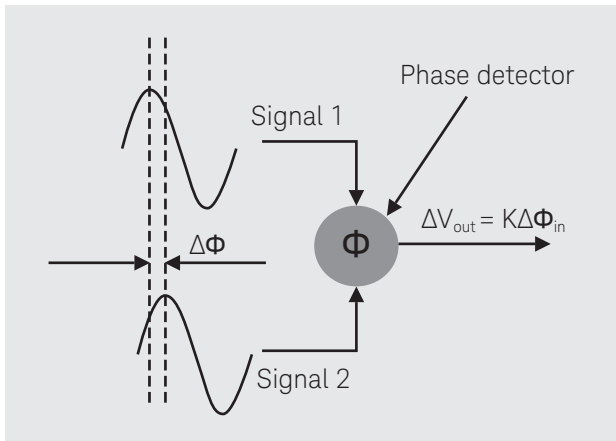

Figure 2. Basic concept of the phase detector technique

Several methods have been developed based upon the phase detector concept. Among them, the reference source/PLL (phase-locked-loop) is one of the most widely used methods. Additionally, the phase detector technique also enables residual/additive noise for two-port devices.



Absolute phase noise measurements

Reference source/PLL method

As shown in Figure 3, the basis of this method is the double balanced mixer used as a phase detector. Two sources, one from the DUT and the other from the reference source, provide inputs to the mixer. The reference source is controlled such that it follows the DUT at the same carrier frequency (f_c) and in phase quadrature (90° out of phase) nominally. The mixer sum frequency ($2f_c$) is filtered out by the low pass filter (LPF), and the mixer difference frequency is 0 Hz (dc) with an average voltage output of 0 V.

Riding on this dc signal are ac voltage fluctuations proportional to the combined (rms-sum) noise contributions of the two input signals. For accurate phase noise measurements on signals from the DUT, the phase noise of the reference source should be either negligible or well characterized. The baseband signal is often amplified and input to a baseband spectrum analyzer.

The reference source/PLL method yields the overall best sensitivity and widest measurement coverage (e.g. the frequency offset range is 0.01 Hz to 100 MHz). Additionally, this method is insensitive to AM noise and capable of tracking drifting sources. Disadvantages of this method include requiring a clean, electronically tunable reference source, and that measuring high drift rate sources requires reference with a wide tuning range.

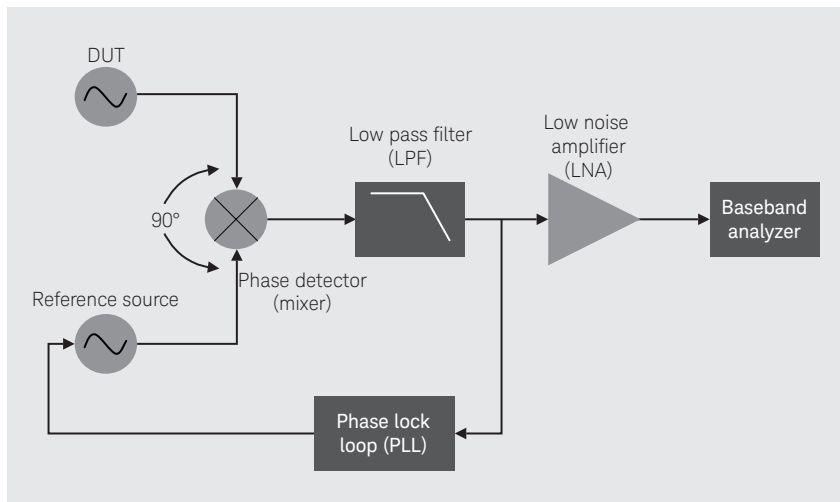

Figure 3. Reference source/PLL technique - basic block diagram



Analog delay-line discriminator method

This method is a variation of the phase detector technique with the requirement of a reference source being eliminated. Although the analog delay-line discriminator method degrades the measurement sensitivity (at close-in offset frequency, in particular), it is useful when the DUT is a noisier source that has high-level, low-rate phase noise, or high close-in spurious sideband conditions which can pose problems for the phase detector PLL technique.

Figure 4 shows how the analog delay-line discriminator method works. The signal from the DUT is split into two channels. The signal in one path is delayed relative to the signal in the other path. The delay line converts the frequency fluctuation to phase fluctuation. Adjusting the delay line or the phase shifter will determine the phase quadrature of the two inputs to the mixer (phase detector). Then, the phase detector converts phase fluctuations to voltage fluctuations, which can then be read on the baseband spectrum analyzer as frequency noise. The frequency noise is then converted for phase noise reading of the DUT.

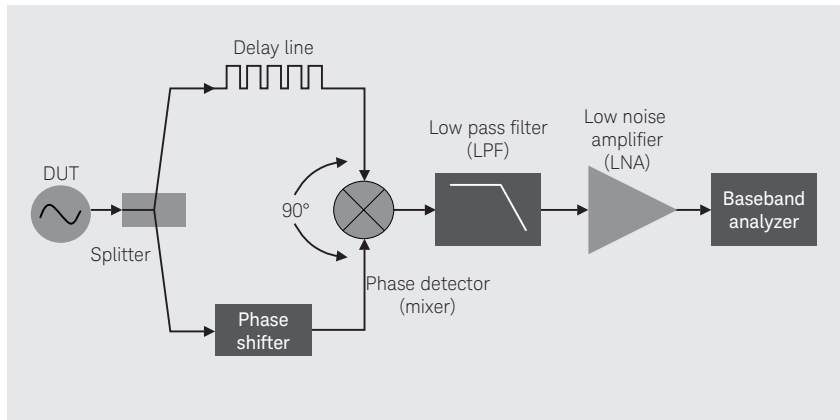

Figure 4. Analog delay-line discriminator method – basic block diagram

A longer delay line will improve the sensitivity but the insertion loss of the delay line may exceed the source power available and cancel any further improvement. Also, longer delay lines limit the maximum offset frequency that can be measured. This method is best used for free-running sources such as LC oscillators or cavity oscillators.



Heterodyne (digital) discriminator method

The heterodyne (digital) discriminator method is a modified version of the analog delay-line discriminator method and can measure the relatively large phase noise of unstable signal sources and oscillators. This method features wider phase noise measurement ranges than the PLL method and does not need re-connection of various analog delay lines at any frequency. The total dynamic range of the phase noise measurement is limited by the LNA and ADCs, unlike the analog delay-line discriminator method previously described. This limitation is improved by the cross-correlation technique explained in the next section.

The heterodyne (digital) discriminator method also provides very easy and accurate AM noise measurements (by setting the delay time zero) with the same setup and RF port connection as the phase noise measurement.

This method is only available in Keysight's E5052B signal source analyzer. See Figure 5 for a functional block diagram.

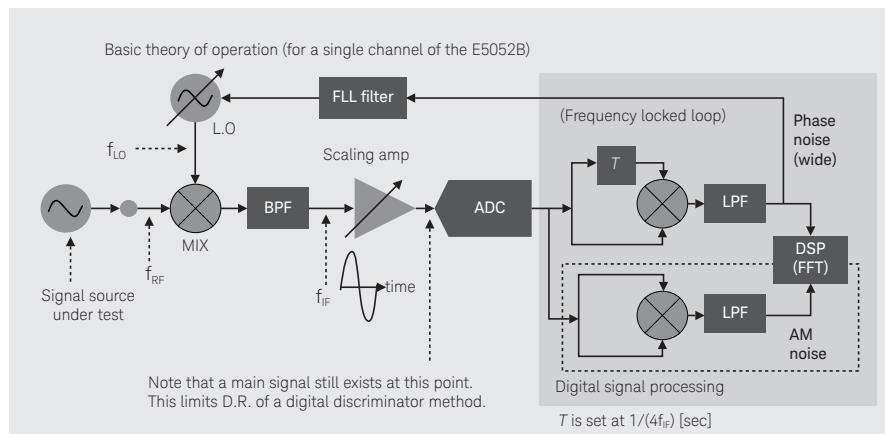

Figure 5. Block diagram for the heterodyne (digital) discriminator method



Residual phase noise measurements

Residual noise is the noise added to a signal when the signal is processed by a two-port device. Such devices include amplifiers, dividers, filters, mixers, multipliers, phase-locked loop synthesizers or any other two-port electronic network. Residual noise is the sum of two basic noise mechanisms: additive noise and multiplicative noise. The additive noise is the noise generated by the two-port device at or near the signal frequency which adds in a linear fashion to the signal. The multiplicative noise, on the other hand, is often due to the intrinsic modulations to the input signal by the non-linear behavior of the two-port DUT (Figure 6).

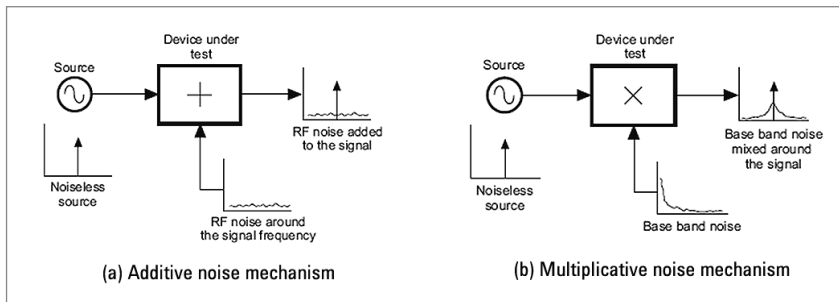

Figure 6. Residual noise generated by a two-port device is a sum of (a) additive noise and (b) multiplicative noise

To accurately measure the residual noise, the noise contribution of the DUT needs to be effectively separated from the source contribution. The phase detector technique provides an ideal solution for residual noise measurements. A typical setup for measuring the DUT's residual noise is shown in Figure 7.

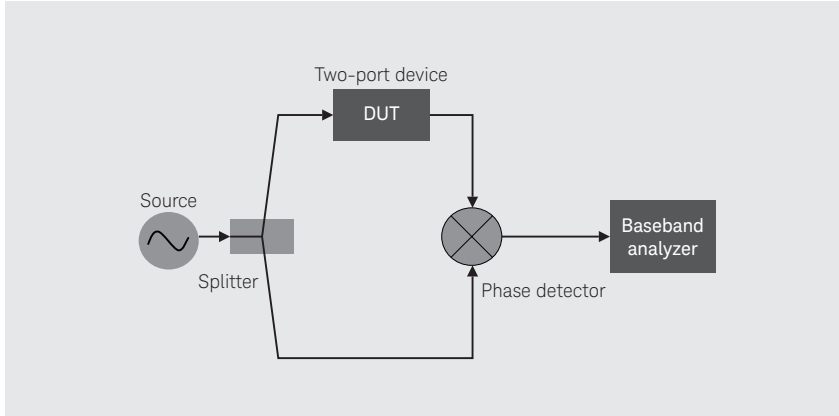

Figure 7. Setup for residual noise measurements based on the phase detector technique

The primary assumption for this setup is that the source noise in each of the two inputs of the phase detector is correlated at the phase detector for the frequency offset range of interest. Due to the correlation, the source phase noise cancels leaving only the residual noise of the DUT at the output of the phase detector. Therefore the baseband analyzer can detect and measure the residual noise generated by the DUT.

The Keysight E5500 phase noise measurement solution offers the residual noise measurement capability providing a useful tool for comprehensively characterizing two-port devices.



Two-channel cross-correlation technique

This technique combines two duplicate single-channel reference sources/PLL systems and performs cross-correlation operations between the outputs of each channel, as shown in Figure 8. This method is available only in the E5052B signal source analyzer, among Keysight phase noise measurement solutions.

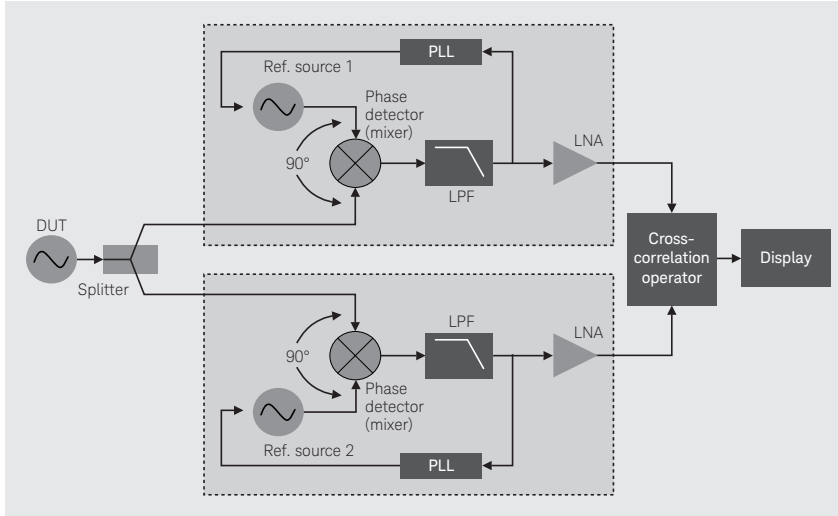

Figure 8. Two-channel cross-correlation technique combines two phase detectors

The DUT noises through each channel are coherent and are not affected by the cross-correlation, whereas, the internal noises generated by each channel are incoherent and are diminished by the cross-correlation operation at the rate of $M^{1/2}$ (M being the number of correlation). This can be expressed as:

$$N_{\text{meas}} = N_{\text{DUT}} + (N_1 + N_2)/M^{1/2}$$

where, N_{meas} is the total measured noise at the display; N_{DUT} the DUT noise; N_1 and N_2 the internal noise from channels 1 and 2, respectively; and M the number of correlations.

The two-channel cross-correlation technique achieves superior measurement sensitivity without requiring exceptional performance of the hardware components. However, the measurement speed suffers when increasing the number of correlations.



Keysight's Phase Noise Measurement Solutions

Keysight offers a variety of phase noise measurement solutions based on the three measurement techniques previously discussed.

Direct spectrum technique-based solutions

N9068A/W9068A phase noise measurement application for X-Series analyzers

In principle, any spectrum analyzer can be used for phase noise measurements based on the *direct spectrum* technique. However, in order to fully understand the DUT's phase noise behavior at different offset frequencies, the measurement procedure can be very time consuming and tedious. The measurement results may also heavily depend upon the user's experiences, as the instrument settings may need to be optimized for accuracy.

The signal/spectrum analyzer's inherent phase noise performance sets the limits for how low the DUT's phase noise can be accurately measured.

This technique is most suited for a quick check for a phase-locked signal. However, it is not recommended for making measurements at very close-in offsets.

The N9068A/W9068A phase noise measurement application software built-in to Keysight's X-Series signal analyzers automates the measurement procedure, and turns a general-purpose signal analyzer into a phase noise tester with convenient one-button operation. Figure 9 shows a display of the phase noise log plot measured by a PXA signal analyzer. The phase noise change versus time (*spot frequency*) can also be monitored at a user-specified offset frequency. Additionally RMS noise, including RMS jitter and residual FM, can be measured.

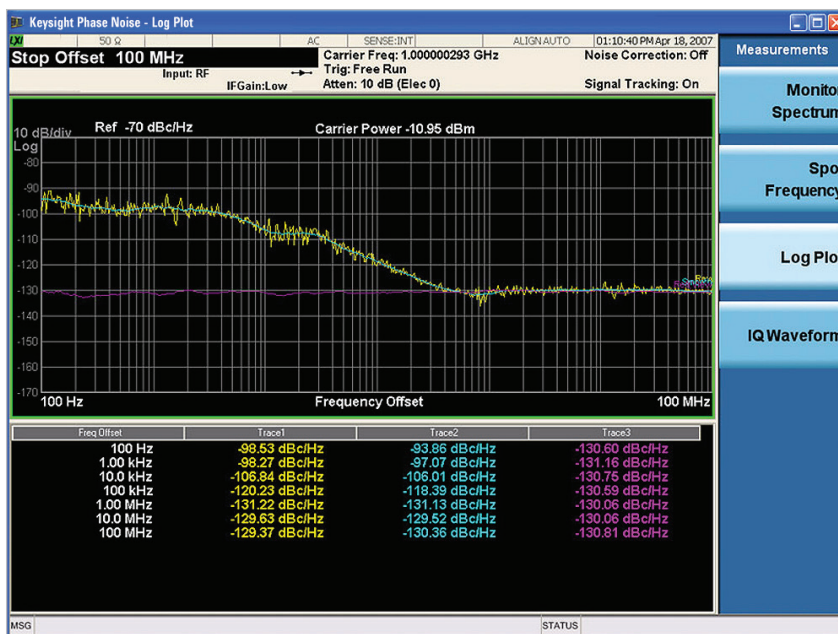

Figure 9. A phase noise log plot measured by a PXA

Option 226 phase noise measurement personality for PSA and ESA spectrum analyzers

The similar built-in application software can be found in Keysight previous-generation spectrum analyzers, PSA and ESA (Option 226, phase noise measurement personality). Option 226 has been one of the most popular built-in applications in the PSA and ESA.

Inheriting the excellence of Option 226 in the PSA/ESA, the N9068A/W9068A is highly backward compatible with Option 226, with respect to user interface and features. Furthermore, the technical innovations enable the N9068A/W9068A to provide superior performance and measurement speed to its predecessor.

Unlike its predecessor, the N9068A/W9068A phase noise application is based on the signal analyzer's IQ analyzer implementation such that the AM noise can be effectively differentiated from the phase noise. The IQ analyzer normalizes each I and Q points with the length of its IQ vector. Thus, rejecting the amplitude variance caused by the AM component (the AM rejection feature) becomes possible.

AM rejection feature in the N/W9068A is effective only in the area where offset frequency is below 1 MHz.



Key specifications and comparisons

The following is a comparison of the phase noise specifications for Keysight signal/spectrum analyzers (in dBc/Hz, @ 20 to 30°C, CF = 1 GHz).



N9030A PXA

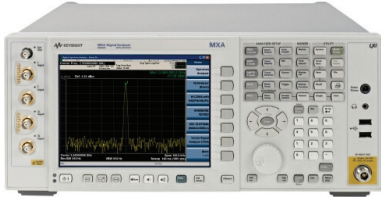

N9020A MXA



N9010A EXA



N9000A CXA

Table 2. Phase noise specifications comparison

Offset	PXA	PSA	MXA	EXA	ESA	CXA*
10 Hz	-75 nom.	-	-	-	-	-
100 Hz	-94	-91	-91	-84	-	-
1 kHz	-121	-103	-112 nom.	-98 nom.	-	-94/-98
10 kHz	-129	-116	-113	-103	-98	-99/-102
100 kHz	-129	-122	-116	-115	-118	-102/-108
1 MHz	-145	-145	-135	-135	-125	-120/-130
10 MHz	-155	-155	-148 nom.	-148 nom.	-131	-143/-145 nom.

*RF CXA values/MW CXA values

The analyzers' carrier frequency coverage ranges are shown in the following table.

Table 3. Carrier frequency range

	PXA	PSA	MXA	EXA	ESA	CXA
Min. freq.	3 Hz	3 Hz	10 Hz	10 kHz	100 Hz	9 kHz
Max. freq.	50 GHz ¹	50 GHz	26.5 GHz	44 GHz ¹	26.5 GHz	26.5 GHz

While the user interface of the N9068A/W9068A allows the offset frequency setting to be as low as 1 Hz, it is not advisable to use the direct spectrum technique to measure the very close-in phase noise due to the analyzer's LO feed-through and unspecified performance.

For more information, visit www.keysight.com/find/phasenoise

1. PXA and mmW EXA with Option EXM and external mixers extends the carrier frequency to 110 GHz and beyond. The N9068A phase noise measurement application supports the PXA and mmW EXA external mixing for the carrier frequency extension.



Phase detector technique:
E5500 Series phase noise measurement solution

E5505A phase noise measurement system

The Keysight E5500 solution, based on the *phase detector* technique, is dedicated to measuring the DUT's phase noise performance. It is a modular system that allows selection of numerous system components to meet a wide variety of phase noise measurements needs. The E5500 architecture combines standard instruments, phase noise components and PC software for the best flexibility and re-use of assets.

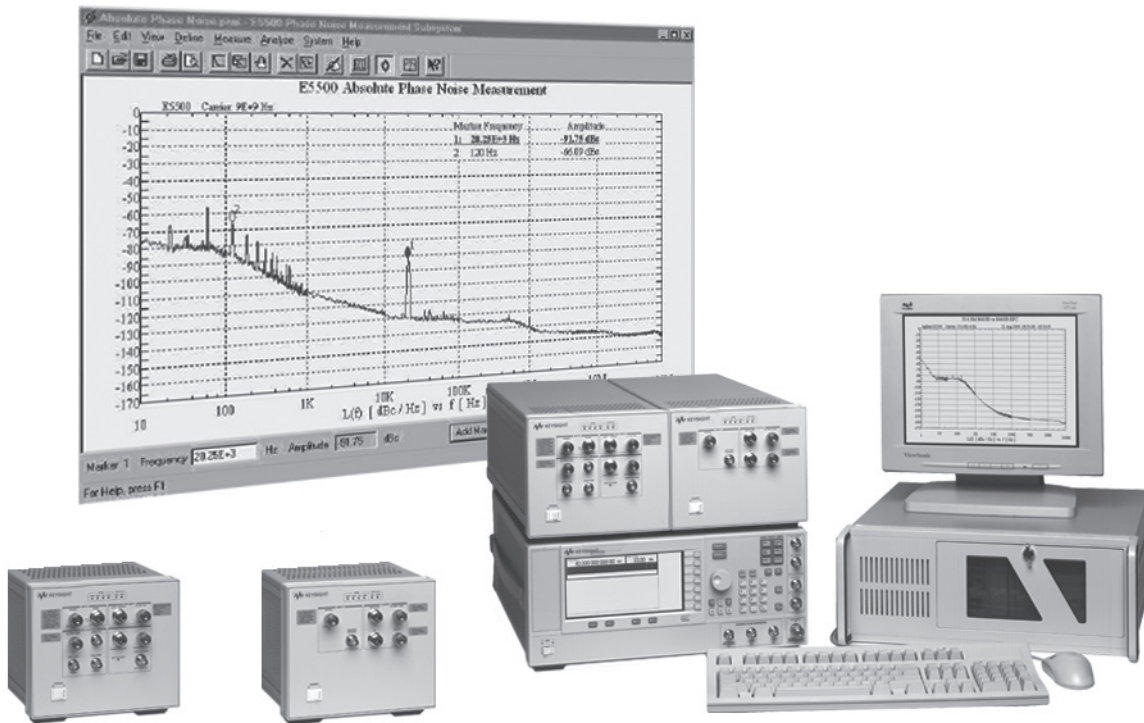

Figure 10. Keysight's E5500 series phase noise measurement solutions offers the most flexible set of measurements and configuration, and the widest offset ranges

The E5500 system allows the most flexible measurements on one-port VCOs, DROs, crystal oscillators, and synthesizers. Two-port devices, including amplifiers and converters, plus CW, pulsed and spurious signals can also be measured. The E5500 measurements include absolute and residual phase noise, AM noise, and low-level spurious signals. The standalone-instrument architecture easily configures for various measurement techniques, including the reference source/PLL and analog delay-line discriminator method.

With a wide offset range capability, from 0.01 Hz to 100 MHz (0.01 Hz to 2 MHz without optional spectrum/signal analyzer), the E5500 provides more information on the DUT's phase noise performance extremely close to and far from the carrier. Depending on the low-noise downconverter selected, the E5500 solution handles carrier frequencies up to 26.5 GHz, which can be extended to 110 GHz with the use of the Keysight 11970 Series millimeter harmonic mixer. The required key components of the E5500 system include a phase noise test set (N5500A) and phase noise measurement PC software. Figure 11 shows the typical N5500A phase noise sensitivity that limits the entire E5500 system's performance.

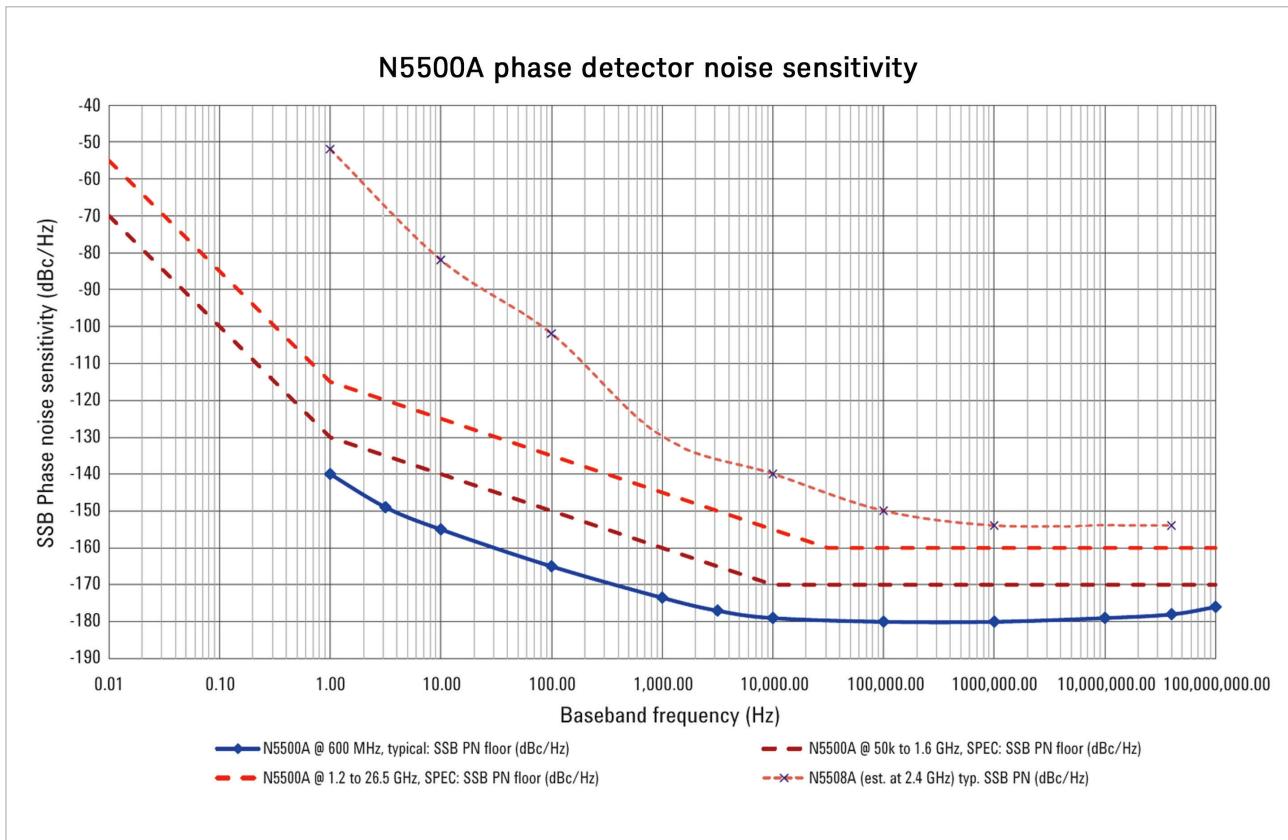

Figure 11. N5500A phase detector noise sensitivity

In addition, when configured with the programmable delay line the E5500 system can implement the “Frequency/analog delay-line discriminator” technique that offers good far-out but poor close-in sensitivity, suitable for measuring the free-running sources with a large amount of drift.

One unique capability of the E5500 is its pulsed carrier phase noise measurement. Pulsed carrier signals are most frequently found in the radar systems. In the pulsed radar systems, the phase noise of the receiver’s local oscillator sets the minimum signal level that must be returned from a target for it to be detected. In this case, phase noise affects the selectivity of the radar receiver, which in turn determines the effective range of the radar system. With the E5500, a user can make accurate measurements for the absolute phase noise, residuals, and AM noise on the pulsed carriers for assessment of the system’s overall performance.

The Keysight E5500 hardware includes

- 0.01 Hz to 2 MHz PC digitizer
- N5500A phase noise test set
- Selection of low noise downconverter

Optional capabilities

- Extend offset range to 100 MHz
- Add RF reference source
- Add high power input capability (includes μ W phase and AM detectors)
- Extend carrier frequency to 110 GHz
- Add remote SCPI programming client for ATE environments



E5500 key specifications and configurations

Carrier frequency ranges

- 50 kHz to 1.6 GHz (N5500A, phase noise test set)
- 50 kHz to 18 GHz (N5502A, low-noise 18 GHz microwave downconverter)
- 50 kHz to 26 GHz (N5507A, low-noise 26.5 GHz microwave downconverter)
- 50 kHz up to 110 GHz (with 11970 external mixer)

Offset frequency ranges

- 0.01 Hz to 2 MHz
- 0.01 Hz to 100 MHz (with selection of a signal/spectrum analyzer: MXA, PSA, or ESA)

System noise response

- -180 dBc/Hz typically (> 10 kHz offset)

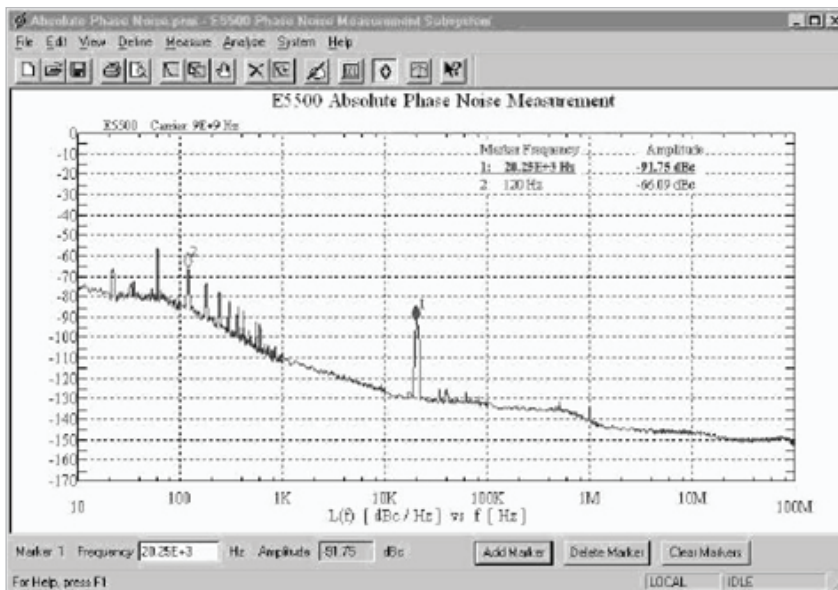

E5500 phase noise results

For more information, visit: <http://www.keysight.com/find/E5505A>



Two-channel cross-correlation technique: E5052B signal source analyzer

E5052B signal source analyzer

The Keysight E5052B signal source analyzer combines the following measurements in one comprehensive tool for signal source characterization:

- Phase noise measurement
- Frequency, phase, and power transient measurements for PLL lockup time test and frequency chirp linearity test
- Frequency, RF power, and DC current versus voltage measurements for VCO tuning test
- Spectrum monitor
- AM noise measurement
- Baseband noise measurement

Signal sources that can be measured by the E5052B include VCOs, DROs, surface acoustic wave (SAW) oscillators, PLL synthesizers, RFICs, transmitters, and clock generators.

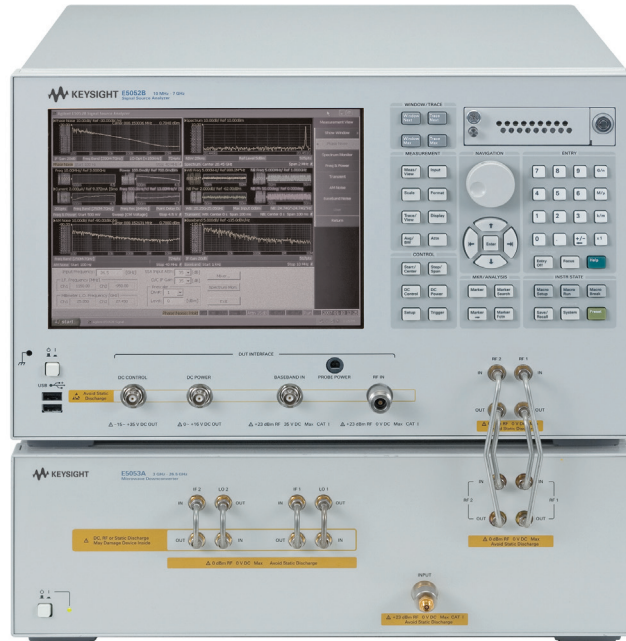

E5052B signal source analyzer with E5053A microwave downconverter

For phase noise measurements, the E5052B employs the “cross-correlation” technique to lower the instrument’s noise floor at all offset frequencies. The cross-correlation algorithm essentially cancels the noise of built-in references. The amount of noise cancellation depends on the “number” of correlations. For example, 100 times correlation reduces phase noise floor by 10 dB. Correlations of up to 10,000 times result in a 20-dB phase noise sensitivity improvement.

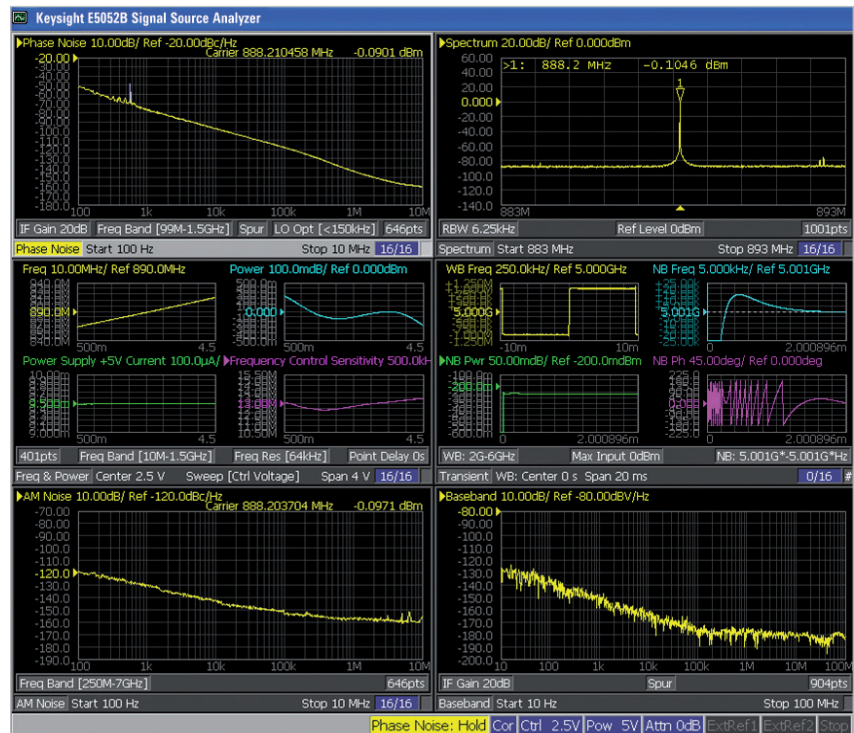

Multiple measurement results



Figures 12 and 13 show the E5052B's typical phase noise sensitivity, and its improvement with the cross-correlation technique, respectively. For a 1-GHz carrier signal at 10 kHz offset, the E5052B's inherent phase noise floor is about -146 dBc/Hz, which can be improved to -156 dBc/Hz with 100 times of cross correlation at the expense of longer measurement time.

The E5052B base model covers the frequency range of 10 MHz to 7 GHz, which can be extended to 26.5 GHz with E5053A downconverter and up to 110 GHz with a combination of the external downconverter and 11970 harmonic mixers. The cross-correlation technique is available in frequency ranges from 10 MHz to 110 GHz. The offset frequency ranges 1 Hz to 100 MHz (10 Hz to 100 MHz with Option E5052B-011).

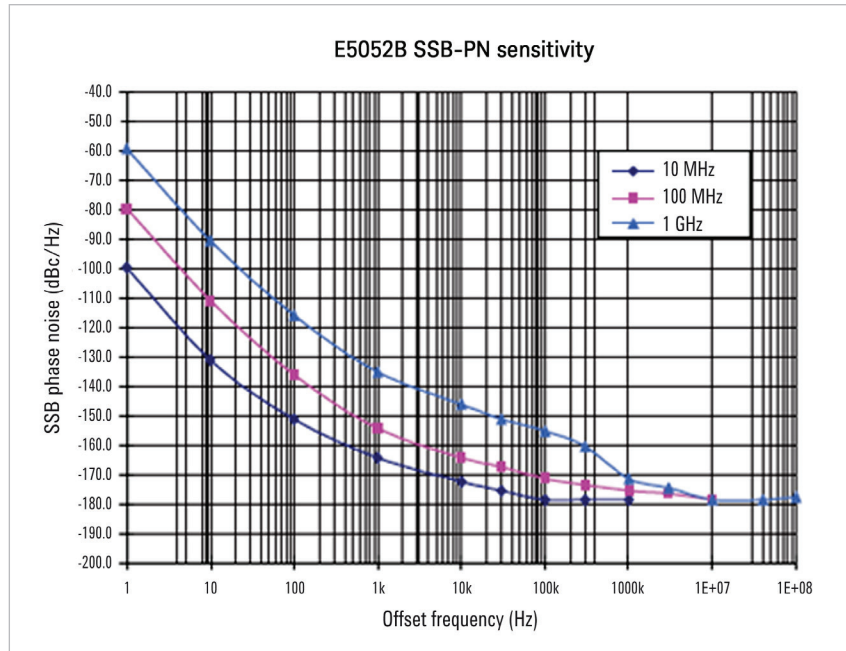

Figure 12. E5052B phase noise sensitivity at three carrier frequencies (standard, correlation = 1)

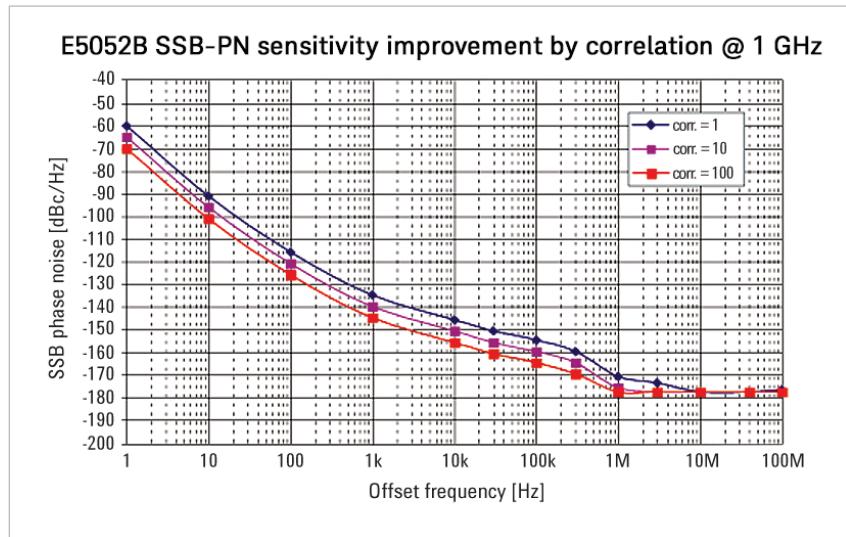

Figure 13. E5052B phase noise performance improvement with 1, 10, and 100 correlations at 1 GHz carrier



E5052B key specifications and configurations

Carrier frequency ranges:

- 10 MHz to 7 GHz
- 10 MHz to 26.5 GHz (w/E5053A downconverter)
- 10 MHz up to 110 GHz (w/E5053A downconverter and 11970 external mixers)

Offset frequency ranges

- 1 Hz to 100 MHz
- 10 Hz to 100 MHz (w/Option E5052B-011)

System phase noise floor

- -146 dBc/Hz typically (1 GHz carrier at 10 kHz offset, correlation = 1)
- -156 dBc/Hz typical (1 GHz carrier at 10 kHz offset, correlation = 100)

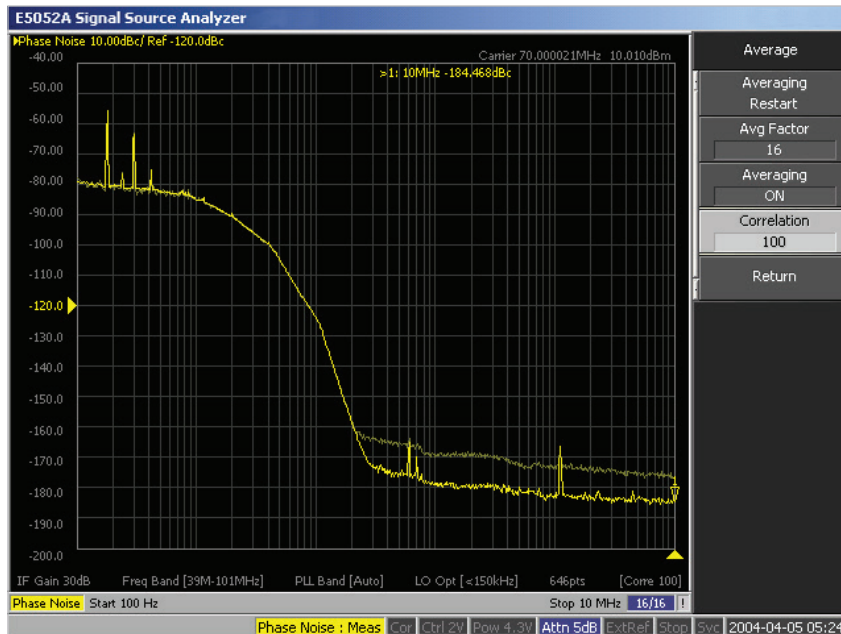

Figure 14. Phase noise log plot measured with an E5052B signal source analyzer

For more information, visit: www.keysight.com/find/SSA



Comparison of Keysight phase noise measurement solutions

The following table shows a comparison of Keysight’s phase noise measurement solutions, the measurement techniques they are based on, and their advantages and disadvantages.

Table 4. Phase noise (PN) measurement solutions

Keysight’s PN solutions	PN measurement technique based	Advantages	Disadvantages
– N9068A/W9068A phase noise measurement application on the X-Series signal analyzers	Direct spectrum measurement	<ul style="list-style-type: none"> – Easy operation – Quick checking of phase-locked signals – Instrument not dedicated to PN but used for general-purpose also 	<ul style="list-style-type: none"> – Difficult to measure close-in PN of quiet signal sources such as crystal oscillators – Cannot measure PN of drifty signal source such as free-running VCOs
– E5500A PN measurement solution	Phase detector (reference source/PLL)	<ul style="list-style-type: none"> – Applicable to broad offset range – Can measure very low PN at close-in-carrier offset frequencies by using good LO – Measure PN for the pulsed carriers as well as CW carriers – Can separate PN from AM noise 	<ul style="list-style-type: none"> – PN noise is limited by LO noise – Complicated set-up and calibration required
– E5500A PN measurement solution	Phase detector (analog delay-line discrimination)	<ul style="list-style-type: none"> – Can measure very low PN at far-out offset frequency – Suitable for measuring relatively drifty signal sources such as YIG oscillator 	<ul style="list-style-type: none"> – Not applicable to close-in PN measurements due to gain degradation by a discriminator – Complicated set-up and calibration required – Difficult to get an appropriate delay-line at an arbitrary test frequency
– E5052B signal source analyzer	PLL method and heterodyne (digital) discriminator method with two-channel cross-correlation technique	<ul style="list-style-type: none"> – Easy operation can eliminate complicated set-up and system calibration – Measure very low PN at a broad offset range – Cross-correlation enhances PN sensitivity – Can separate PN from AM noise – Super low noise built-in DC sources for VCO test 	<ul style="list-style-type: none"> – Longer measurement time for extremely low PN at close-in offset frequencies

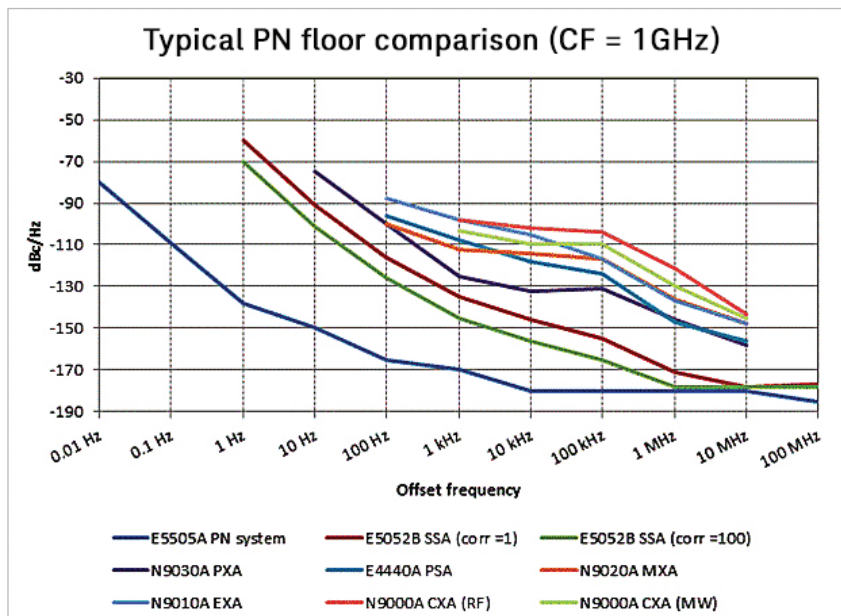

Figure 15. Comparison of phase noise performance at 1 GHz carrier frequency



Selecting the Right Phase Noise Solution

The following charts will help you select the right Keysight phase noise solution to meet your specific measurement needs. Start with your specific applications, select your DUTs, your measurement requirements, and then your investment budget (color coded).

Although this is a much simplified process, it can serve as a guide to the product literature listed in the *Additional Resources* section.

Your requirements	Consider
-------------------	----------

- Applications
- DUTs
- Measurements
- Investment budget

- Spectrum/signal analysis with quick checking of phase noise
 - Non-drifty signal sources
 - Phase-locked VCOs
 - Signal sources with low AM noise
- PN on CW carriers
- Offset from 100 Hz to 10 MHz
- Spot frequency (PN/carrier drift vs. time)
- Low investment budget

- Phase noise with other frequency, power, spectrum measurements
 - VCOs
 - SAW oscillators/crystal oscillators
 - DROs
 - PLL synthesizers
 - Drifty signal sources
 - Transmitters
 - Clock generators
- PN on CW carriers
- Very low PN @ far-out offset
- Offset from 1 Hz to 100 MHz
- Frequency, phase, and power transient over time
- AM noise
- Spectrum monitor
- Frequency, RF power, and DC current
- Baseband noise
- Medium investment budget

- Dedicated phase noise measurements
 - VCOs
 - DROs
 - Crystal oscillators
 - Synthesizers
 - Amplifiers
 - Converters
- PN on CW and pulsed carriers
- Extremely low PN over wide offset
- Offset from 0.01 Hz to 100 MHz
- Absolute PN
- Residual noise
- AM noise
- Low-level spurious
- Medium/High investment budget

Keysight's specific phase noise solution



N9068A/W9068A for X-Series signal analyzers



E5052B signal source analyzers



E5500A phase noise measurement solution

Additional Resources

The following literature can be downloaded from Keysight's website by entering the literature number as the search criteria.

- *Keysight N9068A/W9068A Phase Noise X-Series Measurement Application*, Technical Overview, literature number 5989-5354EN
- *Keysight E5500 Series Phase Noise Measurement Solutions*, Data Sheet, literature number 5989-0851EN
- *Keysight E5052B Signal Source Analyzer*, Technical Overview, literature number 5989-6389EN

Web Resources

- Phase noise measurement
www.keysight.com/find/phasenoise
- N9068A phase noise management application (PXA, MXA, EXA)
www.keysight.com/find/N9068A
- W9068A phase noise management application (CXA)
www.keysight.com/find/W9068A
- E5505 phase noise measurement solution
www.keysight.com/find/E5505
- E5052B signal source analyzer
www.keysight.com/find/SSA



Evolving Since 1939

Our unique combination of hardware, software, services, and people can help you reach your next breakthrough. We are unlocking the future of technology.

From Hewlett-Packard to Agilent to Keysight.

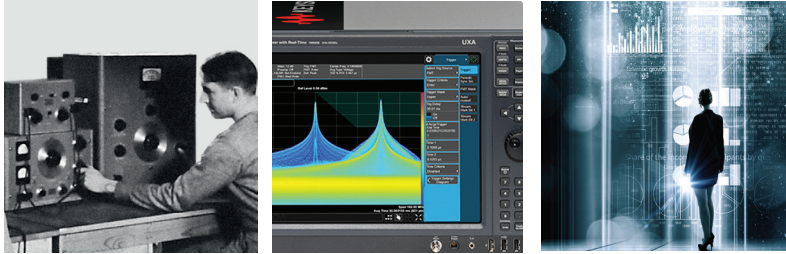

For more information on Keysight Technologies' products, applications or services, please contact your local Keysight office. The complete list is available at:

www.keysight.com/find/contactus

Americas

Canada	(877) 894 4414
Brazil	55 11 3351 7010
Mexico	001 800 254 2440
United States	(800) 829 4444

Asia Pacific

Australia	1 800 629 485
China	800 810 0189
Hong Kong	800 938 693
India	1 800 11 2626
Japan	0120 (421) 345
Korea	080 769 0800
Malaysia	1 800 888 848
Singapore	1 800 375 8100
Taiwan	0800 047 866
Other AP Countries	(65) 6375 8100

Europe & Middle East

Austria	0800 001122
Belgium	0800 58580
Finland	0800 523252
France	0805 980333
Germany	0800 6270999
Ireland	1800 832700
Israel	1 809 343051
Italy	800 599100
Luxembourg	+32 800 58580
Netherlands	0800 0233200
Russia	8800 5009286
Spain	800 000154
Sweden	0200 882255
Switzerland	0800 805353
	Opt. 1 (DE)
	Opt. 2 (FR)
	Opt. 3 (IT)
United Kingdom	0800 0260637

For other unlisted countries:

www.keysight.com/find/contactus
(BP-9-7-17)

DEKRA Certified
ISO 9001 Quality Management System

www.keysight.com/go/quality
Keysight Technologies, Inc.
DEKRA Certified ISO 9001:2015
Quality Management System

myKeysight

myKeysight

www.keysight.com/find/mykeysight

A personalized view into the information most relevant to you.

http://www.keysight.com/find/emt_product_registration

Register your products to get up-to-date product information and find warranty information.

KEYSIGHT SERVICES

Accelerate Technology Adoption.
Lower costs.

Keysight Services

www.keysight.com/find/service

Keysight Services can help from acquisition to renewal across your instrument's lifecycle. Our comprehensive service offerings—one-stop calibration, repair, asset management, technology refresh, consulting, training and more—helps you improve product quality and lower costs.



Keysight Assurance Plans

www.keysight.com/find/AssurancePlans

Up to ten years of protection and no budgetary surprises to ensure your instruments are operating to specification, so you can rely on accurate measurements.

Keysight Channel Partners

www.keysight.com/find/channelpartners

Get the best of both worlds: Keysight's measurement expertise and product breadth, combined with channel partner convenience.

www.keysight.com/find/phasenoise



This information is subject to change without notice.
© Keysight Technologies, 2010 - 2018
Published in USA, January 26, 2018
5990-5729EN
www.keysight.com

