

# Phase VI Progress Report

Dr. William T. Shepherd  
Program Manager  
Federal Aviation Administration  
Office of Aviation Medicine  
Washington, D.C. 20591

Galaxy Scientific Corporation  
Atlanta, GA

June 1996

## CHAPTER 1 PHASE VI OVERVIEW

*William Johnson, Ph.D and Prasad Prabhu, Ph.D  
Information Division, Galaxy Scientific Corporation*

### 1.1 INTRODUCTION

Secretary Peña's Safety Summit held in 1995 has resulted in the Department of Transportation's Aviation Safety Action Plan - "Zero Accidents". This has brought a new level of awareness and focus to applying Human Factors approaches to reducing human errors and developing methods and tools that allow cost savings without compromising safety. The airline industry is showing a great responsiveness in applying human factors methodologies to the maintenance environment. Maintenance Resource Management (MRM) or Technician Resource Management (TRM) using CRM-Human Factors concepts is being viewed favorably by many airlines. Continental Airline's Crew Coordination Concepts (CCC) program for its maintenance personnel is an example of this effort. Airlines are trying to control and reduce "Human Error" and are moving away from "blame the technician" approach to using structured methods to identify the root cause of the errors. The Maintenance Error Decision Aid (MEDA) developed by Boeing in cooperation with

the Federal Aviation Administration (FAA) and various airlines is an example of this approach. With human error being the # 1 cause of aviation incidents, it is evident that applying Human Factors principles to aviation is the best option for the U.S. Air Transport System to continue to maintain and improve its impressive record of air safety.

The Office of Aviation Medicine (AAM) has conducted Human Factors-related research in Aviation Maintenance since 1989. The research ranges from basic scientific experimentation in laboratories to applied studies in airline working environments. The philosophy of this research program has been that "good science" must be the basis for "good practice" and the research conducted must have demonstrable benefits to the Aviation Industry. For this to happen, the end user of the research must be involved in all stages of the research. As such, the researchers in this program have actively sought input from airlines and FAA organizations to define, develop and evaluate the research initiatives.

There has been a strong emphasis on transitioning the research products to the industry. For example one major air carrier is using maintenance workcards that have been re-designed as part of the research. The FAA Flight Standards Service (AFS) is currently planning a large scale deployment of an operational portable computing system called OASIS (On-line Aviation Safety Inspection System). OASIS was an offshoot of the pen-computing job aid developed as part of this research program. These and other research products and procedures generated by the research program have continued to demonstrate the effectiveness of using Human Factors principles in the Aviation Maintenance.

The research program has so far conducted 10 workshops on Human Factors in Maintenance and Inspection attended by over 1000 industry participants. In seven years, the research program has generated over 200 technical reports, journal articles, and presentations at industry meetings. Four CD-ROMS have been published so far and distributed to over 3000 recipients. A homepage has also been established on the world wide web of the Internet to disseminate Human Factors Information to the aviation community.

This report describes the research activities performed during Phase VI of the research program. Research was conducted in a broad spectrum of areas including application of advanced technologies to aviation maintenance, application of CRM concepts in maintenance and inspection, investigation into automation error and ground damage incidents, investigating human performance issues and developing job aids, investigating and developing digital documentation techniques for efficient communication, visual inspection studies, evaluation of Simplified English, and developing methodology to create "advanced certification" for AMTs. Each of the research activities will be described briefly in the following sections of this introductory chapter.

### **1.1.1 Multi-media based Training System for Regulatory Documents (Chapter 2)**

In this phase, the System for Training Aviation Regulations (STAR) progressed from a prototype (in Phase V) to an application supporting three learning environments. The learning environments are the Overview, Scenario, and the Resources. STAR is designed to be an instructional companion to the FAA Part 147 course on Aviation Maintenance Regulations. It

uses multi-media technology and case-based story telling techniques to motivate interest and promote understanding of aviation regulations. The chapter describes the theoretical basis of STAR, the learning environments, and the evaluative studies performed to test the validity of this approach.

### **1.1.2 Computer-based System for Aircraft Maintenance Team Training** **(Chapter 3)**

Team training attempts to improve teamwork by facilitating better communication, decision-making, and problem-solving skills in team members. As computer-based technologies get cheaper, application of these advanced technologies to imparting team training concepts is very desirable. This chapter describes the development of a computer-based team training software called the "Aircraft Maintenance Team Training (AMTT)". AMTT has been designed to train AMTs in basic team skills. It uses multi-media presentations including full motion videos, animations, pictures, and audio to explain team training concepts to the student. It also has an "instructors" module that allows a training instructor to analyze the performance of the student using the pre- and post-training data collected by the software.

### **1.1.3 Team Situation Awareness in Aircraft Maintenance** **(Chapter 4)**

Situation Awareness (SA) had been limited to the study of pilots and air traffic controllers and found to have a tremendous impact in these areas. However, an enhanced understanding of how maintenance personnel manage resources and maintain an awareness of all aspects of a given maintenance task has the potential to reduce and/or mitigate human error in maintenance. The project studied the situation awareness training requirements of maintenance teams. This chapter presents a description of the situation awareness requirements for aircraft maintenance teams, analyzes how SA needs are currently being met in a typical maintenance environment, and establishes the concepts and requirements for training Team SA in the maintenance domain.

### **1.1.4 Job Aiding for FAA and Industry** **(Chapter 5)**

Human-centered job aids help the aviation industry to improve performance without reducing safety. This chapter describes the three job aids developed as part of this effort, one was a fully operational system for conducting audits for the Coordinating Agency for Supplier Evaluation (CASE), the second was a job aid for the FAA Aviation Safety Inspectors to use the Job Task Analyses (JTA) information, and the third was a prototype system for the Civil Aeromedical Institute (CAMI) to collect and distribute data on alcohol and drug test results.

### **1.1.5 Pen-Computer based Non-routine Write-up System** **(Chapter 6)**

Pen-computer based non-routine cards promise the benefits of less handwriting, standardization of language, improved readability, better access to maintenance information, automated routing of information for scheduling repairs, and improved database to support planning and analysis.

This chapter describes the development of a prototype non-routine write-up system and a pilot study conducted to test its effectiveness.

### **1.1.6 Error Reporting System for Maintenance Facilities** **(Chapter 7)**

Many error reporting systems are in use by different departments in an airline. However, these systems are rarely used together to analyze the system as a whole. This holistic approach is important because there could be common causes for errors across the different maintenance areas. The research effort analyzed five classes of errors from reporting systems for Ground Damage Incidents (GDI), On the Job Injuries (OJI), and Paperwork Errors. The chapter describes this analysis and the development of an "Unified Incident Reporting System" for Maintenance.

### **1.1.7 Electronic Ergonomics Audit System for Maintenance and Inspection** **(Chapter 8)**

The purpose of this project was to integrate a variety of ergonomic audit tools into a comprehensive package to cover both maintenance and inspection tasks. Issues such as interface usability, expert system support for analyses, and provisions for printing and generating reports were considered. The chapter reports the development of this tool and also describes its capabilities.

### **1.1.8 Advanced Technology Applications** **(Chapter 9)**

Advanced technology can help maintenance and inspection (M&I) technicians as well as the aviation safety inspectors (ASI's) to achieve the twin goals of safety and productivity. This was demonstrated by the Performance Enhancement System (PENS) which used pen-computer technology. This technology was developed and evaluated in Phase V of the research project.. The project described in this chapter focused on the following areas: (1) Development and evaluation of an improved display prototype, (2) Evaluation of documentation output options for PENS, and 3) Evaluation of specific advanced technologies. These areas were selected because they matched the Flight Standards Service (AFS) requirements for recording and accessing data.

### **1.1.9 Visual and NDI Inspection Research** **(Chapter 10)**

The National Aging Aircraft Research Program (NAARP) of the FAA Technical Center has identified visual inspection and non-destructive inspection (NDI) as two of the specific research areas. This chapter describes research activities performed at the Aging Aircraft Non-destructive Inspection Center (AANC). Two studies were performed, one to help conduct and analyze the Visual Inspection Research Program (VIRP) benchmark study at the AANC and the second was an enhanced visual inspection evaluation in which a "Maglight" flashlight was evaluated. The chapter also reports a summary of a quantitative comparison of recent NDI reliability studies performed by the FAA and the CAA (UK).

### **1.1.10 Study on Automation Related Errors in Maintenance and**

## **Inspection (Chapter 11)**

Modern test equipment for maintenance is getting increasingly complex and poses a potential for novel forms of errors alongside the promised benefits of higher productivity. This chapter reviews the progress of automation in the maintenance and inspection hangar, provides a method for taking automation decisions, and presents a simple procedure to help system designers and buyers to foresee and mitigate automation-related errors.

### **1.1.11 Field Evaluation of Simplified English (Chapter 12)**

The Air Transport Association (ATA) and the Aerospace Industries Association of America (AIAA) have emphasized the use of "Simplified English (SE)" for technical documentation. Most major aircraft manufacturers now use SE in their documentation. However, the impact of this restricted language on AMTs had not been directly measured so far. This chapter describes the results of the study conducted to determine whether SE enhances comprehension of workcards by AMTs.

### **1.1.12 Study of Advanced Certification for AMTs (Chapter 13)**

The Aviation Rulemaking Advisory Committee (ARAC) Part 65 Working Group has been reviewing FAR Part 65. This process began in 1989 and is now in the final stages. The committee's final recommendations have resulted in the draft of a proposed new Part 66 - certification: Aviation Maintenance Technicians and Aviation Repair Specialists, completed in December 1995. This chapter describes the second phase of a study undertaken as an extension of the Part 65 review work. The first phase of the study (Phase V progress report) focused on the need for an industry-directed, independent system. The second phase study addressed the process for developing certification standards of aviation maintenance specialists. The chapter reports the key findings and recommendations for an Aviation Repair Specialists (ARS-I) training, qualification, and certification process.

# CHAPTER 2

## SYSTEM FOR TRAINING AVIATION REGULATIONS (STAR): DEVELOPMENT AND EVALUATION

*Terrell N. Chandler Ph.D.*  
*Information Division, Galaxy Scientific Corporation*

### 2.1 INTRODUCTION

The System for Training of Aviation Regulations (STAR) is designed to be an instructional companion to the FAA Part 147 course on Aviation Maintenance Regulations. The purpose of the STAR project has been to provide a comprehensive curriculum for acquiring the skills and content necessary for efficient document research and comprehension of the Federal Aviation Regulations (FARs). Our goal is to provide a system that a) motivates the student to understand why learning the FARs is both relevant and necessary, b) develops students' study and cognitive skills in document research and understanding, and c) makes the content of the FARs more memorable by providing presentations that are more interesting. Our approach is to incorporate multimedia presentations and storytelling techniques within several different learning environments. This phase report outlines the accomplishments made over the past year. It discusses the theoretical approach to STAR, covers each learning environment included in STAR, and presents the results for two evaluative studies. The phase report will end with an outline of the future directions for Phase seven.

During 1995 STAR progressed from a prototype with a single scenario to an application supporting three of the four planned learning environments identified in the design phase of STAR. The three learning environments that have been developed are the Overview, Scenario and Resources. The Overview learning environment has a module for instruction of the FAR Parts related to the Part 91 operating regulations. The Scenario Learning Environment now houses three scenarios: the New Mechanic, Special Inspections and Cartography Job. Together these scenarios cover the curriculum related to privileges and limitations of aviation maintenance technicians. Many other subjects, such as proper record keeping procedures and document research techniques are also covered within these scenarios. The resources learning environment has three modules, a document browser for referencing the FARs, a glossary and a module indexing informational media included in STAR. Each of these learning environments and their modules will be discussed in the following sections.

### 2.2 THEORETICAL APPROACH

Studying FAA regulatory documents is difficult. Instructors are given the arduous task of

conveying the meaning of subtle and seemingly ambiguous material to a **student<sup>1</sup>** body who do not always recognize the importance of what they are learning. Two difficult aspects of learning the regulations are learning how to navigate through the FARs (and other related documents) and comprehending the meaning of particular statements within the FARs. FARs are legal documents written precisely to define the regulations pertaining to aviation. Unfortunately, it is not easy for most people to extract the intent of each statement from this style of writing. Often, information relevant to a task is distributed across many parts of the FARs. It is not always obvious where one needs to look to get a complete sense of the regulations' intent. Students become so absorbed in interpreting the ambiguities of the FARs that they often miss the "big picture." The big picture is the functional purpose of the FARs and the Aviation Maintenance Technicians' (AMT) role in ensuring compliance with the regulations.

### **2.2.1 Multiple Vantage Points to Complex Information**

STAR is designed to help students acquire the big picture. This is accomplished, in part, by providing many vantage points to the same body of information. Experiencing complex material repeatedly under different circumstances provides multiple opportunities to gain a deep understanding of the subject (Spiro & Feltovich, 1991). Each vantage point not only covers different aspects of the same material, but also reinforces different kinds of study skills. In this way, students are not only provided with multiple ways of viewing the information, but also with multiple opportunities to learn. In addition, information conveyed through one learning environment may best fit one student's style of learning, while the other learning environments fit other people's learning styles. Thus, more people benefit when multiple approaches to the subject are taken.

STAR offers several different categories of learning environments: overviews, scenarios, challenges, and resources (**Figure 2.1: The STAR Directory**). Each category holds one or more learning modules for students to explore. Overviews show students how FARs are organized, how different parts are related to each other, and who is responsible for what aspects of those regulations. Scenarios are interactive stories that set students into a true-to-life situation where the regulations are often subtle. Challenges require students to exercise certain skills they must develop in order to efficiently search the regulations and understand what they find. Resources are comprehension aids such as a glossary. These aids provide "as needed information" that can be explored in their own right or used in conjunction with other, more formal learning environments. Each learning environment could be a stand-alone application. Together they provide multiple vantage points for students to arrive at a deeper understanding of aviation regulations.

### **2.2.2 Learning in Context**

Part of the difficulty in teaching the FARs is that students perceive the subject to be very dry. Indeed, some of the tasks expected of the students can be pretty tedious. However, there are many opportunities to convey the complexity and subtlety of the information in interesting ways. "War stories" from AMTs currently out in the field are one way to make the material more interesting and meaningful to the student. Stories are well suited for capturing tacit instructional knowledge, because story telling is a more natural way for people to convey ill-specified practices (Chandler, 1994).

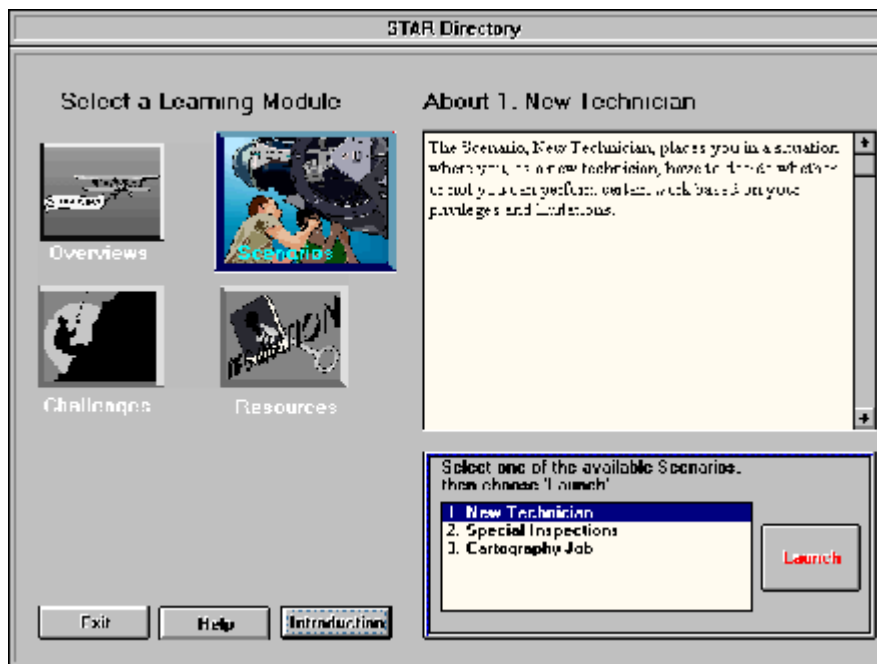


Another way to make the material more meaningful is to immerse the students in situations that confront them with "real world" decisions related to their jobs. By placing the application of the FARs in context, students have a much better chance of constructing for themselves a scheme (Brewer, 1987) for how the FARs operate functionally in aviation. When students are given the opportunity to learn in context, the concepts are acquired more rapidly, durably and are more easily transferred to new situations (Brown et al., 1989). Both "story telling" and "situated learning" place the information to be learned in contexts that the student can more easily relate to and remember.

### 2.2.3 Media-Rich Presentations

Media-rich presentations are a third approach to making the subject of the FARs more interesting. Multimedia has other pedagogical advantages as well. According to Park and Hannafin (1993), multiple, related representations improve both encoding and retrieval. Learning improves as the number of complementary stimuli used to represent learning content increases. For example, when concepts are encoded in both verbal and visual forms, they are retained in memory longer and are more easily accessed, because the two types of information complement each other in the activation, representation and development of related information (Park 1994). Thus, complimentary information presented through multiple types of media is most favorable for conceptual retention.

**Figure 2.1 The STAR Directory**



Each of the pedagogical approaches above is incorporated in STAR. Below, a description of how these approaches have been incorporated in two of the learning environments, the overview and the scenario, is presented. When appropriate, theoretical and practical issues pertaining to interactive multimedia design are highlighted.



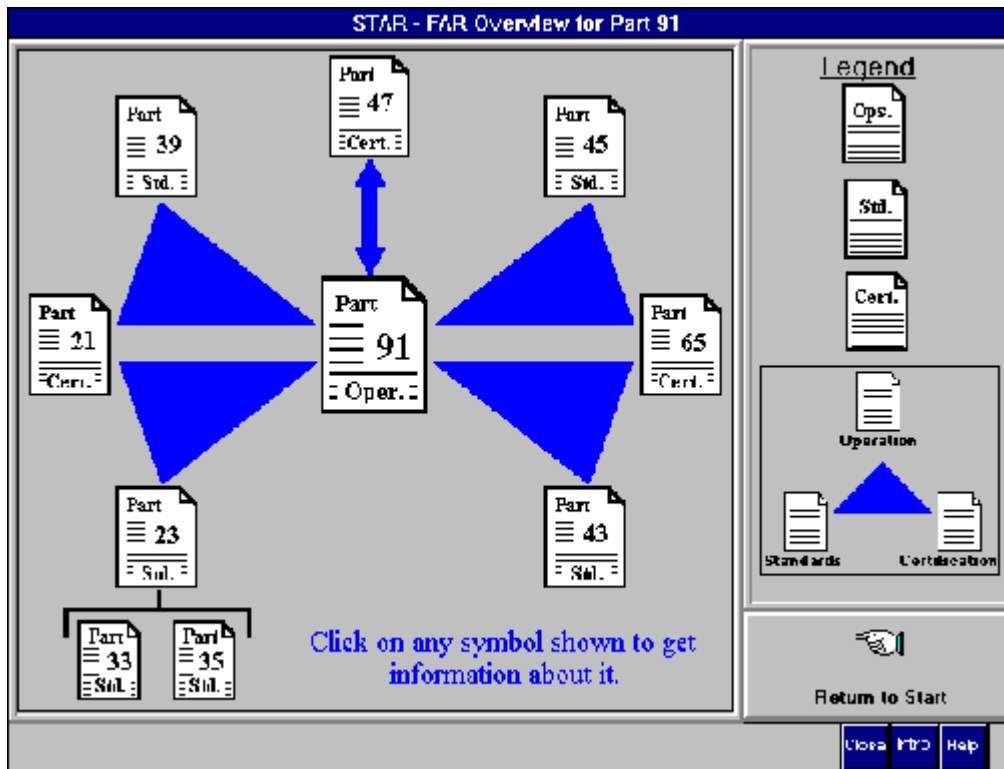
## 2.3 THE LEARNING ENVIRONMENTS

Though the user has control over their exploration of STAR, there is a logical progression for moving through the curriculum. Overviews give students the overall structure of the FARs and are best viewed first. Scenarios anchor (CTGV, 1992) students in real world situations, and Challenges, when implemented, will be designed to promote the integration of material covered in the other learning environments. Resources, in the form of a glossary, informational media browser, and document browser are designed to augment and support the activities in the other learning environments. The three learning environments developed this past year -- Overview, Scenarios, and Resources are presented below.

### 2.3.1 Overviews

Overviews are intended to show students how FARs are organized, how different parts are related to each other, and who is responsible for what aspects of those regulations. There are several perspectives for which one can convey this type of information. One approach would be to describe the chronology of an airplane from its inception, through its manufacture, to its eventual ownership and maintenance of the craft. At each point in the chronology, parts of the FARs relevant to that aspect of the aircraft's development are highlighted and discussed. Another approach is to give the evolution of the development of safety standards for aviation that eventually have been embodied in the FARs. A third approach, and the one that currently is implemented in STAR, is a work-centered approach (**Figure 2.2: Overview of General Aviation**). Students are presented with a visual scheme for how the FARs that are most relevant to their work are related to one another. Included in this scheme is a general description of each FAR part, what type of regulation it embodies, and how these different types of regulations interact with each other.

**Figure 2.2 Overview - General Aviation**



The example in **Figure 2.2** shows the FAR Parts relevant to aviation maintenance for general aviation. In the center is the operating regulation, FAR Part 91. Operating Regulations are central regulations prescribing the privileges and limitations of aircraft operations. Surrounding Part 91 are the standard and certificate regulations supporting the operating rules for general aviation. Each FAR Part, and the relationships between them, is presented in order. As each new piece of the overview is presented, it flashes to indicate to the student that this is the next relevant concept. Students may revisit any part of the overview already presented. Thus, students observe the building of the conceptual graph and then may explore different portions of the graph independent of any order.

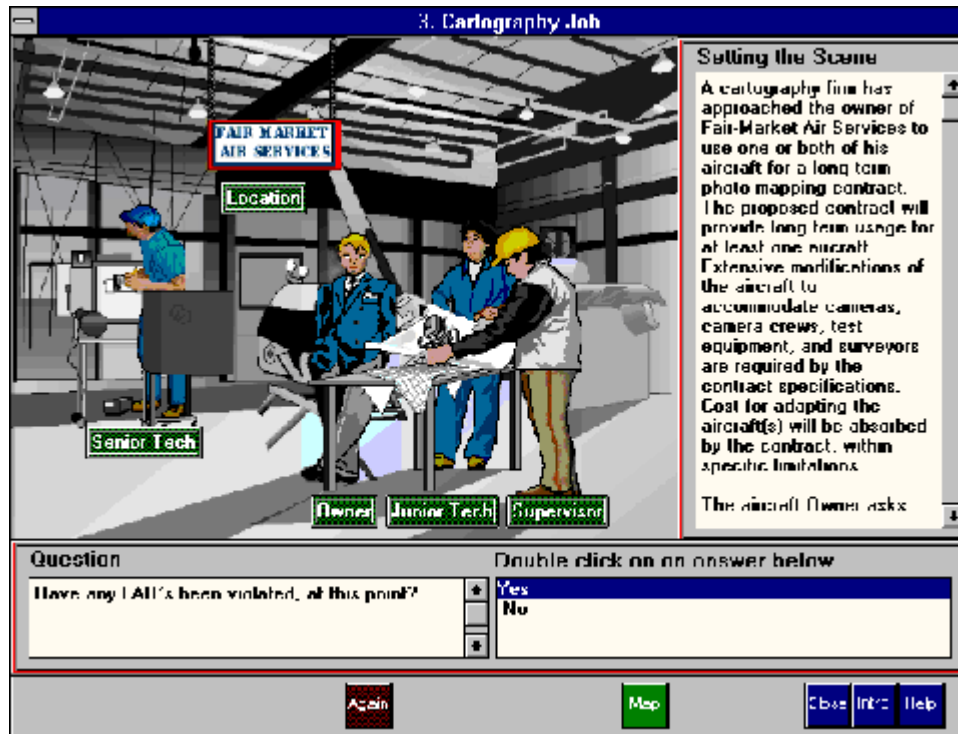
### 2.3.2 Scenarios

Scenarios are essentially interactive stories. In the opening scene of each scenario, students are told of an unclear situation where several actions are possible (**Figure 2.3: Scenario - Cartography Job**). They are asked a question about what they should do, given the situation, and are presented with several actions that they could take. Each scene is portrayed through a graphic picture or photograph and the new situation is told either through text and narration. The graphic picture sets the visual scene and the narration tells the story.

Once a student chooses an answer, a new scene in the scenario is presented. The new scene shows the consequences of the action chosen and the rationale for why the student should or should not have made that choice. Students are then asked a new question and presented with new options until they reach the end of that story line in the scenario. Students may access a map to help them orient and navigate through the scenario. As a student moves from one scene to the

next, the map updates to reflect the student's progress.

**Figure 2.3 Scenario - Cartography Job**



One noted difference between the scenarios in STAR and more traditional ITS is the idea that, in complex situations, there are no definitively right or wrong answers. Understanding why an action may be wrong is as important as knowing what is right. To get the most out of each scenario, students are encouraged to explore all the story lines (or paths). By exploring all the paths, students acquire a deeper understanding of the situation and of the subtle distinctions they need to make to comprehend fully the intent of the regulations. In this sense, there is no right answer, only deeper understanding.

Associated with each individual scene is supporting informational media (**Figure 2.4: Informational media**). This supporting media augments students' understanding of the scene by providing commentary about the FARs or background to general aviation concepts. Some of that information can be accessed by clicking on hotspots in the scene itself. Any labeled, colored area on the scene's (gray scale) picture has information associated with it. Other media can be accessed through a bank of informational buttons along the left side of the button bar located at the bottom of the screen. The buttons represent four main categories of information: "very important points (VIP)", "terminology", "related FAR sections" and "for your information (FYI)". For Your Information may have several different types of information associated with it: procedural information, document research strategies, personal experiences, and system information. The informational media is intended to fill-in students' understanding of the current situation. Students are encouraged to explore the additional information provided within each scene. Some of the information could influence their subsequent decision with respect to the question they are about to answer. Other information is provided to round-out their general

knowledge of the subject.

**Figure 2.4 Scenario - Informational Media**



Throughout STAR there are many different presentation formats. Our primary presentation format is audio narration, with complementary text covering the same content, and a graphic picture that "sets the scene." Students may follow the text while they listen to the narration. This redundancy seems to be a strong format for reinforcing the content. For system or procedural knowledge, video is employed. Video lends itself best to situations where the working of component parts can be pointed-out, and functional relationships elucidated. Video is also utilized to personalize the stories AMTs have about the FARs.

One presentation format adopted in some of the scenarios is the slide show. When a new scene is presented, students are told the situation in the scene by a narrator. Visual highlights punctuate important points in the scene. Pictures, excerpts from the FARs, and colored hotspots appear in timed coordination with the narration. Visual enhancements have varying levels of success depending on the complexity of the visual stimulus. Highlighting important aspects of the commentary graphically seems to work well, particularly if it is pointing out additional information students can access. Presenting the FAR text tends to cause interference with further comprehension of the narration. This is because the two modes of perception, text and audio, compete with each other for cognitive resources (Park & Hannafin, 1993). Unless the text is redundant with the audio content, it should be minimized to bullet points that can be recognized instantly.

When presenting information through interactive story format, it is sometimes a challenge to ensure that the most salient information is what is accessed by the student. In the scenario, for instance, the most salient information is conveyed through the opening narration of each scene. For the supporting media, however, not all relevant information can be portrayed graphically and

not all information can be integrated easily in a single graphic depiction. When this is the case, the informational buttons mentioned above are available to hold the media that cannot be placed easily directly in the scene's picture. There is an implicit assumption, however, that the more significant information is the information imbedded in the graphic. Given this assumption, it is important that the graphic is designed to depict the most significant information as well as support the themes in the scenario. Since one medium is being utilized for dual functionality, there is an implicit tension in accomplishing both these goals. For STAR, the scenario graphics have been designed to support scenario themes and, only where feasible, incorporate depictions of the supporting media.

### 2.3.3 Resources

Resources are comprehension aids such as a glossary. These aids provide as needed information that can be explored in its own right or used in conjunction with other, more formal learning environments. There are three modules in the resource learning environment. The glossary defines and exemplifies commonly found terms in the FARs. All the Part 1 terms are included as well as terms commonly used in aviation maintenance. Informational Media are multimedia presentations designed to supplement the STAR learning environments with related concepts and commentary about the FARs and aviation. The document browser is designed to provide searching and viewing documents in their entirety. It has full-text searching capabilities both within and among documents.

### 2.3.4 The Glossary

Commonly used terms found in the FARs that may or may not be covered in FAR Part 1.1 are listed in the glossary (**Figure 2.5**). When a term is selected, two types of text appear. In one text box are excerpts from the FARs showing the use of the term in the context of the FARs. In the other text box the term is defined according to how it is commonly used in the working world of aviation. When multimedia is appropriate for enhancing the meaning of the term, a multimedia button appears. Usually the media consist of a graphic that, for instance, depicts what a form looks like. This combination of vantage points provides a rich context for understanding the meaning of a term.

### 2.3.5 Informational Media Browser

Several instructors have expressed a need for presentation aids that would help them convey the important conceptual themes to their classes. To speak to this need, the Informational Media module has been included as one of STAR's resources. In all there are 51 informational media presentations available to students and instructors. Each informational title has been designed to be a stand alone presentation that can be employed as a multimedia aid to enhance class presentations and discussions.

**Figure 2.5** shows several different ways through which one can browse this information. By clicking on "Organize by FAR Part," users can look for informational pieces based on what FAR(s) these informational media pieces are about. By clicking on "Organize by Information Type," they can browse the informational pieces by their information type. There are nine information types -- certification, difference, example, procedure, responsibility, story, strategy, system, and terminology. By selecting one of these groups, titles covering that type of

information is listed. To view all the titles together, titles can be listed alphabetically. Video titles also can be listed separately.

Figure 2.5 The Glossary

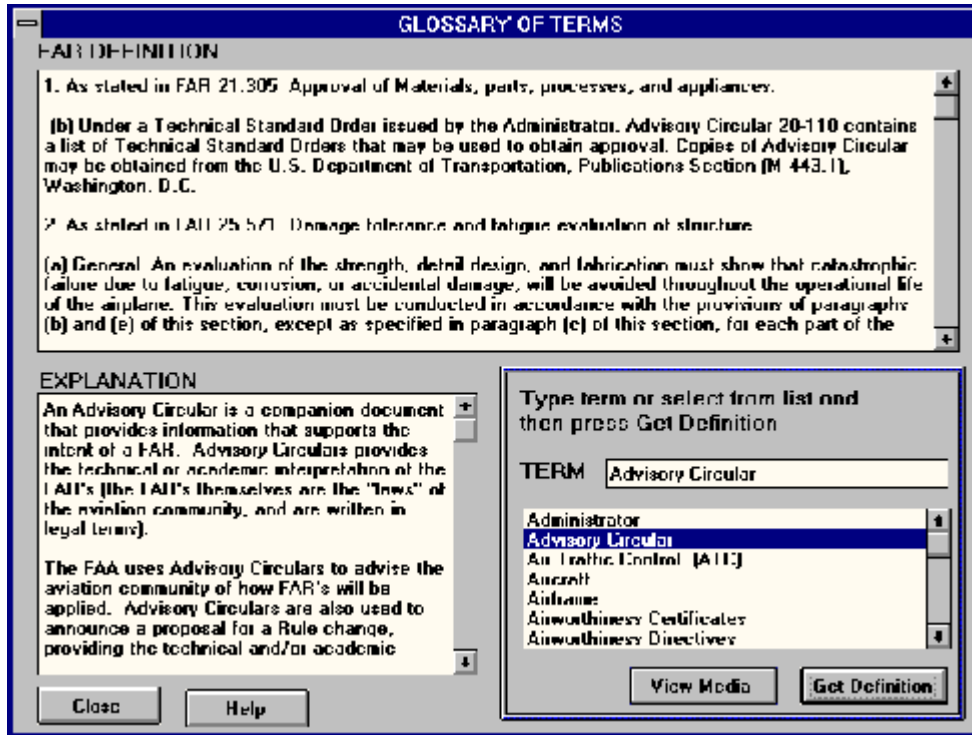
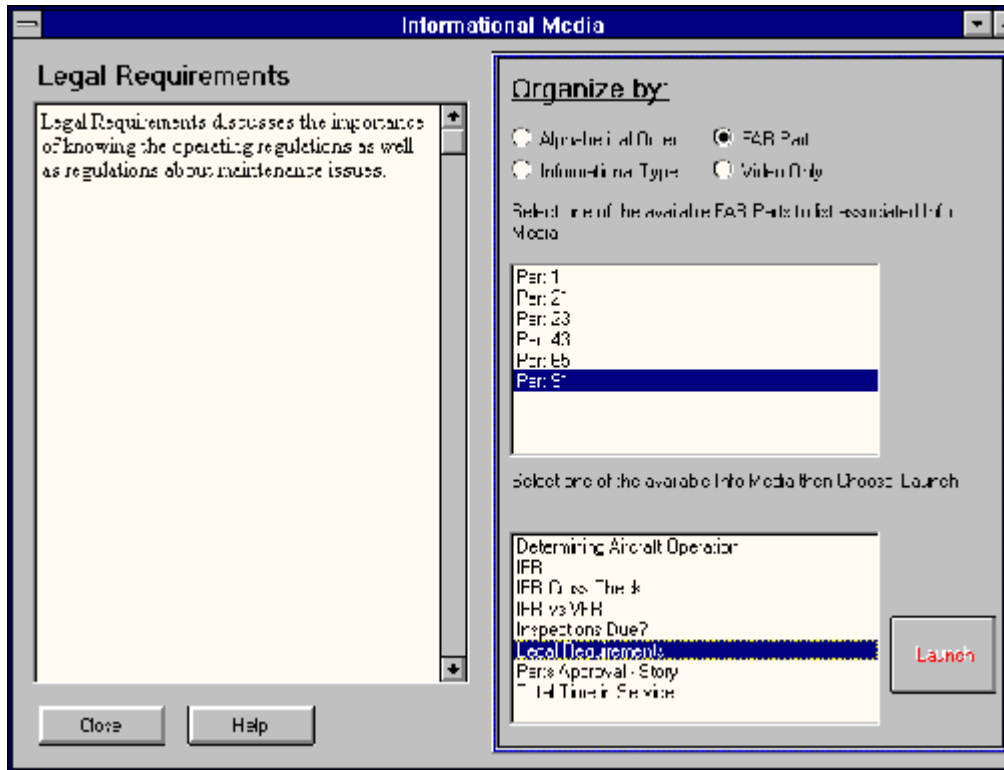


Figure 2.6 Informational Media Browser



### 2.3.6 Document Browser

In the Phase V report the document browser had been promoted as the central unit around which all the other instructional units were connected. Early in the design phase it became apparent that using the document browser as the central organization for instruction would not be the optimal solution for STAR. The main reason was the eventual decision to move away from the Galaxy version of the Hypermedia Information System (HIS) and no longer to support the updating of the FAR publication in house. In an earlier version of STAR the Galaxy HIS document browser was used as the retrieval engine behind an interface written in Visual Basic. This afforded consistent interface design throughout the application and allowed for easy access to relevant informational media associated with the FARs.

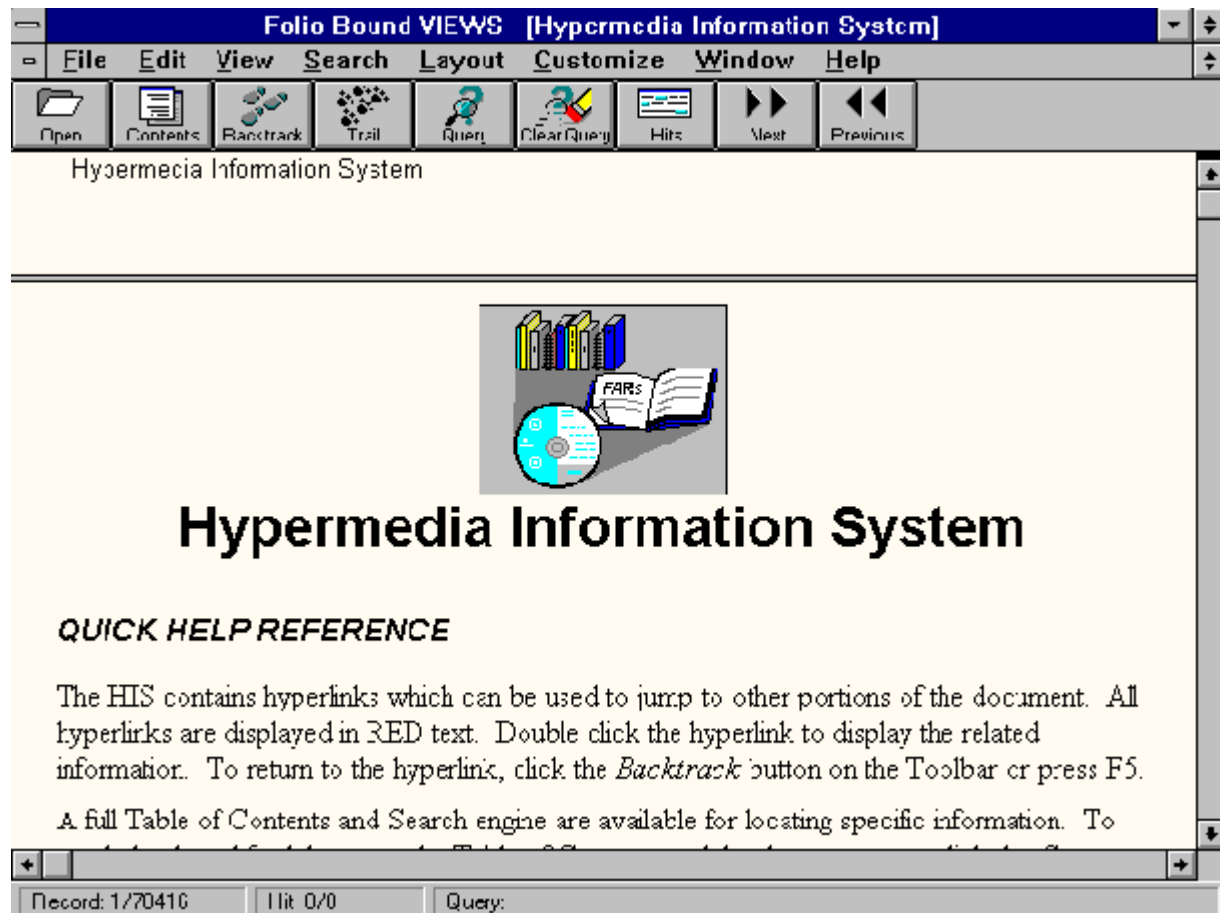
The disadvantage to this initial approach was that the combination of the Visual Basic interface with Galaxy's HIS made the browser so slow that the subjects in the first evaluation thought the module was broken. More flexibility in organizing the informational media was possible by decoupling informational media from the browser. Finally, the decision no longer to support updates of the FARs (because other vendors were in a better position to support such work) solidified the decision to de-emphasize the document browser as the organizing theme for the other instructional units.

Since these decisions, the Galaxy's HIS has been converted to the Folio format (**Figure 2.7**). The Folio version of HIS is launched when the user requests to see the document browser from HIS. When the user is finished he closes Folio and is returned to STAR. This is the most effective way for providing a quick and efficient document browser through STAR. The one drawback to this approach is that the interface for Folio HIS is different from the STAR



interface. This can be a point of confusion for users.

**Figure 2.7 Document Browser**



## 2.4 THE EVALUATIVE STUDIES

STAR has been subject to three in-house critiques and two evaluations by end users in the field. Both evaluations are considered formative, since STAR is a long term and evolving project. The first evaluation was conducted in July, ten months into the projects start, and focused on usability issues such as navigation, screen design and perceived conceptual understanding. At that time STAR consisted of an overview of FARS related to Part 91 General Operating Rules as they pertained to the work of the AMT, one scenario about special inspections, a document browser and a listing of the informational media titles.

Evaluation 2 was conducted four months later in November. At the time of the second evaluation most of the suggested design changes had been incorporated into STAR and several modules had been added. A new scenario, New Technician, addressing privileges and limitations of new AMT's, was added as well as the Glossary. The new browser had not been ported completely to Folio at the time of the second evaluation, consequently a Document Browser was missing from the STAR for the second evaluation. Evaluation 2 also covered usability issues because the

subjects filled in the same assessment questionnaire that was administered to the first evaluation. The second evaluation, however, was concerned with identifying what kind of learning would occur from the STAR experience. Sections 2.4.1 and 2.4.2 gives an in-depth description of the two studies.

### **2.4.1 Evaluation 1: System Understandability**

The intent of the first evaluation was a formative study to determine system understandability that included content accuracy, information presentation and ease of use (Maddox & Johnson 1986). The research team was also interested in what aspect of the program worked well, what needed to be changed, and where additional instructional help would be needed.

#### **Subjects and Method**

Nine students from a Part 147 School of Aviation Maintenance participated in the first evaluation. Five 486 Multimedia equipped PCs complete with CD-ROM players and earphones for audio were provided by Galaxy over a three-day period. The nine students were divided into two groups and rotated through the lab. Each student worked on the same machine each day. Without any introductory instruction on how to use the program, the students were given three one-hour sessions to use STAR. Researchers were available to answer any questions that might arise. This approach was taken to see how intuitive the interface was to the individuals. Points of confusion were noted by the researchers. Based on the type of questions asked and points of confusion encountered by the subjects, the program would be altered and instructional aids developed to address those points of confusion.

At the start of the browse period students were given a questionnaire about their computer experience and when they last took the Federal Aviation Regulations and Document Research class. At the end of the exposure to STAR they were given a three-page questionnaire that included nine dimensions for evaluating important features of interactive multimedia. Notes were taken during each session and a discussion of the program completed the treatment part of the study.

In a more casual setting five instructors spent an hour and a half the second afternoon of the three-day session. Researchers were informed of their computer background and the instructors were asked to fill out the same questionnaire the students had been provided. Four out of the five instructors turned in their questionnaire and several instructors stayed afterward to discuss the program.

The subjects who participated in the second evaluation also filled out the system understandability questionnaire. Some of the discussion of the results of these questionnaires will be covered with in the discussion of the second evaluation where the three groups can be compared.

#### **Theoretical Foundations and Instrument Design**

The approach to both evaluative studies has been influenced by the theoretical foundations of Dr. Thomas Reeves, at the University of Georgia, for evaluating interactive educational multimedia.

Reeves defines evaluation as the process of providing information to enlighten decision-making that will improve the quality of learning (Reeves, 1991). Every new science, according to Reeves, passes through a series of stages that might be described as description, prediction, control and explanation. Instructional technology, as a science, suffers from a lack of fundamental work at the descriptive level (Reeves, 1991). Educational research has been in too big a hurry to do comparative studies before the nature of treatment introduced is fully understood. Because of the inherent complexity of the educational process, it is important to conduct descriptive and case-oriented studies to preserve the inherent complexity of the educational process. The descriptive approach will allow the design process to evolve to progressively more effective instructional treatments. This is not to say measurements should not be made, only that measurements should be made to indicate strengths and weaknesses in the program, not for the sole purpose of proving or disproving interactive multimedia as good or bad when compared to traditional pedagogy.

Evaluation 1's assessment questionnaire was developed based on dimensions covering interactive learning systems, outlined in **Table 2.1**. These were developed by Reeves' research team at the Department of Instructional Technology at University of Georgia. These ten dimensions are designed to provide a basis for understanding, communicating, and evaluating important features of interactive multimedia (IMM) (Reeves 1993).

The evaluation questionnaire (see **Appendix 2.A**) was divided into three sections -- program operation, screen design, and content. Each section has three dimensions, shown in **Table 2.2**, based on a scale of ten, one is designated as least favorable and ten is designated as most favorable perception of that dimension. Each dimension is followed by two or three short answer questions. These questions were designed to elicit specific instances of the subjects' thinking that would exemplify why they scored a particular dimension one direction over another. For example, for the dimension information relevance, the two follow-up questions, "Did you find any information that was particularly relevant or interesting to you?" and "Did you find any information not relevant or uninteresting?", were designed to elicit more specific responses to the general question "Did you find the information in STAR relevant to learning about the FARs?".

**Table 2.1 Ten Dimensions for Evaluating Important Features of Interactive Multimedia (IMM)**

From Tom Reeves' Systematic Evaluation Procedures for Instructional Hypermedia/multimedia (1993).

1. **Ease of Use** is the perceived facility with which a learner interacts with an IMM program.
2. **Navigation** is concerned with the perceived ability to move through the contents of an IMM program in an intentional manner.
3. **Screen design** is the degree that the program adheres to general principles of screen design
4. **Media** integration is how well an IMM program combines the different media to produce an effective whole.
5. **Aesthetics** refers to the artistic aspects of IMM programs.
6. **Cognitive load.** IMM requires different mental efforts than performing learning tasks via print or

other

nonprint media. In order to make a meaningful response to IMM, learners must cope with and integrate at least three cognitive loads or demands, i.e.,

- (a) the content of the program,
- (b) its structure, and
- (c) the response options available.

**7. Mapping** refers to the program's ability to track and graphically represents to the user his or her path through the program

**8. Knowledge space compatibility** is the network of concepts and relationships that compose the mental

schema a user possesses about a given phenomenon or topic.

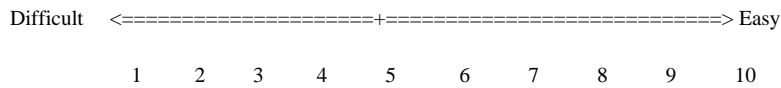
**9. Information presentation** is whether the information contained in the knowledge space of an IMM program is presented in an understandable form.

**10. Functionality** is the perceived utility of the program.

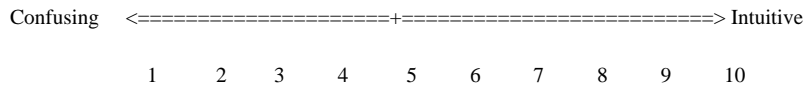
**Table 2.2 System Understandability Dimensions on Questionnaire**

**I. Program Operation**

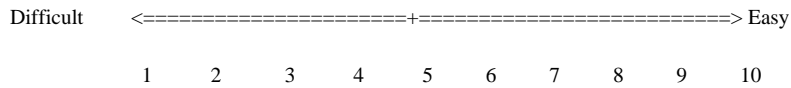
**Ease of Use**



**Intuitiveness**

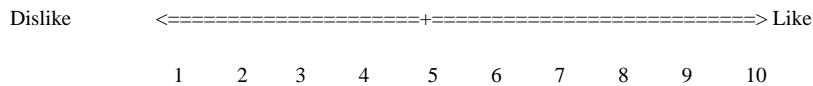


**Navigation**

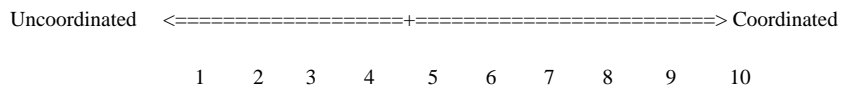


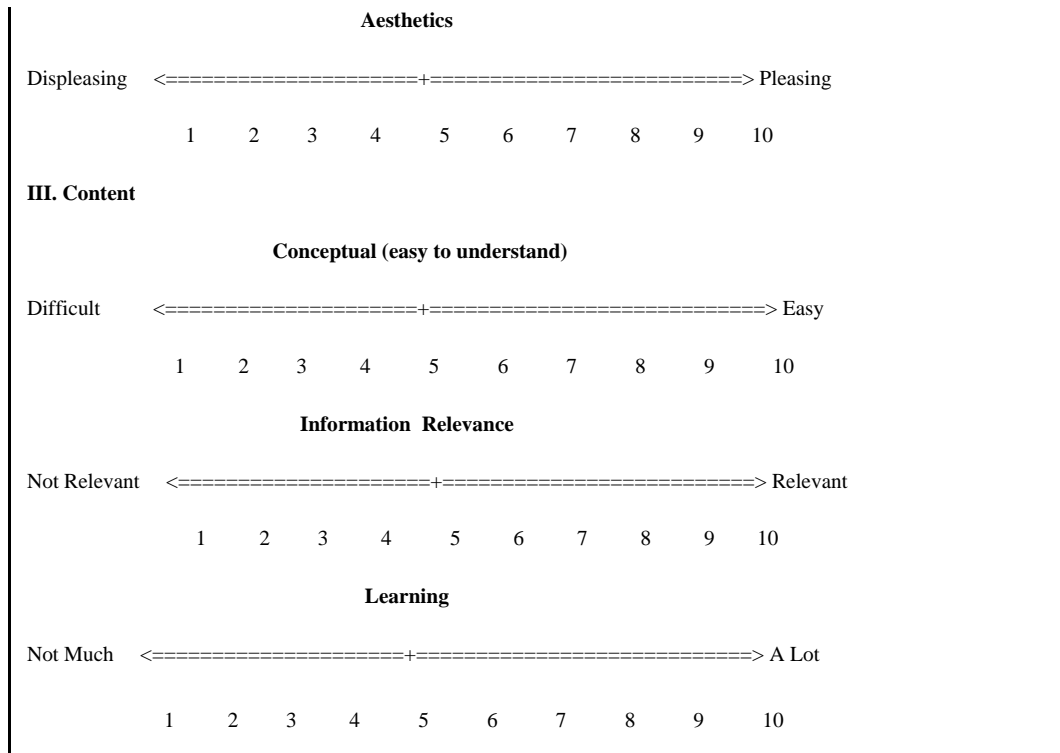
**II. Screen Design**

**Display**



**Media Integration**





## Results

### Subject Background

Eight of the nine students in the study had had the document research course one quarter ago. One student had not taken the course. As shown in **Table 2.3**, students have had more exposure to computers than instructors. Students consistently scored the program higher than the instructors when looking at the scores for the nine system understandability measures. Students tended to give scores in the 8.5 range whereas instructors tended to give scores in the 6.0 range.

**Table 2.3 Computer Experience**

	<b>Never</b> (or maybe once)	<b>Seldom</b> (once or twice a month)	<b>Frequently</b> (once a week)	<b>All the Time</b> (two or three times a week)
Evaluation 1 Subjects (N = 9)		<b>2</b>	<b>7</b>	
Instructors (N = 5)	<b>4</b>		<b>1</b>	

### System Understandability Dimensions

When looking at the individual dimensions, the students scored the three dimensions of the

program operation -- ease of use, intuitiveness and navigation -- in 8 range, while instructors scored program operation in the 5 range (**Figure 2.8**). Both groups scored screen design higher, the students in the 8 to 9 range, the instructors in the 6 to 7 range. Content got a more varied response. Students scored "how easy the information was to understand" and the relevance of the information in the 9's and 10's. Instructors gave conceptual understand their highest rating in the 8's but information relevance only averaged 6.25. When asked how much they felt they learned. Student's gave STAR an average score in the 7's. Instructors gave their lowest average score of 4.5. Students and instructors' comments about how they perceive STAR as an instructional tool, as well as the observations by the researchers of the two groups will be presented in the discussion section.

### *Short Answer Questions*

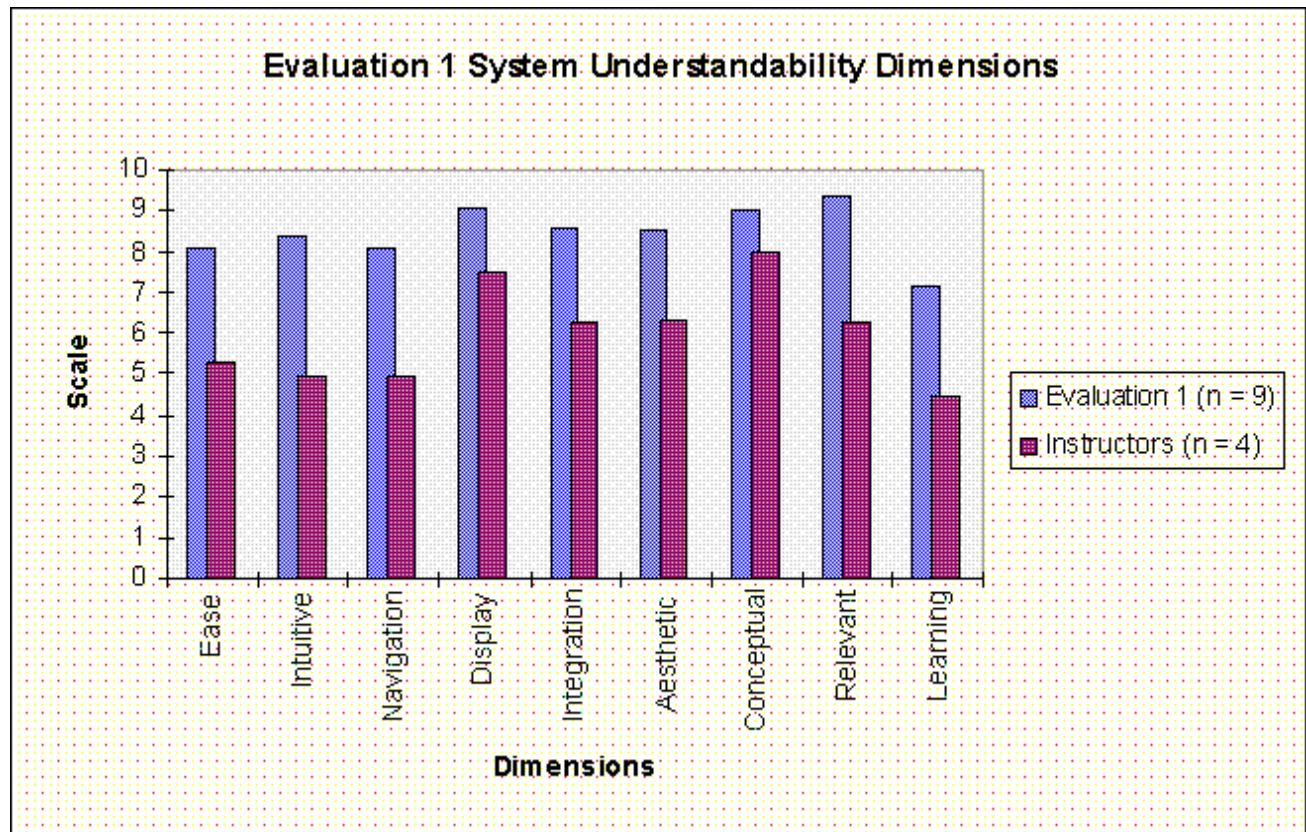
**Table 2.4** shows the students' and instructors' responses to specific questions about ease of navigation and their use of the help file. Unfortunately the instructors tended to skip some of these questions, but the general trends are clear. Every one felt that the directions were sufficient to get them started. However, all the instructors and half the student's became disoriented at some point in the program. Students tended not to access the help file and in general felt that the directory, overview and scenarios were easy to navigate. Two few of the instructors answered these questions to detect a trend. Further discussion of the subjects' comments, drawn from the short answer questions, will occur during the analysis of the second evaluation where a comparison between the two student groups can be made.

### Discussion

Students had a more positive attitude toward and experience with STAR than their instructors. Their level of comfort was evident from the fact that the subjects did not hesitate to explore the STAR environment and needed little help to find their way around. They were familiar with the general principles of using a mouse and were comfortable with navigating through the Windows environment.

Even when confused or when the system faltered students were resilient. They simple raised their hands for help and then got back to work. The instructors were much less comfortable with the computers and as a result they had a less favorable experience with STAR. Many of the instructors lacked the basic skill set that would have enabled them to feel comfortable browsing through the application. They experienced more disorientation and were less resilient to unexpected changes to the program.

### **Figure 2.8 System Understandability Dimensions**



**Table 2.4 Questions about Navigation and Help\***

Questions	Eval 1		Instructors	
	YES	NO	YES	NO
Directions sufficient?	9		4	
Access Help?	3	6	2	1
Help Helpful?	3			2
Get to module from Directory easily?	9		1	1
Overview easy navigate?	6	1		1
Scenario easy navigate?	8			1
Ever feel lost / disoriented?	5	4	4	

What makes this situation serious is the fact that the instructors are the gatekeepers to what is introduced into the system. With computer technology being quickly integrated into all aspects of our working and leisure life and computer based training increasingly becoming a component of education, particularly in the work place, it is important that instructors are not left behind.

Several changes have been implemented in STAR as a result of comments and observations during the first evaluation. These are listed in **Table 2.5** and a discussion of each follows.

**Table 2.5 Changes to STAR**



1. Refinement of Scenario Map design
2. Redesign of the Document Browser
3. More explicit introductory information
4. Refinement Overview navigation
5. Added content covering more fundamental concepts about understanding the intent of the FARs

1. No one seemed to interpret the **Scenario map** correctly without explicit instruction. Even though the written instructions said to "click on the scene label to go to that scene", only one person interpreted that instruction correctly. Most subjects clicked on the instruction itself and when nothing happened they closed the map in confusion. Obviously more explicit instruction was needed.
2. **The document browser** was so slow during the first evaluation that people thought it was broken. This prompted Galaxy to move the Hypermedia Information System to Folio-based technology. It also persuaded the STAR team to move away from writing a separate interface (in Visual Basic). As mentioned before the trade-off here is having a consistent interface versus having an efficient one.
3. It became apparent from subjects initial disorientation that more explicit **introductory information** particularly at the directory level was need in addition to the help file. Though the questionnaire (see [Table 2.4](#)) did not bear this out, it was evident to the researchers through observation that the **Help file** was not helpful. The primary reason has to do with who sought help. Those seeking help tended to be subjects who have had little or no previous computer experience. They were looking for "how to use the mouse" or "what is a button?" types of information. The STAR help file does not supply that kind of information. To compound the issue, the help file uses the standard Windows help application, an interface with which beginners are not familiar. Beginners had to learn the help interface in order to get help. Those familiar with basic computer browsing techniques did not feel the need for help. In this sense the researchers concluded that Help was no Help. A more complete introduction that users can refer back to, consistent with the STAR interface, was developed to address this issue.
4. From comments and observations there seemed to be general confusion between the different instructional levels of the **Overview**. For instance, subjects sometimes assumed that the button label "End Introduction" meant ending the overview when it actually meant ending the introduction to the overview. The overview was still to come. Simple changes of this nature to the interface have rendered the overview more understandable.
5. Some of the instructors **curricular concerns** have been addressed, in the sense that, more scenarios have been developed that cover basic understanding of privileges and limitations for AMTs. The Glossary also addresses some of these basic concepts. The Glossary not only defines a term, but more importantly, shows the relationship between how the term is used in the work place versus how it is used in within the FARs.

Instructors had some legitimate concerns about the content of STAR. One of the main activities in a typical class is reading passages from the FARs and then discussing the intent of the regulation contained in the passage. Some of the instructors expected drill and practice of activities such as this. While this is a reasonable request and certainly could be done, the researchers decided not to replace activities that are already done well and regularly in the classroom setting. Instead, STAR addressed other difficult concepts that instructors had identified as troublesome. The main one the STAR project addressed is conveying the "big picture" to the students. STAR gives students a perspective for why the FARs are important for them to understand and follow. STAR's curriculum addresses questions along the lines of "What is the relationship of the FARs to the AMT's work?", "What are the relationships of the FAR parts to one another?", "What function does each Part of the regulations have?" "What are the privileges and limitations AMT's have in a given situation?", "What are the AMT's responsibility to following those regulations?", and "What are the AMT's responsibilities with respect to informing the customer about those regulations?".

That being said, there is a vehicle within STAR in which curricular concerns raised by the instructors could be addressed directly. This would be the design and implementation of the Challenges learning environment. Originally the primary purpose of the Challenges learning environment has been to promote the integration of material covered in the other learning environments, with the students' own understanding of the domain. Understanding the intent of specific passages in the FARs through drill and practice exercises certainly could be included as one of STAR's self-testing activities.

## **2.4.2 Evaluation II**

### **Subjects and Method**

The second evaluation sought to discern not only whether or not learning occurred but what kind of learning occurred. The sample was composed of two classes of five students from a Part 147 school who were currently tasking the documents research class. The morning class was composed of what is thought of as a typical class: full-time students ranging in age between 18 and 25 years. The evening class was composed of a varied student body. They ranged in age from their early 20's into their 70's. These students were night students holding down a day job. Since the sample size was small (ten students), and the two classes so varied in composition, a comparative study between a treatment and a control group was not made. All ten students worked with the computer application. Pre- and post tests were taken before and after the treatment and comparisons were made between each student's gain or loss for his overall scores and for scores within each test segment.

The study was conducted over a one week period. Each student was provided with a 486 multimedia PC with CD-ROM capability and ear phones. All STAR media was run from the CD-ROM. The morning class took their pretest on Monday. On Tuesday they were instructed to browse the application until they felt they had covered the material. They were provided with a maximum of three one-hour periods before taking the post test. Most of the morning students felt they were ready after a little over two contact hours with STAR; taking the post test on the fourth day of the five-day sequence. The evening class held one and a half hour classes Tuesday

through Thursday. This group was given an hour to complete the pretest on the previous Thursday. They were then provided with a total of two one and a half hour sessions to explore STAR. On the following Thursday evening they were given a one hour post test. The evening group averaged 2.5 hours for the total time spent on STAR.

One potential compounding factor that might have influenced the scores of the morning group is the "lunch" factor. It became evident shortly after administering the post test that some of the students in the morning group were rushing through the test. The conjecture is that they were more interested in getting out early for lunch than applying themselves to a test that did not affect their grade. This attitude may have affected their performance on areas of the test where thoughtful answers were demanded. Areas of the test that may have been affected will be pointed out in the results section. This was not a factor for the evening group.

On the second day of their exposure to STAR the ten subjects also filled out the same questionnaire that was administered to subjects in the first evaluation. Since STAR had been enhanced based on the feed back from the first evaluation subjects, the research team expected to see improvements in perceived system understandability by the second evaluation group. The results of their questionnaires are presented alongside the results of the first evaluation for comparison.

### The Instruments

Both the pretest (**Appendix 2.B**) and the post test (**Appendix 2.C**) were composed of five sections. The first three sections were short answer covering material in the Overview, The New Technicians Scenario (scenario 1), and the Special Inspections Scenario (scenario 2). Section four was composed of standardized multiple choice questions found in typical tests for AMT certification. The questions were similar in content to the content covered in STAR. The last section was a series of true/false questions covering Privileges and Limitations of AMT's. Privileges and limitations are one of the overriding themes in the STAR curriculum. The total points for each of the tests were based on a scale of 110. In addition, one "bonus" question was imbedded in each of the three sections, Overview, Scenario 1, and Scenario 2. These three questions demanded much more detailed information about the FARs than generally expected of students. They were placed in the post test to discern the level of detail that students were retaining information. These questions were dealt with separately from the rest of the test since students were not expected to get these right.

Usually the tests these students are accustomed to taking are either true/false, fill in the blank, or multiple choice. The testing skills required by these types of questions are primarily recognition. In contrast three-fifths of the test items for the pre- and post tests are short answer. Short answer questions require recall as well as integration of concepts. Consequently these tests are more difficult than what the students would normally experience in their class or on the certification test. We chose this format because we wanted to see the level at which students had integrated the concepts from STAR into their own words. When students can articulate correctly a concept in their own words then that concept is well integrated into their mental maps. The research team wanted to analyze that level of integration.

## Results and Discussion

### *System Understandability Questionnaire*

The **Tables 2.6, 2.7** and **Figure 2.9** show computer experience, perceptions about navigation and help and system understandability for both the Evaluation 1 and Evaluation 2 subjects. Students in both evaluations reported having at least some computer experience. As expected subjects of the second evaluation benefited from the changes made to STAR as a result of feedback from the subjects in the first evaluation. The subjects of the second evaluation had less trouble navigating through the system, fewer subjects felt the need to open help, and very few experienced disorientation. These improvements were reflected in the subjects of Evaluation 2's ratings of the program. Evaluation 2 students rated eight of the nine dimensions higher than Evaluation 1 giving an average rating of nine to most of the dimensions while the average ratings were in the eight range for the students of the first evaluation. Higher ratings were noticeably higher for dimensions related to program operations (i.e., ease of use, navigation and intuitiveness) as well as perceived learning.

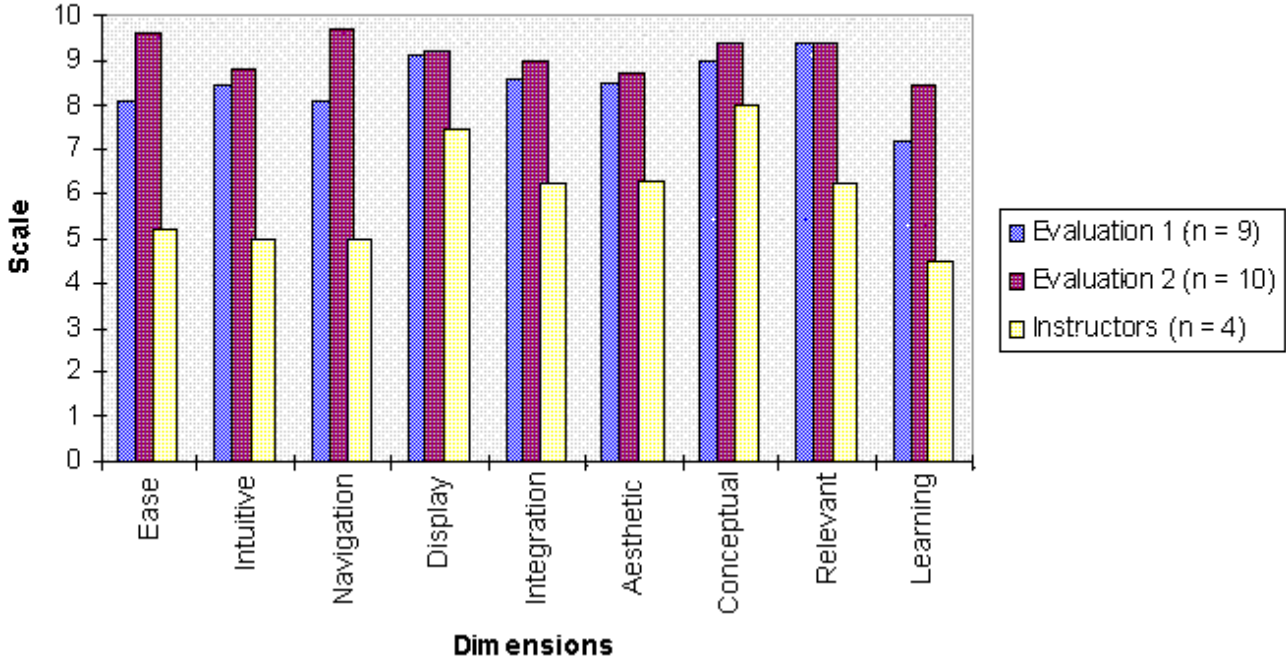
<b>Table 2.6 Computer Experience</b>				
	<b>Never</b>	<b>Seldom</b> (once or twice a month)	<b>Frequently</b> (once a week)	<b>All the Time</b> (two or three times a week)
Evaluation 1 Subjects (N = 9)		<b>2</b>	<b>7</b>	
Evaluation 2 Subjects (N = 10)	<b>1</b>	<b>5</b>	<b>2</b>	<b>2</b>
Instructors (N = 5)	<b>4</b>		<b>1</b>	

<b>Table 2.7 Questions about Navigation and Help*</b>						
<b>Questions</b>	<b>Eval 1</b>		<b>Eval 2</b>		<b>Instructors</b>	
	<b>YES</b>	<b>NO</b>	<b>YES</b>	<b>NO</b>	<b>YES</b>	<b>NO</b>
Directions sufficient?	9		10		4	
Access Help?	3	6	2	8	2	1
Help Helpful?	3		1	1		2
Get to module from Directory easily?	9		9	1	1	1
Overview easy navigate?	6	1	10			1
Scenario easy navigate?	8		10			1

Ever feel lost / disoriented?	5	4	2	8	4
-------------------------------	---	---	---	---	---

**Figure 2.9 Evaluation 1 & 2: System Understandability Dimensions**

**Evaluation 1 & 2: System Understandability Dimensions**



Based on their written comments, the students found the navigation of STAR a little confusing at first but easy to figure out. The second group did not feel they had trouble navigating STAR. Several thought that navigating the scenario was easier than the overview, which was a surprise to the researchers since they thought the opposite would be the case.

Both groups generally liked the displays though many did not like the videos. The videos were too small and not of a high enough quality to see what was going on. Comments about the video quality unfortunately reflect industry wide limitations rather than design or implementation issues related to STAR. Until full screen computer video is reliable and wide spread across the customer base developers will continue to receive complaints about this technology.

Two subjects mentioned they liked the photos better than the graphics while other subjects cited specific graphic displays they particularly liked. These responses are important from a cost perspective. As long as the subjects of the photos are volunteers, photographs are the least expensive medium for media enhancement. The main advantage of using graphics over photos is the flexibility in depicting the themes in the scenarios and concepts in the informational media.

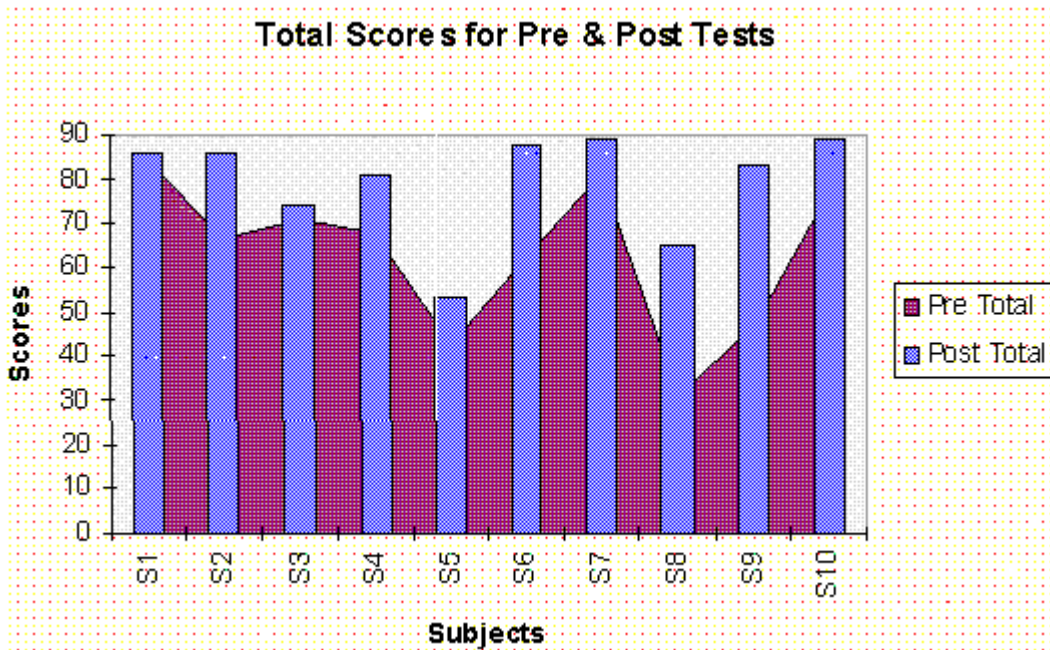
Conceptually the subjects thought the concepts were explained well. There seemed to be an even distribution between those who particularly valued the Overview and those who valued the scenarios as most relevant. When subjects identified aspects of STAR they found particularly

interesting or informative, they usually cited one of the informational media titles. Several cited the stories as most interesting; a couple of subjects sighted the glossary as being particularly useful to understanding the FARs. Except for the document browser (which was not available to the subjects in Evaluation 2), every learning module in STAR was cited by more than one person as being informative or useful to them.

**Conceptual Understanding Results**

**Figure 2.10** shows the overall test scores for both groups. The subjects in the morning class are S1 to S5 and the subjects for the evening class are S6 to S10. Most students showed improvement from the pretest to the post test, though the evening group shows a more substantial gain than the morning group. When viewing the average test scores between sections (see **Table 2.8**), both groups showed substantial gains for the sections about the first and second scenarios and a moderate gain in the section on privileges and limitations. The evening group showed dramatic gains in the Overview section, but the morning class did not do well on the post test. As a group, their scores were below their performance in the pretest. The performance for the two groups on the standardized questions remained about the same. Two individuals in the evening group did not do well on this section, which dropped the group's average post test score below their pretest. The other four in the evening group did as well or slightly better on this section.

**Figure 2.10 Total Scores for Pre & Post Tests**



<b>Table 2.8 Pre and Post Test Scores for Each Subsection</b>										
Classes	Pre Overview	Post Overview	Pre Scenario 1	Post Scenario 1	Pre Scenario 2	Post Scenario 2	Pre Standard	Post Standard	Pre Priv/Lim	Post Priv/Lim
		Morning	18.4	15.6	12	15.6	15	20	11.4	12.6



9.8	12.2									
Evening	12.4	24	9	16.4	11.6	18.6	12.6	10.8	11	12.6
Both	15.4	20	10.6	16	13.3	19.3	12.	11.7	10.4	12.4

When analyzing individual test scores, four of the ten students showed a gain of 20 or more points between pre- and post test (**Table 2.9**). Three students showed a gain of ten or more points and two students showed gains of less than ten points. Greatest gains were seen among subjects who had scored less than 70 points on the pretest. In a two cases more than 30 points were gained from one test to the next. Gains were less dramatic for those scoring over 70 points on the pretest, either showing a gain of about ten points or in a couple of cases showing no gain between tests.

**Table 2.9 Individual Gains or Losses Between Pre and Post Test**

Name	Pre Total	Post Total	Difference
S9	47	83	36
S8	31	65	34
S6	62	88	26
S2	66	86	20
S4	68	81	13
S10	77	89	12
S5	43	53	10
S7	81	89	8
S3	71	74	3
S1	85	86	1

### *Conceptual Understanding Discussion*

Even though this is a tiny sample and there are some compounding factors obscuring the results of the test data performance trends are positive. STAR seems to be most beneficial to students who initially showed little understanding of how the FARs are applied to the daily operations of an AMT. Two of the subjects who benefited the most from the STAR experience were students whose primary language was not English. This may indicate that STAR could be beneficial for foreign students. The pervasive use of audio narration complementing the text may have given the added scaffolding foreign students needed to boost their comprehension level. This is an area where further studies would be informative.

There also seems to be evidence of a ceiling effect. Those who scored reasonably well on the pretests did not experience the dramatic gains experienced by those who struggled with the pretest. This seems to indicate that STAR is particularly well suited for curriculum review or remedial work, particularly for students who have not as yet comprehended the "big picture." The disturbing difference between performance between the morning and evening group is attributed in part to the "lunch factor" mentioned earlier. The morning group did particularly poorly on the Overview section which required the most thoughtful answers to the test and happened to be the first section on the tests. Other sections could be answered more quickly and



the morning group showed better performance in these sections.

There are trade-offs between an open exploratory approach such as that incorporated in STAR with a more lock step training program. In an open approach there is less control over the specifics of what is learned. Each individual will incorporate different details of the program into their conceptual map. If the goal, however, is to provide the students with mechanisms for acquiring a global understanding for how and why the FARs are part of their daily operations then particular details themselves are less important as long as what details are internalized are internalized within a sound conceptual scheme. The Challenge learning environment would add more structure to the existing exploratory framework by providing students with a self testing mechanism for what they are learning and would help to focus students on the more salient concepts that need to be taught. With the addition of the Challenge learning environment STAR would become a more interactive and less purely didactic system for the students to explore.

## 2.5 FUTURE DIRECTIONS FOR STAR, PHASE 7

Starting in Phase VII the STAR approach will be applied to a new target population in the aviation community. We are exploring the feasibility of using the star format to train Aviation Safety Inspectors (ASIs). This R&D effort may provide ideas for full scale implementation by FAA trainers, and may provide information how well the STAR approach can be reconfigured to speak to the training needs of a different group within the training community. STAR was originally designed for students in a Part 147 school. The research challenge for this Phase Seven will be to integrate training within the daily operations of a working environment. What components of STAR will best serve the training needs of this group? How will as needed training be seamlessly incorporated into the daily operations of the work so that training becomes part of and not an addition to the work routine? These questions will be the central focus for the STAR project during Phase Seven.

## 2.6 REFERENCES

- Brewer, W., (1987). Schemas versus mental models in human memory, in *Modeling Cognition*. P. Moris (Ed.), John Wiley & Sons, New York, pp. 187-197.
- Brown, J., A. Collins, & P. Duguid, (1989). Situated cognition and the culture of learning. *Educational Researcher*. 18, pp. 32-42.
- Chandler T., (1994). The science education advisor: Applying a user centered design approach to the development of an interactive case-based advising system. *Journal of Artificial Intelligence in Education*. 5(3), pp. 283 - 318.
- Cognition and Technology Group at Vanderbilt, (1992). The Jasper experiment: An exploration of issues in learning and instructional design. *Educational Technology Research and*

*Development. 40(1), pp. 65-80.*

Maddox, M. E., Johnson, W. B., (1986). Can you see it? Can you understand it? Does it work?: An evaluation plan for computer-based instruction. <> Nuclear Power Systems. *American Nuclear Society*, Knoxville, TN.

Park, O., (1994). Dynamic visual displays in media-based instruction. *Educational Technology. 4*, pp. 21-24.

Park, I., & M. Hannafin, (1993). Empirically-Based Guidelines for the Design of Interactive Multimedia. *Educational Technology Research and Development. 41(3)*, pp. 63-83.

Reeves, T. C. (1991). Ten commandments for the evaluation of interactive multimedia in higher education. *Journal of Computing in Higher Education. Vol. 2(2)*, 84-113.

Reeves, T. C. (April, 1993). Systematic evaluation procedures for instructional hypermedia and multimedia. Paper presented at the *Annual Meeting of the American Educational Research Association*, Atlanta, Georgia.

Spiro, R., & P. Feltovich, (1991). Cognitive flexibility, constructivism, and hypertext. *Educational Technology, 31*, pp. 24-33.

## 2.7 APPENDICES

### 2.7.1 Appendix A: Evaluation 1 Questionnaire

Questions About the Program

Initials \_\_\_\_\_

This questionnaire is intended to give the designers of STAR information about how well the program performed for you. There are two types of questions to be answered short answer and dimensional scale. For each section the dimensional scale questions come first followed by the short answer questions. For the dementia scale questions you are asked to rate the program on a scale of 1 to 10 by circling the number that comes closest to your rating.

#### I. Program Operation

##### 1. Ease of Use

1a. Please circle the number on the dimensional scale below that indicates how easy you found STAR to use.

Difficult <=====+=====> Easy  
1 2 3 4 5 6 7 8 9 10

2. Intuitiveness

2a. How intuitive is the interface?

Confusing <=====+=====> Intuitive  
1 2 3 4 5 6 7 8 9 10

2b. Were the directions sufficient to get you started?

2c. Did you access help?      Once inside help could you find the information you needed?

3. Navigation

3a. How easy was it to navigate through STAR?

Difficult <=====+=====> Easy  
1 2 3 4 5 6 7 8 9 10

3b. Could you easily get to the module you wanted from the directory?

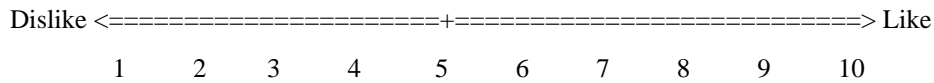
3c. Did you find the scenario easy to navigate? How about the Overview?

3d. Did you ever feel lost or disoriented? If so when and where?

## II. Screen Design

### 4. Display

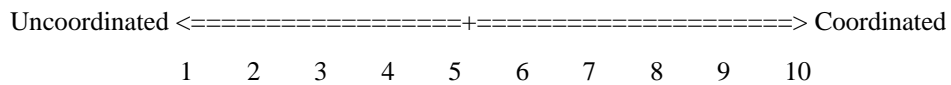
4a. How did you like the STAR displays?



4b. Were there any displays you particularly liked? Disliked? Why?

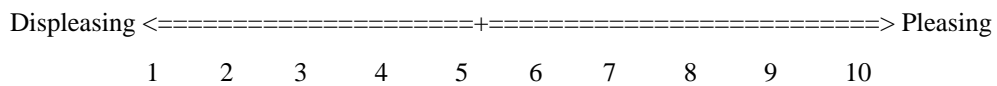
### 5. Media Integration

5a. How well was the media integrated?



### 6. Aesthetics

6a. Did you find the interface design aesthetically pleasing?



## III. Content

### 7. Conceptual

7a. How easily could you understand the information presented to you?

Difficult <=====+=====> Easy  
1 2 3 4 5 6 7 8 9 10

7b. Was there any information that you could not understand?

7c. Was there any thing that was explained particularly well?

8. Information Relevance

8a. Did you find the information in STAR relevant to learning about the FARs?

Not Relevant <=====+=====> Relevant  
1 2 3 4 5 6 7 8 9 10

8b. Did you find any information that was particularly relevant or interesting to you?

8c. Did you find any information that was not relevant or uninteresting?

9. Learning

9a. How much do you feel you learned from using STAR?

Not Much <=====+=====> A Lot  
1 2 3 4 5 6 7 8 9 10

**2.7.2 Appendix B: Evaluation 2 PreTest**

Pretest: System for Training in Aviation Regulations (STAR)

Initials \_\_\_\_\_

## **Short Answer**

1. What is a Federal Aviation Regulation?
2. What is the function of the Operating Regulations? Give an example of an Operating Regulation.
3. What do airworthiness standards communicate to the manufacturer?
4. What types of logs need to be kept for an aircraft?
5. What are the five components to complete a maintenance log entry?
6. Describe the relationship between Part 91, Part 43 and Part 65.

## **Scenario 1**

You are a student in an F.A.A. approved part 147 school. You have just completed your airframe rating and have your temporary certificate. During your last airframe class you met another student, Bill Johnson, who already has a power-plant rating obtained through experience. Bill advised you that his family owns an I.F.R. equipped Cessna 172 and you will be welcome to come for a ride some time. Today he and his father approached you with the following proposal. The Cessna is due a one hundred hour inspection because Mr. Johnson occasionally operates for hire. They propose that you team with Bill to conduct and approve the one hundred hour inspection. Mr. Johnson warns you that he has flown 4.5 hours since the inspection was due.

**Based on this scenario answer the following questions. Justify your answers with references to the appropriate FARs.**

1. If you have a temporary certificate for the airframe rating can you conduct a 100 hour inspection?

2. Can you inspect an aircraft that is past its due date for an inspection?
  
3. How could you determine if Bill is an acceptable technician to perform and approve the powerplant portion of the inspection?
  
4. How long can a technician go without performing an inspection before they lose their currency?
  
5. What is the policy for sharing inspection duties?

## **Scenario 2**

You are a technician with both A and P ratings. During a 100 hr inspection on an IFR equipped C-172, you notice that the altimeter and transponder have not been tested and inspected in the last 24 months. When you inform the owner that these tests and inspections are due, he asks: if these tests and inspections are due, why didn't you do them as part of the 100 hour inspection?

**Based on this scenario answer the following questions. Justify your answers with references to the appropriate FARs.**

1. What is the difference between IFR & VFR?
  
2. What is the difference between a test vs an inspection?
  
3. How would you know these inspections are due?



4. How do you respond to the question posed to you by the owner?
  
5. Of the test and inspections required for IFR flight operations what tests and inspections can the A&P perform?

**Multiple Choice: Circle the letter that best answers each question posed below.**

1. After a mechanic holding an airframe and powerplant rating completes a 100-hour inspection, what action is required before the aircraft is returned to service?

- A - Make the proper entries in the aircraft's maintenance record.
- B - Complete an operational check of all systems.
- C - A mechanic with an inspection authorization must approve the inspection.

2. During an annual inspection, if a defect is found which makes the aircraft unairworthy, the person disapproving must

- A - remove the Airworthiness Certificate from the aircraft.
- B - submit a Malfunction or Defect Report.
- C - provide a written notice of the defect to the owner.

3. Who is responsible for maintaining the required maintenance records for an airplane?

- A - Authorized inspector.
- B - Certificated mechanic.
- C - Aircraft owner.

4. If work performed on an aircraft has been done satisfactorily, the signature of an authorized person on the maintenance records for maintenance or alterations performed constitutes

- A - approval of the aircraft for return to service.
- B - approval for return to service only for the work performed.

C - only verification that the maintenance or alterations were performed referencing maintenance data.

5. Airworthiness Directives are issued primarily to

A - provide information about malfunction or defect trends.

B - present recommended maintenance procedures.

C - correct an unsafe condition.

**True/False: Circle T (for True) or F (for False) to describe the truth value for each statement below.**

1. T F The A&P certificate is good until age 65.
2. T F A temporary A&P certificate is invalid after 3 months.
3. T F To receive an A&P certificate, the requirements are to pass an oral and written series of tests.
4. T F To receive an A&P license, all series of FAA tests must be completed within 24 months.
5. T F The mechanic applicant must be at least 21 years of age.
6. T F An A&P mechanic must have held his certificate for two years before he can apply for his Inspection Authorization.
7. T F The holder of an Inspection Authorization must conduct one annual inspection in a 12-month period in order to renew his/her authorization?

### **2.7.3 Appendix C: Evaluation 2 Post Test**

**Post-test: System for Training in Aviation Regulations (STAR)    Initials\_\_\_\_\_**

**Short Answer**

- 1 Describe the relationship between Part 91, Part 43 and Part 65.
  
2. What is the function of standard regulations? Give an example of a Standard Regulation.
  
3. What do operating regulations communicate to the owner/operator?
  
4. Is there a relationship between the regulations in Part 45 and Part 47?
  
5. What types of logs need to be kept for an aircraft?
  
6. In a maintenance record entry, when you sign your signature, qualification and certificate number what are you attesting to?
  
7. Who is primarily responsible for the following:
  - A. Ensuring the aircraft is inspected and maintained between inspections?
  
  - B. Ensuring the replacement parts installed on an aircraft are airworthy and approved?
  
  - C. Recording, in the maintenance records of the aircraft, maintenance or preventive maintenance performed on the aircraft?

**Scenario 1**

You are a student in an F.A.A. approved Part 147 school. You have just completed your airframe rating and have your temporary certificate. During your last airframe class you met another

student, Bill Johnson, who already has a power-plant rating obtained through experience. Bill advised you that his family owns an I.F.R. equipped Cessna 172 and you will be welcome to come for a ride some time. Today he and his father approached you with the following proposal. The Cessna is due a one hundred hour inspection because Mr. Johnson occasionally operates for hire. They propose that you team with Bill to conduct and approve the one hundred hour inspection. Mr. Johnson warns you that he has flown 4.5 hours since the inspection was due.

**Based on this scenario answer the following questions. Justify your answers with references to the appropriate FARs.**

1. If you have a temporary certificate for the airframe class can you conduct a 100 hour inspection? Justify your answer.
  
2. Can you inspect an aircraft that is past its due date for an inspection?
  
3. FAR 65.83 specifies the "recent experience requirements" for a certificated mechanic; describe the requirements under subparagraph (b), He has for at least 6 months:
  - A.
  - B.
  - C.
  - D.
  
4. Would your performance test to obtain the airframe rating while at school meet the requirement to have performed the task before? Why or Why not.
  
5. What is the policy for sharing inspection duties?

## **Scenario 2**

You are a technician with both A and P ratings. During a 100 hr inspection on an IFR equipped C-172, you notice that the altimeter and transponder have not been tested and inspected in the last 24 months. When you inform the owner that these tests and inspections are due, he asks: if these tests and inspections are due, why didn't you do them as part of the 100 hour inspection?

**Based on this scenario answer the following questions. Justify your answers with references to the appropriate FARs.**

1. What is the difference between a test vs an inspection?
2. How would you respond to the question posed to you by the owner?
3. Of the test and inspections required for IFR flight operations what tests and inspections can the A&P perform?
4. Why is the test and inspection of the transponder with encoded altitude information a requirement under FAR 91.215?
5. What are the two additional components you need to complete an inspection log entry?
6. What are the consequences of an infraction of the regulations?
7. Why is the self-policing nature of the aircraft maintenance profession the greatest weakness of the system?

**Multiple Choice: Circle the letter that best answers each question posed below.**

1. When approving for return to service after maintenance or alteration, the approving person must enter in the maintenance record of the aircraft.

A--the date the maintenance or alteration was begun, description (or reference to acceptable data) of work performed, the name of the person performing the work (if someone else), signature, and certificate number.

B--a description (or reference to acceptable data) of work performed, date of completion, the name of the person performing the work (if someone else), signature, and certificate number.

C--a description (or reference to acceptable data) of work performed, date of completion, the name of the person performing the work (if someone else), signature, certificate number, and kind of certificate held.

2. If an airworthy aircraft is sold, what is done with the Airworthiness Certificate?

A--It becomes invalid until the aircraft is reinspected and returned to service.

B--It is declared void and a new certificate is issued upon application by the new owner.

C--It is transferred with the aircraft.

3. If work performed on an aircraft has been done satisfactorily, the signature of an authorized person on the maintenance records for maintenance or alterations performed constitutes

A - approval of the aircraft for return to service.

B - approval for return to service only for the work performed.

C - only verification that the maintenance or alterations were performed referencing maintenance data.

4. Each person performing an annual or 100-hour inspection shall use a checklist that contains at least those items in the appendix of

A--FAR Part 43.

B--FAR Part 65.

C--AC 43.13-3.

5. Airworthiness Directives are issued primarily to

A - provide information about malfunction or defect trends.

B - present recommended maintenance procedures.

C - correct an unsafe condition.

**True/False: Circle T (for True) or F (for False) to describe the truth value for each statement below.**

1. T F The A&P certificate is good until age 65.
2. T F A temporary A&P certificate is invalid after 120 days.
3. T F To receive an A&P certificate, the requirements are to pass an oral and written series of tests.
4. T F To receive an A&P license, all series of FAA tests must be completed within 24 months.
5. T F The mechanic applicant must be at least 18 years of age.
6. T F An A&P mechanic must have held his certificate for three years before he can apply for his Inspection Authorization.
7. T F The holder of an Inspection Authorization must conduct two annual inspections in a 12-month period in order to renew his/her authorization?
8. T F The issuance of an Airworthiness Directive is governed by FAR Part 39.

# CHAPTER 3

## ADVANCED TECHNOLOGY APPLIED TO TEAM TRAINING: THE AIRCRAFT MAINTENANCE TEAM TRAINING (AMTT) SOFTWARE

*Anand K. Gramopadhye, David Kraus, Pradeep Rao, Daniel Jebaraj  
Department of Industrial Engineering, Clemson University*

### 3.1 INTRODUCTION

The team training effort for aircraft maintenance technicians (AMT) began in September 1994. The earlier phase of this work investigated the usefulness of team training for aircraft maintenance technicians. The study (**Gramopadhye et al., 1995; Ivaturi, 1995**) developed a framework for understanding teams and teamwork in the aircraft maintenance environment and identified opportunities for incorporating team training within the A & P school curriculum. The results of a controlled study (**Kraus, 1996**) conducted to evaluate the effectiveness of team training were encouraging as to the potential of improving AMT team performance and overall task performance. Drawing from the results of the previous phase, the current phase of the research extended the team training effort into a computer-based team training program--Aircraft Maintenance Team Training (AMTT) software.

### 3.2 ADVANCED TECHNOLOGY FOR TEAM TRAINING

As computer-based technology becomes cheaper, the future will bring an increased application of advanced technology to training. Over the past decade, instructional technologists have provided numerous technology-based training devices with the promise of improved efficiency and effectiveness. Examples of such technology include computer simulation, interactive video discs and other derivatives of computer-based applications (Johnson, 1990), several of which have been employed in aviation maintenance training (Johnson, 1990, Johnson et al., 1992; Shepherd, 1992). Furthermore, multimedia has assisted in teaching difficult and complex skills (Gordon, 1994). In her article on integrated learning systems, White (1993) lists a number of reasons that support the use of computers and multimedia for instruction. These include: a) they provide a systematic exposure of the curriculum, b) they allow individuals to learn at their own pace, c) they can track errors and monitor the users learning progress, and d) they can motivate the user to learn through inter-activity and game formats. In their guide for creating educational software, Chabay and Sherwood (1992) state that interactive software is a two-way, dynamic, and modifiable education medium which is inherently self-paced, repeatable, and potentially non-linear. As such, it offers advantages over other educational mediums such as lectures and textbooks. Emphasizing the versatility of computer applications, Andrews et al., (1992) found



various multimedia technologies to be effective in simulating combat situations for team training in the military. Because of the advantages offered, computer-based training may have a role to play in team training in the aircraft maintenance environment. As part of the effort which examined the application of advanced technology to team training, a computer based team training software--Aircraft Maintenance Team Training Software (AMTT)--was developed.

To ensure that the software addressed the needs of the aviation community, the designers worked in close cooperation with a major aircraft maintenance/repair/overhauling facility (Lockheed Martin Aeromod Centers, Inc.) and an A & P school (Greenville Technology--Aircraft Maintenance Technology Program). Lockheed Aeromod Centers, located in Greenville, South Carolina, was particularly helpful in the development of this program by allowing camera crews to shoot various scenes, by providing employees as actors, and by participating in the usability tests. The instructors at the Aircraft Maintenance School of Greenville Technical College volunteered their time and effort by providing technical input and role playing scenes. The development of AMTT was based on the classical iterative software/instruction development methodology (Gould and Lewis, 1985; Gould 1988). The requirements of the aircraft maintenance environment guided the development of the software program, which was centered on human (AMT) requirements and evolved through appropriate stages of specification, story-boarding, prototyping, development and testing.

### **3.2.1 AIRCRAFT MAINTENANCE TEAM TRAINING (AMTT) SOFTWARE**

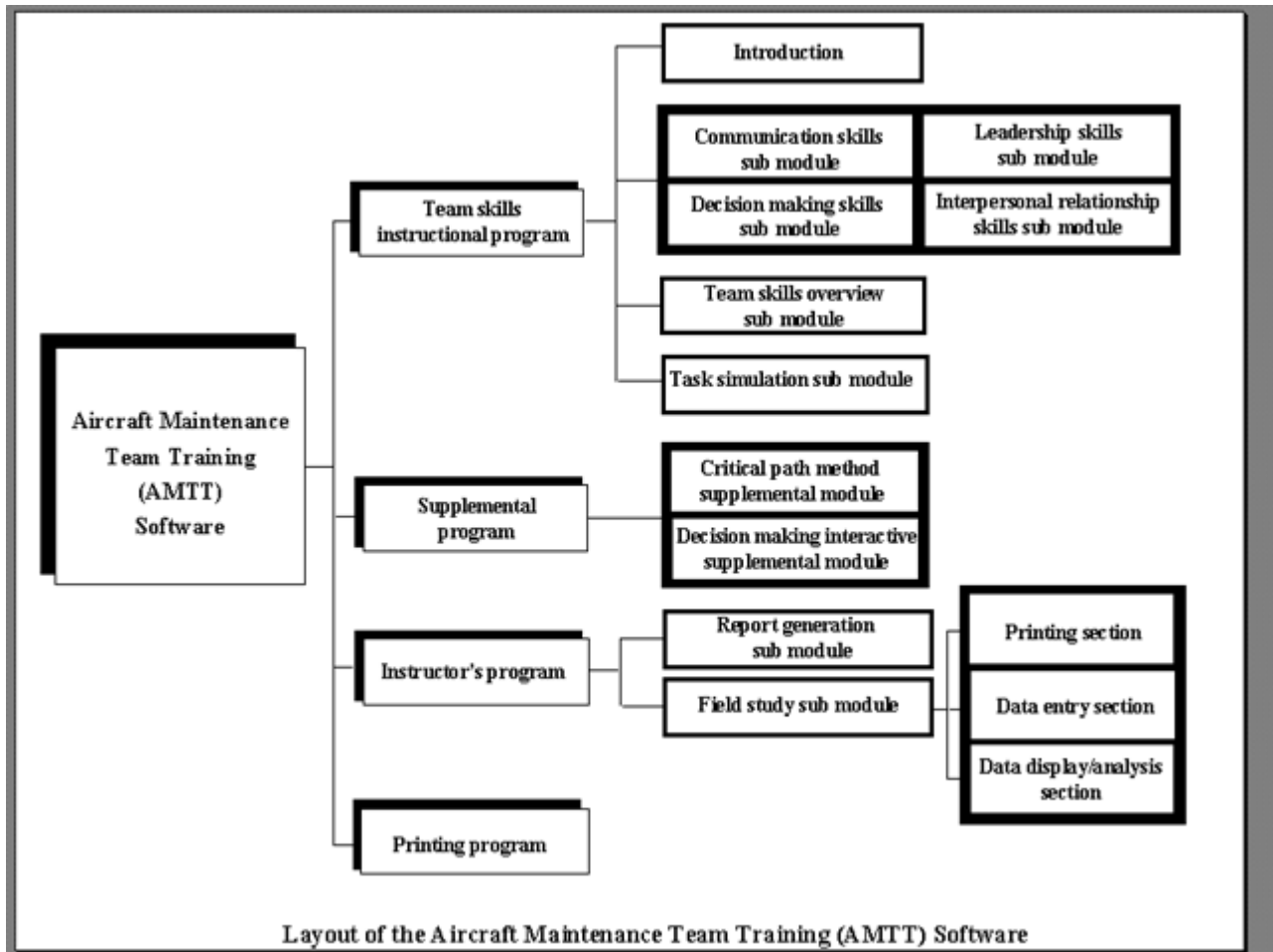
#### ***AMTT Specifications***

AMTT was developed in Microsoft Visual Basic and runs in the Microsoft Windows environment. AMTT uses a 486 DX2 66 MHZ platform, a 15" SVGA high resolution monitor, 16 Mb RAM, 2 Mb Video RAM, MCI compatible sound card, and a multi-speed CD.

#### **Layout of the AMTT software**

Specifically designed for training aircraft maintenance technicians in basic team skills, AMTT uses a multimedia presentational approach with interaction opportunities between the user and the computer. The multimedia presentation includes: full motion videos which provide real life examples of proper and improper team behavior, photographs and animations that illustrate difficult concepts, and voice recordings coupled with visual presentations of the main contextual material. AMTT is divided into four major programs: Team Skills Instructional Program, Instructor's Program, Printing Program, and the Supplemental Program. **Figure 3.1** shows the overall layout of the AMTT software. While the Team Skills Program and the Supplemental Program have been designed for use by the aircraft maintenance technician undergoing team training, the remaining two programs are for use by the instructor/supervisor. An AMT interacting with the AMTT software first uses the Team Skills Instructional program which provides an introduction to the software. Following this step, the AMT is provided with instruction on basic team skills through four team skills sub-modules, specifically, communication, leadership, decision making, and interpersonal relationship.

**Figure 3.1 Layout of the Aircraft Maintenance Team Training (AMTT) software.**



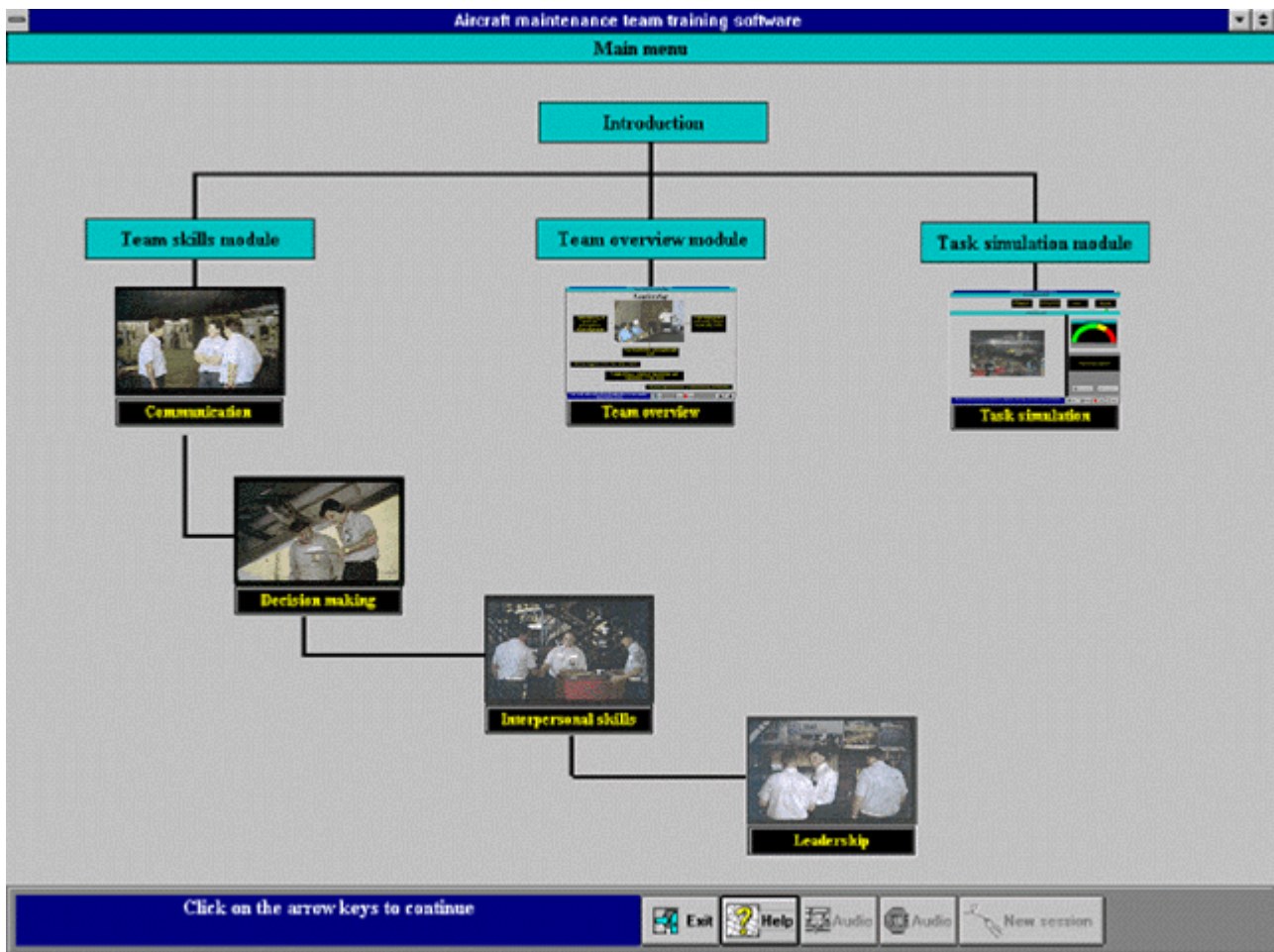
These sub-modules not only emphasize and cover generic material related to these skills but also relate the importance and use of the specific skills within the aircraft maintenance environment. Upon completion of the team skills modules, the information is summarized in the team skills overview module. At this stage, the AMT is ready to use the Task Simulation module, which allows the AMT to apply the skills acquired in the previous four team skills module within an aircraft maintenance situation. The module enables the instructor to test the AMT's knowledge on teams and ability to identify team related problems. In addition to the four basic team skills module, AMTT also provides the AMT with a supplemental program. The supplemental program consists of two separate supplemental modules: the critical path method and interactive decision making. The objective of the supplemental modules is to provide users with hands-on experience in the use of the specific decision making tools in a simulated team environment. It is anticipated that this interactive experience will enhance learning and use of the specific tools in the real world environment. Since the software was developed as both a training and research tool, the software facilitates the collection of pre-training and post-training performance data. The instructor can access and analyze user performance data using the instructor's program. The printing program is an additional utility provided to the instructor to print the various screens in each of the team skills modules and present the information in an alternate instructional format.

All the modules are discussed in greater detail in the following sections.

### 3.2.2 Team Skills Instructional Program

The team skills instructional program consists of the following modules: introduction, team skills, team skills overview, task simulation, and the supplemental. **Figure 3.2** shows the main menu of the team skills instructional program. The various modules in the Team Skills Instruction Program are extremely comprehensive in terms of material covered. As a result, the software will allow the user to complete this instructional program over several separate sessions which could be conducted on different days.

**Figure 3.2 Main menu showing the structure of the team skills instructional program.**



#### [Introduction module](#)

The objective of the introduction module is fourfold. First, it provides the user with definitions of terms and concepts found throughout the tutorial. Team and teamwork are both defined and described, and the types of teams normally found in an aircraft maintenance environment are illustrated. Second, the importance of teamwork and the resulting effects on performance are

detailed. Third, the user is introduced to the organization and layout of the tutorial, thus providing prior knowledge about any questionnaires and/or tests to which he or she must respond. Finally, the introduction collects demographic information on the user.

### **Team skills module**

The objective of the Team Skills module is to provide the user with instructional material in the team skills areas. Team skills factors or skills dimensions have been identified and defined by a number of authors (Cannon-Bower et al., 1993; Glickman, et al., 1987; Nieva et al., 1978). Gramopadhye et al., (1995), and Kraus et al., (1996) describe the six team skills factors that are relevant specifically to the aircraft maintenance environment. Drawing from the task analysis of aircraft inspection and maintenance operations (Drury, 1990; FAA, 1991), site visits and interviews with training personnel and supervisors at aircraft repair and overhaul facilities, review of Aircraft Maintenance Training (AMT) school curriculum and interviews with AMT school instructors, and a literature review of team training material, the skill factors were combined and adapted to form four separate sub-modules: Communication, Decision Making, Interpersonal Relationships, and Leadership. Each of these sub-modules has a similar structure (refer to **Figure 3.3**). The sub-modules start with a questionnaire wherein the user ranks ten subject-related questions on a seven point Likert scale. These questions were based on the Critical Team Behavior Form (CTBF) developed by Glickman et al., (1987). The objective of this questionnaire is to collect the user's perception on specific team skills prior to the training (refer to **Appendix 1** for team perception forms related to communication, decision-making, leadership and interpersonal relationship sub-modules). This questionnaire is followed by a short test containing 20 multiple choice questions that is intended to measure the user's current knowledge on the subject material (refer to **Appendix 2** for tests related to communication, decision-making, leadership and interpersonal relationship sub-modules). Following the questionnaire and the test, the user is presented the instructional material, which is broken down by major topics. After each topic, a multiple choice question is presented to the user that must be answered before proceeding to the next topic. These embedded questions serve two purposes: first, they check to see if the user has understood the material just presented, and second, they reinforce what the user has just learned. On completion of each module, the information is summarized, in a final summary sheet (refer to **Figure 3.4** for a typical summary). The same questionnaire and test questions asked at the beginning of the module are posed to the user at the end to measure both the effect, if any, the subject material had on the user's understanding of the material and any change in the user's perception related to the specific team skill. All answers provided by the user are recorded in the database which can be accessed through instructor's module for later analysis.

**Figure 3.3 Prototypical screen showing the organization of material in the team skills modules.**

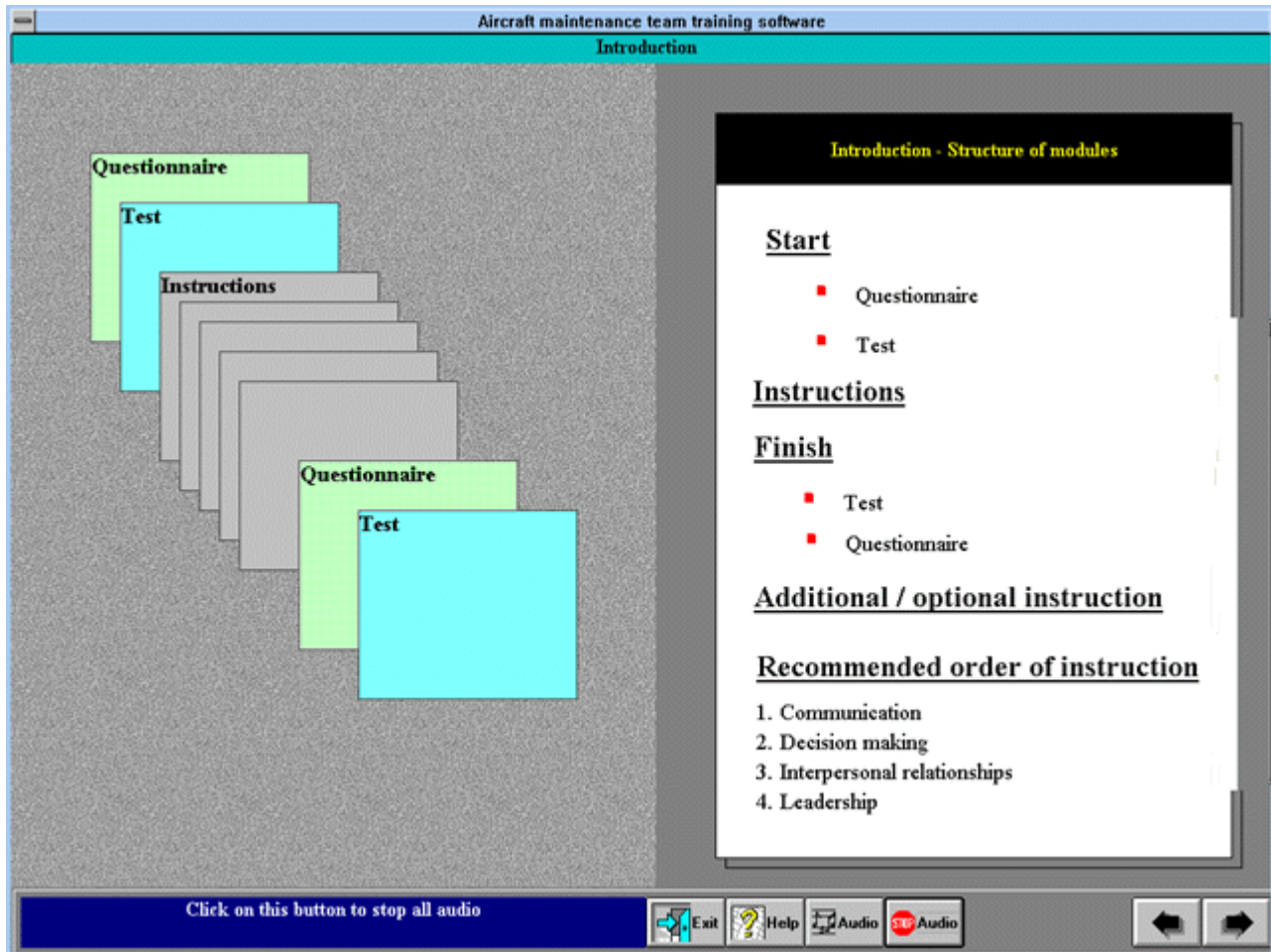
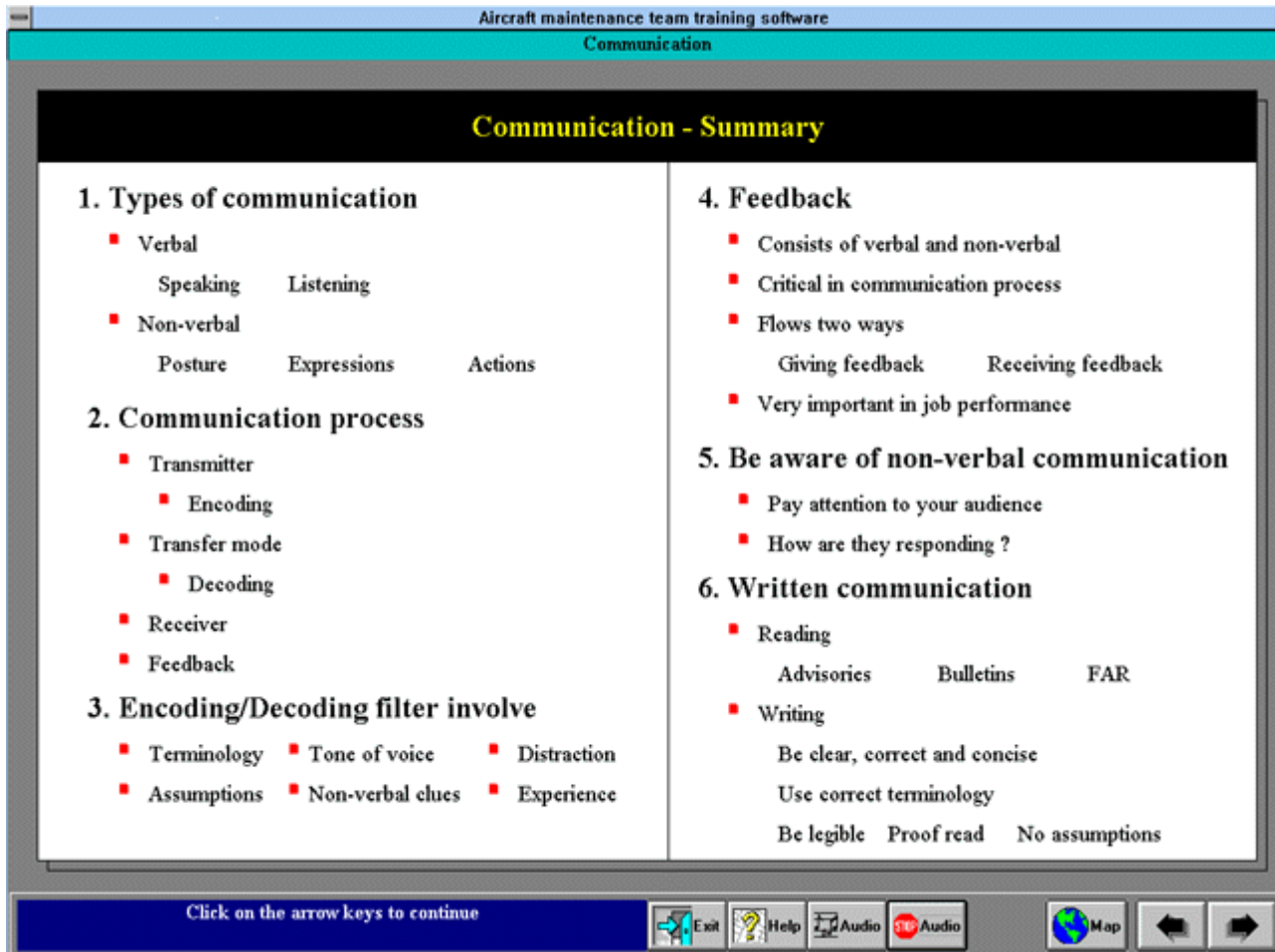


Figure 3.4 A summary provided at the conclusion of each team skills module.




**Figure 3.5** shows a prototypical layout of the team skills module. The right side of the screen is dedicated to key points being discussed in the voice-over, while the left side of the screen provides supporting material. This supporting material comes in a variety of formats which include, but are not limited to, animations, videos, photographs, diagrams, and flow charts. Buttons on the command line at the bottom of the screen can be clicked on to exit, advance, back-up, stop and replay audio, replay video, and access the navigational map. In addition to the advance and forward button on each screen, a navigational map allows the user to navigate through the software. On-line help is also available and is structured similar to Microsoft<sup>TM</sup> help.

**Figure 3.5 Prototypical screen showing the layout of the team skills module.**



Aircraft maintenance team training software  
Communication



**Communication - Non-verbal feedback**

**Example**

- Do you have everybody's attention?
- Is everybody open-minded to what you are saying?
- Is what you are saying too complicated?

Click on the arrow keys to continue

Exit Help Audio Audio Map

## Communication sub-module

Communication between team members is critical to the successful completion of team tasks (Scholtes, 1988). Working with instructors from the Guided Missile School in Norfolk, VA., Hogan et al., (1991) found that the most frequent cause of poor team performance was improper team member communication. To prevent this problem, Hogan et al., (1991) recommend the use of a low fidelity computer-based training program to teach communication skills. Shepherd (1992) explains the importance of communication in the aircraft maintenance environment where technicians must be able to communicate effectively in written and spoken discourse. Addressing these needs, this Communication sub-module was divided into six major topic areas. The first topic examines the different methods of communication in the aircraft maintenance environment. Verbal and non-verbal forms of communication are discussed, and examples are provided which illustrate how individuals communicate through posture, expressions, and actions. The communication process is covered as the second topic. Then, in the following section, those parts of the communication process that are likely to create communication problems in the aircraft maintenance environment are addressed. Fourthly, the importance of feedback on performance is covered, and the proper way to give and receive feedback is presented. Also addressed within the topic of feedback is the concept of active listening. The fifth topic is written

communication, which in the aircraft maintenance industry, comes to the aircraft technician in many forms, with the most critical aspect for the technician being the routine and non-routine work cards. The user is introduced to the importance of these work cards, and through the use of examples, learns how to identify the typical errors made in filling one out. The final topic of this sub-module deals with the proper and improper procedures for a shift change. According to a report by Hackman in 1990 (as cited in Shepherd, 1991), contrary to the dictates of the organization, very little, if any, communication takes place during a shift change. Yet, this is the one critical time when all the various forms of communication come into play--verbal and non-verbal communication, feedback and active listening, and written communication. Through the use of videos, the user sees and hears the incorrect and then the correct procedures for a shift change.

### **Decision making sub-module**

Decision making has been identified as an important teamwork skill dimension (Cannon-Bower et al., 1993). In a team environment, team members must have the ability to gather and integrate information for problem assessment, to generate alternative solutions, to prioritize solutions and make decisions, and to implement their decisions (Scholtes, 1988). Furthermore, the team members need to be aware of specific strategies/tools that can be used in situations when uncertainty or disagreement exists about the nature of a problem and possible solutions (Moore, 1987). The objective of this sub-module is to explain the importance of a well-defined decision-making procedure, to introduce the user to a variety of decision making tools, and to train the user on the proper use of these tools. The Decision Making Sub-module has three main topic areas. The first three topics--problem identification, generation of ideas, and decision making tools--follow the main steps in the decision making process. Later a detailed description of the three decision making tools (Consensus, Multi-voting, and Nominal Group Technique) is presented. Using animation, the user is introduced to the basics on how and when to use the three decision making tools. As part of a separate interactive decision making exercise (Interactive Decision Making supplemental module) the user applies the different tools to resolve a real life aircraft maintenance problem.

### **Interpersonal relationships sub-module**

The importance of interpersonal relationships as a team skill has been recognized by a number of authors (e.g., Cannon-Bower et al., 1993, Ivaturi et al., 1995, and Scholtes 1988). Coovert and McNelis (1992) state that interpersonal skills is one of the major factors that affect decision making in a team, and McCallum et al., (1989) found a positive relationship between supportive behavior and team performance. The purpose in providing training to the user in interpersonal relationship skills is to help them to become more knowledgeable about the effects of various individual behaviors on team performance, to recognize specific behavioral problems that may occur in a team environment, and to deal with those behavioral problems in an effective and constructive manner. The interpersonal relationships sub-module includes a discussion on the various stages of a team's growth, the characteristics of successful teams, and the use of ground rules in a team environment. In the final section of this sub-module, typical personality and behavioral problems that a user may run into are presented in an aircraft maintenance situational



context. The user learns to identify the problems, and to respond with appropriate solutions.

### **Leadership sub-module**

According to McIntyre et al., (1988), proper team leadership has a positive effect on team performance. Burgess et al., (1993) state that the performance of a team is often a direct reflection of ability and performance of the team leader. Swezey and Salas (1991) extracted a number of guidelines for effective team leadership from the literature on teams and teamwork, which were used in developing the Leadership sub-module. The Leadership sub-module not only helps to summarize the previously discussed team skills, but also reviews additional skills that are necessary for both the lead mechanics/supervisors and the aircraft maintenance technicians. The first topic that is covered in this sub-module is the role of the team leader. Team leaders and team members must know and understand the importance of their role within the team and within the organization. In addition, they must recognize various leadership styles and be able to use coaching and counseling techniques in directing their team. The next three topics in this sub-module consist of a review of communication, decision making, and interpersonal relationship skills within the context of leadership and with additional concepts that are germane to proper leadership. The final two topics, which have not previously been covered, include training and coordination. Under the training topic, the need to be proactive rather than reactive is stressed. Leaders (Lead Mechanics/Supervisors) need to be mindful of on-the-job training opportunities, and they must be concerned with the constant upgrading of their team members' skills through off-line training. The final topic addresses coordination. Many authors treat coordination as a separate team skill (e.g., Cannon-Bower et al., 1993; Swezey and Salas, 1992). For the purposes of this tutorial, however, coordination was included as a part of leadership, because a team leader has the responsibility to coordinate activities and resources both at the team level and at the organization level. Since the leadership sub-module addresses both the general team members as well as team leaders, the training information on coordination is available to all tutorial users. Both internal and external coordination are described, and the importance of good coordination skills is highlighted.

### **Team Skills Overview Module**

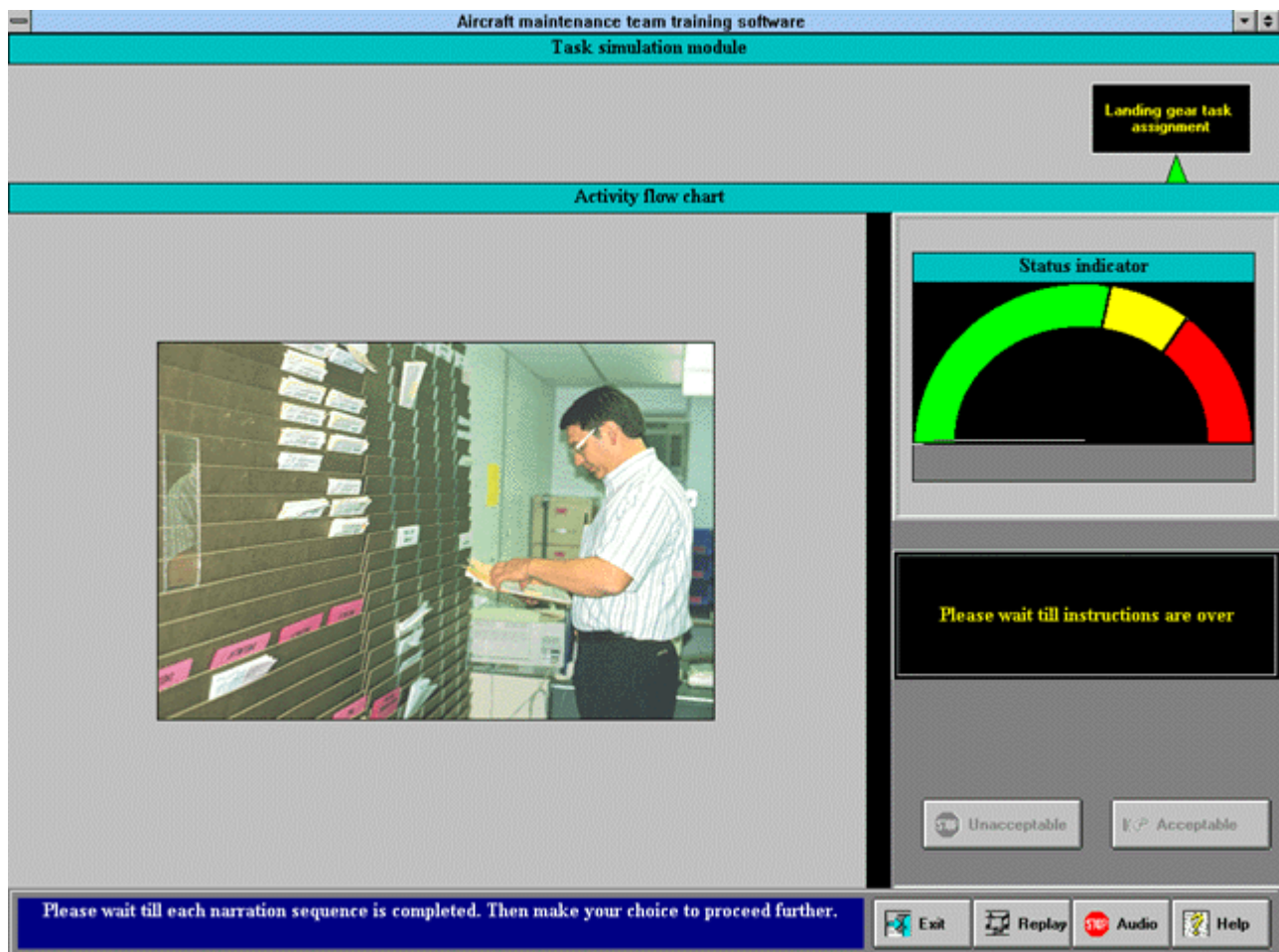
The Team Skills Overview Module was designed to encapsulate all the general information provided in the four sub-modules of the Team Skills Instructional module in a short 10 to 15 minute presentation in the form of a slide show. In this module, the user is not required to interact with the computer. The express purpose of this module is to reinforce the skills that were already covered in the four team skills modules. Also, it serves as a bridge between learning a skill and utilizing that skill. The Team Skills Overview module is intended to be completed prior to using the Task Simulation Module.

### **Task Simulation Module**

The Task Simulation Module was designed to allow the users to apply the skills learned in the team skills instructional module in an aircraft maintenance situation. To make this exercise more challenging, the task simulation module was designed in a game format. To accomplish this, a virtual aircraft maintenance environment is created with a virtual team of seven technicians (one

lead mechanic and six crew members). The virtual team perform three consecutive tasks which require a team effort. These tasks are: performing an extension and retraction test on the landing gears, jacking down the aircraft, and finally, towing the aircraft to another location. A narrative is provided about the crew and their efforts to complete these team tasks. Problems which involve team skills arise in the normal course of work, and the user, acting as a consultant, is queried as to the correct course of action. Each situation is presented as a scene, which the user observes and then evaluates by determining whether the behavior and the actions of the crew are unacceptable or acceptable. To simulate real life, wrong answers are carried forward to a potentially disastrous end. False problems or situations are introduced to determine if the user recognizes when situations are progressing within bounds. **Figure 3.6** shows a prototypical screen of the task simulation module. To assist the user in understanding the story line, photographs of the team members working together are presented on the left side of the screen. Data on user performance is collected and stored in the database for future analysis.

**Figure 3.6 Prototypical screen of the task simulation module**



### 3.2.3 Supplemental Programs

The supplemental program consists of two supplemental modules:

## **Critical Path Method Supplemental Module**

Teamwork often leads to making decisions concerning how to perform or improve future work. Decision making, however, does not end with achieving agreement with all team members. Decisions must be converted into an action plan. The Critical Path Method (CPM) Supplemental Module was developed to teach the user the most common methods of scheduling and analyzing a team process (Paulson, 1995). After the user is introduced to the background and uses of CPM, the module proceeds to instruct the user on how to construct CPM diagrams using the activity-on-node approach. **Figures 3.7** through **3.9** are prototypical screens from the CPM module covering the basics on CPM. CPM networks can be used to answer "what if" types of questions to help determine the impact of a decision before implementation. The impact of changes are taught with a series of "what if" exercises to help the user understand the process, to practice calculating critical paths, and to demonstrate how the critical path may become altered due to minor changes in resources. The supplemental module concludes with a practical exercise in which the user observes an aircraft towing task. The task is shown in full motion video and can be reviewed as many times as necessary. Users are tasked with identifying the various activities involved in towing an aircraft, listing those activities on a table which is provided, *inputting* activity time intervals, and identifying the predecessor and successor activities for each activity needed to form a completed network. On completion, a "school" solution is provided for comparison with the user's solution.

**Figure 3.7 Critical Path Method: instructional screen.**

Aircraft maintenance team training software  
Critical path method

## Developing a network

Conventional notation

Duration = X

ES	EF
LF	LS

EF = ES+Duration(X)

Moving from left to right, you solve for early finish

Moving from right to left, you solve for late start and late finish to find the date for project to start to meet the required finish date

Click on the <Stop Audio> button to stop audio play

Exit

Audio

Audio

←

→

Introduction

When to use?

Development

Construction

Exercises

Map

Help

Simulation

Figure 3.8 Critical Path Method: instructional screen.

Aircraft maintenance team training software  
Critical path method

## Developing a network

Process redesign

Planning should lay out the process

Identify all needed resources

Identify reasonable time estimates for each activity

Identify all constraints and dependencies

```
graph LR; E1[Event 1] --> E2[Event 2]; E1 --> E3[Event 3]; E2 --> E5[Event 5]; E3 --> E4[Event 4]; E4 --> E5; E6[Event 6] --> E4; E6 --> E7[Event 7]; E5 -.-> E7; subgraph "Series of events"; E5; E7; end
```

Introduction

When to use?

Development

Construction

Exercises

Map

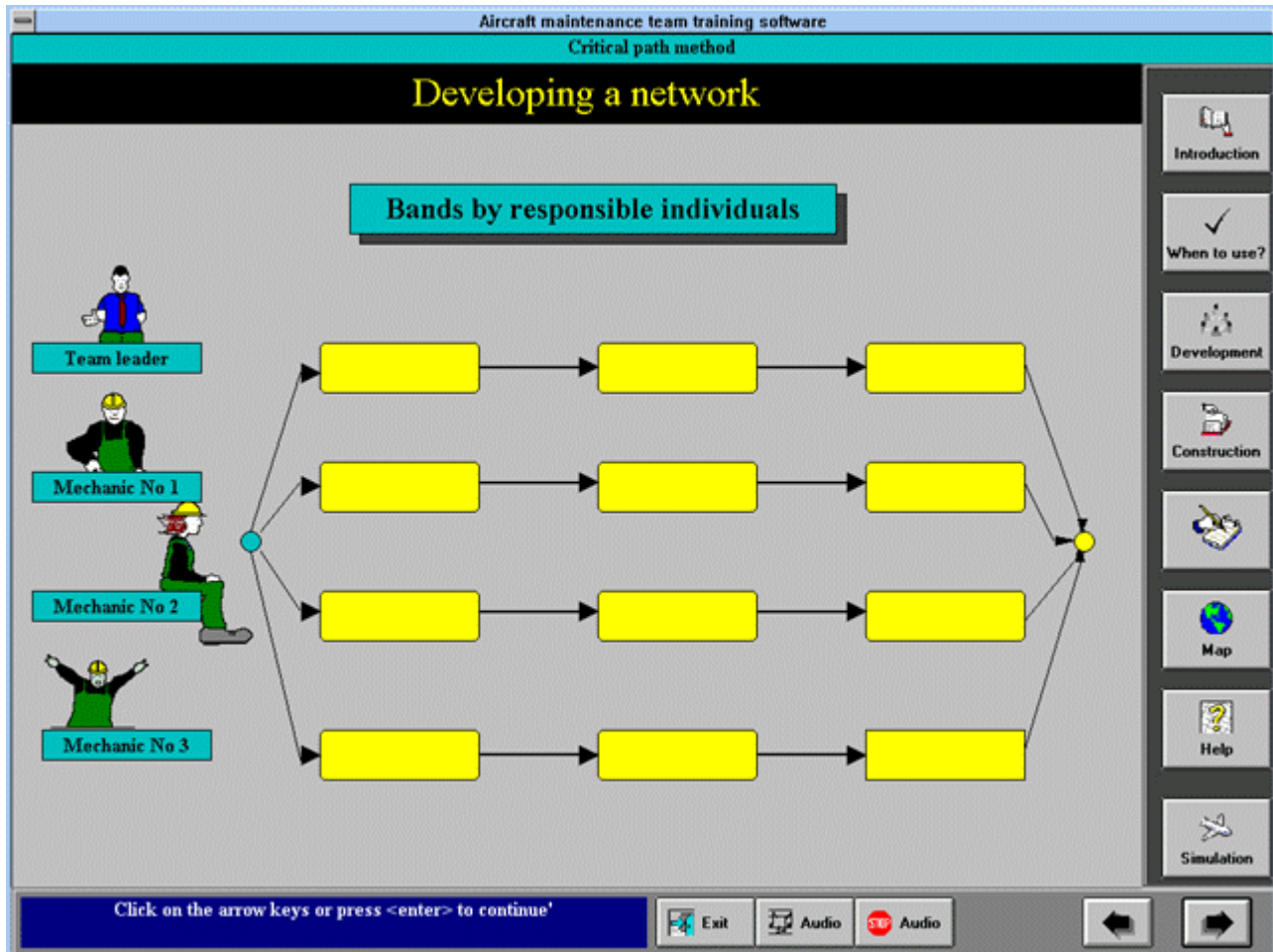
Help

Simulation

Click on the arrow keys or press <enter> to continue

Exit Audio Audio

Figure 3.9 Critical Path Method: instructional screen.

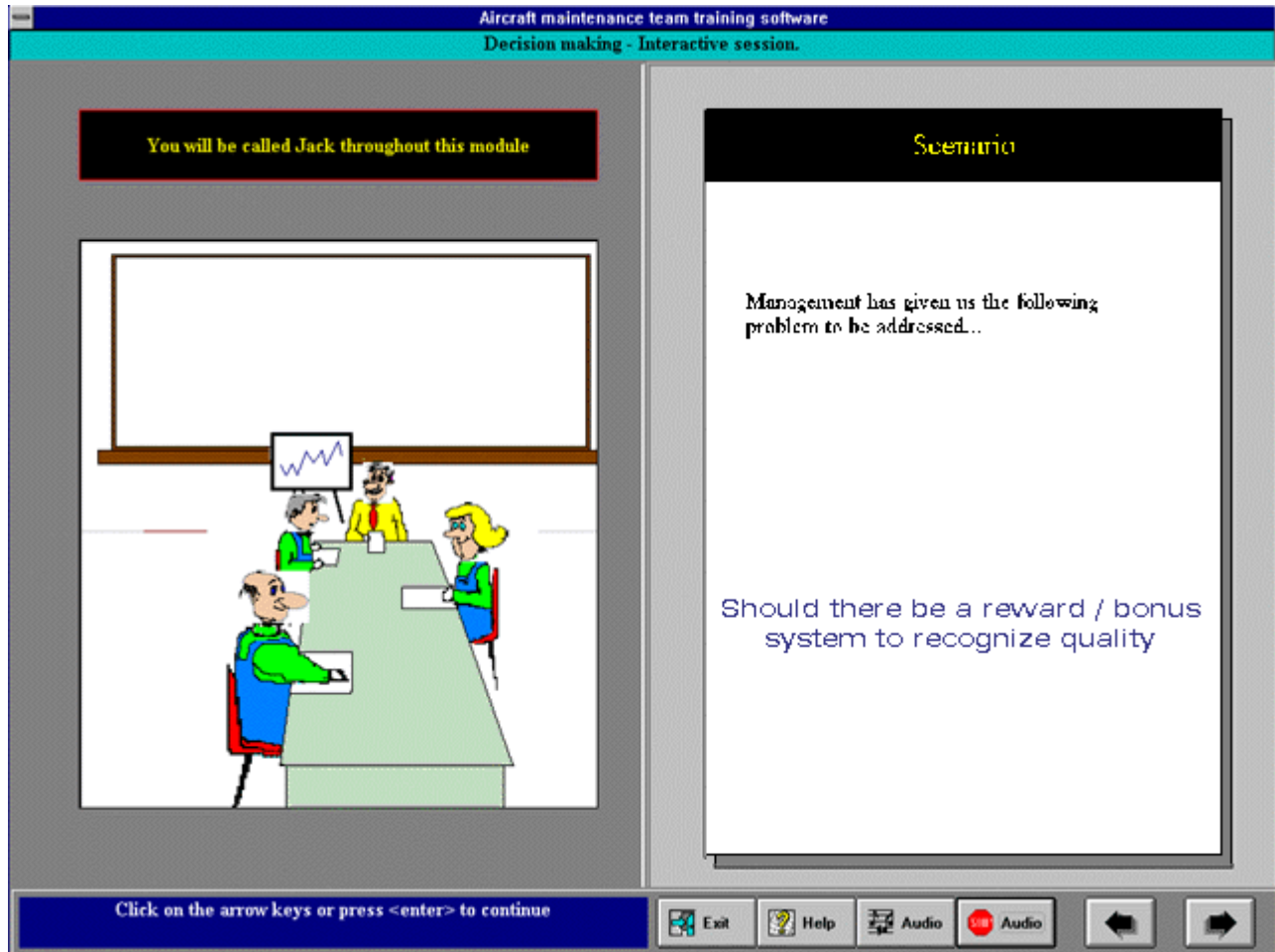


### [Interactive Decision Making Supplemental Module](#)

The objective of this module is to provide the user with an opportunity to apply three different decision making tools in a simulated team environment: consensus, multi-voting and nominal group technique. Thus, the module provides the user with a practical exercise wherein the user interacts with the computer in a decision-making process. To reflect a real life situation, a virtual team environment is created, wherein the user, a member of the virtual team, is posed with a problem which requires a response. The user must interact with "the other team members" by brainstorming ideas and resolving the specific problem either through consensus, or by using a multi-voting decision making technique or the nominal group technique. **Figure 3.10** shows a representative screen from the interactive decision making module.

**Figure 3.10** Representative screen from the interactive decision making supplemental module.





### 3.2.4 Instructor's Program

The AMTT software is both a research and a training tool. As such, data is collected on the user's performance throughout the instructional portions of the tutorial. The main purpose of the Instructor's Program is the collection and analysis of this performance data on each user and team. The Instructor's Program is divided into two modules: Report Generation Module, and the Field Study Module.

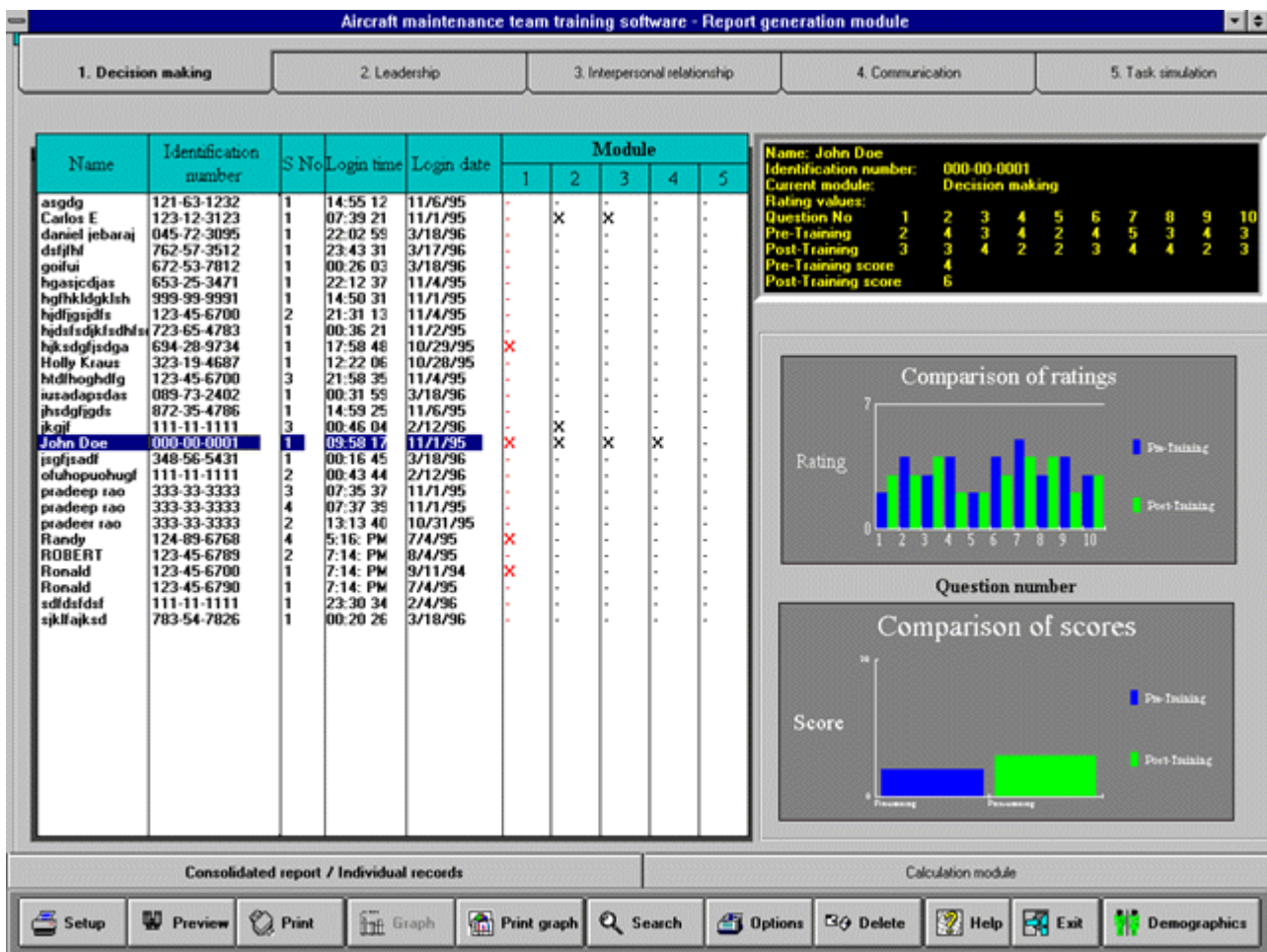
#### Report Generation Module

This module has two major sections: a consolidated report/individual records section and a calculation section. Each of these sections can retrieve and analyze data from the Team Skills Instructional Program. The performance data and demographic information collected in the Team Skills Instructional Program can be accessed through the consolidated report/individual records section. In addition to the user's responses, this program tracks the user's ID, the date and time of each log-on, the session number, and the modules and sub-modules which have been completed. Using this module, the instructor can access and analyze data on user performance. Upon the selection of an identification number, the instructor/researcher may examine the

demographics information, the user's responses to each questionnaire, the scores for the pre- and post test questions, the performance of the user in the Task Simulation exercise, and print graphs/reports of any or all of this data. **Figure 3.11** is a representative screen from the individual records section showing the performance of a user on the decision making portion of the team skills module.

The calculation mode is very similar to the consolidation report/individual records in that performance data and questionnaire responses may be retrieved and analyzed. This mode, however, allows the instructor/researcher to group individuals or multiple sessions of one individual based on teams or date and time of tutorial use. As with the previous mode, the instructor can obtain hard copy printouts of the data.

**Figure 3.11 Representative screen of the individual records section.**



## Field Study Module

At times when an instructor/researcher needs to conduct an evaluation of team training and teamwork in the field or actual working environment, computer support may not be available. It is for this reason that the Field Study Module was designed. The use of this module allows the instructor/researcher to take responses to hard copy printout of the questionnaires and enter those



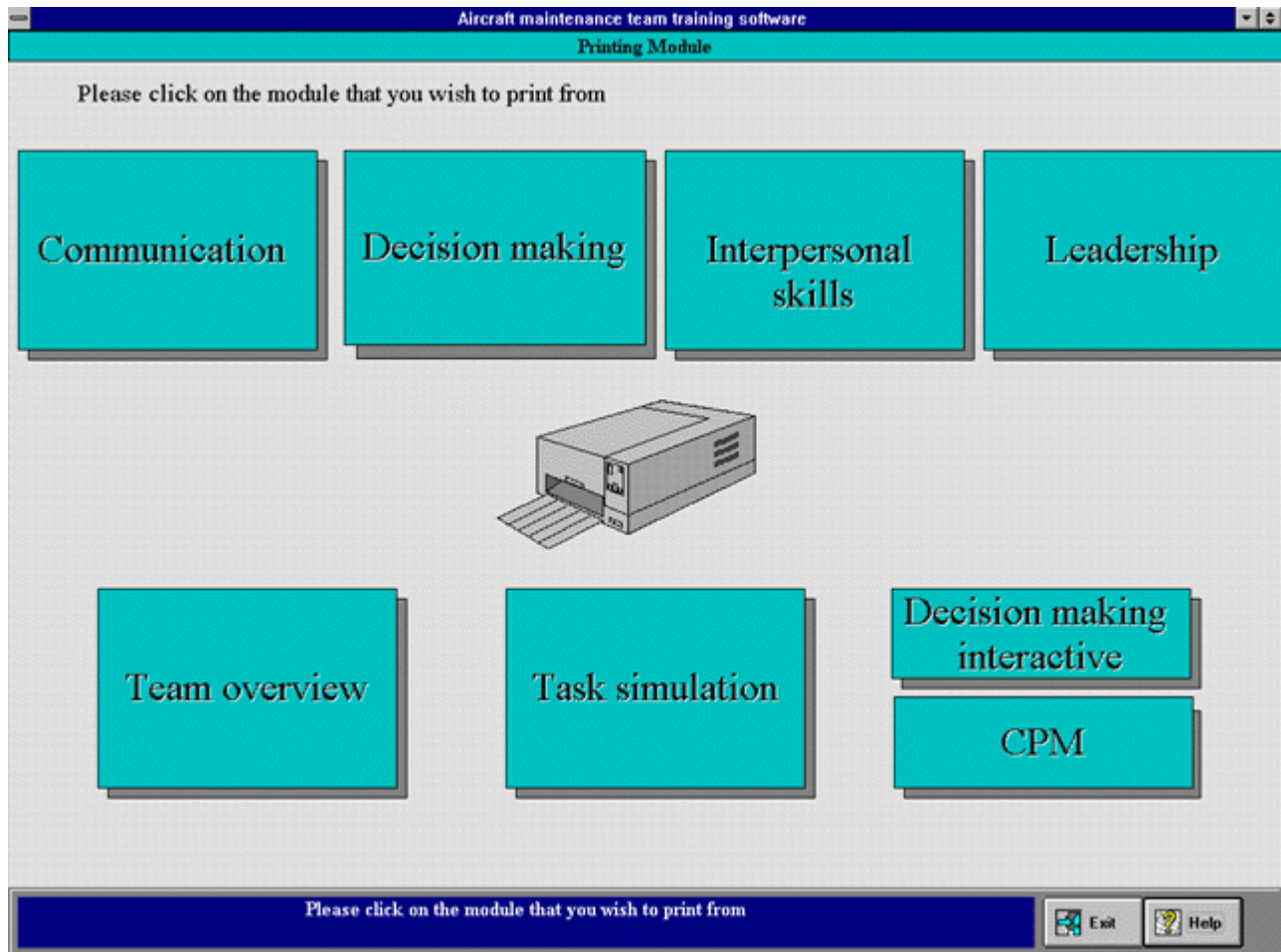
responses into the program for analysis. This module has three major sections: the data entry section, the printing section, and the data display/analysis section.

The data entry section contains three sets of questionnaires for each of the four major skill categories (communication, decision making, interpersonal relationships, and leadership). These questionnaires are adapted from the critical team behavioral forms first developed by Glickman et al., (1987). A student/user may fill out the questionnaire in a paper-based format, and the instructor may then enter the user's responses into the computer. The ten questions in this questionnaire are the same that are posed at the beginning and end of the four skills instructional sub-modules. These questions gauge a user's perception of the various facets of team skills. The remaining two sets of questionnaires are referred to as the Team Behavior Form and the Instructor's Form are both similar in content. While one is to be completed by the team member the other is completed by the instructor. In the Team Behavior Form, the individual team members rate other members on their application of team skills. The Instructor's Form is to be used by the instructor/team leader/supervisor to rate the team as a whole on their use of team skills (refer to **Appendix 3** for Team Behavior and Instructor's Forms related to each skill, i.e., decision-making, communication, leadership and inter-personal relationships). All the questions are based on a seven-point Likert scale, with 1 indicating low or poor and 7 being high or excellent. Because certain behaviors have greater impact on team performance than other behaviors, an additional three-point impact scale was added for each behavioral question. The printing section allows the instructor to generate printouts of the various questionnaires. The Data Analysis section is similar to the report generation module. This utility facilitates the analysis of user data once it has been entered into the computer.

### 3.2.5 Printing Program

In situations where computer support is lacking, it may become necessary to present the instructional information in an alternate format. The printing program was specifically designed to provide the instructor with *necessary resources* and structure to print the different screens in the team skills instructional program (refer to **Figure 3.12**).

#### **Figure 3.12 Printing program**



### 3.3 FUTURE PLANS AND CONCLUSIONS

The next phase of this project will involve testing and detailed evaluation. The software will be tested for robustness. Recommendations forthcoming from this testing will be incorporated to enhance the software. The evaluation phase will analyze the utility of computer-based team training in the aircraft maintenance environment. A detailed experimental protocol will be developed and the evaluation will be based on an experimental design using an experimental treatment group and a control group. The above phases will be conducted in cooperation with an A & P certified school, aircraft maintenance facility, and a partner airline.

The report has described ongoing research and development related to the application of team training in the aircraft maintenance environment. The research demonstrates the current application of advanced multimedia technology in developing a team training software for training aviation maintenance technicians in team-based skills. Subsequent phases of this research will evaluate the utility of AMTT in an operational setting. Training team skills of AMTs is critical to ensure successful team performance in the aircraft inspection/maintenance environment. In the future, as the composition of the AMT workforce changes, team training will become more critical. In such an environment, computer-based team training coupled with

technical instructors will provide an effective training solution. As the projects are completed, dissemination of results in the form of published papers, reports, CD-ROMs, and short training courses is needed. It is only when the results are disseminated and later applied by the general aviation community to enhance already high performance of aviation maintenance that we can realize the full potential of the research.

### 3.4 ACKNOWLEDGMENTS

This work was supported by a contract from the Federal Aviation Administration, Office of Aviation Medicine, administered by Dr. William Shepherd through the Galaxy Scientific Corporation to the Department of Industrial Engineering Clemson University. We would also like to thank personnel from Lockheed Martin Aeromod Centers Inc. (Mr. Don Cope, Manager Training; Mr. Jack Alberts, Manager, Training; Mr. Mike Mason, Instructor, Training and Mr. Hy Small, Manager, TQM) and Greenville Technical College, Aircraft Maintenance Technology Program (Mr. Doyle Arnold, Director) for the use of their facility and time in conducting this research.

### 3.5 REFERENCES

- Andrew, D.H., Waag, W.L. and Bell, H.H. (1992) *Training Technologies Applied to Team Training: Military Examples Teams: Their Training and Performance*, Swezey and Salas (Eds.), Norwood, NJ: Ablex Publishing Corp.
- Burgess, K. A., Salas, E. and Cannon-Bower, J. A. (1993) Training team leaders: More than meets the eye, Paper presented at the *Eight Annual Conference of the Society for Industrial and Organizational Psychology*, San Francisco, CA.
- Chabay, Ruth W. and Sherwood, Bruce A. (1992) A practical guide for the creation of educational software. In *Computer-Assisted Instruction and Intelligent Tutoring Systems: Shared Goals and Complementary Approaches*, Larkin, J. H. and Chabay, R.W. (Eds.) Hillsdale, New Jersey: Lawrence Erlbaum Associates.
- Cannon-Bower, J.A., Tannenbaum, S.I. and Salas, E. (1993) Defining team competencies: Implications for training requirements and strategies. In *Team Effectiveness and Decision Making in Organizations*.
- Coovert, M.D. and McNelis, K. (1992) Team decision making and performance: A review and proposed modeling approach employing petri net. In *Teams: Their Training and Performance*, Swezey and Salas (Eds.), Norwood, NJ: Ablex Publishing Corp.
- David, L.T., Gaddy, C.D. and Turney, J. R. (1985) *An approach to team skills training of nuclear power plant control room crews* (NUREG/CR-4255GP-R-123022). Columbia,

MD: General Physics Corp.

Drury, C.G. and Gramopadhye, A. K. (1990) Training for visual inspection. In *Proceedings of the Third Federal Aviation Administration Meeting on Human Factors in Aircraft Maintenance Inspection: Training Issue*, Atlantic City, NJ.

FAA (1993) Human Factors in Aviation Maintenance - Phase III, Volume 1 Progress Report. DOT/FAA/AM-93/15.

Glickman, A.S., Zimmer, S., Montero, R. C., Guerette, P. J., Campbell, W. J., Morgan, B.B. Jr., and Salas, E. (1987) *The evolution of teamwork skills: an empirical assessment with implications for training* (Technical Report 87-016). Arlington, VA: Office of Naval Research.

Gould, J. D. (1988) How to design usable systems, In M. Helander (Ed.), *Handbook of Human Computer Interaction*. Elsevier Science Publishers B. V., Amsterdam, North-Holland.

Gould, J. D. and Lewis, C. (1985) Designing for usability: key principles and what designers think. *Communications of the ACM*, 28(3), 300-311.

Gordon, S. E. (1994) *Systematic Training Program Design*, Englewood Cliffs, NJ: PTR Prentice Hall.

Gramopadhye, A. K., Ivaturi, S., Blackmon, R. B., and Kraus, D.C., (1995) Teams and teamwork: implications for team training within the aircraft inspection and maintenance environment. (In Press) FAA-1995 Technical Report, Office of Aviation Medicine, FAA.

Guerette, P. J., Miller, D. L., Glickman, A.S., Morgan, B.B., Jr. and Salas, E. (1987) Instructional processes and strategies in team training (Technical Report 87-017). Arlington, VA: Office of Naval Research.

Hogan, J., Peterson, A.V., Salas, E., Reynolds, R.E., and Willis, R. P. (1991) Team performance training needs and teamwork: Some field observations (Technical Report 91-007). Orlando, FL: Naval Training Systems Center, 1991.

Ivaturi, S., Gramopadhye, Kraus, D.C., and Blackmon, R. B. (1995) Team training to improve the effectiveness of teams in the aircraft maintenance industry, *Proceedings of the Human Factors and Ergonomic Society 39th Annual Meeting*, pp. 1355-1359.

Johnson, W.B., (1990) "Advanced Technology Training for Aviation Maintenance," Final Report of the Third FAA Meeting on Human Factors Issues in Aircraft Maintenance and Inspection, Atlantic City, NJ: FAA.

- Johnson, W.B., Norton, J. E., and Utsman, L.G. (1992) New technologies for the schoolhouse and flightline maintenance environment, *Proceedings of the Seventh Meeting on Human Factor Issues in Aircraft Maintenance and Inspection*, Washington, DC: Federal Aviation Administration.
- Kraus, D.C., Gramopadhye, A. K., and Blackmon, R. B. (1996) Teams in the aircraft maintenance environment, (In Press), *Proceedings of the Fifth Industrial Engineering Research Conference Proceedings*.
- McCallum, G.A., Oser, R., Morgan, B.B., Jr., and Salas, E. (1989) An investigation of the behavioral components of teamwork, Paper presented at the *APA Convention*, New Orleans: LA.
- More, C. M. (1987) Group techniques for idea building, *Applied Social Research Methods Series*, Vol 9, Sage Publications: London.
- McIntyre, R. M., Morgan, B., Salas, E. and Glickman, A. (1988) Teamwork from team training: new evidence for the development of teamwork skills during operational training. Paper presented at the *Interservice/Industry Training Systems Conference*, Orlando, FL.
- Nieva, V.F., Fleishman, E. A., and Rieck, A., (1978) Team dimensions: their identity, their measurement and their relationships (Final Technical Report Contract No. DAHC19-78-C-001). Alexandria, VA: U.S. Army Research Institute for the Behavioral & Social Sciences.
- Norton, J. E., (1992) Intelligent simulation for maintenance training, *Proceedings of the Seventh Meeting on Human Factor Issues in Aircraft Maintenance and Inspection*, Washington, DC: Federal Aviation Administration.
- Paulson, B.C., Jr., (1995) *Computer Applications in Construction*, New York, NY: McGraw Hill.
- Scholtes, P.R., (1988) *The Team Training Handbook*, Madison, WI: Joiner Associates, Inc.
- Shepherd, W.T. (1991) *Human Factors in Aviation Maintenance, Phase 1: Progress Report*, DOT/FAA/AM-91/16, Washington, DC: Federal Aviation Administration.
- Shepherd, W.T. (1992) Human factors challenges in aviation maintenance, *Proceedings of the Human Factors Society 36th Annual Meeting*, Washington, DC: Federal Aviation Administration.
- Swezey, R.W. and Salas, E. (1992) Guidelines for use in team-training development, *Teams: Their Training and Performance*, Swezey and Salas (Eds.), Norwood, NJ: Ablex Publishing Corporation.

White, M., (1993) Are ILSs good in education? *Computer-Based Integrated Learning Systems*, Gerald D. Bailey (Ed.), Englewood Cliffs, NJ: Education Technology Publications.

## 3.6 APPENDIX

### 3.6.1 Appendix 1: Team perception forms

Figure 3.13 Team perception forms: Communication

Aircraft maintenance team training software - Field study module

1. Decision making      2. Leadership      3. Interpersonal relationship      4. Communication

Name  ID no

Team  Sess ID

1 Good communication and coordination are as important as technical proficiency for aircraft safety and operational effectiveness

Very strongly disagree      Neutral      Very strongly agree

2 Crew leaders and supervisors should encourage questions during work and in special situations

3 The start of shift team meeting is important for safety and effective team management

4 Knowing the correct terminology is critical for effective communication

5 Proper team communication should always be one directional and progress from the crew chief down to the team members

6 If a person is not able to perform the job properly, he should ask for help from the team members

7 Positive feedback is more important than negative feedback

8 Team members should give unsolicited advice to each other on how to do a job

9 It is equally important to know how to give feedback as well as to receive feedback

10 Feedback is necessary for improving team performance

Submit Recall ? Help Exit Menu

1. Team perception form      2. Team behavior form      3. Instructor's form

Figure 3.14 Team perception forms: Decision making



Aircraft maintenance team training software - Field study module

1. Decision making	2. Leadership	3. Interpersonal relationship	4. Communication
Name <input style="width: 100px;" type="text"/> ID no <input style="width: 50px;" type="text"/>			
Team <input style="width: 100px;" type="text"/> Sess ID <input style="width: 50px;" type="text"/>			
1 Team members should not question the decisions or actions of the crew leader when they feel that the action could affect the safety of the operation <input type="radio"/> Very strongly disagree <input type="radio"/> Neutral <input type="radio"/> Very strongly agree		6 Team members should actively support the goals and objectives of the organization(Costs, quality and service) <input type="radio"/> <input type="radio"/> <input type="radio"/> <input type="radio"/> <input type="radio"/> <input type="radio"/>	
2 In a team situation the work goals and priorities have to be agreed upon by all team members <input type="radio"/> <input type="radio"/> <input type="radio"/> <input type="radio"/> <input type="radio"/> <input type="radio"/>		7 If a team member disagrees with the decisions of the team they should voice their opinion <input type="radio"/> <input type="radio"/> <input type="radio"/> <input type="radio"/> <input type="radio"/> <input type="radio"/>	
3 All team members should contribute to the team decisions <input type="radio"/> <input type="radio"/> <input type="radio"/> <input type="radio"/> <input type="radio"/> <input type="radio"/>		8 Voting and then using the majority is the best way to make team decisions <input type="radio"/> <input type="radio"/> <input type="radio"/> <input type="radio"/> <input type="radio"/> <input type="radio"/>	
4 In making decisions in a team it is important that all members participate <input type="radio"/> <input type="radio"/> <input type="radio"/> <input type="radio"/> <input type="radio"/> <input type="radio"/>		9 Teams have no need to make decisions. They should work together as directed by the crew lead <input type="radio"/> <input type="radio"/> <input type="radio"/> <input type="radio"/> <input type="radio"/> <input type="radio"/>	
5 If there exists a conflict it should be resolved by the team leader <input type="radio"/> <input type="radio"/> <input type="radio"/> <input type="radio"/> <input type="radio"/> <input type="radio"/>		10 Brainstorming is an effective idea generation technique <input type="radio"/> <input type="radio"/> <input type="radio"/> <input type="radio"/> <input type="radio"/> <input type="radio"/>	
		<input type="button" value="Submit"/> <input type="button" value="Recall"/> <input type="button" value="Help"/> <input type="button" value="Exit"/> <input type="button" value="Menu"/>	
1. Team perception form		2. Team behavior form	
		3. Instructor's form	

**Figure 3.15 Team perception forms: Interpersonal relationship**

Aircraft maintenance team training software - Field study module

1. Decision making	2. Leadership	3. Interpersonal relationship	4. Communication
--------------------	---------------	-------------------------------	------------------

Name  ID no

Team  Sess ID

1 When asked for help, team members willingly and openly provided assistance.

Impact of this question

1

2

3

1. No impact 2. Some impact 3. Strong impact

Very strongly disagree
Neutral
Very strongly agree

4 Team members made negative comments or blamed another member for a failure.

1

2

3

5 Team members allowed personality conflicts to interfere with work.

1

2

3

6 Team members gave unsolicited and unnecessary advice to one another.

1

2

3

7 Team members became hostile or defensive when criticized.

1

2

3

**Figure 3.16 Team perception forms: Leadership**



Aircraft maintenance team training software - Field study module

1. Decision making      2. Leadership      3. Interpersonal relationship      4. Communication

Click on the topic that you wish to address

Name  ID no

Team  Sess ID

1 The crew leader should take hands on control and make all the decisions in emergency or non-standard conditions

Very strongly disagree      Neutral      Very strongly agree

2 Team members should not question the decisions or actions of the crew leader or supervisor except when they threaten the safety of the operation

3 Under no circumstances should a subordinate assume control of the project

4 The responsibilities of the crew leader includes detailed management of all tasks

5 Overall successful team management is primarily a function of the crew leader or supervisor's technical proficiency

6 For a team leader to have the respect of his team members he should be proficient in all aspects of his work

7 The crew leader or supervisor should verbalize plans or actions and should be sure that the information is understood and acknowledged by team members

8 A team leader should complete the tasks for his team member if he doesn't know how to complete it

9 Knowledge on how to hold a meeting is an important skill of a leader

10 Unlike technical skills, leadership skills are easily learned and used

Submit Recall Help Exit Menu

1. Team perception form      2. Team behavior form      3. Instructor's form

### 3.6.2 Appendix 2: Tests

#### Appendix 2.1 Test: Communication Sub-Module

Figure 3.17 Test: Communication Sub-Module (page 1 of 4)

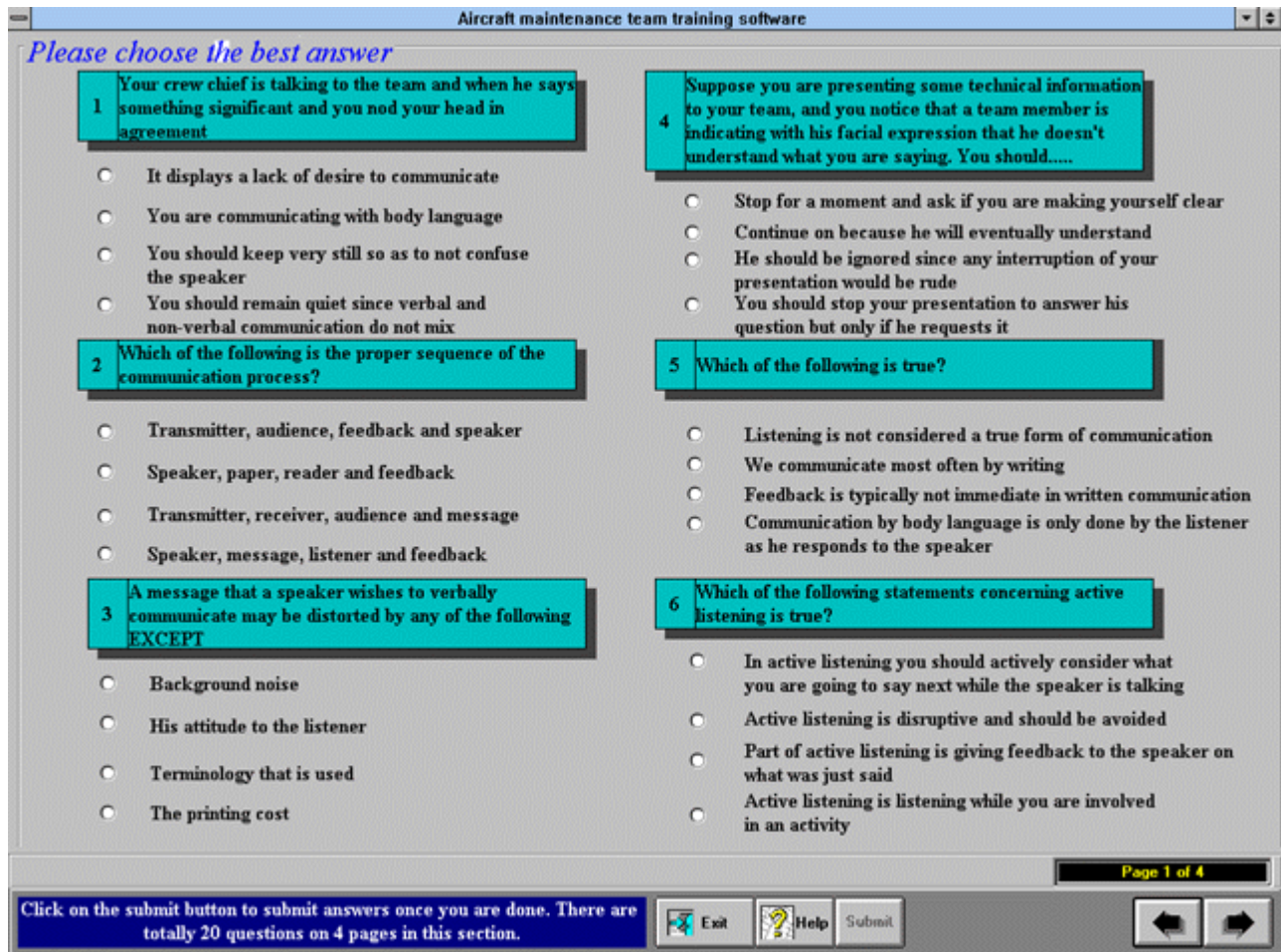


Figure 3.18 Test: Communication Sub-Module (page 2 of 4)

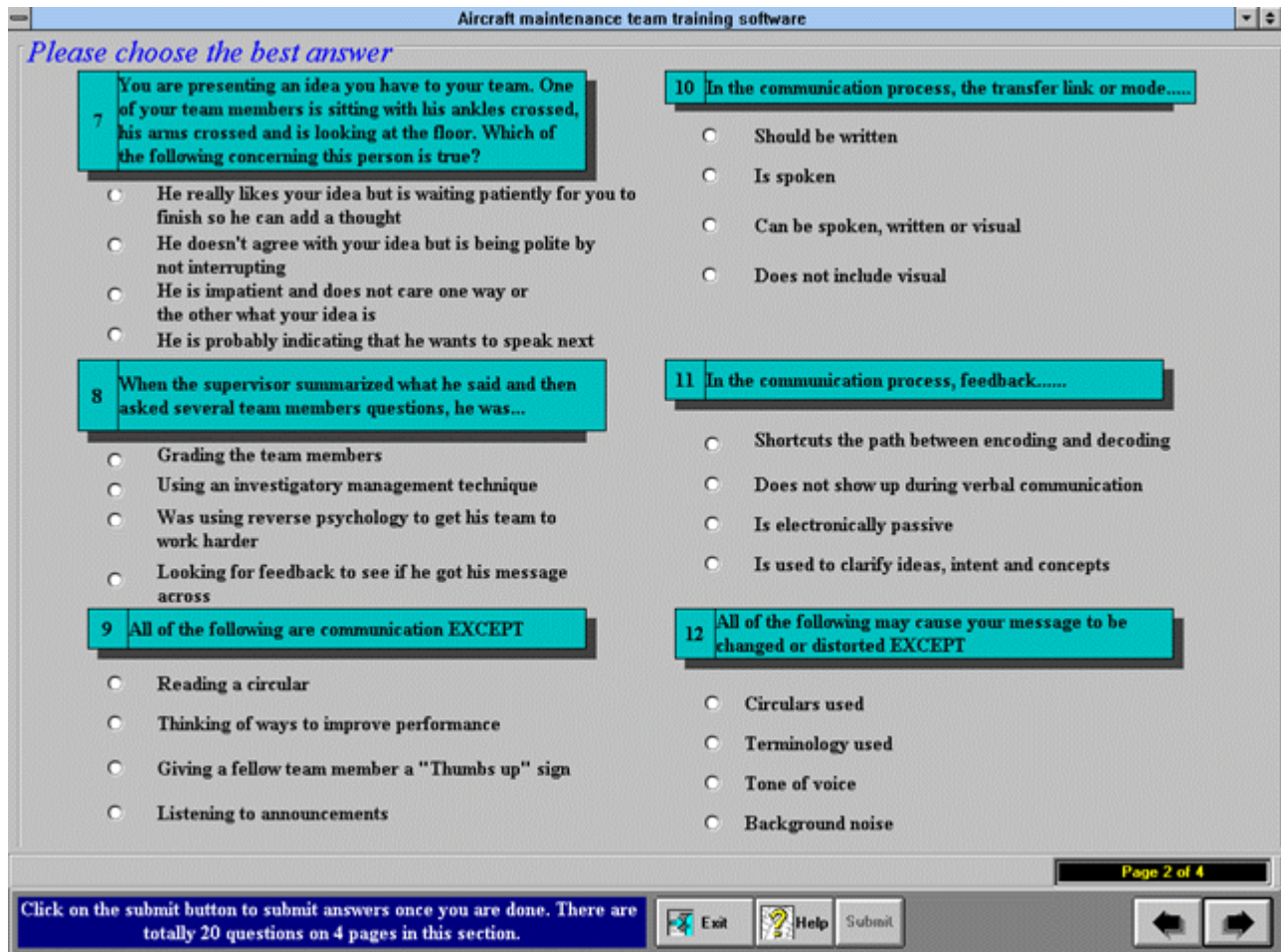


Figure 3.19 Test: Communication Sub-Module (page 3 of 4)



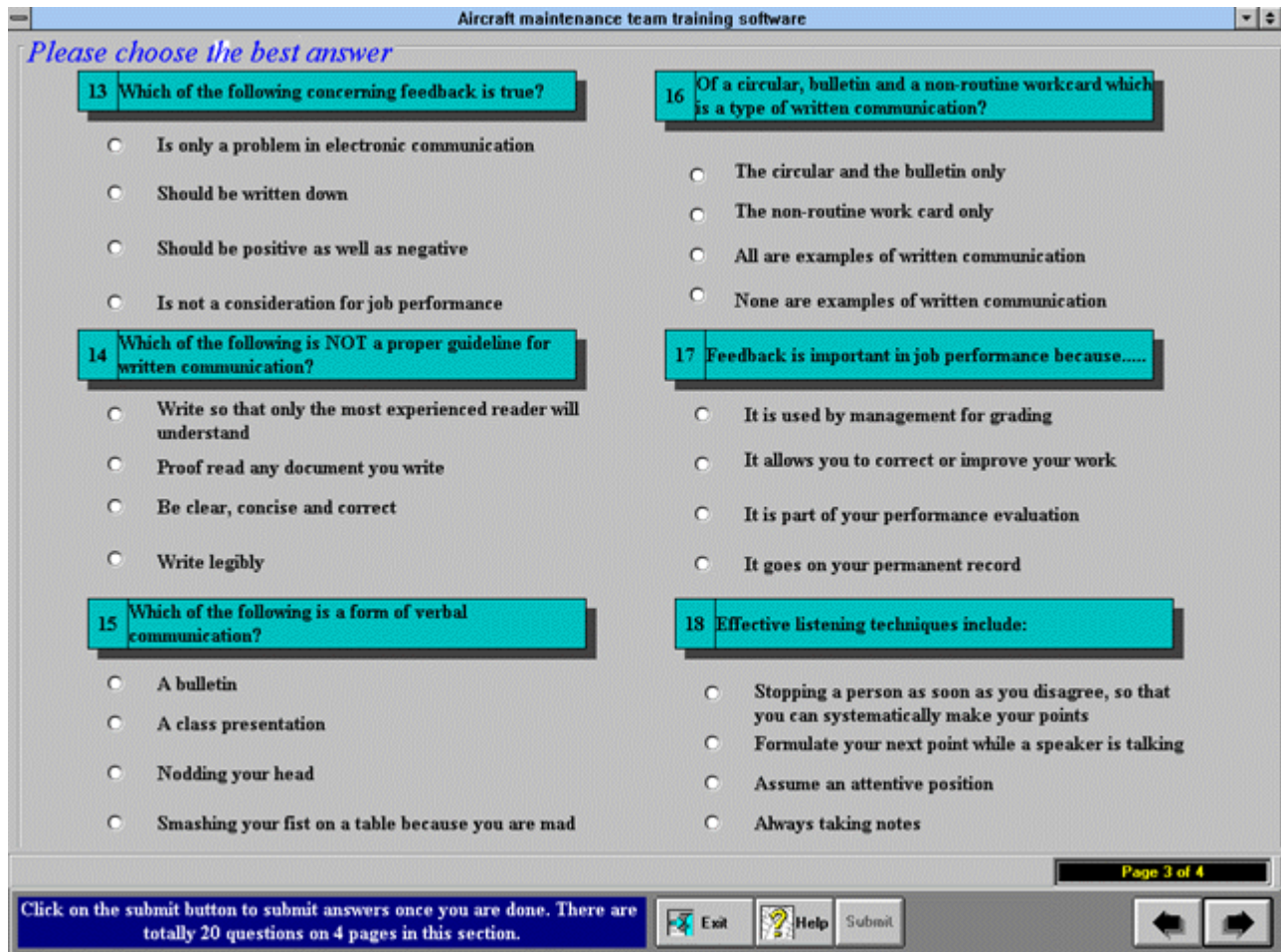
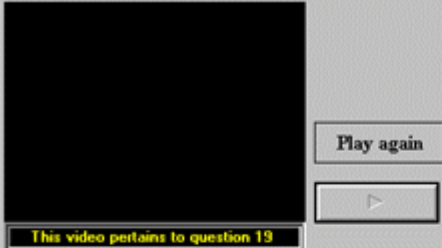
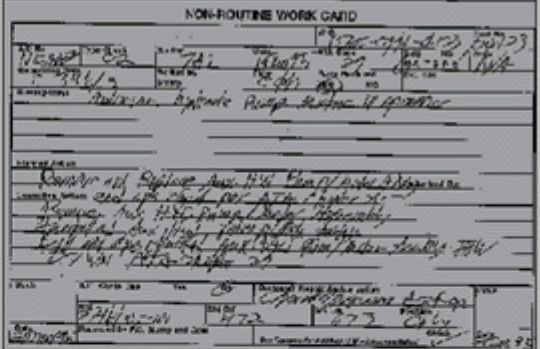


Figure 3.20 Test: Communication Sub-Module (page 4 of 4)

Aircraft maintenance team training software

Please choose the best answer





**19** In this video, Dave.....

- Is using an active listening technique
- Is performing interactive management
- Should not have spoken since it disrupts John's train of thought
- Failed to use body language

**20** The non-routine workcard shown in the picture has created a problem for the reader because.....

- Of poor English
- Of poor Handwriting
- Of incorrect information
- Insufficient information

Page 4 of 4

Click on the submit button to submit answers once you are done. There are totally 20 questions on 4 pages in this section.

**Appendix 2.2: Test: Decision-Making Sub-Module.**

**Figure 3.21 Test: Decision-Making Sub-Module (page 1 of 4)**

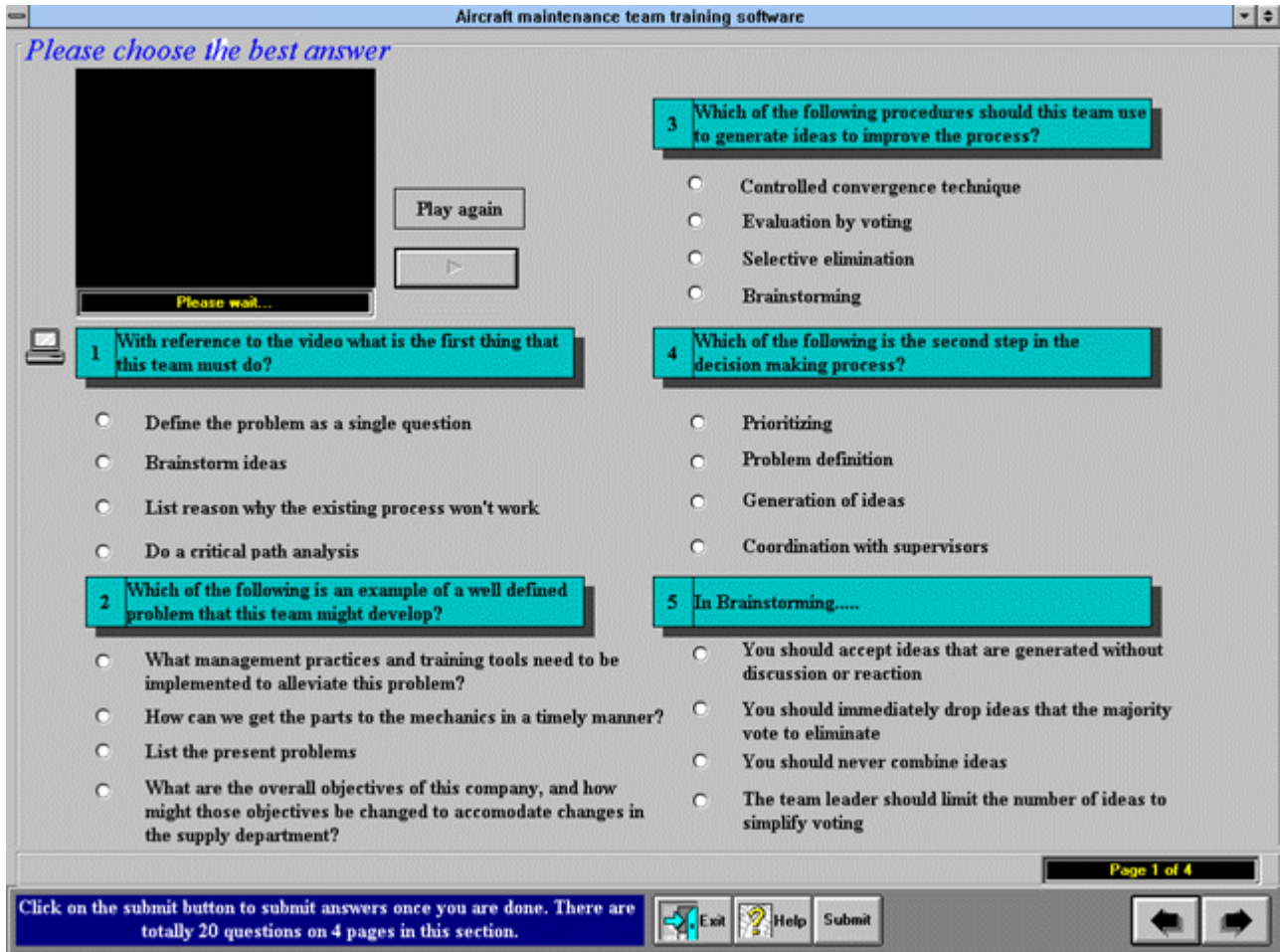


Figure 3.22 Test: Decision-Making Sub-Module (page 2 of 4)



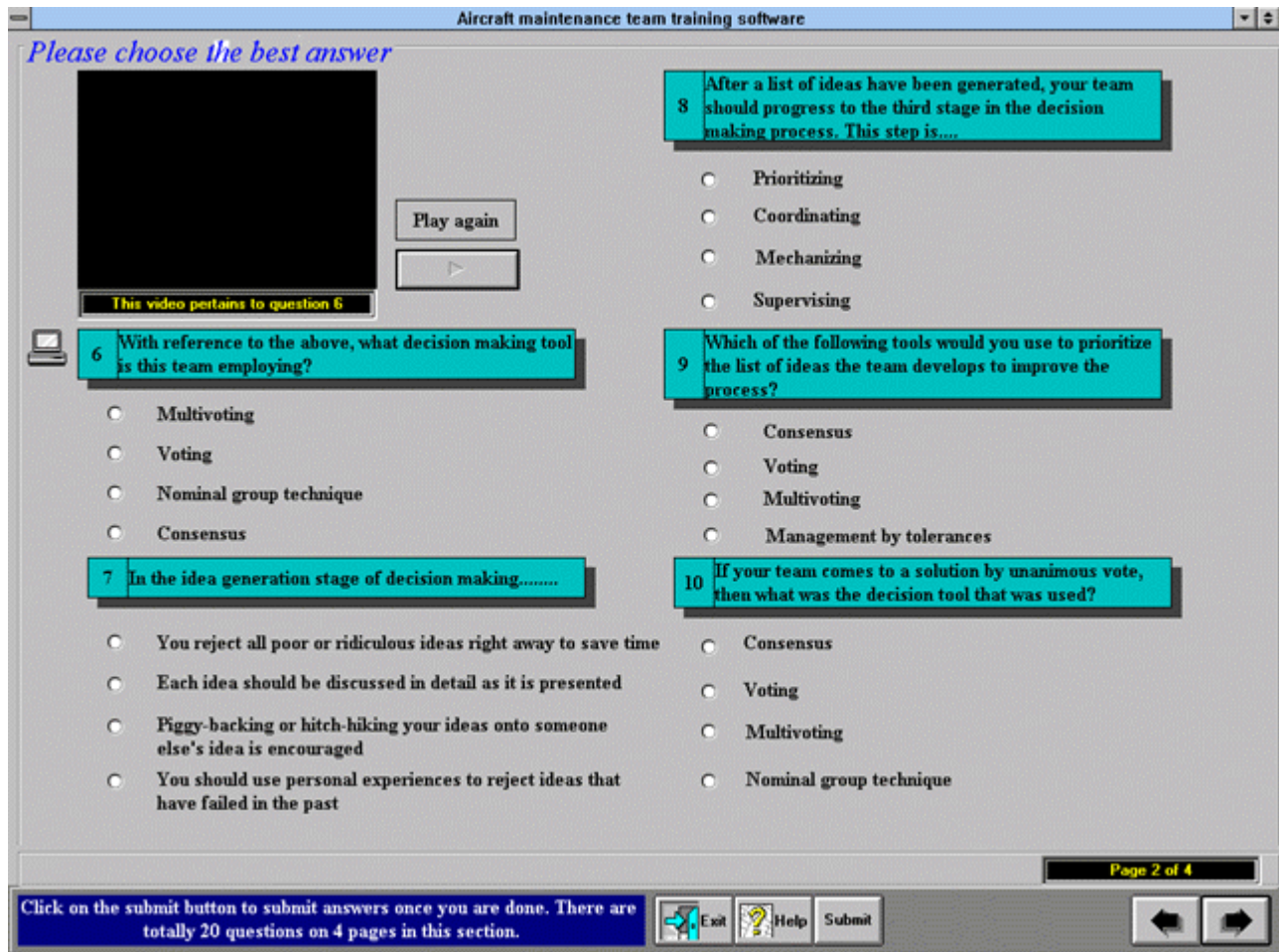


Figure 3.23 Test: Decision-Making Sub-Module (page 3 of 4)

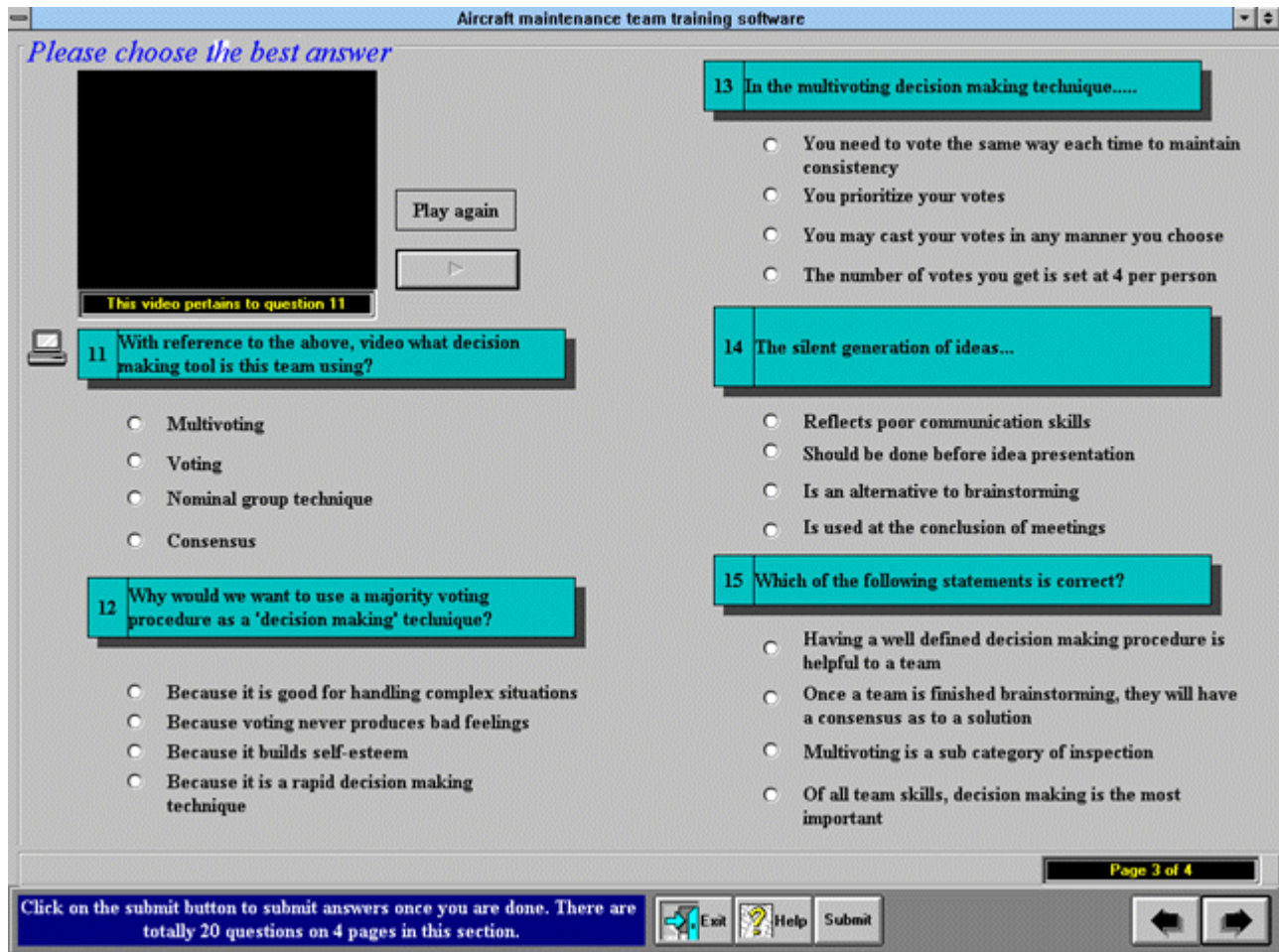


Figure 3.24 Test: Decision-Making Sub-Module (page 4 of 4)



Aircraft maintenance team training software

*Please choose the best answer*

**16** What should the team leader do at this point?

- The team leader should close the meeting and report ' No ideas generated' to the supervisor
- The team leader should keep presenting his own ideas in the hope that the others will get started
- The team leader should use his authority to make them respond
- The team leader should back up and start with the silent generation of ideas

**18** What should the team leader do at this point?

- Nothing. This is the type of interaction that you are seeking for eliminating poor ideas and keeping good ideas.
- Redirect the focus of the team to another problem that needs to be solved
- Reprimand the team members for criticizing and evaluating
- Stop the evaluation by reminding team members of the brainstorming rules

**17** What should the team leader do at this point?

- Do more silent generation of ideas allowing more time - possibly days
- Back up to the initial problem and discuss it thoroughly since there is probably some misunderstanding
- You must keep going round robin until someone gives an idea to report. Someone has to say something.
- Stop. It is now time to report ' No ideas generated ' to the supervisor

**19** In this situation, the team leader.....

- May make changes on a suggestion if the contributor agrees
- Is within his power to make any alterations
- Should make alterations to a suggestion only if the majority of the team members agree
- Should never change what the contributor says

**20** When the team is discussing the various ideas generated during brainstorming, the team leader should.....

- Uses his discretion to shorten the list of ideas for his team
- Should only eliminate ideas and not combine ideas
- Should eliminate or combine ideas only with the permission of the contributor and other team members
- Leave the list alone. Do not make changes.

Page 4 of 4

Click on the submit button to submit answers once you are done. There are totally 20 questions on 4 pages in this section.

Exit Help Submit

← →

**[Appendix 2.3: Test: Interpersonal Skills Sub-Module](#)**

**Figure 3.25 Test: Interpersonal Skills Sub-Module (page 1 of 4)**

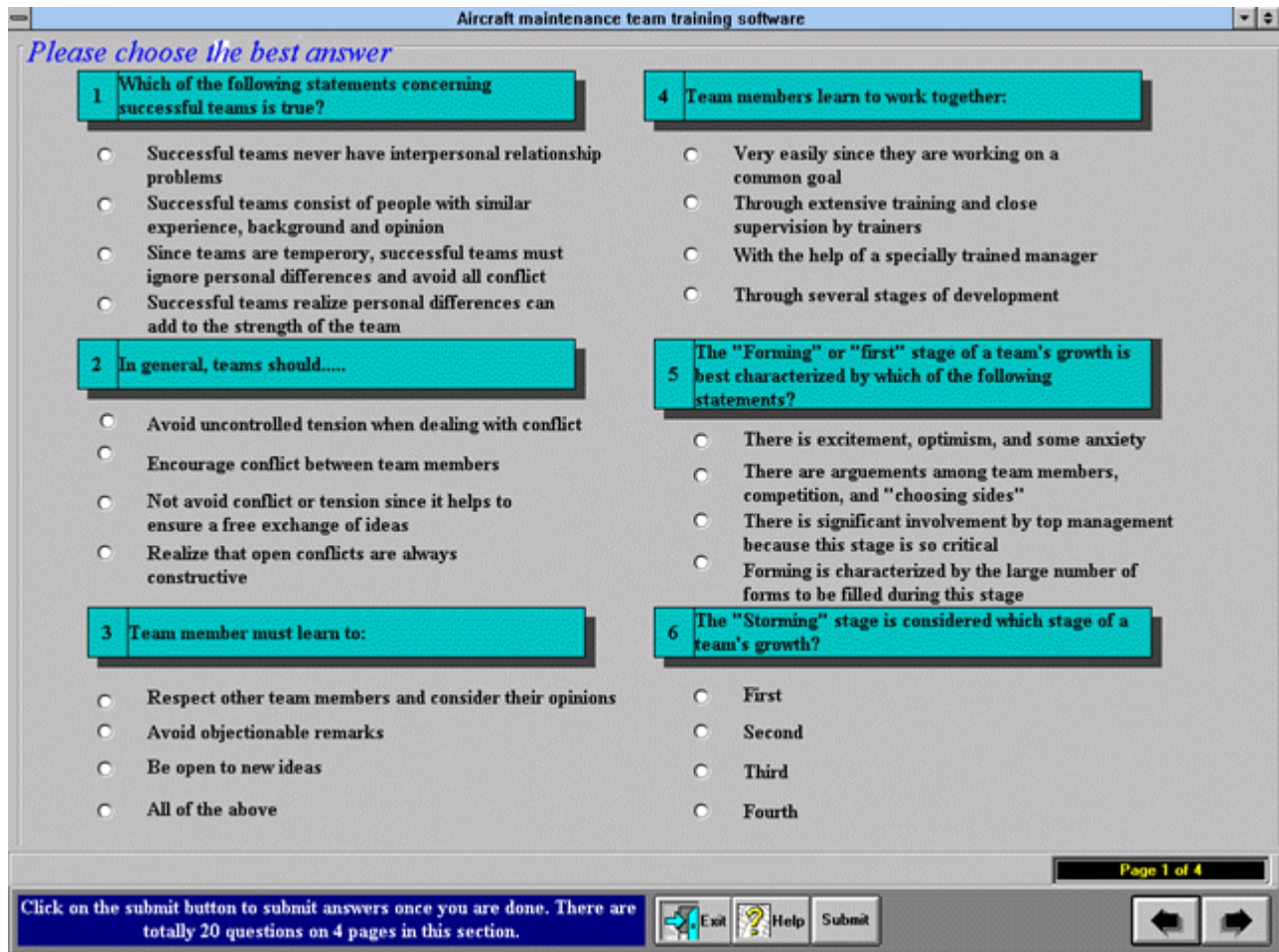


Figure 3.26 Test: Interpersonal Skills Sub-Module (page 2 of 4)

Aircraft maintenance team training software

*Please choose the best answer*

**7** Which of the following statements regarding the "Storming stage" of team growth is true?

- Successful teams typically by-pass this stage of team growth because of the conflict
- During this "Storming stage", it is vital that management becomes involved
- During this stage, more energy is spent in learning about one another than in accomplishing goals
- Storming occurs primarily in long established teams

**10** Gatekeeping is often included in ground rules, and refers to:

- The function of controlling topics to be discussed
- Methods to achieve balanced participation by members
- The team leader closing down a discussion so that decisions can be made
- Monitoring attendance and replacing members who have shown disinterest by not attending meetings on a regular basis

**8** Which of the following statements regarding the "Norming stage" of team growth is true?

- This is the last and fourth stage
- During this stage, team members are more friendly and confident in each other
- It is at this stage that management becomes involved in each team aspect
- Most conflicts occur during this stage

**11** Which of the following statements about team meetings is the most correct?

- Team meetings are important, but they are not treated as high priority work
- Emphasis on attending meetings on time is a distracting carry-over from more formal behavioral requirements
- Team meetings should start and stop on time
- Meetings should be extended if meaningful progress is made

**9** Ground rules are used to:

- Determine procedures for running a team meeting
- Set up processes for documenting team activities
- Establishing acceptable behavior
- Establishing acceptable behavior and standard operation procedures

**12** Interpersonal problems can be solved:

- By establishing ground rules
- With a combination of ground rules and team leader actions
- By reminding members of their responsibilities
- By returning disruptive members to their own organization

Page 2 of 4

Click on the submit button to submit answers once you are done. There are totally 20 questions on 4 pages in this section.

Exit Help Submit

Figure 3.27 Test: Interpersonal Skills Sub-Module (page 3 of 4)



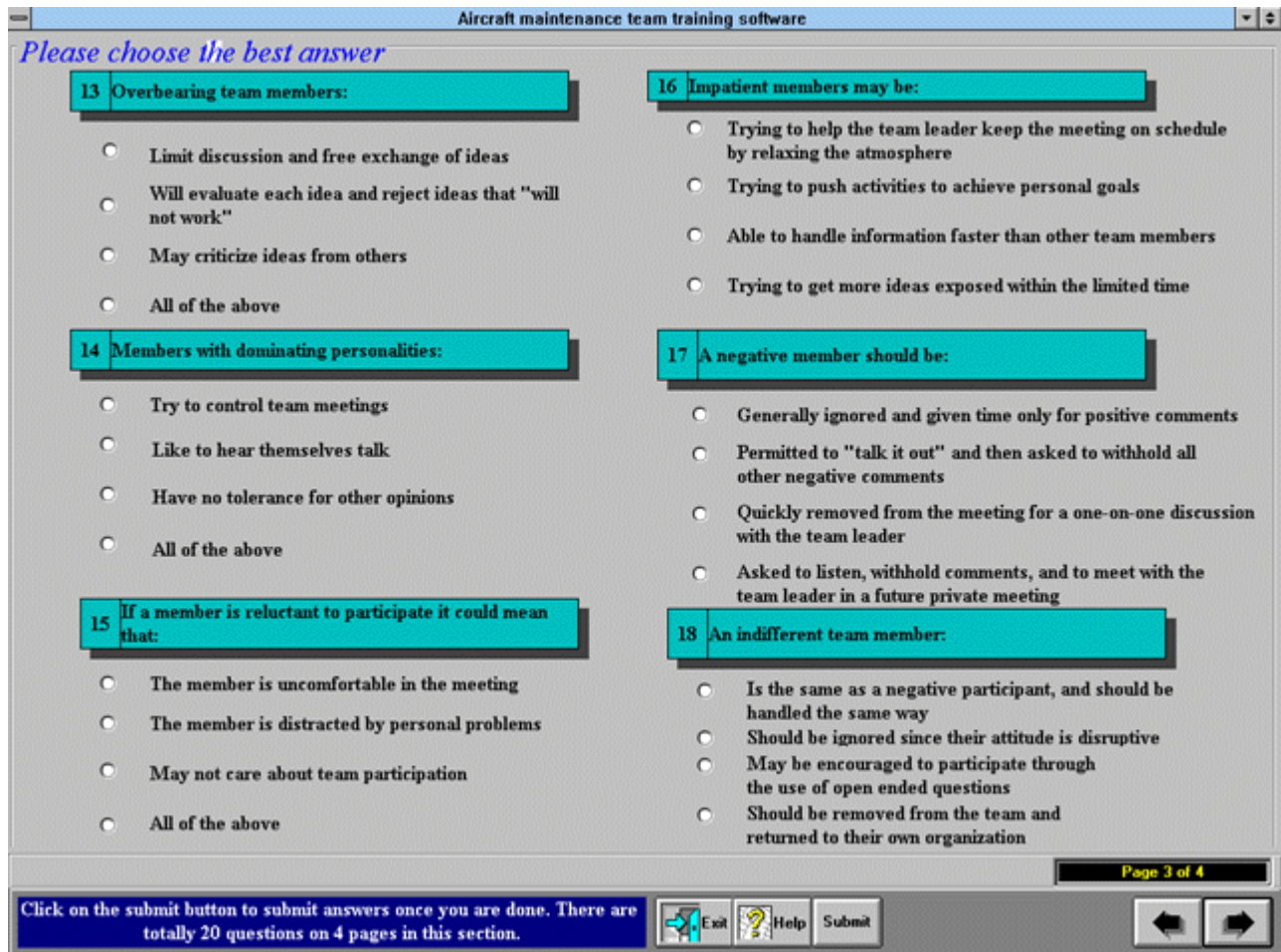
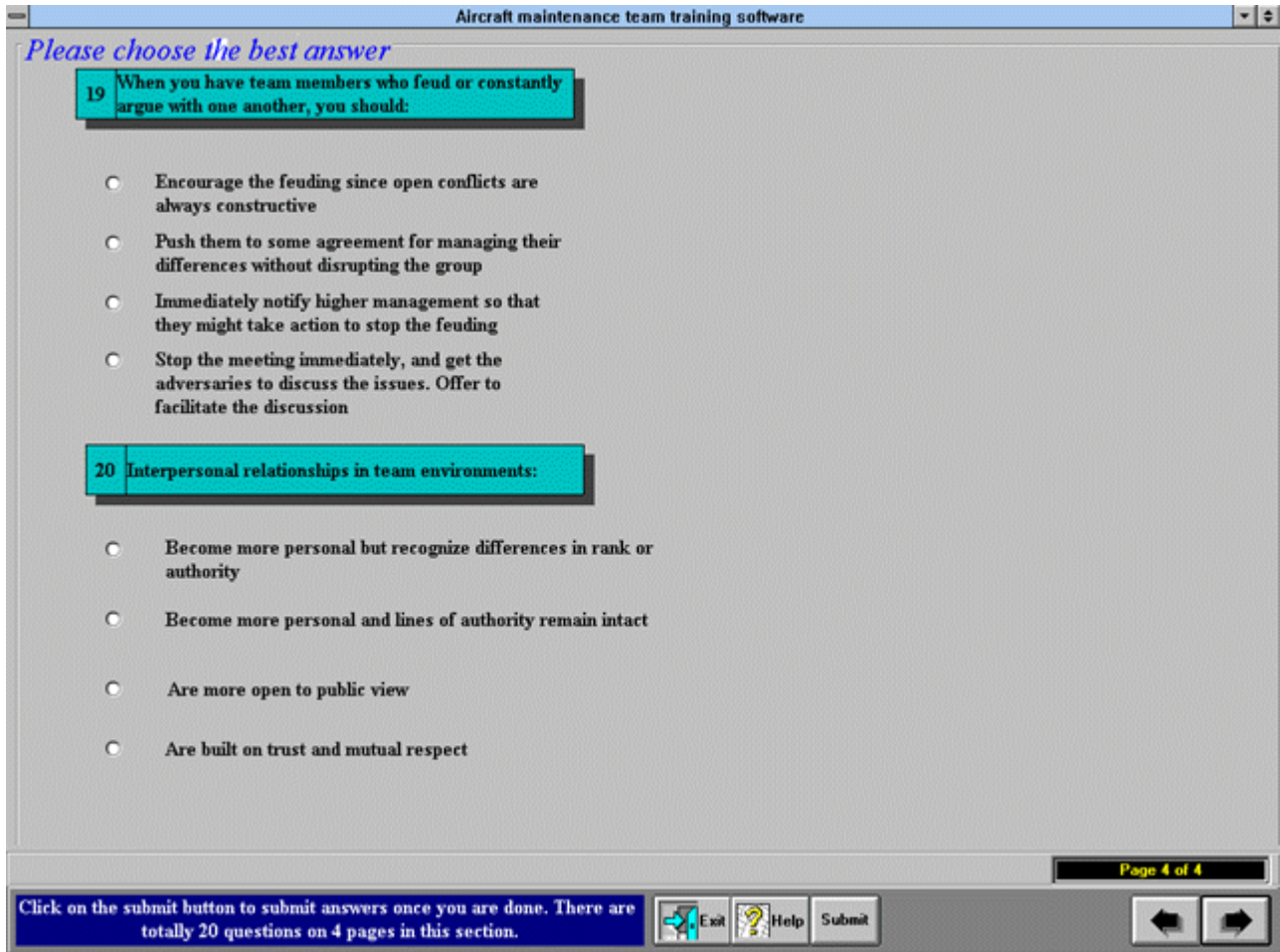


Figure 3.28 Test: Interpersonal Skills Sub-Module (page 4 of 4)



## [Appendix 2.4: Test: Leadership Sub-Module](#)

Figure 3.29 Test: Leadership Sub-Module (page 1 of 4)

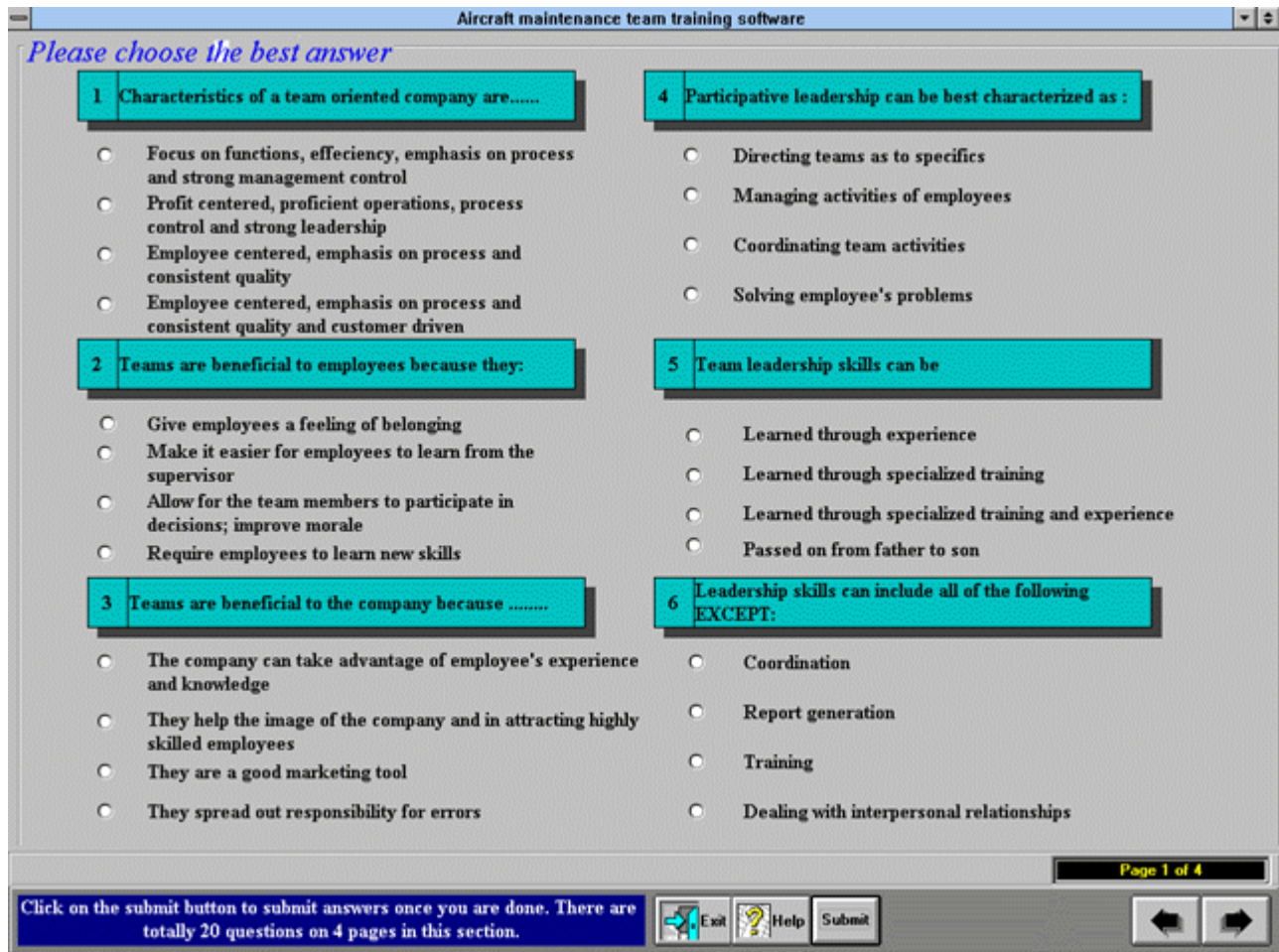


Figure 3.30 Test: Leadership Sub-Module (page 2 of 4)



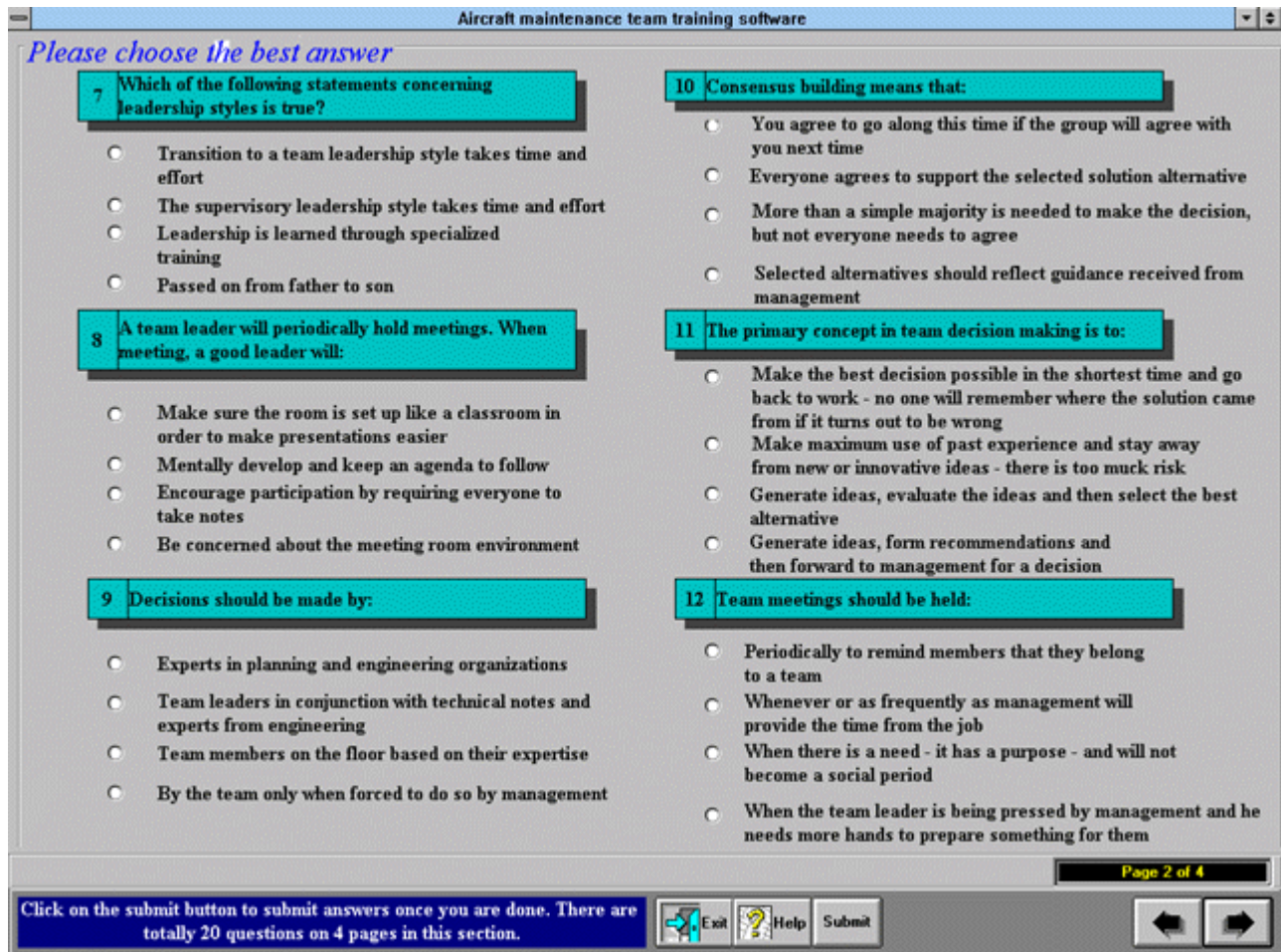


Figure 3.31 Test: Leadership Sub-Module (page 3 of 4)



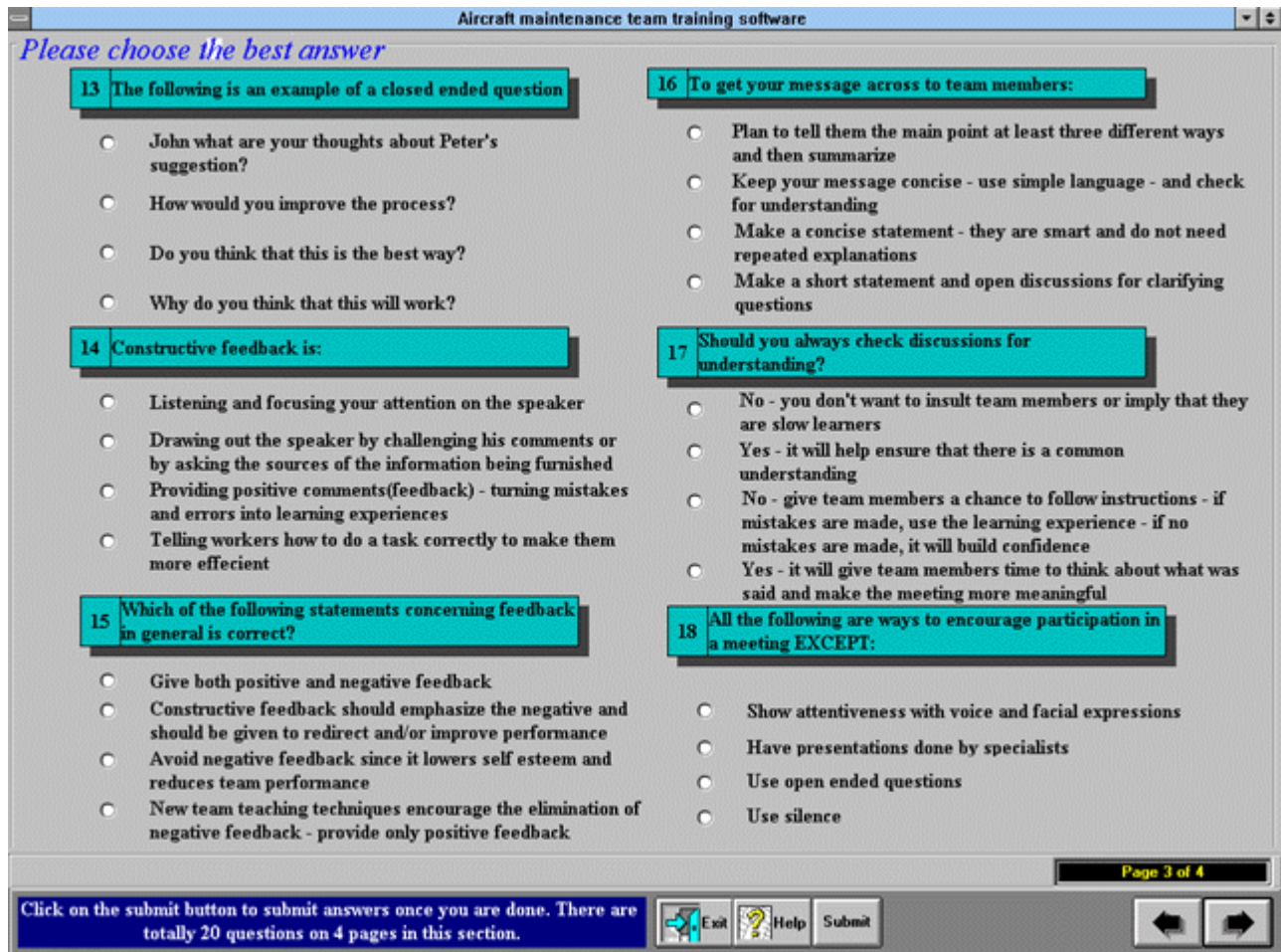
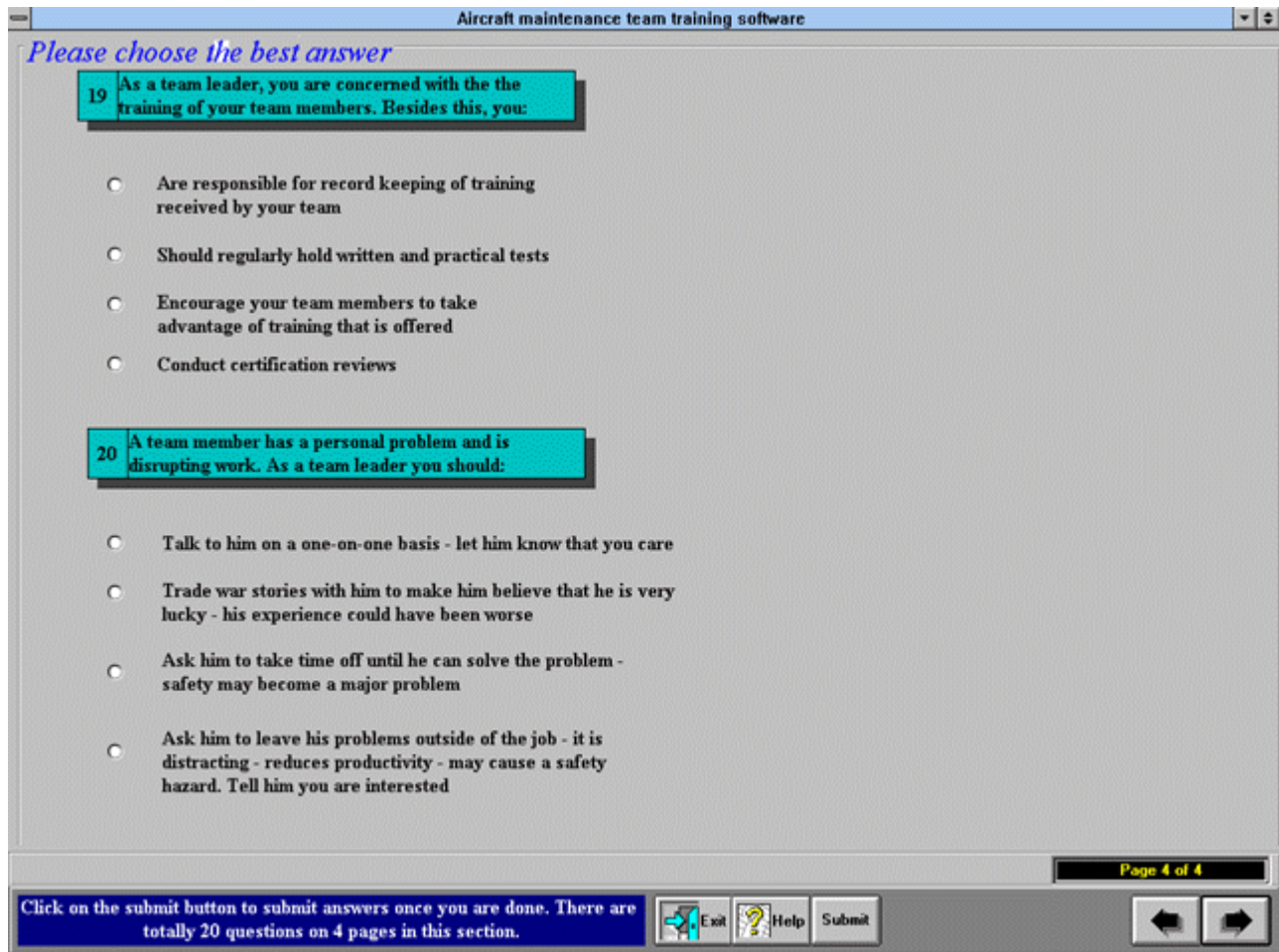


Figure 3.32 Test: Leadership Sub-Module (page 4 of 4)



### 3.6.3 Appendix 3: Team Behavior Forms And Instructor Forms

#### [Appendix 3.1 Team Behavior Forms And Instructor Forms \(Communication\)](#)

Figure 3.33 Team Behavior Forms And Instructor Forms (Communication)

Aircraft maintenance team training software - Field study module

1. Decision making		2. Leadership		3. Interpersonal relationship		4. Communication	
Name	<input type="text"/>	ID no	<input type="text"/>				
Team	<input type="text"/>	Sess ID	<input type="text"/>				
1	Good communication and coordination are as important as technical proficiency for aircraft safety and operational effectiveness			6	If a person is not able to perform the job properly, he should ask for help from the team members		
<input type="radio"/> Very strongly disagree <input type="radio"/> Neutral <input type="radio"/> Very strongly agree							
2	Crew leaders and supervisors should encourage questions during work and in special situations			7	Positive feedback is more important than negative feedback		
<input type="radio"/> <input type="radio"/> <input type="radio"/> <input type="radio"/> <input type="radio"/> <input type="radio"/> <input type="radio"/> <input type="radio"/>				<input type="radio"/> <input type="radio"/> <input type="radio"/> <input type="radio"/> <input type="radio"/> <input type="radio"/> <input type="radio"/> <input type="radio"/>			
3	The start of shift team meeting is important for safety and effective team management			8	Team members should give unsolicited advice to each other on how to do a job		
<input type="radio"/> <input type="radio"/> <input type="radio"/> <input type="radio"/> <input type="radio"/> <input type="radio"/> <input type="radio"/> <input type="radio"/>				<input type="radio"/> <input type="radio"/> <input type="radio"/> <input type="radio"/> <input type="radio"/> <input type="radio"/> <input type="radio"/> <input type="radio"/>			
4	Knowing the correct terminology is critical for effective communication			9	It is equally important to know how to give feedback as well as to receive feedback		
<input type="radio"/> <input type="radio"/> <input type="radio"/> <input type="radio"/> <input type="radio"/> <input type="radio"/> <input type="radio"/> <input type="radio"/>				<input type="radio"/> <input type="radio"/> <input type="radio"/> <input type="radio"/> <input type="radio"/> <input type="radio"/> <input type="radio"/> <input type="radio"/>			
5	Proper team communication should always be one directional and progress from the crew chief down to the team members			10	Feedback is necessary for improving team performance		
<input type="radio"/> <input type="radio"/> <input type="radio"/> <input type="radio"/> <input type="radio"/> <input type="radio"/> <input type="radio"/> <input type="radio"/>				<input type="radio"/> <input type="radio"/> <input type="radio"/> <input type="radio"/> <input type="radio"/> <input type="radio"/> <input type="radio"/> <input type="radio"/>			
						<input type="button" value="Submit"/> <input type="button" value="Recall"/> <input type="button" value="Help"/> <input type="button" value="Exit"/> <input type="button" value="Menu"/>	
1. Team perception form		2. Team behavior form		3. Instructor's form			

**[Appendix 3.2 Team Behavior Forms And Instructor Forms \(Decision-Making\)](#)**

**Figure 3.34 Team Behavior Forms And Instructor Forms (Decision-Making)**



Aircraft maintenance team training software - Field study module

1. Decision making	2. Leadership	3. Interpersonal relationship	4. Communication
--------------------	---------------	-------------------------------	------------------

Name  ID no

Team  Sess ID

1 Technicians and crew leads presented technical problems to the team for potential solutions.

Impact of this question  1  2  3

1. No impact 2. Some impact 3. Strong impact

Very strongly disagree                      Neutral                      Very strongly agree

2 As a problem was presented to the team as a whole, it was well defined so that everyone understood.

1  2  3

3 When discussing a problem, all team members participated in the discussion.

1  2  3

4 Final decisions were agreed to by all team members.

1  2  3

5 Team members carried out solutions/decisions with commitment and pride.

1  2  3

6 When in a meeting room situation, the team used a defined decision making procedure.

1  2  3

7 The crew lead made all the decisions for the team.

1  2  3

1. Team perception form	2. Team behavior form	3. Instructor's form
-------------------------	-----------------------	----------------------

Click on the topic that you wish to address

**[Appendix 3.3 Team Behavior Forms And Instructor Forms \(Interpersonal Skills\)](#)**

**Figure 3.35 Team Behavior Forms And Instructor Forms (Interpersonal Skills)**

Aircraft maintenance team training software - Field study module

1. Decision making	2. Leadership	3. Interpersonal relationship	4. Communication
--------------------	---------------	-------------------------------	------------------

Name  ID no

Team  Sess ID

Click on the topic that you wish to address

**1** When asked for help, team members willingly and openly provided assistance.

Impact of this question

1. No impact 2. Some impact 3. Strong impact

Very strongly disagree
Neutral
Very strongly agree

**2** Team member tried to push another member out of the way and do his job for him.

**4** Team members made negative comments or blamed another member for a failure.

**5** Team members allowed personality conflicts to interfere with work.

**6** Team members gave unsolicited and unnecessary advice to one another.

**7** Team members became hostile or defensive when criticized.

**3** Team members formed subgroups and cliques.

1. Team perception form	2. Team behavior form	3. Instructor's form
-------------------------	-----------------------	----------------------

**[Appendix 3.4 Team Behavior Forms And Instructor Forms \(Leadership\)](#)**

**Figure 3.36 Team Behavior Forms And Instructor Forms (Leadership)**

Name  ID no

Team  Sess ID

1 The leader failed to verify if information he provided was understood by all recipients.

Impact of this question

1 2 3

1. No impact 2. Some impact 3. Strong impact

Very strongly disagree      Neutral      Very strongly agree

2 Team leader discussed with team, ways to improve team performance.

1 2 3

3 Team leader coordinated gathering of information in an effective manner.

1 2 3

4 Leader reviewed procedures and assignments with team prior to a task requiring teamwork.

1 2 3

5 Team leader ridiculed a team member.

1 2 3

6 The leader dealt with personal situations in a removed area.

1 2 3

7 Team leader effectively used on-the-job training as a training tool.

1 2 3

Submit Recall ? Help Exit Menu

# CHAPTER 4

## TEAM SITUATION AWARENESS IN AIRCRAFT MAINTENANCE

*Mica R. Endsley, Ph.D.*

*Department of Industrial Engineering, Texas Tech University  
and*

*Michelle M. Robertson, Ph.D.*

*Institute of Systems and Safety Management, University of Southern California*

### 4.1 INTRODUCTION

Insufficient attention has been paid to human error in aircraft maintenance. While the numbers of incidents due to mechanical failures that can be traced to maintenance problems are relatively few when compared to other causal factors (e.g., inflight human error), they do exist and can be systematically addressed. Marx and Graeber (1994), for instance, report that 12% of accidents are due to maintenance and inspection faults, and around one-third of all malfunctions can be attributed to maintenance deficiencies. In addition to its impact on safety of flight, the efficiency of maintenance activities can also be linked to flight delays, ground damage and other factors that directly impact airline costs and business viability.

In examining human error that may occur within the maintenance arena, several issues can be identified.

1. The first involves shortcomings in the detection of critical cues regarding the state of the aircraft or sub-system. Several accidents have been traced to metal fatigue or loose and missing bolts that should have been visible to maintenance crews. Incidents exist of aircraft being returned to service with missing parts or incomplete repairs. Frequent errors include loose objects left in aircraft, fuel and oil caps missing or loose, panels and other parts not secured, and pins not removed (Marx & Graeber, 1994). While several factors may contribute to this type of error, in all of these cases the state of the system (i.e., the defect, or the loose or missing item) was not detected prior to returning the aircraft to service.
2. Often, even when important information is perceived, there may be difficulties in properly interpreting the meaning or significance of that information. For instance, Ruffner (1990) found that in more than 60% of avionics repairs, the incorrect avionics system is replaced in an aircraft. While the symptoms may be observed correctly, a significant task remains in properly diagnosing the true cause of the failure. While not much data exists regarding the impact of misdiagnoses of this type, there is a significant increase in the probability of an incident occurring when the aircraft undertakes the next flight with the faulty system still aboard.



3. Problems in properly detecting the state of the system and diagnosing or interpreting cues that are perceived are compounded by the fact that many different individuals may be involved in working on the same aircraft. In this situation, it is very easy for information and tasks to fall through the cracks. The presence of multiple individuals supports the need for a clear understanding of responsibilities and good communications between individuals to support the performance of shared tasks.
4. In addition to the need for intra-team coordination, a significant task for maintenance crews is the coordination of activities and provision of information across teams to those on different shifts or in different geographical locations. The Eastern Airlines incident at Miami Airport (National Transportation Safety Board, 1984) has been directly linked to a problem with coordination of information across shifts (along with other contributing factors). In addition, considerable energy is often directed at coordination across maintenance sites to accommodate maintenance tasks within the flight schedule and part availability constraints. These factors add a level of complexity to the problem that increases the probability of tasks not being completed, or completed properly, important information not being communicated, and problems going undetected as responsibility for tasks becomes diluted.

#### **4.1.1 Situation Awareness**

All of these difficulties point to a lack of situation awareness. Situation awareness has been found to be important in a wide variety of systems operations, including piloting, air traffic control and maintenance operations. Maintenance crews need support and training in ascertaining the current state of the aircraft system in addition to current training programs that concentrate on mechanical skills. Formally defined, *"situation awareness is the detection of the elements in the environment within a volume of space and time, the comprehension of their meaning, and the projection of their status in the near future"* (Endsley, 1988). In the context of aircraft maintenance, this means being aware of the state of the aircraft system (and the sub-system one is working on). Termed Level 1 SA, this would include perception of factors such as metal fatigue, loose or missing items, pins, or screws, oil or fluid leaks, tread wear, systems not functioning properly, etc. Level 2 SA would involve the technicians' understanding or comprehension of the significance of observed system states. Specifically this would include their diagnosis of the causal factors associated with observed symptoms. A technician with Level 1 SA might be aware that a particular subsystem is not working properly. A technician with Level 2 SA also understands what is specifically wrong with that subsystem. Level 3 SA, the ability to project the state of the system in the near future, is considered the highest level of SA in dynamic systems. A technician with Level 3 SA would be able to project what effect a particular defect might have on the performance of the aircraft in the future.

While SA has generally been discussed in terms of the operation of a dynamic system, such as an aircraft, the concept is also applicable to the maintenance domain. The complexity of aircraft systems and the distributed nature of equipment and system components poses a significant challenge to technicians' ability to determine the state of the system (Level 1 SA) during diagnosis and repair activities. Putting together observed cues to form a proper understanding of the underlying nature of malfunctions (Level 2 SA) is a significant problem in diagnostic

activities. In the maintenance domain, technicians may need to be able to project what will happen to an aircraft's performance with (or without) certain actions being taken or with given equipment modifications/repairs/adjustments occurring (Level 3 SA). This task may be even more difficult for maintenance technicians, as they often receive little or no feedback on the effects of their actions, and thus may have difficulty developing an adequate mental model for making accurate predictions. The ability to project system status forward (to determine possible future occurrences) may also be highly related to the ability to project system status backward, to determine what events may have led to an observed system state. This ability is particularly critical to effective diagnostic behavior.

### 4.1.2 Team SA

In aircraft maintenance, as in many other domains, the requirement for situation awareness becomes compounded by the presence of multiple team members and multiple teams. Individuals need not only to understand the status of the system they are working on, but also what other individuals or teams are (and are not) doing as well, as both factors contribute to their ultimate decision making and performance. Team situation awareness can be defined as "*the degree to which every team member possesses the situation awareness required for his or her responsibilities*" (Endsley, 1989a). In this context, the weak link in the chain occurs when the person who needs a given piece of information (per his or her job requirements) does not have it.

### 4.1.3 SA Errors

Marx and Graeber (1994) point out that many different taxonomies of errors have been proposed. The major question becomes translating the error classification into meaningful remediation within the maintenance context, an issue that is not trivial with many taxonomies. The primary advantage of characterizing maintenance errors in terms of situation awareness is that a taxonomy of causal factors at the level of human information processing mechanisms and characteristics has been developed for understanding the root causes of these errors (Endsley, 1994; Endsley, 1995), shown in **Table 4.1**. Thus specific remediation measures can be identified for addressing the root causes of the errors discussed previously. Situation awareness training concepts for individuals (Endsley, 1989b) and teams (Robertson & Endsley, 1995) can also be developed based on this formulation.

**Table 4.1 SA Error Taxonomy (Endsley, 1994, 1995)**

- |  |
|--|
| <ul style="list-style-type: none"><li>I. Level 1 SA - Failure to Correctly Perceive Situation<ul style="list-style-type: none"><li>A. Data not available</li><li>B. Data difficult to detect/perceive</li><li>C. Failure to scan or observe data<ul style="list-style-type: none"><li>1. Omission</li><li>2. Attention narrowing/distraction</li><li>3. High taskload</li></ul></li><li>D. Misperception of data</li></ul></li></ul> |
|--|

- E. Memory failure
- II. Level 2 SA - Failure to Comprehend Situation
  - A. Lack of or poor mental model
  - B. Use of incorrect mental model
  - C. Over-reliance on default values in model
  - D. Memory failure
  - E. Other
- III. Level 3 SA - Failure to Project Situation into the Future
  - A. Lack of or poor mental model
  - B. Other

## 4.2 RESEARCH OBJECTIVE

The overall research objective is to address current situation awareness related difficulties in aircraft maintenance through the development of cohesive maintenance teams and the promotion of team situation awareness. Teams differ from a collection of individuals in that they are "*a distinguishable set of two or more people who interact dynamically, interdependently, and adaptively toward a common and valued goal/object/mission, who have each been assigned specific roles or functions to perform, and who have a limited life span of membership*" (Salas, Dickinson, Converse, & Tannenbaum, 1992). Thus, the major factors contributing to the concept of a team are shared goals, the interdependence of their actions, and the division of labor in terms of established responsibilities for meeting those goals. This is critical for the development of an environment in which people have a shared understanding of who does what when, reducing the probability of information or tasks going unattended.

Within the framework of a team it is important to provide the members with the skills to function effectively. Specifically, it is proposed that training be provided to assist teams in achieving situation awareness, as this is the critical factor that will allow team members to carry out the maintenance tasks for which they have been trained. Several related training programs have been successful within this domain. Drury (1993) has shown success in training maintenance personnel in visual inspection. Taylor, Robertson, Peck and Stelly (1993) were successful in improving high-level performance objectives (for example, dependability and safety) after instituting a program to train aircraft maintenance personnel in communication and coordination skills. While both of these examples may help SA, neither directly addresses SA as an over-riding objective. Other factors need to be considered to optimize Team SA, such as the skills needed to identify critical information and ensure that it is passed across teams and team members and interpreted based on a common framework across team members.

The objective of this project is to identify situation awareness requirements for aircraft maintenance teams, analyze how SA needs are currently being met in a typical maintenance environment, and establish concepts and requirements for training Team SA in this domain.

## 4.3 METHODOLOGY

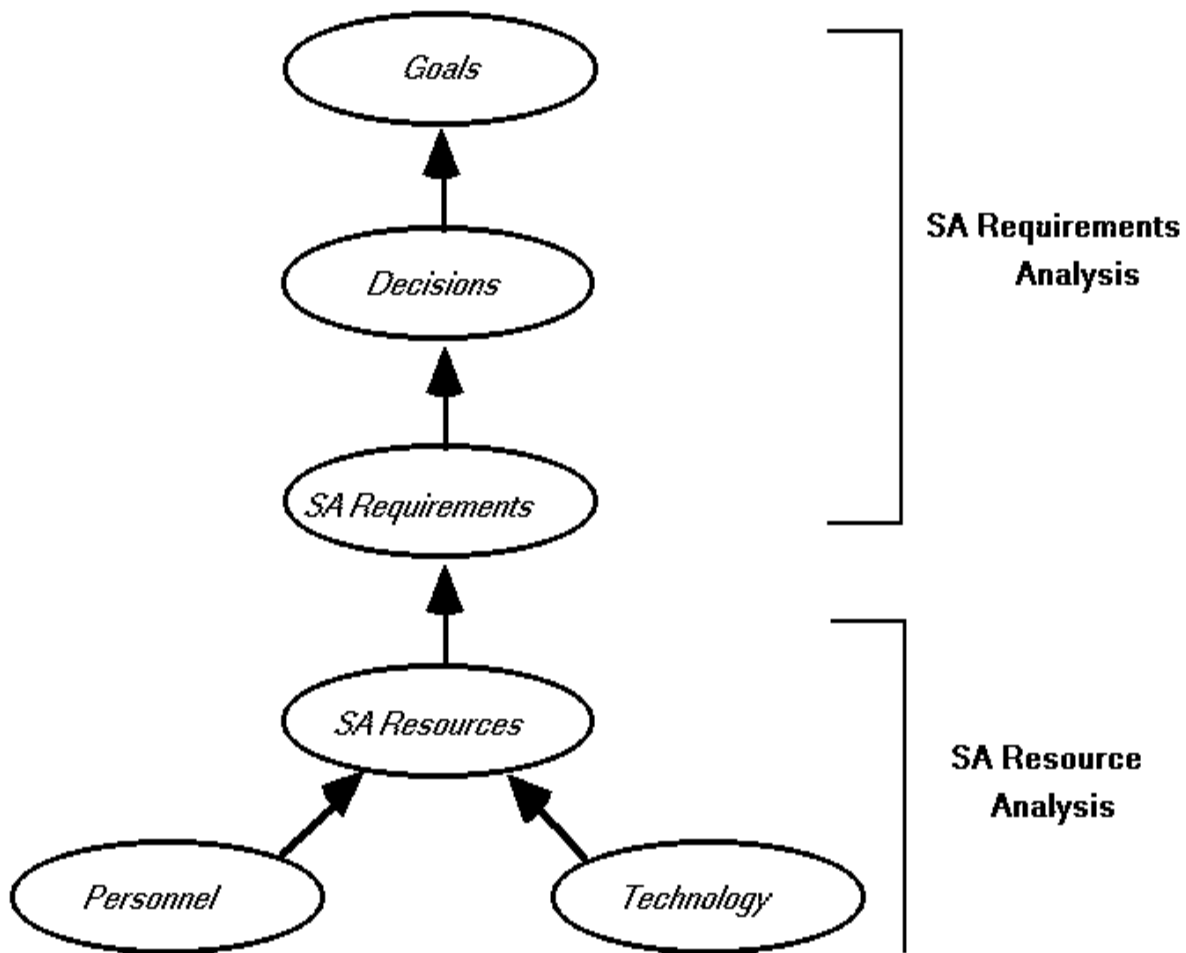
Two major research initiatives were conducted towards the accomplishment of this goal:

- (1) A determination of the requirements and resources for Team SA in aircraft maintenance, and
- (2) An assessment of training needs for Team SA.

Since it was not possible to review practices at all airlines or all locations, these activities were conducted at an aircraft maintenance facility for a major U.S. airline that served as a representative maintenance environment. The B-check maintenance operations at a major airport were selected to keep the project within a reasonable scope. The project was conducted by first identifying SA requirements and the resources used to support those requirements in the selected representative maintenance environment. Concepts for training Team SA were developed based on the analysis.

A Team SA Context Analysis methodology was developed for this project. This method consists of two parts: An SA Requirements Analysis and an SA Resource Analysis, as shown in **Figure 4.1**.

**Figure 4.1 Team SA Context Analysis**



### 4.3.1 SA Requirements Analysis.

The first step was to determine the specific situation awareness requirements of individuals in the aircraft maintenance arena. This was addressed through a goal-directed task analysis which assessed (1) the goals and sub-goals associated with maintenance crews, (2) the decision requirements associated with these goals, and (3) the situation awareness requirements necessary for addressing the decisions at all three levels - detection, comprehension, and projection. This type of analysis has been conducted successfully for several classes of aircraft (Endsley, 1989a; Endsley, 1993), air traffic control (Endsley & Rodgers, 1994) and airway facilities maintenance (Endsley, 1993).

Analyses were conducted through expert elicitation with experienced maintenance personnel, observation of aircraft maintenance activities, and review of all available maintenance documentation. The analysis concentrated on B-Check maintenance activities. Discussions were conducted with three maintenance supervisors, four lead technicians and four A&P technicians.

In addition, personnel in planning and stores, maintenance control, maintenance operations control and aircraft-on-ground at headquarters were involved in the discussions.

### 4.3.2 SA Resource Analysis.

The second part of the Team SA Context Analysis concentrated on identifying the SA Resources used in the current environment to achieve the SA Requirements identified in the goal-directed task analysis. Two major categories of resources were considered: Other personnel as a source of information and technologies used as sources of information.

To provide an assessment of the existing personnel SA resources, an analysis of communications between organizations and individuals was conducted using a contextual inquiry approach. The contextual inquiry approach (Robertson & O'Neill, 1994) focuses on understanding and describing the communication patterns within and between teams as related to their performance goals. The contextual inquiries were conducted simultaneously with the discussions for determining the SA requirements. The contextual inquiries involved semi-structured discussions in which each individual was asked to describe his/her major functions and goals and the organizations or individuals that served as resources in meeting those goals. A mapping was determined showing the interactions among and between team members. Each individual was asked to make an estimate of the overall frequency of communication with each identified unit and the importance of the communication for achieving their goals. Finally, they were asked to identify barriers to effective communication and performance in the work setting.

In addition to identifying the SA requirements of teams working on each maintenance task, the technologies for obtaining each requirement within the current system were documented. Based on this analysis, an assessment was made of the degree to which the current system supports Team SA and the skills and abilities that are required for achieving good SA within this environment. This assessment was used to identify system design recommendations and training concepts for improving Team SA.

## 4.4. RESULTS

A hierarchy of goals in the maintenance environment was developed for several categories of job function within the maintenance team (supervisors, leads and technicians), and for several organizations or teams that work closely with the maintenance team to achieve its goals (Material Services (stores), Planners, and Maintenance Control, including Maintenance Operations Control and Aircraft-on-Ground). These are presented in **Section 4.4.1**. These goals were used to develop a list of SA requirements for each group, shown in **Section 4.4.2**. Next, the personnel resources used for meeting these SA requirements were determined and are presented in **Section 4.4.3**. The technology resources used for meeting the SA requirements were also surveyed and are discussed in **Section 4.4.4**. In addition, barriers and problems for achieving job goals were identified during the discussions and are documented in **Section 4.4.5**.

### 4.4.1 Goals and Functions

Goals for each job analyzed in the maintenance domain were derived from discussions with personnel as a part of the goal-directed task analysis. Job goals at all levels in this domain appear to be oriented towards the dual objectives of ensuring aircraft safety and delivering aircraft for service on time. A breakout of A&P technician goals is shown in **Table 4.2**. The goal break-outs for supervisors and maintenance team leads were identical, and so have been combined and presented in **Table 4.3**. (Supervisors also have significant administrative responsibilities which are outside the scope of this analysis and are not addressed here.)

**Table 4.2 A&P Technician Goals**

<ul style="list-style-type: none"> <li>1.0 Aircraft safety           <ul style="list-style-type: none"> <li>1.1 Deliver aircraft in airworthy, safe condition               <ul style="list-style-type: none"> <li>1.1.1 Make repairs                   <ul style="list-style-type: none"> <li>1.1.1.1 Determine part availability</li> <li>1.1.1.2 Placard problem</li> </ul> </li> <li>1.1.2 Service aircraft</li> <li>1.1.3 Find potential problems</li> <li>1.1.4 Solve problems</li> <li>1.1.5 Provide quality workmanship</li> </ul> </li> <li>1.2 Keep area clean</li> </ul> </li> <li>2.0 Deliver aircraft on time           <ul style="list-style-type: none"> <li>2.1 Prioritize tasks</li> </ul> </li> </ul>
---

**Table 4.3 Lead & Supervisor Goals**

<ul style="list-style-type: none"> <li>1.0 Aircraft safety           <ul style="list-style-type: none"> <li>1.1 Deliver aircraft in airworthy, safe condition               <ul style="list-style-type: none"> <li>1.1.1 Assist mechanics                   <ul style="list-style-type: none"> <li>1.1.1.1 Make repairs</li> <li>1.1.1.2 Service aircraft</li> <li>1.1.1.3 Find potential problems</li> <li>1.1.1.4 Solve problems</li> <li>1.1.1.5 Provide quality workmanship</li> </ul> </li> </ul> </li> <li>1.2 Keep area clean</li> </ul> </li> <li>2.0 Deliver aircraft on time           <ul style="list-style-type: none"> <li>2.1 Prioritize tasks</li> <li>2.2 Assign tasks</li> <li>2.2 Assess aircraft status</li> <li>2.3 Provide coordination</li> </ul> </li> </ul>
---

In general, the top level goals of supervisors and leads are very similar to those of technicians.



They assume many of the same subgoals as the technicians in identifying and solving maintenance problems when needed to support technicians when they run into difficulties. Supervisors and leads, however, also have additional subgoals associated with managing the maintenance teams (assigning and prioritizing tasks, assessing aircraft status and providing coordination).

Specific tasks and functions included within the B-check operations were:

- avionics in cockpit: radar, radios, flaps, gauges,
- interior: lavatories, emergency equipment, seats, overhead bins, lap belts, emergency lighting
- exterior: tires, brakes, fuselage, leading edges and flaps, cargo bays
- right and left engines and wings
- right/left gear lubrication, nose gear lubrication and tail lubrication
- APU
- placards

Several internal organizations (teams) interact with the maintenance team and have a significant role in achieving maintenance goals. The goals and SA requirements for these organizations also were assessed. They included Material Services (Stores) (**Table 4.4**), Planning (**Table 4.5**), and Maintenance Control (**Table 4.6**). Maintenance Operations Control (MOC) (**Table 4.7**) and Aircraft-on-ground (AOG) (**Table 4.8**) are sub-organizations of Maintenance Control.

**Table 4.4 Material Services (Stores) Goals**

1.0	Minimize delays & placards
1.1	Have needed parts/tools/materials ready when needed
1.1.1	Assess parts/tools/materials demands
1.1.2	Assess parts/tools/materials availability
1.1.3	Assemble kits
1.2	Supply parts/tools/materials to other stations
2.0	Minimize costs and time to obtain materials
2.1	Obtain parts/tools/materials in a timely/cost effective manner
2.1.1	Order parts/tools/materials from vendors
2.1.2	Order parts/tools/materials from other stations
2.1.3	Borrow parts/tools/materials from other airlines

**Table 4.5 Planning Goals**

1.0	Set-up and print job cards for remain-over-night (RON) aircraft
1.1	Determine tasks to be done to aircraft

- 1.2 Assess ability to complete tasks
- 1.3 Re-schedule work

#### **Table 4.6 Maintenance Control Goals**

- 1.0 Eliminate out-of-service aircraft and avoid delays
  - 1.1 Determine actions needed to get aircraft back to flight status

#### **Table 4.7 Maintenance Operations Control Goals**

- 1.0 Minimize number of placards on aircraft
  - 1.1 Don't exceed mandated time limits on placards
    - 1.1.1 Get aircraft to desirable station
    - 1.1.2 Approve/disapprove re-routing requests

#### **Table 4.8 Aircraft-on-Ground Goals**

- 1.0 Deliver needed parts ASAP
  - 1.1 Find parts
  - 1.2 Minimize costs

Reviewing the goals of each of these organizations reveals significant interdependencies between teams. For instance, technicians are dependent on Material Services to "have parts/tools/materials ready when needed." Material Services is in turn dependent on Planners to provide relevant task information and on AOG to "deliver needed parts ASAP." These interdependencies, while not surprising, highlight the need for good transfer of information across teams. By examining in detail the situation awareness requirements of each team, it should be possible to gain an understanding of the types of information required by each team and the ways in which the transfer of this information can be improved.

### **4.4.2 SA Requirements**

A breakout of SA requirements for each goal and subgoal was derived from discussions and observations. This is presented in **Table 4.9** (for technicians) and **Table 4.10** (for supervisors and leads). The SA requirements for each goal and subgoal for the supporting organizations was likewise derived and are presented in **Table 4.11** (for material services (stores)), **Table 4.12** (for planning), **Table 4.13** (for maintenance control), **Table 4.14** (for maintenance operations control (MOC)) and **Table 4.15** (for aircraft-on-ground (AOG)). The format of the SA requirements

breakout is as follows:

**X.X Goal**

**X.X.X Subgoal**

- *questions to be answered to meet the goal*
  - SA requirements
  - SA requirements

In general, the analysis identifies a number of SA requirements at all three levels (perception, comprehension and projection) that are important for meeting goals in this domain. There are a few guidelines that should be kept in mind when reviewing this analysis.

- At any given time more than one goal or subgoal may be operating, although these goals will not always have the same priority. The attached SA requirements breakout does not assume any prioritization among them, or that each subgoal within a goal will always come up.
- These are goals or objectives not tasks. The analysis should be as technology free as possible. How the information is acquired is not addressed here (e.g., directly through some system, from another unit, etc.). (This will be addressed in the SA Resource Analysis.)
- The analysis sought to define what technicians would ideally like to know to meet each goal. It is recognized that they often must operate on the basis of incomplete information and that some desired information may not be easily available with today's system.
- Static knowledge, such as procedures or rules for performing tasks, is also outside the bounds of this analysis. The analysis primarily identifies dynamic situational information (information that changes from situation to situation) that effects how technicians perform their tasks.

<b>Table 4.9 A&amp;P Technician SA Requirements</b>	
<b>1.0</b>	<b>Aircraft safety</b>
<b>1.1</b>	<b>Deliver aircraft in airworthy, safe condition</b>
<b>1.1.1</b>	<b>Make repairs</b>
<b>1.1.1.1</b>	<b>Determine part availability</b>
	<ul style="list-style-type: none"><li>• <i>Correct part supplied?</i></li><li>• manufacturer's part number</li><li>• aircraft type, model, tail number</li><li>• maintenance and equipment list (M&amp;E) number</li><li>• effectivity number</li><li>• <i>How long to get part here?</i></li><li>• in-stock status</li></ul>

- manufacturer's part number
- aircraft type, model, tail number
- maintenance and equipment list (M&E) number
- effectivity number
- part & tooling availability
- where
- when it will be here
- delivered or pick-up
- arrival flight number
- arrival gate number

#### **1.1.1.2 Placard problem**

- *Can problem be placarded?*
- type of problem
- Minimum Equipment List (MEL) status
- Deferred information placard (DIP)
- Open item list (OIL)
- redundant systems available
- control number
- log page number
- flight number
- employee number

#### **1.1.2 Service aircraft**

- *Service activities needed?*
- tasks to be done
- fuel status
- lavatory status
- *Are we meeting schedule?*
- time aircraft due at gate
- delays to aircraft
- estimated time of arrival at gate
- aircraft repair status
- *Where do we need to go?*
- permission to taxi
- permission to do high power run-up
- taxi/runway clearances
- *Current status of job?*
- status of other tasks impacting own task
- other tasks own task will impact
- who can help
- who needs help
- tasks started
- tasks completed
- tasks/activities being done next

- who is doing each task
- activity currently being performed by others
- major problems encountered

#### 1.1.3 Find potential problems

- *Item within or beyond serviceable limits?*
- *Item near limits needing preventive maintenance?*
- reported problems
- pilot reports
- placards
- new problems
- worn tires/brakes
- miswiring
- dents/damage
- loose items
- fuel/oil leaks
- items out of ordinary
- functioning of convenience items

#### 1.1.4 Solve problems

- *Fix problem or defer?*
- potential impact of problem on flight safety
- time required to solve problem
- time required to get part
- length of time item can be deferred without repair
- location(s) aircraft is going to
- facility maintenance capabilities
- today's load
- problem deferability category (placardable, groundable)
- minimum equipment list (MEL) status
- *How to solve problem?*
- impact of potential approaches on time
- impact of potential approaches on flight safety
- impact of potential approaches on other tasks/jobs
- possible methods
- possible sources of problem
- maintenance/failure history of item
- part availability (see 1.1.1.1)
- proposed repair authorized
- EC/RA Engineering Change Request Authorization number

#### 1.1.5 Provide quality workmanship

- *Activities performed correctly?*
- tasks performed correctly
- steps to be done

<ul style="list-style-type: none"> <li>• steps completed</li> <li>• location of designated components on system</li> <li>• system type</li> <li>• paperwork completed</li> <li>• parts installed correctly</li> <li>• inspection approved</li> </ul> <p>1.2 Keep area clean</p> <ul style="list-style-type: none"> <li>• <i>Area free of foreign objects?</i></li> <li>• loose objects (screws, parts, etc.)</li> <li>• tools</li> <li>• trash</li> </ul> <p>2.0 Deliver aircraft on time</p> <p>2.1 Prioritize tasks</p> <ul style="list-style-type: none"> <li>• <i>Best order for tasks?</i></li> <li>• task time requirements</li> <li>• interdependence/sequencing requirements of tasks</li> <li>• part availability (see 1.1.1.1)</li> <li>• problem deferability category (placardable, groundable)</li> <li>• minimum equipment list (MEL) status</li> <li>• availability of kits, tools, equipment, vehicles</li> <li>• availability of personnel</li> <li>• personnel skills</li> </ul>
--

**Table 4.10 Lead Technician & Supervisor SA Requirements**

<p><b>1.0 Aircraft safety</b></p> <p><b>1.1 Deliver aircraft in airworthy, safe condition</b></p> <p><b>1.1.1 Assist mechanics</b></p> <p><b>1.1.1.1 Make repairs</b> (see A&amp;P Technician requirements)</p> <p><b>1.1.1.2 Service aircraft</b> (see A&amp;P Technician requirements)</p> <p><b>1.1.1.3 Find potential problems</b> (see A&amp;P Technician requirements)</p> <p><b>1.1.1.4 Solve problems</b> (see A&amp;P Technician requirements)</p> <p><b>1.1.1.5 Provide quality workmanship</b> (see A&amp;P Technician requirements)</p> <ul style="list-style-type: none"> <li>• <i>Procedures followed correctly?</i></li> <li>• required tasks completed properly</li> <li>• tasks completed per manual</li> <li>• paperwork complete</li> </ul>
--



## **1.2 Keep area clean**

(see A&P Technician requirements)

## **2.0 Deliver aircraft on time**

### **2.1 Prioritize tasks**

- *Best order for tasks?*
- tasks scheduled
- aircraft type
- check type
- placards
- non-routine problems
- task time requirements
- time available for tasks
- time due in
- time due out
- location in
- location out
- gate number
- flight number
- interdependence/sequencing requirements of tasks
- part availability
- problem deferability category (placardable, groundable)
- minimum equipment list (MEL) status
- availability of kits, tools, equipment, vehicles
- availability of personnel
- personnel skills

### **2.2 Assign Tasks**

- *Task assignments?*
- personnel here/available
- experience/capability in task type
- speed at performing task
- ability to do job without supervision
- ability to sign off on job
- seniority
- housekeeping
- tasks to be done
- criticality for air safety
- time required to do task
- complexity of task
- how much needs to be disassembled to complete task
- ability to do task at same time as other tasks
- ability to do task at gate
- aircraft location

### 2.3 Assess aircraft status

- *where do we stand on tasks/non-routine problems?*
- *what help is needed?*
- *what problems are the technicians having?*
- *what parts are needed?*
- Impact on delivery schedule
- tasks completed
- tasks in progress
- non-routine problems encountered
- status of non-routine problems
- time required to do remaining tasks
- parts needed
- help/information needed
- personnel needed
- diagnostic support needed

### 2.4 Provide coordination

- *coordination/assistance needed?*
- tasks completed
- tasks in progress
- non-routine problems encountered
- status of non-routine problems
- time required to do remaining tasks
- parts needed
- help/information needed
- personnel needed
- diagnostic support needed

**Table 4.11 Material Services (Stores) Goals**

#### 1.0 Minimize delays & placards

##### 1.1 Have needed parts/tools/materials ready when needed

##### 1.1.1 Assess parts/tools/materials demands

- *What parts/tools/materials are needed?*
- maintenance work forecast
- tasks planned
- aircraft type
- check type
- known placards
- date planned
- parts/tools/materials needed for each task
- aircraft type
- modifications/changes to aircraft

- part number
- effectivity number or mod number
- anticipated problems for aircraft type
- parts/tools/materials needed
- aircraft type
- modifications/changes to aircraft
- part number
- effectivity number or mod number

#### 1.1.2 Assess parts/tools/materials availability

- *Can we meet demands?*
- state of internal inventory
- number of items per part number/effectivity number
- other parts that are interchangeable
- engineering authorization for substitution
- *Is item available elsewhere?*
- availability of parts/tools/materials at other stations
- availability of parts/tools/materials at other airlines
- availability of parts/tools/materials at vendors

#### 1.1.3 Assemble kits

- *Kits ready?*
- kit complete/correct
- kit assembled prior to when needed
- Assess demands (1.1.1)
- Assess availability (1.1.2)
- Obtain items (2.1)

#### 1.2 Supply parts/tools/materials to other stations

- *Can I supply this item?*
- requests for items
- urgency of need
- parts/tools/materials needed
- aircraft type
- modifications/changes to aircraft
- part number
- effectivity number or mod number
- Assess own demands (1.1.1)
- *Where to send item?*
- stations plane will R.O.N. in
- capabilities of station
- urgency of need
- *How can I get it there in a timely/cost effective manner?*
- shipment methods available
- cost
- timeliness

- 2.0 Minimize costs and time to obtain materials
  - 2.1 Obtain parts/tools/materials in a timely/cost effective manner
    - *can I get this item by the time its needed?*
    - *what is the most cost and time effective method of obtaining?*
    - availability of parts/tools/materials at other stations
    - availability of parts/tools/materials at other airlines
    - availability of parts/tools/materials at vendors
    - urgency of need
    - time item needed by
    - shipment methods available
    - cost
    - timeliness
    - 2.1.1 Order parts/tools/materials from vendors
      - *What needs to be ordered?*
      - *When should items be ordered?*
      - lead time to keep inventory at levels needed
      - state of internal inventory
      - number of items per part number/effectivity number
      - re-order points
      - usage requirements (number of items per month)
    - 2.1.2 Order parts/tools/materials from other stations
      - *What needs to be ordered?*
      - *Who has item?*
      - *Who can deliver item quickest and cheapest?*
      - cost
      - time to acquire
      - delivery method
      - item availability
    - 2.1.3 Borrow parts/tools/materials from other airlines
      - *What needs to be ordered?*
      - *Who has item?*
      - *Who can deliver item quickest and cheapest?*
      - cost
      - time to acquire
      - delivery method
      - item availability

**Table 4.12 Planning Goals**

**1.0 Set-up and print job cards for remain-over-night (RON) aircraft**

**1.1 Determine tasks to be done to aircraft**

- *what needs to be done to aircraft?*
- *amount of time until work must be performed?*

- tasks to be completed
- routine work
- type of check
- standard check items
- known placards
- expiration date/time on placard
- non-routine work
- new placards
- expiration date/time on placard
- extra jobs (flight directives, etc.)

**1.2 Assess ability to complete tasks**

- *can work be done here?*
- *manpower available for tasks to be done?*
- time required to complete tasks
- number of man-hours required for tasks
- time available to complete work
- number of man-hours available
- *ability to perform work?*
- parts availability
- in-house
- being shipped
- time of arrival
- material availability
- tooling availability

**1.3 Re-schedule work**

- *can work be deferred?*
- *can plane be delayed?*
- *can aircraft be re-routed?*
- problems encountered in completing work
- new placards
- assess ability to complete work here (1.2)

**Table 4.13 Maintenance Control Goals**

**1.0 Eliminate out-of-service aircraft and avoid delays**

**1.1 Determine actions needed to get aircraft back to flight status**

- *Can aircraft be fixed?*
- problem diagnosis
- type of repairs needed
- parts needed
- estimated time to repair (ETR)
- aircraft model
- description of problem

- status of system parameters
- actions performed
- history of actions on systems/parts on aircraft
- estimated return to service time (RTD)
- confidence in RTD estimate
- estimated time to repair (ETR)
- time to acquire parts
- time to acquire people with skills
- *Is alternate action needed?*
- *Will current actions meet schedule requirements?*
- Estimated return to service time (RTD)
- Scheduled time aircraft due in service
- *Can problem be deferred?*
- M.E.L. list
- other system repairs currently deferred
- scheduled trips (cities, routes)
- weather forecast
- distance of trips
- fuel loads required
- altitude restrictions
- capabilities of stations on current schedule
- *Can aircraft be rescheduled?*
- alternate routes available
- capabilities of stations on alternate routes
- *Temporary repair possible?*
- type of repairs needed
- parts needed
- estimated time to repair (ETR)

**Table 4.14 Maintenance Operations Control Goals**

**1.0 Minimize number of placards on aircraft**

**1.1 Don't exceed mandated time limits on placards**

**1.1.1 Get aircraft to desirable station**

- *Which station should aircraft be sent to?*
- *Can necessary work be performed at stations on route?*
- *Impact of route on schedule?*
- Stations scheduled for R.O.N. on route
- placarded item
- number of days on limit
- type of repairs needed
- parts needed



- estimated time to repair (ETR)
- capability of stations
- availability of parts at stations
- availability of expertise/manpower at stations

**1.1.2 Approve/disapprove re-routing requests**

- *Okay to re-route aircraft?*
- *Can necessary work be performed at new stations?*
- *Impact of re-route on schedule?*
- Stations scheduled for R.O.N. on route
- placarded item
- number of days on limit
- type of repairs needed
- parts needed
- estimated time to repair (ETR)
- capability of stations
- availability of parts at stations
- availability of expertise/manpower at stations

**Table 4.15 Aircraft-on-Ground Goals**

**1.0 Deliver needed parts ASAP**

**1.1 Find parts**

- *Where can the part be acquired from as soon as possible?*
- part number/effectivity number
- reference used to determine part number
- interchangeability of parts
- quantity needed
- rotatable/expendable
- station part needed at
- location of available parts
- other stations
- other airlines
- vendors
- priority
- time aircraft due back in service
- status of part delivery

**1.2 Minimize costs**

- *What is the least expensive place to get the part by the needed time?*
- *What is the least expensive way to get the part to the station by the needed time?*
- expedite fees
- volume discounts

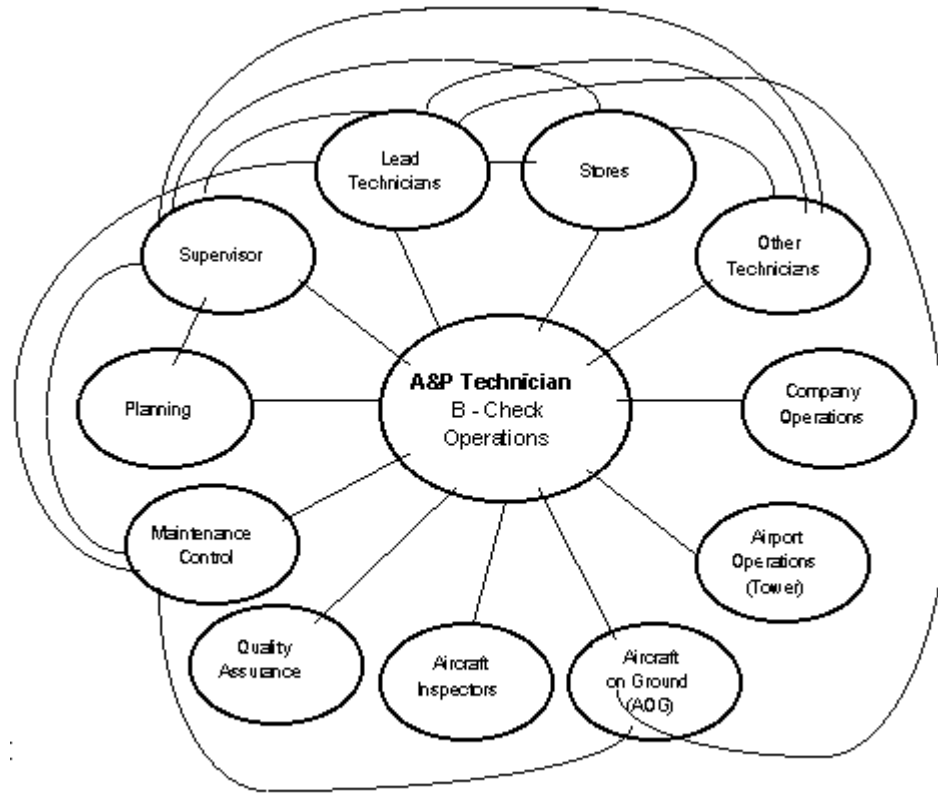
- delivery method
- priority
- time aircraft due back in service
- cost of available parts
- other stations
- other airlines
- vendors

### 4.4.3 SA Resources: Personnel

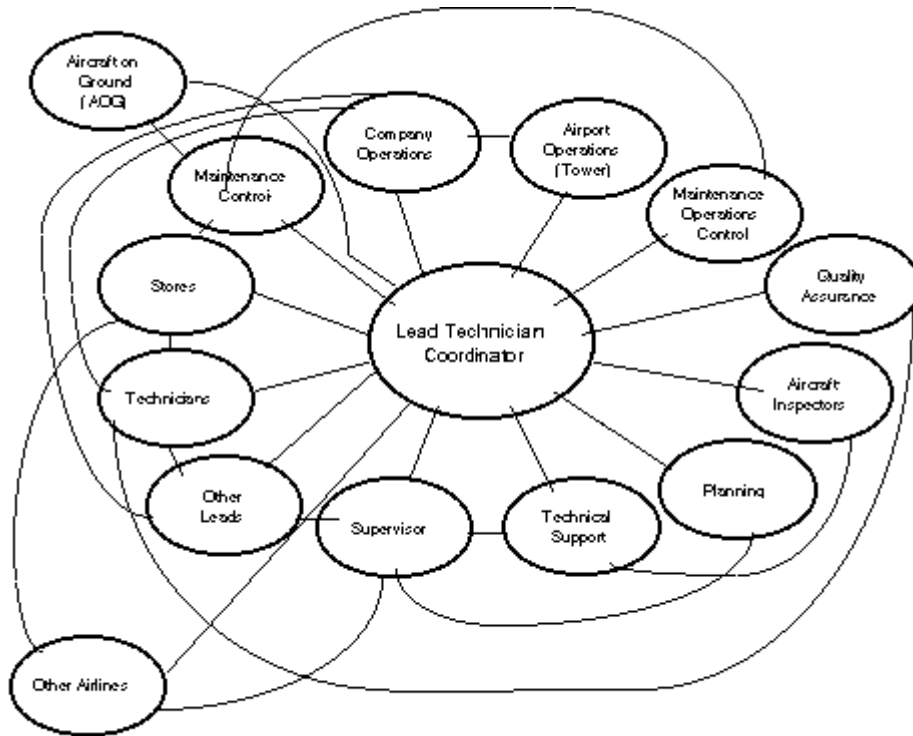
The personnel resources and technology resources used within the organization to meet the situation awareness needs identified in **Section 4.4.2** were ascertained through the contextual inquiry methodology. Personnel resources are presented in this section and the technology resources are in **Section 4.4.4**.

Results of the contextual inquiries are presented in **Figures 4.2** through **4.11**. The figures depict the personnel SA resources, in terms of the individuals or units within the maintenance technical operations, that are needed to achieve the team's performance goals. **Figures 4.2, 4.3, and 4.4** show the organizations and individuals that the A&P technician, lead technician and supervisor interface with, respectively. Lines and arcs show communication patterns between organizations. **Figure 4.5** shows the personnel requirements for the material services (stores) supervisor and **Figure 4.6** for a lead in material services, **Figure 4.7** for planners, **Figure 4.8** for a maintenance control manager and **Figure 4.9** for maintenance control controllers, **Figure 4.10** for maintenance operations control, and **Figure 4.11** for aircraft-on-ground. Supervisor SA resources were delineated for some organizations where available.

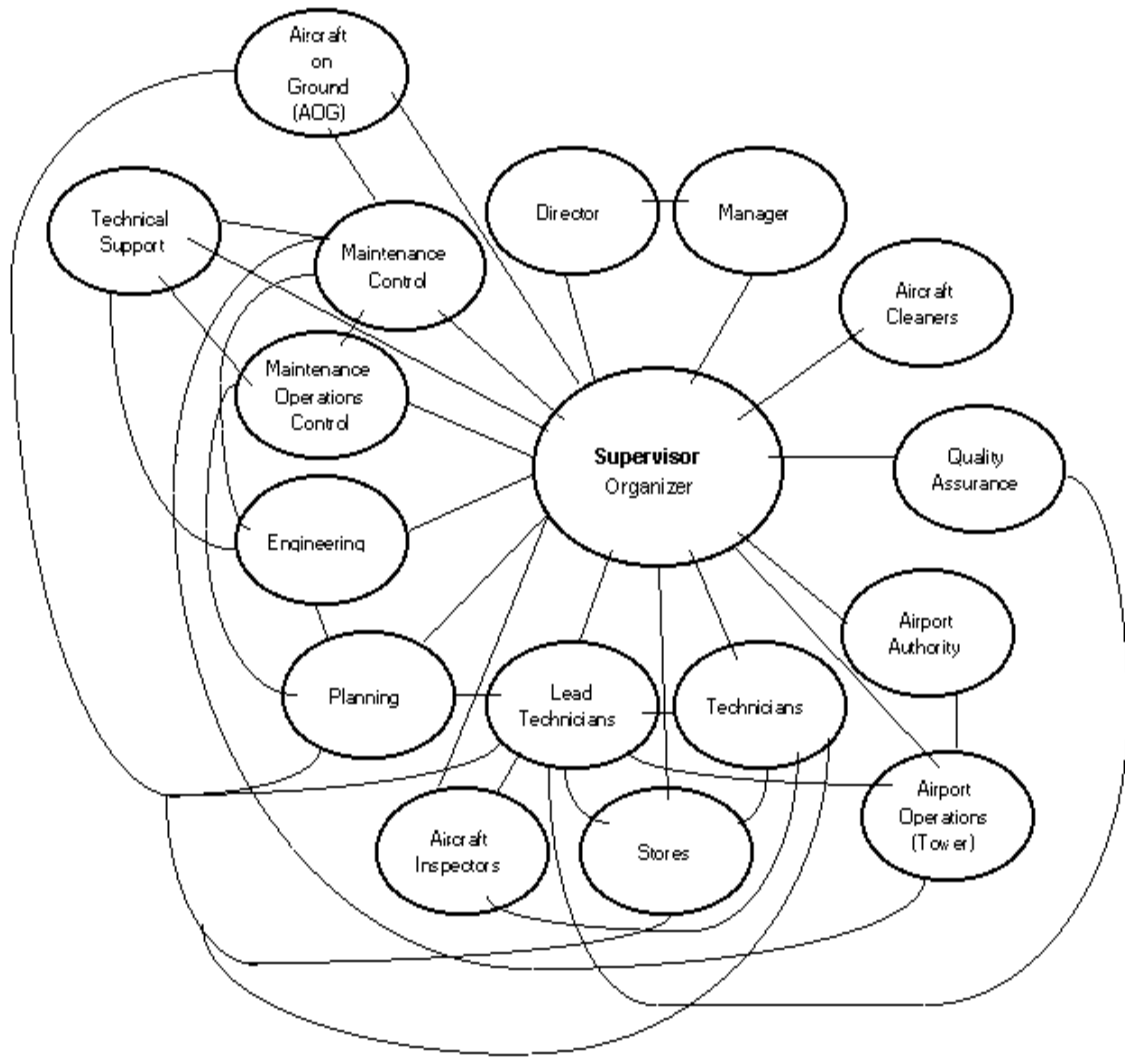
#### Figure 4.2 SA Resources: A&P Technician



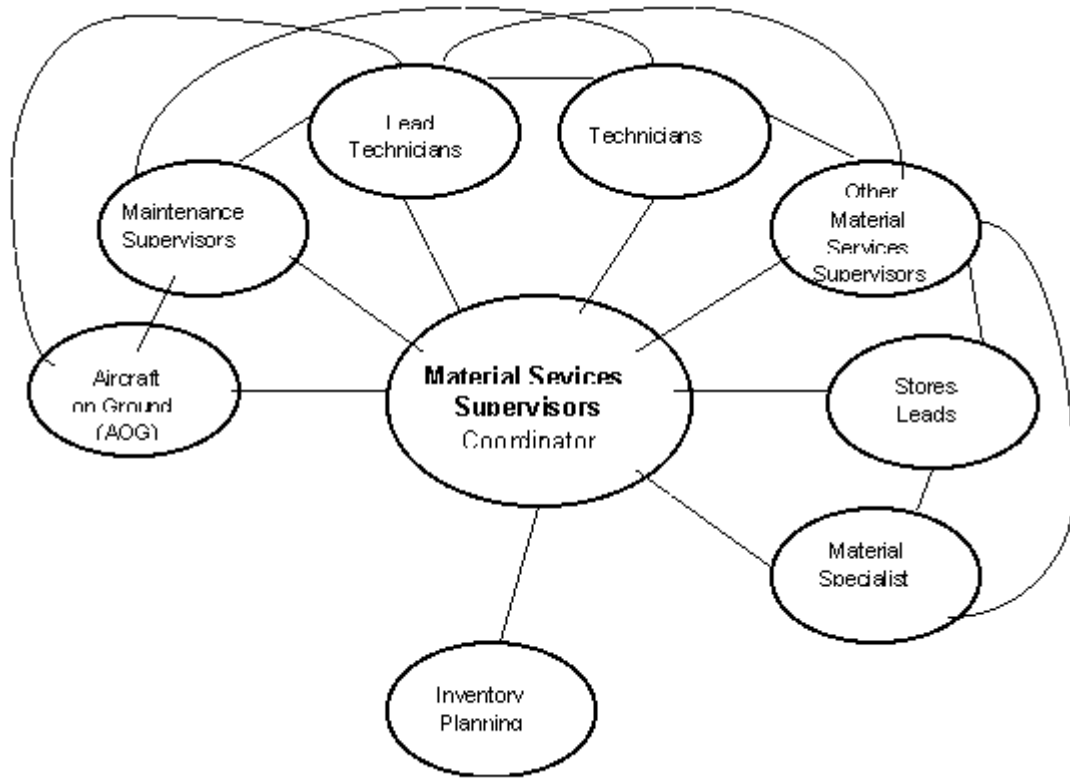
**Figure 4.3 SA Resources: Lead Technician**



**Figure 4.4 SA Resources: Supervisor**

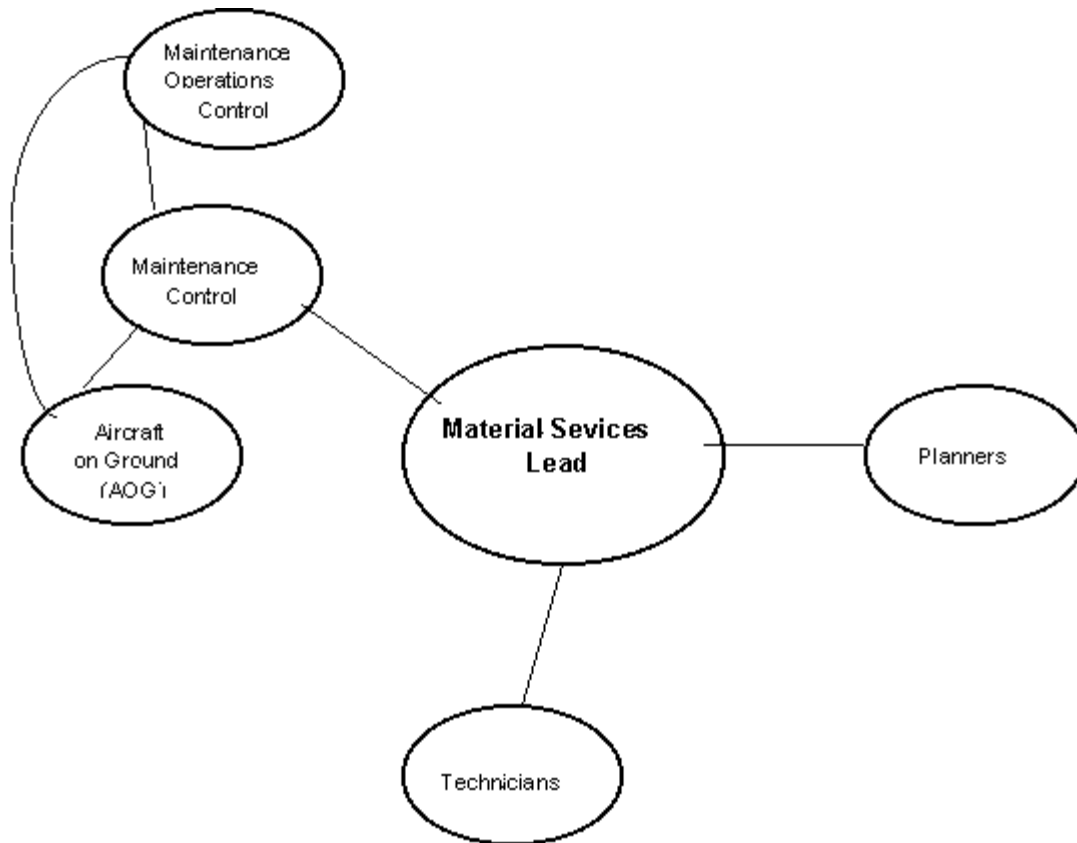


**Figure 4.5 SA Resources: Material Services Supervisor**



**Figure 4.6 SA Resources: Material Services Lead**





**Figure 4.7 SA Resources: Planner**

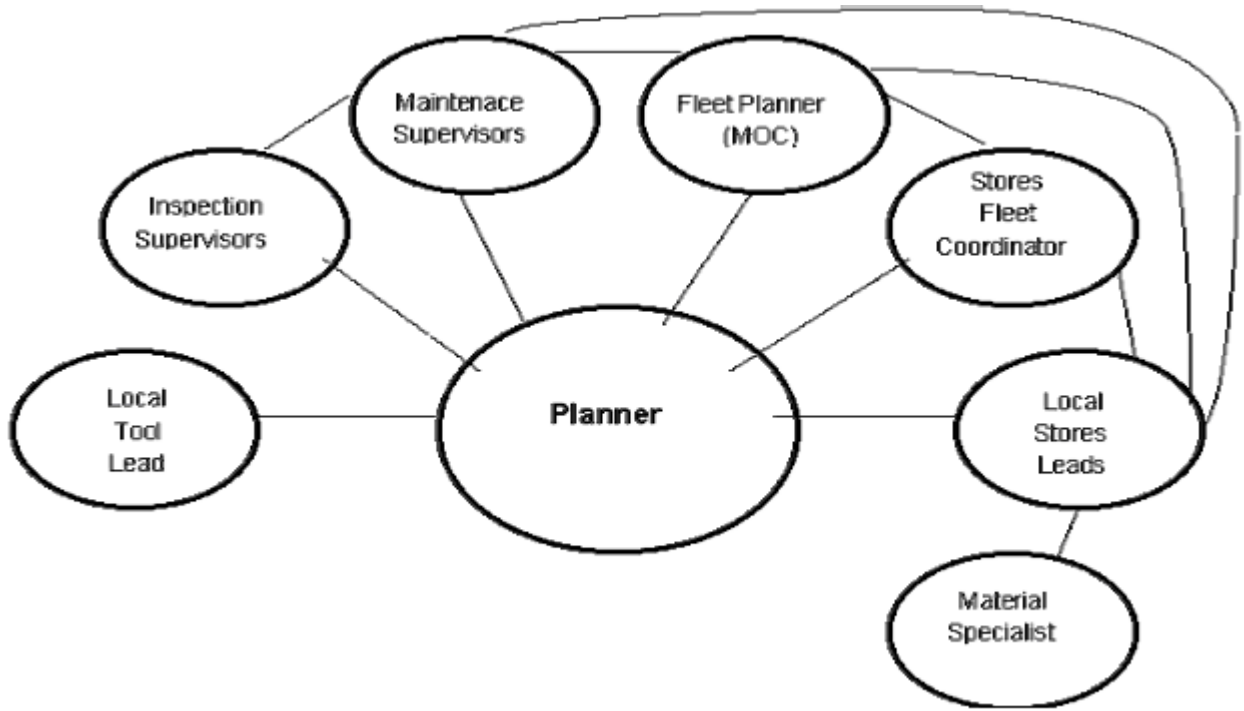
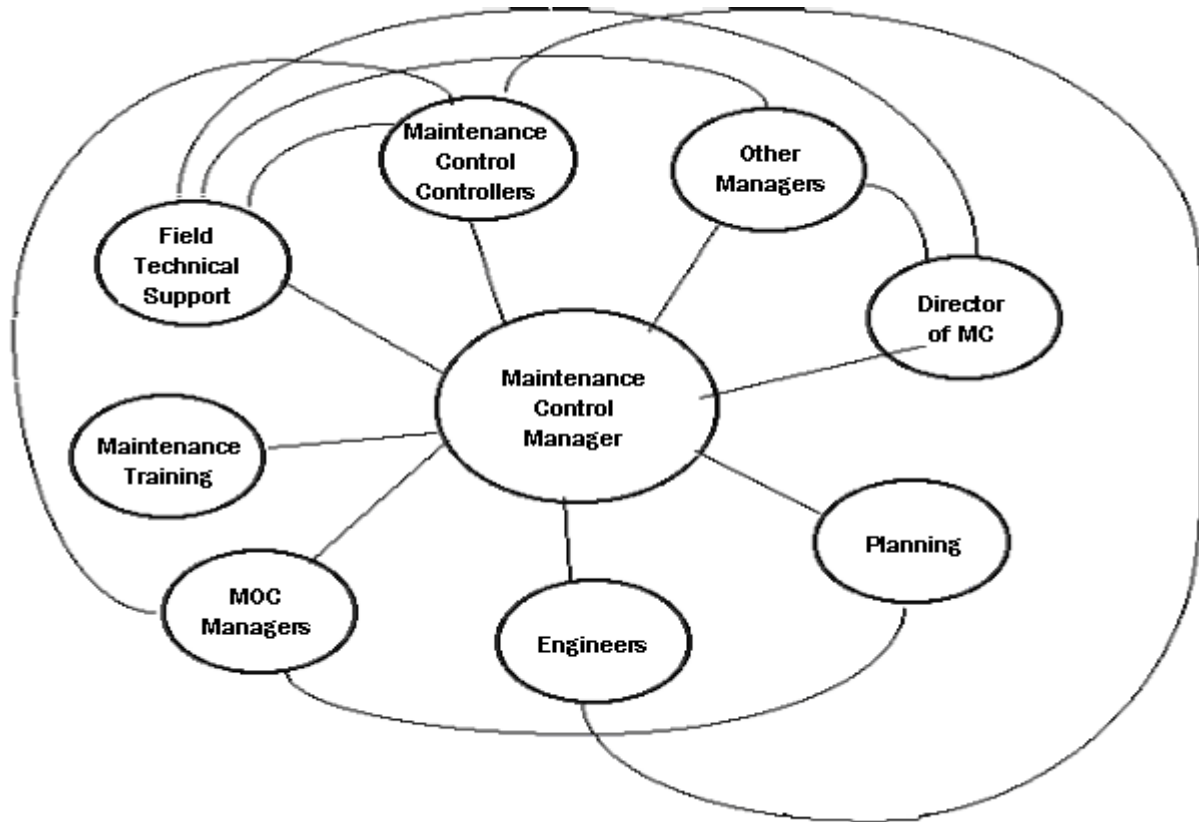


Figure 4.8 SA Resources: Maintenance Control Manager



**Figure 4.9 SA Resources: Maintenance Control Controllers**

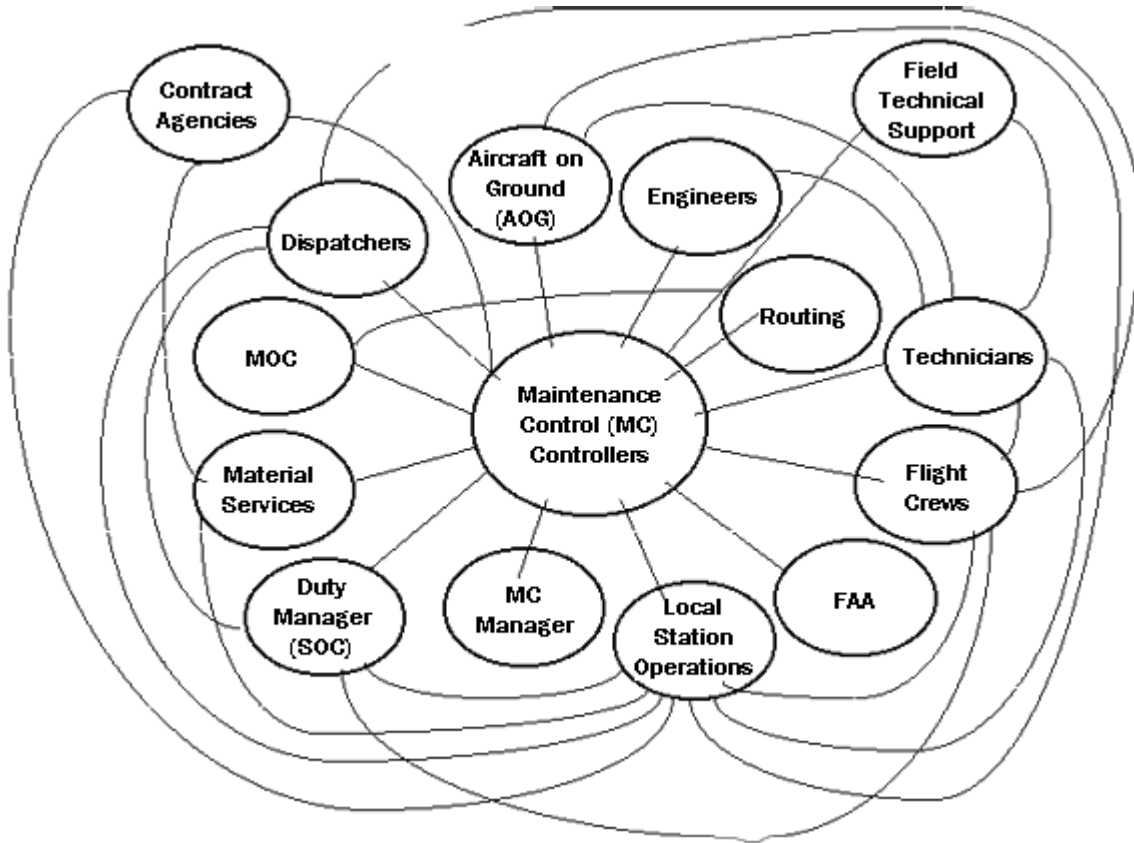


Figure 4.10 SA Resources: Maintenance Operations Control (MOC) Controller

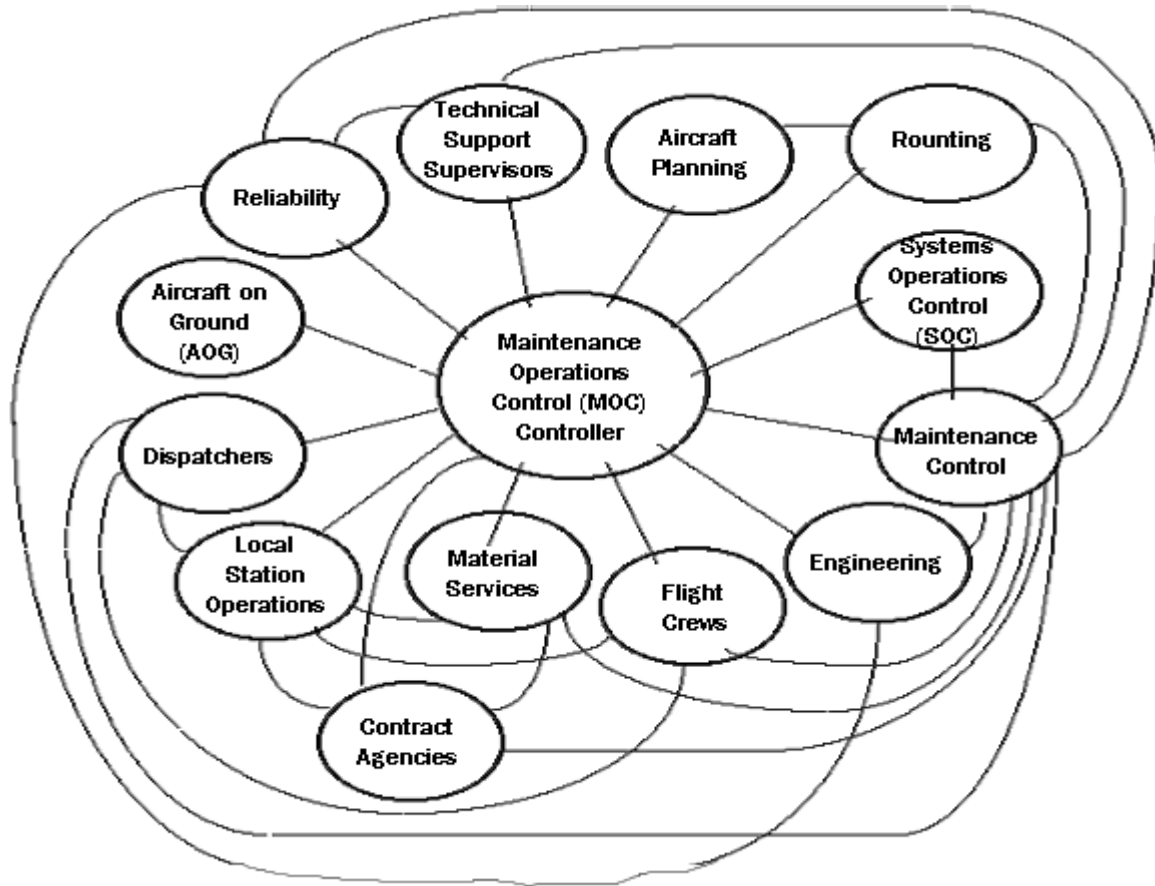
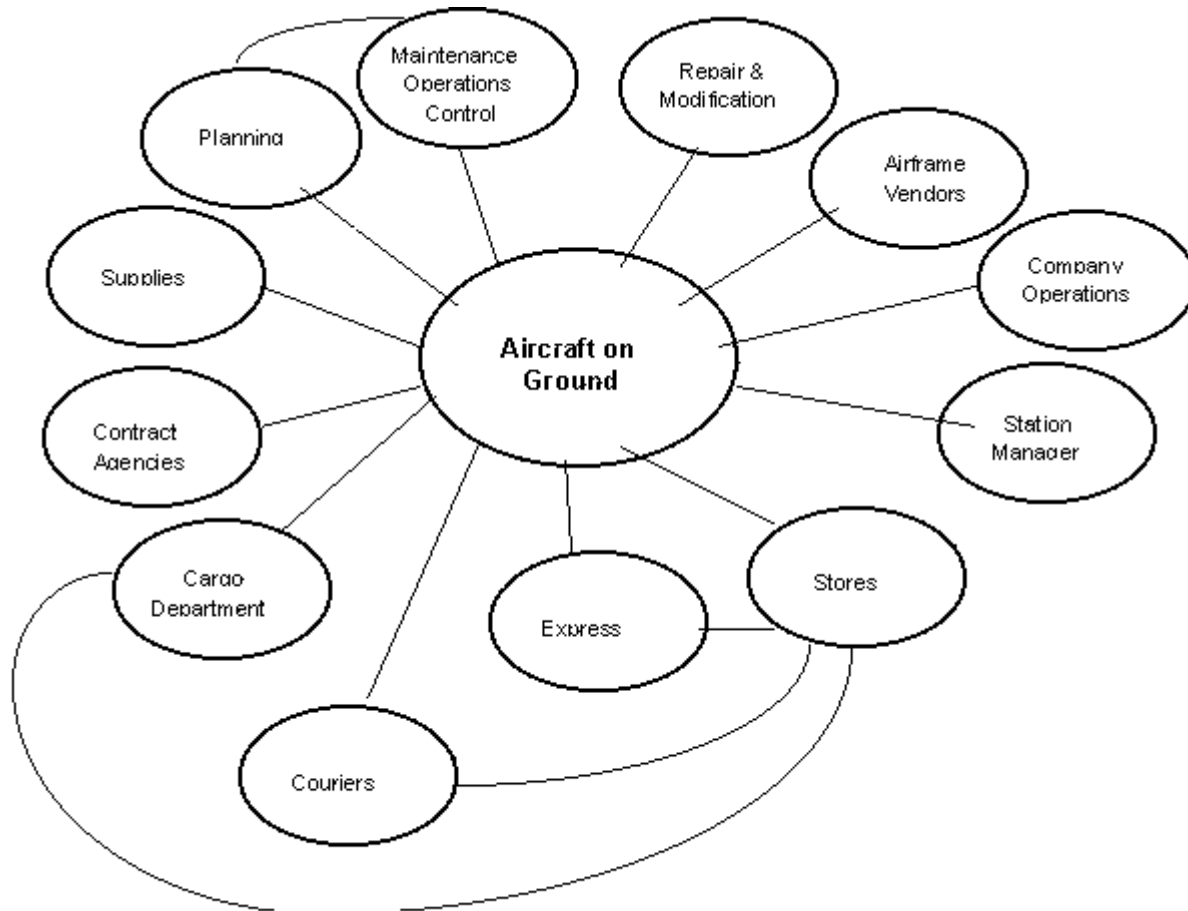


Figure 4.11 SA Resources: Aircraft-on-Ground



Estimates were made by each individual in the discussion concerning the overall frequency of communication with each maintenance unit and other team personnel. Each individual assigned a percentage (of 100%) to each unit that reflected the overall frequency of communication of each interchange. For each of these SA resources, the importance of the communication also was rated on a four point scale, where 1 represents a very important communication interface for achieving the team's performance goals and 4 represents a relatively low importance resource. Mean estimates of communication frequency and importance were determined for each of the interfacing organizations depicted in each figure and are presented numerically in **Tables 4.16** through **4.23**.

**Table 4.16** displays the personnel SA resources, mean importance, and mean frequencies for the communication interfaces from the perspective of the A&P technician. Several personnel and work units were indicated as very important knowledge resources necessary to accomplish the A&P technicians' jobs. These were the other technicians, airport operations (tower) and company operations (ramp personnel), closely followed by lead technicians and stores (material services). The highest reported frequency of communication was with the other technicians (54.50%), followed by lead technicians (26.75%).

**Table 4.16 SA Personnel Resources: A&P Technicians**

<i>SA Resources: Personnel</i>	<i>Mean Importance</i>	<i>Mean Frequency (%)</i>
<b>Maintenance Control - Maintenance Operations Control Aircraft on Ground (AOG)</b>	2.5	3.75
<b>Lead Technician</b>	1.5	26.75
<b>Stores</b>	1.5	8.25
<b>Other Technicians</b>	1.0	54.50
<b>Airport Operations</b>	1.0	< 1.00
<b>Company Operations</b>	1.0	< 1.00
<b>Supervisor</b>	3.2	2.25
<b>Quality Assurance</b>	2.5	< 1.00
<b>Aircraft Inspectors</b>	2.0	3.25
<b>Planning</b>	2.0	< 1.00

**Table 4.17** displays the personnel SA resources, mean importance, and mean frequencies for the communication interfaces from the perspective of the lead technician. The most important knowledge resources necessary to accomplish their jobs were maintenance control, stores (material services) and technicians. The highest reported frequency of communication was with the technicians (45.3%), followed by maintenance control (13.3%), and the supervisor (13.3%).

**Table 4.18** displays the personnel SA resources, mean importance, and mean frequencies for the communication interfaces from the perspective of the maintenance supervisor. The most important knowledge resources necessary to accomplish their jobs were maintenance control, lead technicians, technicians, quality assurance and the director. The highest reported frequency of communication was with the lead technicians (35.0%) and technicians (32.5%).

**Table 4.17 SA Personnel Resources: Lead Technicians**

<i>SA Resources: Personnel</i>	<i>Mean Importance</i>	<i>Mean Frequency (%)</i>
<b>Maintenance Control - Maintenance Operations Control Aircraft on Ground (AOG)</b>	1.3	13.3
<b>Other Leads</b>	3.0	6.0
<b>Stores</b>	1.3	10.0
<b>Technicians</b>	1.6	45.3
<b>Airport Operations</b>	2.0	< 1.0
<b>Company Operations</b>	3.5	3.3
<b>Supervisor</b>	3.0	13.3
<b>Quality Assurance</b>	3.6	< 1.0
<b>Planning</b>	2.0	1.6



<b>Aircraft Inspectors</b>	3.6	2.2
<b>Other Airlines</b>	2.0	< 1.0
<b>Technical Support</b>	2.0	3.6

<b>Table 4.18 SA Personnel Resources: Supervisors</b>		
<i>SA Resources: Personnel</i>	<i>Mean Importance</i>	<i>Mean Frequency (%)</i>
<b>Maintenance Control - Maintenance Operations Control Aircraft on Ground (AOG)</b>	1.0	6.0
<b>Lead Technicians</b>	1.0	35.0
<b>Stores</b>	1.5	6.5
<b>Technicians</b>	1.0	32.5
<b>Airport Operations</b>	2.5	3.0
<b>Quality Assurance</b>	1.0	2.5
<b>Director &amp; Managers</b>	1.0	6.0
<b>Planning</b>	2.0	7.5
<b>Engineering &amp; Technical Support</b>	2.0	< 1.0
<b>Aircraft Inspectors</b>	3.0	< 1.0
<b>Aircraft Cleaners</b>	3.0	< 1.0
<b>Airport Authority</b>	3.0	< 1.0

**Table 4.19** displays the personnel SA resources, mean importance, and mean frequencies for the communication interfaces for the material services supervisor. The most important knowledge resources necessary to accomplish this job was maintenance control, leads, and material specialists in Stores, as well as other supervisors in material services and in maintenance. The highest reported frequency of communication was with material specialists (30.0%) followed by leads in material services (20.0%).

<b>Table 4.19 SA Personnel Resources: Material Services Supervisor</b>		
<i>SA Resources: Personnel</i>	<i>Mean Importance</i>	<i>Mean Frequency (%)</i>
<b>Maintenance Control - Maintenance Operations Control Aircraft on Ground (AOG)</b>	1	< 5.0
<b>Lead Technicians</b>	2	10.0
<b>Technicians</b>	2	10.0
<b>Stores Leads</b>	1	20.0
<b>Material Specialists</b>	1	30.0
<b>Inventory Planning</b>	2	< 5.0

<b>Maintenance Supervisor</b>	1	15.0
<b>Other Material Services Supervisors</b>	1	10.0

**Table 4.20** displays the personnel SA resources, mean importance, and mean frequencies for the communication interfaces for the material services leads. The most important knowledge resources necessary to accomplish this job was maintenance control and technicians. The highest reported frequency of communication was also with these two groups.

<b>Table 4.20 SA Personnel Resources: Material Services (Stores) Leads</b>		
<i>SA Resources: Personnel</i>	<i>Mean Importance</i>	<i>Mean Frequency (%)</i>
<b>Maintenance Control - Maintenance Operations Control Aircraft on Ground (AOG)</b>	1	40.0
<b>Technicians</b>	1	40.0
<b>Planner</b>	2	20.0

**Table 4.21** displays the personnel SA resources, mean importance, and mean frequencies for the communication interfaces for planning. The most important knowledge resources necessary to accomplish this job was the maintenance supervisor, the planners, and coordinator for the fleet (at company headquarters) and the local tool lead. The highest reported frequency of communication was with the fleet planner and fleet stores coordinator.

<b>Table 4.21 SA Personnel Resources: Planners</b>		
<i>SA Resources: Personnel</i>	<i>Mean Importance</i>	<i>Mean Frequency (%)</i>
<b>Maintenance Supervisor</b>	1	20.0
<b>Fleet Planner (MOC)</b>	1	30.0
<b>Stores Fleet Coordinator</b>	1	30.0
<b>Local Material Services (Stores) Lead</b>	3	10.0
<b>Inspection Supervisor</b>	2	5.0

**Table 4.22** displays the personnel SA resources, mean importance, and mean frequencies for the communication interfaces for managers at maintenance control. The most important knowledge resources necessary to accomplish this job were the controllers and other managers in this organization, the director of the organization, and field technical support. The highest reported frequency of communication was with the director, controllers, and other managers.

<b>Table 4.22 SA Personnel Resources: Maintenance Control Managers</b>		
<i>SA Resources: Personnel</i>	<i>Mean Importance</i>	<i>Mean Frequency (%)</i>

<b>Maintenance Controllers</b>	1	25
<b>Maintenance Operations Control (MOC)</b>	4	< 5
<b>Planning</b>	4	< 1
<b>Director of Maintenance Control</b>	1	20
<b>Maintenance Training</b>	2	5
<b>Engineers</b>	2	10
<b>Other Managers</b>	1	25
<b>Field Technical Support</b>	1	10

**Table 4.23** displays the personnel SA resources, mean importance, and mean frequencies for the communication interfaces for controllers in maintenance control. The most important knowledge resources necessary to accomplish this job were the technicians, the SOC duty manager, engineers, and aircraft-on-ground. The highest reported frequency of communication was with technicians.

<b>Table 4.23 SA Personnel Resources: Maintenance Control Controllers</b>		
<i>SA Resources: Personnel</i>	<i>Mean Importance</i>	<i>Mean Frequency (%)</i>
<b>Technicians</b>	1	23.5
<b>Flight Crews</b>	2	3.3
<b>Local Station Operations</b>	1.5	5.0
<b>Duty Manager (SOC)</b>	1	15.6
<b>Material Services</b>	2	10.0
<b>Dispatchers</b>	2	10.0
<b>Contract Agencies</b>	2	10.0
<b>Aircraft on Ground (AOG)</b>	1	15.0
<b>Engineers</b>	1	3.0
<b>Routing</b>	2	< 1.0
<b>Field Technical Support</b>	1.5	< 1.0
<b>MC Manager</b>	1.5	< 1.0
<b>FAA</b>	4	< 1.0
<b>Maintenance Operations Control (MOC)</b>	4	< 2.0

**Table 4.24** displays the personnel SA resources, mean importance, and mean frequencies for the communication interfaces for maintenance operations control. The most important knowledge resources necessary to accomplish this job were aircraft routing, planning, and material services.

The highest reported frequency of communication was with routing and material services.

<b>Table 4.24 SA Personnel Resources: Maintenance Operations Control</b>		
<i>SA Resources: Personnel</i>	<i>Mean Importance</i>	<i>Mean Frequency (%)</i>
Engineers	4	6.0
Maintenance Control	2	4.0
Systems Operations Control (SOC)	2	4.0
Aircraft Planning	1	10.0
Technical Support Supervisor	3	6.0
Reliability	2.5	6.0
Local Station Operations	1.2	10.0
Aircraft on Ground (AOG)	1.2	< 3.0
Dispatchers	2.2	8.6
Material Services	1	15.0
Contract Agencies	2	8.6
Flight Crews	2	< 3.0
Aircraft Routing	1	18.0

**Table 4.25** displays the personnel SA resources, mean importance, and mean frequencies for the communication interfaces for aircraft-on-ground. The most important knowledge resources necessary to accomplish this job were stores, maintenance control, and maintenance operations control. The highest reported frequency of communication was with the same three organizations.

<b>Table 4.25 SA Personnel Resources: Aircraft on Ground</b>		
<i>SA Resources: Personnel</i>	<i>Mean Importance</i>	<i>Mean Frequency (%)</i>
Stores	1	25.0
Cargo Department	3	< 3.0
Express	3	< 1.0
Couriers	3	< 1.0
Station Maintenance	3	< 5.0
Operations	3	< 5.0
Airframe Vendors	4	< 1.0
Repair & Modification	4	< 1.0
Maintenance Operations Control (MOC)	1	20.0
Planning	4	< 1.0
Maintenance Control	1	25.0

<b>Supplies</b>	2	10.0
<b>Contract Agencies</b>	2	10.0

Overall, a great deal of interdependency can be seen between the organizations and personnel included in this study. Each job type involved interacting with between 3 and 14 different organizations to attain (or supply) the information needed to perform the job. In general two or three of these interactions were viewed as very important and constituted the majority of each function's interactions, however, for many of the functions there were also many organizations that were interacted with at least occasionally. Specific issues regarding these interactions that can have a significant impact on SA were uncovered during the analysis and are discussed in **Section 4.5**.

#### **4.4.4 SA Resources: Technologies**

In addition to ascertaining the personnel resources used for attaining situation awareness, the technologies used within the maintenance organization were also examined. The primary technologies used for passing information within the organization included Spectre, a system for logging maintenance activities, several non-integrated databases used across several organizations, and technical documentation that could be found in various hard copy manuals and micro-fiche.

From the standpoint of supporting situation awareness, several shortcomings exist within these technologies. First, Spectre, a computer program that supports maintenance activities at many large air carriers, is woefully deficient in supporting the SA needs of the technicians and others with whom they interact. The primary problem is that the database is based on very old 1970's computer technology that does not meet even basic human-computer interaction standards. Finding information within screens is difficult due to poor layout and presentation, and finding desired screens is quite confusing. These problems greatly increase the likelihood of making an error, spending excess time in trying to find needed information, and, most importantly, decrease the likelihood that the system will be utilized fully to share information across organizations. Particularly since the personnel using this technology are not necessarily high-level computer users, significant changes in this technology would be most beneficial. An upgrade is greatly needed to provide information that is organized around the user's needs (as outlined in the SA requirements analysis presented here). This information can be used to create a database interface that presents the information that is needed in a form that is integrated around the user's goals and corresponding SA needs. A Windows menu-based interface is recommended to provide ease of use for personnel whose main job is not programming computers but fixing aircraft.

Secondly, while Spectre serves as the main database for the technicians, several other computerized databases are also present in the system. These databases all run on separate systems, function in different ways and are non-integrated. This poses significant difficulties for personnel who must switch between several systems to find the information they need. It requires entering information multiple times, which is both time consuming and error prone. To

support situation awareness, these databases need to be integrated. While different databases may be needed to support different functions, they should be designed along a common interface framework and links should be provided between databases so that personnel can easily pull up needed information from one system while working on another system. Without this type of functionality, it is very difficult for personnel to achieve an up-to-date picture of critical situation elements.

Thirdly, a large number of technical manuals are present throughout the organization. These manuals are very important for diagnostic activities, finding proper parts numbers and ascertaining information needed to conduct certain procedures. At present this information is widely distributed in various hard copy manuals and micro-fiche, which may not be up-to-date, and may not cover pertinent modifications or differences between particular aircraft even within a model (due to significant customization of aircraft at the time of purchase and subsequent modifications). This results in a system where personnel spend a considerable amount of time trying to find the information that is needed, often find incorrect information (regarding the needed part number for example), and which provide significant system inefficiencies. Frequently repairs are delayed when the wrong part is procured, for example, and unneeded work is conducted in disassembling and reassembling an aircraft system, upon finding that the repair cannot be made. Pertinent drawings, specifications and technical information needs to be computerized, linked to the aircraft tail number (so that it is correct relative to the customization and changes that have been made to that aircraft), and made directly accessible to the technician through a common interface. By linking this information to the database that technicians use to log information and pass information to other organizations, a significant improvement will be realized in the quality and correctness of information transferred. At present, the information passed within the database tends to be minimal (due to the poor interface and typing requirements). The ability to make direct reference to drawings, procedures and part-numbers will greatly help with this problem. It furthermore puts all needed information at the user's finger-tips which will greatly reduce confusion, errors and wasted time.

#### **4.4.5 Barriers and Problems**

During the discussion process, maintenance personnel were solicited to determine factors that created barriers to effective communication and performance. Barriers are issues that slow down or hinder performance. These are problems that maintenance teams have to routinely overcome in order to meet their performance goals. They encompass organizational, technical and personnel issues. Barriers that were mentioned by the maintenance personnel are listed in order of frequency in **Table 4.26**. In general, most people felt that the system worked quite well, however, almost all could name a few areas where improvement was possible.

The most frequently mentioned barrier was a lack of proper tooling for completing a job which is exacerbated by the fact that much of the repair work has been out-sourced thus making rapid access to correct tooling and parts difficult. In addition to a certain lack of trust of these external organizations (probably stemming from lack of information), there was an expressed frustration with not being able to interact with personnel where the repair work had been out-sourced so that questions pertaining to specific items could be addressed. A decreased reliability of parts and

quality control problems with parts coming from out-sourced vendors was also mentioned. Maintenance personnel expressed the need to be able to track parts by vendor names and to track the quality and reliability of these parts that the current system does not support.

The second most commonly listed problem was an unavailability of parts and difficulty in determining when the proper parts would be available to the technician. Often the parts supplied would not be correct for the specific model and type of aircraft. This is a particular problem as the company has aircraft that were purchased from many different airlines, each with subtle differences between them. Parts supplied by stores often are not the correct ones due to these slight differences. This serves as a frequent source of frustration, necessitating schedule delays or issuing a placard for repair at a later date. Related to this problem is the lack of a backlog of critical parts. Critical parts are frequently not available when needed, leading to having an aircraft down for an extended period or necessitating expensive and time consuming rush procurements through AOG.

Tracking parts for a specific aircraft was frequently mentioned as a significant difficulty. Determining where parts are in the system (specifically in relation to items being obtained from outside the system, or in transit from somewhere) and getting the parts to the aircraft were described as common problems. In general, maintenance personnel experienced significant uncertainty regarding when, where and how parts would be delivered and spent extra time trying to get this information and to ascertain its reliability.

Significant problems in switching between the various information databases (such as Spectre, the stores database and the customer service database among others) were noted. Maintenance personnel currently need to retrieve information from multiple sources, however, the ability to readily access and gain needed information from multiple systems at the same time is quite limited. For example, booking, monitoring bills, baggage handling, and tracking items and parts are all activities that need to be conducted by aircraft-on-ground (AOG). These activities require accessing and integrating information across several databases on an almost continual basis in order to keep up-to-date with the current situation. This situation also leads to redundant tasks between paperwork, manuals and the computer systems. Maintenance personnel expressed a need for an integrated computerized database system, allowing for more efficient monitoring of activities and parts and facilitating getting the part to the aircraft in a more expeditious fashion. Other needs expressed included a ready list of "hot" parts and items, a means of tracking **MELs** better and a database on parts reliability. The Spectre database in particular was considered a significant barrier or problem. Personnel expressed considerable frustration with the system as it made data entry very difficult and the user interface was very clumsy. This system needs significant revisions to provide pertinent information in a usable format.

Organizational issues were also mentioned. In particular the feeling was expressed that management was not providing visible and active support, particularly in regard to feedback on how personnel were doing, improvements that could be made, and guidance on which direction personnel should go in and why. Maintenance personnel expressed a desire for better feedback or rewards when they make progress in the right direction.

Maintenance personnel also expressed a certain degree of frustration regarding other organizations. Many felt that other groups did not really understand what they did. For example,



the maintenance technicians did not like having maintenance operations control (MOC) tell them what to do, when "they are not out here working in the cold and the dark". On the other hand, MOC personnel felt they were misunderstood as they all had worked in the technician's job before. They also felt they had the best information to be able to ascertain the impact of a given problem on changes in the system (e.g., scheduling). The technicians, though, did not have this "big picture." The end result of these types of differences is misunderstandings between organizations, and inefficiencies in problem solving as neither group has the full picture and the same information possessed by the other group.

Several interpersonal issues were mentioned. While most personnel were considered to be "team players," others were considered to be deficient by not pitching in to help complete tasks. Problems with information not being transferred between team members both during a shift and between shifts were cited. Related to this, personnel conflicts were listed as a problem. The instability of the organization was also a significant concern. Just prior to the time period of this study, there were many reorganizations, changes in management, layoffs, and reassignments/relocation of many of the personnel.

Other problems mentioned included fatigue and problems associated with shiftwork (particularly among graveyard shift workers), concerns over organizational down sizing, lack of updating of the stores computer system to reflect the nuances of particular aircraft, need for more training on Spectre, a lag in updating workcards to reflect changes in work procedures, and poor housekeeping and maintenance of tools.

People expressed the desire to be able to solve problems locally if only they had the information they needed. For example a particular problem may be placarded and passed on to another station, when it could be fixed locally if information on scheduling and parts availability was shared better. People at the local level wanted to be involved more in the decision making process in order to help meet the organizational goal of having the aircraft back in service as soon as possible. Related to this, personnel also expressed a desire for more proactive problem solving instead of waiting until a crisis situation develops. They felt they needed to get information sooner and to obtain earlier involvement of the respective parties in the problem solving process.

The need also was expressed for streamlining the processes used for obtaining engineering authorizations, and for developing consistent procedures that everyone could follow for borrowing and obtaining parts. Due to a lack of consistent procedures, a lot of time and effort may go into one particular method for getting a part and then when that method falls through the process must be started over again. Procedures that incorporate alternate parallel tracks and action plans when parts are needed are felt to be needed.

Difficulty with contract suppliers was expressed. The feeling was that contract suppliers need to be given clearer expectations regarding what they are to deliver and quality requirements. Clearer procedures and processes need to be conveyed to them, particularly in light of significant culture and time zone differences.

Finally, the low experience levels of some personnel were described as a problem. Due to a number of layoffs, people with high seniority, but perhaps low experience levels in a particular job type are more common. This has a significant impact on scheduling the technicians on

particular tasks and teams. With the perceived pressure to save money and do more with less, this issue was felt to have an impact on performance as individuals might not be able to work with fellow team members as much as might be needed.

<b>Table 4.26 Barriers to Performance</b>	
<b>Barrier</b>	<b>Frequency</b>
Lack of tooling; out-sourcing of parts	13
Parts availability; determining status of parts	10
No backlog of critical parts	10
Non-integrated databases; redundancy of tasks; hard to find needed information	10
Tracking the parts; getting the parts to the aircraft	8
Computerized Database: Spectre	8
Lack of support and feedback from management	8
Other organizations don't understand what we do, problems we face	8
Lack of teamwork; information being passed among & between team members	7
Personality conflicts	7
Instability of organization	7
Downsizing of organization	6
Shiftwork; fatigue	6
Computer system in stores	5
Workcards; changing of procedures with aircraft	5
Need for better information and communication to solve problems locally	5
Streamline engineering authorizations	4
Poor housekeeping and maintenance of tools	4
Computer system for customer service	3

Need more training on using Spectre	3
Need for more proactive procedures	3
Need to develop consistent procedures for obtaining/borrowing parts	3
Need more explicit requirements for contract suppliers	3
Low experience levels of some personnel due to lay-offs and job changes	2

## 4.5 DISCUSSION

Based on the analysis of the SA requirements and resources for each organization (**Sections 4.4.2 through 4.4.4**) and the barriers and problems expressed (**Section 4.4.5**) several observations can be made pertinent to team SA in the aircraft maintenance domain. The largest problem for team SA exists when gaps are present between organizations or individuals. These gaps may be the result of mismatched goals, lack of needed information on the part of one or both parties, lack of understanding of the exact information that another group needs, or different interpretations of information that is passed from another group.

Maintenance technicians face several challenges to meeting their SA requirements that can be linked to team SA. First, technicians spend a great deal of their time and resources in ascertaining whether they have the correct parts or when and how they will get the correct parts (**A&P technician subgoal 1.1.1.1**). A considerable gap exists between the technicians and the stores organization who often may supply the incorrect part (due to difficulties with effectively number differences between different aircraft models, for instance) or may not have the correct part due to stocking limitations. These situations increase both the probability of error (incorrectly installing the wrong but very similar part) and may lead to considerable inefficiencies, waste and delays. When parts are not available, the technicians frequently must involve their leads and supervisors, maintenance control and aircraft-on-ground to achieve this subgoal. This necessitates the involvement of several organizations and personnel, all of whom need to be brought up to speed on pertinent situational information to make good decisions. This process is time consuming and may be prone to miscommunication errors, leading to SA problems.

The process of placarding also poses a significant problem (**A&P technician subgoal 1.1.1.2**). Technicians may spend a considerable amount of time disassembling a system and trouble-shooting to arrive at a diagnosis, only to find they cannot fix the problem due to an unavailability of parts or schedule constraints. This is a process which is fairly inefficient and which they find very frustrating due to lack of closure in addressing the very problems they are trained to fix. Completing repairs is a factor from which they derive their major job satisfaction. Technicians get very discouraged when they are not allowed to fix things that clearly need fixing. It is also a waste of time and human resources to have to reassemble a subsystem and placard it so that it can be unassembled again and fixed later on at another maintenance station.

Although sometimes placarding is unavoidable, it is generally best if problems can be fixed immediately. The system does not appear to be currently optimized to avoid placarding, however. A review of the goals of other organizations, such as maintenance control and its sub-organizations, reveals that they place far more emphasis on remedying existing placards than avoiding new ones. This goal mis-match may be at the heart of considerable misunderstandings between groups.

While technicians report a need to ascertain job status and schedule progress (**A&P technician subgoal 1.1.2**), they currently get only limited information concerning these issues. While they supply information regarding progress on their own tasks up the line on an ongoing basis, leads and supervisors frequently provide little information back down the line over the course of a shift. Leads reportedly did not feel that technicians really needed information on how the other team members were doing in terms of progress on their respective tasks. Without this knowledge, the technicians have no way to engage in compensatory activities (for example, pitching in to help each other), and may not be aware of ongoing activities of other team members that may have an effect on their own tasks (or vice-versa). In some cases, tasks must be done in a certain order. In other cases, certain tasks can affect the activities of other technicians in a way that creates a safety hazard unless both parties take precautionary measures. Thus, a lack of up-to-date knowledge on within team progress contributes to SA gaps within the maintenance team.

Although regulations are very specific regarding the criteria specifying when an item must be repaired or replaced, discretion is available in allowing technicians to repair or replace items that might be nearing the acceptable limit. It may be both safer and more time and cost effective to promote this type of action in some circumstances (e.g., if a given subsystem already is disassembled for other work and the part is available). Discretion is also available on items that are placardable: they can be fixed immediately or placarded and sent to another station for later repair. Better sharing of information is needed in regard to these issues so that technicians, leads and supervisors can make decisions that are in line with defined organizational priorities and realities. (For example, they may need the information that a given aircraft will only be going to other stations that are not well equipped to fix the particular type of problem or that are overloaded.) Personnel need to understand what current organizational priorities are and why. A shared understanding of the cost and benefit tradeoffs in fixing things on the spot versus delaying repairs would allow them to form a better understanding of situations they encounter and make better decisions.

In reviewing the SA requirements and resources of the maintenance leads and supervisors, it is apparent that they serve largely in the role of coordinators and can become information "middle-men." In addition to administrative duties, they become involved when problems arise and assistance is needed, providing support themselves or interacting with other organizations (e.g., maintenance control or AOG) to get needed support. This role is very critical in the process of achieving good SA at the team level. When they become involved, supervisors and leads need to get a considerable amount of situational information from the technicians or from others who may be in geographically distributed locations. This process can be highly prone to information falling through the cracks or can result in individuals not forming a full understanding of a situation. If supervisors do not have a complete understanding of all pertinent information, for

instance, they may not pass information on that will allow maintenance control to make the best decision. In addition, leads and supervisors are frequently responsible for passing information back to the technician. If they only pass information regarding what the technician should do (the decision) but not regarding why the decision was made, this may lead to both a lack of understanding by the technician and may deny the technician the opportunity to volunteer information he or she may have that would be pertinent to the decision being made. Leads and supervisors form a critical link in the SA chain between the various organizations and need to have a full understanding of what information other people really need and of how to get all the information they need themselves.

Stores (material services) appears to work primarily based on planned demands in order to obtain needed parts in advance. Some stores personnel, however, reportedly do not understand the unique differences between aircraft models and tail numbers that allow them to procure parts with the proper effectivity number. (This problem appears to be at least partially due to problems in documentation and the databases provided to them.) This situation leads to considerable problems with technicians who complain of not having the correct parts. The lack of availability of needed parts has been identified as one of the most critical factors in determining whether an aircraft will be repaired or not. There also exist problems in keeping up with the status of the inventory when there are numerous people who have access to parts and may not keep databases up-to-date. The greatest SA need for this group is in determining methods to insure that they have correct information on needed parts and to provide them with a better ability to project parts requirements (Level 3 SA). While they do work with projections from planning and with typical part usage requirements, their ability to project requirements for parts could probably be enhanced through better system feedback and advanced planning.

Maintenance control (MC) and its sub-groups appear to function largely in a trouble shooting, reactive mode. They become involved when help is needed and primarily focus on expediting problem solution by bringing resources (parts, expertise, routing) to bear on identified problems. They face several challenges in this role. Maintenance control has a great deal of general system knowledge, both in terms of technical skill and documentation, at its disposal. Technicians in the field have the best situation knowledge, however, as they are on-site with the aircraft and have the most contact with pertinent aircraft data. The challenge is to combine these two sources of information most effectively to arrive at proper diagnoses and solutions. This gap between those with situation information and those with the best technical knowledge may be reduced with improved understanding between the two groups or from technologies that assist in the sharing of information between the two groups.

Although the stated goal of maintenance operations control (MOC) is to minimize placards, it should be noted that it primarily focuses on making sure existing placards do not exceed prescribed time limits. The process seems to be to first approve placards (if allowable) and then to work to remove them. Neither MOC nor MC appear to focus on proactive tasks to avoid placards in the first place. This state of affairs also appears to form a gap between these organizations and the technicians in the field. It may be that some organizational streamlining between MOC and MC may also be of benefit, reducing the need to have distributed decision making in meeting their shared goal.

In reviewing the SA resources used by each group, several general comments can also be made.

It appears that the technicians interact mostly with other team members on site. Moving up in the organization, leads and supervisors are far more likely to interact with other groups (such as planning, stores, and maintenance control) and with maintenance units at other stations, as are the support organizations. These groups have an increased need to understand the other groups with which they interact. For example, understanding the differences between maintenance sites (manpower availability and skill levels, load levels, parts and equipment availability) may be very important in allowing personnel to develop a good understanding of the impact of decisions or to understand why other organizations are making certain statements. These issues are very important to effective decision making, particularly when organizations are geographically distributed and such differences may not be evident. Each maintenance site also needs to be able to share relevant information (e.g., problems detected with certain aircraft or parts) across sites in order to allow the whole organization to achieve the highest knowledge level possible. Across the organization, members of each group need to develop an understanding of what information is needed by other groups and how to clearly pass on needed information about their own situations.

## 4.6 TRAINING RECOMMENDATIONS

Several training concepts should be explored for improving Team SA within the maintenance setting based on this analysis and discussion, in addition to the technology enhancements that were recommended in **Section 4.4.4**.

(1) Shared mental models - From the analysis it was determined that different teams (organizations) do not have a good mental model of what other teams know, do not know, or need to know. Good situation awareness at the team level depends on having a clear understanding of what information means when it is conveyed across team members. Thus teams need to share not only data, but also higher levels of SA, including the significance of data for team goals and projection information. This process is enhanced greatly by the creation of a shared mental model that provides a common frame of reference for team member actions and allows team members to predict each other's behaviors. A shared mental model may provide more efficient communications by providing a common means of interpreting and predicting actions based on limited information, and therefore may form a crucial foundation for effective teamwork. When shared mental models are not present, one team may not fully understand the implications of information transmitted from another team and misunderstandings, errors and inefficiencies are likely to occur. By providing each team with better information on the goals of other teams, how they perform their tasks, and what factors they take into account in their decision processes, a better shared model can be developed. This should greatly enhance not only interpersonal interactions among teams, but also the quality of the decision processes.

(2) Verbalization of decisions - There also exists a need for teams to do a better job of passing information to other teams regarding why they decide to (or not to) take a particular course of action (e.g., deferments, schedules, etc.). Unless the rationale and reasons are passed along, considerable misunderstandings may occur. In addition, this will deny the possibility of getting better information from the other team, who may have access to other pertinent information that would make for a more optimal solution. Conveying why a particular decision was made

provides a much greater level of SA (particularly at the comprehension level). It allows other teams to either understand and accept the decision or to offer other solutions that may be better in achieving organizational goals. More information also needs to be conveyed on what diagnostic activities have been performed when passing aircraft to another station, and a need exists for better communications between stations and teams in general. Training that focuses on teaching people to verbalize the rationale behind decisions and provide greater detail regarding diagnostic activities should help improve Team SA considerably.

(3) Better shift meetings and teamwork - Team leads need to receive explicit training on how to (1) run a shift meeting to convey common goals for the team, (2) provide a common group understanding of who is doing what, (3) set-up an understanding of the inter-relationship between tasks and personnel activities and (4) provide expectations regarding teamwork. Shift meetings provide an excellent opportunity to provide this shared understanding among the members of a team. This information is crucial for allowing team members to have a good mental model regarding what everyone is doing and how tasks inter-relate so that they can have good SA regarding the impact of their actions and tasks on other personnel and on the overall goal. Team leads also need to receive specific training on the importance of passing information on job status within teams over the course of the shift. Without this type of feedback, people can easily lose sight of how they are progressing in relation to the other tasks being performed. This feedback is important for individual performance and SA, and also for fostering a team spirit in carrying out activities.

(4) Feedback - Currently, personnel receive little feedback on how well a particular solution worked. A tricky diagnosis and repair may have been totally successful, or may have failed again a few days later at another station. At present, it is very difficult to track the performance of a particular action or part (partially due to the cumbersome nature of the computer system). Such feedback is crucial to the development of better mental models of the technical systems on which technicians work. Without such feedback, it is very difficult to improve one's diagnostic skills. While system enhancements are recommended to help with this problem, it is also recommended that people be trained to provide such feedback. Not only do managers and leads need to take an active role in providing this feedback, but technicians (and others) can also be trained to provide more feedback (either over the phone or through the computer system) on what worked and what didn't.

(5) SA training - Common problems can be linked to SA failures in a number of systems, including (1) forgetting information or steps, frequently in association with task interruptions, (2) not passing information between shifts or team members, (3) missing critical information due to other task related distractions, and (4) misinterpreting information due to expectations. Training can be used to provide heightened awareness of these problems and ways of combating them. For instance, task interruptions are a common problem leading to SA errors. Frequently such interruptions lead to skipping steps or missing activities. Personnel can be trained to take particular measures following a task interruption (double check previous work performed, double check area for loose tools, etc.). This type of training may be useful for helping maintenance personnel to insure that they are not missing critical information in the performance of their tasks.

Results from the SA requirements analysis conducted here provide a firm foundation for



identifying the knowledge, skills, and abilities (KSA) that maintenance personnel need to attain a high level of SA. The SA requirements identified in **Section 4.2** provide information on the specific knowledge that maintenance personnel need to achieve a high level of SA for completing their tasks. Providing personnel with knowledge is not enough, however. Maintenance personnel must also have the skills and abilities required to effectively communicate that knowledge, and need the ability to recognize which information needs to be exchanged among and between team members. Several gaps between teams were discussed in **Section 4.5**. To address these gaps, the training concepts proposed here may be useful as a means of enhancing the skills and abilities needed for achieving a high level of SA in a team environment. This information will be used to develop the proposed training concepts into deliverable training programs in future efforts.

## 4.7 CONCLUSIONS

Overall, the applicability of the concept and importance of situation awareness in maintenance teams has been supported in this analysis. Teams of technicians are supported by many other personnel and organizational units to achieve their goals, each of which has a major impact on the attainment of these goals. In this context it is necessary to examine how information flows between and among team members in order to identify system and personnel factors that will impact on the degree to which team members are able to maintain an accurate picture of an aircraft's status. This knowledge appears to be crucial to their ability to perform tasks (as each task is interdependent on other tasks being performed by other team members), their ability to make correct assessments (e.g., whether a detected problem should be fixed now or later (placarded)), and their ability to correctly project into the future to make good decisions (e.g., time required to perform task, availability of parts, etc.).

In addition to specifying the role of SA in an aircraft maintenance environment, an assessment was made of systems and technologies used to support SA in this organization, and potential areas for improvement identified. In addition, concepts for improving SA among and between team members through training were identified. It is recommended that these concepts be prototyped and tested to determine whether team SA can be improved through the methods identified and organizational effectiveness thus enhanced.

## 4.8 REFERENCES

- Drury, C. (1993) Chapter eight: Training for visual inspection of aircraft structures. In G. S. Corporation (Eds.), *Human Factors in Aviation Maintenance - Phase Three, Volume 1 Progress Report (DOT/FAA/AM-93/15)* (pp. 133-154). Washington, DC: Office of Aviation Medicine, Federal Aviation Administration.
- Endsley, M. R. (1988). Design and evaluation for situation awareness enhancement. In *Proceedings of the Human Factors Society 32nd Annual Meeting* (pp. 97-101). Santa

Monica, CA: Human Factors Society.

Endsley, M. R. (1989a). *Final report: Situation awareness in an advanced strategic mission* (NOR DOC 89-32). Hawthorne, CA: Northrop Corporation.

Endsley, M. R. (1989b). Pilot situation awareness: The challenge for the training community. In *Proceedings of the Interservice/Industry Training Systems Conference (IITSC)* (pp. 111-117). Ft Worth, TX: American Defense Preparedness Association.

Endsley, M. R. (1993). A survey of situation awareness requirements in air-to-air combat fighters. *International Journal of Aviation Psychology*, 3(2), 157-168.

Endsley, M. R. (1994). Situation awareness in dynamic human decision making: Theory. In R. D. Gilson, D. J. Garland, & J. M. Koonce (Eds.), *Situational Awareness in Complex Systems* (pp. 27-58). Daytona Beach, FL: Embry-Riddle Aeronautical University Press.

Endsley, M. R. (1995). A taxonomy of situation awareness errors. In R. Fuller, N. Johnston, & N. McDonald (Eds.), *Human Factors in Aviation Operations* (pp. 287-292). Aldershot, England: Avebury Aviation, Ashgate Publishing Ltd.

Endsley, M. R., & Rodgers, M. D. (1994). *Situation awareness information requirements for en route air traffic control* (DOT/FAA/AM-94/27). Washington, DC: Federal Aviation Administration Office of Aviation Medicine.

Marx, D. A., & Graeber, R. C. (1994). Human error in aircraft maintenance. In N. Johnston, N. McDonald, & R. Fuller (Eds.), *Aviation Psychology in Practice* (pp. 87-104). Aldershot, UK: Avebury.

National Transportation Safety Board (1984). *Aircraft Accidents Report, Eastern Air Lines, Inc., L-1011, Miami, Florida, May 5, 1983*. Washington, DC: Author.

Robertson, M. M., & Endsley, M. R. (1995). The role of crew resource management (CRM) in achieving situation awareness in aviation settings. In R. Fuller, N. Johnston, & N. McDonald (Eds.), *Human Factors in Aviation Operations* (pp. 281-286). Aldershot, England: Avebury Aviation, Ashgate Publishing Ltd.

Robertson, M. M., & O'Neill, M. J. (1994). *Development of contextual inquires for examining knowledge workers in technological office environments*. Zeeland, MI: Herman Miller, Inc.

Ruffner, J. W. (1990). A survey of human factors methodologies and models for improving the maintainability of emerging army aviation systems. Alexandria, VA: US Army Research Institute for the Behavioral and Social Sciences.

Salas, E., Dickinson, T. L., Converse, S., & Tannenbaum, S. I. (1992). Toward an understanding of team performance and training. In R. W. Swezey & E. Salas (Eds.), *Teams: their training and performance* (pp. 3-29). Norwood, NJ: Ablex.

Taylor, J. C., Robertson, M. M., Peck, R., & Stelly, J. W. (1993). Validating the impact of maintenance CRM training. In R. S. Jensen & D. Neumeister (Ed.), *Proceedings of the Seventh International Symposium on Aviation Psychology* (pp. 538-542). Columbus, OH: Department of Aviation, The Ohio State University.

# CHAPTER 5

## JOB AIDING

*Ed Crowther and Michael Merriken  
Information Division, Galaxy Scientific Corporation*

### 5.1 INTRODUCTION

Human-centered job-aids can greatly impact the performance of maintenance and inspection personnel as well as aviation safety inspectors. Our experiences with the Performance Enhancement System (PENS) project would be very useful to the aviation industry. Three separate projects were conducted that used various PENS-related job aiding concepts. In one project, we developed a job aid to support the audit conducted by the Coordinating Agency for Supplier Evaluation (CASE). The second project developed a job aid that incorporated the AFS Job Task Analyses (JTA), which are paper-based sets of information that comprise the steps and resources required by the aviation safety inspector (ASI) to perform inspection activities. These JTAs were used to develop a computer based job aid prototype (Inspector's Task Book) to support the ASIs. Finally, we created a prototype job-aid for the Civil Aeromedical Institute (CAMI) to collect and distribute data on alcohol and drug test results. This report outlines all these activities. A pen-computer based application was also developed in the research program in partnership with United Airlines. That project has been reported in **Chapter 6**.

### 5.2 THE CASE JOB-AID: TRANSITION OF PENS CONCEPTS TO INDUSTRY

The success of the Performance Enhancement System (PENS) has brought the aviation industry's attention to the possibilities of supporting mobile maintenance technicians and auditors with portable computing technology. During the last year we have worked with a partner airline to field and evaluate a prototype job aid, and then transition that prototype to an operational system. The following is a description of the features of the job aid and the results of the field evaluation.

#### 5.2.1 Airline Partner's Needs

Our partner airline has a group of Vendor Surveillance Analysts within its Technical Standards office. They use a variety of forms to document the results of their quality assurance audits. Also, they have standards that support the criteria of their audits. These standards are based in-part upon Federal regulations (Federal Aviation Regulations, Airworthiness Directives, etc.). The Vendor Surveillance group is responsible for auditing companies who supply materials and

services to the airline. They ensure that those companies are in compliance with Federal guidelines and with industry standards. Our partner airline is a member of the Coordinating Agency for Supplier Evaluations (CASE). The CASE organization is a consortium of airlines that pool their resources and share audit data. If a CASE member, e.g., our partner airline, evaluates a supplier and certifies that the supplier is in compliance with Federal regulations and CASE standards, then other CASE members know that they can use the supplier without having to perform their own audit. CASE provides auditing forms and standards to its members. There are currently six CASE forms, although this number changes as new forms are added and old forms are retired.

The partner airline also has a group of Compliance Auditors who focus their investigations upon company maintenance bases. This group uses the same types of mechanisms (i.e., checklists and standards) in performing their duties. The Compliance Auditor group is responsible for ensuring that our partner airline's maintenance operations are in compliance with Federal guidelines and with its own standards. The Compliance Auditors use approximately 32 forms.

Based on our discussions with the partner airline, it was evident that both audit tasks have data collection and documentation reference requirements that could be addressed by the technologies employed in the Performance Enhancement System research.

## 5.2.2 Software Prototype

Two prototype job aids were developed - one for Vendor Surveillance Analysts (CASE Job Aid) and one to support the Compliance Auditors. These prototypes were developed for use on pen computers. It was hypothesized that pen computers would provide the auditors an ease of use similar to that of the clipboards they normally use. Data collected with the job aids are stored in databases and can be printed out in standard report formats or exported to Microsoft Word. This is a vast improvement over the current method of manual transcription of handwritten paper forms. The reduction in paper work realized from use of the job aid results in considerable time savings.

For the CASE job aid, we developed an application that contains four of the forms Vendor Surveillance Analysts use most frequently. The forms are separated because a vendor will normally provide just one type of the supplies or services that the auditors are responsible for reviewing. An example is shown in **Figure 5.1**. The application allows an inspector to identify whether a vendor is in compliance and to make a comment for each item on the form, as shown in **Figure 5.2**.

**Figure 5.1 Form to Collect Audit Data**

CASE - [CASE Air Carrier Section - Component Repair/Overhaul Vendor (Part A)]

Form Window Table of Contents General Comment Help

CACS-20

Page 1  
Page 2  
Page 3  
Page 4  
Page 5  
Page 6  
Page 7  
Page 8

1. CERTIFICATION (continued)

B. Record certificate number.

C. Obtain a copy of certificate and limitations.

D. Is the certificate displayed unobscured in an area accessible to the public? [1L]  YES  NO  N/A

Comment

2. ANTI-DRUG TESTING PLAN [1M]

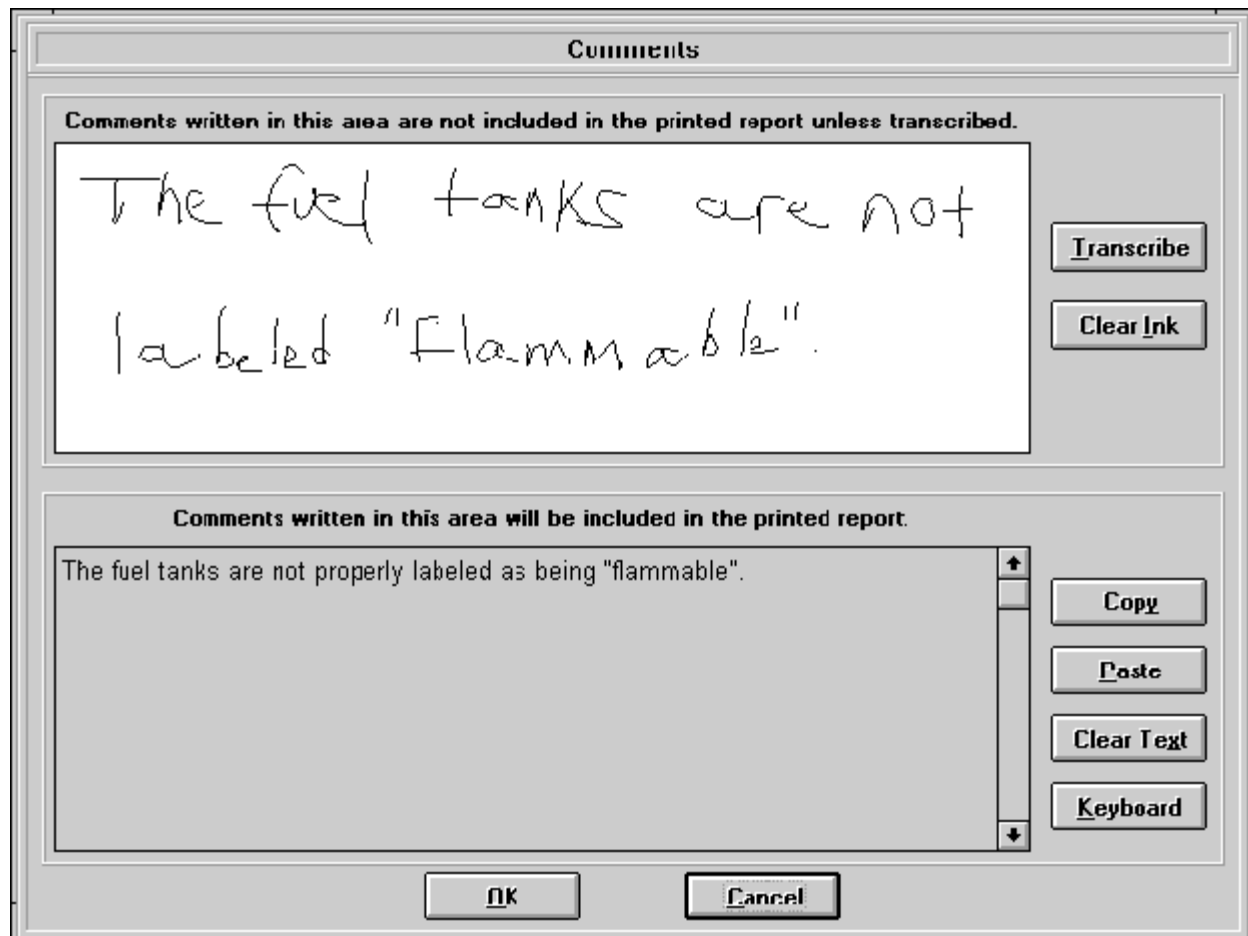
A. Does the ROV have an FAA approved anti-drug plan?  YES  NO  N/A

Comment

B. Record plan number.

C. The plan is:  A Vendor's  A Consortium's  An Air Carrier's

Figure 5.2 Dialog Box to Make Comments on Each Form

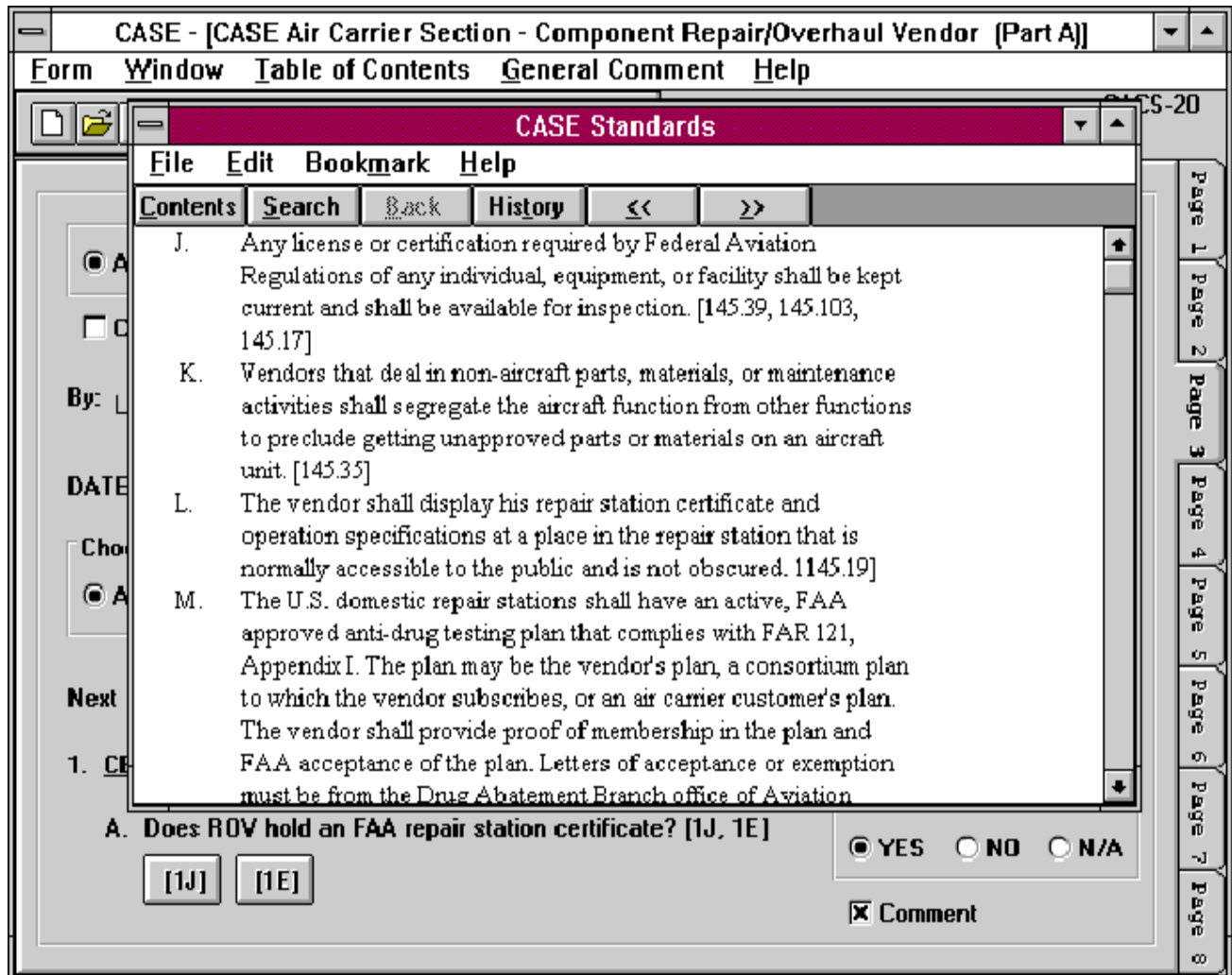


The application also contains links to the CASE standards appropriate to the questions on the auditing forms. This allows an auditor to access the standards for reference while performing an audit. As shown in **Figure 5.1** there is a button next to a surveillance item ("Does the ROV have an FAA approved anti-drug plan?") that identifies the standard. When an auditor clicks on the button, the standard appears in Windows Help, as shown in **Figure 5.3**. Auditors liked this capability because they could read the standard and because they could copy and paste it into their reports. Whereas their reports previously contained the auditor's recollection of the standard, they now contain the standard's exact wording.

We developed a similar application for the Compliance Auditors. Unlike the Vendor Surveillance application, forms are saved in "sessions" (i.e., all forms used in a given audit are saved together). This difference in design results from the fact that a given maintenance facility of our partner airline normally performs several different types of maintenance and requires multiple forms. Because the content of the forms is proprietary to our partner airline, we cannot publish examples. However, the format and content are very similar to the Vendor Surveillance forms.

**Figure 5.3 The Case Standard is Displayed Appropriate to The Question on The Audit Form.**





### 5.2.3 Evaluation

Both prototype systems were fielded for evaluation with auditors from the partner airline. Pen computers loaded with the job aid software were provided to the auditors for use during field inspections. The software also was loaded on the auditor's desktop workstations. This allowed auditors to both use the software on the road, and to familiarize themselves with it in the office. The evaluation period lasted approximately ninety days, ending in April 1995.

The Vendor Surveillance auditors (CASE audits) were very enthusiastic about the prototype audit software, and used it on several of their audits. Their favorite features were (1) the portability of the equipment, (2) the ability to record comments that become integrated into output reports, and (3) the on-line standards which can be easily accessed and copied into comments. The evaluating auditors estimated that use of the job aid reduced the total time to perform an audit by 25 - 30 %. In general, the auditors said that they saw a definite utility for this type of technology in their field.

The fielding of the Compliance Audit prototype did not go according to plan, due to scheduling

changes at the partner airline. As it turns out, our partner airline closed twenty-one of its over forty maintenance bases in the period during which the prototype was being created. As a result, there was only one Technical Standards audit scheduled during the evaluation period. The Compliance Auditors did spend some time reviewing the software, but not through any practical field use.

Evaluators indicated that the Compliance Audit prototype suffered from the lack of standards on-line. Of course, this was due to the partner airline's reluctance to let us put their proprietary information on-line. Another shortcoming identified in the prototype related to the fact that the compliance criteria and checklists change frequently. There is no mechanism in the prototype to easily modify the contents of the checklists. While a software developer could make the changes, it would be extremely difficult for an end user to do it. This makes maintenance of the software an expensive task. The evaluators indicated that they would like to have the capability to author the on-line checklists themselves.

The Vendor Surveillance auditors (CASE audit) expressed similar concerns about the inability to modify checklist contents. However, the CASE checklists and standards are fairly stable. Thus modifications would be infrequent and minor.

The only features of the software that the evaluating auditors were unhappy with were associated with pen computing technology. The transcription capabilities of the software, for converting both handwritten data and handwritten comments to typed text, were unsatisfactory to the auditors. Also, when they attach a keyboard to the computer for typing, they had difficulty in placing the mouse pointer with the pen. It switched back and forth between a handwriting and point-and-click device every time the pen was touched to the screen, impeding the process of editing a document. It was the general opinion of the auditors that a standard laptop computer *without* Pen Windows (and hence a mouse or trackball point-and-click device) would be more convenient to use.

#### **5.2.4 Development of Operational System**

Based on the results of the field evaluation, it was decided that the CASE Vendor Surveillance prototype software would be developed into an operational software system for delivery. The CASE evaluators were pleased with the prototype, and indicated that it would play a useful role in performing field audit tasks.

It was also decided that no further development would take place on the Compliance Audit prototype. Because of restrictions on the availability of standards information, and because of a limited amount of usage during the evaluation period, we determined that it would not be feasible to construct a useful operational system from this prototype.

The CASE software system was developed as a final output to this research task. The CASE system was based upon the CASE prototype software. Enhancements were made to the prototype as a result of the findings of the field evaluation. The major modification involved the dismantling of pen computing technology -- the software can now run on any laptop or desktop PC without the need for Windows for Pen Computing. Other modifications include:

- The addition of summary reporting: Summary reports are printouts of just the comments that

a user made during an audit. Such reports provide a concise description of those specific areas in which a vendor did not perform as expected.

- Additional file management utilities: Over time the number of records contained in the hard disk of the auditors portable platform can become extensive. The ability to remove outdated audit records from the database was provided with this modification.
- General comments areas: Users requested a space to put comments that did not apply to any one area on the audit checklist. The general comments area stores such comments. General comments are printed out at the end of the complete checklist report, and at the top of the summary report.
- On-line Help: This module provides standard user help information, and serves to round out the operational software system.

### 5.2.5 Presentation and Distribution of Software

The CASE software system was presented to members of the CASE consortium, at their semi-annual meeting in May 1995. The software was presented to an assembly of each of the consortium's three sections. In total the prototype was seen by approximately 120 representatives from major commercial airlines, aircraft manufacturers, and aerospace/marine repair organizations. During the presentations, extra copies of the *Human Factors Issues in Aircraft Maintenance and Inspection '95* CD-ROM were distributed to meeting attendees. The CD-ROM contains a demo program that describes the features of the CASE software.

The CASE software was well received by each audience. Many attendees expressed a desire to see a greater use of technology in their job tasks, and look forward to the release of the software as a part of the next Office of Aviation Medicine CD-ROM.

The CASE software system was released as a part of the *Human Factors Issues in Aircraft Maintenance and Inspection '96* CD-ROM. From this CD-ROM users are able to install the operational software and databases so that they can then run the program from their local hard disks.

## 5.3 CAMI JOB AID FOR COLLECTION AND DISTRIBUTION OF DATA

The Office of Aviation Medicine (AAM) recommended that the Civil Aeromedical Institute's (CAMI) Toxicology and Accident Research Laboratory would benefit from the creation of a data collection and distribution application for alcohol and drug test results. The goal was to provide improvements such as a prototype data collection, data distribution and information display application that would run on Windows PC-compatible computers. This research laboratory stores and analyzes toxicology data derived from tissue and fluid samples collected from aircraft crew members who are suspected to have been flying while intoxicated. These individuals may or may not have been involved in an aircraft accident or incident. The Flight Standards Service is responsible for collecting such data and communicating it to Civil Aeromedical Institute (CAMI)

as part of normal accident and incident investigation procedures.

The laboratory sent forms and instructions to the field offices in the Fall of 1994. To date, however, the laboratory has not received any data from the field. It was proposed that the usability of the forms issued by the laboratory could be greatly improved by implementing them in a user friendly software application. Because the forms are very simple and require data that the inspectors already collect in the course of such investigations, they were prototyped very quickly. The data collected would then be sent to the laboratory via a modem and a bulletin board system.





We developed a toxicology information and drug report job aid software that promises to provide an improved means of collecting data, data distribution, and information display for Flight Standard Service (AFS) personnel and communicating it to Civil Aeromedical Institute's Toxicology and Accident Research Laboratory.

The CAMI job aid will improve the means of collecting data by eliminating the cumbersome paper/pencil method. The data collected by AFS will be sent to the Civil Aeromedical Institute via modem and bulletin board system. The data collected is saved and displayed on electronic forms compatible with the Civil Aeromedical Institute standards. The software was developed with the assumption that the users are familiar with MS Windows.

### 5.3.1 CAMI Job Aid Prototype

The purpose of this task was to develop a working prototype that would demonstrate the ability to collect and distribute data from drugs and alcohol test results in an efficient and effective manner. The prototype followed the Microsoft GUI standards to interactively guide the users through the task and allow users to collect and distribute data properly.

In designing the prototype, it was with the understanding that it must conform to the MS Windows GUI standard and be able to add any features to assure that both novice and expert users can use the software with minimal assistance and training.

The CAMI job aid is a single stand-alone application. It is a multiple-document interface (MDI) application and contains a main window (**Figure 5.4**). The main window contains a menu bar, tool bar, and status bar. The menu functions correspond to the tool bar functions. The user can either select File-Create New Report or click the New Report button  to create a new report, or File-Open Existing Report or click Existing Report button  to open an existing report. The same applies for printing  and saving . Clicking on the new button brings up the Report Information requesting Inspector ID, date of report, and report ID (**Figure 5.5**). When all the information is completed, clicking the OK button brings up the Accident/Incident Report form (**Figure 5.6**). Data is collected by entering it in the Accident/Incident Report form. When all data are filled in, clicking the save button on the toolbar will save the current information to the database. If users want to work with data that has been collected previously, they may select the Existing Report button or from the menu select File-Open Existing Report which will pop up an Existing Report dialog (**Figure 5.7**).

Double-clicking on a particular report will bring up the Accident/Incident Report form with data that has been saved. If any changes are made to the form, the user will be notified that data have been changed and asked to save them.

The print function button on the toolbar applies to the printing of Accident/Incident Report form only. Users may print the current form or formatted text from the menu.

### **5.3.2 CAMI Job Aid: Strengths and Weaknesses**

This section describes the strengths and weaknesses of the CAMI job aid as well as description of possible future enhancements.

#### **CAMI Job Aid Strengths**

This prototype demonstrates features that make data collecting and retrieving an easy job for inspectors. The CAMI job aid was developed with the look and feel of a standard Windows word processor to make using the software easy for novice as well as expert users. By conforming the Windows standard, we are optimistic that the CAMI job aid will be received well.

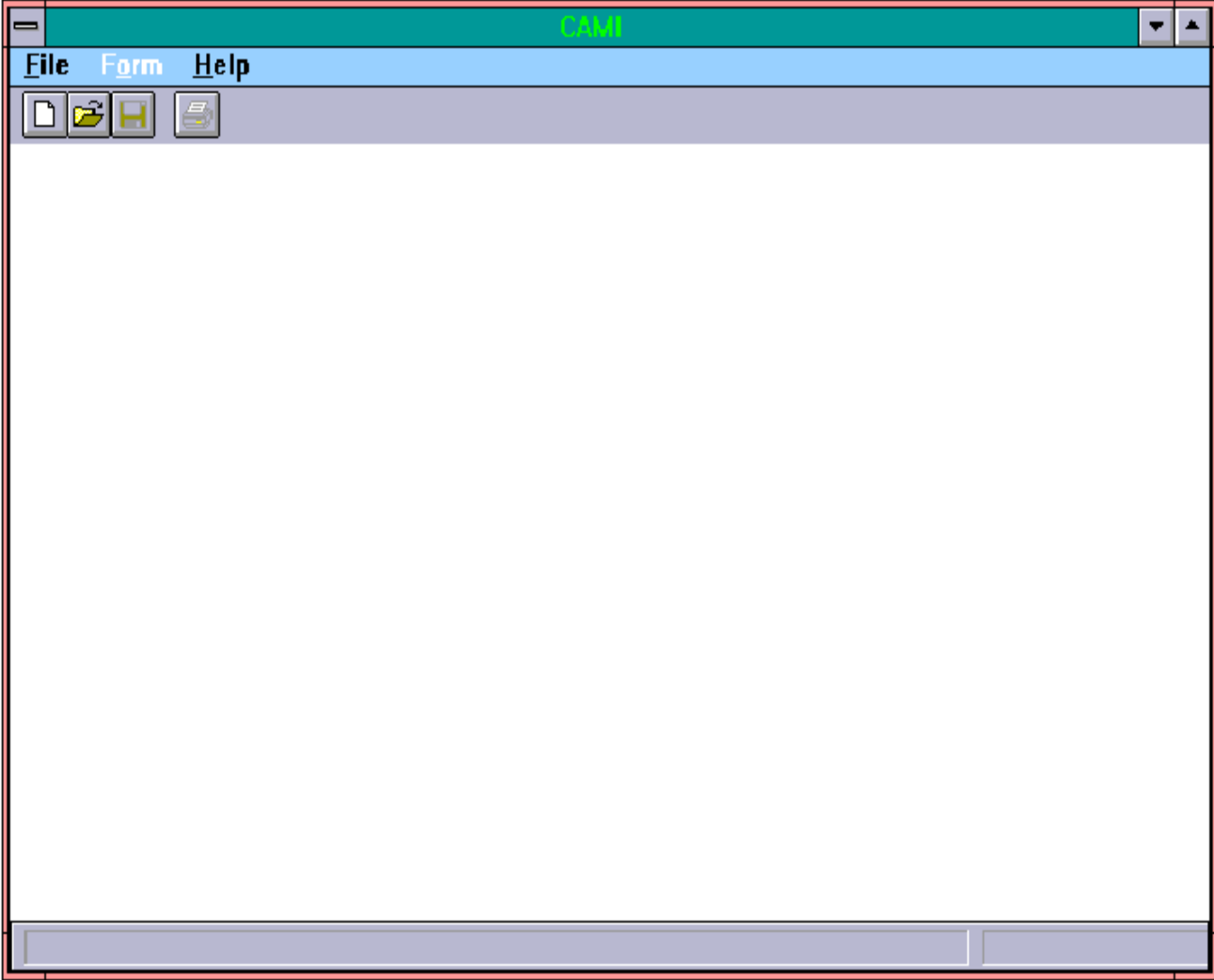
The data collected by CAMI will reside in one location and can be accessed via not only CAMI software itself, but also by other tools such as MS Access as a means of getting to the data.

#### **CAMI Job Aid Weaknesses**

Due to the short development time, this prototype only shows some of the features that enhance the way data are collected and distributed electronically. The noticeable feature that CAMI job aid lacks is the inability to delete an existing record from the database.

Another weakness is the lack of on-line help that can be resolved with additional development and support resources.

**Figure 5.4 Main Window for CAMI Job Aid**



**Figure 5.5 Report Information**

**Report Information**

Inspector ID: JAC

Date of Report: 8/27/95

Record ID: 1024

Ok Cancel

Figure 5.6 Accident/Incident Report form

**Incident and Sample Information** | **Drug(s) Identified**

Please complete as much information about the accident or incident as possible

**Accident/Incident Information**

Time of Accident/Incident  
 0600-1159  1200-1759  
 1800-2359  2400-0599

Date of Accident/Incident

Fire  
 Yes  No  
 Unknown

**Location of Accident/Incident**

1111

Location City or County State

**Sample Information**

Sample from Fatality  Putrefied Sample

Date Specimen Received

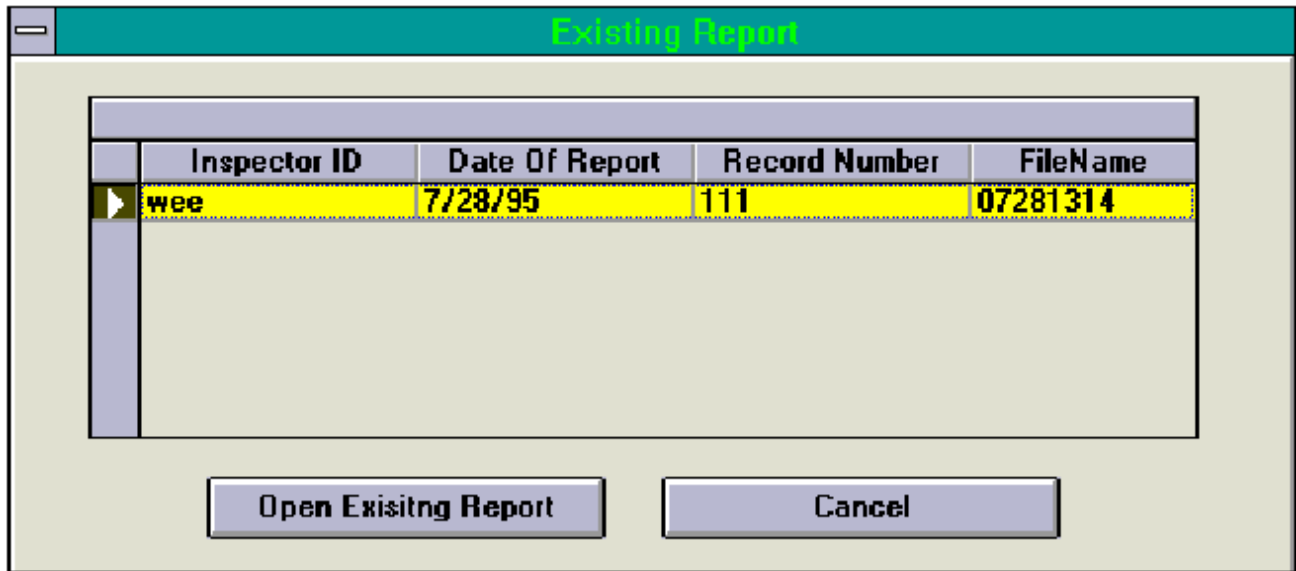
Aircraft Type >>

**Airman**

Last Name First Name M.I. Date of Birth Airman Status

Figure 5.7 Existing Report Information





### Possible Future Features

Additional forms may be added to the existing software if and when needed. It would be advantageous to automate the process of upload/download of CAMI data.

## 5.4 JOB TASK ANALYSIS: INSPECTOR'S TASK BOOK

The Job Task Analyses (JTAs) hold the promise of providing a great deal of assistance to inspectors who must perform activities infrequently. The JTAs list all of the resources and steps required for an AFS Aviation Safety Inspector (ASI) to perform a variety of inspection and investigation activities. These JTAs would be invaluable in the field. The purpose of this task was to develop a working prototype job aid to demonstrate the capability to provide on-line display of JTA reference sheets.

This prototype job aid used the capabilities of MS Windows and the MS Windows GUI standards not only to show the task sheets on the screen, but also interactively to guide an inspector through the task and allow him to automatically access on-line documentation related to that task. We called this prototype the Inspector's Task Book (ITB).

To be included in the Inspector's Task Book (ITB) several JTAs were converted from their paper versions so that they can be accessed in conjunction with the Performance Enhancement System (PENS) software now called the On-line Aviation Safety Inspection System (OASIS). The ITB was developed in a manner similar to Microsoft (MS) Windows Help. Thus, the JTAs in the ITB can be accessed at any time while performing an inspection. Ideally, the JTAs would also contain links to the policy guidance systems, but the commercial vendors providing policy guidance can not support such capability yet.

### 5.4.1 The Inspector's Task Book: Design Fundamentals

In designing the ITB prototype job aid for the JTA program, we developed a set of fundamental considerations which will maximize the usability and utility of the program.

Because the ITB operates in MS Windows, it must conform to all MS Windows GUI standards. This allows both veteran and novice users to learn the system with minimal training, and cooperates well with other MS Windows programs.

This program is one component of a suite of tools envisioned by Galaxy Scientific for the enhancement of FAA inspections. As such, the ITB was built to dovetail with other tools in the OASIS suite, primarily the Inspector's Field Kit (IFK). The IFK provides access to all the forms for an inspection activity.

The ITB provides quick, context-sensitive access to the IFK. This allows the user to switch to the inspection activity suggested by the current job task analysis. Likewise, the IFK provides a path back to the ITB, such that the current inspection activity may be viewed in light of the appropriate job task.

Also, since these two utilities together provide a solid, structured approach to aviation inspections, they must coexist in the MS Windows environment in a way that allows the user to switch back and forth between the two. The ITB was designed to be small enough to be seen on the screen along with the IFK without interfering with the inspector's use of either program.

#### **5.4.2 The Inspector's Task Book: Description of the Prototype**

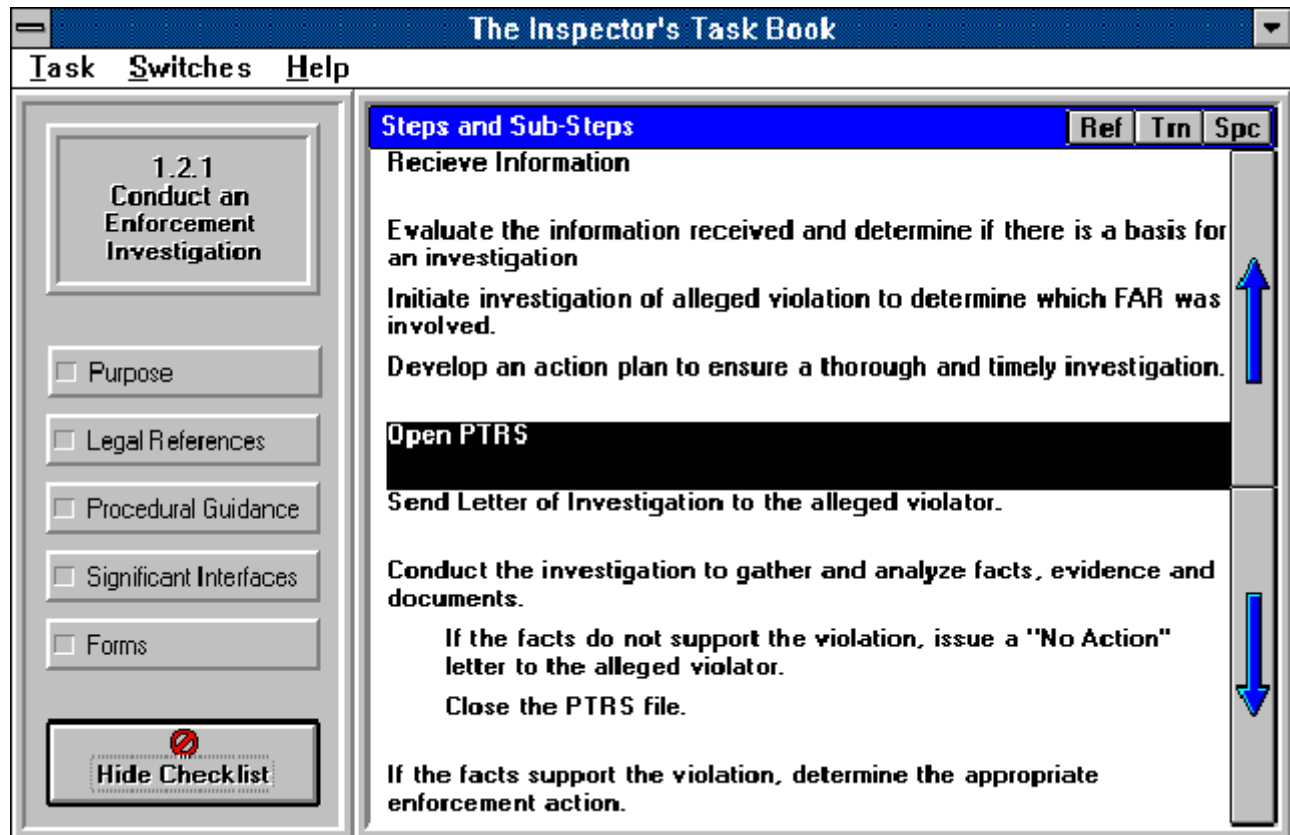
The Inspector's Task Book (ITB), in its normal configuration, is contained in a single, small window that may fit conveniently to one side of the user's screen. It contains a standard MS Windows title bar and menu bar. The body of the window contains the title of the selected job task analysis along with a series of buttons that provide detailed information about that task (*see Figure 5.8*). These buttons include those for the purpose of the task, legal references pertaining to the task, procedural guidance annotations appropriate to the task, significant interfaces encountered during the performance of the task, and forms that will be used during the execution of the task. By clicking on any of these buttons, the user will be shown the details provided in the job task analysis.

**Figure 5.8 The Main Window for the Inspector's Task Book**



To show the separate steps and sub-steps involved in the completion of the task, ITB utilizes an "expanding window". When the **Show Checklist** button is clicked, the width of the main window expands to show a list of the required steps (see [Figure 5.9](#)). By highlighting a particular step and clicking on the **Ref** (Reference), **Trn** (Training) or **Spc** (Specialization) buttons, the user will see pop-up details for the step.

**Figure 5.9 The Inspector's Task Book, with Expanded Window**



Selection of a particular job task analysis is accomplished through the **Task** menu (**Task - New**). This will display a hierarchical list of all available JTA sheets, from which the user selects the particular task to be displayed.

The inspector can switch to the IFK through the **Task** menu (**Task - Field Kit**). The program determines which activity number is suggested by the current job task, or, if multiple activities are supported, it presents the user with the list of possible activities. Once the activity is determined, the IFK will be launched, automatically beginning with that activity.

### 5.4.3 The Inspectors Task Book: Software Development

#### *Tools Used*

- **Visual Basic Pro** - Visual Basic was our language of choice for this prototype. It allows us to quickly put together fully functional applications in a minimum amount of development time. The "Pro" version adds extra controls (e.g., Outline) to the standard list of VBX controls that come with the standard VB package.
- **VB HelpWriter** - In earlier evaluations (during the development of IFK), we found VB HelpWriter to be an easy-to-use, fully featured, WYSIWYG help creation utility. It also supports automatic generation of glossaries and help contexts, through unique links to Visual Basic.

- **Paradox 3.5** - Development with the Paradox 3.5 database is one of the requirements of the IFK, due to the current widespread usage of that package among existing FAA systems. We chose to use this database in the development of the ITB in an effort to avoid incompatibilities with other PENS utilities.

### **Tools Not Used**

- **TrueGrid Pro** - In order to implement the steps and sub-steps as a checklist, we purchased and evaluated a checklist VBX called TrueGrid Pro. This third-party control is a full-featured checklist add-on. It was selected for its ability to use buttons, drop-down lists, and other controls within the grid. We discovered, however, that its wide range of functionality also created a poor development interface, in that the control of its features is difficult. Instead, we decided to implement the steps list using the standard Visual Basic controls.

## **5.4.4 Inspectors Task Book: Strengths And Weaknesses**

This section explores some of the strengths and weaknesses of the ITB prototype, as well as a description of possible future enhancements to the program.

### **ITB Strengths**

This prototype demonstrates some of the features that will make it an indispensable tool for guiding users through an inspection task. The implementation as a Microsoft MS Windows program and the adherence to MS Windows standards allow the ITB to take advantage of facilities inherent to the MS Windows operating system. MS Windows has proven itself to be a user-friendly environment, allowing experienced users to switch from one program to another without a significant learning curve, and allowing beginning users to quickly learn the program through intuitive actions. This implementation also allows possible connections to built-in resources such as printing and communications.

Another strength is the ITB's compactness. The presentation of the window as a small, stay-on-top window with buttons to activate only the required information, allows it to show as much information in as small and unobtrusive manner as possible.

One of the greatest strengths is the way in which the ITB interacts with other tools in the PENS applications, most notably with the Inspector's Field Kit. By building inspection tools which interact with each other and which share information, Galaxy Scientific is creating a computerized environment which will ultimately aid in all aspects of the process of aviation inspection.

### **ITB Weaknesses**

Due to the short development time and the availability of certain tools, this prototype can only demonstrate the basic functionality of the on-line JTA information.

Conspicuously absent are direct links to on-line documentation such as the inspector handbooks, which are referenced in each of the job task analyses. By clicking on a particular procedural

guidance annotation or legal reference for example, the user would expect to be able to view the text associated with that reference. Currently, such references are not available on-line. However, the program was developed with the software hooks for such an interface. When these documents become available, they may be easily integrated into the existing prototype.

Approximately 10 job task analyses have actually been implemented into the ITB prototype. These tasks were arbitrarily selected from available information. Before the ITB may be regarded as a truly useful program, the remaining 500+ JTAs must also be imported into the program's database. This requires a level of cooperation and coordination between Galaxy Scientific and the developers of the JTA information. This is currently being explored.

Another shortcoming of the prototype is the absence of direct form links into the IFK. Many of the job task steps and sub-steps refer directly to particular forms that must be completed in the course of a task. However, since both the IFK and the ITB have limited forms and task information completed, such a linkage is not yet possible, but will be developed as the two programs evolve.

Finally, there have been no formal tests of the ITB program. A testing effort to prove the viability of this program would necessarily include both usability studies and field testing, neither of which have been included in the initial scope of the project.

### **Possible Future Features**

In addition to addressing the aforementioned weaknesses in the program, the ITB would be enhanced by the addition of further functionality.

The ability to highlight and check off completed tasks, to add comments and to save this information will allow the inspector to keep better records of the job task. These records could be saved and recalled later for tracking purposes or to aid in future inspections.

Any information gathered in the course of performing a job should also be shared with other utilities in the PENS suite of tools. Such information sharing will be defined as the development of the series progresses.

# CHAPTER 6

## PEN COMPUTER BASED NON-ROUTINE REPAIR WRITE-UP SYSTEM

*Julie Jones, Mike Christodoulou, and Dan Thompson  
Information Division, Galaxy Scientific Corporation*

### 6.1 INTRODUCTION

In the past, the research program has investigated the use of pen computer technology for inspection and auditing tasks in cooperation with FAA Flight Standards Service (Layton, in press). This line of applied research has been well received by industry representatives as a valuable aspect of the research program. This year the research program once again teamed up with industry representatives to study other applications of pen computing technology. One of the applications was developed for the Coordinating Agency for Supplier Evaluation (CASE) and is reported in **Chapter 5** of this phase report.

This chapter describes another application developed in conjunction with personnel from United Airlines (UAL) Oakland Modification Center to use pen computer technology for the collection of non-routine repair write-up information during heavy maintenance inspections. The system design and software development were completed solely under UAL funding. However, UAL allowed the research team to conduct a pilot study using the pen computer based non-routine repair system in the Oakland facility. This report describes the UAL Pen Computer Non-Routine Write-up System, its development, the pilot study and its conclusions so that other industry personnel can benefit from this endeavor.

### 6.2 NON-ROUTINE REPAIR WRITE-UPS: CURRENT SYSTEM

Heavy maintenance checks of aircraft are scheduled to occur at regular intervals. Standard inspections are performed for each type of maintenance. For safety reasons, the FAA requires an airline to document every maintenance action that is taken on an aircraft. Standard inspections are typically documented using a routine inspection job card. However, a substantial number of maintenance actions are not covered by a routine job card. A non-routine repair write-up form is used to document such maintenance actions.

When an aircraft arrives at the maintenance facility for a heavy maintenance check, the airplane is opened up in preparation for the preliminary inspection. During preliminary inspection, the inspectors use standard job cards to assess what maintenance work is needed on this particular aircraft. During the preliminary inspection process, a number of non-routine repair write-ups are generated by the inspectors. These write-ups represent additional work that must be completed in



the scheduled time-frame of the visit.

After the inspector generates a number of write-ups, the forms are wanded into a bar coding station for transmission to a central data base. The paper forms are left in the planning center for additional processing. First, a lead mechanic processes the paper write-up, indicating what repair is to be performed. The lead also provides an estimate of the number of hours that will be needed to complete the repair. The planner/analyst uses this information to plan man-power needs. One or more mechanics will complete the non-routine repairs and sign-off the non-routine form, on the portion of the repair they have performed. When the repair is completed, the non-routine repair form is returned to the planning center. An inspector must then verify that the repair has been completed properly and sign-off on the repair. This last step is known as buy-back. Finally, there is an audit process that verifies all the paper work is accounted for and that all standard and non-routine maintenance have been completed prior to releasing the aircraft for service.

### **6.2.1 Problems Associated with the Current System**

The current paper process has been used successfully to generate and track non-routine repairs. However, the airline can save money by improving the efficiency of the process. For example, time is lost when write-ups are not easy to read or are incomplete. In such cases, work cannot proceed until the inspector is tracked down and clarifies what has been written on the write-up form.

Tracking and planning is also hindered by the current system. There is little ability to analyze the non-routine repairs reported over time. Common repairs can become part of the routine maintenance planned on a particular aircraft. This is partly due to the lack of a database of defects and locations. Another major hindrance to such analysis is the lack of standardized terminology for identifying defects.

Inspectors have indicated that they frequently rely on reference material that is not available to them at the inspection site. It is not practical for the inspector to carry around the complete set of reference material in paper form. Therefore, in order to access the reference material needed to correctly complete an inspection, the inspectors must often leave an inspection area.

The inefficiencies described above generally translate to lost time, which in turn translates to lost money. One element of the current process can be quantified directly in terms of costs. This is the cost of the paper write-up forms themselves. These forms are specially printed in quadruplicate to support tracking of the paper work. (See **Figure 6.1**). Consequently the cost of these specialized forms is relatively high. The number of forms used per aircraft maintenance visit varies depending on the type of aircraft, age of the aircraft, and type of maintenance visit. UAL found that it uses anywhere from approximately one thousand to five thousand write-ups per visit. When multiplied by the number of maintenance visits that are that are completed each year, the figure that results is significant in terms of maintenance costs.

**Figure 6.1 Current UAL Non-Routine Write-Up Form**

FOG STA		MAL COMP		SPECIFIC ITEM		DEFECT		REG		SSR		Z6452N			
A-DI		SKILL		ZONE		GENERATED BY		INSP		COPR TASK NBR		[Barcode]			
FOR STUDY DC		STA TYPE		STA		IC		SIA		SIF		IC			
Y/N		NO													
Y/N		EST LINE		IC		DAT CODE		WARRANTY		PROCESSED BY		WH SHL EC COF REVIEW			
Y/N				Y/N								ENTER COF			
INSP		MEC		1											
<b>UNCONTROLLED, FOR REFERENCE ONLY</b>															
DO NOT WRITE IN THIS AREA															
DO NOT WRITE IN THIS AREA															
<b>UNCONTROLLED, FOR REFERENCE ONLY</b>															
INSP		MEC		SCAN THIS BARCODE, THE WRITE-UP BARCODE (ABOVE) AND YOUR PIN WHEN ALL MECHANIC OR ALL INSPECTION ITEMS ARE SIGNED OFF								[Barcode]			
LEAD:		IS ESTIMATED WEIGHT CHANGE 5 LB OR MORE?		YES		NO		IF ESTIMATED WEIGHT CHANGE IS 5LB OR MORE CONTACT TECHNICAL SERVICES							
PAR SERVO								DASH		REPAIR		FOR NUMBER			
[Barcode]								?		M M U D					

## 6.3 NON-ROUTINE REPAIR WRITE-UPS: THE AUTOMATION APPROACH

The United Airlines personnel were well aware of the problems associated with the current non-routine repair write-up system. The question of how to improve the process had been discussed both formally and informally for years. An automated approach to the process was desired, but the proper technology was needed before it could be implemented. United personnel learned of the results of the first fielding of pen computers for the Flight Standards Service that was performed as part of the FAA/AAM Human Factors research program (Layton, in press). Given that pen computers are similar in size to the clip boards that inspectors carry during preliminary inspections, there was interest in this relatively new technology. In June 1995, UAL funded a project to determine if pen computer technology was a viable alternative to the current paper-based method for generating and tracking non-routine repair write-ups.

### 6.3.1 The Goals

The immediate goals of the initial project were two-fold. First, UAL wanted to determine if pen computer technology was a feasible solution for this aircraft maintenance application. If the technology proved feasible, many of the problems identified above could be addressed. Second, the project would allow inspectors and other personnel to evaluate various brands of pen computers to help select appropriate hardware. The long-term vision of the project was to provide better tools to the inspectors, lead mechanics, and planner/analysts in order to improve the creation and processing of non-routine repairs. The expected result was a reduction in the time it takes to complete a maintenance visit.

### 6.3.2 Expected Benefits of Pen Computer Based System

The pen computer approach provides solutions to many of the problems listed with the current system: cheaper paper forms, language standardization, improved database to support planning and analysis. In order for the automated system to be successful, however, it must provide sufficient tools and support for the inspectors so that they are willing to use the system. The expected benefits of the system for inspectors include:

- Less handwriting (e.g., pick-lists, duplicate write-ups)
- Standardization of language (e.g., constrained fields)
- Information is complete (system checks write-up before saving)
- Improved readability of printouts
- All Inspectors will be "Rovers" (no longer constrained to one area of the aircraft)
- Transfers occur automatically during breaks
- Easier to review write-ups after transfer
- Easier to get reprints if needed.

Note that inspectors were not expected to generate write-ups more quickly using the pen computer write-up system compared to the paper forms. It was also noted that the initial system had limited benefits compared to the operational system that is planned. If the technology proves feasible, the additional benefits include:

- Expanded database to handle entire UAL fleet
- Wireless radio frequency (RF) transfers data transparently and "instantaneously"
- Access to on-line reference material
- Automated routing of information
- Improved planning/scheduling.

In essence, the bottom line benefit of the full system would be to improve the collection and flow

of non-routine repair information to reduce the time it takes to complete a maintenance visit.

### 6.3.3 Pen Computer Models Evaluated

Pen computers are a general class of computer that employ a specialized operating system which allows a pen stylus to be used as an input device. This stylus can be used to print characters that are then "recognized" and converted to digital representations of the character. Pen computers have evolved over the past five years. A wide range of pen computer technology has become available, from low-end personal digital assistants to slate computers to "convertibles" with both a pen stylus and a standard keyboard.

**Table 6.1** lists the minimum specifications desired for the pen computer hardware and software to be used for the Phase 1 inspector system platform. Several models of pen computers were considered for inclusion in the field study. However, for a variety of reasons, some models were not actually fielded.

<b>Table 6.1 Specifications for Inspector Pen Computer Platform</b>	
<b>Hardware</b>	
<ul style="list-style-type: none"> <li>• 486/25 MHz</li> <li>• 8 MB RAM</li> <li>• 100 MB Hard Drive</li> <li>• Type II PCMCIA Slots</li> <li>• 5 MB PCMCIA Memory Card</li> <li>• One of the following</li> <li>• Ethernet PCMCIA Card</li> <li>• Cradle with network and power connections</li> <li>• Docking station with an Ethernet card.</li> </ul>	
<b>Software</b>	
<ul style="list-style-type: none"> <li>• MS-DOS 6.2</li> <li>• Microsoft Windows for Pen Computing</li> <li>• Novell Netware</li> </ul>	

**Table 6.2** summarizes units that were considered for the evaluation and includes, where applicable, a note explaining the primary reason(s) why a unit was not fielded.

<b>Table 6.2 Pen Computers Considered for Fielding</b>		
Make/Model	Fielded?	Why Not?
Fujitsu Stylistic 500	Yes	
Hammerhead 486	Yes	

Inforite Phoenix	No	Too slow (386SX/25MHz); Screen too small
Kalidor K2100	Yes	
MicroSlate Datellite 400L	No	Too heavy/bulky, poor screen clarity
NCR Safari	No	No longer available
Telepad SL	No	Too slow, poor usability
Telepad 3.0	No	No units provided by Vendor
Telxon 1134	No	Screen too small, problems with network communications
Telxon 1184	Yes	
Toshiba Dynapad T200	No	No longer available
Zenith CruisePAD	No	Requires <b>RF</b> capability

### 6.3.4 Scope of Pen Computer System

Given that the initial system development was targeted at determining feasibility of the technological approach rather than operational use, the initial scope was limited. The proof-of-concept system supports:

- Initial data entry of write-up data by inspectors on a pen-based computer
- One model of aircraft (i.e., classic 747)
- Batch transfer of data via Ethernet network
- Automatic data transfer between the pen units and the local data base
- Automatic data transfer between the local data base and UAL's master data base
- Administration of users and privileges
- Administration of aircraft visit information
- Administration of printing and data transfer functions
- Modification of write-ups after initial transfer.

This partial implementation allowed for a smaller up-front investment. Feasibility, therefore, could be assessed without risking the larger quantity of dollars needed for full, operational implementation.

## 6.4 PEN COMPUTER SYSTEM: DESIGN AND DEVELOPMENT

The Pen Computer Non-Routine Repair (NRR) Write-up System was designed, developed, and tested over a nine month period, from June 1995 to February 1996. Ten personnel from UAL and four developers from Galaxy Scientific Corp. formed the project team. The first two months involved development of detailed design specifications. Software development and testing took place over a four-month period. The final three months encompassed system integration, installation and testing.

### 6.4.1 Interface Design Methodology

From past research we have learned that persons who do not routinely use computer technology to perform their jobs generally have a modest understanding (though possibly greater aptitude) concerning such tools, and an even lower appreciation for them. Such persons are often suspicious of new technologies and may reject new solutions if they perceive any difficulties with it. To address such users, we integrated the following concepts in the design of this project:

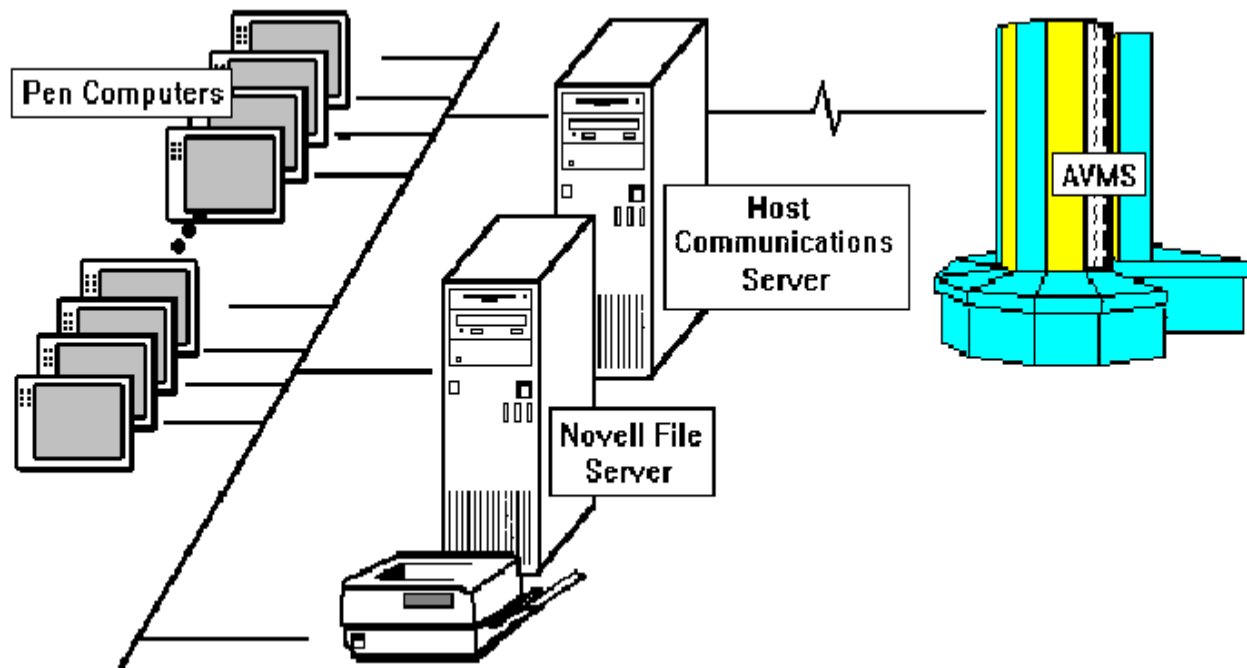
- Human-Centered design:** Galaxy Scientific prides itself on its application of Human Factors principles to production software. Every attempt was made to ensure that the system was easy to learn and to use. At many points throughout the project, Galaxy Scientific used an iterative approach that included soliciting feedback and suggestions from those who would ultimately use the system.
- Limit the amount of work:** Redundant information was eliminated. Once data is entered, it would remain and propagate for as long as it was still valid.
- Restrict the possibility of error:** Handwriting recognition technology is not perfect. Through the use of selection lists and other standard controls provided in the MS Windows interface, the ability to enter invalid data was greatly reduced.
- Check for errors:** Not all input can be constrained to eliminate errors on input. Therefore, to the extent that was practical, the data was checked prior to saving to verify that the information was complete and accurate.
- Standardized data entry:** One of the goals of this project was to provide statistical analysis data from inspection results. In order to properly perform such analysis, a standard format and language were established in the collection of defect information and comments.
- Multiple input methods:** Different users feel comfortable using the computer in different ways. In order to accommodate as many preferences as possible, multiple methods of data entry, including keyboard, pen, and mouse, were supported.

### 6.4.2 System Configuration

**Figure 6.2** illustrates the architecture of the automated UAL Non-Routine Repair Write-up

System. The network system is a Novell-based, Ethernet network system. This data network is comprised of multiple pen computers, one host communication server, one host file server, and one double-sided laser printer. The file server stores the central (local) database for the pen computers and handles the printing of write-up forms. The communication server is used to transfer data to UAL's Aircraft Visit Maintenance System (AVMS). The laser printer prints the non-routine repair write-up forms, filled out with the inspection write-up information.

**Figure 6.2 The Architecture of the Automated UAL Non-Routine Repair Write-Up System**



### 6.4.3 Work Flow: Using the Pen Computer

The software that runs on the pen-based computer is called the Pen Computer Application. An inspector uses the Pen Computer Application to enter and transmit non-routine write-up information. This application actually consists of two separate programs -- one for entering the non-routine write-up data and a second which transmits the data to the Host System.

An inspector beginning his shift will select a pen-based computer from the bank of computers designated for this purpose. The computer will be running the Non-routine Repair Write-up software already, unless it is powered off, in which case powering on will initiate the software automatically.

At this point, the application is in "**docking mode**", a restricted state in which two functions are available: Data Transfer and Inspector Log-in. Data transfer should have been completed when the computer was last docked. When an inspector is ready to begin work, at the beginning of the shift or after a break, the inspector will log-in to a pen unit. The log-in requires him to enter his



personal identification number (PIN) via bar code, password, and the bay in which he will be operating. Once the identification is accepted, the computer will restart in "**data entry mode**". (The computer must be rebooted so that the network software may be unloaded.)

The data entry screen consists of two parts. The first screen contains all the standard information collected from the inspection. The second screen displays a summary of the defect location information, and will allow entry of additional details (up to 255 characters).

After completing a single write-up, the inspector may then initiate a new write-up record. Selecting "New" from the pull-down menu will display a dialog box allowing the choice of creating a completely blank form or carrying over information from the previous write-up.

At the completion of the shift (or at the next break), the inspector will return the unit to the docking station. Since battery life for the Pen-based computers is not expected to last the entire shift, it will be necessary for the inspector to change out batteries during breaks. When the inspector returns the computer to the docking station, he should replace both batteries (one at a time) with spare batteries that are fully charged. The "used" batteries should be placed in the external charging unit. Next the inspector will initiate the data transfer sequence that will restart the machine in the docking mode. All data collected since the last upload session will be sent to the Host File Server and deleted from the pen-based computer. Also, at this point, any reference tables updated at the Host system will be downloaded to the pen unit. This transfer is normally an automatic process, so the inspector does not need to monitor the process. However, in the event that a transfer is aborted for any reason, it will also be possible to start the process manually.

#### **6.4.4 Description of the Pen Computer Application Software**

The software residing on the pen computers is known as the Pen Computer Application. The Pen Computer Application is divided into two programs: the Write-up program and the Transfer program. The Transfer program handles transfer of non-routine write-ups to the file server (see **Figure 6.3**) and permits log-in to the Write-up program (see **Figure 6.4**).

**Figure 6.3 Example of the Transfer System**

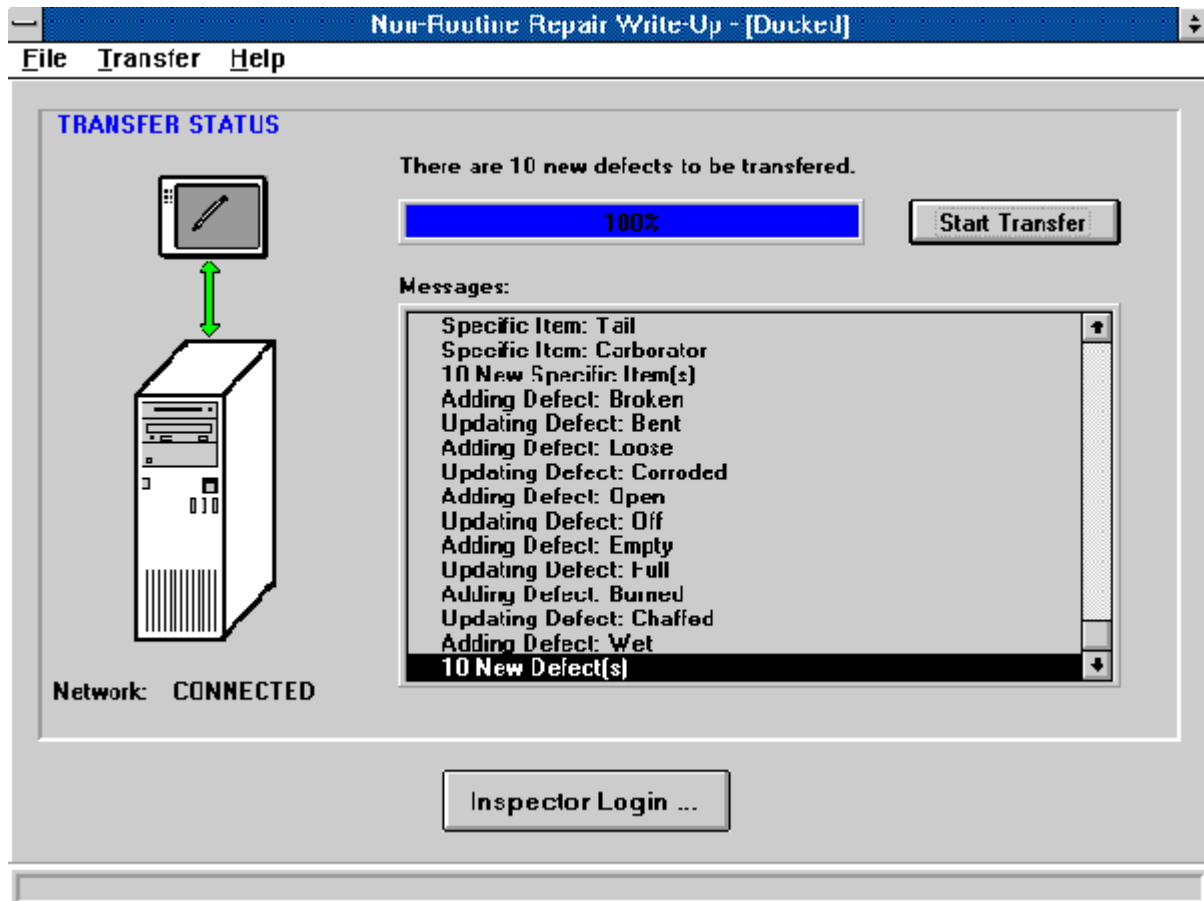


Figure 6.4 Example of Log-in Screen

**Inspector Login**

1. Wand Your Bar Code:

2. Enter Your Password:

3. Select a Bay:

2     3  
 1     4     9

BAY #3 ... 747-123 ... VISIT 536

A	B	C
D	E	F
G	H	I
J	K	L
M	N	O
P	Q	R
S	T	U
V	W	X
Y	Z	
1	2	3
4	5	6
7	8	9
*	0	#
Bksp	Clr	

The Write-up program is used to enter initial write-up information. The main form is used to enter standard write-up information (see **Figure 6.5**) using the pen stylus. Rather than handwriting the information, much of the form can be completed by selecting items from drop-down lists. Related fields are linked such that entering information in one field will determine the content of the related fields. For example, if the Zone Number is entered, then the Major and Submajor fields are automatically filled in for the inspector. A change to any of these three fields will affect the other two.

**Figure 6.5 Main Write-Up Form**

**Non-Routine Repair Write-Up**

**Write-up Edit Tools Help**

Analyst: Petray, Jim      A/C: 8454

---

**#1 ENGINE, NOSE COWL BULKHEAD IS CORRODED (EXFOLIATE)**

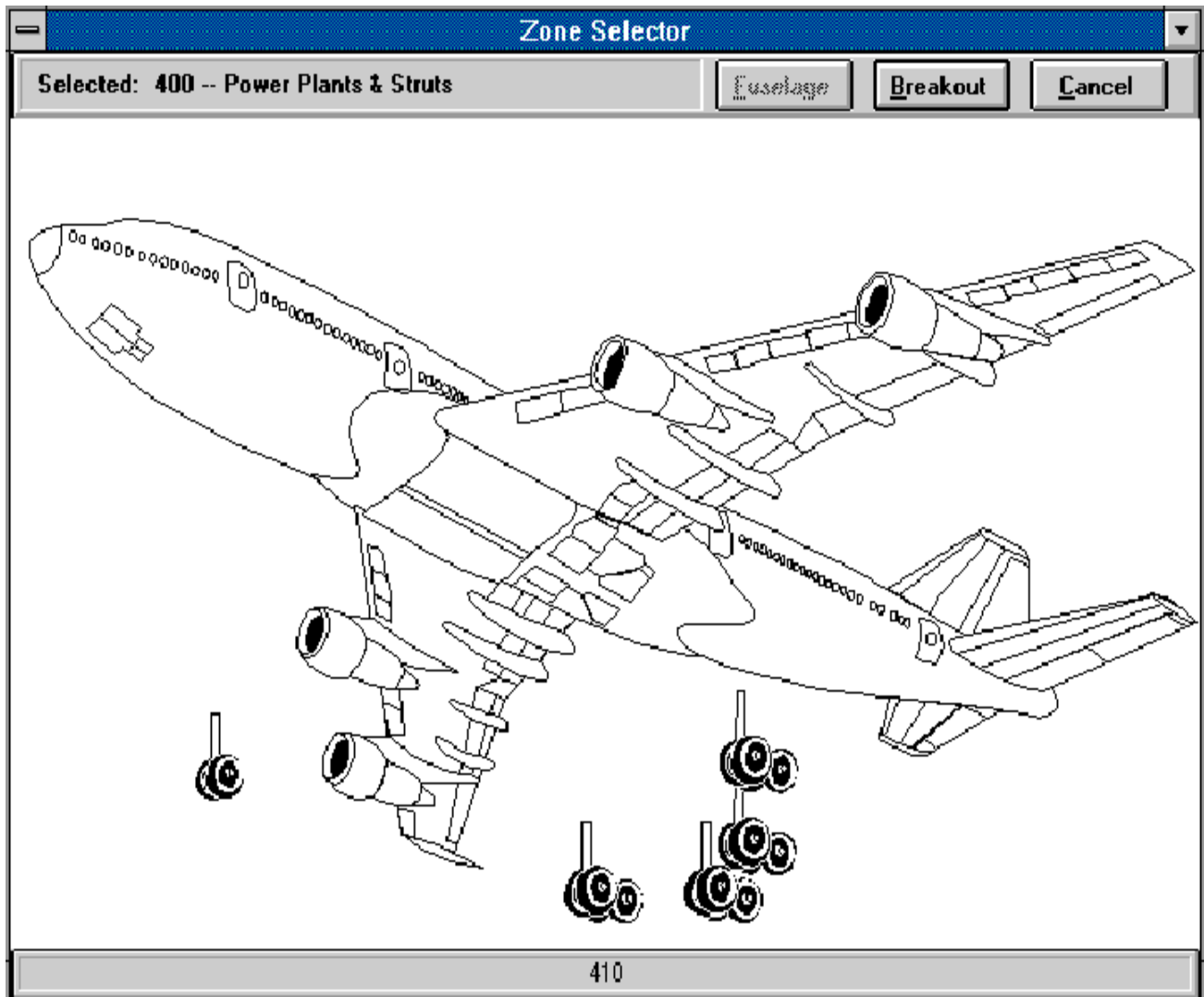
<p><b>Zone #:</b>    4 1 1</p> <p><b>Major:</b>    #1 ENGINE</p> <p><b>SubMajor :</b> NOSE COWL</p> <p><b>Specific Item:</b> BULKHEAD</p> <p><b>Defect:</b>    CORRODED (EXFOLIATE)</p> <p><b>Skill:</b>     5 0</p> <p><b>ATA:</b>      71 POWER PLANT - GENE</p> <p><b>Generated By:</b>  <input checked="" type="radio"/> Job Card    <input type="radio"/> Write-up    <input type="radio"/> Other</p> <p><b>Job Card Number:</b>  3 3 4 2 6</p>	<p><b>Corrosion Task #:</b>    _____</p> <p><input type="checkbox"/> <b>Principal Structural Element?</b></p> <p><b>Station Type:</b>        _____</p> <p><b>Position/Station:</b>    _____</p> <p><input type="checkbox"/> <b>MRR?</b>  <input type="checkbox"/> <b>Recheck?</b></p> <p><b>Station:</b>              _____</p> <p><b>FR:</b>                    _____</p> <p><b>Water Line:</b>        _____</p> <p><b>TO:</b>                    _____</p> <p><b>Stringer:</b>            <input type="radio"/> Left    <input type="radio"/> Right</p> <p><b>FR:</b>                    _____</p> <p><b>Body Line:</b>         <input type="radio"/> Left    <input type="radio"/> Right</p> <p><b>TO:</b>                    _____</p>
--	--

Choose the Defect from the drop-down list.

Write-up (new) of 3

In addition, Zone Charts are available for identifying the location of the defect (see **Figure 6.6**). The inspector can use the pen stylus to select the location of the defect and have the corresponding zone number and major and submajor fields automatically completed.

**Figure 6.6 Example of an On-Line Chart**



The drop down lists for Specific Items and Defects are not intended to hold all possible options. Rather, the lists contain the most frequently occurring items and defects. If an inspector wants to record a defect that is not currently in the list, the inspector can use the Expanded Input Field to write the defect. The new defect will not be added immediately to the drop down list, but it will be added to a separate database. The system administrator can then determine whether or not this item should be added to the default list based on the frequency of its occurrence.

If a similar defect is found in multiple locations, the write-up can be duplicated and modified to indicate the different location, thus reducing repetitious inputs by the inspector. **Figure 6.7** illustrates how the user can open previous write-ups for copying or for modification.

**Figure 6.7 Example of Opening a Previous Write-Up**

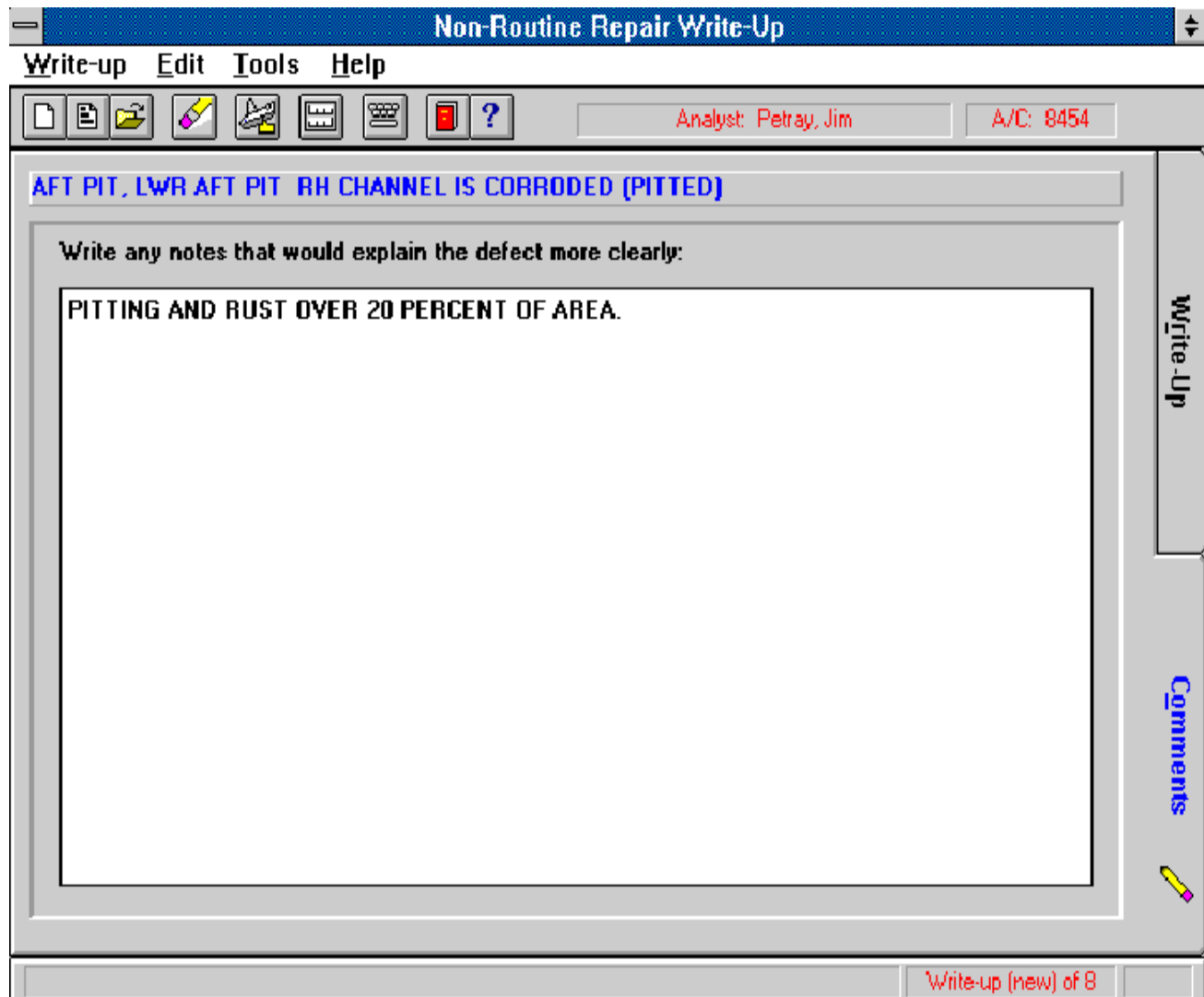
**Open a Previously Saved Write-up**

Choose a previous write-up from the list:

	Date/Time	Bay	Major	SubMajor	Specific Item	Defect	Corr
3	01/18 01:22	3	#1 ENGINE	ENGINE	BOLT	BURNED	No
4	03/31 07:02	3	CABIN	B ZONE RH	CABLE	BURNED	No
5	03/31 07:03	3	FORWARD PIT	LWR PIT LH	FLOORBEAM	CHAFFED	No
6	03/31 07:04	3	CABIN	UPR DECK LH	FRAME	CORRODED	Yes
7	03/31 07:05	3	ACFT DOORS	#3 MED LH	CASTING	DENTED	No
8	03/31 07:06	3	EMPENNAGE	RUD LWR	SKIN	DELAMINATEI	No

The Comments form in the Write-up program contains a free-form field for expanding on the location or description of the defect (see **Figure 6.8**). As with any field that accepts handwriting, the user may use the on-screen keyboard or expanded input field for entering or editing information.

**Figure 6.8 Example of Adding Comments to a Write-Up**



### 6.4.5 The Host System Application And Transfer Program

The software responsible for maintaining the data on the Host File Server is known as the Host System application. The software that transfers data from the file server to the Aircraft Visit Maintenance System (AVMS) is known as the Host-AVMS Transfer application.

The Host System application performs functions necessary to maintain the host database, print write-up data, and initiate the upload of database information to AVMS. Some functions are carried out at regular intervals by the program and others are initiated by the user. Of the user initiated functions, some are concerned with the write-ups and others with administration.

Functions performed by the Host System application are:

- Automatic Functions
  - Write-up Printing
  - Initiate AVMS-Host Transfer Application
- User Initiated Functions (Write-ups)



- Reprint Write-ups
- View Write-ups
- Modify Write-ups
- View Write-ups History
- Print Summary Report
- View Print Queue
- User Initiated Functions (Administrative)
  - Visit ID Management
  - User ID Management
  - Database Maintenance
  - Initiate AVMS Transfer Application

### ***Automatic Functions***

The Host System application performs two functions automatically. These are printing non-routine write-ups and calling the Host-AVMS Transfer application. Between shifts or during breaks the pen computer transfers data to the Host Database. The Host application periodically prints all new write-up data on 8.5 x 11 inch paper using a two-sided laser printer. Similarly, the Host System application periodically activates the Host-AVMS Transfer application to transfer write-up data from the Host File Server to AVMS.

### ***User Initiated Functions***

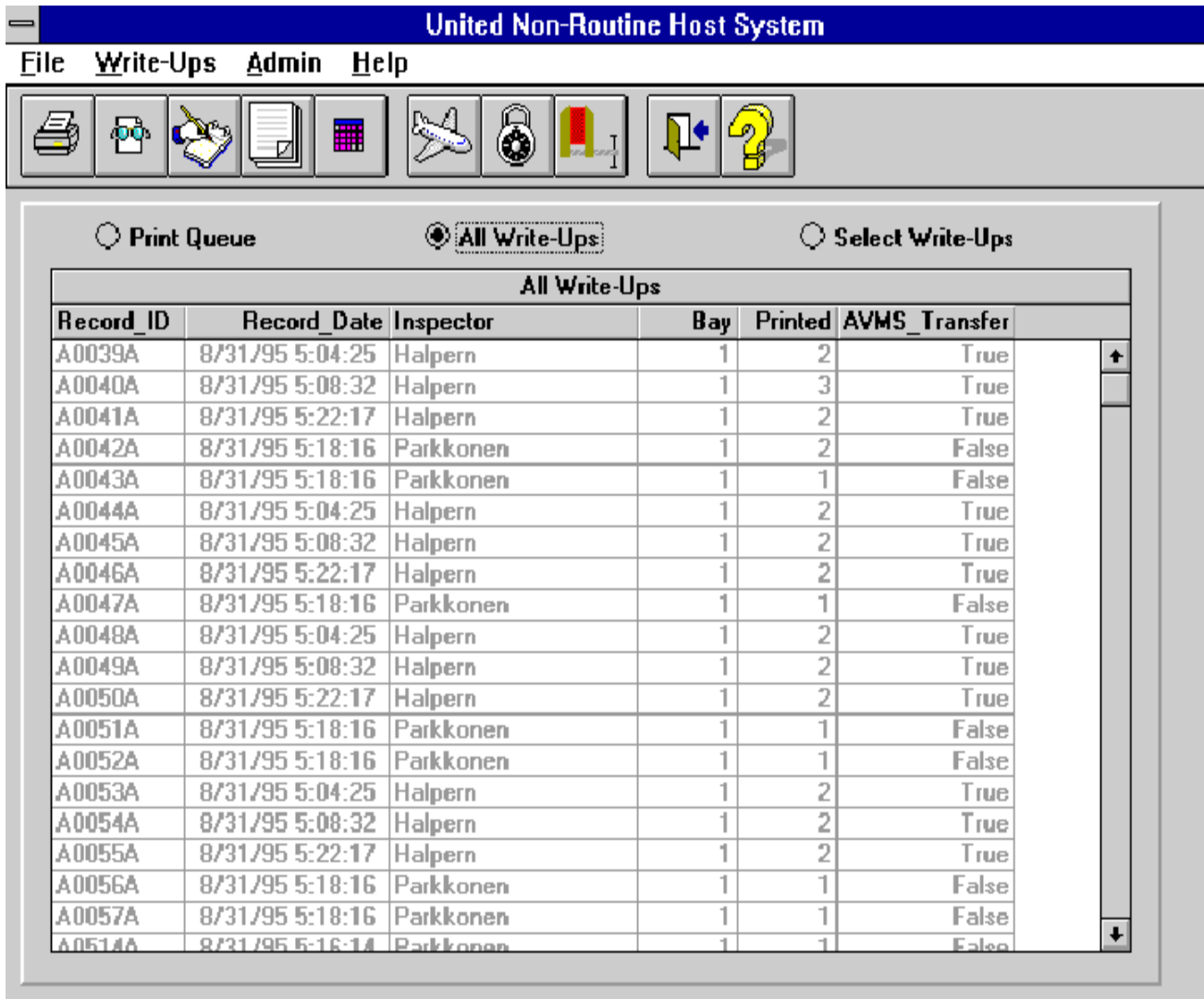
In order to access user-initiated functions of the Host application, users must log-in. To log-in, the user must swipe his identification card through the bar-code reader and enter a log-in password. (see **Figure 6.9**) Only persons with a valid password and matching bar-code scan, will be able to access the user-initiated functions of the Host System application.

**Figure 6.9 Host Application Log-in Screen**



User Initiated Functions are accessed via the toolbar or the menubar of the Main Window (see **Figure 6.10**). The toolbar is divided into three groups. The group on the far left allows the user to perform functions on write-ups. The group to the right of that allows the user to perform administrative functions. The last group allows the user to exit the program or get help. The menubar is grouped similarly to the toolbar.

**Figure 6.10 Host System Application Main Window**



### [User Initiated Functions, Write-ups](#)

The left most group of buttons on the toolbar perform functions on the write-up data (see **Figure 6.11**). The user can select a specific write-up or group of write-ups and then use a tool to perform any of the following operations: reprint, view, modify, or view the history of the write-ups. Additionally a user may print a summary report of write-ups recorded on a certain date. Of course, whether or not a specific user can perform these operations will depend on privileges given to the user.

**Figure 6.11 Host Application Write-up Tools: Reprint, View, Modify, View History, Print Summary**



## User Initiated Functions, Administration

The group of buttons right of the Write-up buttons is the Administration buttons. The Administration buttons are shown in **Figure 6.12**. Using these buttons, an administrator can assign write-up numbers to a visit, assign user ID's, and perform database maintenance functions (e.g., compact and repair). Only users with administrative privileges will be allowed to do so.

**Figure 6.12 Host System Application Administration Tools**



## 6.5 THE PILOT STUDY

The Pilot Study was conducted using inspectors at United Airlines Oakland Modification Center. The study was conducted in two stages. The primary goals of the first stage of the study were to (a) train inspectors on how to use the system and (b) to refine the study procedures and feedback forms. The primary goals of the second stage of the study were (a) to have inspectors evaluate various aspects of pen computer hardware, (b) to obtain feedback from inspectors on the features of the software system, and (c) to obtain input from inspectors on what items should have priority for future development.

### 6.5.1 Stage One

In the first stage, inspectors were trained to use the pen computer write-up system and gained experience using the application on two different pen computer models: the Fujitsu Stylistic 500 and the Kalidor K2100. Eleven inspectors representing all three shifts participated over several days in early December 1995. Despite the logistical and technical problems encountered, this first fielding made four major accomplishments:

- trained inspectors on all three shifts in how to use the system
- provided inspector feedback on pen computers and the Non-Routine Repair Write-up application
- identified procedural and system problems
- identified problems with the feedback forms.

**Table 6.3** contains the outline of the training that was provided. Hands-on training was considered an essential element for the training to be effective. Participants completed a post-training evaluation form immediately after the training session. The evaluation form assessed their comfort level with performing each of the key tasks associated with system usage. All participants indicated a medium to high comfort level for each task. Participants also were instructed to complete a

follow-up form at the end of the pilot study. This form was intended to provide a better gauge of the training effectiveness by having participants rate the training after they had completed the pilot study. However, very few of the participants completed the post-study training evaluation form. Hence no conclusions could be drawn about how the training could be improved.

**Table 6.3 Training Outline**

<p><b>1. Project Overview</b></p> <ul style="list-style-type: none"> <li>• Problem Statement</li> <li>• Goals</li> <li>• Present status</li> <li>• Benefits</li> <li>• Future plans</li> </ul> <p><b>2. Write-up Process Overview</b></p> <ul style="list-style-type: none"> <li>• Write-ups created on-line using pen-computer</li> <li>• Data transferred automatically to local master database via network connection during breaks</li> <li>• Printouts are automatically printed on duplex laser printer</li> <li>• Data automatically transferred to AVMS database via Host Computer</li> </ul> <p><b>3. Demonstration and Practice</b></p> <ul style="list-style-type: none"> <li>• Logging in</li> <li>• Making Write-ups</li> <li>• Docking and Logging out</li> </ul>	<p><b>5. MS Windows Basics</b></p> <p><b>6. Understanding Different Fields</b></p> <ul style="list-style-type: none"> <li>• Types of Handwriting Fields</li> <li>• Drop down Pick Lists</li> <li>• Option Buttons</li> <li>• Check Boxes</li> </ul> <p><b>7. Handwriting Tips</b></p> <p><b>8. Data-entry Aids</b></p> <p><b>9. Introduction to Help Features</b></p> <ul style="list-style-type: none"> <li>• Contents</li> <li>• Search for Help on</li> <li>• Using Help</li> <li>• Using a Pen</li> <li>• On-line Manuals</li> </ul> <p><b>10. Hardware Tips</b></p> <ul style="list-style-type: none"> <li>• Pen</li> <li>• Screen Lighting Controls</li> <li>• Batteries</li> <li>• Power Modes</li> </ul>
--	--

Most of the inspectors did provide feedback on the pen computer hardware and the automated Non-routine Repair Write-up system. Two main findings came from this portion of the evaluation. First, two-thirds of the inspectors who responded indicated that they preferred the pen computer system over the current paper system for creating non-routine repairs. Given that change of any kind is often rejected or met with much skepticism, it was encouraging to find that inspectors saw the potential benefit of computer technology and were ready to use it on the job.

The second main result was that the inspectors found the handwriting recognition technology was not very accurate. This finding was not surprising. Handwriting recognition software has not improved noticeably in the past few years. Also, people understandably are annoyed by even a small percentage of recognition errors. Recognizing this fact, the Non-Routine Repair application was developed with as few handwriting-only fields as possible. The inspectors expressed appreciation for the drop down lists and other aids that limited the need for handwriting. The only free-form field is the comments field. It was questionable whether inspectors would provide comments given the current inaccuracy of handwriting recognition and the difficulty of using an on-screen keyboard. However, the inspectors indicated that they did enter comments and that they used the on-screen keyboard to enter this information. Thus, when a small number of free-form fields are necessary, the on-screen keyboard appears to provide

sufficient support. If an application had a large requirement for free-form data entry, a hardware keyboard probably would be recommended.

Several valuable lessons were learned in this first fielding. Many of these lessons were helpful in designing a more realistic study for the second stage. For example, the initial study plan called for:

- equal numbers of inspectors on all three shifts
- 6-8 hours of hands-on training for all participants
- equal amounts of time on each pen computer model
- working in parallel with the current system (i.e., participant shadows actual inspector)
- operate system during entire D-Check preliminary on a 747 (12 shifts = 4 days for 24 hours).

While these were valid design goals, the scheduling and logistical problems of the aircraft maintenance environment made most of these goals unattainable. The first change was that the 747 D-Check was changed to a Mid-Point Visit (MPV). This adjustment was due to the schedule of aircraft coming in for inspection. Other scheduling problems were also encountered with assigning inspectors for the test. For example, the inspectors that would be present for training on the day prior to the start of the preliminary inspection would not all be present for the remaining days of the test. This logistical problem is due to the complex regular day off (RDO) schedule that is a fact of life in aircraft maintenance. Similarly, personnel who might be present for several days of the test, may not be present the day of training. Consequently, some training had to be provided later for these individuals. Obviously, this type of scheduling constraint prevented researchers from using the inspectors for four consecutive days.

In addition, it was not practical for participants to work in parallel with another inspector. The plan was for the study participant to be paired with an inspector assigned to work the 747 preliminary. The participant would create write-ups using the pen computer to match the ones being generated by the "actual" inspector on the traditional paper forms. This arrangement had strong appeal since it would provide a strong test of the actual working conditions in which the system would be expected to function. Although inspection had agreed to provide redundant personnel ahead of time, the conditions at the time of the study would not allow it. That is, four preliminaries were being conducted simultaneously; naturally, business priorities dictated that redundant personnel could not be justified, since the inspectors were needed to complete "real" inspections.

## 6.5.2 Stage Two

A second pilot study was conducted in early February 1996. Nine inspectors participated: four on day shift, four on swing shift and one on midnight shift. **Table 6.4** summarizes the background of the inspectors.

**Table 6.4 Stage 2: Summary of User Background**

Inspector	1	2	3	4	5	6	7	8	9	Avg.
Yrs at airline	10+	11	10	12	9	12	27	9	9	12.1 yrs
Yrs as inspector	7	7	6	7	6	8.5	8	6	7	6.9 yrs
Shift	2	2(5)	2(5)	2(5)	3	1	1	1	1	Day: 44.5% Swing:44.5% Mid: 11.0%
Age	45-55	35-45	35-45	45-55	35-45	35-45	45-55	25-35	35-45	25-35: 11.0% 35-45: 44.5% 45-55: 44.5%
Ever used PC?	No	Yes	Yes	Yes	Yes	Yes	Yes	No	Yes	Yes: 78%
How long?	0	1 mos	8 yrs	6 yrs	10 mos	3 mos	2 yrs		Own 386	~3 yrs
Ever used MS Windows?	No	Yes		Yes	Yes	Yes	Yes	No	Yes	Yes: 67% No: 22% ?: 11%
Participated in the 1st study?	Yes	No	Yes	Yes	No	Yes	Yes	No	Just barely	Yes: 67% No: 33%

## Methodology

Stage 2 of the study was conducted over one 24-hour period. Each inspector used the five pen computers and completed the revised feedback forms during one shift, as detailed in the schedule shown in **Table 6.5**. A separate day of training was not included in this stage of the study because six of these nine inspectors participated in the first pilot study. Rather, each shift began with a briefing to explain the purpose of the second study and to clarify what software and procedural changes had been made since the first study.

<b>Table 6.5 Schedule for Stage 2 Pilot Study</b>			
	<b>Swing (2/8/96)</b>	<b>Midnight (2/8-9/96)</b>	<b>Day (2/9/96)</b>
<b>Briefing</b>	3:30 pm - 4:30 pm	11:30 pm -12:30 am	7:30 am - 8:30 am
<b>Computer 1</b>	4:30 pm - 5:30 pm	12:30 am - 1:30 am	8:30 am - 9:30 am
<b>Computer 2</b>	5:30 pm - 6:30 pm	1:30 am - 2:30 am	9:30 am - 10:30 am
<b>Computer 3</b>	6:30 pm - 8:00 pm	2:30 am - 4:00 am	10:30 am - 12:00 pm
<b>Computer 4</b>	8:00 pm - 9:00 pm	4:00 am - 5:00 am	12:00 pm - 1:00 pm
<b>Computer 5</b>	9:00 pm - 10:00 pm	5:00 am - 6:00 am	1:00 pm - 2:00 pm
<b>Complete Forms</b>	10:00 pm - 11:00 pm	6:00 am - 7:00 am	2:00 pm - 3:00 pm

One goal of the stage 2 study was to gain feedback on additional pen computer hardware. Three additional brands of pen computer hardware were available for evaluation in this stage: Hammerhead 486, Norand Pen\*Key 6600, and Telxon PTC-1184.

Feedback obtained from the initial pilot study was used to identify both software and procedural



changes that were made prior to the second stage of the study. The primary software changes centered around eliminating rebooting problems associated with the network transfer/log-in portion of the write-up program. In addition, a procedural change was needed to prevent the problem from occurring. In the initial training, inspectors were told that they could disconnect from the network as soon as they had completed the log-in. However, in stage 2, the inspectors were retrained to wait for the rebooting process to begin, prior to disconnecting the computer from the network. Both of these changes succeeded in correcting the rebooting problems encountered in the first fielding.

The inspectors simulated a C-Check preliminary inspection on a 747. In this stage, there was no attempt to pair up the study inspectors with "real" inspectors since this approach proved impractical in stage one. Rather, inspectors were given C-check inspection job cards to work various areas of the aircraft.

During the last hour of each shift, the inspectors were given dedicated time to complete the feedback forms. The feedback forms used in Stage 2 are included in **Appendix A**.

## **Evaluation Results**

The nine inspectors were asked to evaluate each of the pen computers on nine different hardware factors:

- screen size
- durability/weight
- overall speed
- screen lighting
- screen clarity
- battery life
- battery replacement
- ease of carrying
- stylus feel

This section describes each of these criteria and summarizes the feedback received.

Before describing the specific characteristics, some overall comments should be made about the feedback received. First, some inspectors did not provide complete feedback on all criteria for all models. For example, Inspector #1 did not evaluate the Hammerhead unit, Inspector #8 did not evaluate the Telxon unit and Inspector #6 only evaluated the Fujitsu and the Norand units. Also some inspectors did not evaluate certain criteria. For example, Inspector #1 did not evaluate battery life or battery replacement, Inspector #8 did not evaluation battery life and Inspector #5 did not evaluate stylus feel. Such omissions are recorded as No opinion in the following analysis. A detailed compilation of the inspector responses on all criteria is included as **Appendix B**.

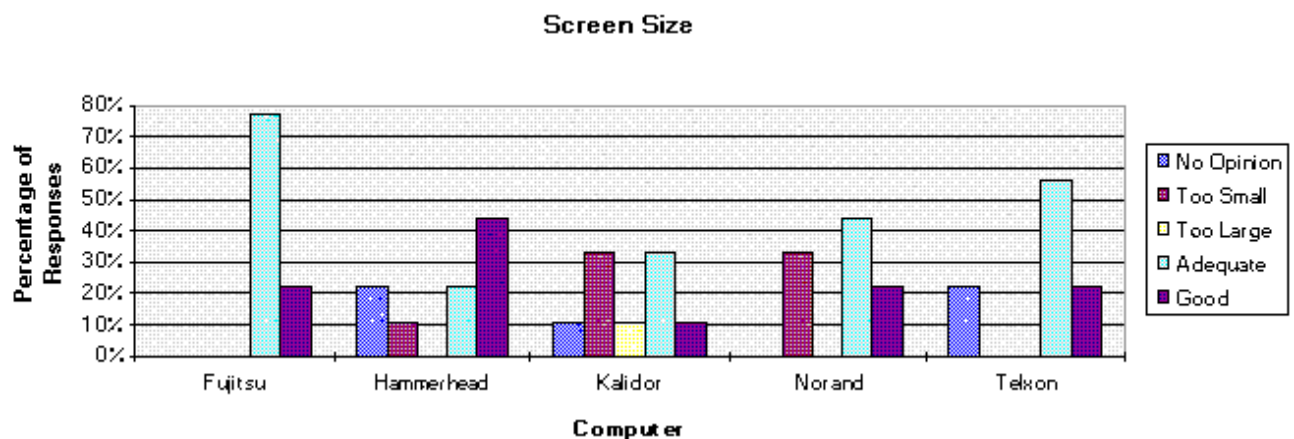
## Screen Size, Lighting and Clarity

Screen size, lighting and clarity are important factors to be considered in evaluating a pen computer. **Table 6.6** summarizes the screen characteristics for each of the models evaluated.

Table 6.6 Screen Characteristics of Five Pen Computers					
	Fujitsu Stylistic 500	Hammerhead 486	Kalidor K2100	Norand Pen*Key 6600	Telxon PTC-1184
<b>Size</b>	8" diag.	9.4" diag.	7.5" diag.	7.25" diag.	9.5" diag.
<b>Lighting</b>	Backlit	Backlit	Sidelit	Backlit	Backlit
<b>Type</b>	Transmissive	Transflective	Transflective	Transflective	Transflective
<b>Resol.</b>	max 640x480	max 1024 x 768	max 640x480	max 640x480	max 640x480

The Telxon and Hammerhead screens are the largest, followed by the Fujitsu, Kalidor, and Norand respectively. In general, the three larger screens were rated more favorably than the two smallest screens (see **Figure 6.13**). All screens were evaluated at 640 x 480 pixel resolution (The Hammerhead 486 is the only one of the models evaluated that can be used in a higher resolution). Thus, the same display elements appear larger on a larger screen and smaller on a smaller screen. For example, the field for inputting characters is larger on a larger screen, making it easier to print characters for handwriting recognition. Also, a larger screen allows more detailed graphics to be displayed more clearly.

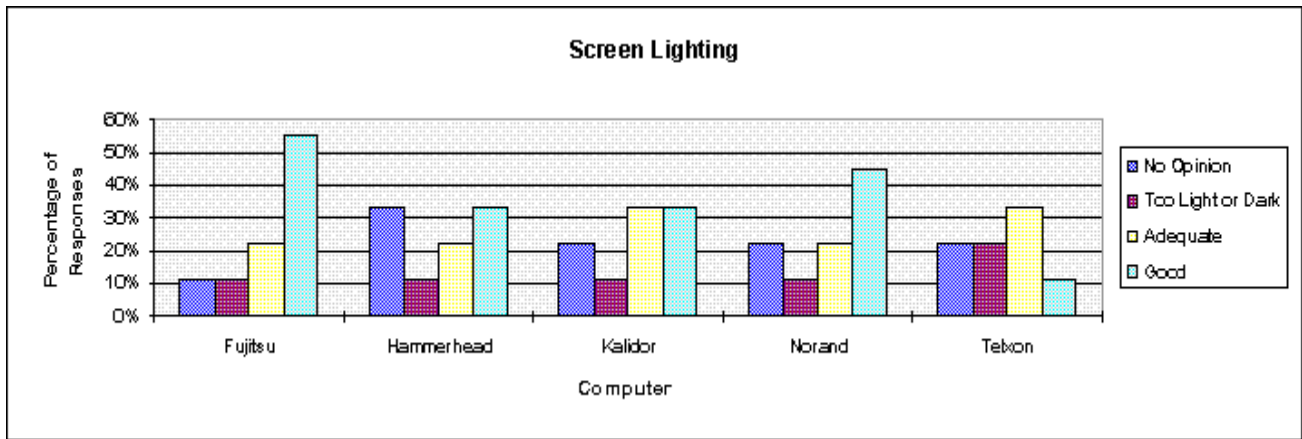
**Figure 6.13 Inspector Evaluation of Screen Size by Computer**



While screen lighting is an important consideration, nearly all pen computers incorporate similar types of technology that accommodate various lighting conditions. A back or side light can be used to brighten the display when working in a darkened area. This additional lighting can be turned off when in a brightly lit area. While bright sunlight can washout the display due to glare, inspectors did not seem to have a problem with this. In general the inspectors were generally satisfied with the screen lighting on all the computers, except the Telxon. As shown in **Figure**

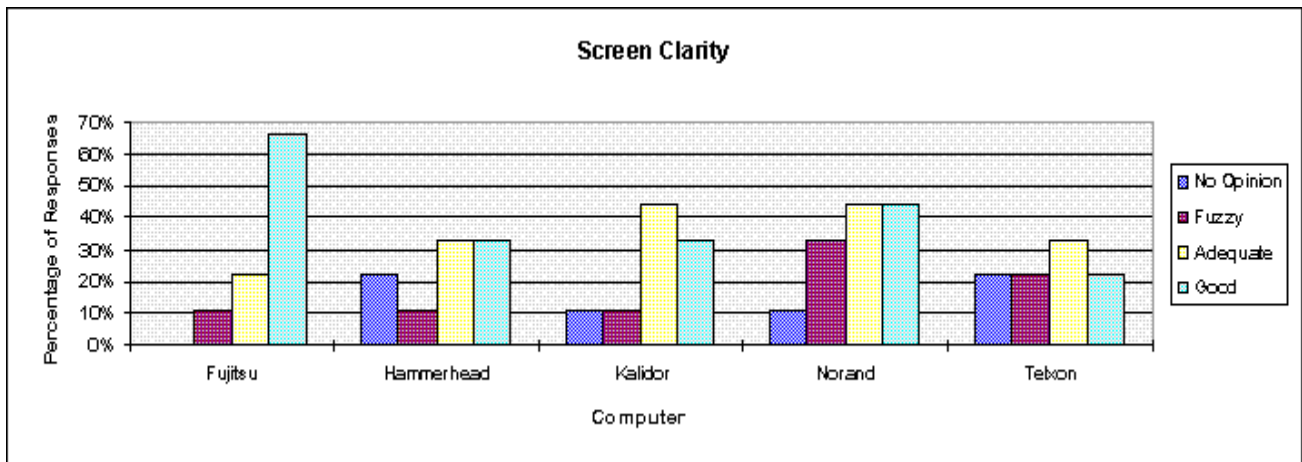
6.14, the Fujitsu was rated most favorably on this feature.

**Figure 6.14 Inspector Evaluation of Screen Lighting by Computer**



The clarity, or sharpness, of the screen display was also evaluated by the inspectors for each of the five brands of pen computers. **Figure 6.15** charts the percentage of responses for each brand. The inspectors were generally satisfied with the clarity of the screens on all machines. Once again, the Fujitsu was rated the best on this dimension.

**Figure 6.15 Inspector Evaluation of Screen Clarity by Computer**



### Durability and Weight

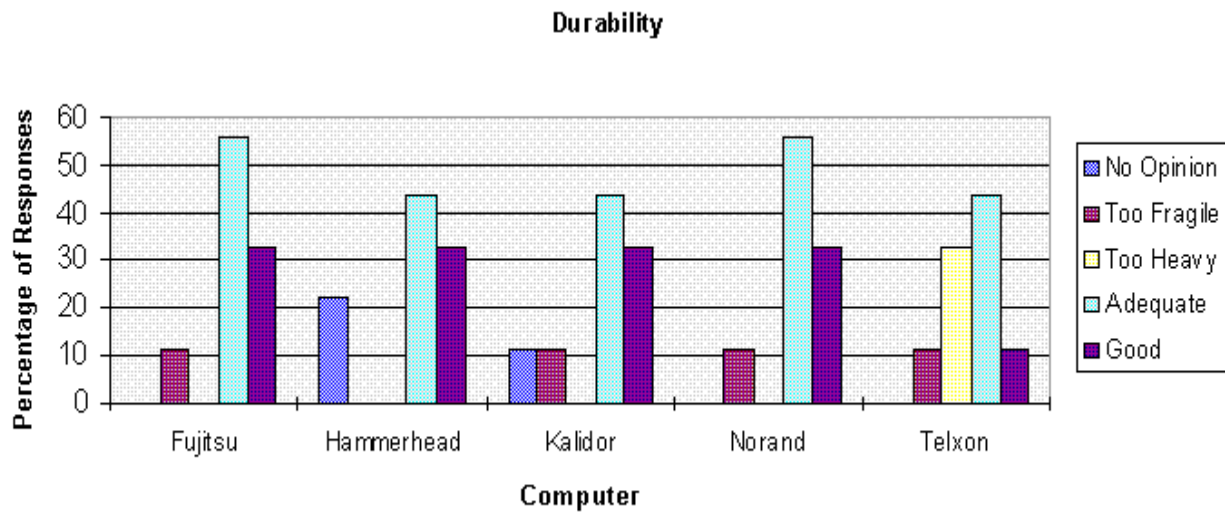
Weight and durability of a computer tend to be inversely related. The more rugged computers are generally heavier. Although all computers incorporated some design aspects with increased ruggedness, inspectors were not fully briefed on the internal ruggedness features of units. Therefore the inspector's ratings indicate perceived durability. **Table 6.7** summarizes the overall unit dimensions, weight of the unit (including battery), and more rugged features of each of the five units. The type of case provided for each unit is also included in the table, since case type may affect the perception of unit durability.

**Table 6.7 Summary of Features for the five pen computers evaluated.**

	<b>Fujitsu Stylistic 500</b>	<b>Hammerhead 486</b>	<b>Kalidor K2100</b>	<b>Norand Pen*Key 6600</b>	<b>Telxon PTC-1184</b>
<b>Dimension</b>	7.2"x10.7"x1.5" 12.25"x9.5"x1.5"	11"x7.75"x1.5"	9.7"x6.4"x1.8"	10.1"x8.5"x2.1"	
<b>Weight</b>	2.6 lbs	4.0 lbs	3.35 lbs	4.0 lbs	4.0 lbs
<b>Case</b>	Plastic	Aircraft grade Aluminum	Rubber	Plastic	Plastic

A majority of the inspectors found these five machines were adequate in weight and durability (see **Figure 6.16**). However, the number of adequate responses was greater than the number of good responses for all types. Combining this result with the fact that the Telxon PTC-1184 was the only model that was rated as being too heavy (33%) suggests that inspectors would like the machines to be a little more durable. One inspector also rated this same unit as being too fragile. The Hammerhead was the only computer that did not receive any negative ratings (Too Heavy or Too Fragile).

**Figure 6.16 Inspector Evaluation of Durability/Weight by Computer**



### Overall Computer Speed

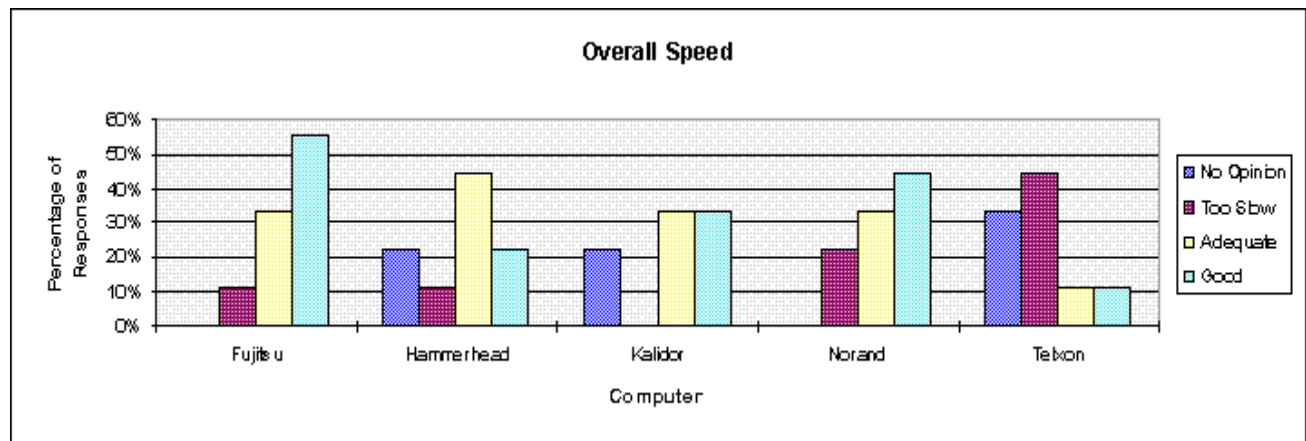
Perceived speed of a computer is important for end user acceptance. Processor type and speed, system configuration, amount of RAM, battery power management features, and stylus response all have an impact on system response time to user input. No attempt was made to optimize or change the default power management features for any of the units. **Table 6.8** summarizes the basic configuration for each of the five computers. Software demands also effect response time, but all units were configured with the same operating systems, handwriting recognition software (except the Norand) and application software.

**Table 6.8 Basic configuration for the five pen computers.**

	<b>Fujitsu Stylistic 500</b>	<b>Hammerhead 486</b>	<b>Kalidor K2100</b>	<b>Norand Pen*Key 6600</b>	<b>Telxon PTC-1184</b>
<b>Processor</b>	486 DX2 SL	486 DX	486 SLC	486/DX2	486 SLC
<b>Speed</b>	50 MHz	33MHz	50 MHz	50 MHz	25 MHz
<b>RAM</b>	8 MB	8 MB	8 MB	16 MB	3 MB
<b>Hard drive</b>	170 MB PCMCIA Type III	170 MB Shock Tolerant Hard Drive	170 MB	170MB PCMCIA Type III	60 MB
<b>Stylus Type</b>	Active	Active	Passive	Active (touch screen optional)	Active

As shown in **Figure 6.17**, the Fujitsu, Norand, and Kalidor (all 486/50mhz units) were rated the most favorably on overall speed. The Hammerhead (at 33mhz) was not far behind with two-thirds of the inspectors rating it adequate or good. The Telxon, with the slowest processor and least memory, was rated as being unacceptably slow by nearly half of the inspectors.

**Figure 6.17 Inspector Evaluation of Speed by Computer**



### Battery Replacement and Battery Life

For a high-end application being used nearly continuously, battery technology has not advanced to a level where an entire shift can be covered on a single battery. In a 24-hour maintenance environment, battery issues are important. While an eight hour battery would be desirable, the initial pilot study showed that the inspectors work in two-hour blocks. During breaks and meals, the units were returned to the planning area for security reasons. Thus inspectors were asked to initiate uploading the data and to recharge/replace batteries prior to going on breaks. Consequently, for this application, two hour battery life would be sufficient.

**Table 6.9** summarizes the battery related information for each of the models evaluated. Battery life and time to recharge are based on vendor provided specifications. Battery life in actual usage will depend on many factors, including amount of application usage, backlight usage, and power management features.

<b>Table 6.9 Battery Related Characteristics</b>					
	<b>Fujitsu Stylistic 500</b>	<b>Hammerhead 486</b>	<b>Kalidor K2100</b>	<b>Norand Pen*Key 6600</b>	<b>Telxon PTC-1184</b>
<b>Battery Type</b>	Lithium Ion	Nickel-Metal Hydride	Nickel-Metal Hydride	Lithium Ion	Nickel Cadmium
<b>No. in Unit</b>	2	1	1	1	1
<b>Battery Life</b>	2 hours continuous operation;	2.5-4 hours continuous runtime w/out power management	2 hours continuous operation; 6-8 hrs. with power savings	5 hours	2-4 hours
<b>Time to Recharge</b>	1.5 hrs - 90% 3 hrs - 100%	1 hour	2 hours	1.5 hrs	
<b>External charger?</b>	Yes	No*	Yes	Yes	Yes
<b>Hot change?</b>	Yes	No	Yes	Yes	

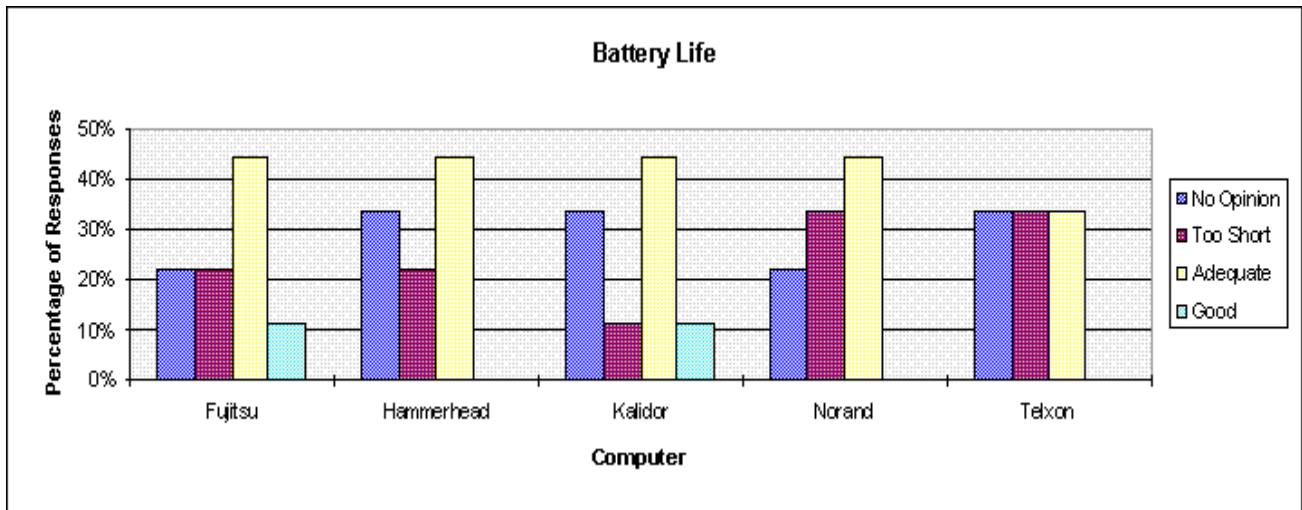
Since all units are rated for at least two hours of continuous usage, the most important consideration is the ability to charge batteries with an external charger. An external charger permits extra batteries to be charged and carried around as spares. The Hammerhead is the only unit that does not currently permit external charging. It was designed with the battery sealed in the unit and has been tailored to the "traveling salesman" model: work for a while, then dock the machine in a vehicle dock for recharging before the next use. The next issue of importance is the ability to change the battery without applying AC power to the unit. This feature, referred to as "hot changing" of batteries, allows the inspector to swap batteries on the job site. One issue that has been resolved by improvements in battery technology related to fully discharging batteries before recharging. In the past, batteries had to be fully discharged before re-charging

The results for battery life and battery replacement are shown in **Figure 6.18** and **Figure 6.19**. Unfortunately the results are not very informative because the structure of this second pilot study was not particularly conducive to evaluating these parameters. With inspectors swapping machines every hour during a single shift, inspectors did not get the opportunity to change batteries on every unit. In fact, some inspectors may have been biased against a machine which just happened to need the battery changed during their turn to use it. Nor did the study allow the inspectors to get a true sense of how often the battery would need to be changed during continuous usage. Since there were more units than inspectors, when a computer was not in use,

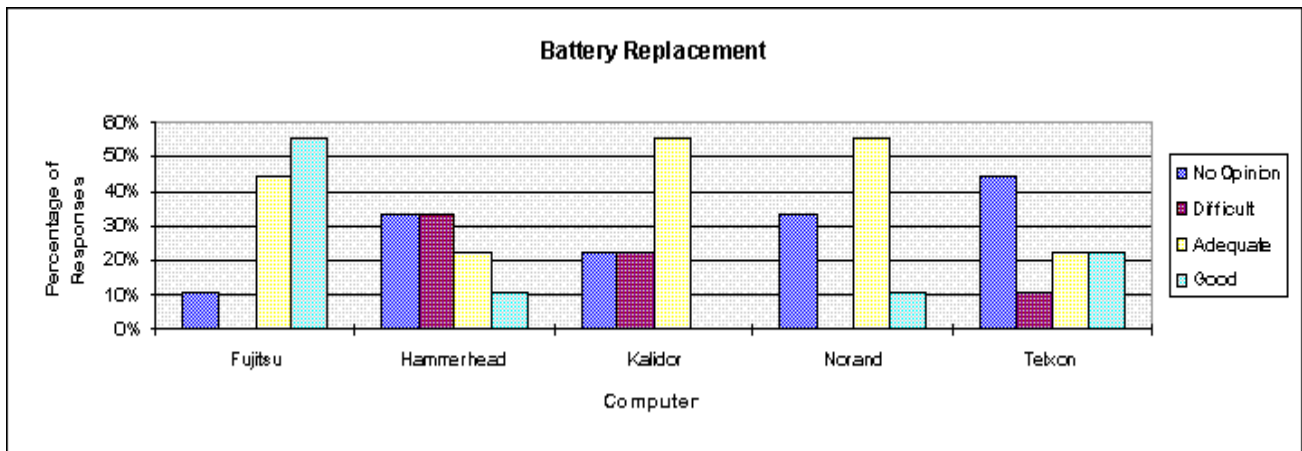


external AC power was supplied to charge the unit.

**Figure 6.18 Inspector Evaluation of Battery Life by Computer**



**Figure 6.19 Inspector Evaluation of Battery Replacement by Computer**



### Ease of Carrying

In general, the pen computers are similar in size to the clipboards currently used by the inspectors, although the computers are more fragile and somewhat heavier. Therefore, the inspectors were asked to rate each unit on how easy/comfortable it is to carry around on the job. Most of the units include handles and/or shoulder straps to aid in carrying the unit, either as part of the computer case itself or as a separate carrying case. Some units also include hand straps to aid in holding the unit during usage. **Table 6.10** summarizes these features for each of the five pen computers. It should be noted that the external cases were made available, but the inspectors were not required to use them. Most inspectors opted to use the carrying cases.

**Table 6.10 Summary of Carrying Case Features**

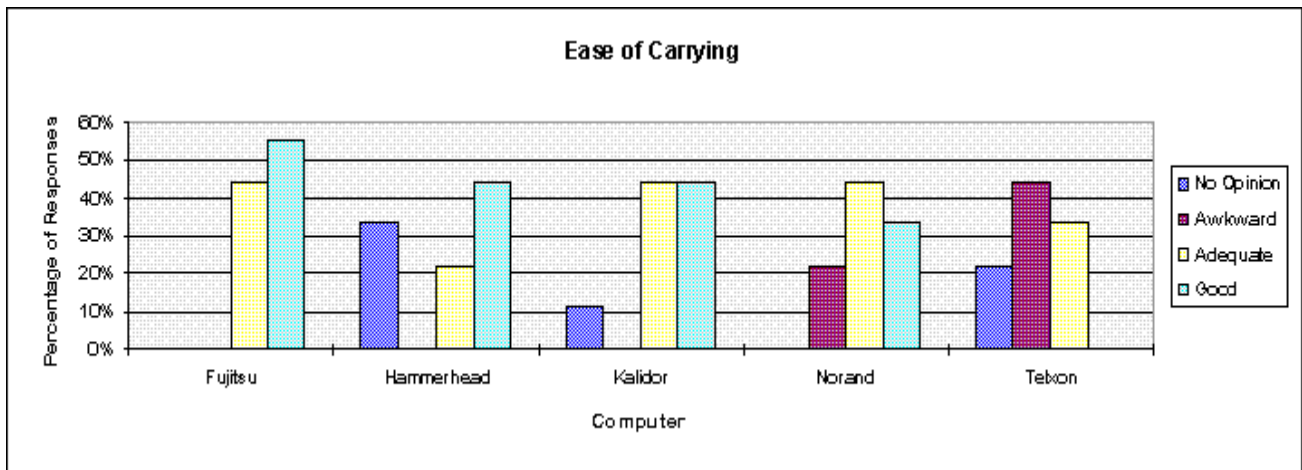
Fujitsu	Hammerhead	Kalidor	Norand	Telxon
---------	------------	---------	--------	--------



	Stylistic 500	486	K2100	Pen*Key 6600	PTC-1184
<b>Unit</b>	Stylus Holder	Stylus Holder	Stylus Holder	Handle Shoulder Strap Stylus Holder	Shoulder Strap Hand Strap Stylus Holder
<b>Case</b>	Handle Shoulder Strap Hand Strap Stylus Holder	Handle Shoulder Strap Stylus Holder	Shoulder Strap	None	None

The inspector evaluation results for ease of carrying the various pen computers are summarized in **Figure 6.20**. In general, the Fujitsu and Kalidor were rated most favorably on this feature, while the Telxon was rated poorly. The poor rating for the Telxon may have been influenced by the overall size and weight of the unit rather than the carrying features themselves. It is not apparent why the inspectors preferred the Fujitsu and Kalidor units. However, it may have something to do with familiarity with the units. In fact, the inspectors were much more favorable on this dimension in the second pilot study compared to the first (in which only the Fujitsu and Kalidor were evaluated). This change of opinion suggests that inspectors needed some time adjusting to the new tool before they became comfortable carrying it around instead of a clipboard.

**Figure 6.20 Inspector Evaluation of Ease of Carrying by Computer**



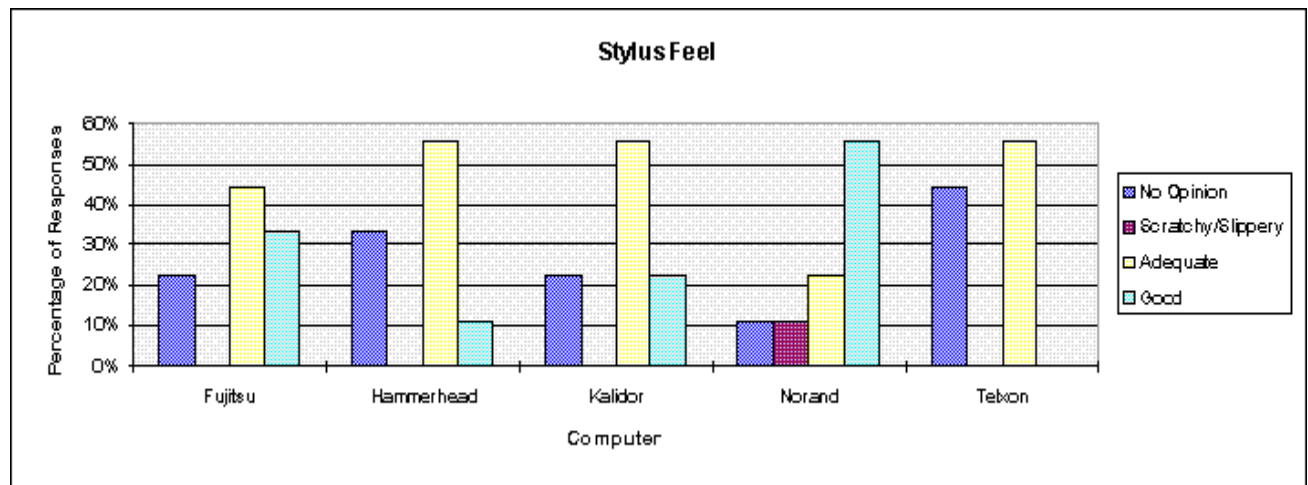
### Stylus Feel

One of the appeals of a pen computer is that they use a pen stylus, instead of a keyboard or mouse device, which is more similar to the way people currently record information on paper. However, not all styluses have the same "feel" when used on a pen computer screen. **Table 6.11**

summarizes the objective features of a pen stylus. An active stylus contains one or more batteries and are considerably more expensive than a passive stylus. Some of the vendors provide a tether that attaches the stylus to the pen computer by a lanyard or cord. The Norand was the only unit that was with the tethered configuration. The **Figure 6.21** summarizes the inspectors' subjective rating of stylus feel. The Norand stylus was preferred over all others.

Table 6.11 Summary of Stylus Features					
	Fujitsu Stylistic 500	Hammerhead 486	Kalidor K2100	Norand Pen*Key 6600	Telxon PTC-1184
Type	Active	Active	Passive	Active (touch screen optional)	Active
Tethered	No	No (Optional)	No	Yes	No (Optional)

Figure 6.21 Inspector Evaluation of Stylus Feel by Computer



### Trade-off Results

In addition to ranking the performance of specific computer brands, inspectors were asked to identify trade-offs they would make in the characteristics of the pen computers. Because each desirable feature often has negative side-effects, trade-offs are important in evaluating pen computers. Inspectors were asked for their preferences in eight categories:

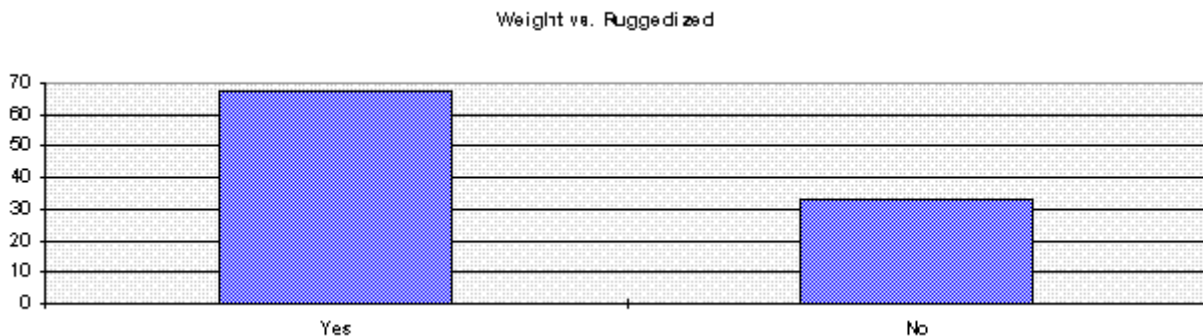
- weight vs. ruggedness
- weight vs. screen size
- keyboard vs. imperfect handwriting recognition

- tethered pen vs. untethered
- case vs. no case
- printed stickers vs. handwritten stickers
- barcode reader vs. no barcode reader

### Weight vs. ruggedness

As noted earlier, inspectors generally gave the computers an adequate or good rating for durability/weight (see **Figure 6.16**). However the lower number of "Good" (compared to adequate) responses and the lower number of "Too Heavy" (compared to fragile) responses suggest that inspectors would like machines to feel a little more durable. This was shown to be the case when inspectors were asked if they would trade of added weight (1-2 lbs) for more ruggedization. As shown in **Figure 6.22**, 67% of the inspectors said they would accept added weight for a more rugged computer. A common reason for this response was a concern for the cost of repairing/replacing the pen computers.

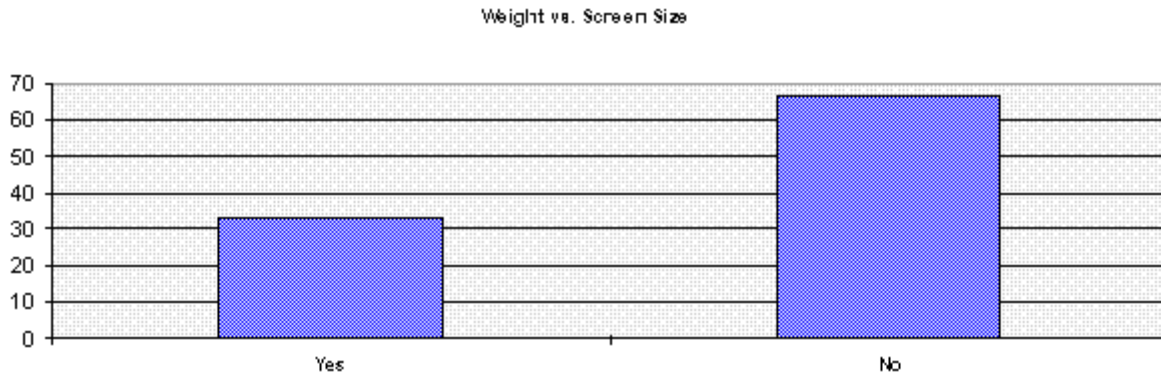
**Figure 6.22 Would you be willing to use a machine that is heavier (1-2 lbs) in order to get a more rugged unit?**



### Weight vs. screen size

Weight vs. screen size did not have the same results as weight vs. ruggedness. When asked if they would trade added weight for larger screen size, 67% of the inspectors said "No" (see **Figure 6.23**). This seems surprising since the initial screen size results are similar to ruggedness (more adequate than good). However, of the three computers with the larger screen size (Hammerhead, Fujitsu, and Telxon) there was only one "Too Small" response. In addition, the Hammerhead received more "Good" than "Adequate" votes. This suggest that screen size within the larger range (8" - 9.5") is acceptable, but the pen-computer should not have significant added weight for this size.

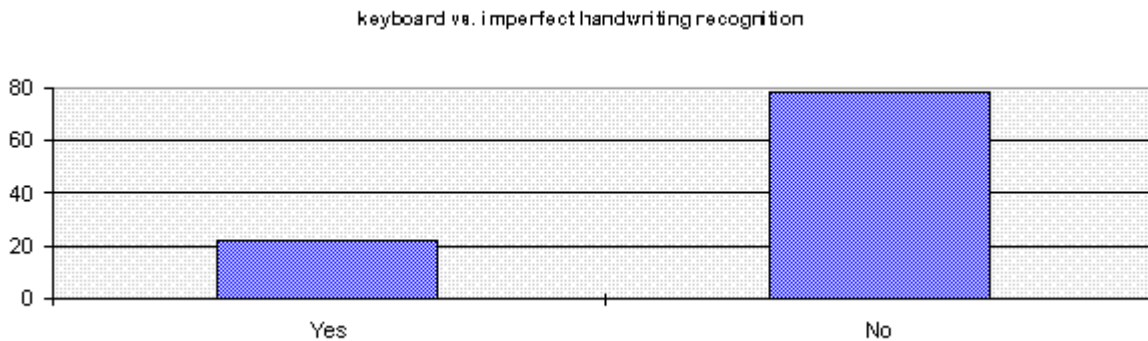
**Figure 6.23 Would you be willing to carry around a heavier machine (1-2 lbs) in order to have a larger screen?**



**Keyboard vs. imperfect handwriting recognition**

Although many inspectors expressed dissatisfaction with the performance of the handwriting recognition software, only two (22%) stated they would prefer to carry a keyboard. One of them is a trained typist and feels that typing would improve speed. Generally, inspectors do not want to carry a keyboard while performing their inspections. Most felt it would be cumbersome and get in the way. A few felt the on-screen keyboard was sufficient.

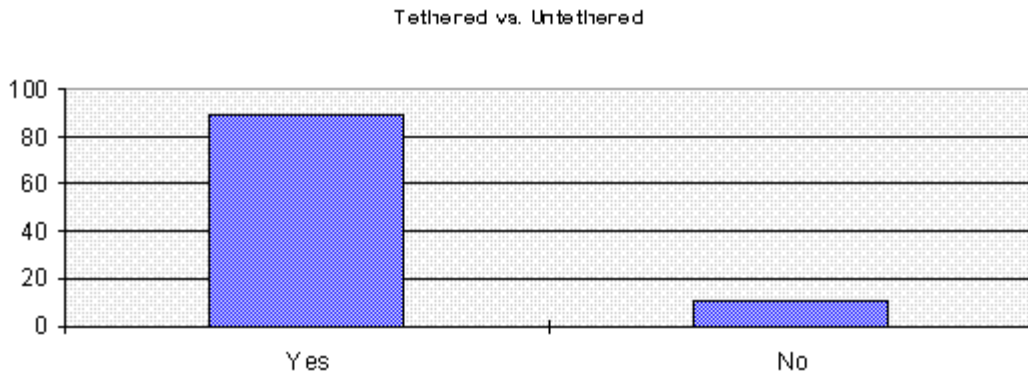
**Figure 6.24 Assuming that handwriting recognition cannot be improved substantially, would you prefer to use/carry around a portable computer with a keyboard rather than just use the pen stylus and on-screen keyboard?**



**Tethered pen vs. untethered**

Inspectors overwhelmingly preferred a tethered pen (89%) to an untethered pen (11%). Nearly all inspectors were concerned with dropping or loosing the pen. The only non-tethered voter felt that the tether got in the way.

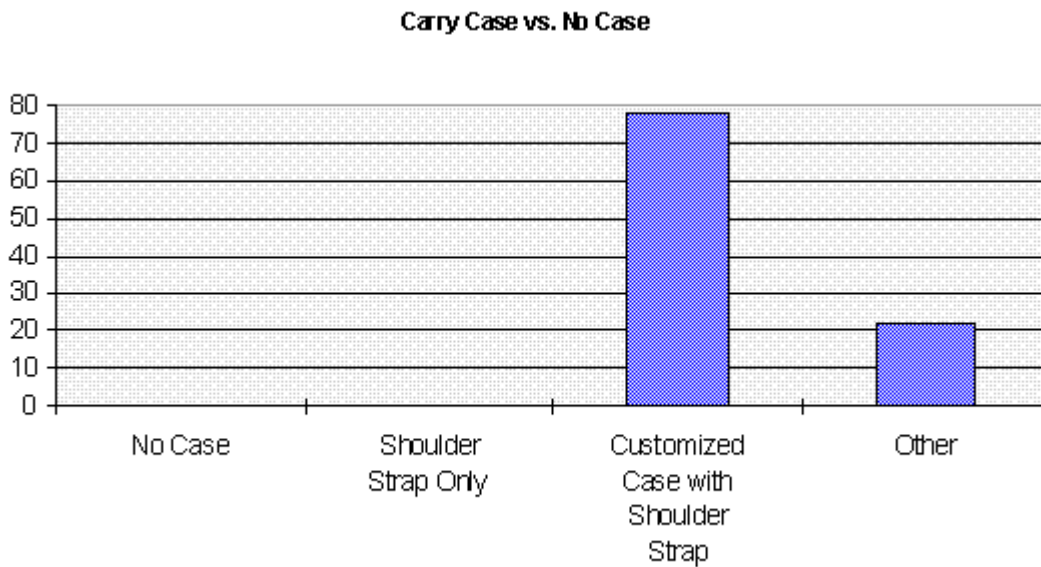
**Figure 6.25 Would you prefer to have the pen stylus tethered to the machine rather than loose?**



**Case vs. no case**

All inspectors preferred a case to carry the pen computer. Seventy-eight percent stated that they would prefer a case with a shoulder strap. The 22% that choose "Other" preferred a case with a handle. Inspectors feel that a case will help protect the computer against damage. One inspector also liked to carry additional objects in the case (pens, job cards, etc.).

**Figure 6.26 Which would you prefer?**

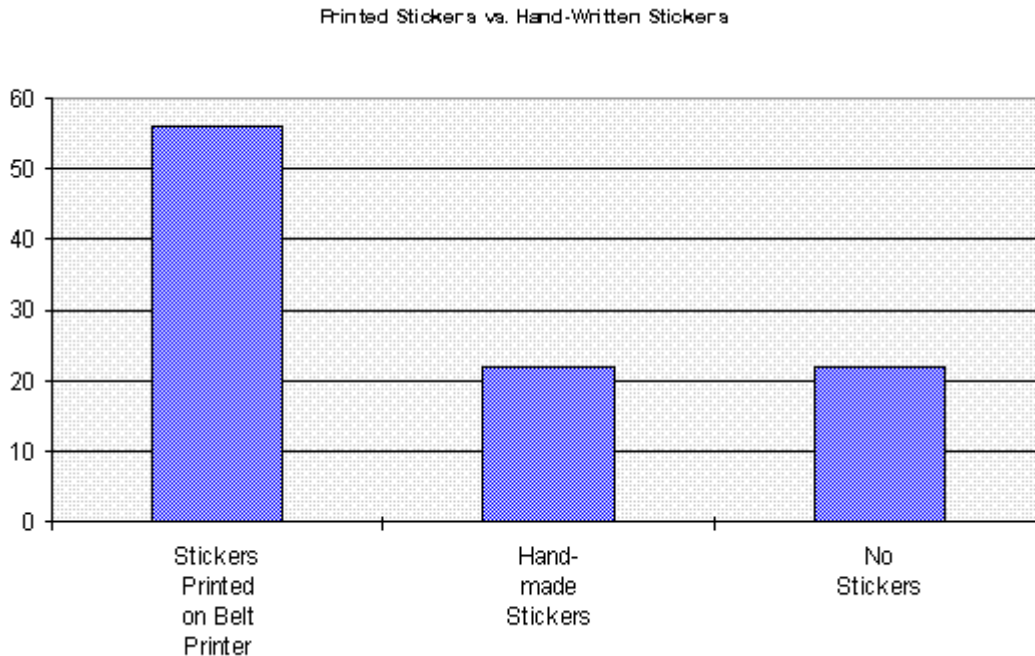


**Printed stickers vs. handwritten stickers**

Presently, when inspectors record a non-routine write-up they mark the location of the item with a sticker that contains the write-up number. These stickers come printed on the current paper non-routine write-up forms. When the pen computer-based write-up is incorporated, an alternative method of locating the write-up item must be used. A majority of the inspectors

(56%) preferred to use "stickers printed on a belt printer". Many of them, however were concerned that the computer should not become too heavy or cumbersome. Twenty-two percent of the inspectors preferred to use "hand made stickers" and the same amount (22%) preferred to use the location information used in the write-up.

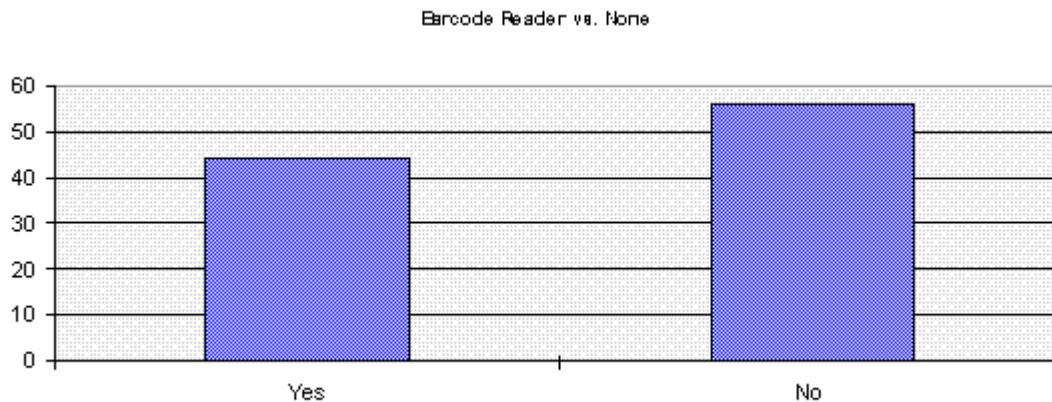
**Figure 6.27 Which would you prefer?**



**Barcode reader vs. none.**

A barcode can often serve as a convenient input device. This may be especially true when you consider the imperfections in handwriting recognition. However, a barcode reader also adds extra weight and size to the pen computer system. When asked, inspectors were mixed on carrying a bar-code reader. Forty-four percent preferred not to carry a barcode reader while 55% preferred to carry one. As expected, nearly all inspectors were concerned with size and weight of the barcode reader. Inspectors voting "Yes" either believed it would not add much size/weight to the computer or made this a stipulation. Inspectors voting "No" generally believed that the computer would become too big or bulky.

**Figure 6.28 Would you be willing to carry a small, portable barcode reader attached to the pen computer in order to enter barcode information (e.g. , job card #, write-up #, login) rather than write/type it in?**



## 6.6 LESSONS LEARNED

### 6.6.1 Loaners vs. Buying

In the process of completing this project, a considerable amount of effort was required to obtain pen computers for use in the field evaluation. One of the major constraints in this effort, was the need to obtain "loaner" or "evaluation" units for testing. From the airline's perspective, it is unreasonable to purchase one or two units of several different brands in order to determine which one meets their needs. From the pen computer vendor's perspective, it is not practical to lend units to every potential customer for several weeks or months. As a result, some vendors were unable to provide units for the evaluation. In some cases, the vendors initially provided units that were unreliable engineering samples that did not give a good representation of their products capability. Also, when you opt for the loaner route, you can only *request* a particular configuration for a loaner. When you purchase, you have much more control over what configuration and peripherals you get. Finally, a unit that is "loaned" may not command the same resources in terms of vendor support on technical issues. Given these trade-offs, it may be cost-justifiable to purchase units for evaluation purposes rather than dealing with the limitations and the hassles of loaners.

### 6.6.2 Support for System Configuration and Administration

Vendors that supplied "loaner" computers, often did not provide the units until the last minute. In some cases, not all of the system administrative support and maintenance items that were required for the fielding, such as keyboards, floppy drives, and external battery chargers were readily available. While this may seem like a minor inconvenience, it was very apparent from this experience that system administrative support should be a major consideration in selecting an appropriate system. These units often employ non-standardized connections; hence, specialized adapters or peripherals must be obtained from the vendor to make system configuration and support feasible.



### 6.6.3 Nothing is Standard in Pen Computer Hardware (even Standards)

Every pen computer included in this study had some specialized feature about it. Everything from the type of keyboard port, to the power management features, to the rebooting procedure, to the battery is customized to the machine. Even the PCMCIA standard is not completely standard, that is, some units had lists of approved brands of PCMCIA network cards that could be used with their machine. While this problem is a slight annoyance when fielding a single brand of computer, the problem magnifies greatly with every additional unit. This is a fact of hardware evaluation that cannot be avoided; however, it should provide caution to those who consider fielding multiple brands for operational use.

### 6.6.4 Evolution of Technology is Inevitable

The brands and features of pen computers that were available for this study will most likely be replaced by a new generation of computers in a relatively short period of time, perhaps in as little as six months. This evolution of technology is typical for the computer hardware and software age. In addition, the pen computer industry has not yet stabilized in terms of vendors. Therefore, there are little assurances that any particular vendor will still be manufacturing and supporting pen computer technology a year or two from now. These facts make it difficult to know when to purchase such specialized hardware. The approach taken in this effort helped to minimize the effect of hardware evolution. That is, the system was developed for a standard operating system. As hardware capabilities increase, the software is easily moved to the new platform.

## 6.7 SUMMARY AND OPTIONS FOR NEXT STEP

The Pen Computer Non-Routine Repair (NRR) Write-up System was shown to be a feasible system in Phase I. However, the system was designed to be a proof-of-concept system rather than a system for immediate implementation. In order for the system to be minimally functional in operation, there are some additional issues that need to be addressed. The following describes various options that could be pursued at this point.

### Option 1: Implement Laser printed forms ONLY

The initial proposal for the Pen Computer NRR Write-up System was justified on the cost savings of printing write-ups on normal laser paper as opposed to the current specialized 4-ply printed form. This cost savings could be realized with minimal additional investment by putting into use the laser printed forms as designed and printed by the NRR Write-up System.

- **Additional Hardware Required**: No additional hardware is required to implement this option. These forms can be printed using the double-sided laser printer that was purchased for the project. The software runs on any existing PC-compatible desktop computer.

- **Additional Software Required:** A minor adjustment would need to be made to the Host software to allow easy printing of a large number of blank forms with sequential write-up numbers. The beginning and ending number could be input by the user. If any changes are desired in the format or content of the blank form (prior to or after implementation) software changes would be needed to accomplish the changes.
- **Additional Training/Procedural Changes:** New procedures need to be constructed for handling the new paper documents. Appropriate parties must be re-trained per the new procedures
  - Who is going to be in charge of printing documents?
  - Who is going to communicate the write-up number sequence for a given aircraft?
  - Who is going to distribute documents?
  - Are write-ups going to be assigned to different write-up boards based on the sequence number or will all inspectors become "Rovers" as with the Pen Computer system?
- **System Support Personnel Required:** Personnel must be assigned responsibility to support the laser printer.

## Option 2: Implement Pen Computer System in 747 Bay only

The scope of the current software was limited to a classic 747. Therefore, there is NO support for making write-ups on any other fleet type. Fielding the system in the 747 Bay would require the least amount of development and equipment investment.

- **Additional Hardware Required:** Pen computers and peripherals (batteries, battery chargers, etc.) for one Bay. Ethernet cables and power hook-ups. NOTE: Phase 2 implementation may select DIFFERENT hardware for **RF** capabilities than would be selected for immediate implementation in network configuration.
- **Additional Software Required:**
  1. Add graphics - Inspectors have indicated that the current level of graphics in the software supports Zone selection for 747 classic, but does not cover all 747 models and series. In addition, the system does not provide all of the graphics that they currently reference during inspections. Panel and Station charts would need to be added to the software OR inspectors would need to carry the paper copies of these graphics. None of the pen computers or their cases provide a convenient place to store such paperwork. Custom cases may be an option if desired.
  2. Database expansion: the UAL provided database of Major and Submajor zones is not complete. Inspectors would like additional choices for handling such locations as external fuselage, as in the case of lightning strikes. In addition, inspectors have asked for larger field lengths for specific items and defects. Also, any additional zone information needed to handle non-classic 747 a/c would also be needed.
  3. Rule modification: the current software rules require the inspector to fill in data in the

corrosion task # field whenever corrosion is indicated as the defect. Inspectors have pointed out that the corrosion task # is not needed if corrosion is noticed during an inspection controlled by a C-check inspection job card.

4. Additional functionality: There are several items that have been requested in order to make the system usable for full operation or more user-friendly. Listed below are some of these options:

- Add functionality to handle write-up's for removal of parts/robbing or parts rather than defects
  - Add functionality to handle planner/analyst write-ups generated from analysis of log book items
  - Add functionality to handle additional security measures (i.e., limit user to one machine at a time).
  - Add customized on-screen keyboard.
  - Add functionality to retrieve handwriting recognition profile for current user.
  - Add screen customization option for left-handed users
- **Additional Training/Procedural Changes**
    1. New procedures need to be constructed for handling the new paper documents (same as Option 1)
    2. Appropriate parties must be re-trained per the new procedures.
    3. All inspectors in targeted bay would require training on the pen computer system.
    4. Must decide who is going to have access to the Host software and then provide training accordingly.
  - **System Support Personnel Required:** Personnel must be assigned responsibility to support the laser printer, pen computer equipment, Host, and associated software.

### **Option 3: Implement Pen computer system for all fleet types**

This option expands on Option 2 by expanding the system capability to include all fleet types handled by United Airlines. All issues raised above would have to be addressed for this option as well. In addition, this option would require additional resources in all categories to handle the added scope of implementing the system for all fleet types and all bays.

### **Option 4: Add Functionality, User Groups, Technology**

This is the most ambitious option of all. It basically constitutes a complete new phase of effort that would require specification of the additional functionality desired. This specification should take into account the needs of additional user groups (e.g., lead mechanics, planners) and may include consideration of additional technology (e.g., wireless communications).

## 6.8 ACKNOWLEDGEMENTS

We wish to acknowledge and thank all of the members of the United development team as well as the inspectors who participated in this study.

## 6.9 REFERENCES

Layton, C., (1995 in press) Job Aiding: Performance Enhancement System. *Human Factors in Aviation Maintenance, Phase V: Progress Report*, (contract No. DTFA01-94C0103).

## 6.10 APPENDICES

### 6.10.1 Appendix A - Questionnaires Used in Study

#### *User Background Form*

INSPECTOR # \_\_\_\_\_

Thank you for agreeing to participate in the Pen Computer Non-Routine Repair Write-up System Pilot Study. Please complete the following information so that we can describe the general background of participants in this study. The information that you provide on this and other feedback forms will be used for two purposes: (a) to aid in planning improvements/ changes to this system in the future and (b) to complete reports for the FAA Office of Aviation Medicine Human Factors program on the performance of the hardware and software aspects of this system.

#### PART A

Number of years at United: \_\_\_\_\_ Number Years as an Inspector: \_\_\_\_\_

Have you ever used an IBM compatible PC before?                      Yes                      No

If yes, how long?                      \_\_\_\_\_                      months/years (circle one)

Have you ever used Microsoft Windows software?                      Yes                      No

What shift are you working?      1                      2                      3

Age: < 25                      26-35                      35-45                      35-45                      45-55

Did you participate in the initial Pilot study?      Yes      No

**PART B (To be completed during the pilot study)**

Circle Inspection Job-cards worked. Indicate Unit used for each:

F= Fujitsu      H=Hammerhead      K=Kalidor      N=Norand      T=Telxon

- |  |   |
|--|---|
| <input type="checkbox"/> GALLEY/LAV SUPT STRUCTURE-INSP  | <input type="checkbox"/> TAIL COMPT ZONE 315/316 INSP       |
| <input type="checkbox"/> FWD BLKHD AND RADOME INSPECT    | <input type="checkbox"/> HORZ STAB CENTER SECTION INSP      |
| <input type="checkbox"/> AIR COND COMPT - INSPECTION     | <input type="checkbox"/> TAIL COMPT ZONE 311/312 INSP       |
| <input type="checkbox"/> KEEL BEAM AREA - INSPECTION     | <input type="checkbox"/> #2 L/H MED EMER ASSIST BTL<br>DATE |
| <input type="checkbox"/> BULK CARGO COMPARTMENT INSPECT  | <input type="checkbox"/> COCKPIT WINDOWS INSPECT            |
| <input type="checkbox"/> FUSELAGE BILGE INTERNAL INSP    | <input type="checkbox"/> CHECK MAIN DECK ATTNDT'S<br>SEATS  |
| <input type="checkbox"/> CHECK ATTND'S SEAT UPPER DECK   | <input type="checkbox"/> LH WLG WHEEL WELL INSPECTION       |
| <input type="checkbox"/> MAIN ENTRY DOOR RH INSPECT      | <input type="checkbox"/> LH WING LNDG GEAR INSPECTION       |
| <input type="checkbox"/> M.E.D. CRACK CHECK - 2LH        | <input type="checkbox"/> ATTENDANTS SEAT CHECK              |
| <input type="checkbox"/> MAIN ENTRY DOOR LH INSPECT      | <input type="checkbox"/> FWD CARGO COMPARTMENT<br>INSPECT   |
| <input type="checkbox"/> AFT CARGO DOOR AND FITTING INSP | <input type="checkbox"/> INSPECT NOSE WHEEL WELL            |
| <input type="checkbox"/> LT WING FLAP TRACK FAIRING-INSP | <input type="checkbox"/> E&E COMPT LADDER-INSPECT           |
| <input type="checkbox"/> LH WING EXTERIOR SURFACES-INSP  | <input type="checkbox"/> PITOT STATIC PROBE INSPECTION      |
| <input type="checkbox"/> LH WING UPPER SURFACE-INSPECT   | <input type="checkbox"/> RH LOWER FUSELAGE INSPECT          |
| <input type="checkbox"/> LH WING LEADING EDGE INSPECT    | <input type="checkbox"/> LH LOWER FUSELAGE INSPECT          |
| <input type="checkbox"/> VERTICAL STABILIZER - INSPECT   | <input type="checkbox"/> EXT LWR FUSELAGE INSPECT           |
| <input type="checkbox"/> APU COMPT ZONE 317/318 INSP     | <input type="checkbox"/> NLG W//W STRUCTURAL INSPEC.        |
| <input type="checkbox"/> NOSE GEAR/WHEEL WELL INSPECT    | <input type="checkbox"/> NOSE GEAR AREA INSPECTION          |

***Hardware Evaluation Form***

INSPECTOR # \_\_\_\_\_

Compare the basic hardware features of the pen-computers used in this pilot study. For each model, place a check mark in the box of the choice that applies for each evaluation criteria. Rank the models from 1 (best)

to 5 (worst) in overall performance on the last line of the table.

<i>Evaluation Criteria</i>	<i>Choices</i>	<i>Fujitsu Stylistic 500</i>	<i>Hammer- head 486</i>	<i>Kalidor K2100</i>	<i>Norand 6600</i>	<i>Telxon PTC-1184</i>
<b>Screen Size</b>	Too Small Too Large Adequate Good					
<b>Durability/ Weight</b>	Too Fragile Too Heavy Adequate Good					
<b>Overall Speed</b>	Too Slow Adequate Good					
<b>Screen Lighting</b>	Too light or dark Adequate Good					
<b>Screen Clarity</b>	Fuzzy Adequate Sharp					
<b>Battery Life</b>	Too Short Adequate Good					
<b>Battery Replacement</b>	Difficult Adequate Easy					
<b>Ease of Carrying</b>	Awkward Adequate Comfortable					
<b>Stylus Feel</b>	Scratchy/Slippery Adequate Good					
<b>Overall</b>	Poor Adequate Good					
<b>RANKING</b>						

***Evaluation of Trade-offs Form***

INSPECTOR # \_\_\_\_\_

**PART 1**

**In selecting the best system for your environment and use, trade-offs may need to be made between two opposing traits. To help identify trait priorities, please answer the following questions by circling your answer and then explain the reason for your answer.**

**1. Would you be willing to use a machine that is heavier (1-2 lbs) in order to get a more ruggedized unit?**

Yes No

Why/Why not?

**2. Assuming that the handwriting recognition cannot be improved substantially, would you prefer to use / carry around a portable computer with a keyboard rather than just use the pen stylus and on-screen keyboard?**

Yes No

Why/Why not?

**3. Would you prefer to have the pen stylus tethered to the machine rather than loose?**

Yes No

Why/Why not?

**4. Which would you prefer:**

**Stickers printed on belt printer attached to pen computer**

**Hand-made stickers made using masking tape or "dots"**



**No stickers - rely on location information on write-up**

**Why?**

**5. Would you be willing to carry around a heavier machine (1-2 lbs) in order to have a larger screen?**

**Yes No**

**Why/Why not?**

**6. Which would you prefer:**

**No case**

**Shoulder strap only**

**Customized case with shoulder strap**

**Why?**

**7. Would you be willing to carry a small, portable barcode reader attached to the pen computer in order to enter barcode information (e.g., job card #, write-up #, login) rather than write/type it in?**

**Yes No**

**Why/Why not?**

## **PART 2**

**1. Describe the special environmental conditions in which the pen computer hardware must operate (ex: temp, vibration, corrosion, lighting, etc.).**

**2. Describe areas of the A/C where you had problems using the pen computer and explain why.**

3. What other areas of the A/C (areas you didn't work) do you foresee possible problems with operating the pen unit and explain why.

### ***Hardware Evaluation***

INSPECTOR # \_\_\_\_\_

1. Describe general features/functionality of pen computer hardware you liked.

2. Describe general features/functionality of pen computer hardware you would change (explain the desired change).

3. Describe model specific features/functionality you like.

**Fujitsu**

**Hammerhead**

**Kalidor**

**Norand**

**Telxon**

4. Describe model specific features/functionality you did not like.

**Fujitsu**

**Hammerhead**

**Kalidor**

Norand

Telxon

## ***Application Evaluation Form***

INSPECTOR # \_\_\_\_\_

This form requests your input on the Non-Routine Repair Write-up software application. Complete and return this form at the conclusion of the pilot study.

**QUESTIONS:** Complete the following questions by circling your response.

1. a. Which system do you prefer for making write-ups?  
Current paper system          Pen computer system  
  
b. Why?
  
2. a. What is your opinion of the Transfer portion of the program?  
Easy to Use          Adequate          Difficult to Use  
  
b. Why?  
  
c. Other comments
  
3. a. What is your opinion of the Write-up portion of the program?  
Easy to Use          Adequate          Difficult to Use  
  
b. Why?

c. Other comments

4. What are your comments on the laser printouts (ex: format, content, speed, etc.)?

***Priorities for Future***

INSPECTOR # \_\_\_\_\_

The current pen computer system is NOT a complete system. It supports initial NRR write-up creation for one aircraft type only. Prioritize the items below in terms of which would be make the Pen-Computer Non-Routine Repair System most useful to you.

H= High Priority M= Medium Priority L= Low Priority X= Undesirable

\_\_\_\_\_ On-line GN/MM

\_\_\_\_\_ On-line IPC

\_\_\_\_\_ On-line SRM

\_\_\_\_\_ On-line Panel Charts

\_\_\_\_\_ On-line Detailed Zone Charts

\_\_\_\_\_ On-line Detailed Station Charts

\_\_\_\_\_ On-line Job card and W/U Numbers

\_\_\_\_\_ Support for Buy-back

\_\_\_\_\_ Bar code reader attachment

\_\_\_\_\_ Physical keyboard attachment

\_\_\_\_\_ **Sticker Printer attachment**

\_\_\_\_\_ **OTHER** \_\_\_\_\_

\_\_\_\_\_

\_\_\_\_\_ **OTHER** \_\_\_\_\_

\_\_\_\_\_

\_\_\_\_\_ **OTHER** \_\_\_\_\_

\_\_\_\_\_

## 6.10.2 Appendix B Summary of User Responses

### *Summary of Hardware Evaluation*

<b>Evaluation Criteria</b>	<b>Choices</b>	<b>Fujitsu Stylistic 500</b>	<b>Hammer-head 486</b>	<b>Kalidor K2100</b>	<b>Norand 6600</b>	<b>Telxon PTC-1184</b>
<b>Screen Size</b>	<b>Too Small</b>		7	3,4,5	2,3,5	
	<b>Too Large</b>			2		
	<b>Adequate</b>	1,3,4,5,7,8,9	8,9	7,8,9	4,6,7,8	1,2,4,5,9
	<b>Good</b>	2,6	2,3,4,5	1	1,9	3,7
<b>Durability/ Weight</b>	<b>Too Fragile</b>	4		4	7	2
	<b>Too Heavy</b>					2,5,7
	<b>Adequate</b>	1,3,7,8,9	5,7,8,9	5,7,8,9	2,4,5,8,9	1,3,4,9
	<b>Good</b>	2,5,6	2,3,4	1,2,3	1,3,6	3

	<b>Too Slow</b>	1	9		2,3	4,5,7,9
<b>Overall Speed</b>	<b>Adequate</b>	5,8,9	4,5,7,8	4,5,7,8	7,8,9	3
	<b>Good</b>	2,3,4,6,7	2,3	1,3,9	1,4,5,6	2
	<b>Too light or dark</b>	1	9	3	3	1,4,9
<b>Screen Lighting</b>	<b>Adequate</b>	5,9	5,7	4,5,7	5,9	3,5,7
	<b>Good</b>	2,3,4,6,7	2,3,4	1,2,9	1,2,4,6	2
	<b>Fuzzy</b>	1	9	7	7	1,4
<b>Screen Clarity</b>	<b>Adequate</b>	5,9	4,5,7	1,4,5,9	1,5,9	3,5,9
	<b>Sharp</b>	2,3,4,6,7,8	2,3,8	2,3,8	2,4,6,8	2,7
	<b>Too Short</b>	4,9	4,7	4	4,6,7	4,7,9
<b>Battery Life</b>	<b>Adequate</b>	2,3,5,7	2,3,5,9	2,3,5,7	2,3,5,9	2,3,5
	<b>Good</b>	6		9		
	<b>Difficult</b>		2,3,5	3,5		5
<b>Battery Replacement</b>	<b>Adequate</b>	5,8,9	8,9	2,4,7,8,9	2,5,7,8,9	2,9
	<b>Easy</b>	2,3,4,6,7	7		3	3,7
	<b>Awkward</b>				5,7	1,2,3,5
<b>Ease of Carrying</b>	<b>Adequate</b>	1,4,7,9	4,9	3,4,7,9	2,4,6,9	4,7,9
	<b>Comfortable</b>	2,3,5,6,8	2,3,5,8	1,2,5,8	1,3,8	
	<b>Scratchy/Slippery</b>				3	
<b>Stylus Feel</b>	<b>Adequate</b>	2,4,6,9	2,3,4,7,9	2,3,4,7,9	2,9	2,3,4,7,9
	<b>Good</b>	3,7,8	8	1,8	1,4,6,7,8	
	<b>Poor</b>		8			4,5

<b>Overall</b>	<b>Adequate</b>	9	4,5,9	3,4,5,7,8	5,9	7,9
	<b>Good</b>	3,4,5,6,7,8	3	1,9	1,3,4,6,8	
<b>RANKING</b>		1 - 3,7	1 - 2	1 - 1,9	1 - 4	1
		2 - 2,4,5	2 - 3,5	2 - 5,7	2 - 1,9	2
		3 - 1,9	3 - 4,7	3 - 4	3 - 3	3
		4	4	4 - 3	4 - 2,5	4 - 1,7,9
		5	5 - 9	5	5 - 7	5 - 2,3,4,5
Inspector 6 rated only Fujitsu and Norand; did not rank						
Inspector 8 did not rate Telxon; Did not rank but could derive ranking from overall rating						

## ***Evaluation of Trade-offs Form***

**INSPECTOR # \_\_\_\_\_**

### **PART 1**

**In selecting the best system for your environment and use, trade-offs may need to be made between two opposing traits. To help identify trait priorities, please answer the following questions by circling your answer and then explain the reason for your answer.**

**1. Would you be willing to use a machine that it heavier (1-2 lbs) in order to get a more ruggedized unit?**

**Yes 3, 4, 5, 6, 7, 9**

**Why?**

**3 Could save a lot of money on repairing units**

**4 - It doesn't matter as long as it's durable**

**5 To get the most updated features**

**6 Given the cost of replacement and or repair, I don't feel that a heavier unit is a large price to pay.**

**7 Less damage [means] less down time**

**9 - A few more lbs would not affect the machines mobility**



No 1, 2,8

Why not?

1 - Carry around the whole aircraft, and won't fit some small corners.

2 - I feel the units are rugged enough. If an inspector can hang onto the machine, we need to change the carry handle/strap or council the Inspector.

8 - The machines at their current weight get noticeably heavy after 20 mins.

2. Assuming that the handwriting recognition cannot be improved substantially, would you prefer to use / carry around a portable computer with a keyboard rather than just use the pen stylus and on-screen keyboard?

Yes 6,9

Why?

6 - I would prefer the keyboard because I am a trained typist. It would greatly improve my w/u generating speed

9 - I feel that a regular keyboard would be easier to use then the on-screen keyboard; it is too tedious.

No 1,2,3,4,5,7,8,9

Why not?

1- It will be very inconvenient. Create a lot of problem.

2- On screen keyboard is good

3 - Using a keyboard in the locations that we inspect would not be practical. Laying down or kneeling you could not type

4 - It's awkward & uncomfortable

5 - Flip top could get broken

7 - keyboard already onboard

8 - the more moving parts the more to break

3. Would you prefer to have the pen stylus tethered to the machine rather than loose?

Yes - 1, 2,3,4,5,6,7,9

Why?

- 1 - This way the pen won't lose so easily.
  - 2 - Keeps the stylus from getting lost.
  - 3 - You know where the pen is.
  - 4 - To eliminate dropping and breakage
  - 5 - Harder to lose
  - 6 - I inadvertently dropped the pen with the Norand unit and was grateful that the pen was tethered. I was in the wheel well and would have had to climb down to retrieve it.
  - 7 - lost or breakage if not
  - 9 - less chance of losing it
- No - 8
- Why not?
- 8 - Norand had a tethered pen. It got in the way when writing.

4. Which would you prefer:

Stickers printed on belt printer attached to pen computer 1,2,4,5,7

Why?

- 1 - easy to use and convenient
- 2 - how heavy will this printer be?
- 4 - Easier for others to locate areas
- 5 - Mechanics are used to looking for stickers; easier to locate w/u's; saves time
- 7 - Needs **RF** & would help production locate w/u with w/u #

Hand-made stickers made using masking tape or "dots" 6

Why?

6 - Dots would be good. The mechanic is used to looking for a sticker, plus carrying around dots would prevent us from needing a belt printer on a pen base. P.S. We used dots quite a while ago and they work well.

9 - I think a roll of tape would be suitable because it [printer] would add extra weight & complexity to the machine

No stickers - rely on location information on write-up 3,7

Why?

3 - If charts are available, the information given on the w/u location should be easy

to find

7 - maybe a station on the wing and tail docks that would dispense the stickers or none at all. Keep the machine low maintenance.

5. Would you be willing to carry around a heavier machine (1-2 lbs) in order to have a larger screen?

Yes 3,4,7

Why?

3 - The handwriting recognition seems to work better on larger screen. It makes making the w/u easier

4 - Easy to read

7 - Bigger is better???

No 1,2,5,6,8,9

Why not?

1 - will be too heavy to carry around

2 - screen size adequate

5 - Screen sizes are adequate

6 - the smallest of the screens appears to be adequate

8 - The lighter the better. We all as insp. have 20/20 close up.

9 - the screens are adequate already

6. Which would you prefer:

No case

Why?

Shoulder strap only

Why?

Customized case with shoulder strap 1,2,3,4,5,6,8

Why?

1 - Good protection machine and easy to carry

2 - Ease of handling - protects machine

3 - The case is good to protect the unit. But it will not stay clean ( i.e., grease, oil, hyd

**fluid) A skydrol proof rubberized body with a shoulder strap would be good.**

**4 - Comfortness**

**5 - Pockets to put jobcards/pen, etc.**

**6 - The case has a handle plus the strap**

**8 - A case to better protect unit and a strap to support most of the system when in use.**

**OTHER 7,9**

**7 - Case with handle only; strap gets in way, case helps protect**

**9 - Customized case with hand carrying strap; I prefer carrying the machine this way**

**7. Would you be willing to carry a small, portable barcode reader attached to the pen computer in order to enter barcode information (e.g., job card #, write-up #, login) rather than write/type it in?**

**Yes 1,4,6,9**

**Why?**

**1- as long as making machine easier to use and convenient will be all right.**

**4 - for easiness & comfort**

**6 - A pen type barde reader/stylus can be used while adding very small (couple of oz's) amount to the total weight.**

**9 - If it makes my job easier & doesn't make the machine too bulky it would be worth it**

**No 2,3,5,7,8**

**Why not?**

**2- How heavy is this barcode reader?**

**3 - Too much clutter.**

**5 - More stuff to carry around**

**7 - Enough is enough**

**8 - Past experience shows barcode readers to be temperamental and we don't need any extra appendages.**

# CHAPTER 7

## A UNIFIED INCIDENT REPORTING SYSTEM FOR MAINTENANCE FACILITIES

*C. Levine Wenner and C. G. Drury, Ph.D.  
Industrial Engineering Department, State University Of New York At Buffalo*

### 7.1 ABSTRACT

Errors in maintenance can have many consequences, from endangering public safety through damage to aircraft to personal injury. Each error consequence is lead into different reporting systems, making it difficult to take action against common causes of error. This project performed detailed analysis on three classes of errors resulting from ground damage incidents, personal injuries, and paperwork errors. Hazard patterns were developed for each error class to discover latent failures within the maintenance system in addition to the final active failure which precipitated the incident. A unified incident reporting system was developed to allow these latent failures to be captured and acted upon.

### 7.2 PROJECT OBJECTIVES

The objectives of this project were to demonstrate a base-level human factors project in an engine shop at the airline partner's facility and to interface with that partner's Human Factors Planning Group to develop an integrated error data collection model.

For the engine shop human factors program, a number of starts were made during a period of unprecedented organizational change in the shop. These starts allowed us to collect considerable data on paperwork errors, which was the indicator chosen by SUNY at Buffalo and the airline partner to indicate human factors problems within the shop. We also provided briefings and training in human factors to both management and workforce in the engine shop. However, because of management changes, particularly changes in the reporting structure between the facility and headquarters, the full human factors program could not be completed within the nine months available. Hence the SUNY at Buffalo team continued work on this project by integrating the paperwork error analysis with the other error analyses in conjunction with the Human Factors Planning Group. This strengthens the error analysis and includes engine shop considerations in the final report.

#### 7.2.1 Introduction

Error, as defined in Reason (1990, p.9), is "a generic term to encompass all those occasions in which a planned sequence of mental or physical activities fails to achieve its intended outcome,

and when these failures cannot be attributed to the intervention of some chance agency." The definition of error includes two types of failures. Either the plan developed by the operator is adequate, but the actions deviate from the plan; or the actions may follow the plan, but the plan is not appropriate for achieving its desired ends (Maurino, et al., 1995, p .16). The first type of failure is considered a slip or a lapse and is a failure in executing a plan, while the second type of failure is considered a mistake and is a failure in formulating a plan.

It is also necessary to consider the distinction between errors and violations. An error, as defined above, refers to unsafe acts which are unintentionally committed. A violation, on the other hand, is defined as a "deviation from safe operating practices, procedures, standards or rules. (Maurino, et al., 1995; Reason, 1990)" However, it is important to note that, although the operator may deliberately intend to violate procedures, the unwanted consequences that may occasionally arise are definitely not intended. Maurino, et al., (1995) explain that errors generally arise from informational problems (e.g., when operators do not have enough information, operators do not have the correct information, or when pertinent information is forgotten), while violations are usually associated with motivational problems (e.g., poor supervisory example, and sanctioned non-compliance).

This distinction between errors and violations is especially important in the airline maintenance environment, in which mechanics are often given conflicting goals and priorities in which to work. Mechanics are told to be safety conscious and to follow procedures, but are also pressured to keep on schedule, and to prevent delays at almost any cost. The heavy workloads at most maintenance stations, coupled with a limited number of personnel, make it difficult for all of the efficiency and safety goals to be achieved. Mechanics often make a choice as to which goal is perceived by the supervisors to be most important, and often, the mechanics choose efficiency (most work completed in the least amount of time) over the safety concerns. Maurino, et al., (1995, p. 9) presents a theory that:

Asserts that the negative consequences of top-level decisions (e.g., inadequate budgets, deficient planning, under manning, commercial and operational time pressures, etc.) are transmitted along various departmental and organizational pathways to the different workplaces. There, they create the local conditions that promote the commission of unsafe acts. Many of these unsafe acts will be committed, but only very few of them will penetrate the defenses to bring about damaging outcomes.

This theory can be verified by examination of an airline maintenance system. Mechanics operate under a large number of rules and procedures, and it is often difficult for the mechanics to keep track of them all. Some of the procedures often describe a more difficult way to perform a task, or may require more personnel than is typically available. Thus, over time, it has become routine for procedures to be violated. For example, a towing procedure may specify that six people are necessary whenever an aircraft is moved (a tug driver, a brake-man, a nose walker, a tail walker, and two wing walkers). However, in actuality, it is very difficult to find six people who are not otherwise occupied every time an aircraft is moved. Thus, the tug driver may decide to move the

aircraft using only a brake-man and two wing walkers, in order to prevent delays.

In fact, some of the newer personnel may not even know that they are violating documented procedures, since they have received only on-the-job training for what their trainers see as the correct way to perform certain tasks. Over time, the routine violations have been passed down as correct procedures to new personnel. Management and supervisors often do not enforce the procedures, since the violations are often performed in order to prevent delays and promote efficiency. Generally, the violations do not lead to any further problems, the benefits greatly outweigh the costs of committing the violations, and management tends to look the other way. However, when an incident occurs due to the violation (e.g., ground damage when a plane contacts a parked object due to insufficient number of spotters), the employees involved are reprimanded for their behavior and everyone is told to follow the procedures.

Although violations are officially highly discouraged by management, they are often tolerated as part of normal operating practices. However, the entire maintenance system is designed specifically to prevent mechanics from committing errors, or at least to allow the errors to be detected and corrected before the aircraft leaves the maintenance domain. Job aids, in the form of workcards, are provided to the mechanics to assist them in performing their assigned tasks. Critical tasks require an inspector to verify that the work is properly completed, and the pilots are required to walk around the plane before take-off to ensure that the aircraft is ready to fly. The system contains many defenses, barriers and safeguards whose purposes are (Maurino, et al., 1995):

- To create *awareness* and *understanding* of the risks and hazards.
- To *detect* and *warn* of the presence of off-normal conditions or imminent dangers.
- To *protect* people and the environment from injury and damage.
- To *recover* from off-normal conditions and to restore the system to a safe state.
- To *contain* the accidental release of harmful energy or substances.
- To enable the potential victims to *escape* out-of-control hazards.

These defenses, barriers and safeguards are layered within the system, and are intended to prevent hazardous situations from occurring, allowing operators to detect hazardous situations if they do occur, and allowing the operators to recover once a hazardous situation occurred. It is only when all of the defenses, barriers, and safeguards fail that an error can be propagated through the entire system and eventually affect the public.

In the airline maintenance environment, as in many other industries, the defenses, barriers and safeguards are comprised of: engineered safety devices (e.g., safety rails, locking casters on workstands); policies, standards and controls (e.g., administrative and managerial measures designed to promote safety); procedures, instructions and supervision (e.g., workcards and maintenance manuals); training, briefing, drills (e.g., the provision and consolidation of technical skills and safety awareness); and personal protective equipment (e.g., respirators, safety glasses) (Maurino, et al., 1995). Obviously, many of these defenses are not controlled by the mechanics in the system, and must be put in place by the management of the organization.

## ***Latent and Active Failures***

When an error occurs in the maintenance system of an airline, the mechanic(s) who last worked on the aircraft is usually considered to be at fault. The mechanic may be reprimanded, sent for further training, or simply told not to make the same mistake again. However, to blame the mechanics for all of the errors that are committed is perhaps giving them too much credit for their role in the airline's maintenance system. Many errors are, in fact, committed due to other failures inherent in the system and the mechanic involved is merely the source of one of the failures. In these cases, it may not matter which mechanic is involved at the time of the actual incident, the system encourages particular errors or violations to be committed.

The failures caused by those in direct contact with the system, i.e., the mechanics who are working on the aircraft, are considered to be active failures. These failures are errors or violations that have a direct and immediate effect on the system. Generally, the consequences of these active failures are caught by the mechanic himself, or by the defenses, barriers and safeguards built into the maintenance system. Thus, the system must rarely deal with the consequences of active failures. However, when an active failure occurs in conjunction with a breach in the defenses, a more serious incident occurs (Maurino, et al., 1995).

Latent failures are those failures which derive from decisions made by supervisors and managers who are separated in both time and space from the physical system. For example, technical writers may write procedures for a task with which they are not totally familiar. If the procedure has even one mistake in it, the mechanic using the procedure will be encouraged to commit an error. The latent failures can often be attributed to the absence or weaknesses of defenses, barriers, and safeguards in the system. Often, latent failures may lie dormant in the system for long periods before they become apparent (Maurino, et al., 1995). Fox (1992) defines latent failures as those decisions made in the organization which may create poor conditions, result in less than adequate training, poor supervision, etc. which may lie dormant for some time, but which have the potential to predispose active failures.

For an incident to occur, latent failures must combine with active failures and local triggering events, such as unusual system states, local environmental conditions, or adverse weather. There must be a precise 'alignment' of all of the 'holes' in all of the defensive layers in a system (Maurino, et al., 1995). For example, rain may cause a mechanics' foot to be wet, allowing his foot to easily slip off the worn brake pedal in a pushback tug when the mechanic becomes distracted. The tug may then lunge forward contacting a parked aircraft. The latent failure in the system is that the brake pedal has no anti-slip surface in place, but the problem does not become an issue until the rainy conditions (a local trigger) cause an incident. It can be seen that if any one of the failures had not occurred (mechanic did not become distracted, the tarmac was not wet, or the brake pedal was in better condition), the incident would have been avoided.

Traditionally, the mechanic would be blamed for the incident, since he allowed his foot to slip off the pedal. Clearly, the mechanic did commit this error. However, it must be noticed that mechanics are required to drive pushback tugs daily, and can not control the weather conditions or even the condition of the equipment. They are required to work under strict time guidelines, and they are highly motivated, by management and personally, to keep on schedule. Mechanics



therefore, should not face sole responsibility for such incidents that occur. It is important to consider all of the other factors that affect their performances, and all of the other system-wide problems that may contribute to both failures.

Thus, it can be seen that a large number of unsafe acts (errors and violations) may occur on a daily basis, but it is very rare that a situation is elevated into a serious, reportable incident. Usually, the unsafe acts are either caught immediately, or the defenses of the system prevent the problem from becoming an incident, i.e., the error is prevented from propagating through the system. Mechanics are especially conscious of the importance of their work, and typically expend considerable effort to prevent injuries, prevent damage, and to keep the aircraft safe.

In any system which has been operating for long enough to experience sufficient incidents, examining past incidents makes it possible to determine the types of errors, violations, and latent failures that typically have caused problems in the past. However, in order to prevent future incidents, it is necessary to predict, identify, and remedy latent failures that still may be lying dormant in the system. Many of the errors and violations can be eliminated by addressing the latent problems in the system. Violations can be discouraged by ensuring that the correct way for the mechanics to work is also the easiest and most efficient way for them to perform their task, while errors (which can never be totally eliminated) can be reduced to as low a level as possible by improving or strengthening the various defenses, barriers, and safeguards in the system.

### **Error Reporting Systems**

In a typical airline, failures (above a certain threshold severity) in the system are strictly monitored and recorded. Management keeps stringent records of on-time flight departures/arrivals, turnaround time for aircraft requiring maintenance, injuries to personnel, damage to aircraft and other ground equipment, and other measures that document the airline's overall performance. In addition, many errors may be detected and routinely corrected as part of the system so that no record is kept. However, most of the error-reporting systems in use are recorded and utilized by different departments, and are rarely used together to analyze the system as a whole. But, there are many inherent problems that affect more than one of these performance measures, and similar errors may lead to an incident in more than one of these areas. For example, if a mechanic drops a wrench on his foot, the incident would be recorded as an OJI (on-the-job injury). If a mechanic drops a wrench on an aircraft, damaging it severely, the incident would be recorded as Technical Operations Ground Damage. If the wrench was dropped on the aircraft, causing no damage, the incident would not be recorded at all! Finally, if a Ground Operations Employee drops a wrench on an aircraft, the incident would be recorded as Ground Operations Ground Damage. In each of these scenarios, the error was exactly the same, only the final consequences differed, differentiating the way in which each of these incidents is recorded.

Ground damage incidents, caused by airline personnel, are recorded in what we shall refer to as GDI (Ground Damage Incident) reports. In these reports, an investigative team produces a detailed written report, including: a problem statement describing the incident, a detailed description of the incident, a list of process, equipment and personnel factors, as well as recommendations for preventing this type of incident from happening again. The report generally

includes photographs of the damage to the aircraft as well as the equipment that may have been involved. Also, written descriptions from all of the personnel involved are obtained and included in the report. The recommendations from each GDI are supposed to be disseminated to all of the stations to allow other personnel to learn from the incident.

Ground damage caused by maintenance personnel are recorded as Technical Operations GDIs, while damage caused by other ground personnel are recorded as Ground Operations GDIs. When personnel from both departments are involved in one incident, GDIs may be performed by each department separately. Also, recommendations from Technical Operations GDIs are only passed along to other maintenance facilities, while the recommendations from Ground Operations GDIs are shared only with other ground operations personnel. As many of these incidents have common causes, the conclusion is that no method exists to share information that may be common to all personnel.

At our partner airline, OJIs are recorded using an investigative tool based on a checklist. Although much of the factual data of an incident is recorded, (including the type of accident, the type of injury, the type of equipment being utilized, etc.) there is little opportunity to provide a detailed narrative description of the incident. In addition, the manager completing the investigation is required to indicate possible root causes for the injury, selecting from a limited checklist of possible causes. There is little encouragement inherent in this reporting system to glean specific information concerning the factors leading up to the injury, or the other system factors that may have contributed to the incident.

A paperwork record is crucial in an airline maintenance system. Mechanics must sign-off at appropriate points in their workcards, indicating that they have completed the task correctly. It is essential that all of the sign-offs be properly completed, in order to ensure safe operation of an aircraft, and indeed to satisfy strictly enforced FAA requirements. Clerical personnel at the airline are often assigned the task of reviewing all of the paperwork that is submitted to ensure that all of it is properly completed. Any errors detected can then be corrected before the paperwork is filed in archival storage. Some departments simply keep a running count of the number of paperwork errors that are being committed, to monitor trends in performance, but little use is made of this information to redesign the systems which generated the errors in the first place.

From the previous examples, it can be seen that there are many different error recording systems in use at a typical airline. Each system has different uses, and thus records different levels of information. However, in order to determine the general latent failures that are within the maintenance system, it is necessary to look at more than one source of error data, and to examine the data in sufficient depth to derive findings which can be translated into effective actions.

## **7.2.2 Specific Objectives**

The objectives of this project can now be defined more specifically. They were to examine multiple sources of errors at one airline, to determine how each system recorded information concerning the incidents, to analyze the past incidents to determine commonalities among the incidents, and to develop hazard patterns for the past incidents. These hazard patterns could then be utilized to indicate appropriate interventions, to prevent other incidents. Also, the information

gathered in this investigation could be used to develop a tool to analyze future incidents, in order to determine the latent failures, as well as the active failures, which contributed to the incident.

## 7.3 GDI ANALYSIS

Ground damage includes damage to aircraft caused by airline personnel. It only includes damage that is preventable: damage caused by hail, bird strikes, part failures, and even foreign object damage are not recorded in this system. Ground damage is extremely costly to an airline, since the total cost includes both the cost of repairing the damage as well as the cost of keeping the aircraft out of service. One example, documented in *Airline and Equipment Maintenance* (Chandler, 1995), describes an incident where the cost of repairing a damaged aircraft was \$39,300. However, the total cost of the incident was calculated to be \$367,500, due to passenger and cargo revenue lost. In addition, there are nontangible costs to the airline, including: passenger inconvenience, affected flight schedules throughout the entire airline system, and increased maintenance workloads. A typical airline may have 100-200 reportable ground damage incidents per year, adding significant financial losses that could be prevented.

In this analysis, 130 Technical Operations GDI reports were analyzed, covering ground damage from January, 1992 through April, 1995 by Technical Operations personnel. Initially, each GDI report was reviewed to determine the specific action that caused the ground damage. It was determined that there were only twelve distinct patterns that covered almost all of the GDI reports. Each of these distinct patterns was considered to be a Hazard Pattern. The GDI hazard patterns are enumerated in **Table 7.1**. Next, each GDI report was analyzed to determine the specific active failures, latent failures, and local triggers that contributed to the incident. A scenario was then developed for each hazard pattern, illustrating the common factors between all of the incidents. These scenarios are included in the next section. Each of these is summarized in **Appendix 1** as an event tree showing how each of the latent failures contributes to the final damage event. This form analysis, which has much in common with Fault Tree Analysis, was originally developed by CNRS in France (Monteau, 1977).

Table 7.1 GDI Hazard Patterns		
Hazard Pattern	Number of Incidents	% of Total
1. Aircraft is Parked at the Hangar/Gate/Tarmac	81	<b>62.3</b>
1.1 Equipment Strikes Aircraft	51	
1.1.1 Tools/Materials Contact Aircraft		4
1.1.2 Workstand Contacts Aircraft		23
1.1.3 Ground Equipment is Driven into Aircraft		13
1.1.4 Unmanned Equipment Rolls into Aircraft		6
1.1.5 Hangar Doors Closed Onto Aircraft		5
1.2 Aircraft (or Aircraft Part) Moves to Contact Object	30	
1.2.1 Position of Aircraft Components Changes		15
1.2.2 Center of Gravity Shifts		9

1.2.3 Aircraft Rolls Forward/Backward			6	
2. Aircraft is Being Towed	49			<b>37.7</b>
2.1 Towing Vehicle Strikes Aircraft		5		
2.2 Aircraft is Not Properly Configured for Towing		2		
2.3 Aircraft Contacts Fixed Object/Equipment		42		
2.3.1 Aircraft Contacts Fixed Object/Equipment			13	
2.3.2 Aircraft Contacts Moveable Object/Equipment			29	
<b>Totals</b>	130	130	130	100%

### 7.3.1 GDI Scenarios

#### **Tools or Materials Contact Aircraft (1.1.1)**

In these incidents, a piece of equipment (tools, parts) falls onto the aircraft (or mechanic). Generally, gravity is the ultimate cause of these incidents. By examining the environment in which the incident occurred, and the steps in the process proceeding the incident, it is possible to see how other non-obvious factors contributed to the incident. One such example is presented below.

During an engine change, a mechanic pulled out a forklift supporting an A-frame, causing the frame to fall on the aircraft. However, on further review of the steps leading up to the incident, it is possible to see how this incident came to happen. First, it was not obvious to the mechanics that the A-frame was top heavy and could not support itself. Second, the forklift was removed in order to facilitate disassembly of the A-frame and nose cowl sling, two pieces of equipment necessary for the engine change. The disassembly was required because the engine change kit was missing parts, requiring the mechanics to change their procedure while in the middle of the engine change. Unfortunately, the missing parts were not detected prior to beginning the procedure, since the engine change kit does not contain either an inventory or packing list for the parts to be checked against.

Thus, although this incident was eventually blamed on the mechanic who moved the forklift, the problem had its antecedents far earlier, when the engine change kit was prepared.

Other latent failures contributing to these types of incidents include: poor communication between co-workers, and between shifts; inappropriateness of available equipment for the task; inadequate space in which to perform the task; and poor mechanical condition of the equipment. Many of these latent failures can all be considered to be failures of the workforce to become aware of the possibility of risks and hazards. This lack of awareness may be a failure of management to properly emphasize safety as the first priority (as opposed to emphasis on speed of task completion), and/or may be a result of the mechanics' repeated performance of similar tasks.

Other latent failures result because the equipment does not 'behave' as the mechanics expect. For

example, the engine sling does not hang level from the hoist; the overhead crane has only one speed in the East-West direction and this speed is perceived to be too fast; and the work platform has sagged over time, creating a decline towards the front end. The mechanics' misperceptions of the equipment cause them to perform as they otherwise might not if they were aware of the correct state of the equipment. For instance, the mechanic may have chosen not to place a wheeled dolly on the work platform if he had known it was so slanted towards the front end.

### **Workstand Contacts Aircraft (1.1.2)**

In these incidents, a workstand that was being used to service or repair the aircraft came in contact with the aircraft. There are various scenarios in which this type of incident can occur. The mechanics working on the aircraft may misperceive the position of the workstand while maneuvering in close proximity to the aircraft. In other situations, the mechanic accidentally causes the workstand to move in a direction that is not intended. Mechanics may also fail to properly configure (e.g., raise/lower platform) the workstand before moving it. Finally, in almost all of these incidents, no ground spotter was used while moving workstands around the aircraft.

This last scenario, in which no ground spotter is used, is a routine violation of company policy. The ground equipment policies requires a spotter to be used at all times when moving equipment around the aircraft. However, the unavailability of excess personnel, and high workloads for ground personnel have made this requirement difficult to follow. Since this policy is rarely enforced (except following a ground damage incident) mechanics often feel that they can properly maneuver the equipment and can properly judge distances from the aircraft.

However, there are many latent failures that can be identified as contributors to these incidents. For example, in some situations, the workstand has unused metal brackets attached that can not be seen by the workstand operator. In other situations, the equipment suffers from a mechanical problem that contributes to the incident (e.g., the stand jerks forward when placed in stop position, wheels do not swivel properly, design of dead man switch allows the foot to easily slip out). Furthermore, pressures to ensure on-time departures encourage the mechanics to quickly move their workstands into position, without properly checking for adequate clearance with the aircraft.

Another contributor to this category of incidents is the use of improper, or ill-suited, workstands to perform assigned tasks. In these situations, the mechanic uses workstands (or other ground equipment as workstands) for purposes for which they were not designed. Generally, the mechanic chooses to use the improper workstand because either: the maintenance station does not have the correct equipment (or has too few of them), the correct equipment is unavailable (e.g., the correct equipment is in the shop for repairs, or is being used elsewhere), or because the correct equipment is less accessible than the incorrect equipment (e.g., the correct equipment is parked in a remote location). The improper workstands may offer the mechanic quicker access to their work, but may cause additional problems. Since the workstands are not designed for the work they are doing, they are often difficult to correctly position without contacting the aircraft, and may require excessive relocation throughout the task duration. The increased difficulty of moving the equipment around the aircraft, as well as the increased number of times the workstand's position must be adjusted, increases the chances for the workstand to contact the

aircraft.

### **Ground Equipment is Driven Into Aircraft (1.1.3)**

In these incidents, equipment (trucks, belt loaders, etc.) is driven by airline maintenance personnel into the aircraft. The drivers either misjudge the amount of space available, misjudge the size of the equipment, or in some cases, accidentally continue moving forward when they know they are about to contact the aircraft. This last type of incident occurs when the mechanic is attempting to stop the vehicle by depressing the brake pedal, but fails to do so. All of these incidents are often attributed to the driver allowing his foot to slip off the pedal. However, on closer examination, it can be seen that this is simply an accident waiting to happen. Often, the ground on which the mechanic must work is slippery, due to a combination of oil, cleaning fluids, and rain. This makes the mechanic's footwear slippery, and may cause his foot to slip off the pedals while driving a vehicle. Although these conditions are often present at many stations, the pedals in the vehicles do not all have anti-skid surfaces. In some situations, the anti-skid surface has simply worn off, and has not been replaced. Therefore, these type of incidents can be traced back to poor vehicle maintenance.

As in the previous category of incidents (see **Hazard Pattern 1.1.2**), some of these incidents (ground equipment is driven into the aircraft) are further aided by the use of ill-suited ground equipment for the particular task to be performed. For example, in one incident, mechanics using a pushback tug as a work platform backed the tug into the #1 engine thrust reverser. Specifically, the high windshield on the tug contacted the aircraft. In this situation, the station did not have a lift that was suitable for work in tight locations, and the work platforms that the station does own are difficult to locate when needed. Additionally, in many of these incidents, no ground spotter was used when moving equipment in close proximity to the aircraft. This is a violation of a company policy that is rarely enforced.

Many of these incidents occurred in congested areas, where the mechanic was forced to maneuver his vehicle through other parked ground equipment. Pressure to ensure on-time departures often causes the mechanics to take 'short-cuts', instead of waiting for other vehicles to be moved out of the safer path. For example, in one incident, a mechanic drove a tug with an airstart unit attached under the right wing of a parked aircraft, contacting the aircraft. The mechanic was attempting to leave a refueling station, and all of the other exit points were blocked with equipment and other vehicles. The mechanic decided to take the open path under the aircraft in order to facilitate on-time departure of his next flight. Although this was a conscious choice by the mechanic to violate the company policy against driving under the aircraft, the decision was made in what the mechanic considered to be the best interest of the company.

### **Unmanned Equipment Rolls Into Aircraft**

In these incidents, equipment (tugs, etc.) which is left unattended by airline personnel, rolls into the aircraft. These incidents can be divided into two categories, those in which an unmanned parked vehicle rolls into an aircraft, and those in which a piece of equipment rolls into the aircraft. In most of the incidents in the first category, the vehicle was left unattended, with the



engine running and the parking brake set. This is in violation of company policy that requires all vehicles to be turned off when left unattended. However, in many of the northern stations, it has become standard practice to leave the vehicles running at all times during the winter months, to prevent any problems restarting the vehicles when they are needed. Ground damage incidents occur when the vehicle's parking brake fails, allowing the vehicle to roll into a parked aircraft.

In some situations, the mechanics are aware that the parking brake on the vehicle is not working properly, but are reluctant to pull the vehicle out of service. This reluctance is driven by the shortage of suitable equipment, and the feeling that plant maintenance will not be able to fix the problem satisfactorily within a reasonable amount of time. In other situations, the mechanic is not aware of the limitations of the parking brake and the supplemental braking systems installed by the airline. The lack of awareness of potential hazards causes the mechanics to leave the vehicle unattended with complete confidence that it will remain where it was parked. The limitations of the braking system can be considered a latent failure in the system.

The second category of incidents, those in which equipment rolls into an aircraft, occur when the equipment is not properly fastened into place (hitch pin engaged, or brakes set). For example, in one incident, a cart that was being towed came loose and rolled into a parked aircraft. During the subsequent investigation, it was found that the hitch on the tug had been modified. The modified hitch was not as safe as the standard hitch, since it did not have a positive lock feature to ensure that the hitch pin did not come loose. However, the standard hitch required more time to install, and more strength (usually more than one person) to use as compared to the modified hitch. Since usually only one person was assigned to a tow, the hitch had been modified to allow easier connections/disconnections. Plant maintenance, the department responsible for the condition of the ground equipment, was unaware of the modifications to the hitch on this vehicle. This particular incident was exacerbated by a worn hitch pin which had worn small enough to come out of the hitch body during the tow.

### **Hangar Doors Closed Onto Aircraft**

In these incidents, airline personnel close the hangar doors onto the aircraft. This type of incident is usually caused by misjudging the position of the aircraft within the hangar. In most situations, the mechanics who close the hangar doors have simply assumed that the aircraft is correctly parked in the hangar, and have closed the hangar doors without checking for clearance. However, in most cases when this type of incident has occurred, the aircraft had been parked incorrectly in the hangar. Thus, it is useful to consider why the aircraft could be parked incorrectly.

Since aircraft hangars are often quite congested, and are filled with other aircraft and equipment, there is often only one correct place in which the aircraft can be parked. To correctly park an aircraft in a hangar it is necessary for the aircraft to be towed into the hangar on the proper tow line for that type of aircraft, and the tow stopped on the proper block. The tow line and stop block are painted lines on the floor of the hangar. Ideally there is one line for each type of aircraft using that hangar. Problems arise when the painted lines do not match the type of aircraft, and the mechanics have to choose a different set of guide lines to follow. For example, in one incident, a DC-9 was pulled into a hangar on a 727 tow line. The only two painted lines in

this hangar were for the 727 and 757 aircraft. Additionally, it is necessary to properly align the aircraft on the guide lines before it is too far into the hangar, since it is difficult to adjust its position once the aircraft is in the hangar. Therefore, it is desirable to have the guide lines extend outside of the hangar, to allow the tug driver and spotters to properly align the aircraft as they enter the hangar. In places where the guide lines do not extend outside of the hangar, it is much more difficult to properly position the aircraft in the hangar. Proper positioning also assumes that it is possible to correctly position the aircraft in the hangar. If equipment/workstands are in the path of the aircraft, or a tug that is too large is used, it may not be possible for the mechanics to properly park the aircraft.

In other situations, an aircraft may be parked temporarily in a hangar that is not suited to that type of aircraft. The hangar may not be big enough for the aircraft to fit completely inside. However, if mechanics are not aware of this, they may routinely close the hangar doors without checking for clearance. It is proper procedure for the door controls to be 'red-tagged' to indicate to everyone else that the controls should not be used. This should be done by the mechanics who tow the aircraft into the hangar, who should be aware that the aircraft is too long for the hangar. However, in incidents where the doors were closed on a aircraft, the door controls were not red-tagged.

### **Position of Aircraft Components Changes**

In these incidents, the position of aircraft components (e.g., stabilizer, flaps, rudder, etc.) is changed, either manually or through the activation of a hydraulic system, causing the components to contact obstacles in their path. The first category of incidents, those in which an aircraft component was manually adjusted, generally occurred because a workstand was left in the path of the component. The mechanic failed to perform a walk-around check to ensure that the area was clear before adjusting the component. In addition, no ground spotters were utilized to ensure that the component did not contact anything during its move. It is the crew chief's responsibility to ensure that the proper personnel is assigned to perform a given task. In many situations, the crew chief failed to assign enough personnel and/or failed to ensure that the ground spotters were in place. Since the policy of using ground spotters is rarely followed, many mechanics fail to even ask for assistance when they have to adjust the position of an aircraft component. In addition, the time pressure to ensure on-time departures encourages mechanics to complete their tasks as quickly as possible. The time used to arrange for ground spotters might have been seen as time that can be used more effectively on actually performing the task.

In the second category of incidents, the hydraulic system is activated (or deactivated), causing aircraft components to return automatically to a neutral position. Often, the movement of these components is unintended by the mechanic, who simply activates the hydraulic system for a different purpose. However, the lack of awareness of the implications of hydraulic system activation have caused many incidents. Since the mechanics do not consider what will happen all around the aircraft when the hydraulic system is activated, they often fail to perform a complete walk-around to check for proper clearance. Thus, the aircraft components may contact equipment that is being used by another mechanic, performing an unrelated task. There are many other latent failures that can be shown to contribute to this type of incident.



Most importantly, there seems to be no standard method of communicating the impending activation of the hydraulic system to all of the mechanics working on the aircraft. Some mechanics simply yell their intentions to all within earshot, but the noise in the hangar environment makes it very difficult to hear and understand. In addition, as required by the company policy manual, the controls for the hydraulic system should be 'red-tagged' (with a Do Not Operate tag) if a mechanic is working in the path of any of the components that may be affected by the hydraulic system. This is often not performed.

These incidents are likely to occur because mechanics are often unaware of what other work is being performed on the aircraft. Poor communication between the crew chiefs and the mechanics at the beginning of the shift leaves each mechanic only with an understanding of his task assignment, not the larger picture. Better communication will help mechanics become more aware of the hazards and risks associated with their assigned tasks.

### **Center of Gravity Shifts**

In these incidents, the center of gravity of the aircraft shifts unexpectedly, causing the aircraft to contact the ground with either its nose (center of gravity shifts forward) or its tail (center of gravity shifts backwards). In most of these incidents, the mechanics left a workstand or other piece of equipment under the aircraft while they were working. When the center of gravity shifted, the aircraft settled onto this equipment, causing damage to the aircraft.

In some situations, the passengers were loaded on board while the mechanic was working on the aircraft. The mechanics were unaware that the loading had begun until the aircraft's center of gravity began to shift. The poor communication among all of the airline personnel connected to a single aircraft (mechanics, gate agents, ground crew, flight crew) is a latent failure behind many of these incidents. Similarly, the work of other mechanics on the aircraft may cause the center of gravity to shift as well. For example, if other maintenance work requires the aircraft to be jacked up, the center of gravity shift will affect all other mechanics working on this aircraft. Lack of awareness of other work on the aircraft, as well as poor communication between the different mechanics, contributes to these incidents.

In other incidents, the center of gravity shift is caused by improper procedures or equipment that is being used to complete an assigned task. For example, one mechanic did not follow the DC-9 manual for supporting and jacking the aircraft, and chose to jack the aircraft improperly. This caused the aircraft to be unstable, and the aircraft's center of gravity shifted. In other situations, the mechanics use improper tools that cause the landing gear to collapse during functional tests, causing damage to the nose of the aircraft. The mechanics may not even know that they are using the wrong tools, since it is a common practice at this airline. This lack of awareness prevents the mechanics from taking the correct precautions to avoid damaging the aircraft.

### **Aircraft Rolls Forward/Backwards**

In these incidents, the aircraft rolls either forward or backward under its own power. This unexpected movement causes the aircraft to contact obstacles in its path. In many of these incidents, the aircraft is parked, and the wheels are not chocked (or are improperly chocked). In these cases, the mechanics parked the aircraft in a remote parking area, and forgot to bring

chocks with them. They returned to the hangar, but were distracted before they could return to the aircraft with the chocks.

In other incidents, the mechanics request the cockpit crew to release the aircraft brakes while the aircraft is connected to the pushback tractor. Then, the towbar is detached before the brakes are reset. These incidents can also be attributed to the poor communication between the airline personnel working on this aircraft. In some instances, the mechanics asked the cockpit crew to release the brakes, without informing the pushback crew. The pushback crew then continued to prepare the aircraft for pushback, without being aware of the maintenance problem that the mechanics were working on. In other instances, one member of the pushback (wingwalker) was struggling to disconnect the towbar, when the tug driver requested that the brakes be released to allow the towbar to be repositioned. The wingwalker then successfully pulled the hitch pin, without knowing that the brakes had been released, and the aircraft rolled forward into the tug.

### **Towing Vehicle Strikes Aircraft**

In these incidents, the pushback tug being used to tow the aircraft, or the towbar connecting the tug and the aircraft, comes in contact with the aircraft. In some of these incidents, the tug being used to tow the aircraft slips on the ramp surface, causing it to jackknife and contact the aircraft. In these incidents, the ramp is usually covered by snow and ice. Other latent factors contributing to this type of incident include: the lack of traction augmentation for the tugs (e.g., chains for the tires); the use of towbars which are too short (which allow the tug to contact the aircraft); the use of light tow tractors that are subject to sliding; and poor ramp maintenance in snow/ice conditions. In fact, the snow policy at one station even discourages the mechanics from calling to have the ramp sanded. At this particular station, because of the high cost, sanding overnight can only be arranged by first calling the manager at home. Since mechanics are reluctant to call their manager at home in the middle of the night, they often choose to forgo sanding.

Other incidents occur when the mechanic is working alone to connect the aircraft to the tow tractor. Generally, it is preferable to have two people connecting the towbar: one to drive the tug, the other to connect the towbar. When only one mechanic is assigned to this task, he must repeatedly climb in and out of the tug in order to ensure that the tug is properly aligned with the aircraft. Combined with equipment problems, this may increase the potential for a problem to occur during the towbar hookup. For example, in one incident, the mechanic's foot accidentally slipped from the brake to the accelerator pedal while he was connecting the towbar. The brake pedal surface was worn completely smooth, but the mechanic's footing may have been slippery from the conditions on the ramp. This particular incident was compounded by additional problems with the gear selector on the tug, which allowed the gear selector to slip into Drive from Neutral. This type of incident emphasizes the need to keep all ground equipment in good operating condition at all times.

The need to maintain ground equipment in good condition is also illustrated by the following example. In one incident, the mechanic used a tug with a known problem with the door latch. The door latch had been broken for a few days, but it had not been red-tagged and the tug was allowed to remain in service. In addition, no safety restraint had been installed on the tug's door to prevent it from swinging open. During a routine tow, the door of the tug swung open,

contacting the aircraft and causing damage. This incident was obviously preventable, had the defective equipment been removed from service when the problem was initially detected.

### **Aircraft in Not Properly Configured for Towing**

In these incidents, the towing operation was initiated before the aircraft was ready to be moved. The movement of the aircraft caused damage to occur. These incidents are characterized by poor communication between various members of the pushback crew. For example, in one incident, the airstairs were left down when the pushback was initiated. The cockpit crew did not inform the tug driver as to the status of the door light annunciator. This would have alerted the tug driver that the door was open, and the aircraft was not ready to be towed. Although this is not required by the company's general practices manual, it is suggested by the ramp standards practice manual. The communication from the cockpit that the door was open would have prevented costly damage to the aircraft. Another factor contributing to this incident is that the mechanic in charge of the aircraft tow (the tug driver) was interrupted during his walkaround, and he failed to complete the walkaround before beginning the tow. Finally, since this aircraft was parked in a wide open parking area, the tug driver decided that no wing walkers would be necessary (as per usual ramp practice). This prevented one last preventive measure from working as designed.

In another incident, the pushback tug driver initiated the pushback while a lavatory truck was still servicing the aircraft. The wing walkers knew that the lavatory truck was still connected to the aircraft, but failed to communicate this information to the tug driver. In addition, the wingwalker was not using his wands to indicate the obstruction to the tug driver. The tug driver initiated the pushback before the wingwalkers were in their proper positions, and before the 'all-clear' signal was given by the wingwalker. Apparently, there was some confusion as to whether the wingwalker must give the all-clear signal before the pushback can begin, or whether the pushback should begin when the tug driver sees all of the wingwalkers in their proper positions. The wingwalker mistakenly assumed that the tug driver would wait for the all-clear signal before beginning pushback, so he did not indicate the obstruction to the tug driver. The tug driver had been instructed to clear the gate to allow another incoming aircraft to enter the gate, and was feeling pressure to maintain his departure schedule. The latent failures of poor communication and confusion concerning the pushback procedure contribute to this type of incident.

### **Aircraft Contacts Fixed Object/Equipment**

In these incidents, the aircraft contacts a permanent, unmoveable fixture (e.g., the doors/walls of the hangar) while being towed. Semi-permanent fixtures, such as snowbanks which exist for relatively long periods of time, are included in this type of incident. Many incidents of this type are caused by problems with the guide lines that are used to tow aircraft into maintenance hangars. The aircraft might contact a fixed object when it is towed into the hangar off-center, i.e., when the aircraft is improperly aligned on the guide lines. In some situations, the guide lines are incorrectly painted or are quite confusing. In fact, in some hangars it is standard practice to park the aircraft in the hangar off-center. In other situations, the guide lines do not extend outside of the hangar, making it quite difficult to properly align the aircraft before entering the

hangar. Congestion both inside and outside of the hangar increase the difficulty of properly aligning the aircraft, by making it harder to maneuver the aircraft into the correct position.

Another factor that contributes to this type of incident is the failure of the tug driver to stop the tow when he loses sight of one of the wingwalkers. Although this violates company policy, the line managers regularly permit this behavior to occur. In addition, in some cases the proper number of guidepeople are not even used during the tow. Also, in some situations the tug driver consciously decides to turn his attention away from one or more of the guidepeople in order to concentrate on other related matters (e.g., locating the guide line, checking clearance on one particular point on the aircraft, etc.). In these situations, he is not attending to signals that the other guidepeople may be giving him, and thus he will not be able to avoid contacting an obstacle in his path.

Incidents of this type are also caused when an aircraft is being pushed out of a hangar, and the hangar doors are not completely open. This situation has occurred when a company aircraft is being repaired in a hangar belonging to another company, or when another company's aircraft is being repaired in this company's hangar. The damage to the aircraft is often caused by the visiting mechanics' unfamiliarity with the hangar, as well as poor communication between the two sets of mechanics.

### **Aircraft Contacts Moveable Object/Equipment**

In these incidents, the aircraft contacts moveable objects/equipment while being towed. The objects/equipment are not necessarily in the same location each time an aircraft is moved. Thus, it is necessary for the mechanics to detect the objects before beginning the aircraft tow, and make the necessary efforts during the tow to prevent contact with the aircraft. Many of these incidents involve the aircraft contacting objects/equipment parked within the aircraft safety zone. The aircraft safety zone is supposed to be indicated by painted lines at each aircraft parking area, to indicate where it is safe to leave equipment. Objects left within the safety zone are at risk to be contacted by the aircraft during the tow. It is company policy for the tug driver (who is in charge of the tow) to ensure that the parking area for the aircraft is clear before beginning the tow. In many of these incidents, the safety zone is not cleared before the aircraft is towed into the area. Generally, the tug driver, or other guidepeople, assume that the aircraft will clear the objects/equipment that are left within the safety zone. In other situations, malfunctions of the equipment parked in the safety zone prevent it from being moved to a safer area. For example, in one incident, a loader was parked within the safety zone. However, the right wheel of the loader was broken off, so it could not easily be moved from its position. In a second example, a tail dock in one hangar was inoperative, and the tail dock could not be lowered to the correct position. In this situation, the mechanic had not been informed of the problem with the tail dock, although it had been red-tagged the previous day. There are also situations where it is considered normal for equipment to be parked inside the safety zone. For example, at one particular gate it is normal for the catering truck to be parked nearly eleven feet into the safety zone for the adjacent gate. Such situations make it even more difficult for tug drivers to ensure that the area is clear before the tow is initiated.

Another factor contributing to this type of incident is that the correct number of guidepeople is

not always used during aircraft tows. Although this is a violation of company policy, the policy is rarely enforced, and the mechanics have become accustomed to moving aircraft with a limited number of personnel. The reduced number of personnel makes it more difficult for the tug driver to ensure clearance around the aircraft. In fact, some mechanics report that there are many more instances of minor aircraft damage that go unreported. In addition, the congestion that surrounds the ramp and hangar areas increases the difficulty of safely towing the aircraft.

There are also problems of communication that contribute to this type of incident. One of the common problems is miscommunication between the tug driver and the guidepeople. In some situations, the tug driver failed to recognize the hand signals given by the wingwalkers. In other situations, the tug driver initiated the tow before the guidepeople were ready. Another latent communication problem is that tug drivers do not routinely give verbal responses to commands from the guidepeople. This becomes a problem when a guideperson gives a command to the tug driver, and assumes that the tug driver sees and understands the command. This problem also manifests in situations when verbal communication between the towing crew is difficult. Since the tug driver must simultaneously attend to many areas of the aircraft, it is very difficult to ensure that the tug driver will see the hand signals given by any one guideperson. However, the guidepeople are usually not in radio contact with the tug driver, so verbal communication is also difficult, due to the excessive noise inherent to the airport environment. When communication between the members of the tug crew is difficult, it is likely that the tug driver will not be able to respond in time to any obstacle that may lie in the path of the aircraft.

### 7.3.2 Summary of GDI Hazard Patterns

From the highly-detailed GDI reports it has been possible to identify consistent hazard patterns, and within these to derive the latent failures in addition to the more usual active failures. **Table 7.2** summarizes the incidence of latent failures within hazard patterns.

The latent failures can also be tabulated by the hazard patterns in which they occur. **Table 7.3** illustrates the most common latent failures that contribute to specific hazard patterns. It is important to remember that each latent failure does not contribute to each incident within a hazard pattern, but is simply a latent failure that has resulted in an incident of this type in the past.

From **Table 7.2**, it can be seen that the most frequently occurring latent failures are problems with the equipment, use of an improper number of personnel, and a lack of awareness of risks and hazards. This last latent failure is a broad category, including such failures as inadequate training, and the assumption that adequate clearance exists without checking. However, it is not possible to fully eliminate any of these latent failures using only the traditional technique of reprimand, motivate and train.

<b>Table 7.2 Incidence of Latent Failures</b>		
<b>Latent Failure ID</b>	<b>Description of Latent Failure</b>	<b>Number of Incidents</b>
<b>A</b>	<b>Poor Communication</b>	<b>29</b>
A1	Poor Communication: Between Crew	24

A2	Poor Communication: Between Shifts	5	
<b>B</b>	<b>Poor Equipment</b>		<b>72</b>
B1	Poor Equipment: Inappropriate for Task	39	
B2	Poor Equipment: Mechanical Problem	33	
<b>C</b>	<b>Correct Number of Personnel Not Used</b>		<b>36</b>
<b>D</b>	<b>Inadequate Space</b>		<b>30</b>
D1	Inadequate Space: Congested Area	22	
D2	Inadequate Space: Ill-suited for Task	8	
<b>E</b>	<b>Problems With Painted Guide Lines</b>		<b>21</b>
E1	Guide Lines: Do Not Exist	7	
E2	Guide Lines: Do Not Extend Out of Hangar	4	
E3	Guide Lines: Not Suitable for Aircraft	10	
<b>F</b>	<b>Personnel Unaware of Concurrent Work</b>		<b>8</b>
<b>G</b>	<b>Pressures to Maintain On-Time Departures</b>		<b>19</b>
<b>H</b>	<b>Lack of Awareness of Risks/Hazards</b>		<b>34</b>
<b>I</b>	<b>Pushback Policies Not Enforced</b>		<b>16</b>
	<b>TOTAL</b>		<b>265</b>
Note: Totals exceed the number of incidents due to multiple latent failures per incident.			

In order to eliminate these latent failures in the system, it may be necessary to make many changes in the maintenance system. For example, the Plant Maintenance department may need to be reorganized or enlarged in order to better maintain the ground equipment, or additional equipment may need to be purchased. Also, managers may need to rethink their pushback procedures in order to ensure that the procedures can be applied to the real situations the mechanics must face on a daily basis.

It is not suggested that managers discount the active failures that occur in the system, since clearly, if the active failures are eliminated the incident will be prevented. It is just that going beyond the surface to expose latent failures and/or root causes can: a) show up many problems which have common interventions (e.g., better maintenance of equipment can eliminate many typical hazard patterns, and thus prevent future incidents (see **Table 7.3**) and b) proposed interventions can go beyond the traditional personnel actions of reprimand/motivate/train, which heretofore have proven to be ineffective.

**Table 7.3 Latent Failures By Hazard Pattern**

		Latent Failure ID																
		A	A1	A2	B	B1	B2	C	D	D1	D2	E	E1	E2	E3	F	G	H
H	1	17	13	4	53	33	20	22	12	8	4	8	2	1	5	8	11	22



A	1.1	5	2	3	47	30	17	17	11	8	3	7	1	1	5	1	6	10
Z	1.1.1	3	1	2	3	1	2	0	1	0	1	0	0	0	0	0	0	2
A	1.1.2	1	1	0	29	25	4	6	0	0	0	1	0	0	1	1	4	2
R	1.1.3	0	0	0	7	4	3	9	7	7	0	1	0	0	1	0	2	0
D	1.1.4	0	0	0	8	0	8	2	0	0	0	0	0	0	0	0	0	4
	1.1.5	1	0	1	0	0	0	0	3	1	2	5	1	1	3	0	0	2
P	1.2	12	11	1	6	3	3	5	1	0	1	1	1	0	0	7	5	12
A	1.2.1	8	7	1	1	1	0	5	0	0	0	0	0	0	0	2	3	5
T	1.2.2	2	2	0	3	2	1	0	0	0	0	1	1	0	0	5	1	5
T	1.2.3	2	2	0	2	0	2	0	1	0	1	0	0	0	0	0	1	2
E	2	12	11	1	19	6	13	14	18	14	4	13	5	3	5	0	8	12
R	2.1	0	0	0	8	3	5	2	0	0	0	0	0	0	0	0	0	3
N	2.2	2	2	0	0	0	0	0	0	0	0	0	0	0	0	0	1	0
	2.3	10	9	1	11	3	8	12	18	14	4	13	5	3	5	0	7	9
I	2.3.1	2	1	1	4	1	3	2	8	4	4	5	1	1	3	0	1	3
D	2.3.2	8	8	0	7	2	5	10	10	10	0	8	4	2	2	0	6	6
	Totals	29	24	5	72	39	33	36	30	22	8	21	7	4	10	8	19	34

## 7.4 OJI ANALYSIS

While the **GDI** reports represented a data collection system of considerable depth and complexity, such is not typically the case with error/accident/incident recording systems. For example, Drury and Brill (1983) analyzed hazard pattern for consumer products using a two-level system developed by the Consumer Product Safety Commission. It is, therefore, important to include a data set with more incidents and less details in our analysis, as any integrated system must be able to serve both needs. On-the-Job Injuries (OJIs) in airline maintenance are a common problem which lead to significant losses to the airline each year. The OJIs analyzed during this research were the Technical Operations (maintenance) injuries for the 1994 calendar year. A total of 785 injury reports was obtained for this period including the insurance costs associated with many of these incidents. The total direct cost to the airline for the data compiled was over \$1,200,000. Obviously, the airline has a purely financial interest in lowering the number of injuries that occur per year. These direct costs do not include loss of productivity and quality due to moving personnel between jobs to compensate for missing injured workers. OJIs are already collected and statistical summaries are available showing frequency and costs by body part injured and type of incident (fall from height, caught in, etc.) using ANSI-Z16 categories. Current analyses give little guidance on presentation or on latent failures, so that a hazard pattern approach was taken as with the GDI reports. The hazard patterns used here were modified from a set developed by one author (C. G. Drury) in a number of industries, to cover the specific maintenance injuries recorded at the partner airline. Hazard patterns were developed for the injury data by sorting the injury reports according to the type of situation that caused the injury. Sixteen hazard patterns were developed for the injury data, as described below in **Table 7.4**.

**Table 7.4 OJI Hazard Patterns**

<b>Hazard Pattern</b>	<b>Number of Incidents</b>	<b>Percentage of Total</b>	<b>Percentage of Costs</b>
1.0 Task Overstrain	<b>240</b>	<b>30.57</b>	<b>35.25</b>
1.1 Specific Incident	177	22.55	28.7
1.1.1 Connecting or Disconnecting Towbars	19	2.42	2.15
1.2 Accumulated Repetitive Stress Injuries	44	5.61	4.4
2.0 Environmental Hazards	<b>123</b>	<b>15.67</b>	<b>3.23</b>
2.1 Noise	2	0.25	0.58
2.2 Extreme Temperatures	6	0.76	0.12
2.2.1 Whole Body Exposure to Heat or Cold Through Convection or Radiation	2	0.25	0.02
2.2.2 Skin Contact to Extreme Heat or Cold	4	0.51	0.10
2.3 Chemicals	48	6.11	1.67
2.3.1 Contact with Chemicals	37	4.71	1.29
2.3.1.1 Known Contaminant	34	4.33	0.57
2.3.1.2 Unknown Contaminant	3	0.38	0.72
2.3.2 Inhalation of Fumes or Gases	11	1.40	0.38
2.4 Foreign Objects From Environment	67	8.54	0.86
3.0 Surface Slips	<b>113</b>	<b>14.39</b>	<b>16.7</b>
4.0 Lose Control Of Equipment	<b>108</b>	<b>13.76</b>	<b>21.5</b>
5.0 Spatial Misperceptions	<b>166</b>	<b>21.15</b>	<b>14.1</b>
6.0 Traffic Accidents	<b>4</b>	<b>0.51</b>	<b>1.1</b>
7.0 Equipment Malfunction	<b>19</b>	<b>2.42</b>	<b>7.9</b>
8.0 Illness	<b>12</b>	<b>1.53</b>	<b>0.13</b>
<b>TOTAL</b>	<b>785</b>	<b>100%</b>	<b>100%</b>

For each hazard pattern, a scenario was then developed to describe the pattern's common features, as shown in the following section. It is important to note that only one year of injury data was examined, and examining additional years of injury reports may change the statistical results discussed below. In addition, since less information is available in the OJI system, it is very difficult to understand all of the factors that contribute to these incidents.

The current OJI investigation tool is completed by the manager of the injured employee. The form requires some basic information, such as the location, date, and the employee's name, identification number, and age. Also, there is a small space for a written description of the incident. Most of this form is series of checklists, from which the manager must choose one item from each category. The categories include such basic information as: the type of aircraft, the type of accident, the type of injury, and the part of the body that was injured. Other categories are included which target root causes of the accident, including: substandard conditions, substandard practices, personal factors, and job factors. However, no attempt is made to determine the reasons behind the identified factors.



## 7.4.1 OJI Scenarios

### Specific Incident

These incidents occur when a mechanic suffers a strain while performing a specific task which he was assigned to perform. The mechanic exerts more force on equipment during task performance than the body can safely withstand in that posture, or the mechanic achieves an unusual posture resulting in musculoskeletal strain. In each of these incidents, it is possible to identify what the mechanic was doing at the time of the injury. This hazard pattern accounts for 22.6 percent of the maintenance injuries, with associated costs of \$356,413 (28.7 percent of the total costs of injuries).

90 percent of these incidents are muscle strains, and over 56 percent of the strains are back injuries. Many of these incidents occur when the mechanic is lifting, moving, or carrying objects as part of routine activities. These incidents are also caused when the mechanic must maintain an awkward position while working on an assigned task.

### Connecting/Disconnecting Towbars

These incidents are similar to the miscellaneous task overstrain category described in **Table 7.3 (see 1.1)**, but occur when the mechanic is connecting or disconnecting the aircraft towbar. The towbar must be attached to the aircraft and the towing vehicle in order to tow the aircraft into a gate, pushback the aircraft from a gate, or tow the aircraft from one place to another. The towbar is heavy, and must be positioned accurately in order to properly lock the towbar in place. It is usually recommended that two people be used to connect the towbar, but due to limited availability of personnel, one person often attempts to connect the towbar without assistance. 68.2 percent of all injuries resulting from this task are back strains. This type of incident accounts for 2.5 percent of all injuries to maintenance workers and for 2.15 percent of the total amount spent on injury compensation (\$26,748).

### Accumulated Repetitive Stress Injuries

These incidents occur when an injury can not be related to one specific occurrence or event. The injury is the result of the mechanic performing his assigned duties over a long period of time. 25 percent of these injuries are arm strains, 18 percent are wrist injuries, and 1.6 percent are elbow strains. These injuries are compatible with the frequent use of hand tools required by airline maintenance work. Mechanics must often work using odd postures, and must use hand tools which promote repetitive stress injuries in the wrists and arms.

This type of incident accounts for 5.6 percent of the total injuries for the year, and the costs associated with this hazard pattern account are \$55,205, only 4.4 percent of the total. However, it is important to note that these injuries developed over a long period of time, and it is up to the individual mechanic to decide when to report his injury.

### Noise

Excessive noise can cause hearing damage, especially if the mechanic is exposed to high sound pressure levels over a long period of time. The maintenance environment can be quite noisy, and the mechanics are often required to use noisy hand power tools in close quarters. These incidents are not pinpointed to a specific exposure, but are the result of accumulated exposure over the mechanic's career. These injuries are generally identified during the mechanic's routine medical evaluations, and are detected when hearing ability falls below a predetermined level. Only .25 percent of the injuries were due to excessive noise, accounting for .58 percent of the costs spent on maintenance injuries (\$7,250).

### **Whole Body Exposure to Heat or Cold Through Convection or Radiation**

These incidents occur when a mechanic must perform his assigned duties in extremely cold or extremely hot temperatures. Cold temperatures may result in frostbite, while hot temperatures may result in heat exhaustion, or even heat stroke. Mechanics must perform their assigned duties, no matter what the weather conditions are on a given day. The work often must be performed outside, or in non-heated hangar environments. Thus, mechanics are extremely susceptible to the effects of the ambient temperatures if they are not aware of how to prevent being affected (properly dressing for the weather, becoming dehydrated in hot conditions, etc.). This type of injury accounts for only .25 percent of the total injuries, and for only .02 percent of the total cost of injury compensation (\$213).

### **Skin Contact to Extreme Heat or Cold**

In these incidents, a mechanic comes in contact with either an extremely cold, or an extremely hot surface. The injuries examined in this research were examples of mechanics coming in contact with hot surfaces or liquids. The mechanics suffered burns due to contact with hot substances. This type of injury accounted for .5 percent of all injuries, and for .10 percent of the total costs (\$1,200).

### **Known Contaminant**

Here, mechanics come in contact with a chemical substance while they are performing their assigned duties. The chemical substance may contact the mechanic's skin, or may enter the mechanic's eyes. These injuries generally occur when the mechanic is either painting, working near hydraulic fluids, or is using various cleaning compounds. 67.7 percent of these injuries resulted from the contaminant entering the mechanic's eye. Some of these injuries occur when the injured mechanic is simply working in an area in which a contaminant is being used.

These incidents account for 4.3 percent of the total injury, but only .57 percent (\$7,028) of the injury costs.

### **Unknown Contaminant**

In these incidents, mechanics develop rashes or other skin or eye irritations that cannot be pinpointed to a specific occurrence at work. These incidents account for only .38 percent of the

injuries, and for .72 percent of the total cost (\$8,939). The irritations are diagnosed to be a reaction to some unknown contaminant in the work environment.

### **Inhalation of Fumes or Gases**

Mechanics can experience an adverse reaction to the inhalation of fumes or gases while they are working. Reactions to these contaminants are usually manifested as respiratory problems. These incidents account for 1.4 percent of all injuries, and for .38 percent (\$4,560) of the total expenditures for injury. Substances that have triggered this type of incident include the fumes from: cleaning compounds, gasoline, hydraulic fluids, and paint. This type of incident can be exacerbated by the confined areas in which mechanics must often work.

### **Foreign Objects From Environment**

In these incidents, mechanics get a foreign object in their eye while they are working. This type of incident also includes foreign objects that enter other parts of the body, including slivers. 94 percent of these incidents occur when the mechanic gets a foreign object in his eye, of which 46 percent are due to dust, or other airborne particles. Often, the particle arises from work the mechanic himself is doing, but these incidents also may occur as a mechanic is simply passing through an area in which other mechanics are working. Many of these incidents occur when a mechanic fails to wear his safety glasses, but many mechanics report that they were wearing safety glasses at the time of the incident. This hazard pattern accounts for 8.5 percent of all injuries, but for only .86 percent of the total cost (\$10,320) spent on injury compensation.

### **Surface Slips**

These incidents occur when a mechanic's foot, hand, or finger slips due to poor surface grip. In these situations, the mechanic may lose control of his limbs and/or body and/or tools, resulting in a fall, contact with a fixed object, or a musculoskeletal strain. 20 percent of these incidents result in back strains, while 9.7 percent give ankle sprains, and 9.7 percent knee sprains.

Most of these incidents occur as a mechanic is climbing into or out of their work area (the aircraft, a workstand, etc.), or are simply walking between two areas. The mechanic slips during the movement, causing a strain or sprain. These incidents comprise 14.4 percent of the total number of injuries, and are associated with costs of \$207,788 (16.7 percent of the total).

### **Lose Control Of Equipment**

In these incidents, the mechanic loses control of the equipment and/or tools and/or materials that he was using to perform his assigned task. The object then falls, or moves out of the mechanic's reach, resulting in contact with the object, or a musculoskeletal injury suffered while trying to recover. Many of these injuries occur as the mechanic is using hand tools. 43.5 percent of these injuries are laceration to various body parts (24.1 percent are to fingers), resulting when a tool is dropped onto the mechanic's hand. Other injuries that result are punctures, crush injuries and bruises. These are the injuries that are expected when objects are dropped onto the mechanic's body parts. These incidents account for 18.7 percent of total injuries, and for 21.5 percent of the

total expenditures on injuries, or \$267,300.

### **Spatial Misperceptions**

These incidents occur when a mechanic does not correctly perceive the position of tools, equipment, aircraft parts, or the ground in relation to his position. The misperception results in either a misstep or contacting a fixed structure with a body part. 38 percent of these incidents result in lacerations to various body parts (fingers and head predominately), while 21 percent result in bruises to various body parts (knee, elbow, and hand injuries occur most often). Many of these incidents occur while a mechanic is maneuvering around an aircraft, when he misperceives the position of fixed objects on the aircraft. Other incidents occur when a mechanic does not correctly perceive the hazards associated with sharp items (sheetmetal, etc.). These incidents account for 21.2 percent of all of the maintenance injuries, and for 14.1 percent of the total costs (\$174,882).

### **Traffic Accidents**

These incidents occur when a mechanic is injured while driving or while riding as a passenger in a ground vehicle. In addition, this hazard pattern also includes incidents in which a mechanic is stuck by a vehicle while working. Only .51 percent of all incidents fell into this category, and these incidents account for 1.1 percent of the total injury costs. Most of the injuries are strains or sprains resulting from the accident.

### **Equipment Malfunction**

In these incidents, a piece of equipment breaks, sticks, or otherwise functions incorrectly. In many situations, the mechanic is unable to control the equipment after it breaks, resulting in a fall, contact with an object, or a musculoskeletal strain. In many cases, the mechanic is struck by an object that has malfunctioned, and the mechanic happens to be in its path. For example, a mechanic may step on a pallet and it breaks, causing him to fall through and sprain his ankle. Or, a locking mechanism on a scaffold may break, causing the scaffold to collapse and contact a mechanic who is standing underneath it at the time. Only 2.4 percent of the maintenance injuries fall into this category, but their costs are responsible for 7.9 percent of the total (\$98,500).

### **Illness**

In these incidents, the mechanic becomes ill while performing assigned duties. The illness may be due to a previous medical condition, a new medical condition, an allergic reaction to something in the work environment, or even job stress. These incidents account for 1.5 percent of the total maintenance injuries, and for .13 percent of the total cost (\$1504). Overall, the tasks being performed at the onset of the illness are totally unrelated to the incident. One-third of these incidents are allergic reactions.

## **7.4.2 Summary of OJI Hazard Patterns**

A data set such as that for OJIs is collected in a less detailed and rigorous manner than that for

GDI. The incidents are more common, and for at least some management personnel there is an element of disbelief unless an actual wound can be seen. The emphasis in personal injury is on treatment of the injured person, with data collection seen to some extent as a legally necessary, but somewhat unrewarding, exercise. Interventions have concentrated on physical changes for chemical hazards and personal protective equipment (e.g., hearing protection, bump caps), but the hazard patterns for which these are effective represent only a small fraction of the total injuries and costs.

Interventions for many of the larger categories, such as task overstrain or losing control of equipment tend to be oriented towards behavior modification using poster campaigns, reprimands from supervisors or slogans. Such methods are typically quite ineffective, as seen by the continued large numbers of injuries and costs associated with these hazard patterns. However, many of the latent factors can be the same as those found in GDIs. Why was the mechanic hurrying? Why did a single mechanic attempt to maneuver a towbar? Why did the mechanic have shoes incompatible with the surface conditions?

Even though the data collection system lacks the depth to pinpoint the latent failures, it can still be used to define patterns concentrating on the active failures, from which the existence of latent failures can be deduced.

## 7.5 PAPERWORK ERRORS

If GDI reports represent the most detailed level of data available, and OJI reports a more usual level, paperwork error records represent a bare minimum of causal information. Typically, only their existence is noted, and the person who is directly to blame is identified for remedial action. Integrating paperwork errors into a comprehensive error data collection system is likely to be challenging.

In a typical maintenance system, mechanics use workcards to guide them as they perform tasks. The workcards are usually based on maintenance manual or manufacturers' procedures, and provide blocks for the mechanics to sign-off the completion of tasks. The workcards then serve as a legal record of the work performed on the aircraft, with mechanics held responsible for the work that they sign-off on the workcards. There are strict FAA guidelines that describe the use of workcards in the maintenance environment. The FAA may fine an airline for failing to follow these guidelines. For example, there are guidelines requiring that every block on a workcard be signed-off before the workcard is considered completed. Thus, if a workcard is filed away before all sign-offs are complete, the airline may pay a substantial penalty if the error is detected during an FAA audit. Thus, airlines have a strong financial interest in eliminating errors in workcards, and mechanics have an equally compelling interest in preserving their good names.

In this research, the paperwork errors of an isolated maintenance environment were examined. The environment chosen was an airline engine shop, since the paperwork for this area is tightly controlled and monitored by only one department. This department has been routinely checking all engine paperwork that is submitted for filing after an engine has left the shop. Clerical workers are responsible for ensuring that all of the paperwork has been properly completed, and for correcting any errors before the paperwork is archived. The department staff in this particular

airline had been tracking the number of errors committed by the maintenance personnel, and had found that an unacceptable number of errors had been made. However, the reasons for the errors being committed had never really been addressed. This research has examined many of the typical errors committed by maintenance personnel, and has identified latent failures in the system that contribute to the commission of particular types of errors.

The paperwork examined in this research included engine documentation that was being reviewed by the airline clerical staff during the project duration. Some of the paperwork examined included: workcards, routing tags, file sheets and non-routine workcards. Originally, discussion of particular errors with the maintenance personnel who committed the errors, in order to determine the surrounding factors that contributed to these specific errors was planned. However, this approach was not feasible due to the long delay between paperwork submission and the error being detected. Instead, a group of maintenance workers were brought together to discuss problems with the paperwork, and to help identify factors that often contribute to errors.

A total of 136 paperwork errors was examined during this research. The errors were those that were identified by the airline's clerical staff during its normal review of the paperwork. As with the GDIs and OJIs, the errors were classified into six patterns which covered the common features of the incidents. The patterns for the paperwork errors, including the number of errors in each category are presented in **Table 7.5**. Descriptions of each error pattern can be found in the following section.

<b>Table 7.5 Error Patterns of 136 Paperwork Errors in Engine Maintenance</b>		
<b>Description of Paperwork Error</b>	<b>Total Number</b>	<b>Percentage of Total</b>
Cannot Read PMI Stamp	2	1.4
Incorrect Verification of Status Figures	6	4.4
Failed to Initial Changes or Other Entries	4	3.0
Missed Compliance	10	7.4
Missed Intermediate Sign-Offs	46	33.8
Missed Final Sign-Offs	68	50.0
<b>Total</b>	<b>136</b>	<b>100.0</b>

## **7.5.1 Paperwork Errors**

### **Cannot Read PMI (Parts and Material Inspector) Stamp**

In these errors, the PMI correctly attempted to sign-off a step he had completed. However, the stamp seemed to be improperly inked, and the stamp was not totally readable on the paperwork. It was not possible to identify the PMI number from the paperwork, a condition not permitted by

the guidelines. This type of error should have been detected by the PMI when checking the result of the stamping.

### **Incorrect Verification of Status Figures**

At various points in the paperwork, the mechanic is required to pull an assembly status report for the engine, and to record particular data on the workcard. The mechanic must choose the correct information from the status report, and write the correct numbers on the workcard. Errors occur when the mechanic chooses the incorrect figures from the status report, or incorrectly writes the information on the workcard (e.g., transposes the numbers).

Similarly, the workcard requires that part numbers and serial numbers be written in at various points. This is necessary to ensure that the same part is replaced on an engine during assembly that was taken off the engine during disassembly. Errors occur when the mechanic incorrectly writes in the necessary part numbers.

### **Failed to Initial Changes or Other Entries**

Whenever a mechanic makes a mistake on a workcard, he must cross out the incorrect information and write in the correct information. At the same time, he is required to initial the cross-out. In addition, if a mechanic adds any extraneous information to the workcard, he is required to initial the information. This requirement allows the reviewers to understand who made entries and/or changes on the workcard. Errors occur when the mechanic fails to initial changes or additions to the workcard.

### **Missed Compliance**

At various points within the engine paperwork, the mechanic must indicate whether a specific engine component has: previously complied with (PCW), complied with (CW), not complied with (NCW), or is not covered by (NA) particular service bulletins (SB), Engineering Orders (EO), Engineering Authorizations (EA), etc. This information is obtained by checking the particular engine or part in question in the airline's computer system. An item is considered to be PCW if the service bulletin was completed on a previous visit to the engine shop. The item is CW if the service bulletin is completed on the current visit to the engine shop. NCW is selected if the service bulletin has not been completed on this engine, if the work is not performed on this visit, and if the work is scheduled for a later visit to the shop. NA is indicated if the service bulletin does not apply to this particular item. An error is made if the mechanic fails to indicate which option applies to the service bulletin in question.

It is important to consider how the workcard presents this sign-off to the mechanic. In a typical workcard, this sign-off appears as follows:

(1) SB XXXX

Complete SB

PCW\_\_\_\_\_ CW\_\_\_\_\_ NCW\_\_\_\_\_ NA\_\_\_\_\_



The compliance choices are imbedded in the text of the workcard, and a separate sign-off block is provided along the right hand side of the document (where all workcard sign-offs are located). The mechanic is expected to indicate the correct compliance status, by either using a check-mark, or by using his stamp. Then, the mechanic must also sign-off on the right hand side that the compliance record was completed. This violates the guidelines for good workcard design, as described by Patel, Drury and Lofgren (1994). For example, Guideline 10 states that "[the workcard] should have certain consistent and common elements to foster generalizations across contexts." For this type of sign-off, the compliance record is located in a different location than the rest of the sign-offs. Consequently, it could be predicted that the mechanics would be more likely to miss these required blocks. In addition, contrary to most other workcard sign-offs, the compliance record requires two sign-offs for completing the same task (once at the compliance record, once at the item sign-off).

### **Missed Intermediate Sign-Offs**

The engine shop paperwork contains instructions for the complete disassembly, repairs, and reassembly of the engine. At each step in the process, a mechanic will be required to sign-off that a particular step has been completed. At some critical steps, sign-offs from both a mechanic and an inspector are required. Further, PMIs are required to sign off that particular parts have been inspected as the workcard specifies. Errors occur when one of these sign-offs is omitted. Generally, if only one sign-off block in a process is blank, this indicates that the mechanic did complete the work, but simply failed to complete the sign-off (This is usually the case, since the next step in the process could not be completed if the previous step had been omitted). These are considered intermediate sign-offs since they occur in the middle of a particular process.

From discussions with engine shop mechanics, various explanations for this type of error have been identified. First, some mechanics complete an entire process before signing off any of the blocks on the workcard so as not to disrupt their work sequence. Then, as they go through the paperwork, they may simply accidentally skip over one of the necessary blocks. Or, a mechanic may be distracted or interrupted as he is completing the sign-offs, causing him to omit a sign-off when he returns to his task. Another possible explanation is that more than one mechanic may be working from one set of paperwork (engine paperwork is separated into engine modules, and the paperwork for each module is bound together into one book). When one mechanic finishes a task, the book may not readily be accessible for him to sign-off his task completion. The mechanic may then move on to his next assignment, and may never remember that he did not complete the sign-off. This may also occur if a task is completed immediately before the end of a shift. The mechanic may simply clean up his area and go home before he has a chance to complete the sign-off.

### **Missed Final Sign-Offs**

Final sign-offs are those sign-offs located at the end of one section of the paperwork. These sign-offs are designed to give one mechanic (or inspector) the responsibility for ensuring that the paperwork is properly completed. For example, an inspector is required to review a section of



the paperwork, and sign-off that that section has been properly completed. On a routing tag, one inspector must sign that all of the work indicated on the tag has been completed correctly. In addition, when specific forms are completed, a mechanic must sign-off on the file sheet (a 'table of contents' included at the beginning of the module paperwork book) that the paperwork has been completed. Errors occur when the final sign-off is not completed.

However, on further examination of the wording of the final sign-offs, it is possible to see how poorly designed sign-offs contribute to mechanics' errors. For example, consider the following final sign-off that has been added to many of the workcards:

Ensure all items of form are complete and signed off. Sign-off completion of form on file sheet. _____
---

This statement was recently added to the paperwork, in attempt to reduce the number of paperwork errors. Its intention is to make one person responsible for ensuring that an entire section of paperwork is properly completed. However, this one statement is responsible for 36 of the errors examined in this research (26.5 percent).

This statement violates many of the guidelines for good workcard design, as described in Patel, Drury and Lofgren (1994). For example, Guideline 18 indicates "Eliminate use of all illogical and self-contradictory statements," and Guideline 41 explains that "The task information should be ordered/sequenced in the natural order in which the tasks would be carried out by most inspectors..." However, this statement does not follow the natural order, since it requires the mechanic (or inspector) to check all of the sign-offs in that section of the paperwork, then to go to the file sheet and sign-off that the section has been completed. Finally, the mechanic (or inspector) must go back to this page in the paperwork and sign-off this block. Generally, it is not expected that mechanics (or inspectors) will flip back and forth between pages in the paperwork book. It is also interesting to note that none of the errors examined had omissions of both this sign-off and the corresponding sign-off on the file sheet. This indicates that if the mechanic (or inspector) goes to the file sheet (as directed by the sign-off), he may not return to sign-off the final sign-off. However, if the final sign-off is completed, the mechanic (or inspector) may have intended to sign off the file sheet later, and forgot.

In addition, this final sign-off may appear on more than one page in a particular paperwork form. However, there is only one place on the file sheet for the entire form. Thus, once the first of these final sign-offs is encountered, the mechanic (or inspector) will sign-off the file sheet. It is therefore, (technically), impossible for any of the other final sign-offs on that particular form to be completed. This problem arises because a mechanic (or inspector) is not supposed to sign-off for work that he has not completed and the file sheet can not be signed off. Thus, this statement also is illogical, and self-contradictory.

It can be seen from this error pattern how an attempt to add another layer of checking can introduce another opportunity for error. Total Quality Management principles would suggest eliminating extra checks and ensuring the original process is performed correctly.

## 7.5.2 Improvements to Paperwork

By applying guidelines developed by Patel, Drury and Lofgren (1994), many improvements can be made to the layout of the engine shop paperwork. In addition, discussions with engine shop personnel have indicated that the paperwork has many additional content problems that need to be addressed. There seem to be many workcard pages that are still included in the paperwork, although they are not used. Each of these unused pages has a final sign-off that must be signed by an inspector. (Thus, an inspector must sign-off that a blank page has been completed, which seems to violate the role of a sign-off). Engine shop personnel have been unable to have these excess pages removed from the paperwork. Addressing these issues should eliminate many of the latent errors in the paperwork, and should result in fewer errors. Ensuring that all sign-offs are in a consistent location will reduce the possibility of their being missed by a mechanic.

In the scope of this research, some possible improvements to a small section of engine shop paperwork were prototyped. Changes were limited to making layout improvements to the existing workcards. However, due to problems in organizing the team at the partner airline, it was not feasible actually to test these newly designed workcards.

In addition, technological solutions could help prevent errors in transferring information between a data source and the workcard. For example, when the engine paperwork is generated, the correct compliance information could be automatically recorded on the paperwork. Similarly, electronic workcards could allow more than one mechanic to access the paperwork at the same time, reducing errors due to the unavailability of the workcards when needed by a mechanic.

Finally, it is important to note that this particular airline does plan some changes to its paperwork system in the near future. However, the current plan is simply to convert the existing paperwork to the new system, without making any layout or content changes. Thus, an ideal opportunity for the maintenance personnel to address their concerns and an opportunity to reduce the latent failures in the paperwork may be lost.

## 7.6 GENERAL INCIDENT ANALYSIS

It is useful to consider an example of how various error reporting systems may interact. Mechanics are often required to use pushback tugs to move aircraft between gate and hangar areas. Ground damage incidents have been found to be caused by defective parking brake systems in these tugs. (The obvious question is why is a defective tug still in service on the ramp). Narratives from the GDI report indicate that mechanics are reluctant to send a tug in for service because the Plant Maintenance department (responsible for repairing ground equipment) is seen as inefficient. Equipment can be out of service for a long period of time, and the problems may not be completely fixed when the equipment is returned. Thus, one of the latent failures that contributes to ground damage is the inefficiency of Plant Maintenance. However, if mechanics do not report their problems with the service provided by Plant Maintenance, that department will not be aware of how their performance has affected other areas of the maintenance system. The information gleaned from the GDI may not be disseminated to the management or personnel in Plant Maintenance.

This example illustrates how poor communication can contribute to the repetition of errors in the maintenance environment. In fact, the lack of communication about errors and their causes is common throughout many areas of the industry. During the analysis, we found that although much effort is utilized throughout the company to collect information about incidents and errors, little is done to actually use this information to prevent future incidents. Information collected in error reporting systems are currently used mainly for insurance and financial reports, and for disciplinary action against maintenance personnel. In some cases, the error analysis provides motivation for additional training to be conducted. However, the information is rarely used to provide insight into system wide problems.

Furthermore, the maintenance of separate error reporting systems for each type of incident (OJI, GDI, etc.) does not allow the common patterns of events to be detected. From the analysis of the data in this study, it is possible to see that the same latent failures are at the root of many different types of errors. However, the significance of each latent failure on the entire maintenance system is less obvious when examining only one error reporting system, than when examining all of the errors in the entire system.

## 7.7 INCIDENT INVESTIGATION METHODOLOGY

From the errors that we have examined during this research, it is obvious that it is important to consider all of the factors that contribute to an incident. The obvious end result, or the active error that is committed by maintenance personnel, is not nearly the end of the story for error investigation. Latent failures in the system must be identified in order to determine why an error was committed. However, many of the current error reporting systems are not capable of reaching this level of investigation. Other reporting systems, such as the GDI system, do currently collect information through which latent failures can be identified; But, the information is reported in such a way that it is very difficult to extract the necessary information, and to produce effective recommendations for action. In addition, the use of multiple error reporting systems, maintained by different departments within an airline, make common issues difficult to identify.

It is therefore desirable to develop an incident investigation tool that can be applied to more than one type of error. This tool must be able to get behind the obvious contributory factors to an incident to identify the latent issues. However, not all incidents need to be examined to the same depth. Therefore, the investigative tool must be flexible enough to address different levels of investigation. In addition, the investigative tool must not be more cumbersome than the error reporting systems that are currently in place and should hopefully be less cumbersome. The investigative tool should also provide for multiple modes of intervention, beyond the relatively ineffective motivation and counseling actions usually specified. The information from the system must be easy to extract and disseminate, in order for the airline to learn from its mistakes.

The data that has been examined during this research forms the basis for a new investigative tool. The various errors that have been considered have provided examples of the situations in which errors are likely to occur. The hazard patterns that have already been identified can be used to guide future error investigations. From what is known of typical latent and active failures

for each type of event, a set of investigative questions can be developed that can be used to analyze future errors. It is critical that descriptive narratives be included in any investigative tool. Narratives from the people involved in an incident generally include background information that provides an insight into what people were thinking at the time of the incident, and the motivations for their actions. This information helps to explain why the people involved performed as they did, which helps to identify the latent failures in the system. Without a narrative, only the active failures can be seen, which may not paint the whole picture for the incident investigators.

An investigative tool must fulfill certain roles, as described by Maurino, et al., (1995). It must be able to identify the nature of the outcome of the event, identify the failed or missing defenses in the system, identify any unsafe acts committed by the personnel involved (errors and violations), and identify the local triggers that contribute to the incident. This investigative tool can be computerized using typically available computer software. For example, an Access database has already been developed to store information about the various incidents analyzed here. Electronic forms can be designed to allow easy input of information (as they were for this project), and can in the future be used to prompt the investigator as to relevant questions that should be asked during the investigation. The data can be automatically stored in a database, on which various queries and reports can then be run to analyze the incidents that have been investigated. Note that the requirement for storage and retrieval in a computer system does not mean that questions need to be multiple choice from a fixed set of answers. In this project we have used data entries in narrative form and been able to search for and retrieve specific information. To use this investigation tool, it will be necessary to provide additional training to maintenance personnel. This type of investigative tool differs from the approach usually taken in airline maintenance. Personnel must learn how to look beyond the obvious active failures (errors and violations), in order to determine the latent failures. This, in fact, has been attempted with the introduction of MEDA.

MEDA, or the Maintenance Error Decision Analysis, was developed by Boeing (Hibit and Marx, 1994) in conjunction with various partner airlines. It is designed to capture errors in the system which are not necessarily reportable incidents to other existing reporting systems. It uses a checklist approach to examine the factors surrounding the incident. However, its lack of narrative detail limits its usefulness as a preventive tool. Although data is collected on the existence of many performance shaping factors, airline personnel are not really encouraged to consider *why* particular events occur, or why they contributed to the error. In addition, MEDA is still fairly lengthy, and requires a significant amount of time to complete (1 hour +), which may be perceived as too much time in a hectic maintenance environment. Thus, it is unlikely that all errors will be recorded in the MEDA system. In addition, until all departments are using the MEDA tool, and have a computer system in which all of the MEDA reports are integrated, it will be difficult to share information between the various departments. This latter will apply to any data collection methodology until it achieves widespread use.

Using the design requirements listed above, a prototype incident investigation system has been developed. This Unified Incident Reporting System (UIRS) had a common reporting form for all incidents, whether the incident was a paperwork error, an injury, ground damage or even had no adverse outcome. **Appendix 2** shows the common reporting form and the attachments for

specific outcome types. Both forms were designed using the hazard patterns and analysis presented in this project, with the hazard pattern analysis being seen most clearly in the outcome-specific attachments.

In the common form, a human factors engineer would recognize the breakdown into task/operator/machine/environment, although these have different titles and are in a different order. **Section 5** of this form directs the user to one of a number of specific forms based on the hazard patterns developed. The three outcomes studied here would come under **5A**, **5C** and **5E**, and forms are provided for these. Incidents without specific outcomes, as collected by MEDA, are covered by **5F**. (Note that the developers of MEDA have not allowed us access to MEDA incidents and, thus, we have not developed hazard patterns specific to these incidents). The set of outcome-specific forms can be expanded as needed in future.

**Appendix 2, Number 6** of the form has the analyst and/or the person involved list the active failure and the latent failures. These latent failures come from the common form and the specified probes on each outcome-specific form. Using these latent failures, event trees such as those in **Appendix 1** can be constructed. These form the basis for action recommendations in **Appendix 2, Number 7**. Note that we ask for two possible interventions: a system change and a personal change. This is to reduce the easy reliance of inexpensive and ineffective personnel actions when an incident takes place, and to encourage the analyst to think through more permanent system changes.

At present, the UIRS is being reviewed by our airline partners.

## 7.8 INCIDENT PREVENTION

In traditional maintenance systems, once management is aware of potential errors, they use various methods to train, threaten, motivate, or inform their personnel of the situation. For example, a mechanic involved in a GDI where an aircraft is towed into a hangar wall may receive a reprimand in his personnel folder, and may be sent for additional training on procedures for towing aircraft. A memo may be sent to other maintenance stations (or may be simply circulated at the station of occurrence) reminding people of the hazards associated with towing aircraft. Chances are that another similar event will not occur for some time. After all, aircraft are towed many times daily without incident. However, over time, it would be expected that, unless permanent changes in the underlying latent failure factors are implemented, the mechanics will revert to the same procedures in use at the time of the incident. This is because the latent failures remain in the system to encourage the sub-optimal behavior. Maurino et al., (1995, p. 100) show that incident investigators often condemn the use of improvisation by the workforce, and advocate strict adherence to procedures and the development of additional checklists. However, to be effective, procedures have to be correct, available, credible, and appropriate for the situation at hand; Additional procedures and stricter enforcement will not prevent all errors. We need to ask why the mechanic, for example, thought that the best course of action was to violate the procedures.

Thus, once the latent failures can be identified, other solutions must be implemented in order to prevent future incidents. For example, procedures may need to be rewritten to better suit the

realistic needs and expectations of the mechanics. In a recent example, Pearl and Drury (1995) showed that the specified sequence of steps in overnight checklists would require far more time and effort than an easily-perceived alternate sequence. Under such circumstances it will only be a matter of time before the easier (incorrect) sequence becomes the norm. Management may need to be more conscious of the signals that they are sending to the workforce. Finally, technical solutions may be implemented to help eliminate certain errors. For example, it may be possible to mount mirrors or closed circuit televisions at the gate areas to assist the pushback tug driver in ensuring adequate clearance during aircraft tows.

## 7.9 CONCLUSIONS

Most importantly, it is important to remember that only a small percentage of unsafe acts (errors and violations) lead to reportable incidents. In most cases, the multiple layers and redundancies of system safety defenses act efficiently to protect the system. In instances where the layers of defenses are breached, a number of factors must occur in conjunction to produce an incident (Maurino, et al., 1995). In addition, maintenance personnel typically are very conscientious and would not perceive themselves as intentionally endangering the system. Unsafe acts that are committed are either unintentional, or are done with the very best intentions. Mechanics want to perform their duties as efficiently as possible, and to the best of their abilities. Also, mechanics are especially good at devising innovative solutions to problems they may encounter. These innovative solutions usually work well, but occasionally may become an unsafe act. We need to find ways to safely harness this innovative potential in a highly regulated system.

There are many latent failures in the system that have been created by decisions of the upper management levels of the organization. These decisions filter down throughout the organization, causing inherent latent failures in the maintenance system. For example, the emphasis on on-time performance from upper management encourages mechanics to take short-cuts in order to remain on schedule. Mechanics may choose to use readily available (but unsuitable) access equipment to perform a task, instead of spending the extra time to locate the more suitable equipment. These latent error-producing conditions interact with mental and physical states to generate unsafe acts (Maurino, et al., 1995). Defenses, barriers, and safeguards are imposed in the system to mitigate or block the adverse consequences of these unsafe acts. However, when a defense is weak or missing, the unsafe act is able to penetrate and cause a reportable incident.

In order to prevent mechanics from committing the same errors over and over, it is necessary to learn from the previous mistakes. The latent failures must be identified and confronted in order to be eliminated. In the current error reporting systems, it is very difficult to determine these latent failures so that they continue through understandable neglect. Thus, the current system concentrates on addressing the active failures, or unsafe acts of particular mechanics.

It is necessary to develop a new error reporting system that is able to target the latent failures in the system. This new tool must be able to address the various investigative levels warranted by different types of errors. Such a tool can be developed by using the information learned by examining past errors to develop a set of investigative questions. These questions can then be computerized to facilitate storing, analyzing and acting upon the information.

## 7.10 REFERENCES

- Chandler, J.G. (1995). Putting a Dent in Ground Damage. *Aviation Equipment Maintenance*, 14(6), 22-25.
- Drury, C. G. and Brill, M. (1983). Human Factors in Consumer Product Accident Investigation. *Human Factors*, 25(3), 329-342.
- Fox, J. G. (1992). The ergonomics audit as an everyday factor in safe and efficient working. *Progress in Coal, Steel and Related Social Research*, 10-14.
- Hibit, R. and Marx, D. A. (1994). Reducing the human error in aircraft maintenance operations with the maintenance error decision aid (MEDA). In *Proceedings of the Human Factors and Ergonomics Society 38th Annual Meeting*, Nashville, TN, 111-114.
- Maurino, D., Reason, J., Johnston, N, and Lee, R. (1995). *Beyond Aviation Human Factors*, Hants, U.K.: Avebury Aviation.
- Monteau, M. (1977). A practical method of investigating accident factors. Luxembourg: Commission of the European Communities.
- Pearl, A. and Drury, C. G. (1995 in press). Improving the reliability of maintenance checklists. *Human Factors in Aviation Maintenance, Phase 5: Progress Report*, Springfield, VA: National Technical Information Service, DOT/FAA/AM-95XX.
- Patel, S., Drury, C. G., and Lofgren, J. (1994). Design of Workcards for Aircraft Inspection. *Applied Ergonomics*, 25(5), 283-293.
- Reason, J. (1990). *Human Error*, Cambridge, U.K.: Cambridge University Press.

## 7.11 APPENDICES

### 7.11.1 Appendix 1

## 7.11.2 Appendix 2

### Unified Incident Reporting System

#### 1. The Person Involved

Name \_\_\_\_\_ Age \_\_\_\_\_ Gender \_\_\_\_\_

Years in current job \_\_\_\_\_ Years at airline \_\_\_\_\_ Years performing this task \_\_\_\_\_

Comments on experience \_\_\_\_\_

Describe person's condition at the time of the incident. Include any medical conditions, sleep loss, unusual life events. \_\_\_\_\_

Describe training completed in past five years \_\_\_\_\_

Did person's clothing contribute to the incident? \_\_\_\_\_ If YES, describe clothing worn \_\_\_\_\_



---

---

## 2. What Happened?

Date of Incident \_\_\_\_\_ Time of Incident \_\_\_\_\_

Describe activities on the day of the incident, up to 5 minutes before the incident \_\_\_\_\_

---

Describe activities in the minutes before the incident. Include any events which disrupted the usual sequence: \_\_\_\_\_

2.1 What action was being performed, with the intended result \_\_\_\_\_

---

2.2 What went wrong to prevent this action from being completed as intended? \_\_\_\_\_

---

2.3 Did the person to try to recover? How? \_\_\_\_\_

---

2.4 If damage/ injury occurred, what happened at the moment of impact or injury? \_\_\_\_\_

---

2.5 What damage / injury resulted? \_\_\_\_\_

---

## 3. The environment

Lighting conditions at point of incident \_\_\_\_\_

---

Temperature \_\_\_\_\_ Wind conditions \_\_\_\_\_

Noise conditions \_\_\_\_\_

Other relevant environmental factors (surface condition if slip, distractions if missed sign-off, unstable workstand,...) \_\_\_\_\_

---

## 4. The Equipment involved

Types of equipment	Specific equipment	Identification	Any defects in equipment?	Which defects w
--------------------	--------------------	----------------	---------------------------	-----------------

(aircraft / component / vehicle / tool,.....)	(aircraft type, engine type, vehicle type, wrench size,.....)	Number (if any) worn, .....	(not working properly,	known to person

**5. Results of Incident**

Aircraft Damage	Complete Section 5 A
Equipment / Building Damage	Complete <b>Section 5 B</b>
Personal Injury / Illness	Complete Section 5 C
Delay to Operations	Complete <b>Section 5 D</b>
Operational Incident (e.g. turn-back)	Complete Section 5 E
None, incident recovered successfully	Complete <b>Section 5 F</b>

**5A. Aircraft Damage**

**Questions Pertaining to When Task Was Assigned:**

5A.1 Were proper number of personnel assigned?\_\_\_\_\_If NO, why were the incorrect number of people assigned to this task?

\_\_\_\_\_

\_\_\_\_\_

5A.2 Was the proper equipment (or tools) available?\_\_\_\_\_If NO, why was the proper equipment not available?\_\_\_\_\_

\_\_\_\_\_

Could the proper equipment have been obtained?\_\_\_\_\_If NO, why not? \_\_\_\_\_

\_\_\_\_\_

5A.3 Was the work area properly prepared for the assigned task?\_\_\_\_\_If NO, What preparation was not performed?\_\_\_\_\_

\_\_\_\_\_

Why was area not properly prepared?\_\_\_\_\_

---

**Questions Pertaining to Task Being Performed:**

5A.4 Were ground spotters required for this task?\_\_\_\_\_

- If YES, were spotters used?\_\_\_\_\_ Were the proper number of spotters used?\_\_\_\_\_

If not, why not?\_\_\_\_\_

\_\_\_\_\_ Were personnel available?\_\_\_\_\_

- If NO, why were spotters not used?\_\_\_\_\_

\_\_\_\_\_

Whose decision was it not to use spotters?\_\_\_\_\_

5A.5 Was the proper equipment/tools used for this task?\_\_\_\_\_

- If YES, was it working properly?\_\_\_\_\_ If NO, why was this equipment still in service?\_\_\_\_\_

Describe the problem with this piece of equipment\_\_\_\_\_

Was the mechanic aware of the problem at the beginning of the task?\_\_\_\_\_

- If NO, was improper equipment used instead?\_\_\_\_\_ If YES, why was this equipment substituted?\_\_\_\_\_

What is the implication of this substitution on the task?\_\_\_\_\_

\_\_\_\_\_

What are differences between this equipment and the proper equipment?\_\_\_\_\_

\_\_\_\_\_

Was this equipment working properly?\_\_\_\_\_ If NO, describe the problem with this piece of equipment\_\_\_\_\_

5A.6 Was work area suitable for this task?\_\_\_\_\_ If NO, why was this work area used?\_\_\_\_\_ What should have been performed at this area to better suit this task?\_\_\_\_\_

\_\_\_\_\_

Why wasn't area properly prepared?\_\_\_\_\_

\_\_\_\_\_

5A.7 Did the mechanic's actions follow his intentions?\_\_\_\_\_ If NO, what happened to cause the discrepancy?\_\_\_\_\_

\_\_\_\_\_

5A.8 Was communication satisfactory?\_\_\_\_\_ If NO, were the proper tools available to aid communication?\_\_\_\_\_ Did members of the work crew understand each other?\_\_\_\_\_

\_\_\_\_\_ If not, what were the difficulties encountered?\_\_\_\_\_

\_\_\_\_\_

Could better communication have prevented the error? \_\_\_\_\_ Was the paperwork satisfactory for this task? \_\_\_\_\_ If not, describe the error or inconsistency in the paperwork.

---

---

---

How did the paperwork contribute to the error? \_\_\_\_\_

---

5A.9 Were established procedures followed? \_\_\_\_\_ If NO, what changes were made to the procedure?

---

---

What are the advantages of the changes that were made? \_\_\_\_\_

---

Why were the changes made? \_\_\_\_\_

---

5A.10 Were the established procedures satisfactory for the job? \_\_\_\_\_

- If YES, are these procedures the documented procedures? \_\_\_\_\_ If NO, why has the procedure been routinely violated by personnel? \_\_\_\_\_

---

- If NO, what are the problems with the procedures? \_\_\_\_\_

---

Is this the documented procedure? \_\_\_\_\_ If NO, are violations of the procedure ever enforced? \_\_\_\_\_

What are the advantages of the violations? \_\_\_\_\_

---

Are violations encouraged by management? \_\_\_\_\_ If YES, describe how. \_\_\_\_\_

---

### **5C. Personal Injury/Illness**

5C.1 Was proper safety equipment used? \_\_\_\_\_ If NO, why not? \_\_\_\_\_

---

5C.2 Was task being performed in a restricted (or confined) space? \_\_\_\_\_

5C.3 Were proper number of personnel assigned? \_\_\_\_\_ If NO, why were the incorrect number of people assigned to this task? \_\_\_\_\_

---

5C.4 Were established procedures followed? \_\_\_\_\_ If NO, what changes were made to

the  
procedure? \_\_\_\_\_

What are the advantages of the changes that were made? \_\_\_\_\_

Why were the changes made? \_\_\_\_\_

5C.5 Were the established procedures satisfactory for the job? \_\_\_\_\_

- If YES, are these procedures the documented procedures? \_\_\_\_\_ If NO, why has the procedure been routinely violated by personnel? \_\_\_\_\_

- If NO, what are the problems with the procedures? \_\_\_\_\_

Is this the documented procedure? \_\_\_\_\_ If NO, are violations of the procedure ever enforced? \_\_\_\_\_

What are the advantages of the violations? \_\_\_\_\_

Are violations encouraged by management? \_\_\_\_\_ If YES, describe how. \_\_\_\_\_

5C.6 Did the mechanic's actions follow his intentions? \_\_\_\_\_ If NO, what happened to cause the discrepancy? \_\_\_\_\_

5C.7 Was communication satisfactory? \_\_\_\_\_ If NO, were the proper tools available to aid communication? \_\_\_\_\_ Did members of the work crew understand each other? \_\_\_\_\_

If NO, what were the difficulties encountered? \_\_\_\_\_

Could better communication have prevented the error? \_\_\_\_\_ Was the paperwork satisfactory for this task? \_\_\_\_\_

If NO, describe the error or inconsistency in the paperwork. \_\_\_\_\_

How did the paperwork contribute to the error? \_\_\_\_\_

5C.8 Was the proper equipment/tools used for this task? \_\_\_\_\_

- If YES, was it working properly? \_\_\_\_\_ If NO, why was this equipment still in service? \_\_\_\_\_

Describe the problem with this piece of equipment\_\_\_\_\_

Was the mechanic aware of the problem at the beginning of the task?\_\_\_\_\_

- If NO, was improper equipment used instead?\_\_\_\_\_ If YES, why was this equipment substituted? \_\_\_\_\_

What is the implication of this substitution on the task?\_\_\_\_\_

What are differences between this equipment and the proper equipment?\_\_\_\_\_

Was this equipment working properly?\_\_\_\_\_ If NO, describe the problem with this piece of equipment\_\_\_\_\_

5C.9 Was this injury caused by repetitive motion, or accumulated stress over time?\_\_\_\_\_

5C.10 Was the mechanic aware of the risks and hazards associated with this task?\_\_\_\_\_

If NO, why not? \_\_\_\_\_

## **5E. Operational Incident**

### **Questions Related to Paperwork Errors**

5E.1 Was the sign-off embedded in the text of the workcard?\_\_\_\_\_

5E.2 Is this sign-off illogical and contradictory?\_\_\_\_\_ If YES, does it require the signer to have more than one page of the workcard open at once, or to go between two pages of the workcard?\_\_\_\_\_

5E.3 Is this a sign-off that corresponds to one specific action performed by the signer?\_\_\_\_\_

If NO, what does this sign-off designate?\_\_\_\_\_

5E.4 Do sign-offs match the work sequence of the mechanic?\_\_\_\_\_

## **6. Active and Latent Failures**

From Sections 1 through 5, list all contributing factors.

**Active Failure:** describe the final action which led to the incident, i.e. the immediate cause\_\_\_\_\_

---

---

---

**Latent Failures:** Summarize the failures and conditions which contributed to this incident

## **Personal Factors**

P - 1	
P - 2	
P - 3	
P - 4	
P - 5	
P - 6	
P - 7	

### **Equipment Factors**

E - 1	
E - 2	
E - 3	
E - 4	
E - 5	
E - 6	
E - 7	

### **Environment Factors**

EN - 1	
EN - 2	
EN - 3	
EN - 4	
EN - 5	
EN - 6	
EN - 7	

### **Organizational / Managerial Factors**

OM - 1	
OM - 2	
OM - 3	
OM - 4	
OM - 5	
OM - 6	

**7. Action Recommended and Taken**

Suggest a change to the equipment, tools or procedures to prevent future incidents\_\_\_\_\_

---

---

---

Suggest a change to the person (specific training, motivation etc.) to prevent future incidents\_\_\_\_\_

---

---

---

What action has been taken?\_\_\_\_\_

---

---



# CHAPTER 8

## ELECTRONIC ERGONOMIC AUDIT SYSTEM FOR MAINTENANCE AND INSPECTION

*Gopinath Meghashyam*  
*Information Division, Galaxy Scientific Corporation*

### 8.1 INTRODUCTION

This Audit Program was developed at Galaxy Scientific Corporation, in cooperation with the State University of New York at Buffalo, for the Federal Aviation Administration (FAA), Office of Aviation Medicine (AAM). The purpose of the development task was to integrate a variety of ergonomic audit tools into a comprehensive package. This ergonomic auditing system called "ERgoNomic Audit Program" (or ERNAP), can be used to carry out an ergonomic evaluation of maintenance and inspection operations. ERNAP also can be used to guide designers to build ergonomically efficient procedures and systems. ERNAP is simple to use and applies ergonomic principles to evaluate existing and proposed tasks and setups. It also suggests ergonomic interventions. The package consists of a user interface, an expert system, a help module, a printing module, and a reference database. The user interface supports user learning, guides the user through the steps, describes the less familiar ergonomic principles, allows the user to access on-line help, and is simple to use. The expert system evaluates the user inputs based on the reference database and different models of analysis.

### 8.2 THE AUDIT PROGRAM

From detailed task descriptions and task analyses of maintenance and inspection activities, Drury, Prabhu and Gramopadhye (1990) developed a generic function description that has been used in this audit program. An audit program involves data collection, data analysis, data storage, and results presentation. Data is collected through a series of observations and readings. This data collected is then analyzed based on guidelines and standards. The analysis is then presented to the user in a suitable / useful format. All the data collected, the data analyses, and its results can be saved for later reference if necessary. This entire process can be performed using a manual (paper-based) method or a computer-based method.

Meghashyam (1995) did a comparison of manual- and computer-based methods of ergonomic analyses in which the computer-based method is found to be superior in performance. Pusey (1994) did a similar comparison of ergonomic audits for carpal tunnel syndrome and arrived at a similar conclusion. In practice, a combination of both methods is preferred due to hardware constraints. ERNAP is based on the checklist concept. ERNAP consists of a data collection module, a file handling module, an expert system module, a printing module, and a help module.

**Table 8.1 Classification of Modules in ERNAP**

<b>Human Factors Grouping</b>	<b>Data Collection phases</b>		
	<b>Pre-Maintenance phase</b>	<b>Maintenance phase</b>	<b>Post-Maintenance phase</b>
Information Requirements	1. Documentation 2. Communication	6. Documentation 7. Communication	23. Buy-back
Environment	3. Visual Characteristics	8. Task Lighting 9. Thermal Characteristics 10. Thermal Perception 11. Auditory Characteristics	
Equipment / Job Aids	4. Equipment Design 5. Access Equipment	12. Equipment Availability 13. Access Availability	
Physical Activity / Workspace		14. Hand Tools 15. Force Exertion 16. Manual Mtls. Handling 17. Vibration 18. Repetitive Motion 19. Physical Access 20. Posture 21. Safety 22. Hazardous Materials	

### 8.3 DATA COLLECTION MODULE

The data can be collected directly by using a portable computer, or by using the paper form of the checklists. Data collection is classified into three phases:

- Pre-maintenance
- Maintenance

- Post-maintenance.

In each of these phases data is collected on one or more of the four Human Factors Groupings, following Prabhu and Drury (1992) and Latorella and Drury (1992). **Table 8.1** shows the clear classification of the data collection modules. The Data Collection module consists of twenty-three checklists. A brief description of each checklist is given in the next section.

### 8.3.1 Pre-maintenance phase

Documentation: Concerns itself with information readability, information content: text & graphics and information organization.

Communication: Between-shift communication and availability of lead mechanics/supervisors for questions and concerns.

Visual Characteristics: Overall lighting characteristics of the hanger: overhead lighting, condition of overhead lighting, and glare from the daylight.

Electrical/pneumatic equipment issues: Evaluation of the equipment which uses controls: ease of control, intuitiveness of controls, and labeling of controls for consistency and readability.

Access Equipment: Evaluation of ladders and scaffold for safety, availability and reliability.

### 8.3.2 Maintenance Phase

Documentation: Physical handling of documents and the environmental conditions affecting their readability, i.e., weather and light.

Communication: Communication issues between coworkers and supervisors, and whether or not suggestions by mechanics are taken into consideration.

Task lighting: The overall lighting available to the mechanic for completing the task. Evaluates the points such as light levels, whether personal or portable lighting is used, and whether the lighting equipment is causing interference with the work task.

Thermal issues: The current conditions of thermals in the environment in which the task is being performed.

Operator perception: Operator perceptions of the work environment at present, during summer, and during winter.

Auditory issues: Determine if the sound levels in the current work environment will cause hearing loss or interfere with tasks or speech.

Electric and pneumatic issues: The availability of any electrical/pneumatic equipment, whether the equipment is working or not, and ease of using the equipment in the work environment.

Access equipment: Availability of ladders and scaffolds, whether the equipment is working or not, and ease of using the equipment in the work environment.

Handtools: Evaluates the use of hand tools, whether or not the hand tools are designed properly to prevent fatigue and injury, and usability by both left and right handed people.

Force requirements: Forces exerted by the mechanic while completing a maintenance task. Posture, hand positioning, and time duration are all accounted for.

Manual Material Handling: Uses **NIOSH** 1991 equation to determine if the mechanic is handling loads over the recommended lifting weight.

Vibration: Amount of vibration a mechanic encounters for the duration of the task. Determines if there are possible detrimental effects to the mechanic because of the exposure.

Repetitive motion: The number and frequency of limb angles deviating from neutral while performing the task. Takes into consideration arm, wrist, shoulder, neck, and back positioning.

Access: Access to the work environment; whether it is difficult or dangerous, or if there is conflict with other work being performed at the same time.

Posture: Evaluates different whole-body postures the mechanic must assume in order to perform the given task.

Safety: Examines the safety of the work environment and what the mechanic is doing to make it safer, e.g., meaning of personal protective devices.

Hazardous material: Lists the types of chemicals involved in the maintenance process, whether or not the chemicals are being used properly, if disposal guidelines are being followed, and if the company is following current **EPA** requirements for hazardous material safety equipment.

### 8.3.3 Post maintenance

Buy-back: Usefulness of feedback information to the mechanic and whether or not buy-back is from the same individual who assigned the work.

By using separate modules, ERNAP allows the users to make specific or comprehensive audits.

## 8.4 FILE HANDLING MODULE

The file handling module consists of different options that allows the user to maintain the different audits better. The options that are available to the user are open audit, save as new audit, rename audit and delete audit. To open a previously completed audit, the user selects Audit | Open. By doing this the user can go back to an audit conducted earlier and all the relevant information about the audit, such as the checklists selected for audit, the information entered into these modules, audit description, etc., is displayed again. To conduct audits that are of similar nature, the user can open an existing audit and save this audit as a new audit allowing all the information from the earlier audit to be transferred to this new audit. To do this, the user selects "Audit | Save as new Audit" from the menu. To rename the current audit under a new name, the user selects "Audit | Rename this Audit" from the menu. Finally, Stored audits which are not required can be deleted. This can be done by selecting the menu option Audit | Delete Audit from the menu. Deleting an Audit removes all the information about an audit from the database.

## 8.5 EXPERT SYSTEM MODULE

ERNAP gives the user a feedback on the ergonomic aspects of the activity being audited. If the user wishes a feedback, then, after entering all the information requested by ERNAP, the user can select "Audit | Analyze". This module will analyze all the information entered by the user in the checklists. It does this by using a rule-based expert system, CLIPS. The rules used by CLIPS are based on the research carried out at SUNY Buffalo. The total number of rules used by CLIPS to carry out the analyses are about 300. These rules are fired based on the information that has been provided by the user in the audit checklists. After analysis is completed, CLIPS passes the information to ERNAP which presents the analysis and suggestions in a suitable format.

## 8.6 PRINTING MODULE

This module caters to the printing requirements. The user can print either the checklists themselves with the information entered or without the information entered into the checklists. The advantages of this would be in those situations when it is not possible to get all the information on the computer directly. By printing an empty checklist, the user can collect all the necessary information on a paper based format and enter it later to into ERNAP for carrying out the analysis. To print the module, the user selects "Audit | Print | Modules". Once the analysis is completed, the user can print the analysis as a report. to do this the user selects "Audit | Print | Analysis".

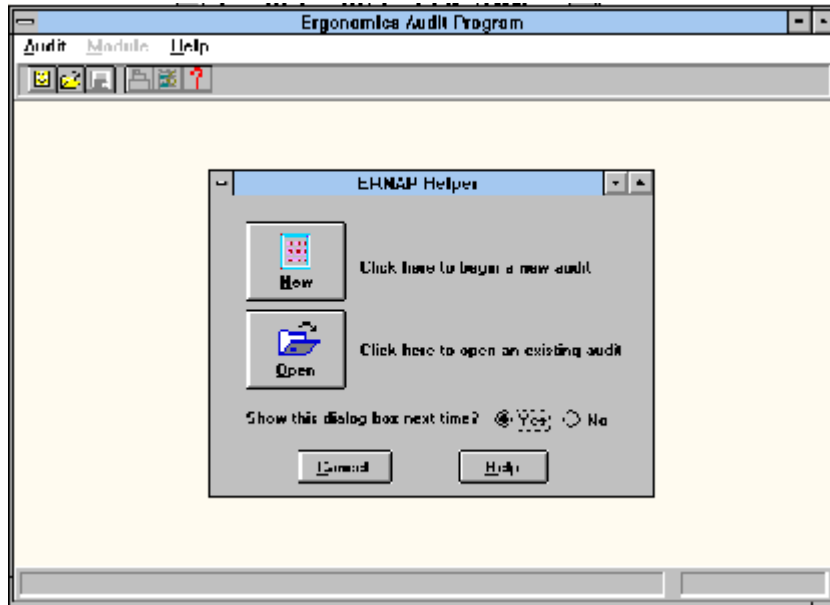
## 8.7 HELP MODULE

ERNAP was designed such that it also can be used by a person who is not necessary well versed with all the ergonomic terminologies. In order to do this, ERNAP provides links to an on-line help. The on-line help consists of hot words, glossary of terminologies, pictures, and diagrams. By providing an on-line help to the user, ERNAP explains the ergonomic terminologies used to get all information about the task being audited. Hot words on the checklists (modules) are linked to the help topics within the help module. The help module also can be referred to in its entirety. A glossary of terms is also provided to help the users better understand the terminology. The users can also directly access the help module by selecting "Help | Help Contents".

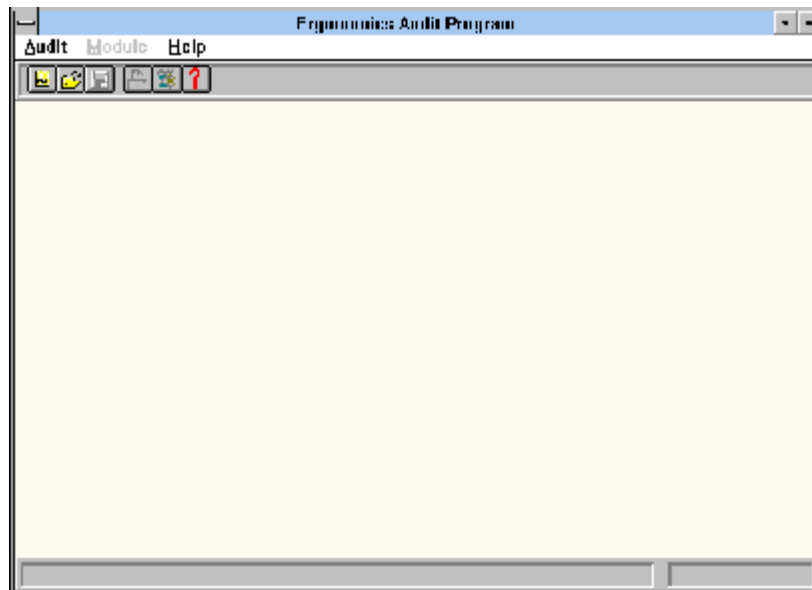
## 8.8 USING ERNAP

On starting ERNAP, the first screen comes up showing information about ERNAP. Following this the next screen comes up as shown in **Figure 8.1**. The user has the option to either select begin a "New" or "Open" an existing Audit. Selecting "Cancel" shall bring the user to the main screen of ERNAP as shown in **Figure 8.2**. ERNAP then waits on the user to either begin a "New" ergonomic audit or "Open" a saved ergonomic audit. By selecting "Open", the user can revisit earlier audits as shown in **Figure 8.3**. Selecting "Begin a New Evaluation" starts a completely new ergonomic audit and selecting "Open an Existing Audit" starts an audit conducted earlier. These options are available to the user in the "pull-down" menus. Selecting either of these (Open or New), brings up a screen that displays the different modules of ergonomic evaluation. The user at this point can select any or all of the ergonomic audits. This can be done by selecting the check boxes provided against each audit, as shown in **Figure 8.4**.

**Figure 8.1 Opening Screen of ERNAP**



**Figure 8.2 Main Screen of ERNAP**



**Figure 8.3 Open Existing Audit**

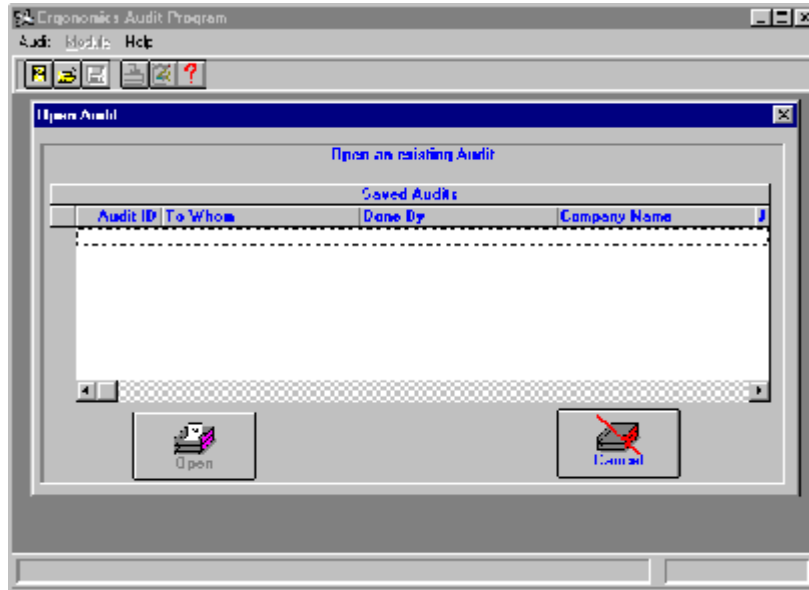
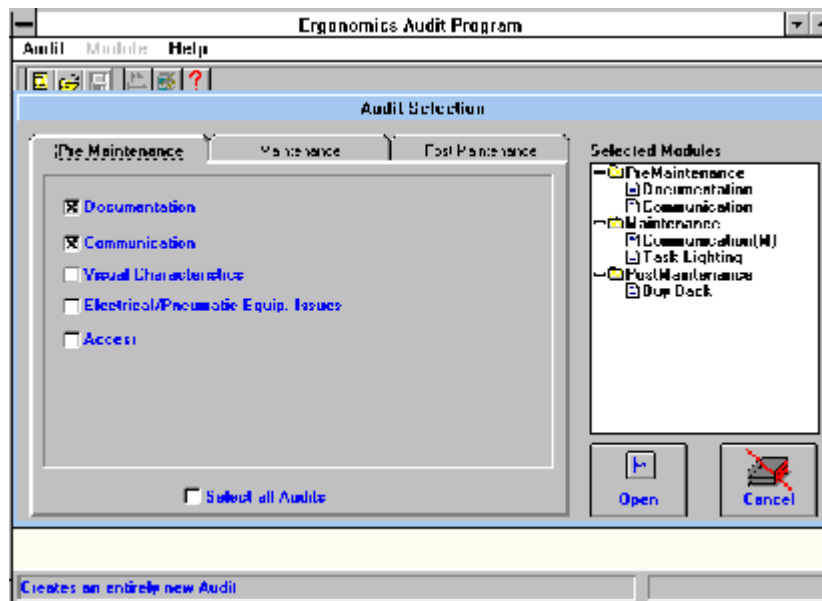
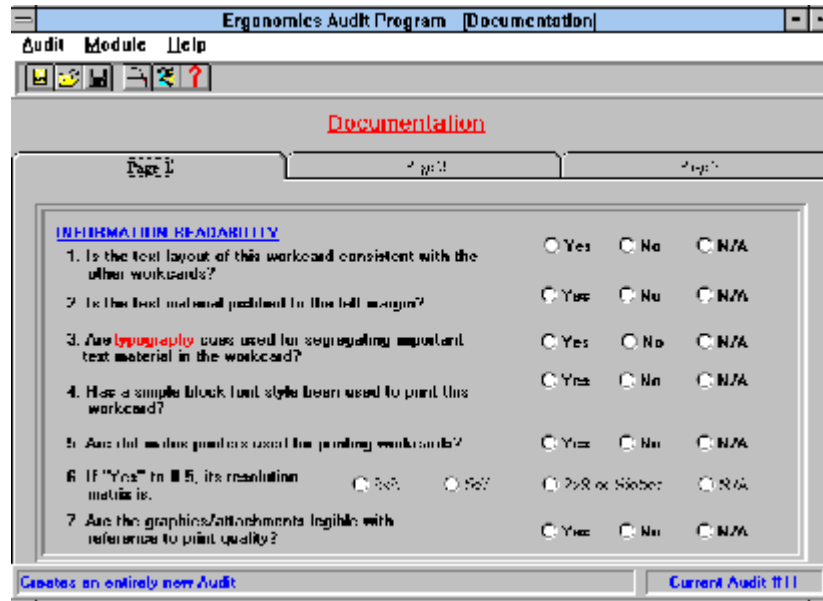


Figure 8.4 Audit Selection in ERNAP



ERNAP will step through only those modules that are selected by the user, thus allowing a partial audit. Once the user has started the audits, ERNAP starts with the first module and presents the user with specific questions related to the operation being audited. **Figure 8.5** shows an example of an audit. ERNAP uses a simple user interface for the input of information related to the operation under audit. The user interface has been developed based on the principles of human-computer interaction.

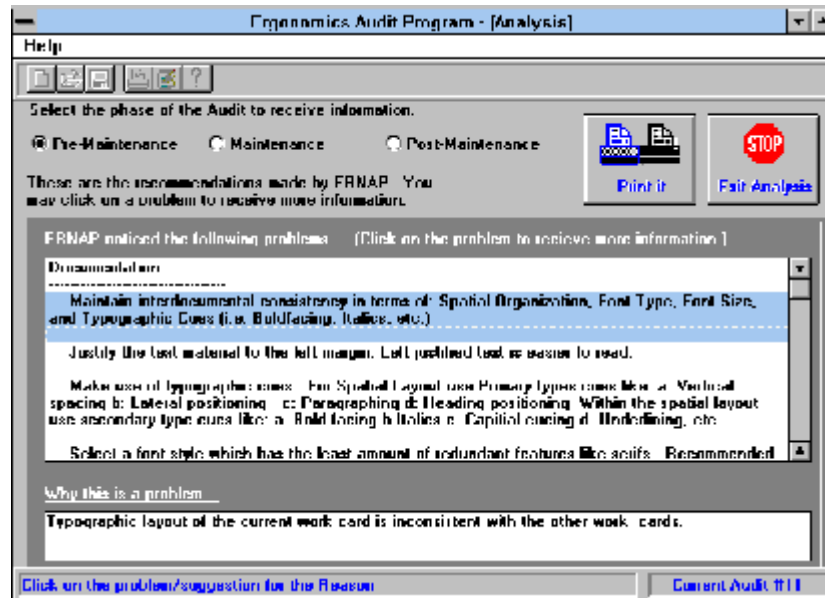
Figure 8.5 Checklist example



The user can either use a "mouse" to make the selections or use the "tab" key in combination with the "enter" key on the keyboard. On each module, help is provided to the user on the terminology used in the questions asked by ERNAP. Clicking the mouse on the hot words brings up more information about that section of the audit. The user can also get general help from the "Help" section of the "pull down menu". This provides information about ERNAP, its developers, and other relevant information. Furthermore, help on the menu item selected is shown in a status box towards the bottom of ERNAP main screen. The user can also directly go to the required audit by selecting the audit module from the "pull down menu". The index tabs help the user move to different sections within each module. The user can exit from ERNAP by selecting the "exit ERNAP" option in the pull down menu. After the user completes all the audits that were selected earlier, the expert system CLIPS, analyzes this information and compares it with the standards database. Based on its analysis, it provides the user with suggestions. The analysis is based on standard models in the Human Factors Literature. This information about its findings and its suggestions is presented to the user, as shown in **Figure 8.6**.

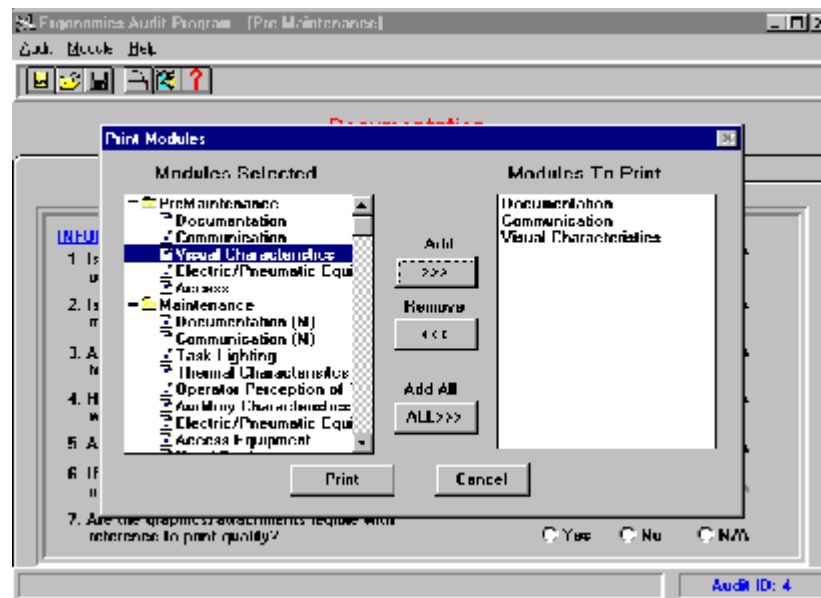
**Figure 8.6 Analysis and Suggestions by ERNAP**



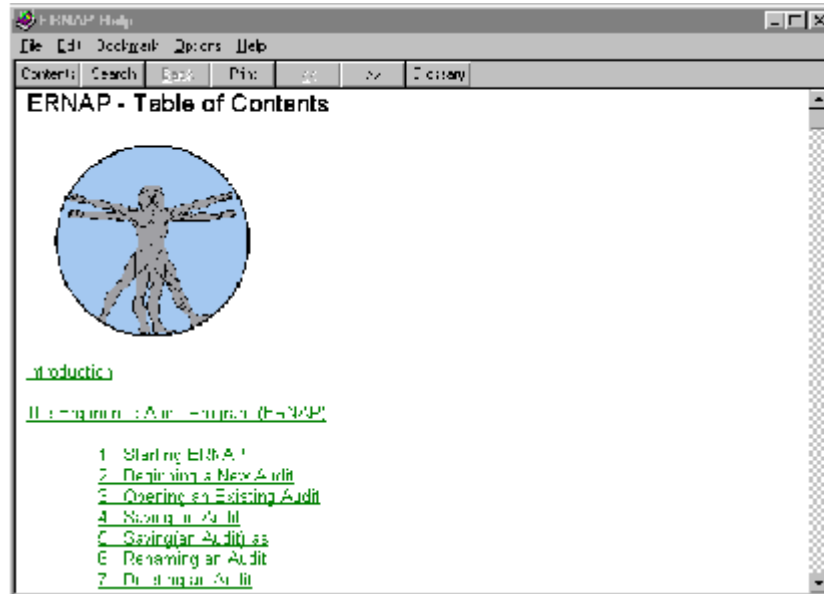


The Expert System module helps update the database, based on new research. Specific information is provided to the user about the operations that were under audit. ERNAP shows the results of the audit to the user when requested. ERNAP also saves this information in a file. This information from the file also can be printed by selecting "print" from the pull down menu. A screen comes up asking the user's choice for printing as shown in **Figure 8.7**. If the user needs help at any point of time, the help module screen comes up as shown in **Figure 8.8**. The help module consists of pictures, definitions, glossary and a detailed explanation about using ERNAP.

**Figure 8.7 Analysis and Suggestions by ERNAP**



**Figure 8.8 Help module of ERNAP**



## 8.9 INSTALLATION, SYSTEM REQUIREMENTS, DISTRIBUTION

ERNAP requires an IBM PC-compatible 486 with SVGA monitor running MS Windows 3.1 and having at least 4MB RAM. However, it is recommended to have 8MB RAM. It has been designed to run in the 640 x 480 resolution, but can adapt to the 1024 x 780 resolution. ERNAP can be installed off the CD-ROM by either double clicking the "setup.exe" under the ERNAP directory, or by running "setup.exe" directly from the File manager (or Program Manager) from within the Windows environment. The program itself occupies 5 MB of hard disk space. ERNAP is available with the CD-ROM for E-Guide, the *Human Factors Guide for Aviation Maintenance* and the CD-ROM titled *Human Factors Issues in Aircraft Maintenance and Inspection '96*.

## 8.10 REFERENCES

- Meghashyam, Gopinath (1995). A Computer based Ergonomic Assessment System for Manual Material Handling. *Master's Thesis*, Dept. of Industrial Engineering, Clemson University.
- Pusey, Edward (1994). A Computer based Ergonomic Assessment System. *Master's Thesis*, Dept. of Industrial Engineering, Clemson University.
- Drury, (1994) Ergonomics on the hangar floor. *Proceedings of the Human Factors and Ergonomics Society 1994*.
- Prabhu, P and Drury, C. G. (1992) A framework for the design of the aircraft inspection information environment. In *Meeting Proceedings of the Seventh Federal Aviation Administration Meeting on Human Factors Issues in Aircraft Maintenance and*

*Inspection*, Atlanta, GA, 83-92.

- Latorella, K. A. and Drury, C. G. (1992). A framework for human reliability in aircraft inspection. In *Meeting Proceedings of the Seventh Federal Aviation Administration Meeting on Human Factors Issues in Aircraft Maintenance and Inspection*, Atlanta, GA, 71-82.
- Drury, C. G., Prabhu, P. and Gramopadhye, A. (1990). Task Analysis of Aircraft Inspection Activities: Methods and Findings, In *Proceedings of the Human Factors Society 34th Annual Conference*, Santa Monica, California, 1181-1185.

# CHAPTER 9

## ADVANCED TECHNOLOGY APPLICATIONS

*Michael Merriken*  
*Information Division, Galaxy Scientific Corporation*

### 9.1 INTRODUCTION

Advanced technology can help maintenance and inspection (M&I) technicians as well as the aviation safety inspectors (ASI's) to achieve the twin goals of safety and productivity. This was demonstrated by the Performance Enhancement System (PENS) which used pen-computer technology. This technology was developed and evaluated in Phase V of the research project. Under the PENS program in Phase V and Work Order 01, Mods 02 and 03, several advanced technologies were evaluated with the goal of identifying applications that could be integrated into PENS. The activities described in this report used the recommendations from these advanced technology evaluations as a starting point. We decided to focus in on the following areas: 1) Development and evaluation of an improved display prototype, 2) Documentation output options for PENS, and 3) Evaluation of specific advanced technologies. We selected these areas because they matched the Flight Standards Service (AFS) requirements for recording and accessing data. Prototypes of these technologies and attributes were integrated into the PENS software and evaluated. The PENS program has since migrated from a research prototype to a pre-operational system that is called the On-line Aviation Safety Inspection System (OASIS). OASIS will be fielded this summer by the Flight Standards Service (AFS) at a limited number of Flight Standards District Offices (FSDO's).

### 9.2 DEVELOPMENT/EVALUATION OF PROTOTYPE FLIGHT STANDARDS AUTOMATION SYSTEM (FSAS) INTERFACE

The purpose of this task was to develop a prototype display to demonstrate how existing AFS reference documents and databases would benefit from the application of a user-centered design approach to display design and data access. This prototype capitalized on graphical user interface (GUI) technologies and Human Factors research on information presentation (color, formatting, direct manipulation, etc.). The prototype emphasized ease of use and information utilization. The research team evaluated this prototype with the Aviation Safety Inspectors (ASI).

#### 9.2.1 Flight Standards Automation System (FSAS): Interface Weaknesses

A detailed study of the AFS database systems (Galaxy Scientific Corporation, 1995) had

outlined the manner in which the ASIs interact with the numerous database systems provided for their use. This study identified several inherent weaknesses that are unique to the Flight Standards Automation System (FSAS). Based on these results we developed a prototype to address some of the important weaknesses in the FSAS interface. The goals of the prototype were:

1. Demonstrate improved FSAS functionality in the Windows environment.
2. Provide data entry guidance to users within the Windows-based FSAS.
3. Demonstrate a more efficient search function within the Windows-based FSAS.
4. Demonstrate an easier way to access supporting screens (e.g., comment screens) within the Windows-based FSAS.
5. Demonstrate how selected Windows-based FSAS subsystems would react if the subsystems were more tightly integrated.
6. Demonstrate how selected Windows-based FSAS subsystems would function if the database was normalized resulting in the elimination of duplicated data between the subsystems.
7. Demonstrate a more efficient text editor for entering comments within the Windows-based FSAS.

During prototype development, several trips were made to the FSDO in Atlanta, GA, to demonstrate the prototype and to gather feedback. The responses received from the ASIs and managers were incorporated in the prototype. During the detailed study of the AFS existing database systems, we had been informed that the AFS is planning to upgrade the existing Paradox database system to a client/server environment in the near future. This prototype also demonstrated some of the benefits that the AFS will realize under the client/server environment.

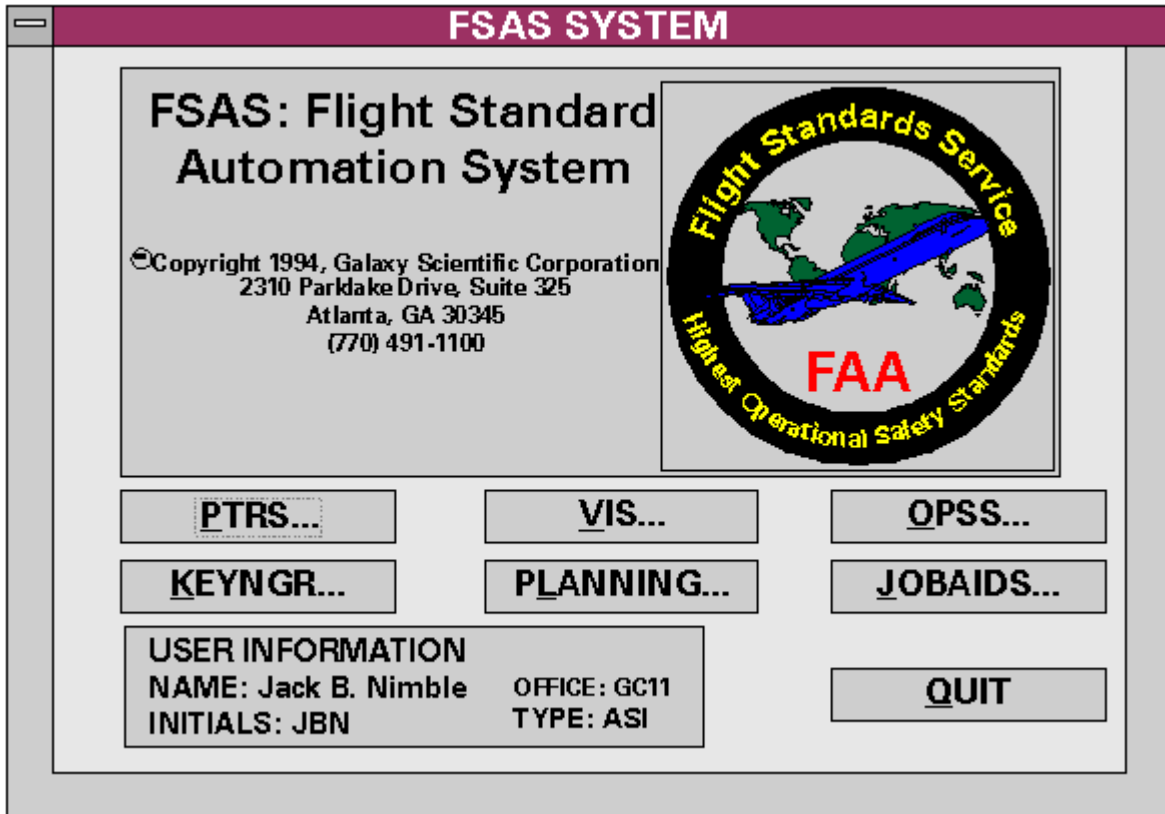
The prototype is not a fully functional FSAS system. It merely demonstrates how some of the FSAS weaknesses can be addressed. The prototype demonstrated enhancements to only two of the subsystems of the FSAS: a) The Program Tracking and Reporting System (PTRS) which enables the FSDOs to compile and track information gathered by the ASIs and b) The Vital Information System (VIS) which enables the FSDOs to maintain information about air operators, air agencies, designated airmen, check airmen, facilities, and organizations engaged in non-certificated activities. However, the issues addressed in these two subsystems are applicable to the other FSAS subsystems as well. The next section describes the prototype and how it will benefit the AFS.

### **9.2.2 The User Interface Prototype**

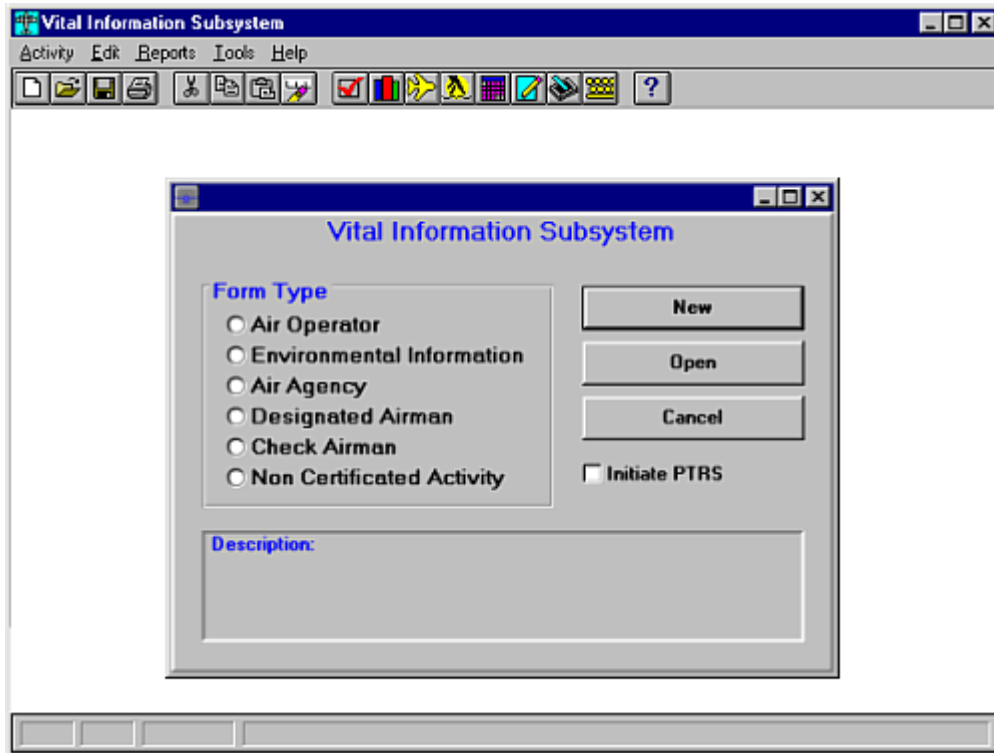
The prototype demonstrates how a Micro Soft (MS) Windows-based FSAS system would operate in a client/server environment and how it would benefit the AFS. Because the FSAS prototype adheres to standard MS Windows design, users who are already familiar with MS Windows will also be familiar with the functionality of the prototype. Each subsystem is designed with the same look and feel and offers similar functionality. Hence, very little time will be spent retraining users to use this system.

The prototype attempts to guide the users through the system. Emphasis is placed on ease of use and on presenting the users with valuable information when appropriate. **Figure 9.1** shows the main FSAS screen. From this screen, all FSAS subsystems (PTRS, VIS, OPSS, KEYMGR, JOBAIDS, and PLANNING) are accessible. The user-id and user information displayed is acquired from the Flight Standard Electronic Office system (FSEO) (Galaxy Scientific Corporation, 1995) which provides a single point of user login. **Figure 9.2** represents the VIS main entry screen that contains the most often used functions.

**Figure 9.1 Main FSAS Screen of The Prototype**

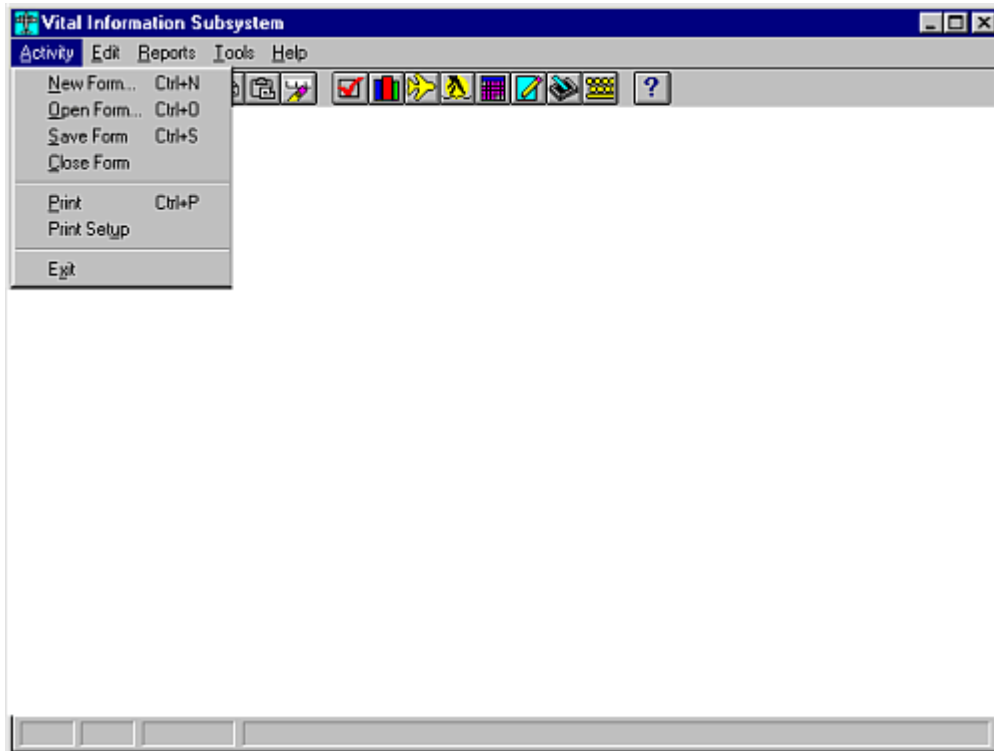


**Figure 9.2 VIS Main Entry Screen**



The screen allows the user to select the appropriate form from the form type section and then selects whether to create a new form or open an existing one. The description on the bottom of the dialog box (**Figure 9.2**) describes the form type that is selected. The main screen also has a menu bar with menu options including activity, edit, reports, tools, and help. The "Open" and "New" options presented in the dialog box on the main screen also can be accessed from the Activity menu option. **Figure 9.3** is a representation of this menu option.

**Figure 9.3 Activity Menu Option**



The Edit menu option (**Figure 9.2**) offers the standard edit options available in the Windows environment such as Cut, Copy, Paste, and Clear. These options under the Edit menu allow data to be copied within or between applications. The Reports menu option will provide access to pre-defined reports and to the ad-hoc reporting system. The Tools menu option provides quick access to the PTRS and VIS subsystems. The Tool Bar located at the top of the screen contains icons and provides the same functionality as the menu items. The tool bar icons can be used to gain quick access to frequently used applications. A balloon help function was integrated into the prototype so that whenever the cursor is moved over an icon on the Tool Bar a brief description of the item is displayed.

### 9.2.3 Implications of Moving to Windows

The current implementation of FSAS is a DOS-based, Paradox-driven application that is not compatible with the MS Windows operating environment. The ASIs and other AFS users often use several windows-based software packages along with FSAS on a daily basis. Both FSAS and the MS Windows Operating System cannot operate simultaneously on the ASI's desktop computer. Therefore, if a user is in FSAS and he/she needs access to an MS Windows-based software package, the user will be required to exit FSAS and then start the Windows Operating System. It is the intention of the AFS to convert all of the major safety-related database systems to run within MS Windows. When this takes place, the ASIs and other AFS users will no longer be required to exit one subsystem in order to start another. This will reduce the time and effort it takes to access these subsystems.

In addition, by having all major systems running under the MS Windows environment, data can



be easily transferred within and across subsystems. For example, if an ASI needs to write a memo in MS Word and he/she needs to reference information in FSAS, this information can be transferred from the appropriate subsystem to the memo directly by using the standard cut and paste functionality in MS Windows.

Another advantage of having all major database systems running in the MS Windows environment is that several safety related subsystems can be run simultaneously. Therefore, a user can potentially have PTRS, VIS, and OPSS running at the same time, which is important if the user needs to copy information across subsystems. The only limit to the number of subsystems that can be up and running simultaneously is the amount of memory that is installed on the user's desktop computer.

Although the AFS will eventually migrate its major applications to the MS Windows environment, this will take time. This will result in some systems continuing to reside on the mainframe computers before the transition is complete. However, access to the mainframe via MS Windows will not be a problem as there are several software packages on the market that effectively address this issue. Procomm for Windows and IBM Personal Communication System are two such packages that allow users working in the Windows environment to access the mainframe. This will allow a user to cut and paste information from mainframe applications to Windows-base PC applications.

## 9.3 DOCUMENTATION OUTPUT OPTIONS FOR PENS

The PENS program currently provides an unformatted report option to print out a transmittal record. The ASI who uses PENS still needs to fill out an original form to sign and give to his/her supervisor to approve. It would obviously be more convenient if PENS could print out formatted reports that closely resemble the original forms. This activity evaluated different print applications to print out forms from PENS. The PTRS form was used as a sample form to be printed. We met with ASIs to discuss various issues to be considered when printing out a form. Then different ways of printing the forms were considered

### 9.3.1 Printing a Form

There are two steps to print a form. First, the form has to be digitally re-created and secondly, the form populated with data has to be printed out. We looked at existing applications in which the forms could be designed easily. These applications also had to provide programming interfaces so that the PENS program can communicate with them to print the forms. There are two characteristics of the PTRS form affecting the ease of creating the form: data model and the layout of the form.

#### Data Model

The data on the PTRS form contains four sections: 1) Transmittal general information, 2) Personnel information, 3) Equipment information, and 4) Comment. These data are stored in different database tables. Section 1 is stored in "Master" table while the rest of data are stored in

"Detail" tables. It was discovered that different applications support different data models. Some do not support Master-Detail tables but only support a single table for each form. For such applications, we need to retrieve the data from multiple tables and save them into a temporary table. Later the application will use the temporary table as the data source to print the form.

### **Layout of The Form**

On the PTRS form, the master data are located on the left. The Detail tables are below and to the right of it. The layout is critical because some applications may not support random placement of data. These applications usually allow Detail data to be put below the Master data rather than next to it.

### **9.3.2 Programming Interface**

The common programming interfaces that applications provide include: development library (DLL), custom control for development (VBX), Dynamic Data Exchange (DDE), Object Linking and Embedding (OLE), and simple languages like scripts or macros. Usually DLLs and VBXs provide more low-level functions and are more powerful. They also take up fewer resources than the rest of interfaces. Since PENS is a large software application and uses up significant computer resources, it is better to choose applications that use fewer resources in order to avoid interference with PENS. Moreover, it is easier to program and control using DLLs and VBX. If the application does not provide any interface, other work-around methods will need to be found in order to use that application.

### **9.3.3 Applications Evaluated**

Three applications were studied for the design and printing of forms: 1) Crystal Reports by Crystal Computer Services, 2) OmniForm by Caere Corporation, and 3) FormFlow by Delrina Corporation. FormFlow was selected for further evaluation due to better compatibility with the existing PENS software

#### **OmniForm**

This application was very easy and fast to create the layout of the PTRS form. First, the paper form was scanned into the computer and a digital image of the form was produced. The image was then imported to OmniForm where the application automatically generated an electronic form that looked exactly the same as the inputted form. Depending on the quality of the image, some recognition mistakes like spelling mistakes and some missing lines may have to be fixed. OmniForm was able to recognize most of the fields on the form. Only a few fields had to be added or deleted. The time it took was less than an hour per form, if the developer is familiar with OmniForm.

However, OmniForm only allows one table for each form. That means Master-Detail feature is not supported. Therefore, a single table had to be created containing all the data of the transmittal record. The data was then imported to the form and the form was printed out.

There is another weakness of OmniForm. It does not have a programming interface with other applications. It may be possible to print out a form by sending messages from PENS to OmniForm to simulate key strokes entered by a user. However, this method is fragile and most programmers would try to avoid using such a method. Much time was spent scanning in the forms and writing the conversion program that stores data to a single table.

### **Crystal Report**

Crystal Report supports Master-Detail table structure on the report. However, Crystal Report is more like a general report generator that expects data flow to be from top to bottom. It only allowed detail data to be placed below the master data but not next to it. If Crystal Report was used to print out the forms, a temporary table would need to be created in order to put all the data on the report. So, even though it has the Master-Detail feature, we were not able to take full advantage of it. Designing a form was straight forward. It was easy to insert a field into the report form, but it was difficult to position the field exactly where we wanted it. Crystal Report comes with VBX custom controls which can be used with Visual Basic making it easier to program and control. Most of the effort was expended on how to create the Master-Detail linkage; this was **not** a minor task.

### **FormFlow**

A key capability of FormFlow is that it supports Master-Detail data structure and it also supports random placement of data. Therefore, no data conversion was needed. Data was read directly from the original tables containing the PTRS transmittal record. Designing the form was simpler than using Crystal Reports. The Data fields were generated directly from the data file. Master-Detail linkage also was defined easily. The FormFlow application that was tested was a stand-alone application version. PENS can print a report by starting the application with a macro file that prints the report automatically. PENS can also start the application and communicate with FormFlow using Dynamic Data Exchange (DDE). Moreover, FormFlow has a programming interface that PENS can use without using macros or DDEs. We spent a longer test period on FormFlow compared to the other two applications due to the better compatibility with the existing PENS software. The following sections describes the tasks that were completed in order to print out a correct PTRS report from FormFlow.

## **9.3.4 Form Flow Evaluation**

### **Master and Detail Tables on the Report**

The first thing we tried was to create a report of all transmittal records. We defined the data tables and linkages between tables. However, only the data from the Master table showed up and the data from the Detail tables were missing. Detail tables were linked to the Master table by the transmittal record ID and the inspector office code. These data were stored in two separate fields in the master table. In the detail tables, the same data were combined and stored in a single field. At that point, we thought it was because the linkages were abnormal and that FormFlow was not

able to handle it. We then had to find another way to print out the report.

### **Report with a Temporary Table**

We recognized that no matter what method we chose to print, we still needed to find a method for PENS to specify which transmittal record it wanted to print. So we created a temporary table. This table contained the transmittal record ID, the inspector office code, and combined information of these two. This table not only was used to specify the transmittal record but also acted as a bridge between the Master table and the Detail tables. This method worked and the data was correctly printed on the report.

### **Report Using SQL Tables**

The report was created using Paradox tables. We then duplicated the report using SQL tables instead. This second report worked fine and showed and printed the data correctly.

### **Running from PENS**

At the beginning, these two methods for printing reports were tested without PENS. That means we started the FormFlow application itself and opened the reports manually. We then converted the PENS application to print the report from within itself. The report using Paradox tables printed the form and the data correctly when it was run by itself and when it was run from PENS. However, the report using SQL tables was different. It printed the data and the form correctly if it was run by itself. If it was run from the PENS application, the report was printed without the data.

To determine why this occurred we tried several approaches. When PENS printed out the report, it actually started the FormFlow application and then commanded the application to print the report. At that time, we thought PENS took up too many resources so that FormFlow could not run properly. Then we tried running the FormFlow before running PENS. It turned out that FormFlow still could not work properly when it was with PENS. Then we asked for technical support from the manufacturer of FormFlow, Delrina. They told us the problems may be caused by the SQL server. Then we tried to vary the settings on the server but that did not work. We talked to the technical support people several times without any success. The last thing we tried was to increase the conventional (based) memory in DOS. It was done by loading a lesser number of programs in DOS before we ran Windows. The report printing then worked correctly. All data showed up on the report. This behavior of FormFlow shows that it is very sensitive to the amount of conventional memory available.

### **Summary**

If the memory can be configured properly, FormFlow would be the best choice to print a form report. The forms are easy to design and can be easily integrated with PENS. Crystal Report would be the second choice. The main advantages of Crystal Report are that it is not sensitive to the amount of memory available and can be programmed easily. However, it takes longer to design the report and to integrate with PENS.

## 9.4 EVALUATION OF ADVANCED TECHNOLOGIES

The goal of this task was to identify appropriate applications of emerging advanced technology to support current and future activities of the FAA and aviation industry areas. These advanced technologies included mobile computing applications and personal digital assistants.

### 9.4.1 Evaluation of New Computing Technologies

The future deployments of mobile computing applications for the AFS will be dependent on the notebook computers in production at that time. We reviewed the current technical literature and developed a list of specifications that would meet the current needs of the aviation safety inspectors and those needs in the future. This information is contained in **Table 9.1**.

**Table 9.1 Desirable Features For A Mobile Computer**

1. Upgradable processor
2. Rugged internal CD-ROM drive
3. Daylight readable display
4. Two Type II/one Type III PCMCIA drives
5. Large hard drive
6. Docking Station option
7. Reputation for low maintenance
8. Manufacturer has good reputation for customer service.

We identified two computers that met these criteria. These computers were manufactured by leading computer companies, and cost under \$5,000 retail. They were -- the Toshiba 2150 CDT and the Panasonic CF-41. **Table 9.2** is a comparison of these two units. We contacted these manufactures and were provided with a computer for a brief evaluation period.

Upon their arrival, we loaded the current version of the PENS software and tested its ability to run the application. Both computers proved to more than adequate to support the application. No problems nor deficiencies were found with either computer and the PENS software.

**Table 9.2 Comparison of The Selected Mobile Computers**

Computer	Process or	HDD	RAM	CD-R OM	Pointing Devis	Weight	Battery	Dock Stati
<b>Toshiba T2150</b>	486/75	540 MB	8 MB STD + 8 upgrd	2x	Accu-point	6.9 lbs.	NiMH	No, p replic onl;
<b>Panasonic CF-41</b>	486/100	810 MB	16 MB	2x	Integrated Trackball	8 lbs (9 lbs w/ 2nd bttry)	NiMH <b>(I)</b>	Ye: witl moni stan

The computers were evaluated using the PENS software for a whole week. The following observations were made:

### **Durability**

These computers will be taken on the road by the ASIs and therefore exposed to rougher treatment compared to a computer that would remain on a desk. Therefore, durability was a prime consideration. The CD-ROM drive design on the Panasonic CF-41 computer is located under the keyboard and is a much stronger mechanical design and less susceptible to damage than the slide-out carriage found on other computers. A damaged CD-ROM drive will result in the loss of the on-line reference material.

### **Desk Space**

We noted that in most FSDO offices, the ASIs have minimal desk space. We therefore rated highly a desktop solution that minimizes the requirement for desk space. The Panasonic CF-41 computer utilizes a Docking Station concept that minimizes the desktop space requirements by stacking the monitor on top of the docking station and provides internal card slots for expandability. The Toshiba 2150 uses a port replicator that does not contain these features.

### **Cursor Control**

The majority of inspectors had an opportunity to operate our test notebook computers preferred the trackball provided by the Panasonic computer over the "Accu-point"/Track-point" devices found on the Toshiba 2150 and other computers.

### **Battery options**

The Panasonic computer's battery configuration was found to be superior. A second battery can be used in place of the 3.5 inch floppy drive for longer field use while retaining the CD-ROM drive. This feature is unique to the Panasonic computer. The Toshiba 2150 has no extra battery options. On the other hand, the Toshiba does use an integral ac adapter that obviates the need for an external adapter required by the Panasonic.

### **Sunlight Readable Display**

The Panasonic was the only computer that has a special capability in its display unit that increases its sunlight viewing contrast. The display panel is also protected with a rugged magnesium cabinet to better withstand the rigors of mobile use.

### **Maintenance**

The Panasonic and the Toshiba come with a three-year warranty.

### **Availability**

The final consideration was that the Panasonic computers, plus docking stations, were in-stock and available to be shipped immediately. This availability issue was in question for the other computers based upon conflicting statements from several value-added resellers.

At this point in time it is our opinion that either of these computers would be a good choice for the program but our preference is for the Panasonic CF-41.

## **9.4.2 Personal Digital Assistants for PENS**

We performed a study on the feasibility of using a Personal Digital Assistant (PDA) for data collection and information retrieval purposes with the PENS program. The Sony MagicLink PDA was used to conduct this evaluation. The Sony MagicLink interface with PENS was addresses in five areas: Physical Configuration, User Interface, Communication, Software Development, and Application Areas.

### **Physical Configuration**

The MagicLink PDA is small in size (about 8 in. x 6 in.) and very light weight (1.3 lb.) making it easy for an Aviation Safety Inspector (ASI) to carry it around. However, due to its small size, it also has a small display screen. This limits the amount of information that can be either entered or viewed on a single display. The MagicLink does not have an attached physical keyboard. Data entry is accomplished by one of three methods: 1) Using the stylus device for selecting data from pick lists or utilizing the handwriting recognition feature, 2) Using the software keyboard on the screen, and 3) Connecting an external physical keyboard. The last option is the least desirable based upon the results of the earlier PENS evaluation in Phase V. In this evaluation the ASIs did not like to have additional equipment attached to the primary computer because it was too easily lost or damaged.

The MagicLink comes with a standard one megabyte of storage and can be extended to two megabytes by adding a memory expansion card. Unfortunately, this storage capacity is so small that it will not meet the needs to the current PENS program. A reduced capability version of the application could be developed in the future specifically for a PDA.

### **User Interface**

The user interface of MagicLink makes use of the "desk" and "hallway" metaphors. It is intuitive and easy to use though limited in features because of the minimal processing power, screen size, and memory storage. The common input and output controls are text boxes, check boxes, radio buttons, command buttons, list, and icons. All of the controls allow only small amount of information to be displayed at one time. For instance, a long narrative describing an aircraft accident would be difficult to write and edit in a text box due to the fact that only several lines of text could be viewed at any time. The text box would be more appropriate for small inputs like a Model Number or a Name Code. Also, large databases commonly used within the AFS's Program Tracking and Reporting System (PTRS) would not be accommodated by Magic Link's look-up lists. Check boxes or options buttons would be suitable for responding to questions with Yes/No answers.



## Communication

One of the strong points of the MagicLink PDA is its communications capabilities. There are a number of ways for MagicLink to communicate. It can connect through a telephone line to a number of services like AT&T Personal Services, America On-line, and CompuServe. Mailed messages with data can be sent or received using these services. There is a third-party terminal emulation program through which Magic Link can be connected to different bulletin board system (BBS) or different servers. Data can then be transferred via these networks. MagicLink can also be directly connected to a personal computer using a special cable and a software application called Magic XChange. Using Magic XChange, files and data can be saved to, or retrieved from, MagicLink. When used within the limitations identified earlier, being able to collect data using a PDA and then uploading the information to the PENS system is the area of interest.

## Software Development

The only software development tool that is currently available for Magic Link is called Code Warrior. It is an add-on tool to the Macintosh Programming Workshop that is a programming environment on a Macintosh computer. Applications have to be developed on the Macintosh and tested using a MagicLink Simulator on the Macintosh before porting to the PDA. There is another software application called FreeStyle which allows a user to develop simple forms' applications on MagicLink directly. This application will allow the creation of input boxes, option buttons, lists, check boxes, and signature blocks on these forms. Once the data has been collected, it can be transferred back to a workstation and stored in a number of different database formats. FreeStyle also has a script language that can be used to perform some simple data processing.

## Application Areas

The application areas for the PDA are limited because of limited capabilities of the user interface. Applications like a small checklist or small reports would be suitable for this operating environment. Generally, the inputs and outputs of an application have to be simple for use on the MagicLink PDA. They have to be segregated into smaller pieces of information. For the PTRS form, this would apply to the fields of inspector name, completion date, activity time, personnel position, manufacturer's remarks, etc. Based upon our evaluation of the product, if information can be organized well and broken down into small groups, MagicLink can be a useful tool for data collection.

## **9.5 CONCLUSION**

A user interface prototype was developed and evaluated to enhance some of the observed weaknesses in the Flight Standards Automation System (FSAS). This prototype was well received by the FSDO managers and the ASIs. They all felt that this interface would improve task performance. Applications to design and print forms within the PENS program were



investigated. It was concluded that FormFlow would be the best choice to print a form report. A list of specifications was developed for notebook computers to meet the mobile computing needs of ASIs. Two computers meeting these specifications were evaluated and found to be equally good. Finally the Sony MagicLink personal digital assistant was evaluated for data collection and information retrieval purposes. It was concluded that it could be a useful data collection tool for small checklists or reports.

## 9.6 REFERENCES

Galaxy Scientific Corporation (1995). *A Human Factors Study of Information Dissemination and Display for the Flight Standards Service* (Contract No. DTFA01-94-C-01013, Work Order # 2). Washington, DC: FAA/AAM.

# CHAPTER 10

## SUPPORT OF INSPECTION RESEARCH AT THE FAA TECHNICAL CENTER AND SANDIA NATIONAL LABORATORIES

*Colin G. Drury, Ph.D.*  
*State University of New York at Buffalo*

### 10.1 INTRODUCTION

The National Aging Aircraft Research Program of the Federal Aviation Administration (FAA) Technical Center has defined its goals for maintenance and inspection research in its National Aging Aircraft Research Plan (1993). Two specific areas are Visual Inspection and Non-Destructive Inspection (NDI) reliability. In both of these areas there must be explicit recognition of the interaction of the human inspector and the technology employed to detect the particular defect condition. C.G. Drury was tasked with providing human factors support for some of these activities. A paper presented to the FAA's Ninth Meeting on Human Factors Issues in Aircraft Maintenance and Inspection at Atlantic City in June, 1995 (Drury, 1995a) showed how the two traditions of human factors in inspection and inspection reliability measurement interact, and how they are closely integrated in the FAA's Visual Inspection Research Program (VIRP).

In addition to attendance at this meeting and the Airline Transportation Association's (ATA) NDI Forum in Hartford (CT) in September, 1995, the support for the FAA Technical Center inspection programs comprised three elements in 1995. The first was to help conduct and analyze the VIRP Benchmark study at the Aging Aircraft Non-Destructive Inspection Center (AANC), and help design future studies. The second (closely related) was an enhanced visual inspection evaluation performed at AANC in conjunction with a visit by the International Association of Machinists (IAM) in April, 1996. Finally, C.G. Drury joined with FAA and CAA (Civil Air Authority) (UK) representatives to undertake a quantitative comparison of recent NDI reliability studies performed by these two organizations.

### 10.2 VIRP BENCHMARK EXPERIMENT

Drury (1995b) provided details of the design of the VIRP Benchmark study. To summarize, the objective was to measure the reliability of airframe structural visual inspection for a representative sample of inspectors from major airlines, using AANC's high-cycle B-737 airplane as the test specimen. This aircraft had already undergone a detailed check, the Baseline Study (Roach, 1993) to determine what defects existed on the airframe. From the structural inspections carried out as part of the Baseline Study, the following ten workcards were selected

to represent high and low levels of difficulty of access, and high and low levels of visual complexity:

**Task 501** - Midsection Floorbeams. This task involved the inspection of the midsection fuselage floor beams from Body Station (BS) 520 to the aft side of BS 727. It included web, chord, stiffeners and seat tracks, and upper flanges of floor beams, overwing stub beams at BS 559, 578, 597, 616, and 639.

**Task 502** - Main Landing Gear Support. This task was for inspection of the main landing gear support fittings for the left and right main landing gear support beam and side strut attachments at BS 685, 695, and 706 for cracks and corrosion.

**Task 503** - Midsection Crown - Internal. This task was for inspection of the internal midsection crown area stringers and frames from BS 540 to BS 727A from stringer 6L to 6R and tie clips from stringer 7L to 7R for cracks and corrosion.

**Task 504** - Galley Doors - Internal. (The galley doors are the two doors on the right side of the aircraft.) This task was to inspect the galley door frames hinges, latches, locks, seals, actuating mechanisms, and stops and attachments for cracks, corrosion, and general condition (i.e., wear, deterioration).

**Task 505** - Rear Bilge - External. This task was for inspection of the rear bilge (belly) area from BS727 to BS 907 between stringers 25R and 25L, including lap splices, for bulges in skin, skin cracks, dished/deformed/or missing rivet heads, and corrosion.

**Task 506** - Left Forward Upper Lobe. This task was for inspection of the interior of the left fuselage upper lobe from BS 277 to BS 540 and from Stringer 17L (floor level) to Stringer 4L for corrosion, cracks, and general condition.

**Task 507** - Left Forward Cargo Compartment. This task was for inspection of interior of the left fuselage lower lobe from BS 380 to BS 520 from stringer 18L to the keel beam (centerline) for corrosion, cracks, and general condition.

**Task 508/509** - Upper and Lower Rear Bulkhead Y-Ring. This task was inspection of the aft side of the Y-ring of the fuselage bulkhead at BS 1016 (aft pressure bulkhead) including Bulkhead outer ring, "Y" frame aft chord, steel strap and fastener locations on all stringers for cracks, corrosion, and accidental damage such as dents, tears, nicks, gouges, and scratches.

**Task 510** - Nose Wheel Well Forward Bulkhead. This task was for inspection of the aft and forward side of the nose wheel well forward bulkhead at BX 227.8 for cracks.

**Task 701** - Simulated Lap Splice Panels. This task was for inspection of 30 feet of simulated Boeing 7387 lap splice and one large unpainted naturally cracked panel. The simulated lap splice was artificially cracked. The setup of the lap splice simulation and the large panel were the same as was described in Spencer and Schurman (1994).

Note that task 701 was included to provide a direct comparison with the earlier NDI reliability study of the same panels (Spencer and Schurman, 1994). To ensure that study inspection represented good practice in the industry, a standard inspection tool kit was provided and all workcards were prepared following the guidelines of Patel, Drury and Lofgren (1994). The

thermal, visual and auditory environments in the AANC hanger were all representative of inspection practice. Twelve inspectors were tested in the Benchmark study, all volunteers supplied by major airlines. Each spent 2-1/2 days at AANC undergoing a number of pre-tests, performing the ten tasks and being briefed/debriefed.

Measurements were made of the time taken for each inspection task and the defects called out by each inspector. All inspections were video taped so that more detailed analysis would be possible other than merely counting missed defects and false alarms.

A number of results have been analyzed by the VIRP research team (F. Spencer, AANC; D. Schurman, SAIC; C. Drury, SUNY). The interpretation of results in visual inspection on a real airplane is more complex than that for inspection of well-defined materials (e.g., rivet sites on panels) for well-characterized defects (e.g. cracks of specific length). First, there are many types of defect (see classification in Drury, 1995b) which may be reported under different names by different inspectors. Second, not all of the defects existing in each task were found in the earlier Baseline inspection, so that each defect site marked in this Benchmark study had to be checked (visually and with NDI where appropriate) before it could be classified as a hit or a false alarm. Third, inspectors often treated corrosion as an area affected, for example along a stringer, rather than calling out each patch. Their rationale was that a single call for the whole affected length of the stringer would lead to a single repair action so that specifying each "corrosion defect" was both unrealistic and unnecessary. Finally, to preserve the test bed for future inspections, the inspectors were specifically instructed not to permanently mark the airplane. In their normal inspection practice they would be expected to rub, scratch or scrape at a defect site to confirm, for example, cracks or corrosion.

Because of these difficulties of interpretation, analysis began with the best-characterized defects, i.e., the test panels (**Task 701**) and the tie clips in the midsection crown internal (**Task 503**). Fuller analyses of the data are contained in a report being finalized by the VIRP team, so only the three aspects for which C. Drury was primarily responsible will be covered in this report.

## 10.2.1 Pre-Tests and Individual Differences in Inspection

First, because of the consistent finding of large inspector-to-inspector differences in performance (e.g., Spencer and Schurman, 1994), and the success of task-related pre-tests in predicting some of these differences (e.g., Drury and Wang, 1986), a number of demographic and pre-test measures were taken for each inspector. Originally, there were 38 variables covering aspects of the individual (e.g., age), experience (as AMT, as inspectors), visual functioning (e.g., near and far acuity), mechanical aptitude (Bennett Mechanical Comprehension Test) and cognitive factors (e.g., perceptual style, attention). For the twelve inspectors tested, Factor Analysis were used to find groups of variables which were highly intercorrelated. From each of these groups the variable with the highest factor score was taken as representative. This procedure reduced the number of inspector variables from 38 to 10. A final Factor Analysis of this reduced set of ten variables confirmed that they were measuring independent qualities of the inspectors. The ten variables used as pre-test measures were:

- Age (years)

- Experience as an inspector (years)
- Post-high school education (years)
- Time since Past B-737 inspection (days)
- Far Visual Acuity (Snellen score, both eyes)
- Near Visual Acuity (Snellen score, both eyes)
- Peripheral Visual Acuity (time to complete task)
- Field Independence cognitive style - Embedded Figures Test (EFT) score
- Mechanical Aptitude - Bennett Mechanical Comprehension Test (BMCT) score
- Attention Memory - Weschler Adult Intelligence Scale (WAIS) digit span total score

This set of individual characteristics was then correlated with speed and accuracy measures from the overall experiment and from the two tasks (503 and 701) analyzed in detail. These performance measures were:

- Probability of hit (701)
- Probability of false alarm (701)
- Discriminability,  $d'$  (701)
- Inspection Time (701)
- Probability of hit (503)
- Probability of false alarm (503)
- Discriminability,  $d'$  (503)
- Inspection Time (503)
- 50% point on Probability of Detection (PoD) curve score (503)
- Total inspection time (all tasks)
- Total number of defects called (all tasks)

There were 110 possible intercorrelations between the pretest measure (1-10) and the performance measures (1-11). Of these 110 possible correlations there were 21 significant at  $p < 0.05$  on a one-tailed test, that is, with a correlation coefficient of greater than 0.497. By chance only  $0.05 \times 110 = 5.5$  would be expected to be significant. Those significant effects are shown in **Table 10.1**.

<b>Table 10.1 Correlations between pretests &amp; performance measures significant at <math>p &lt; 0.05</math></b>								
	<b>Pretest Measure</b>							
	<b>1</b>	<b>2</b>	<b>3</b>	<b>4</b>	<b>6</b>	<b>7</b>	<b>8</b>	<b>9</b>
<b>Performance</b>	<b>Age,</b>	<b>Years</b>	<b>Years</b>	<b>Days</b>	<b>Near</b>	<b>Periph</b>		

Measure	year	as insp	post highsch	since last insp	VA	VA time	EFT	BMCT
1. prob.(hit) (701)	-.588	-.566						
2. time (701)	+.556					+.542		
3. prob.(hit) (503)	+.526		+.568	-.513	-.618	+.667		
4. d' (503)	+.577					+.508	+.572	
5. time (503)				-.541				
6. prob. 50 (503)	+.702	+.596					+.553	
7. total time			+.660	-.633				+.513
8. total calls			-.625			-.608		

The pattern of these significant results produces expected findings only in a few places. For example, most of the pretest scores (such as EFT) have positive correlations with performance measures which sometimes indicate better inspection (p (hit) 503) and sometimes worse inspection (50% point on PoD curve, 503). The conclusions are that the expected large individual differences were found, that they correlated with some pretest measures, but that different aspects of performance correlated in different ways. Such findings are not unusual: Drury and Wang (1986) showed that inspectors who were good at one aspect of inspection may not be that good at other aspects. As these authors stated, inspection abilities may be highly task-specific. This does not auger well for discovering an "aircraft inspection person" who would have high abilities on the many different types of tasks required in inspection ranging from broad area visual inspection to detailed eddy current scans.

## 10.3 NEW METHODS OF ANALYSIS

The second major contribution to the VIRP Benchmark Study was in devising and implementing new methods of analysis by combining the data on defect calls with the videotape record. Inspection performance (errors) typically measures misses and false alarms as defined as in **Table 10.2**. (This measurement, however, does not reveal the sub-processes that comprise inspection.) The inspection process, whether by human, machine or a combination, is composed of two sequential sub-processes: Search and Decision (Drury and Prabhu, 1992). If we could characterize errors as "Search Errors" or "Decision Errors" it would help in understanding interventions of lowered reliability, and hence in concentrating interventives where they would be most effective (Drury and Sinclair, 1983).

**Table 10.2 Outcomes in an inspection task**

	Rivet State	
Inspector Decision	Good	Defective

No report	Correct Accept	Miss
Report	False Alarm	Hit

In Search, the inspector covers the inspection area by a series of fixations separated by eye movements. The inspector will stop searching either because an indication is found, or because it is no longer profitable to continue inspection, i.e., the area has been searched as thoroughly as desired but no indication has been found.

In Decision, the indication located by the search process is examined more closely to determine whether it should, or should not, be called out. Usually this is done by a comparison of the indication with a standard for reporting of a defect.

We can thus characterize the inspection process as one of search followed by either a decision to stop searching, or entry into an intensive decision process, which may also include some element of search. The decision tree in **Table 10.3** shows the different subtasks, the tests in each, and the three possible outcomes. These three numbered outcomes (from **Table 10.3**) will have different final outcomes based on the actual state of the rivet, as shown in **Table 10.4**. It is also possible to map these three outcomes (**Table 10.3**) onto the outcomes presented in **Table 10.2**. This is shown in **Table 10.5**.

**Table 10.3 Decisions tree for inspection**

Subtask	Test	"Yes" Outcome	"No" Outcome
Search (1)	Indication?	Go to Decision	Stop Search and Move to next rivet
Decision	Report Defect?	Defect reported (2)	Move to next rivet (3)

**Table 10.4 Final outcomes corresponding to decision tree based on state of rivet**

Outcome Number	Good Rivet	Defective Rivet
(1)	Correct stop, i.e., search terminates correctly	Search failure: miss
(2)	Decision failure: false alarm	Decision success: hit
(3)	Decision success: correct accept	Decision failure: miss

**Table 10.5 Relationship between decision tree outcomes and final outcomes**

	Rivet State	
Inspector Decision	Good	Defective
No report	Correct accept (1) (3)	Miss (1) (3)

Report	False alarm (2)	Hit (2)
--------	-----------------	---------

In the Benchmark experiment, each inspector placed a marker for each call, so that the final outcomes could be determined if the location of each true defect was known, as was the case for the cracked panels in **Task 701**. However, in the Benchmark study, video-recordings of all inspectors had been taken so that it was possible to observe on the tape how each inspector dealt with each rivet. It was found to be possible to determine whether the inspector had stopped the search and moved to the next rivet (outcome 1) or started the decision process (outcomes 2 or 3). Decision was indicated by a significant pause during which the flashlight and/or the inspector's head was moved in order to obtain additional views of the indication. Using the records of which rivets were marked and where the visible cracks (those which went beyond the diameter of the rivet head) were located, it was possible to reconstruct the search/decision process.

With this methodology it was possible to determine to what extent errors were due to a faulty search process (i.e., not even seeing an indication) and to what extent they were due to a faulty decision process (i.e., mis-classifying the indication once located). The importance of this analysis is that it allows countermeasures to be focused on the process where they are most needed. For example, if training is the intervention, then quite different techniques are required for search training and decision training (Gramopadhye, Drury and Prabhu, 1993). If physical interventions were proposed, then different types of lighting would be required to improve the two subtasks of search and decision. An earlier study of manufacturing inspection of aircraft gas turbine roller bearings (Drury and Sinclair, 1983) used a similar analysis. This helped to provide a more rational allocation of function between human and machine inspection, and to design a highly-effective training system for inspectors (Kleiner and Drury, 1993).

For the twelve inspectors in the Benchmark experiment, all except Inspector 9 gave usable videotapes. **Table 10.6** shows the probabilities of the different outcomes. It can be seen that the inspectors were uniformly poor at the search sub-task, only locating 44% to 69% of the indications. They were highly variable in the decision process, with some inspectors perfect (#5 and #7 both had 100% decision hits and no false alarms) and some very poor (#2 had few decision hits but not many false alarms while #10 had more decision hits at the cost of excessive false alarms). Thus it appears that search interventions are required for all inspectors, but decision interventions only required for a few inspectors. Overall measures were calculated in the normal way from reconciling inspector calls with actual crack locations.

**Table 10.6 Performance measures of inspectors analyzed to show both search and decision performance**  
 \* indicates video tapes unusable for inspector.

Inspector No.	Prob. Correct Stop	Prob. Search Success	Prob. Decision Hit	Prob. Decision False Alarm	Overall Prob. (Hit)	Overall Prob. (False Alarm)
1	0.88	0.69	0.73	0.14	0.508	0.0169



2	0.94	0.49	0.44	0.11	0.200	0.0068
3	0.86	0.53	0.69	0.26	0.355	0.0372
4	0.95	0.56	0.93	0.42	0.519	0.0226
5	0.95	0.48	1.00	0.00	0.478	0.0000
6	0.95	0.60	1.00	1.00	0.600	0.0536
7	0.98	0.53	1.00	0.00	0.531	0.0000
8	0.93	0.44	0.97	0.84	0.424	0.0714
9	*	*	*	*	0.720	0.3050
10	0.98	0.46	0.77	0.80	0.338	0.0136
11	0.96	0.46	0.93	0.17	0.431	0.0068
12	0.97	0.46	0.83	0.22	0.381	0.0068

### 10.3.1 Techniques for Measuring Perceived Difficulty

The final contribution to the VIRP Benchmark experiment was to develop techniques for measuring aspects of the perceived difficulty of the different tasks. A number of standard scales were chosen from the human factors literature and others developed specifically for aircraft inspection. The following aspects were chosen to cover task difficulty, execution, physical discomfort and physical and visual access. These were defined as follows:

**Task Difficulty.** "How easy or difficult was this task?" Ten point scale (1 = very easy, highly desirable; to 10 = Impossible). Based on the Modified Cooper-Harper Scale (MCHS), omitting intermediate choice structure.

**Whole Body Execution.** "How much effort did you exert in this task?" Ten point scale (0 = Nothing to All; to 10 = Extremely Strong, almost maximum) developed as the Borg Rated Perceived Execution (RPE) Scale.

**Body Part Discomfort.** "How much discomfort/pain do you feel in each body part?" The Corlett and Bishop Body Part Discomfort (BPD) Scale (0 = None; to 5 = Intolerable) for each of 19 body parts. This was summed across body parts for initial analysis.

**Access to Workpoint.** "The physical access to and from the workpoint was easy." Five point Likert scale (1 = Strong Agree, to 5 = Strongly Disagree).

**Access at Workpoint.** "The physical access at the workpoint was easy." Same Likert scale as (4).

**Visibility of Workpoint.** "It was easy to see the areas that were to be inspected." Same Likert scale as (4).

**Freedom from Distractions.** "The surface areas to be inspected were free from excessive distractions with respect to the type of flaws being searched for. Same Likert scale as (4).

All scales were given to each inspector immediately following each task and the rating recorded. The analysis of this data considered the agreement among the inspectors and the patterns of high or low values for each task across inspectors. For each of the scale responses, an analysis of variance was performed with inspectors and tasks as factors, using their interaction as an error item. For all seven scales, the effects of both inspectors and tasks were significant at  $p < 0.0001$ . Inspectors were different in overall severity/leniency of rating scores, but overall they agreed on their ratings of each task. In **Table 10.7**, responses have been categorized as a "+" if the response was much higher than the average across all tasks, or a "-" if much lower.

<b>Table 10.7 Categorization of inspector perceptions of each task</b>										
<b>Rating Scale</b>	<b>Task</b>									
	<b>501</b>	<b>502</b>	<b>503</b>	<b>504</b>	<b>505</b>	<b>506</b>	<b>507</b>	<b>508/9</b>	<b>510</b>	<b>701</b>
Task difficulty	+	+	-	-	-	-	+	+	-	-
Whole body exertion	+	+		-	-		+	+	-	-
Body part discomfort	+	-		-	-		+	+	-	-
Access to workpoint				+	-	-		+		-
Access at workpoint		+		+	-	-		+		-
Visibility at workpoint		+		+	-	-		+		-
Freedom from distraction		+	-	+	-		+	+		-

Some important patterns emerge from this data. First, the three scales of difficulty, exertion and discomfort tended to give the same patterns across all tasks, as did the Likert scale variables. Within these broad groupings, there were clearly some tasks which were considered "good" such as **505** (Rear Bilge Exterior) and **701** (Lap splice panels) and some as "bad" such as **508/9** (Rear Bulkhead Y Ring) or **502** (Main Landing Gear Support). Between these were tasks with low difficulty but difficult access, such as **504** (Galley Doors, Interior) or with high difficulty but neutral access such as **501** (Midsection Floor Beams).

The conclusion of this analysis is that inspectors can provide useful data on their perceptions of the different tasks. Also the design of the experiment was successful in achieving a mix of high and low levels of difficulty and access across the set of all tasks.

## 10.4 IAM FLASHLIGHT EXPERIMENT

Part of the mission of the AANC is to provide an environment for testing and validation of inspection equipment. This mission has typically been interpreted as applying to NDI equipment, although a program on Enhanced Visual Inspection has been pursued for the FAA.

As part of this program an improved lens was developed for the "Maglight" flashlight, a tool which has become something of an industry standard among inspectors. This lens developed by

W. Shurtleff of Sandia National Laboratories (SNL) has a microscopic pattern molded into one surface to act as a diffuser. The effect is to greatly enhance the evenness of illumination across the output beam of the flashlight, eliminating dark and bright spots. This necessarily reduces the peak brightness. Evaluations of this lens have been confined to detailed measurement of its optical characteristics, and tests of acceptability to practicing inspectors. While both of these are necessary first steps to ensure that the new lens can be used by the industry, they do not address the question of performance. Does this lens aid (or even hinder) detection of defects? There have been a number of evaluations of lighting effectiveness in the literature (e.g., Drury, 1984 for review). Typically, changes in lighting must be quite dramatic to achieve significant gains in inspection performance. Merely increasing overall illumination on the task rarely produces performance improvements, unless the original level of illumination was extremely low (e.g., Sheehan and Drury, 1971).

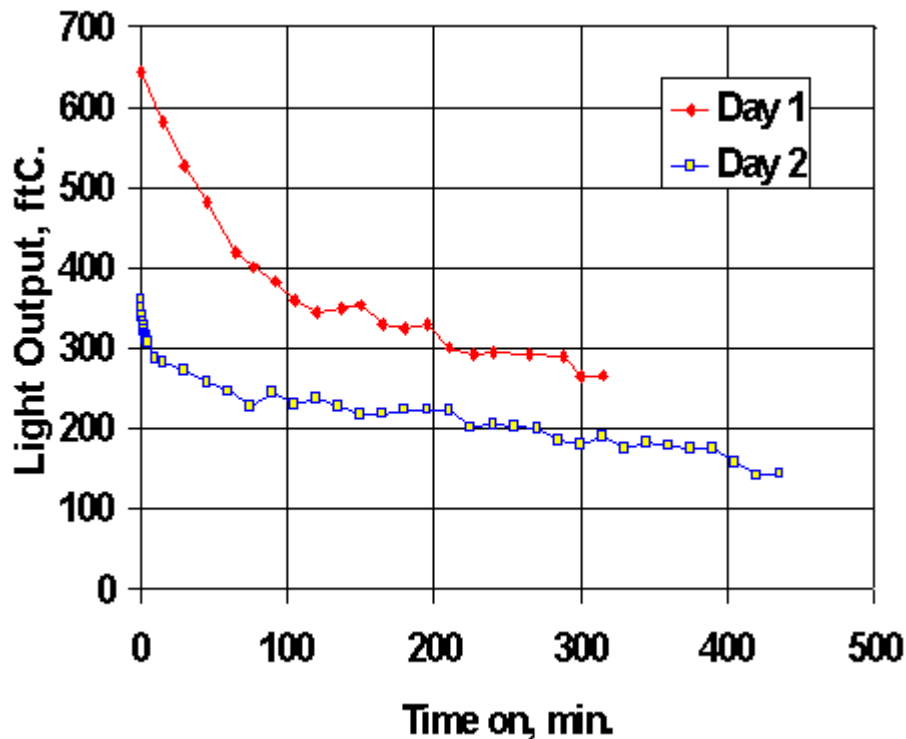
Performance evaluations are required not just for this flashlight lens but for many tools developed from FAA programs, by research laboratories or by vendors. Hence performance evaluation of this lens was seen as an opportunity to develop a standard performance evaluation methodology for other visual inspection job aids. A suitable methodology should provide a measure of inspection reliability, which means that a set of well-characterized defects is required embedded in a larger set of similar areas known to be free of defects. For the flashlight evaluation, a suitable choice was the lap splice panels produced for the ECRIRE study (Spencer and Schuman, 1993) and already used in the VIRP Benchmark experiment. A subset of 16 of the 20" (0.5 mm) panels was chosen for the test. They were arranged in sets of four panels under two ambient lighting conditions. "Low" illumination was 9 fc (90 Lux) at the rivet level, while "High" illumination was 90 fc (900 Lux) at the rivet level. All panels were arranged so that the rivets were at mean (male) eye level of 60" (1.5 m) above the floor.

Choice of representative people to perform the evaluation is critical to study validity. A visit to AANC by a committee of the International Association Machinists (IAM) was accompanied by a request by the committee for "hands on" demonstrations at AANC. One such demonstration was the flashlight lens evaluation. This demonstration provided AANC with "experiment flashlight users" on-site, if only for a limited time period.

An experiment was designed to perform the evaluation and to demonstrate good statistical and human factors practice in experimental design. Twenty-four AMTs, all experienced flashlight users, of whom 12 were qualified inspectors, took part. They arrived in groups of six, for one hour per group. During the hour, they were given ten minutes to inspect each of the four sets of panels. Matched flashlights with the original and enhanced lenses were used so that each subject inspected a different set of panels under all four combinations of flashlight lens and ambient lighting. Calibration of the rates of decrease of light output of the flashlights as batteries depleted in two runs over two days showed that batteries should be changed after two or three one-hour sessions to keep the illuminance above 300 fc (see **Figure 10.1**). Subjects marked all findings on a sheet which reproduced the pattern of rivets on the panels. In the remaining two ten-minute periods of their hour, subjects performed a set of pretests (Near and Far Visual Acuity, Color Vision, Peripheral Visual Acuity) and completed a demographic questionnaire detailing their age, training, experience and use of corrective lenses. Four groups of six subjects each completed the experiment. All subjects were instructed to find all the cracks on the panels and

mark them on the sheets provided.

**Figure 10.1 Light Output From Flashlight Over Two Consecutive Days On Same Batteries**



The subjects' findings were compared to the known locations of cracks large enough to extend beyond the diameter of the rivet head. Because some rivets had two cracks, it was possible to measure reliability as "correct detection of a crack" or "correct detection of a rivet with a crack." Similarly false alarms could be measured on the crack or on the rivet. Thus, there were four possible performance measures for each combination of subject (24), flashlight lens (2), and ambient lighting (2).

Analysis of the results began by calculating correlations between the performance measures. High correlations were found between the two measures of correct detections ( $r = 0.906$ ) and between the two measures of false alarms ( $r = 0.988$ ) with much smaller correlations between the other pairs ( $r = 0.145$ ,  $r = 0.323$ ). Thus the choice of measures, i.e., defined by crack or by rivet, made little difference to the results. Three-factor analyses of variance of each measure were performed. All four analyses showed significant differences between subjects, but no significant effects of flashlight lens, ambient lighting or their interaction. Differences between subjects were further explored by correlating each of the four performance measures with the pre-test and demographic variables. Only Peripheral Visual Acuity gave significant correlations, both with correct detections. The correlation of peripheral visual acuity with correct detections defined on cracks was  $r = -0.432$  and that with detections defined on rivets was  $r = -0.395$ . Note that both correlations were negative. Peripheral acuity was measured by the time to complete the peripheral acuity task, so that a negative

correlation shows that subjects with better peripheral visual acuity were better at detecting true defects. As peripheral visual acuity (lesser time to complete peripheral acuity task) is known to predict search performance (e.g., Courtney, 1984) this finding suggests that, as with the VIRP study, visual search was the factor limiting performance.

Significant differences were observed between subjects, indicating that the experimental design was sensitive enough to show individual differences in performance. To explore this factor further, subjects were classified as inspectors (12) and AMTs who were not inspectors (12). A nested analysis of variance was performed to test for differences between inspectors and noninspectors on each of the four performance measures. For each measure, these differences were significant at  $p < 0.05$ . The mean performance of each group on each measure is shown in **Table 10.8**, where it is evident that inspectors detected about 8% more cracks (or rivets with cracks) but at the cost of making about 2% more false alarms.

<b>Table 10.8 Performance by job classification</b>				
<b>Group</b>	<b>Detections (crack)</b>	<b>Detections (rivet)</b>	<b>False Alarms (crack)</b>	<b>False Alarms (rivet)</b>
Non-inspectors	46%	46%	5%	9%
Inspectors	54%	54%	6%	11%

The mean performance under the four visual conditions is shown in **Table 10.9**. Note that the ANOVA's showed that none of these differences were significant, indeed they were remarkably small differences.

<b>Table 10.9 Performance under different lighting and flashlight lens conditions</b>					
<b>Ambient Lighting</b>	<b>Flashlight Lens</b>	<b>Detections (crack)</b>	<b>Detections (rivet)</b>	<b>False Alarms (crack)</b>	<b>False Alarms (rivet)</b>
Low (9 fc)	original	47%	47%	5%	9%
Low (9 fc)	enhanced	50%	52%	5%	9%
High (90 fc)	original	51%	50%	6%	11%
High (90 fc)	enhanced	51%	52%	6%	11%

The finding of no difference between ambient lighting conditions was anticipated because the illumination from the flashlight beam was expected to overpower any ambient illumination when the flashlight was held only a few inches from the rivet. Thus overall illumination was expected to be high enough for stable performance under high and low ambient lighting. However, the lack of a significant effect due to the flashlight lens was disappointing. While the enhanced flashlight did not increase total illumination, its effect was to provide better illumination

uniformity. One reason for this may be due to restricting the test to detection of cracks in a bare metal panel at eye level. It is possible that different defects (e.g., corrosion) or different surfaces (e.g., painted metal, dirty surfaces, complex structures) would have revealed differences. Also, it is possible that subjects were used to using the non-uniformities in the original lens to help detect subtle visual cues such as tight cracks (cf., Drury and Sinclair, 1983). However, for this particular experiment, choice of flashlight lens made no difference to the subjects performance. With statistical significance of such relatively small differences as those found between inspectors and non-inspectors, it is unlikely that the lack of a significant flashlight lens effect was due merely to an insensitive experiment. The conclusion is that under the conditions used, the enhanced lens neither helped nor hindered crack detection performance.

The 'IAM' experiment has demonstrated how to perform a well-controlled experiment to evaluate the inspection reliability of different job aids for visual inspection. Similar methods can be used for rapid, cost effective evaluations in future AANC work.

(The author and the AANC would like to thank those IAM members who acted as willing subjects in our experiment.)

## 10.5 COMPARISON STUDY OF FAA AND CAA NDI RELIABILITY EXPERIMENTS

This section is a condensation of a 20,000 word report already under review (Murgatroyd, Drury and Spencer, 1996 draft). Detailed analyses and tabulation of findings are omitted as they have not yet completed the review process by UKCAA and FAA sponsors. In 1993-94 the CAA and FAA initiated work with AEA Technology (AEAT) in the UK (Murgatroyd, Worrall and Waites, 1994) and Sandia National Laboratories (SNL) in the USA (Spencer and Schurman, 1994), respectively, to carry out investigations of the reliability of aircraft eddy current inspection. While the two studies had different objectives and were conducted separately, there was significant interaction between the two research groups. Hence, the studies were performed to broadly similar protocols and procedures, although the detailed experimental programs differed. The study summarized here compared in detail the results and conclusions of the two experiments in order to identify common conclusions, to analyze and explain any differences, and also to establish an integrated databank of results, leading to further insight into the reliability of aircraft non-destructive inspection.

The FAA and the UK Civil Aviation Authority (CAA) therefore initiated a collaborative exercise between AEAT, SNL and the University of Buffalo to examine further the integrated database, and to correlate the trends and conclusions with relevant published information.

The specific objectives of the project were:

To compare and contrast the data and conclusions from the FAA and CAA studies to highlight similarities and explain differences.

To extract further relevant information from the data sets of the two studies.

To review relevant literature on NDE and other inspection tasks to provide an overall

explanation applicable to both studies.

To assess the implications of the findings for current practice in aircraft maintenance facilities.

To consider the need for any future studies of NDI reliability.

The final report (to be published in 1996 by the CAA and FAA) gives a detailed analysis of each study under a common set of criteria. These criteria were study objectives, inspection task and specimen details, inspection conditions, choice of inspectors, and data collection, analysis and reporting procedures. To determine the validity of the studies, the current work compares their conduct with inspection practice and their findings with other published data on human performance in inspection tasks. As the CAA and FAA studies used different measures of reliability, new measures of accuracy and speed of inspection were derived to allow direct quantitative comparisons to be made. To better understand the mechanisms of error contributing to lowered reliability, observed errors were organized into a consistent framework based on the analysis of human functions in the eddy current inspection task.

From the detailed comparisons, it was concluded that the two studies did indeed differ in their objectives and conduct, yet produced comparable results when comparable measures were derived. The FAA study aimed to measure eddy current inspection reliability under realistic conditions to derive representative probability of detection curves relating detection performance to crack size. The CAA study, in contrast, was designed to study in great detail the occurrence of errors in following a controlled procedure over long periods of time. Both studies achieved their separate objectives, and also simulated aspects of inspection practice in an appropriate manner.

The overall crack detection results obtained for the two studies were different, with different distributions of detection capabilities. However, this analysis has shown that by considering a specific group of inspectors which had worked to similar test conditions, namely those who had worked alone using the sliding probe technique on an unpainted inspection surface, there is no significant difference between the detection rates of comparable sets of inspectors. This result must be treated with some caution in view of the small sample sizes involved.

Another apparent difference between the inspectors in the two studies was in work rate, with the FAA inspectors taking three to four times longer to scan an equivalent number of fasteners. The present analysis has resolved this discrepancy. An evaluation of the respective task contents revealed that the rate of presenting the inspector with crack signals in the FAA experiment was significantly higher than in the CAA project, and hence the relative proportion of the time spent in scanning fasteners and deciding on indications differed between the two studies. When allowance is made for this factor it is concluded that there is no significant difference in the work rates encountered in the two studies.

Factors affecting performance also were in agreement between the studies. The major effects were due to individual differences between the inspectors, the eddy current technique used and characteristics of the test specimens. The body position during inspection had a minor effect. There was also agreement on the facts not significantly affecting performance. Environmental conditions, at least over the ranges typically met in inspection practice had no measurable influence, although extremes of thermal, auditory and visual environments were not tested. Inspector experience was unrelated to performance, at least for the relatively experienced



inspectors used in the two studies.

Variability between inspectors was large and consistent, which echoes a common finding in inspection studies across a variety of industrial settings. Measured demographic and psycho-social differences between inspectors did not explain these performance differences. There were also differences between certain facilities (in the FAA study) of magnitude comparable to inspector-to-inspector differences.

Detailed analysis of the errors recorded in the CAA study showed them to be consistent with task analytic frameworks developed earlier from human factors studies of inspection. With such a framework in place it is now possible to develop interventions for reducing specific causes of lowered reliability. This is particularly important for addressing those errors which cause inspectors to miss the occasional large defect. The finding in the FAA study that some misses are independent of defect size directly supports this conclusion. There are implications of this finding for the accurate fitting probability of detection curves.

## 10.6 FUTURE WORK

It was proposed at the start of 1993 to follow the VIRP Benchmark experiment with "Follow-on" or "Parametric" studies to evaluate the effects of different parameters of the task, inspector, equipment and environment on inspection reliability. Since that time the priorities of the FAA Tech Center and AANC have changed to evaluation of inspection reliability in a commuter airline environment. Thus a commuter airplane has been obtained and installed at AANC and follow-on studies have been changed to studies of visual inspection reliability in commuter airlines. The roles of SUNY Buffalo and FAA/AAM in this endeavor are still unclear at press time.

## 10.7 REFERENCES

- Courtney, A. J. (1984). A search task to assess visual lobe size. *Human Factors*, 26(3), 289-298.
- Drury, C. G. (1995a). Improving human inspection reliability. In *Proceedings of the 8th FAA/AAM Meeting on Human Factors in Aircraft Maintenance and Inspection: Trends and Advances in Aviation Maintenance Operations*, Atlantic City, NJ.
- Drury, C. G. (1995b). Support of the FAA/AANC Visual Inspection Research Program (VIRP). *Human Factors in Aviation Maintenance, Phase V: Progress Report*, (contract No. DTFA01-94C0103). Available on CD-ROM, Atlanta, GA, Galaxy Scientific Corporation (Distributor).
- Drury, C. G. and Prabhu, P. V. (1994). Human factors in test and inspection. In Salvendy, G. and Karwowski, W. (Eds.), *Design of Work and Development of Personnel in Advanced Manufacturing*, Chapter 13, John Wiley & Sons, New York, 355-402.
- Drury, C. G., Prabhu, P. V. and Gramopadhye, A. K. (1990). Task analysis of aircraft inspection



- activities: Methods and findings. In *Proceedings of the Human Factors Society 34th Annual Meeting*, Santa Monica, CA, 1181-1185.
- Drury, C. G. and Prabhu, P. (1992). Human factors in test and inspection, In Salvendy, G. and Karwowski, W. (Eds.), *Handbook of Human Factors in Advanced Manufacturing*, New York: John Wiley and Sons.
- Drury, C. G. and Sinclair, M. A. (1983). Human and machine performance in an inspection task, *Human Factors*, 25(4), 391-399.
- Drury, C. G. and Wang, M. J. (1986). Are research results in inspection tasks specific? In *Proceedings of the Human Factors Society 30th Annual Meeting*, 393-397.
- Federal Aviation Administration (1993). *The National Aging Aircraft Research Program Plan*, Washington, D.C.: DOT.
- Gramopadhye, A., Drury, C. G. and Prabhu, P. V. (1993). Training for visual inspection of aircraft structures. *Human Factors in Aviation Maintenance, Phase III: Progress Report, Interim Report*, DOT/FAA/AM-93/15, Springfield, VA: National Technical Information Service.
- Kleiner, B. M. and Drury, C. G. (1993). Design and evaluation of an inspection training programme. *Applied Ergonomics 1993*, 24(2), 75-82.
- Murgatroyd, Drury and Spencer, 1996 draft. Comparison and further analysis of CAA and FAA inspection reliability experiments.
- Murgatroyd, R. A., Worrall, G. M. and Waites, C. (1994). *A Study of the Human Factors Influencing the Reliability of Aircraft Inspection*, AEA/TSD/0173, U.K.: AEA Technology.
- Patel, S., Drury, C. G. and Lofgren, J. (1994). Design of workcards for aircraft inspection, *Applied Ergonomics 1994*, 25(5), 283-293
- Roach, D. P. (1993). *Baselining The Flaw Profile Of The FAA/AANC Transport Aircraft Testbest*. A Proposal to the FAA for Development of Advanced Aircraft Inspection Techniques. Albuquerque: Sandia National Laboratories.
- Sheehan, J. J. and Drury, C. G. (1971). The analysis of industrial inspection, *Applied Ergonomics*, 74-78.
- Spencer, F. and Schurman, D. (1994). *Reliability Assessment at Airline Inspection Facilities. Volume III: Results of an Eddy Current Inspection Reliability Experiment*,

DOT/FAA/CT-92/12,III, Atlantic City, NJ: FAA Technical Center.

# CHAPTER 11

## REDUCING AUTOMATION-RELATED ERRORS IN MAINTENANCE AND INSPECTION

*Colin G. Drury, Ph.D. and J. Rangel  
State University of New York at Buffalo*

### 11.1 ABSTRACT

With the advent of more flexible automation comes the need to decide what to automate and how to fit human and automation together. This chapter proposes an error-based criterion for allocation of inspection and maintenance functions between people and computers. Working examples applying this methodology to two inspection tasks at our airline partner's facilities are provided.

### 11.2 PURPOSE

Throughout the aircraft maintenance and inspection system, there is an increasing emphasis on automation. While the benefits of automation can be substantial, care must be taken to ensure that adverse and unexpected consequences are not introduced into the system by automation. We have seen in the areas of cockpit automation and manufacturing automation that introducing automated functions leads to novel forms of error along with the promised benefits of higher productivity and reduced operator workload. This chapter reviews the progress of automation in the maintenance and inspection hangar, provides a method for rational decisions on what to automate, and shows how the nature of human and system errors can change between manual and automated systems. Finally, a simple procedure is presented to help systems designers, and those who purchase and use their designs, to foresee and mitigate automation-related errors.

### 11.3 THE NATURE OF AUTOMATION

According to an adaptation from Webster's Third International Dictionary by Sheridan (1992), "Automation" is the "automatically controlled operation of an apparatus, a process, or a system by mechanical or electronic devices that take the place of human organs of observation, decision and effort." This implies that sensors, processors and effectors are all machine-assigned, but it is not all that we mean by "automation" in the hangar. In practice, automation is used to refer to almost any degree of mechanization, that is, assignment of functions to machines rather than

people.

**Table 11.1** provides a scale of degrees of automation (from Sheridan, 1992) which shows that the word in fact represents a continuum from almost no machine assistance to machines that ignore the human completely. Note that automation need not refer to a complete process or task, but may be implemented only for a few of the functions comprising the process.

<b>Table 11.1 Scale of degrees of automation. (Sheridan, 1994)</b>	
1.	The computer offers no assistance; human must do it all.
2.	The computer offers a complete set of action alternatives, and
3.	narrows the selection down to a few, or
4.	suggests one, and
5.	executes that suggestion if the human approves, or
6.	allows the human a restricted time to veto before automatic execution, or
7.	executes automatically, then necessarily informs the human, or
8.	informs the human after execution only if he asks, or
9.	informs the human after execution if it, the computer, decides to.
10.	The computer decides everything and acts autonomously, ignoring the human.

The issue is not whether automation is good or bad *per se*, but rather how far to go in automation (Sheridan, 1992, p. 356). For example, Horte and Lindberg (1991) give an analysis of 27 Flexible Manufacturing Systems (FMS) in Sweden, and show great variation in performance. The most flexible systems, and those used specifically for their flexibility, do best. It is noteworthy in this study that the major tasks of the operator were operation (obviously), process monitoring and maintenance; quality and maintenance functions are well integrated into the operator's job. This can be contrasted with the many well-documented examples of system failure in automation, (e.g., Rasmussen, Duncan and Leplat, 1987), primarily from poor use of human operators in the system (e.g., Bessant, Levy, Ley, Smith and Tranfield, 1992).

These issues of what to automate, that is, appropriate automation, have surfaced in many contexts, from civil airline operations (Wiener and Nagel, 1988) to industrial production (e.g., Brödner, 1994; Kidd and Karwowski, 1994). The successful philosophy in industry currently is composed of the items in **Table 11.2**, summarized from Bessant, et al. (1992).

<b>Table 11.2 Factors common to successful change implementation in manufacturing (46 applications in 28 companies)</b>	
<b>1. <u>Work Organization Factors</u></b>	
Multi-skilling	Teamwork
Integrated tasks	Alternative payment systems
Short skill life cycle	Supervisor support
Re-skilling	Flexibility/autonomy
<b>2. <u>Management Organization Factors</u></b>	
Blurred line/staff boundaries	Product/project/customer-based structures
Flat organization structures	

Network communications Holographic adjustment	Single status employees Flexible, participate worker
--	---

In the aircraft maintenance context, these factors appear somewhat unusual, because they do not stress technology, elimination of "inefficient" human operators, or dramatic productivity improvements. When automation is presented in maintenance and inspection (for example, new NDI methods) the presentation starts with a litany of human shortcomings (e.g., inspectors are subject to boredom or distraction) and goes on to suggest that the author's automated system will, by eliminating the human, eliminate these shortcomings. The factors in **Table 11.2**, derived from a study of successful and unsuccessful implementations of automation, concentrate mainly on the integration between the automation and the human. The current chapter is a move towards recognizing the paradoxical, but central, role of the human in automation, so that aircraft maintenance and inspection can learn from successes in other domains.

## 11.4 AUTOMATION ERRORS

As shown in **Table 11.2**, a goal of successful automation is flexibility, that is, the system should be able to perform multiple functions, or the same functions differently under different circumstances. Thus an eddy-current NDI system should have both calibration and operation functions. Within the operation function it should be operable in modes that either display only the output from the current site being inspected, or display the output from the current site and stored outputs from other sites to facilitate site-to-site comparisons. Because the same display, and often the same controls, are used in both modes, it is possible for the operator to misperceive which mode is currently chosen. This is labeled a *mode error* (Norman, 1981) and obviously can occur only when a display is capable of multiple modes. Mode error is an example of the potential for unwanted, and often unexpected, consequences of automation. How important mode errors are for systems operation depend upon how well the system is designed to prevent mode error from occurring, and the controls and safeguards built into both the automation and the social system to prevent the error from propagating through to final undesired consequences.

To designers and users of automation, multiple-mode capability is of great importance. If a vendor can show that the automated system can handle many different situations, a user will be more inclined to purchase the system. Additionally, such a flexible system will be salable to multiple users, thereby reducing design, manufacturing and inventory costs for the system. Thus there is a natural drive towards multiple modes. Even in computer software for office use, recent programs are increasingly larger and more complex than their predecessors, with multiple modes the norm. In a word processor, the user can choose to view the document at the text level, at the page layout level, or at the multi-page level. Unfortunately, not all operations work, or work in the same way, in all modes, leading to potential confusion and errors absent in the earlier, less-automated, systems. In a word processor, the consequences of error are probably only delay and annoyance, but in aviation systems the errors can lead to safety being compromised.

In a review of mode error, Sarter and Woods (1995) show that such errors can be expected where the multi-mode system is complex and where it is partly driven by external events. In the word

processor example there are few external events within the program, but more can occur in computers with many tasks running simultaneously. NDI systems, in contrast, are designed to interact with the aircraft structure, and are thus highly event-driven. Thus the finding of a defect, electrical interference, or periodic recalibration can be external events that would drive the system. As system functions become more automated, the system itself may change modes due to external events without human intervention, increasing the likelihood of error.

It is this unanticipated mode change that has been implicated in flight operations incidents and accidents (Wiener and Nagel, 1988). An example is the "Bangalore crash" which Sarter and Woods (1995) show to have been due in part to choice of the "Altitude Acquisition" mode for descent which automatically activated the "Open Descent" mode because the aircraft was within 200 feet of the target altitude. In this latter mode the aircraft tried to maintain speed by going below the flight path, eventually crashing. Cockpit procedures should have noted this mode change but did not. In this, as in other instances, the mode error occurred in a high-workload situation where the crew were not primed specifically to suspect a problem. Sarter and Woods (1995) go on to show how poor display design can contribute to these errors, and to suggest possible interventions.

Obviously mode errors are not the only ones that can occur in automated and manual systems. They have been presented here as being typical of those inadvertently introduced by automation.

To obtain more data on errors related to automation in maintenance and inspection, a search was made of the ASRS reports on maintenance. There was very little related to automation, but three examples show where automation and lack of automation have led to errors. [Note: None of these were from our airline partner.]

ASRS Example 1: Unreliable Automation. (Accession number 110244 partial narrative - originals in uppercase only)

Airlines test stand model is used to test bus power control units and generator control units for aircraft. This test stand is unreliable in that it uses an old card reader for its different test step inputs. This card reader is at times intermittently in error and causes erroneous information to be fed to test stand. Sometimes the mechanic operating tester does not notice this and can make a wrong adjustment or miss a malfunction in unit under test. A second fault in this test stand is the frequency counter. It is intermittent and at times inoperable. Many testing steps rely on this (also inaccurate) counter to measure trip times of relays in until under testing. Suggested remedy: have unit repaired correctly by manufacturer, or replace it. Too many generator control units and bus power control units go out of shop and mechanic does not know if it is correctly repaired or not . . .

In Example 1, the (somewhat dated) test stand automation has become unreliable without the indications of unreliability being obvious to the mechanic who is operating the test stand. This means that the mechanics do not know with any certainty whether the adjustments were correct or not.

ASRS Example 2: Lack of Automation. (Accession number 90509. Partial narrative)

. . . During the night graveyard maintenance started to defuel the #2 tank which

was on a placard, so the tank could be fueled with a known quantity in the morning. While this was being done, #1 fuel quantity indicator started showing erratic readings, then went completely inoperable . . . I told the gate agent in charge that we had found the problem, but I would need about 10 minutes to defuel the #1 tank to make sure the quantity was correct. After contacting operations they decided to continue debarking the aircraft. I continued to defuel the #1 tank and watched the gauges all the way to make sure the indication was correct. Once the #1 quantity was verified to be working the captain and operations decided to reboard aircraft a. At this time I defueled #2 tank into #1 tank so that it could be filled with a known quantity. Once this was complete, I started transferring fuel from #3 to #1 due to #3 having too much fuel. Once I finished this I ran downstairs to have the fuel truck fill #2 with a known quantity. I took the fuel load which was in pounds and changed it to gallons. Due to the fact I did not have a calculator handy and the passengers being restless from being moved twice, I did the calculation on a sheet of paper and filled the aircraft with this amount. Unknown to me at the time was I miscalculated and was off by 1 decimal, thus giving an improper load. The plane departed and the improper amount was not detected until crew called and questioned the amount of fuel added . . .

In the incident described in Example 2, the lack of a simple automation device (a calculator) combined with severe time pressure to cause a potentially dangerous fuel situation.

ASRS Example 3. Attempted Manual Solution (Accession number 97278. Partial narrative)

While checking for horizontal stabilizer hinge bearing wear, the maintenance manual instructs you to secure a dial indicator to the fuselage. We do not have the proper attachments to do this. My supervisor made me hold the dial indicator on the fuselage. With this method I could not "zero" out the indicator, and feel the readings I got were grossly inaccurate . . .

In the incident described in Example 3, even a simple mechanical fixture would have prevented the potential inspection error. As with Example 2, the lack of even the most rudimentary of automation aids was closely linked with time pressure.

As can be seen, automation can both produce errors and prevent them. It is interesting that Example 1 shows the dangers of not having system changes displayed unequivocally to the operator.

As a final example of errors, Murgatroyd and Worrall (1994) ran a series of highly controlled studies of eddy current inspection to determine error types and frequency. To provide realistic changes, they included several instances of an ultrasonic inspection calibration task. The results showed a high variability in calibration, both within the same inspector from day to day and between inspectors. It is possible for even highly experienced personnel under observed test conditions to make significant errors in a rigorous procedure using semi-automated equipment. Analysis was performed on the reasons for these errors, which showed that many were due to miscalculation of gain settings.

In order to assess the potential for different errors as automation in the hangar environment increases, we must consider the current status of automation in inspection and maintenance and the potential for future changes.

## 11.5 CURRENT AUTOMATION IN AIRCRAFT MAINTENANCE AND INSPECTION

The major functions needed in aircraft maintenance and inspection to convert new material (unrepaired aircraft) into finished products (repaired and airworthy aircraft) have been listed by Drury (1995a) as:

1. Planning
2. Opening/Cleaning
3. Inspection
4. Repair
5. Buy-back and return-to-service

For the inspection and repair functions we have further breakdowns into sub-functions, using Drury, Prabhu and Gramopadhye (1990) for inspection and Drury (1995a) for repair. These are shown as [Tables 11.3](#) and [11.4](#).

Table 11.3 Generic functions in aircraft inspection, with examples from visual inspection and NDI		
Task Description	Visual Example	NDT Example
1. Initiate	Get workcard. Read and understand area to be covered.	Get workcard and eddy current equipment. Calibrate.
2. Access	Locate area on aircraft. Get into correct position.	Locate area on aircraft. Position self and equipment.
3. Search	Move eyes across area systematically. Stop if any indication.	Move probe over each rivet head. Stop if any indication.
4. Decision Making	Examine indication against remembered standards, e.g., for dishing or corrosion.	Re-probe while closely watching eddy current trace.
5. Respond	Mark defect. Write up repair sheet or if no defect, return to search.	Mark defect. Write up repair sheet or if no defect, return to search.



**Table 11.4 Generic functions in aircraft repair**

Function	Tasks
Initiate	Read and understand workcard Prepare tools, equipment Collect parts, supplies Inspect parts, supplies
Site Access	Move to worksite, with tools, equipment, parts, supplies
Part Access	Remove items to access parts Inspect/store removed items
Diagnosis	Follow diagnostic procedures Determine parts to replace/repair Collect and inspect more parts if required
Replace/Repair	Remove parts to be replaced/repared Repair parts if needed Replace parts
Reset Systems	Add fluids supplies Adjust systems to specification Inspect adjustments
Close Access	Refit items removed for access Adjust items refitted Remove tools, equipment, parts, excess supplies

As in most industrial activities, automation has proceeded piecemeal in aircraft maintenance and inspection. It is at least as much a push system, driven by those who invent or develop systems that may have an application here, as a pull system driven by user needs. Whether "push" or "pull," there appears to have been no systematic (i.e., system-conscious and system-driven) strategy for automation. Similarly, there has been no attempt to determine the level of automation (in Sheridan's sense) represented or desired by each implementation. This section therefore classifies current and near-term projected automation examples in the field, using the five major functions of maintenance and inspection. For a survey of the state of automation classified by traditional departments, see Goldsby, 1991.

**1. Planning.** As planning is an activity relatively easy to model using task precedence and interference constraints, and expected completion times, it has been at least partially automated in some airlines for many years. The combination problem of finding a minimum-out-of-service-time schedule is not easy to solve, but good heuristics do exist (Pinedo, 1992). Such scheduling systems are used by the airlines, with fine-tuning by foremen and supervisors typically on a shift-by-shift basis. No attempts to use research (e.g., Sanderson, 1989) on hybrid scheduling systems of humans and computers interacting to develop a schedule has been located in the airline industry.

Another area where automation has been used is in stock control and parts ordering. As aircraft

parts are both very costly and have long lead times for procurement, the costs of both inventory and stock-outs are considerable. Innovative solutions have been developed so as not to delay aircraft return-to-service. Computers are used extensively by parts suppliers as well as airlines to track parts required for repair. Airlines often cooperate in parts inventory, a task impossible without computer tracking.

The final area of planning automation is in the optimization of the overall repair process. Given that the Maintenance Plan approved for each aircraft calls for a series of inspections, repairs and replacements at known times, the packaging of these activities into hangar visits is a process where automation in the sense of model optimization has been used. Therefore, to bring together a number of different maintenance activities into a check visit, the inspection intervals for some components can be shortened. As the intervals may be time-based (e.g., some perishable items), cycle-based (e.g., fuselage inspection or landing gear) or flight-hours based (e.g., engine components) and the flight profiles for each airline differ, then the optimum schedule for hangar visits will differ. For example, there are some airlines which perform heavy checks (such as a C-checks) in a single long visit, others which perform them in a small number of shorter visits, and still others who "phase" their C-checks during overnight hangar visits at stations away from major repair bases.

**2. Opening/Cleaning.** Little in the way of automation or even modern job aids has been applied to this function, although the technology itself is changing. For example, the use of environmentally dubious solvents for paint removal is being supplanted by high pressure water jets.

**3. Inspection.** Much of the automation currently taking place or projected concerns the inspection function, even though this is likely to remain a labor-intensive activity. Indeed, many NDI inspection devices have been justified in terms of reduced inspection times (e.g., Lutzinger, 1992, p. 97) due to not having to disassemble structures and components.

At the Initiate functions, automation is possible using computer-based workcards. The Integrated Maintenance Information System (IMIS) (Johnson, 1990) pointed the way for military aircraft and many ways of automating this information presentation function have been proposed (e.g., Marx, 1992). A typical modern example is the computer workcard system developed by Patel, Drury and Lofgren (1993). This system presents workcard information using a hypertext format, allowing for access to background documents as well as the more conventional sequential access. A test of this system in an airline environment showed that it scored more highly than either the original paper-based workcards or redesigned paper-based workcards using human factors principles. It should be noted, however, that the redesigned paper-based workcards accounted for almost as much improvement over the original ones as did the hypertext system. Also under the Initiate function are systems that automate the set-up of an NDI task. One such system, for automatic eddy current inspection of wheels, is detailed later.

For access, perhaps the best-known example of automation is the climbing robot for eddy-current scans of lap-splice joints developed by Carnegie Mellon University (Albert, Kaufman and Siegel, 1994). This is being developed to automate the data acquisition of the NDI system, essentially by removing the human access function.

Search and Decision functions in automated inspection may not be easily separable (Drury and

Prabhu, 1994) so they will be considered together under sensing and signal processing. A major effort by the FAA and NASA to develop new sensor systems, to automate signal processing and to aid final decision-making has been underway throughout the 1990's (see D. Johnson, 1989) for preview, and DOT, 1993 for current status. Many of these applications are push-driven, and most are still in the stage of proof of concept. However, some have been tested under simulated operational conditions at the FAA's Aging Aircraft NDI Validation Center Facility at Albuquerque, NM. Typically, they represent good physical approaches to the detection problem, but with little thought given to integration between device and user at this stage. The same problem of user interface design is also apparent in operational eddy current and ultrasonic test equipment.

The response function can be, and has been, automated in combination with the Initiate function as part of a work control system. Thus in the hypertext system (Lofgren and Drury, 1994) when an inspector completes a workcard item, it can either be signed as good, or a Non-Routine Repair (NRR) form can be generated, both on the computer. Some airlines even have a bar-code system with lists of possible faults and positions, so that NRRs can be generated without any typing. A typical computer-driven system for generating NRRs was analyzed in the current project, with results presented later.

**4. Repair.** The Initiate functions of repair use the same automation technology as the equivalent function in inspection. Thus Goldsby (1991) describes the Aircraft Visit Management System (AVMS) at United Airlines that coordinates both inspection and repair activities through a central computer data base.

It is, however, in the diagnosis function that the major impact of automation is being felt. Because diagnosis of avionics failures is a rule-based and knowledge-based system, it is inviting for computer aiding, expert systems and artificial intelligence, e.g., Husni, 1992. AI techniques have been used in military avionics systems (e.g., Lesgold, 1990) with good evaluation results. Modern aircraft are designed with built-in systems to aid trouble-shooting and diagnosis. For example, the B-777 (Hessburg, 1992) has an On-Board Maintenance System (OMS), combining condition monitoring (cf. the CBM of Nakajima, Yamashina, Humagai and Toyota, 1992) with earlier Built-In Test Equipment (BITE). Early analog BITE systems were characterized as unfriendly to the user, while first-generation digital systems gave large numbers of false alarms (Hessburg, 1992). The newer systems, as ever, have promised to be free of the ills of the systems they replace. At least these newer OMS systems are designed with specific human factors input on user requirements.

Because of the typically high cost of removing avionics equipment that later turns out to be fault-free, there has been an expanding interest in using AI systems with models of the equipment as part of a diagnosis training program. Kurland and Huggins (1990) demonstrate a model training system (MACH-III) which trains for a functional understanding of the system itself and the diagnostic procedures. Johnson (1990) has developed Intelligent Tutoring Systems (ITS) for aircraft maintenance, again based on expert system concepts, but including a formalism for student and instructor modeling.

In the repair/replace function, there is little in the way of computer assistance except in repair shops where, for example, brakes, engines or seats are passed through a manufacturing-like

system away from the aircraft itself. Here part tracking, inventory control and scheduling are computer-based; there are some **CNC** machining centers and robotic welders (Goldsby, 1991). Here too Goldsby reports that work re-organization to give focused repair centers for nozzle guide vanes gave the results shown in **Table 11.5**. This use of cellular manufacturing concepts in maintenance gives similar spectacular results to those achieved in manufacturing industry. For a comparative example, **Table 11.5** also presents the data from Drury, 1991(a) for a manufacturing cell for zinc castings. Neither of these examples rely strictly on automation; both are automated machinery in a way that includes intelligent use of the human operator within a social and organizational context.

<b>Table 11.5 Comparison of examples of job redesign results in aircraft maintenance with those from manufacturing</b>				
	<b>Goldsby, 1991</b>		<b>Drury, 1991(a)</b>	
	Original Shop	Focused Repair Center	Original Plant	Manufacturing Cell
Cycle time, days	130	23	7	0.3
Labor cost, \$/part	57	33	1.71	0.81
Rejection rate, %	50	5	?	0
Travel distance, m	9600	16	209	13

No uses of automation have been located for the *reset systems* or *close access* functions of repair.

**5. Buy-Back and Return to Service.** As with the other functions (planning and initiate) which are paperwork-based, automation is proceeding more rapidly. With an automated workcard system, the outstanding items requiring buy-back or final sign-off can be found at any time. Goldsby (1991) describes bar-codes on badges and workcards that can be read to provide job control information. The fully electronic logbook is the next logical step. Questions about the need for a system are not typically addressed, although the current paper-based system is often cumbersome in practice.

## 11.6 FUNCTION ALLOCATION IN MAINTENANCE AND INSPECTION

As maintenance systems change, they offer more possible alternative allocations of function between people and other system elements. Technical advances in integration between machines and computing power have provided us with capabilities that are not only new but which force us to rethink our allocation philosophy. An obvious example is that computing power can be widely distributed yet inter-connected, instead of being either centralized or isolated. Particular emerging technologies are routinely examined in the aviation maintenance

press for their potential impact, for example, virtual reality applications to maintenance practice and training (Lombardo, 1995).

In systems design, function allocation has a long history as a set of techniques for deciding whether or not each function is best performed manually or by automation. As recent reviews indicate (Drury, 1994a; Sharit, 1996) the choice is not only between total automation and total manual allocation for each function, but also in the consideration of other solutions. One intermediate solution is *hybrid* automation, where the human and machine cooperate to perform the function. Another is *flexible* automation in which the system allows either the person or the automation to perform the function, with the final decision being made based upon the circumstances prevailing at each performance of the function.

For the current chapter we take the rather limited view of function allocation as the decision on the degree of automation of each function, leaving aside considerations of how to combine the human-allocated functions into meaningful jobs: Drury (1994a) provides a review of this later aspect.

Within function allocation, the techniques that have evolved over the years start with listing the functions (as was done for maintenance and inspection in **Section 11.5**), deciding whether any must necessarily be assigned one way (e.g., the legal requirement for a mechanic to sign off a repair), and then allocating the remaining functions so as to maximize some criteria of system performance. Suitable criteria include system effectiveness (reliability, speed), system efficiency (initial and running costs) and human well-being (health, safety, satisfaction).

Of these criteria of system performance, a number can be subsumed under the term "error" as failure to meet results in short or long term system malfunctions. Failure to meet a speed criterion in manufacturing gives an error of delay (e.g., delivery not on time). Accordingly, failure to provide for human well-being results in degraded system performance, either through injuries (obvious system errors) or reduced motivation. Although there are trade-offs between different error types (e.g., hits and false alarms) and between errors and speed (speed/accuracy trade-off), the choice between function allocation hypotheses is typically independent of these trade-offs. For example, two alternative function allocation hypotheses will usually have different Speed/Accuracy Trade-Off (SATO) curves, but the choice will generally be based on the overall position of the SATO curve, rather than on a single point on that curve.

Error has some other useful properties as a criterion, at least at the lower levels of function allocation:

1. It is a face-valid criterion in industry, meeting one of Clegg, Rauden, Corbett and Johnson's (1989) desirable features. With the current emphasis on total quality management, just-in-time (JIT) production and six-sigma criteria, there is a new-found zeal for error reduction. Providing further evidence is the continuing movement toward litigation to affix blame, especially in the USA. Indeed, there is a tendency now to see high quality/low error as the only criterion of competitiveness (Drury, 1994b).
2. A focus on error forces the designer to consider explicitly all forms of error, for example, failure modes, head events, injury events. Such analyses are becoming more

commonplace in manufacturing, for example in chemical processes, or with plant safety analyses.

3. There is a well-developed classification and analysis schemes for error, going back to Fitts and Jones' (1961) list of control operation errors in aircraft. The current resurgence of interest in error is well covered in Reason (1990), Hollnagel (1989), Rouse and Rouse (1983), and Senders and Moray (1991). With this interest has come a deeper understanding of the mechanisms contributing to error, and of the situations that can lead operators into error.
4. Because errors occur at many different levels of human operation in a system, explicit consideration of errors forces explicit consideration of the level of human functioning. For example, the simplest classification into slips and mistakes require consideration of skills/rules/knowledge levels of operation (Reason, 1990). These levels are:
  - Skill-based - where the person can make a rapid, almost automatic, selection of the correct action based on the signals from the system.
  - Rule-based - where the person must assess the state of the system and select the correct action based on sets of IF...THEN...ELSE rules.
  - Knowledge-based - where the person must choose an action based on reasoning derived from knowledge of the system.
5. Errors could be expected to be quite different between different allocations. For example, rule-based reasoning (typical of computers) has been described as brittle (Woods and Roth, 1988) i.e., not being able to function at all in novel situations, whereas people are prone to entirely different error forms, such as capture error, fixation on a single incumbent hypothesis, etc. The point is that in any system, some errors are more easily recovered than others. Thus using error as a criterion could reduce the level of "resident pathogens" in the system.

If we choose error as the criterion, then we can use error models, such as those of Reason (1990) or Rasmussen (1983) to help make the possible errors explicit. For example, **Table 11.6** shows the functions of inspection at each of three levels of human functioning described above.

<b>Table 11.6 Possible errors arising from functions in Table 11.3.</b>			
<b>[Note: Not an exhaustive error listing.]</b>			
<b>Function</b>	<b>Level of Operation</b>		
	<b>Skill-Based</b>	<b>Rule-Based</b>	<b>Knowledge-Based</b>
<b>1. INITIATE</b>	<ul style="list-style-type: none"> <li>o Mis-reads instructions</li> <li>o Slip in set-up/calibration sequence</li> </ul>	<ul style="list-style-type: none"> <li>o Mis-interprets instructions</li> <li>o Logical error in set-up/ calibration</li> </ul>	<ul style="list-style-type: none"> <li>o Mis-understands instructions</li> <li>o Mis-understands physics of calibration</li> </ul>
<b>2. ACCESS</b>	<ul style="list-style-type: none"> <li>o Mis-handles item</li> </ul>	<ul style="list-style-type: none"> <li>o Chooses wrong item to inspect</li> </ul>	

<b>3. SEARCH</b>	<ul style="list-style-type: none"> <li>o Fails to locate possible fault when fixated</li> <li>o Moves fixation to unintended location</li> </ul>	<ul style="list-style-type: none"> <li>o Selects inappropriate search sequence</li> </ul>	<ul style="list-style-type: none"> <li>o Mis-understands current conditions</li> <li>o Does not know how to optimize strategy</li> </ul>
<b>4. DECISION</b>	<ul style="list-style-type: none"> <li>o Mis-perceives difference between possible fault and standard</li> </ul>	<ul style="list-style-type: none"> <li>o Uses wrong standard</li> </ul>	<ul style="list-style-type: none"> <li>o Does not understand reasons for choice of standards</li> </ul>
<b>5. RESPOND</b>	<ul style="list-style-type: none"> <li>o Makes unintended response on item</li> </ul>	<ul style="list-style-type: none"> <li>o Fails to record response</li> </ul>	

Each of these levels of functioning produces its own particular errors: skill-based slips, rule-based mistakes and knowledge-based mistakes. In **Table 11.6**, these are made specific to the job of inspection. Note that the more "mechanical" functions of Access and Respond have few higher level aspects, and thus few higher level errors. Also note that to apply this methodology to an actual inspection job, we need to break each function down into more detailed tasks, giving a "function and task analysis."

Despite this listing of errors, as far as system performance is concerned, there are only three possible system errors:

**Missed Fault:** a true fault receives the response appropriate to a non-fault

**False Alarm:** a non-fault receives the response appropriate to a true fault

**Delay:** no response is made during an appropriate time interval

The mapping of the component or function errors onto the system errors depends upon the detailed allocation used. Models for these error mappings have been proposed for aircraft structural inspection (Drury, 1991b), and for generic inspection processes (Drury and Prabhu, 1994).

With the information in **Tables 11.1** and **11.2** we are in a better position to evaluate alternative hypotheses for each function. There are many feasible systems for automated inspection (see Drury and Prabhu, 1994), but all have a tendency towards "brittleness" and lack of flexibility. For example, Drury and Sinclair (1983), in direct comparisons of human and automated inspection found, as expected, that people and automated vision systems had complementary rather than competitive qualities. In general, search was better performed by machines and decision by people.

From the function and error breakdown of inspection, we can postulate feasible hypotheses, allocating to either people, automated systems or both, i.e., hybrid. For this we need to be more specific than the generic inspection task presented in **Tables 11.3** and **11.6**.

In manufacturing inspection there have been a number of tests of alternative allocations, based

on criteria such as errors, cost and speed (Drury and Sinclair, 1983; Hou, Lin and Drury, 1993) and on human well being, such as stress measures (Drury and Goonetilleke, 1992a, b). In these studies, hybrid automation was usually the recommended choice, combining the unique strengths of both the human inspector and the computer to perform better than either could alone. For aircraft inspection, the choice is usually seen as depending upon the feasibility of automating each function, the costs of equipment, the savings in time and the quoted reliability. Integration with the human inspector is typically considered as a training functions Most vendors attempt to make their systems "user friendly" but do not explicitly use human factors data in design. Also, the testing is often by the designer and colleagues, with inspectors brought in during the implementation phase. Again, the body of human factors knowledge on how to design rapid and effective usability trials is not typically part of the design process. Almost never are there direct tests of the effects of different function allocations, although well-designed validation studies of the overall human-plus-hardware system are now being undertaken at the FAA's Aging Aircraft NDI Evaluation Center. An example is reliability and cost evaluations of the Nortec-30 Eddyscan System (Spencer, 1994).

The remainder of this chapter shows a methodology for incorporating modern ideas of function allocation and error prevention into the design of equipment for aircraft inspection and maintenance. We start with an example that applies the function and error analysis of this section to automated and manual examples of an airline inspection and maintenance job.

## 11.7 EXAMPLE OF FUNCTION, TASK AND ERROR ANALYSIS

At our airline partner, a recent automation project was to provide small portable computers to inspectors so that Non-Routine Repair (NRR) reports could be produced automatically. The computer was a small hand-held device with keys and a touch screen as input devices and a screen about 75mm x 125mm as the display. Developed in-house, the software and hardware allowed the inspector to download the current task, enter discrepancies (largely from menus), type in additional data on a "soft" keyboard, and upload the results to a main computer that can print and track the NRRs. We were able to observe and analyze both this automated system and the current manual system at the airline partner's facility. This provides an example of a function and task analysis for two equivalent systems and shows where the possible errors match and differ between the two.

The task and error analysis in [Table 11.7](#) is organized by the main functions of inspection ([Table 11.3](#)). As there are few differences in Access Search and Decision, the analysis is less detailed in these functions. In this analysis, not every contingency (e.g., interruptions) is covered, nor are all software features explained. When this methodology is used in design rather than post-hoc analysis, more detail will usually be included.

<b>Table 11.7 Function, Task and Error Analysis of NRR Automation.</b>	
* indicates known common error	
<b>Manual</b>	<b>Automated</b>



<b>Function</b>	<b>Task Step</b>	<b>Possible Errors</b>	<b>Task Step</b>	<b>Possible Errors</b>
<b>Set-Up</b>	Obtain workcard	Wrong workcard	Obtain workcard	Wrong workcard
			Log on with bar-code reader	Wrong bar-code
	Obtain tools, materials	Unavailable Omitted	Obtain tools, materials, computer	Unavailable Omitted
	Obtain tools, materials	Unavailable Omitted	Obtain tools, materials, computer	Unavailable Omitted
<b>Access</b>	Go to aircraft		Go to aircraft	
	Go to inspection area	Area inaccessible	Go to inspection area	Area inaccessible
	Place tools, materials in area	Insufficient room	Place tools, materials, computer in area	Insufficient room
<b>Search</b>	Search area, visual or NDI	Missed area Missed indication	Search area, visual or NDI	Missed area Missed indication
	Find indication		Find indication	
<b>Decision</b>	Compare indication to standards	Wrong standards	Compare indication to standards	Wrong standards
	Decide to report	Fail to report fault False alarm	Decide to report	Fail to report fault False alarm
<b>Respond</b>	Put new NRR on top of clipboard		"Continue" on home screen	
	Write in employee number	Wrong number	"Employee Field" on login screen	Wrong button
			Enter employee number	Wrong number
			"Personal ID"	Wrong ID
			"OK"	Omit step
	Write in workcard	Wrong number	"Choose card"	Wrong area

number		
	Find workcard in dialog box	Wrong workcard
	"Select"	Wrong button
	"Continue"	Omit step

**Table 11.7 Function, Task and Error Analysis of NRR Automation. (Cont'd)**  
 \* indicates known common error

Manual			Automated	
Function	Task Step	Possible Errors	Task Step	Possible Errors
<b>Respond (cont.)</b>	Increment NRR card number	Fail to increment*	NRR appears on computer with incremented number	
	Write in aircraft number	Wrong number Poor writing*		
	Write in station	Omit step* Wrong station Poor writing*		
	Write in description of discrepancy	Poor writing* Non-Standard terminology	"Continue"	Omit step
			Find discrepancy in dialog box	Made error Too many terms No appropriate term
			"Accept"	Choose wrong item
			(editing) "keyboard"	Wrong button
			Touch area to edit	Poor aim
			Use soft keyboard	Poor aim Not good for touch typing
			"OK"	Hit OK before edit complete
Write in location on aircraft	Wrong location Non-standard terminology Poor writing*	"Charts"	Wrong button	
		Find chart in dialog	Poor labels on charts	

			box	cause wrong chart
			"Accept"	Omit step
			Find region number on chart	Wrong region
			"Return"	Omit step
			Return to text	Mode error
			Locate place to insert region number	Wrong place in text
			Enter region number	Wrong number
			"Finished"	Omit step
	Check box for inspection item	Omit check	Check box for inspection item	Omit check
	Sign and date	Omit step	"Continue"	Omit step

**Table 11.7 Function, Task and Error Analysis of NRR Automation. (Cont'd)**  
 \* indicates known common error

		Manual		Automated	
Function	Task Step	Possible Errors		Task Step	Possible Errors
<b>Respond (cont.)</b>	Note: must complete all Respond steps for each NRR			Note: can paste between NRRs and edit any NRRs	
<b>Plan Repair</b>	Take NRRs to control center and give to planner	<b>Forget*</b> Leave without telling planner		Take computer to control center	
	Planner logs NRRs	Logs incorrectly Fails to monitor errors in NRRs		Upload NRRs to main computer	Fails to upload
	Distribute to production foreman	NRRs misplaced NRRs not given		Give computer to production foreman	
	Production foreman checks NRRs for evaluation	Wrong evaluation		Production foreman checks NRRs for evaluation	Wrong evaluation
<b>Repair</b>	NRRs distributed to AMTs	Wrong distribution		NRRs distributed to AMT	Wrong distribution
	NRRs manually	Log errors		NRRs logged out on	

	logged out		computer	
	AMT reads NRR	Misinterprets written NRR	AMT reads NRR	Misinterprets computer-generated NRR
	AMT performs repair	AMT errors	AMT performs repair	AMT errors
	If inspection item place NRR in QC box for buyback	Omits step	If inspection item place NRR in QC box for buyback	Omits step
	Log NRRs in	Log in errors		
<b>Buyback</b>	Issue NRR to inspection foreman	Omit step	Issue NRR to inspection foreman	Omit step
	Log NRR out	Wrong NRR number	Assign NRR on computer	
	Log NRR in	Wrong NRR number Omit step	Computer login of NRR	Omit step Mode error

From an analysis such as **Table 11.7** it is possible to see where errors differ as automation is introduced. In this case a major reason for the automation was problems with penmanship and non-standard terminology in NRRs produced by inspectors. The computer system reduces such errors at the expense of having the inspector select from long lists of possible features (type of defect, etc.). These lists have no hierarchical structure in most systems: typically just an alphabetical list is used. In the field of human-computer interaction, better menu structures for long lists have been found, by first providing major choices which each lead to further sublists. Keeping each menu list under about 8-10 items improves search performance. This helps eliminate the error where the inspector loses patience and finds a menu item that is "close enough." Elimination of imprecision in NRRs was a major reason for the automation in the first place: we should use human factors knowledge to ensure that the design of the system does not inadvertently perpetrate imprecision.

The analysis in **Table 11.7** took place after the computer system was functional, so that we could observe both the manual and automated versions. An advantage of function and task analysis is that the same analysis could have been performed while the computer system was still in the development stage. Indeed, it is good programming practice to involve users in the design of software, to lay out all functions that must be performed, and to test the system with users. At our airline partner, the programming used industry good practice, and the result was a functional and usable system. For example many of the errors listed under the automated column of **Table 11.7** were anticipated in the software, and the system designed to prevent their propagation. Thus if a "continue" button touch is omitted, the software will not respond correctly with the next screen. One difference in the human factors approach advocated here is that functions and tasks

are presented in **Table 11.7** hierarchically to better discover the possible errors. A second difference is that, throughout the early design process, explicit decisions are made concerning whether or not to automate each function. Only after the possible errors have been listed, do the designers decide whether a human, the computer or both should perform a function. The idea is not to automate a function just because it is technically feasible.

## 11.8 AN ERROR-AVOIDANCE DESIGN PROCEDURE

We have introduced the elements of a design philosophy throughout this chapter; now they are integrated into a consistent set of steps suitable for use by those designing or purchasing automated equipment. Three factors underlay this design procedure:

1. The functions of the system are first listed in such a way as to avoid a decision of whether each will be automated or not. This ensures that the designer's mind is kept open to different ideas and not forced arbitrarily into one stance. Functional thinking at this stage helps to avoid fixation on hardware or on personnel considerations.
2. Users have a central role to play throughout the process, from listing functions, through detailed design to test and evaluate. Since successful design should meet real user needs, a wide range of users must be involved in the process. This is not just surveying inspectors and AMTs for their ideas, or demonstrating prototypes to AMTs, but having users as a part of the design team.
3. Awareness of technical human factors data (and methods of evaluation) will help design decisions remain grounded in fact rather than subjective opinion. Indeed, in most applications domains other than aircraft maintenance and inspection, human factors are seen as primarily contributing to equipment and interface design. Many aspects of system and interface design have detailed data-based recommendations, for example the design of user/computer interfaces (Helander, 1988; **ANSI/HFS-100**). A listing of sources is provided at the end of this chapter but the FAA's *Human Factors Guide to Aviation Maintenance* is a good starting point.

With these factors in mind, a step-by-step procedure is presented, with an example based on an existing system that is treated here as if it were a system under design. This system is for the eddy current inspection of aircraft wheels. Typically a workshop job, wheel inspection here uses eddy-current inspection of wheel rims and bolt holes. This example was observed at our airline partner's facility, where again both automated and manual systems were available. Currently, there is interest in further using automation to enhance such systems with an FAA-sponsored project on the use of signal classification software at the Center for Aviation Systems Reliability (Brasche, 1995).

### 11.8.1 Step One - List System Functions

A system is defined by what it must do, so the obvious place to start is from a short sentence describing the transformation of input to output. For our example, this could be "Accurately sort good from defective wheels using eddy-current inspection." The functions for eddy-current

inspection of aircraft wheels are:

- Setup
- Access
- Search
- Decision
- Respond

## 11.8.2 Step Two - List Alternative Allocations for Each Function

Here, each function listed is considered IN ISOLATION for allocation between human, machine or hybrid. The reason for considering functions in isolation is to prevent a single early decision from biasing all subsequent ones. **Step 4** will integrate functions into a coherent system, which may force changes in some allocations, but those changes will then be evaluated from a whole-system context.

As we perform Step 2, it may be necessary to change the function listing slightly. For example, if both the bolt holes and wheel rim must be searched, there are really two search functions. Each could, in principle, be automated independently of the other. **Table 11.8** shows the results of this analysis. Hybrid automation is not considered here for simplicity, but could be incorporated as another column. For example, hybrid decision making would have the computer display the eddy current signal to the operator, with a recommendation from the pattern recognition algorithm, so that the operator could make the final decision.

<b>Table 11.8 Manual and Automated Allocation of Each Function for Wheel Inspection</b>		
<b>FUNCTION</b>	<b>MANUAL</b>	<b>AUTOMATED</b>
Set-Up	<ul style="list-style-type: none"> <li>•Manually calibrate Eddy Current (EC) probe on standard defect.</li> </ul>	<ul style="list-style-type: none"> <li>•Calibrate EC probe on standard defect using automated procedure.</li> <li>•Enter wheel size, configuration data.</li> </ul>
Access	<ul style="list-style-type: none"> <li>•Place wheel on cart.</li> <li>•Move to Eddy Current table.</li> <li>• Place on fixture.</li> </ul>	<ul style="list-style-type: none"> <li>•Use pick and place robot to move wheel to fixture.</li> </ul>
Search 1: Bolt Holes	<ul style="list-style-type: none"> <li>•Manually probe circumference of bolt hole.</li> <li>•Move to next bolt hole.</li> <li>•Stop on indication or after last bolt hole.</li> </ul>	<ul style="list-style-type: none"> <li>•Automated scanning of circumference of bolt hole.</li> <li>•Move to next bolt hole.</li> <li>•Stop on computer indication or after last bolt hole.</li> </ul>
Search 2:	<ul style="list-style-type: none"> <li>•Manually spin wheel against EC</li> </ul>	<ul style="list-style-type: none"> <li>•Computer spins wheel and scans</li> </ul>

Wheel Rim	probe. •Move probe across while rim. •Stop on indication or at edge of rim.	rim surface with EC probe. •Stop on indication or at edge of rim.
Decision	•Manually probe each indication. •Check EC display against standard.	•Use pattern recognition algorithm on each indication to compare against standard.
Respond	•Manually move healthy wheel to appropriate rack. •Mark defects on defective wheel and manually move to appropriate rack.	•Pick and place robot. •Move wheel to appropriate hole. •Automatic marking of defects.

### 11.8.3 Step Three - List Errors for Each Function

As each function is considered for automation, its possible errors need to be listed. This step requires a more detailed breakdown of the functions into separate tasks, as was done in **Table 11.7** for the NRR production. We collected more detailed task steps for the current automated and manual versions of each wheel inspection task at the airline partner's facility, but only present two functions here for brevity. Errors are found quite easily for existing systems, both by listing the ways in which tasks can go wrong and by interviewing AMTs/inspectors. For projected systems, only logical analysis is possible, but analogies with other systems can be used, for example eddy current automation on other components, or manufacturer's brochures on automated devices.

**Table 11.9** shows the results of this step for Search 2: Wheel Rim and Decision in wheel inspection. Note that for most detection algorithms, search and decision do not split as neatly as they do for human inspectors. The error results, however, are identical: misses and false alarms.

<b>Table 11.9 Task Steps and Possible Errors for Wheel Inspection (Two functions only)</b>				
	<b>Manual</b>		<b>Automated</b>	
<b>Function</b>	<b>Task Step</b>	<b>Possible Errors</b>	<b>Task Step</b>	<b>Possible Errors</b>
Search 2: wheel rim	Spin wheel	Wrong speed off-counter	Initiate "wheel spin" program.	Wrong setup conditions specifies.
	Locate probe at edge of rim	Not at edge. Wrong pressure	Initiate "search wheel rim" program.	Misaligned probe.

	Move probe across rim to other edge	Missed areas. Stop before other edge.		Mechanical malfunction.
	Observe EC display	Failure to observe miss indication. Detect false indication.	Algorithm interprets EC signal.	Miss False alarm.
Decision	Re-probe suspected area	Wrong area.		
	Observe EC display	Failure to observe miss indication. Detect false indication		
	Compare to standard	Wrong standard.  Mis-calibration		
	Reach decision	Miss false alarm.		

The most important criterion may be how well the human and automated subsystems are integrated in the whole hangar environment, as seen in the summary of successful automation applications in **Table 11.2**. This emphasizes once again the need for active and continuous involvement of the users in the design procedure.

Detailed design of each function can now proceed, at least to the level required to determine whether the separate function choices can be successfully integrated. Detailed design of hardware, software and their communications (interfaces) are covered in the *Human Factors Guide to Aviation Maintenance*. As our wheel inspection example is already built, we cannot profitably continue the example further.

#### 11.8.4 Step Four - System Integration

Will the chosen allocations of each function fit together into a whole system? They must eventually, so design compromises may be required to ensure that the whole system works. This has two aspects:

1. Are the automated functions compatible? In our wheel inspection example, does electrical interference or mechanical interaction adversely affect the data from the eddy current probe? In this example, we have seen that Search and Decision are difficult to split, so that if one is assigned to automation the other cannot be entirely manual (although it could be hybrid).
2. Do the functions assigned to the inspector make a meaningful whole? Have we reduced



the operator to another automaton with none of the requirements for a satisfying job being met? There are many examples, both in manufacturing and in aircraft maintenance and inspection, where the operator is assigned the few "left over" functions when automation is incomplete. The evidence shows (e.g., Bainbridge, 1990) this is the least effective way of automating as it breeds rote job performance and dissatisfaction among operators. **Table 11.2** makes clear that such job design aspects are of vital importance in automation. Further information on these aspects can be found in Drury, 1995b and Taylor, 1991.

In the wheel inspection example, the system in use at our airline partner's facility allocated Set-up, Access and Response to the inspector, and Search and Decision to automated components. However, there is a manual check each shift on all defects found before wheels are finally scrapped, so that a second (manual) Decision function has been added.

## 11.9 CONCLUSIONS

The importance of error in automated systems has been shown in aircraft maintenance and inspection as well as in other domains such as flight operations and manufacturing. A six-step procedure has been demonstrated which allows explicit allocation of functions between people and automation, with errors as a major criterion of the choice.

## 11.10 REFERENCES

- Albert, C. J., Kaufman, W. M. and Siegel, M. W. (1994). *Development of an Automated Nondestructive Inspection (ANDI) system for commercial aircraft: Phase I*, DOT/FAA/CT-94/23, Virginia: National Technical Information Service.
- American National Standards Institute (1988). *American national standard for human factors engineering of visual display terminal workstations*. ANSI/HFS-100, Santa Monica, CA: Human Factors Society, Inc.
- Bainbridge, L. (1990). Verbal protocol analysis. In Wilson, J. R. and Corlett, E. N. (Eds.), *Evaluation of Human Work* (pp. 161-179). London: Taylor and Francis.
- Bessant, J., Levy, P., Ley, C., Smith, S. and Tranfield, D. (1992). Organization design for factory 2000. *The International Journal of Human Factors in Manufacturing*, Vol. 2 (2), New York: John Wiley & Sons, Inc., 95-125.
- Brasche, L. (1995). *The Federal Aviation Administration Center for Aviation Systems Reliability, a synopsis*. Ames, Iowa: Iowa State University of Science and Technology.
- Brödner, P. (1994). Design of work and technology. In Salvendy, G. and Karwowski, W. (Eds.) *Design of work and development of personnel in advanced manufacturing* (pp. 125-157).

New York: John Wiley & Sons, Inc.

- Clegg, C., Rauden, S., Corbett, M. and Johnson, G. 1989, Allocating functions in computer integrated manufacturing: a review and a new method, *Behaviour and Information Technology*, 8, 175-190.
- Department of Transportation (1993). *National Aging Aircraft Research Program Plan*. Atlantic City, NJ: Federal Aviation Administration Technical Center.
- Drury, C. G. (1995a). Automation in quality control and maintenance. In Parasuraman, R. (Ed.), *Automation and Human Performance* (ch. 19). New York: John Wiley & Sons.
- Drury, C. G. (1991a). Ergonomics practice in manufacturing. *Ergonomics*, 1991, Vol. 34(6), 825-839.
- Drury, C. G. (1991b). Errors in aviation maintenance: Taxonomy and control. *Proceedings of the Human Factors Society 35th Annual Meeting*, 1, 42-46.
- Drury, C. G. (1994b). The speed-accuracy trade-off in industry, *Ergonomics*, 37.
- Drury, C. G. (1995b). Work design. In Maddox, M. (Ed.), *Human Factors Guide for Aviation Maintenance* (ch. 6). Springfield, VA: National Technical Service.
- Drury, C. G. (1994a). Function allocation in manufacturing. In Robertston, S. A. (Ed.), *Proceedings of the Ergonomics Society 1994 Annual Conference*, University of Warwick, 19-22 April 1994, 2-16.
- Drury, C. G. and Goonetilleke, R. S. (1992a). Stress, performance and automation: a controlled study. *Proceedings of the 1992 "Ergonomics for Industry" Annual Conference*, 131-137.
- Drury, C. G. and Goonetilleke, R. S. (1992b). Stress, performance and automation: a field study. *Proceedings for the Ergonomics Society of Australia Conference*, December 1992, 48-55.
- Drury, C. G. and Prabhu, P. V. (1994). Human factors in test and inspection. In Salvendy, G. and Karwowski, W. (Eds.), *Handbook of Human Factors*, New York: John Wiley and Sons, Inc., 355-402.
- Drury, C. G. and Sinclair, M. A. (1983). Human and machine performance in an inspection task, *Human Factors*, 25.4, 391-400.
- Drury, C. G., Prabhu, P. V. and Gramopadhye, A. K. (1990). Task analysis of aircraft inspection activities: Methods and findings, In *Proceedings of the Human Factors Society 34th Annual Conference*, Santa Monica, CA, 1181-1185.

- Fitts, P. M. and Jones, R. E. (1961). Analysis of factors contributing to 400 pilot error experiences in operating controls. In H. W. Sinaiko (Ed.), *Selected papers on human factors in the design and use of controls systems*, (pp. 33-358). Dover, NY.
- Goldsby, R. P. (1991). Effects of automation in maintenance. In *Proceedings of the Fifth FAA Meeting on Human Factors Issues in Aircraft Maintenance and Inspection*, Atlanta, GA, 103-123.
- Helander, M. (Ed.) (1988). *Handbook of Human-Computer Interaction*, Amsterdam, The Netherlands: Elsevier Science Publishers B.V.
- Hessburg, J. (1992). Human factors considerations on the 777 on board maintenance system design. In *Meeting Proceedings Sixth Federal Aviation Administration Meeting on Human Factors Issues in Aircraft Maintenance and Inspection "Maintenance 2000"*, 22-23 January 1992, Alexandria, VA, 77-91.
- Hollnagel, E. (1989). The phenotype of erroneous actions: implications for HCI design. In G. R. S. Weir and J. L. Alty (Eds.), *Human-Computer Interaction and Complex System* London: Academic Press.
- Horte, S. A. and Lindberg, P. (1991). Implementation of advanced manufacturing technologies: Swedish FMS experiences. *International Journal of Human Factors in Manufacturing*, 1, New York: John Wiley & Sons, Inc., 55-73.
- Hou, T-S, Lin, L. and Drury, C. G. (1993). An empirical study of hybrid inspection systems and allocation of inspection function. *International Journal of Human Factors in Manufacturing*, 3, 351-367.
- Husni, M. (1992). Advances in artificial intelligence for aircraft maintenance. *Meeting Proceedings Sixth Federal Aviation Administration Meeting on Human Factors Issues in Aircraft Maintenance and Inspection "Maintenance 2000"*, 22-23 January 1992, Alexandria, VA, 157-171.
- Johnson, D. (1989). Research and development. In *Proceedings of the 2nd Annual International Conference on Aging Aircraft*, Federal Aviation Administration, 3-5 October 1989, Baltimore, MD, 30-35.
- Johnson, R. C. (1990). An integrated maintenance information system (IMIS): An update. *Final Report Second Federal Aviation Administration Meeting on Human Factors Issues in Aircraft Maintenance and Inspection "Information Exchange and Communications"*, Washington, DC: Office of Aviation Medicine, Federal Aviation Administration, 141-150.
- Kidd, P. T. and Karwowski, W. (Eds.) (1994). *Advances in Agile Manufacturing*. Washington,

DC: IOS Press.

- Kurland, L. and Huggins, A. W. F. (1990). Training trouble-shooting using advanced AI-based training technology, In *Proceedings of the FAA Training Technology Symposium*, Oklahoma City, OK, 133-148.
- Lesgold, A. M. (1990). Intelligent computer aids for practice of complex troubleshooting. In *Proceedings of the FAA Training Technology Symposium*, Oklahoma City, OK, 116-132.
- Lofgren, J. and Drury, C. G. (1994). Human factors advances at Continental Airlines. In *Proceedings of the 8th FAA/AAM Meeting on Human Factors in Aviation Maintenance and Inspection "Trends and Advances in Aviation Maintenance Operations"*, Alexandria, VA, 16-17 November 1993, 117-138.
- Lombardo, D. A. (1995). Virtual maintenance. *AEM*, September 1995, 40-46.
- Lutzinger, R. (1992). Tomorrow's problems as seen by maintenance managers. *Meeting Proceedings Sixth Federal Aviation Administration Meeting on Human Factors Issues in Aircraft Maintenance and Inspection "Maintenance 2000"*, 22-23 January 1992, Alexandria, VA, 97.
- Marx, D. (1992). Looking toward 2000: the evolution of human factors in maintenance. *Meeting Proceedings Sixth Federal Aviation Administration Meeting on Human Factors Issues in Aircraft Maintenance and Inspection "Maintenance 2000"*, 22-23 January 1992, Alexandria, VA, 64-76.
- Murgatroyd, R. A. and Worrall, G. M. (1994). Effect of human factors on the reliability of routine inspections. AEA-RS-4509. AEA Technology, Reader Services, Risley, UK.
- Nakajima, S., Yamashina, H. Humagai, C. and Toyota, T. (1992). Maintenance management and control. In Salvendy, G. (Ed.), *Handbook of Industrial Engineering*, Second Edition, (pp. 1927-1996). New York: John Wiley & Sons, Inc.
- Norman, D.A. (1981). Categorization of action slips. *Psychological Review*, 88(1), 1-15.
- Patel, S., Drury, C. G. and Lofgren, J. (1994). Design of workcards for aircraft inspection, *Applied Ergonomics 1994*, 25(5), 283-293
- Pinedo, M. (1992). Scheduling. In Salvendy, G. (Ed.), *Handbook of Industrial Engineering*, Second Edition, New York: John Wiley & Sons, Inc., 2131-2153.
- Rasmussen, J. (1983). Skills, rules, knowledge: signals, signs and symbols and other distinctions in human performance models, *IEEE Transactions: Systems, Man and Cybernetics*,

SMC-13, 3, 257-267.

Rasmussen, J., Duncan, K. and Leplat, J. (Eds.) (1987). *New Technology and Human Errors*, New York: John Wiley & Sons, Inc.

Reason, J. (1990). *Human Error*. Cambridge, UK: Cambridge University Press.

Rouse, W. B. and Rouse, S. H. (1983). Analysis and classification of human error. *IEEE Transactions Systems, Man and Cybernetics*, Vol. SMC-13(4), 539-549.

Sanderson, P. M. (1989). The human planning and scheduling role in advanced manufacturing systems: an emerging human factors domain, *Human Factors*, 31, 6, 635-666.

Sarter, N. B. and Woods, D. D. (1995). How in the world did we ever get into that mode? Mode error and awareness in supervisory control. *Human Factors*, 37(1), 5-19.

Senders, J. W. and Moray, N. P. (1991). *Human Error: Cause, Prediction and Reduction*. Hillsdale, NJ: Lawrence Erlbaum Associates.

Sharit, J. (1996 in press). Function allocation. In Salvendy, G. (Ed.), *Handbook of Human Factors and Ergonomics*, Second Edition, New York: John Wiley & Sons, Inc.

Sheridan, T. B. (1994). Human supervisory control. In Salvendy, G. and Karwowski, W. (Eds.), *Design of Work and Development of Personnel in Advanced Manufacturing* (p. 100). New York: John Wiley & Sons, Inc.

Sheridan, T. B. (1992). *Telerobotics, Automation, and Human Supervisory Control*. (pp. 360, 356) Cambridge, MA: The MIT Press.

Sheridan, T. B. (1988). Task allocation and supervisory control. In Helander, M. (Ed.), *Handbook of Human-Computer Interaction*, 8, Amsterdam: Elsevier.

Spencer, F. (1994). Inspection reliability of a Nortec-30 Eddyscan System. SAND94-0128, Albuquerque, NM: Sandia National Laboratories.

Taylor, J. C. (1991). Maintenance organization. *Human Factors in Aviation Maintenance Phase I: Progress Report*, DOT/FAA/AM-91/16, Chapter 2, Office of Aviation Medicine, Springfield, VA: National Technical Information Service, 15-43.

Wiener, E. L. and Nagel, D. C. (Eds.) (1988). *Human Factors in Aviation*. San Diego: Academic Press, Inc.

Woods, D. D. and Roth, E. M. (1988). Cognitive systems engineering. In M. Helander (Ed.),

*Handbook of Human-Computer Interaction, 1*, (Elsevier, Amsterdam).

# CHAPTER 12

## FIELD EVALUATION OF SIMPLIFIED ENGLISH FOR AIRCRAFT WORKCARDS

S. Chervak and C. G. Drury, Ph.D.,  
*Industrial Engineering Department, State University Of New York At Buffalo*  
and  
J. P. Ouellette  
*GE Aircraft Engines*

### 12.1 ABSTRACT

The restricted technical language Simplified English (AECMA, 1995) was evaluated using aircraft maintenance workcards. One hundred seventy-five practicing Aircraft Maintenance Technicians (AMTs) were given a comprehension test of four different workcards. Each workcard was produced in Simplified English (SE) and Non-Simplified English (Non-SE) versions with two different layouts. Simplified English versions gave improved performance as measured by comprehension error rate that was reduced from 18% to 14% with SE. Most of the improvement was obtained where conditions were most challenging: for more difficult workcards and with non-native English speakers. No effects of workcard layout on performance were observed.

### 12.2 INTRODUCTION

The importance of good document design practices to the writing of aircraft work control cards (workcards) has already been documented (Bohr, 1978; Patel, Drury and Lofgren, 1994). Patel, et al., (1994) showed several deficiencies in structuring, wording, layout and typography, and related these to potential errors by Aircraft Maintenance Technicians (AMTs) in performing their tasks. An improved design was developed and evaluated to demonstrate its superiority. This design was based on the application of the principles of document typography and layout from the human factors literature. Documents produced in the Patel, et al., (1994) study had a better choice of case and font, a more consistent paragraph structure, and better integration of text with graphics. There are, however, issues in document design that go beyond layout and typography.

Most major transport aircraft manufacturers now use Simplified English (SE) in their documentation. However, the impact of this restricted language on AMTs has not been measured directly. The current study provides such an evaluation to determine whether SE enhances (or degrades) comprehension of workcards by AMTs.

### 12.2.1 Simplified English

Since Latin faded as the common scientific language, there have been various attempts to produce artificial languages to allow people of different countries to intercommunicate. For general use, the early twentieth century saw Esperanto and later Basic English (Ogden, 1934). More recently, restricted technical languages have appeared, such as Caterpillar Fundamental English (CFE) for the documentation of agricultural vehicles, and Simplified English (SE) for the documentation of procedures on commercial aircraft. More information on the development and details of these restricted languages can be found in Shubert, Spyridakis, Holmback and Coney (in press).

### 12.2.2 Issues in Evaluation

While restricted languages such as SE make logical sense, there is still a need to evaluate their effectiveness. Despite potentially reduced ambiguity, there are still feelings among some technical writers that SE prevents them from expressing instructions in the most obvious manner. Restricted languages can appear restrictive to some. Since the documentation is designed for the user, the effect of SE on the AMT is the ultimate criterion. Hence direct evaluation of SE using actual workcards and practicing AMTs is an obvious step.

Evaluation by users has a long history in document design. For example, McLaughlin (1966) compared the readability of two versions of a government pamphlet using a comprehension test. He found the version that had been revised for readability gave improved comprehension. The relationship between readability and comprehension has been documented further in a number of studies reviewed by Klare (1978). A more recent compilation of studies of warnings (Edworthy, Hellier and Stanton, 1995), showed speed of use, accuracy and rating scales as frequently used measures of the performance of different aspects of warning design.

A major evaluation study of SE, by Shubert, et al., (in press) followed a methodology similar to that of McLaughlin (1966), using a comprehension test.. SE and Non-SE versions of two maintenance manual procedures were tested on 127 engineering students. While having comparable overall lengths, the two procedures differed in a number of measures of writing complexity, one being more complex than the other. A between-subjects experimental design was used, where each subject was tested on only one of the four documents. The comprehension test was timed and performance on the test was measured both by whether each question had the correct answer and whether the information used for the answer could be located correctly within the maintenance manual procedure.

Analyses were performed separately for native English speakers and non-native English speakers and for the two maintenance manual procedures which differed in complexity. Measures of both the comprehension and the content location showed a significant effect of Simplified English and a significant Simplified English  $\times$  Procedure interaction. The native English speakers scored higher than their non-native English speaking counterparts. Simplified English gave higher comprehension and location scores than non-Simplified English for the more complex procedure only. Performance time was not a significant factor, except that non-native English speakers



were slower overall.

From these studies it was concluded that to evaluate a restricted language we must control both the users' native language and the document complexity. In addition the evaluation should focus on the accuracy of comprehension using a comprehension test based upon the documents themselves. "Accuracy of comprehension" should measure the correctness of both comprehension questions and location questions.

## 12.3 METHODOLOGY

The basis of our methodology was to extend the comprehension test technique to the use of workcards by practicing AMTs. Differences from the Shubert, et al., (in press) study were the choice of subjects (AMTs versus students), levels of document complexity (four workcards versus two procedures) and the addition of two levels of workcard layout to provide a test performance of the Patel, et al., (1994) results.

### 12.3.1 Choice of Workcards

Following discussions with computational linguists at Boeing Inc. and with Aerospace Industries Association of America (AIAA) Simplified English Committee members, it was decided to use actual examples of existing workcards in the evaluation. For two aircraft types, Boeing had produced workcards in pre-SE maintenance manual language and had later modified these to Simplified English standards. Thus the workcards were realistic AMTs and represented actual writing practice by those who write maintenance manual procedures. In this way, difficulties of translating Simplified English workcards back into artificial non-Simplified English versions was avoided. The one drawback of this decision was that the SE interpretation was not always "perfect", i.e., AIAA committee members could still identify a few possible changes needed to ensure full compliance with the latest release of SE. The standard of SE in these workcards was high, and represented real-world "good practice." The benefits of using "real" workcards were considered to far outweigh the few possible non-SE interpretations introduced by real technical writers in their normal writing practice.

Seventeen potential workcards were analyzed for possible inclusion in the study. The Boeing computational linguists and University of Washington technical communications researchers analyzed the non-SE versions of each in terms of total words, mean words per sentence, percentage passive voice, and Flesch-Kinkaid reading score. A task difficulty rating of each workcard by an experienced engineer also was used for guidance. Each of these variables was split at the median to be able to match workcards at the high or low level of each variable. From this analysis, four workcards were chosen, two "easy" on all the measures and two "difficult." Within each pair the document lengths were different, which would presumably mainly affect performance times, although document length could also affect comprehension through additional cognitive load. **Table 12.1** shows the four workcards chosen.

**Table 12.1 Characteristics of The Four Workcards Used**

<b>Workcard</b>	<b>Word Count</b>	<b>Words per Sentence</b>	<b>Percentage Passive</b>	<b>Flesch-Kinkaid</b>
Easy 1	472	13 (lo)	13 (lo)	9.3 (lo)
Easy 2	254	8 (lo)	3 (lo)	8.6 (lo)
Difficult 1	554	19 (hi)	31 (hi)	10.8 (hi)
Difficult 2	491	17 (hi)	25 (hi)	10.4 (hi)

Each of these four workcards was then prepared in four versions:

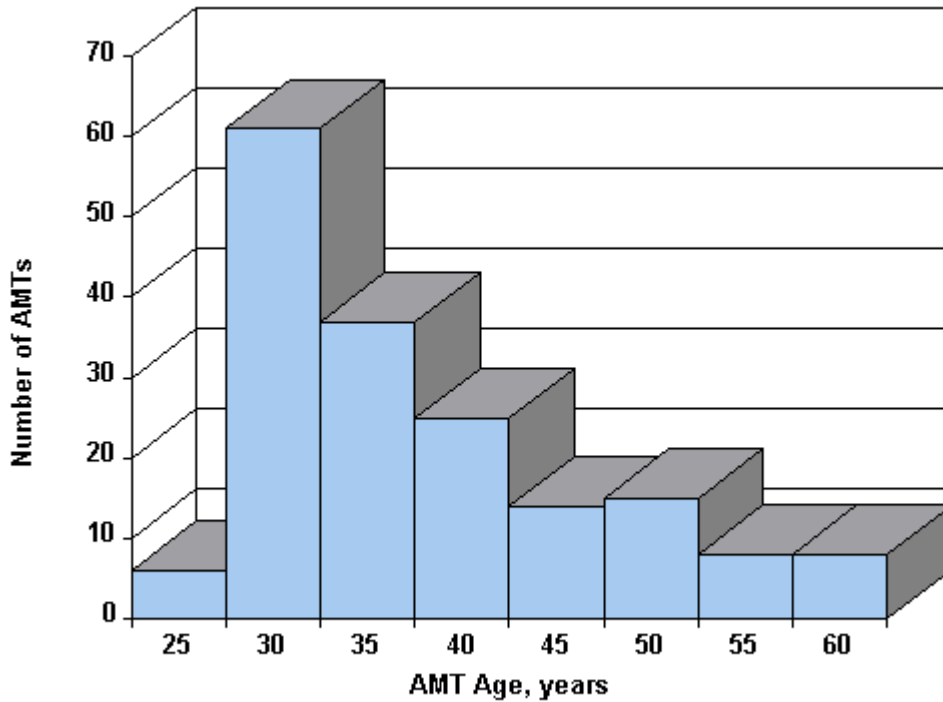
1. Simplified English, original layout
2. Simplified English, Patel, et al., (1994) layout
3. Non-Simplified English, original layout
4. Non-Simplified English, Patel, et al., (1994) layout

The four versions were critiqued by our Boeing, University of Washington colleagues and the AIAA Simplified English Committee members. Based on their feedback, minor corrections were made to ensure consistency between versions. **Appendix 1** shows a typical page of each of the four versions.

### **12.3.2 Choice of AMTs**

Following pre-tests in a Greater Buffalo International Airport facility to determine the adequacy of the methodology, contacts with airline partners allowed testing to take place at eight facilities of major air carriers. These carriers were chosen to represent the USA from east coast to west coast, from northern to southern states, including the midwestern region. All the AMTs who participated in the study were volunteers, and were assured of anonymity.

**Figure 12.1 Age Distribution of AMT Sample**



One hundred seventy-five licensed AMTs, all with Airframe and Power Plant licenses, from eight major air carrier maintenance sites were tested. The age distribution of this sample shown in **Figure 12.1** and the AMT experience distribution is shown in **Figure 12.2**. Mean age was 37.7 years, and mean experience 13.2 years. The data from our sample can be compared with demographic data on aircraft mechanics (in all branches of aviation) compiled for 1988 by the Bureau of Labor Statistics (BLS) (Wash, 1991). **Table 12.2** shows this data comparison. **Table 12.3** summarizes other characteristics of the AMT sample used in our study.

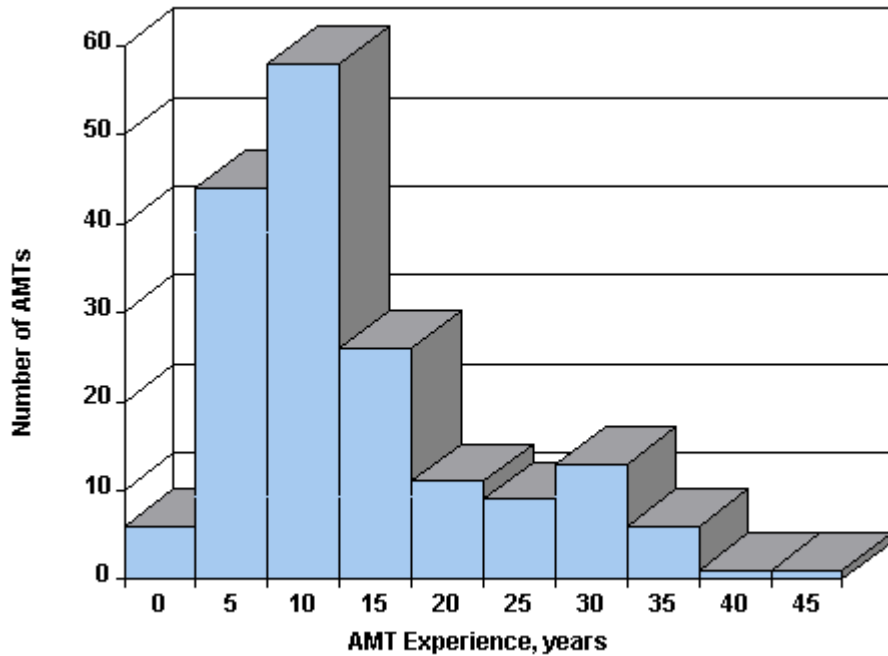
<b>Table 12.2 Comparison of Sample Age and Experience to 1988 Bureau of Labor Statistics Data</b>			
<b>Measure</b>	<b>Range, years</b>	<b>Percent All Av. Mtc</b>	<b>Percent Current AMT Sample</b>
Age	29	31.3	21.8
	30-49	50.7	63.8
	75	18.0	14.3
Experience	<3	22.9	4.6
	4-9	28.5	42.9
	10-19	16.2	32.6
	>20	32.5	20.0
		<b>All Av. Mtc</b>	<b>Current AMT</b>

	<b>Median</b>	<b>Sample Median</b>
Age	36.2	35.0
Experience	9.4	10.0

Wilcoxon tests of the median age in our sample shows that it was not significantly different from the BLS data ( $t = 7879$ ,  $p > 0.50$ ). For the experience distribution, the sample median was significantly greater than the BLS data ( $t = 10,142$ ,  $p < 0.001$ ), showing that the AMTs in our study were more experienced than the AMTs of the earlier data. In particular, there were far fewer AMTs with three years or less experience, a finding probably representing reduced hiring patterns in major airlines during the 1990s.

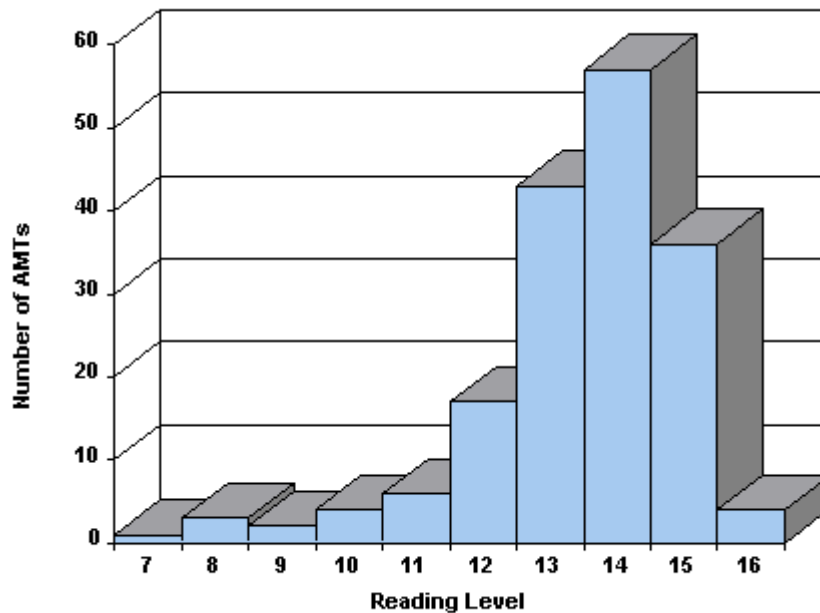
<b>Table 12.3 Characteristics of AMT Sample Used in Our Study</b>		
<b>Question</b>	<b>Answer</b>	<b>Percentage</b>
Type of Maintenance:	Line	12%
	Hangar	73%
	Shop	14%
	Other	2%
Native Language:	English	90%
	Other	10%
Worked in past two years on:	Boeing	87%
	McDonnell-Douglas	76%
	Airbus	22%
	Other	14%

**Figure 12.2 Experience Distribution of AMT Sample**



**Figure 12.3** shows the distribution of scores on a reading ability test, the Accuracy Level Test. Scores are equivalent to reading grade levels. Carver (1987) provides data for this test for two appropriate comparison groups: freshmen undergraduate and beginning graduate students. The mean score of our sample (13.35) was significantly higher than for college freshmen (12.5) with  $t(174) = 6.95$ ,  $p < 0.001$ . However, it was significantly lower than for graduate students (14.3) with  $t(174) = -7.85$ ,  $p < 0.001$ . Thus the reading level of our AMT sample was typical of an educated adult group, i.e., above college freshmen but below graduate students. The mean was less than one grade level different from either group, showing that while the differences may be significant, they are not large in absolute terms.

**Figure 12.3 Reading Level Results for AMT Sample**



### 12.3.3 Evaluation Procedure

All the testing took place at airline maintenance facilities, in whatever room was made available. AMTs were tested individually or in groups depending upon their arrival times. Each AMT was given written instructions for completing a demographic questionnaire, a reading comprehension test, the actual workcard comprehension task and a set of workcard rating scales.

Each AMT was given one of the sixteen possible workcards, i.e., four complexity levels each in four versions. Workcards were distributed in order, with a different starting point at each carrier. For the comprehension test, each AMT was given the workcard and a set of questions (20 each for three workcards, 19 for the other). Generally, a question concerning specific technical information was followed by a question asking where this information was located in the workcard. The questions demanded either a short answer, a "fill in the blank," or a multiple choice. Because the four workcards represented different procedures, there was no way to match the individual questions across workcards, i.e., ensure that the same questions were asked across all workcards.

Although there were four different versions of each workcard, there was only one version of the comprehension test to eliminate any bias in constructing or wording this test. Also, in some cases, different words were used in Simplified English and Non-Simplified English workcards to refer to the same object. In this case a neutral word with similar meaning was chosen in order to prevent bias. For example, in Simplified English, the term "Do-Not-Operate tag" was used to indicate a card that was placed on an inoperative control lever, whereas in the Non-Simplified English workcard the term "Do-Not-Operate identifier" was used. In this particular case, questions regarding these cards used the term "Do-Not-Operate marker."

The dependent variables measured were defined as follows:

1. Demographic Variables: Age, experience as AMT, experience with different aircraft types, native language.
2. Reading Comprehension: The Accuracy Level Test (Carver, 1987). This was a ten-minute timed vocabulary test that measured the reading level of the AMTs as an equivalent grade level. This test has high reliability (0.91) measured on college students (Carver, 1987) and has a high validity (0.77 to 0.84) when compared to a longer standard reading test (the Nelson-Denny Reading Test).
3. Workcard Comprehension: Accuracy score on comprehension test, called "Test Completion Accuracy" and calculated as the percentage of correct answers, combining accuracy of answers and accuracy of locating the answer in the workcard. Time taken to complete the reading of the workcard and the comprehension test, called "Test Completion Time" and measured with a stopwatch.
4. Rating Scales: Rating scale responses were based upon the evaluation scales used by Patel, et al., (1994), as shown in **Appendix 3**. They covered ease of use of the workcard and its graphics attachments, the simplicity of the English used and, finally, an overall rating of workcard usability. All were nine-point scales (0 to 8) anchored at each end with an appropriate adjective, and with their midpoints located at a scale value of 4.5.

### 12.3.4 Experimental Design

This was a three-factor factorial experimental design with AMTs nested under all three factors. The factors were:

Language at two levels:

Simplified English

Non-Simplified English

Layout at two levels:

Original layout

Patel, et al., (1994) layout

Workcard complexity at four levels:

Easy 1

Easy 2

Difficult 1

Difficult 2

## 12.4 RESULTS

All of the data from each subject was coded using the ACCESS(tm) program, and brought into MINITAB(tm) for statistical analysis. There were three main groups of variables:

1. Independent Variables:

Language

Layout

Workcard complexity

2. Dependent Variables:

Performance Measures on comprehension test:

Test completion time

Test completion accuracy

Ratings of workcard

rating scale results

3. Possible performance predictors or covariates:

Age

Experience as mechanics

Experience with different aircraft

Native language

Reading comprehension score

In this report, no distinction was made between scores on correctness of answers and correctness of location. Only a single score was derived, called test completion accuracy (or just "accuracy"). The first analyses presented here assess statistically the effects of the three independent variables on the two performance measures, using selected performance predictors as covariates. Subsidiary analyses explore the role of some of the covariates further, i.e., native language and experience with different aircraft. These analyses are followed by those of the effects of the independent variables on rating scale scores. All analyses used analysis of variance or covariance procedures, specifically the General Linear Models technique which allows for unequal sample sizes between conditions. Statistical significance is defined here as odds of greater than 1 in 20 against an effect having arisen by chance ( $p < 0.05$ ).

### 12.4.1 Performance Effects

For the analysis of the three major factors, a covariate was used to reduce the expected variability between individual AMTs. The four possible individual variables that may affect performance, and therefore could be useful covariates, were: AMT experience, inspection experience, age, and reading ability score. An intercorrelation matrix of these and the two

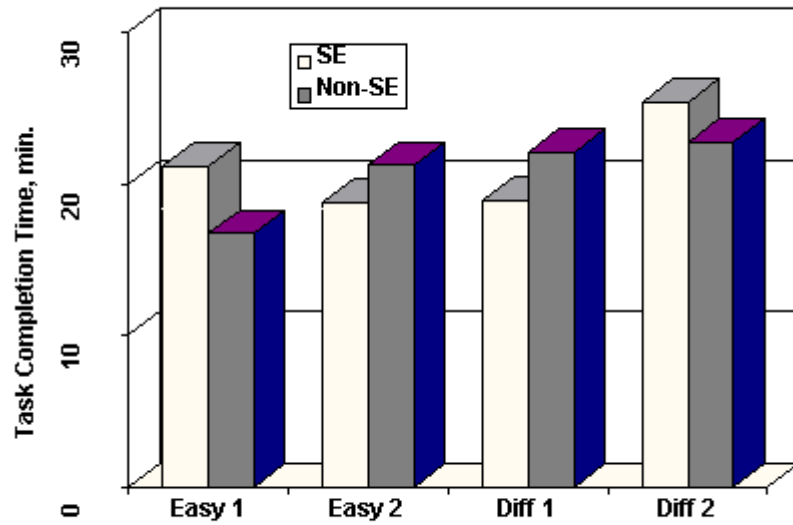


performance variables (time, accuracy) showed that inspection experience was uncorrelated with other variables and that AMT experience was highly correlated with age. The other two variables, age and reading ability, were moderately correlated with time and accuracy. Correlation coefficients were calculated as 0.217 between age and task completion time and -0.158 between age and task completion accuracy. Age and reading ability were tested, singly and together, as covariates, and gave almost identical results. Only the analyses using age as a covariate are presented here for simplicity.

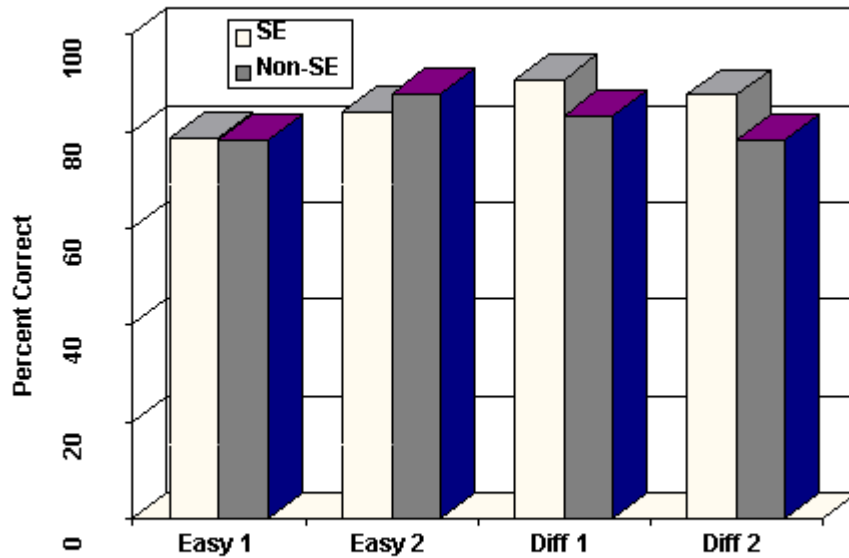
**Table 12.4** shows a summary of the significant effects for task completion time and task completion accuracy. The covariate (age) was significant in each case showing that times increased and accuracy decreased with increasing age. Both performance measures (time and accuracy) showed a significant workcard effect and a significant interaction between Simplified English/non-Simplified English and workcard, as shown in **Figures 12.4** and **12.5**. For times, **Figure 12.4** shows that each workcard had a somewhat different effect of Simplified English. Workcards Easy 1 and Difficult 2 gave slower performance times, and the others faster performance times. However, for accuracy (**Figure 12.5**) the effects were much clearer. For the two Easy workcards, there was no significant change in accuracy between Simplified English and non-Simplified English versions, but for the two Difficult workcards, Simplified English gave clearly superior accuracy.

<b>Table 12.4 Significance Levels For All Factors and i GLM ANOVA with Age as A Covariate.</b>		
<b>Factor</b>	<b>Performance Measure</b>	
	Task Completion Time	Task Completion Accuracy
Age (covariate)	p = .001	p = 0.006
Workcard (W)	p = .001	p = 0.004
SE/Non-SE (S)	not significant	not significant (p =0.073)
Layout (L)	not significant	not significant
W × S	p = 0.011	p = 0.024
W × L	not significant	not significant
S × L	not significant	not significant
W × S × L	not significant	not significant

**Figure 12.4 Effects of Workcard and Simplified English on Task Completion Time**



**Figure 12.5 Effects of Workcard and Simplified English on Task Completion Accuracy**



To determine whether the AMTs' experience on Boeing aircraft had an effect on their performance on the comprehension test, a factor of whether or not each AMT had worked on Boeing aircraft in the past two years was added to the ANCOVAs of time and accuracy. No main

effect or interaction with Boeing experience was found to be significant.

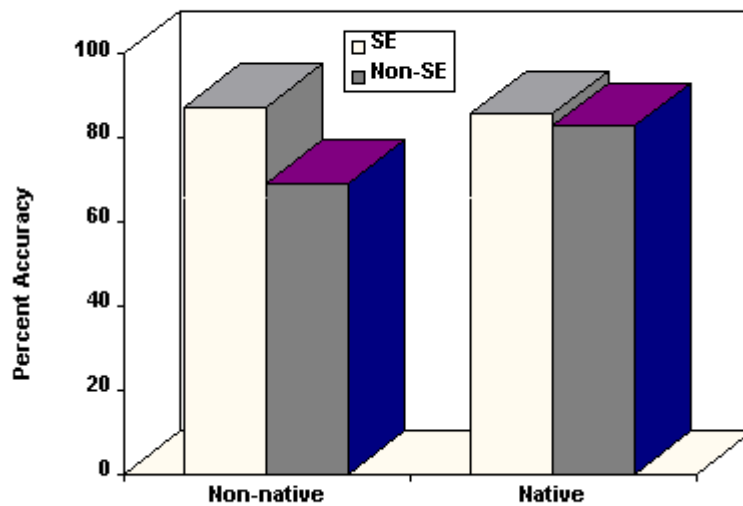
In the Shubert, et al., (in press) study it had been found that SE was of greatest benefit to non-English speakers, so that a similar test was appropriate in our study. Of the 175 AMTs tested, 157 were native English speakers and only 18 non-native English speakers. Because there was an even distribution of the 16 workcards to AMTs, nine non-native English speaking AMTs were given SE workcards and nine non-SE workcards. The number of non-native English speakers was too small for this characteristic to be used within the main ANCOVA, either as a covariate (Boeing experience), or as a fourth factor. Hence, a separate ANOVA was performed with only two variables, each at two levels:

Language of workcard: SE or non-SE  
 Native language: English or non-English

**Table 12.5** shows the significance of the main effects and their interaction for task completion time and task completion accuracy. Only the AMT's native language affected task completion time significantly. Native English speakers took an average of 20.5 min. while non-native English speakers took longer, an average of 24.7 min., to complete the comprehension test. Accuracy was different between the two types of English, between native and non-native English speakers, and for the interaction of these two factors. **Figure 12.6** shows all of these effects. There was a clear superiority for Simplified English, with accuracy increasing from 76% to 86% overall. Equally important is the finding that the effect was most marked for non-native English speakers, where the improvement in accuracy was from 69% to 87%. Indeed, Simplified English allowed non-native English speakers to achieve about the same level of performance as native English speakers. Performing multiple comparisons among the four means in **Figure 12.6** shows that only the differences between the lowest mean (non-SE/non-native English speakers) and the other three were significant at  $p = 0.05$ . Thus, the scores for both groups of native English speakers and the SE non-native English speakers were essentially the same, i.e., use of SE brought the non-native English speakers up to the same accuracy as native English speakers.

<b>Table 12.5 Significance Levels for SE/Non-SE and Native/Non-Native Language Effects.</b>		
<b>Factor</b>	<b>Performance Measure</b>	
	Task Completion Time	Task Completion Accuracy
Language of workcard	not significant	$p < 0.001$
Native language	$p = 0.010$	$p = 0.043$
Interaction	not significant	$p = 0.011$

**Figure 12.6 Percentage Accuracy for Native and Non-Native English Speakers with and without Simplified English**



## 12.4.2 Rating Scale Analyses

In the Patel, et al., (1994) study, the rating scales were used to compare new and old workcard layouts. For such a simple comparison, a non-parametric statistical test could be used. However, the current study had a more complex multi-factor experimental design so that analyses of variance or covariance were the only feasible statistical analyses. This meant that the rating scales had to be assumed to produce normally distributed responses. Histograms of the responses to each scale were plotted and no marked departures from normality noted.

In the rating scale data there were few significant effects noted in the ANCOVAs. **Table 12.6** shows the significance levels for the main effects; only a single interaction was significant. There were significant layout differences for six of the fifteen rating scales, all in favor of the original rather than the Patel, et al., (1994) layout. **Table 12.7** shows the mean ratings for these significant measures. Of the four ratings that gave significant workcard effects, **Table 12.8** shows that AMTs gave low ratings to the Difficult 2 workcard on the measures listed in the table. Amount of graphics information and simplicity of English used were both rated close to the center of the scale for all workcards. The single significant interaction was workcard  $\times$  SE/non-SE for the overall rating ( $p = 0.027$ ). Of the two Easy workcards, one had SE rated better than non-SE while the other was reversed. For the Difficult workcards, both had the SE version rated better overall. No clear pattern emerges from this significant interaction.

**Table 12.6 Significance Levels of Main Factors for Rating Scale Data**

Measure	Workcard	SE/Non-SE	Layout

1. Readability of text	not significant	not significant	not significant
2. Continuity of information flow	not significant	not significant	not significant
3. Ease of information location	not significant	not significant	p = 0.046
4. Chance of missing information	not significant	not significant	not significant
5. Ease of understanding	p = 0.002	not significant	not significant
6. Ease of location on aircraft	not significant	not significant	p = 0.024
7. Ease of relating figure numbers	not significant	not significant	p = 0.01
8. Amount of information provided	not significant	not significant	not significant
9. Ease of readability of attachments	p = 0.038	not significant	not significant
10. Relating graphics to aircraft structure	not significant	not significant	p = 0.016
11. Consistency of presentation	not significant	not significant	p = 0.012
12. Compatibility with attachments	not significant	not significant	p = 0.001
13. Amount of graphics provided	p = 0.001	not significant	not significant
14. Simplicity of English used	not significant	not significant	not significant
15. Overall ease of usability of w/c	not significant	not significant	not significant

**Table 12.7 Mean Ratings of Both Layouts for Significant Measures**

Measure	Original Layout	Patel, et al (1994) Layout
3. Ease of locating information	5.5	5.0
6. Ease of location on aircraft	6.1	5.6
7. Ease of relating figure numbers	5.9	5.3

8. Amount of information provided	5.9	4.7
10. Relating graphics to aircraft structure	5.7	5.2
11. Consistency of presentation	5.8	5.3
12. Compatibility with attachments	5.9	5.1

<b>Table 12.8 Mean ratings of workcards for significant measures.</b>				
<b>Measure</b>	<b>Easy 1</b>	<b>Easy 2</b>	<b>Difficult 1</b>	<b>Difficult 2</b>
5. Ease of understanding	5.8	5.6	5.8	4.7
9. Ease of readability of attachments	5.7	5.5	5.7	4.9
12. Compatibility with attachments	5.5	5.7	5.7	5.0
13. Amount of graphics provided	4.5	5.4	4.2	4.8
14. Simplicity of English used	5.1	5.3	4.8	4.8

## 12.5 DISCUSSION

This large and realistic study measured the effects of SE across a range of AMT backgrounds, types of workcard and workcard layouts. The aim was to determine whether SE helps (or hinders) comprehension of workcard information, and whether it does so uniformly or mainly in particular circumstances. In doing so, it was intended to confirm and extend existing comprehension studies, and to make sound recommendations on the use of SE by the aviation maintenance community.

The major result was that SE was indeed useful, having a positive effect on comprehension accuracy without any consistent negative effect on the speed of performance. On a representative sample of 175 practicing AMTs from sites across the USA, it was accuracy that was impacted by SE, showing that performance change with SE would be in the direction of error reduction. In this aspect, the current work mirrors that of Shubert, et al., (in press), where comprehension correctness and content location (accuracy measures) were also the affected outcome measures.

In terms of which factors interacted with the SE factor, again previous research was confirmed and extended. Both the native language of the AMT and the complexity of the workcard

interacted with the SE/Non-SE factor. As **Figure 12.6** showed, the effect of SE was to improve the accuracy by about 2% for native English speakers, but by about 18% for non-native English speakers. If we consider error rates, the inverse of accuracy rates, the results look even more dramatic, as shown in **Table 12.9**.

<b>Table 12.9 Error Rates Across Native Language for Simplified English and Non-Simplified English Workcards</b>		
<b>Speaker Type</b>	<b>Error Rates</b>	
	<b>Non-Simplified English</b>	<b>Simplified English</b>
Native English Speakers (157)	17%	15%
Non-Native English Speakers (18)	31%	13%
Whole Sample (175)	18%	14%

The conclusion is simple and direct: Simplified English workcards allowed non-native English speakers to achieve the same level of performance as native speakers: the non-Simplified English versions of the workcards did not.

An analogous effect was seen for the interaction between workcard complexity and Simplified English (**Figure 12.3**). The two Difficult workcards were the only ones where Simplified English made a significant difference. The data in **Table 12.10** shows the error rates for both workcards.

<b>Table 12.10 Error rates for Easy and Difficult Workcards for Simplified English and Non-Simplified English Conditions</b>		
<b>Workcard Complexity</b>	<b>Error Rates</b>	
	<b>Non-Simplified English</b>	<b>Simplified English</b>
Easy Workcards	17%	19%
Difficult Workcards	18%	11%

Here, for the easy workcards there was no difference between Simplified English and non-Simplified English, but for the difficult workcard the errors were reduced by a third, for all users (native and non-native English speakers).

Overall, Simplified English proved to have the most effect where the most effect was needed, that is, for those whose native language was not English and where the material was more difficult.

Because of our large and varied sample, this result is generalizable across a range of age and experience levels, and appears independent of the particular make of aircraft with which the AMT is familiar.

There were no effects of layout on performance. From the rating scale data, AMTs preferred the original workcard layout to one incorporating the Patel, et al., (1994) guidelines. This is contrary to the previous finding; however, in fairness it should be pointed out that the original workcards

in this study were much closer to meeting human factors guidelines than the originals in the Patel, et al., (1994) study. Here, all workcards used an easily readable typeface, laser printer output, high contrast, and good paper stock. Given these improvements, AMTs may have preferred to see workcards with a more familiar layout. Also, in the Patel, et al., (1994) study, the inspectors used both types of workcards to perform an actual task on the aircraft. Perhaps rating of layout after a short comprehension test cannot be expected to give the same results as rating after use on an aircraft.

## 12.6 CONCLUSIONS

Aircraft manufacturers and technical operations departments in airlines can use SE for workcards and be confident that it will improve comprehension accuracy.

The effectiveness of SE is greatest where it is most needed: for non-native English speakers and for difficult workcards. Under more favorable conditions, i.e., with native English speakers and easier workcards, SE will not adversely affect performance.

Workcard layout differences had no effect on comprehension.

## 12.7 ACKNOWLEDGEMENTS

The authors would like to acknowledge the active cooperation of many individuals and groups in this project. Special mention is made of Boeing (Heather Holmback, Rick Wojcik, Paul Montague), to the University of Washington (Jan Spyridakis, Serena Shubert) and the EICMA Committee (Kathleen Barthe).

## 12.8 REFERENCES

- AECMA Simplified English Standard (1995). *A Guide for the Preparation of Aircraft Maintenance Documentation in the International Aerospace Maintenance Language*, AECMA Document PSC-85-16598, Belgium: The European Association of Aerospace Industries.
- Bohr, E. (1978). Application of instructional design principles to nuclear power plant operating procedures manuals. In Easterby, R. and Zwaga, H. (Eds), *Information Design* (pp. 517-577). New York: John Wiley & Sons Ltd.
- Carver, R. P. (1987). *Technical Manual for the Accuracy Level Test*. REVTAC Publications, Inc.
- Edworthy, J., Hellier, E. and Stanton, N. (Eds) (1995). Editorial: Warnings in research and practice. *Ergonomics*, 38(11), 2145-2154.



- Klare, G. R. (1978). Readability and comprehension. In Easterby, R. and Zwaga, H. (Eds), *Information Design* (pp. 479-495). New York: John Wiley & Sons, Ltd.
- McLaughlin, G. H. (1966). Comparing styles of presenting technical information. *Ergonomics*, 9.1, 257-260.
- Ogden, C. K. (1932). *Basic English, A General Introduction with Rules and Grammar*. London: Paul Treber & Co., Ltd.
- Patel, S., Drury, C. G. and Lofgren, J. (1994). Design of workcards for aircraft inspection. *Applied Ergonomics* 1994, 25(5), 283-293.
- Shubert, S. K., Spyridakis, J. H., Holmback, H. K. and Coney, M. B. (in press). The comprehensibility of Simplified English in procedures. *Journal of Technical Communications*, in press.
- Wash, D. P. (1991). The changing workforce to the year 2000. In *Meeting Proceedings of the Fourth FAA Meeting on Human Factors Issues in Aircraft Maintenance and Inspection*, 25-42.

## 12.9 APPENDICES

### 12.9.1 Appendix 1 Examples of Simplified and Non-Simplified Workcards

Non-Simplified English Workcard (regular format)

STATION		<b>SUNYAIR N290</b>			SUNYAIR CARD NO. 29-002-01		
TAL NO.					MON		TASK CARD
DATE					AIRLINE CARD NO.		
SKILL	WORK AREA	RELATED TASK	INTERVAL	PHASE	REVISION		
AIRPL	CREW CABIN		5A	10505	B DEC 15/85		
TASK		FILE	STRUCTURE ILLUSTRATION REFERENCE		APPLICABILITY		
FUNCTIONAL		RESERVOIR PRESSURIZATION CHECK VALVE			AIRPLANE ALL	ENGINE ALL	
ZONES			ACCESS PANELS				
212			193HL 194ER				
MECH	RSP	FUNCTIONALLY CHECK HYDRAULIC SYSTEM L/R/C RESERVOIR PRESSURIZATION CHECK VALVE FOR PROPER OPERATION.				MFD ITEM NUMBER 29-11-30-5a	
		<p>1. <u>General</u></p> <p>A. This procedure contains a test of the check valves which retain air pressure in the hydraulic system reservoirs after pneumatic power is removed. This test applies to each main hydraulic system.</p> <p>B. The reservoir pressurization check valve is located in the reservoir manual depressurization valve installed on each system reservoir.</p> <p>2. <u>Referenced Procedures</u></p> <p>A. 06-41-00201, Fuselage Access Doors and Panels</p> <p>B. 24-22-00201, Electrical Power - Control</p> <p>C. 31-41-00201, EICAS</p> <p>D. 36-00-00201, Pneumatic Control</p> <p>3. <u>Equipment</u></p> <p>A. Air pressure gage - 0 to 100 psi range.</p> <p>B. Regulated source of clean dry air or nitrogen, 0 - 100psi maximum pressure.</p> <p>4. <u>Prepare for Test</u></p> <p>A. Provide electrical power (Ref 24-22-00).</p> <p>B. Check that the following circuit breakers on overhead panel P11 are closed.</p> <p style="margin-left: 40px;">(1) HYDRAULIC QTY CTR (11K19)</p> <p style="margin-left: 40px;">(2) HYDRAULIC QTY L (11K20)</p> <p style="margin-left: 40px;">(3) HYDRAULIC QTY R (11K21)</p>					
EFFECTIVITY ALL		FUNCTIONAL 29-11-30-5A	RESERVOIR PRESSURIZATION CHECK VALVE 29-002-01 PAGE 1 OF 4 DEC 15/85				



## Simplified English Workcard (regular format)

STATION		<b>SUNYAIR S290</b>			SURF AIR CARD NO. 23-002-01			
TAL NO.					<b>MON</b>		<b>TASK CARD</b>	
DATE								
SKILL	WORK AREA	RELATED TASK	INTERVAL	PHASE	REVISION			
AIRPL	CREW CABIN		1C	11212	H SEP 20/83			
TASK		TITLE		STRUCTURE/ILLUSTRATION/REFERENCE		APPLICABILITY		
FUNCTIONAL		RESERVOIR PRESSURIZATION CHECK VALVE				AIRPLANE ALL ENGINE ALL		
ZONES			ACCESS PANELS					
212			193HL 194ER					
MECH	RSP					MPO ITEM NUMBER		
		FUNCTIONALLY CHECK HYDRAULIC SYSTEM L/R/C RESERVOIR PRESSURIZATION CHECK VALVE FOR PROPER OPERATION.				29-11-30-5A		
		<p>1. <u>Reservoir Pressurization Check Valve Test</u></p> <p>A. General</p> <p>(1) This procedure does a test of the check valves which keep air pressure in the hydraulic system reservoirs after the pneumatic power is removed. This is a test of each main hydraulic system.</p> <p>(2) The check valve is in the manual depressurization valve on each system reservoir.</p> <p>B. Equipment</p> <p>(1) Air pressure gage - 0 to 100 psi range - commercially available</p> <p>(2) A source of clean, dry air or nitrogen, that is controlled from 0 to 100 psi maximum pressure - commercially available</p> <p>C. References</p> <p>(1) 06-41-00/201, Fuselage Access Doors and Panels</p> <p>(2) 24-22-00/201, Electrical Power - Control</p> <p>(3) 38-00-00/201, Pneumatic Control</p> <p>D. Procedure (Fig. 501)</p> <p>(1) Supply electrical power (Ref 24-22-00).</p>						
EFFECTIVITY		FUNCTIONAL	RESERVOIR PRESSURIZATION CHECK VALVE					
		23-11-30-5A	23-002-01 PAGE 1 OF 4 SEP 20/83					

**12.9.2 Appendix 2 Demographics Questions**

D #	
LOC #	
W/C #	
COLOR	

**Please answer the following questions about yourself to help us ensure we have a representative sample of Aircraft Maintenance Technicians (AMT's).**

1. What is your job title?
2. When did you obtain your Airframe and Powerplant (A & P) license?
3. How old are you?  years
4. How many years have you been an AMT?  years
5. **IF** you are, or have been, an inspector:  
How many years as an inspector?  years
6. What type of maintenance / inspection do you mainly perform?
  - Line
  - Hanger
  - Shop
  - Other  specify
7. List the types of aircraft you have worked on in the last 2 years:
 

8. Were you born in the USA? Yes 
  - No -  where?
9. Is your native language English?
  - Yes
  - No → 10. What is your native language?
11. How long have you spoken English?  years

12. Where did you learn English?

School  
Intensive course  
Self taught  
Other

13. What language do you speak best?

328: Thank you for your cooperation in our study of improving workcard design.

ID #	
LOC #	
W/C #	
COLOR	

12.9.3 Appendix 3 Rating Scales for Workcard

Please rate the workcard and its attachments you have just used on the following scales by placing a mark across the scale, thus: 0 1 2 3 4 5  
6 7 8

- 1. Readability of Workcard 0 1 2 3 4 5 6 7 8  
Terrible Excellent
- 2. Continuity of information flow 0 1 2 3 4 5 6 7 8  
Terrible Excellent
- 3. Ease of locating Information 0 1 2 3 4 5 6 7 8  
Very Difficult Very Easy
- 4. Chance of missing information 0 1 2 3 4 5 6 7 8  
Always Never
- 5. Ease of understanding content 0 1 2 3 4 5 6 7 8  
Very Difficult Very Easy
- 6. Ease of location on aircraft 0 1 2 3 4 5 6 7 8  
Very Difficult Very Easy
- 7. Ease of relating the Figure numbers 0 1 2 3 4 5 6 7 8  
Very Difficult Very Easy
- 8. Amount of information provided 0 1 2 3 4 5 6 7 8  
Too Little Too Much

9. Ease of readability of attachments      0   1   2   3   4   5   6   7   8  
**Terrible** **Excellent**
10. Relating graphics to aircraft structure      0   1   2   3   4   5   6   7   8  
**Very Difficult** **Very Easy**
11. Consistency of presentation      0   1   2   3   4   5   6   7   8  
**Terrible** **Excellent**
12. Compatibility with attachments      0   1   2   3   4   5   6   7   8  
**Terrible** **Excellent**
13. Amount of graphics provided      0   1   2   3   4   5   6   7   8  
**Too Little** **Too Much**
14. Simplicity of English used      0   1   2   3   4   5   6   7   8  
**Too Simple** **Too Complex**
15. Overall usability of workcard      0   1   2   3   4   5   6   7   8  
**Terrible** **Excellent**

# CHAPTER 13

## TRAINING AND CERTIFICATION IN THE AIRCRAFT MAINTENANCE INDUSTRY

*Ray Goldsby  
HKS & A Inc.*

### 13.1 EXECUTIVE SUMMARY

#### 13.1.1 Introduction

The regulatory review of Title 14 Code of Federal Regulations Part 65-Certification: Airmen Other Than Flight Crew Members is in the final stages. The process began in 1989 and was conducted by the Aviation Rulemaking Advisory Committees (ARAC) Part 65 Working Group. This group comprises representatives from the aviation industry including commercial operators, professional organizations, labor, and educational institutions. Their final recommendations, which resulted in the draft of a proposed new Part 66-Certification: Aviation Maintenance Technicians and Aviation Repair Specialists, were completed in December 1995.

Under the proposal, individual certification of some Aviation Repair Specialists (ARS-I) may be issued to a properly qualified person. A portable certificate may be issued directly to the individual by the FAA based on approved industry developed standards and proficiency in designated specialty areas. The certificate holder could then perform and certify in his/her specialty at an FAA approved maintenance organization.

The two phase research project undertaken for this study was an extension of the Part 65 review work accomplished for the FAA through the ARAC Process. Phase I was conducted in 1994 and focused on the need for an industry-directed, independent system. The objective of this Phase II study was to address the process for developing certification standards of aviation maintenance specialists. The study was conducted for the FAA as part of the Human Factors for Aviation Maintenance research program. This executive summary highlights our key findings and recommendations for an ARS-I training, qualification, and certification process.

#### 13.1.2 Background

There is ample evidence of an increasing worldwide demand for aircraft maintenance. This is because of two primary factors:

- An aging aircraft fleet



- Increasing size of the air transportation industry.

Airline and freight operators are keeping older aircraft in service longer, thereby increasing the need for heavy maintenance. At the same time, the demand for air travel is continuing to grow. Over the next two decades, the world air transport jet fleet is anticipated to double in size to accommodate the growth in airline passengers and freight.

While aircraft incorporating new technology contribute to more cost-effective operations, they also lead toward more complex maintenance procedures. When an operator uses a mix of old and new aircraft, the requirements to keep pace increase. When high technology components need analysis or repair, long-standing experience with airplanes may not be sufficient. Increased specialization will be needed as aircraft technical requirements continue to grow.

This need for increased specialization has led to a substantial growth in third-party maintenance providers. As the specialties require more sophisticated test equipment, it has become more cost-effective for many air carriers to outsource their maintenance activities rather than to perform certain specific tasks in-house. Moreover, third-party maintenance providers are increasingly supplementing their workforce with temporary personnel. Concern has arisen in the industry regarding the skill qualifications of some specialists.

### **13.1.3 Advanced Skill Specialists**

The ARAC-65 working group concluded that a new certification process needs to be developed for aviation repair/maintenance specialists. The group proposed to grant specific maintenance and repair privileges to individuals in three ARS classifications. The ARS-I classification is a new concept, ARS-II and ARS-III replace the current repairman certification. Chapter III provides detailed information on the proposed ARS process.

The ARAC-65 working group also proposed that ARS-I certification should be based on nationally and internationally recognized standards developed by the aviation maintenance industry. The working group selected four initial skill areas for the ARS-I certification. These specialty categories include:

- Aircraft electronics (avionics)
- Composite structural repair
- Nondestructive inspection
- Metal structures repair.

Other specialties may be added in response to industry needs once the certification process becomes established. One or more existing standards of technical organizations may be applicable to the proposed ARS-I specialty categories.

### **13.1.4 Industry Opinions and Preferences**

The project team conducted interviews and informal surveys with industry leaders to ascertain opinions and preferences about the implementation of an ARS-I certification system. In general, a majority of the individuals interviewed believed that the aims of improving professionalism, increasing productivity, and improving the quality of specialty maintenance work would be promoted by the FAA certificating specialists to established industry standards.

Not everyone in the industry, however, was in full agreement over specialist certification based on the ARS-I concept. Most of the concerns arose from the large airline group. These concerns focused on the potential for increased regulation and additional costs. Whether or not additional costs would occur remains to be seen. However, the FAA's economic analysis did not indicate increased costs to the industry. Given this fact, the project team still considered industry concerns and exercised considerable care in designing an approach to ARS-I certification that would minimize administrative requirements.

### **13.1.5 Global Regulatory Directions**

While the need for global harmonization is well recognized among aviation authorities worldwide, the processes required to achieve international maintenance standards are relatively long term. International authorities, such as the International Civil Aviation Organization, have been slow to up-date and implement regulatory changes in maintenance standards and practices. Considerable work and progress toward harmonization, however, has been accomplished by the United States and Canada. Transport Canada and the FAA have engaged in full participation in each other's rule making process at the advisory council level. In some cases, specialist qualification standards developed in Canada may be acceptable for certification in the United States (and vice versa).

#### **Other Industry Standards**

Examining the systems and processes developed by other industries for skill training, qualification, and certification provided useful information in formulating the ARS-I system. We reviewed two basic approaches to skill and knowledge certification: (1) government-imposed certification through rules and regulations and (2) industry self-imposed certification based on standards developed by nonprofit professional organizations.

Many highly critical specialties have rigorous training, certification, and recurrent certification requirements. The American Society for Nondestructive Testing (ASNT), and the combined Automotive Service Excellence (ASE) and National Automotive Technician Education Foundation (NATEF), for example, have developed comprehensive certification standards for their industry. Programs from these associations include the development of testing procedures, the accreditation of learning institutions, and the certification of individuals and organizations. These programs also provide guidelines to employers for quality assurance.

### **13.1.6 The AIMSAC Concept**

To establish standards and training curriculum guidelines for ARS-I skill categories, we propose that an aviation industry advisory council be created. For the purpose of this study, we have

named the organization, the Aviation Industry Maintenance Standards Advisory Council or AIMSAC. The primary function of AIMSAC would be to assure that various technical maintenance and inspection specialties have standards fostering high qualification of workers in the commercial air transport industry. As an industry oversight organization, AIMSAC would make recommendations to the FAA concerning the quality, suitability, and currency of skills standards. AIMSAC membership might consist of representatives from the FAA, air carriers, third-party maintenance organizations, and industry associations. It would be an industry-funded organization.

### 13.1.7 Recommended Action

We recommend that the FAA, AIMSAC, and technical organizations work closely together to establish an integrated ARS certification process. **Table 13.1** identifies the primary functions for each group.

We recommend the following action plan to establish AIMSAC and implement an ARS certification plan:

- The FAA should develop an Advisory Circular to establish the ARS-I certification process and to call for the formation of the umbrella organization, such as AIMSAC.
- An initial meeting should be called to discuss the possibility of forming this group and consider developing procedures for creating/evaluating professional organization standards. These procedures would then be distributed to candidate standard associations to initiate the process for evaluating each program.
- AIMSAC would evaluate the standards and curriculums submitted by technical associations for their appropriateness to the aviation maintenance industry. The development of a standardized curriculum would be an important part of the ARS-I process.
- Training providers, accredited by AIMSAC approved organizations, would conduct their training programs and complete the performance evaluations for candidates. The accredited training providers would be subject to oversight by the technical associations.
- The FAA may issue ARS-I certificates to individuals who have completed appropriate training and are qualified according to the approved industry standards.

The basic elements of an ARS-I certification system would need to be developed into an

operational process in the near future. Once the Part 66 **NPRM** activities have been concluded, and public comments addressed, steps to build the AIMSAC group and develop its required policies, terms of reference, operating guidelines, and procedures should begin. This will ensure that when the new rule becomes effective, there will be a viable system in place that reviews and approves industry standards for ARS-I certification.

<b>Table 13.1 Group Functions Of An Integrated ARS Certification Process</b>		
<b>FAA</b>	<b>AIMSAC</b>	<b>Professional Associations</b>
<ul style="list-style-type: none"> <li>• Accept AIMSAC recommended qualifications</li> </ul>	<ul style="list-style-type: none"> <li>• Identify organizations qualified to develop and monitor standards</li> </ul>	<ul style="list-style-type: none"> <li>• Analyze specialty elements</li> </ul>
<ul style="list-style-type: none"> <li>• Issue individual ARS-I certificates</li> </ul>	<ul style="list-style-type: none"> <li>• Identify new or potential future needs or qualification for other specialties</li> </ul>	<ul style="list-style-type: none"> <li>• Determine experience requirements</li> </ul>
<ul style="list-style-type: none"> <li>• Conduct regulatory surveillance applicable to ARS-I certificate holders</li> </ul>	<ul style="list-style-type: none"> <li>• Evaluate and approve industry standards for the ARS-I</li> </ul>	<ul style="list-style-type: none"> <li>• Establish training standard and core curriculum</li> </ul>
	<ul style="list-style-type: none"> <li>• Recommend FAA acceptance of qualified organization's programs</li> </ul>	<ul style="list-style-type: none"> <li>• Develop competency testing</li> </ul>
	<ul style="list-style-type: none"> <li>• Implement communication programs</li> </ul>	<ul style="list-style-type: none"> <li>• Conduct training provider accreditation</li> </ul>

## 13.2 INTRODUCTION

### 13.2.1 Overview

The aviation maintenance industry has changed significantly over the past decade. These changes occurred in three primary areas:

- New aircraft systems and materials technology
- Aircraft remaining in operation for longer periods, thus creating more demand for heavy maintenance

- An increasing shift of maintenance activities to third-party providers.

Technological advances are primarily in the application of digital electronics that integrate and monitor aircraft systems. Commercial aircraft now incorporate highly sophisticated electronic systems. These systems include airframe and powerplant and are integrated through digital electronics, controlled by on board computers and micro processors. They are housed in computer engineered damage tolerant design airframe structures. There is also an extensive use of advanced composite materials in airframe and engine construction. Corresponding advances have been made in built-in test equipment, special tools and shop repair processes, and nondestructive inspection (NDI) processes and equipment. Enhancements in learning and training technology has changed how technicians learn and are qualified to operate and maintain these advanced systems and equipment.

The useful life of aircraft continues beyond expectations. Due to the high replacement cost, operators are keeping older aircraft in service longer, thereby increasing the need for heavy maintenance. Some aircraft have been in service for more than 30 years and are expected to continue in operation beyond the year 2000. Given proper inspection and maintenance, current evaluations indicate aircraft can be safely flown almost indefinitely. Boeing estimates that there are more than 2,800 airplanes over 20 years old in the world fleet and more than 4,000 Stage 1 and Stage 2 airplanes with airlines. The increasing number of older aircraft in service has brought about changes in surveillance, inspection, and maintenance practices for the industry.

Historically, air carriers completed a majority of their line, routine and heavy maintenance work in-house. With increasing cost constraints, many airlines now find it more efficient and cost-effective to have major work accomplished by others. These third-party repair stations usually specialize in modifications, repairs, heavy maintenance checks (C check) and airframe overhaul (D check). As a result, some airlines have restructured their maintenance programs with respect to the amount of work completed internally as opposed to that performed by outside contractors. These changes effect the demand for and qualifications of aviation maintenance personnel.

While the industry continues to change, the rules and regulations pertaining to personnel responsible for aircraft maintenance have lagged behind current technology and industry trends. A complete regulatory review of the maintenance personnel certification requirements has not been completed since the recodification of the Civil Air Regulations into the Federal Aviation Regulations in 1962. No significant revisions have been made since then to Title 14 Code of Federal Regulations (CFR) Part 65-Certification: Airmen Other Than Flight Crew Members. Part 65 is the regulation that specified the certification requirements of maintenance personnel.

Recognizing these factors, the Federal Aviation Administration (FAA), together with the aviation industry, initiated action to review and modify the rules and regulations that determine training, qualification, and certification requirements of maintenance personnel. About two years after the project began, a Part 65 Working Group of the Aviation Rulemaking Advisory Committee (ARAC) was established to recommend rule changes with specific emphasis on the rule regulating mechanics, mechanics holding inspection authorizations, and repairmen.

The proposed recommendation from ARAC is expected to be submitted to the FAA in early

1996. The research undertaken for this study was an extension of the regulatory review work being accomplished through the ARAC process. The primary focus of this effort was on the new aviation repair specialist (ARS) certification that will be part of the revised Part 65.

### **13.2.2 Objectives**

The overall objective of this study was to address the processes for developing standards in the training, qualification, and certification of maintenance specialist personnel and to describe and recommend a system for implementing an industry-controlled advanced certification plan.

The first phase of this study, conducted in 1994, focused on the need for an industry-directed, independent system and provided input to the FAA on aviation maintenance personnel training. The implications of such a system and the potential for implementation of the system were analyzed. This study, Phase II, is an extension of the previous work and covers all pertinent issues related to the evolving training and certification systems and standards for the specialist category. The specific objectives of this Phase II study were:

- Describe, define and provide examples of advanced specialty qualifications
- Provide a rationale for a modified U.S. system for advanced training and qualification for specialists
- Examine advanced certification standards in Canada and other Joint Aviation Authorities (JAA) countries
- Describe specific topical areas of advanced training and qualification with "straw man" curricula content and instructional methods
- Develop a plan to create an industry advisory council whose purpose would be to advise the FAA on advanced training, qualification, and certification of some aviation repair specialists
- Recommend a standards approval process.

### **13.2.3 Methodology**

This project team worked closely with industry leaders in establishing the process for developing ARS training and qualification standards. It is essential that such a process meets both the current and the future needs of the FAA and the aviation maintenance industry. In developing guidelines for a modified qualification system, the project team analyzed a wide range of information compiled from published documents and personal interviews.

As a first step, the project team reviewed relevant information from studies, such as the Aviation Safety Action Plan, the Pilots and Aviation Maintenance Technicians Blue Ribbon Panel report, the Job Task Analysis of the Aviation Maintenance Technician report, the Human Resources in

the Canadian Aircraft Maintenance Industry study, and the current Part 65 ARAC draft proposal. These studies had examined the need for changes in the aviation maintenance personnel certification procedures and practices.

The project team also reviewed data on historical and projected U.S. aircraft fleet size and utilization. This review identified the major factors influencing the aviation maintenance industry. The supply and demand of the aviation maintenance workforce were also analyzed.

Data was compiled on qualification procedures and standards implemented by other industry and regulatory organizations. Examples of other qualification processes evaluated include: nondestructive testing specialists, automotive mechanics, electronic technicians, structural welders, nuclear power generator operators and maintainers, medical technologists, and emergency medical technicians. The project team reviewed and compared the Canadian and JAA processes for the qualification and certification of maintenance personnel. The differences and similarities to the U.S. system of aviation maintenance certification were identified to ascertain where direct application of other standards may be useful. In its evaluation of U.S. and international standards and systems, the team also considered the potential for harmonization.

The project team conducted approximately 100 telephone and in-person interviews with key individuals in government, industry, and professional associations who were knowledgeable on the issues related to specialist standards and certification. Their input provided insight into areas of agreement and disagreement with the concept of the ARS certification process and helped to validate the findings and recommendations of the ARAC 65 working group.

Based on the data analysis and interviews, the project team outlined the framework and objectives for an industry-directed advisory council to be created to provide advice to the FAA on training and certification procedures. Recommendations were then made for establishing such a council.

### **13.2.4 Report Structure**

Following this Introduction, the findings of the study are described in seven chapters. Chapter II provides an overview of the aircraft fleet size and utilization and examines aviation maintenance trends and labor force dynamics. The next chapter provides information on proposed changes by the ARAC 65 working group to rules and regulations governing aircraft maintenance personnel and discusses industry's response to these changes. Chapter IV reviews the directions other countries and international authorities have taken to develop maintenance personnel qualification and certification standards. The fifth chapter examines systems and processes used in other industries to develop and maintain certification standards. Chapter VI describes specialty categories proposed by the ARAC-65 working group and training programs for the ARS, and Chapter VII discusses the goals and objectives of an industry advisory council. The final chapter summarizes our recommendations and the actions needed to implement an industry oversight group.

## **13.3 BACKGROUND**

### **13.3.1 Industry Profile**

Aircraft fleet size, growth, and utilization directly influence the demand for maintenance activity and the number of manhours required to perform these services. In the early 1990s, worldwide economic recession caused airlines to delay new aircraft deliveries and implement stringent cost saving measures. These measures included restructuring of operations and optimizing maintenance processes and practices. As a consequence of these actions, industry-wide demand for maintenance personnel declined. The aviation industry has now moved into a recovery phase, and the demand for maintenance workers appears to be increasing.

This section provides information on world and U.S. fleet growth over the next 10 to 20 years and aircraft utilization by type. The impact of economic cycles on the overall supply and demand for aviation maintenance personnel and training programs is also described along with the near- and long-term demand projections for aviation maintenance technicians (AMTs).

Data on aircraft fleets and hours of operation vary considerably. We have reviewed statistical documents from several sources, such as the General Aviation Manufacturers Association (GAMA), the National Business Aircraft Association (NBAA), the Regional Aircraft Association (RAA), the Air Transport Association (ATA), the International Civil Aviation Organization (ICAO), and The Boeing Commercial Aircraft Company, to provide reasonable estimates of the size and utilization of the U.S. aircraft fleet. Data extrapolated from these sources provide the basis from which we can determine the amount of maintenance work and skill requirements in the aviation industry.

#### ***Aircraft Fleet Size***

In 1994, more than 300,000 aircraft were active in civilian use worldwide. These aircraft include large commercial air transports; regional and commuter aircraft; general aviation aircraft, such as corporate/business, government/utility, and private-use aircraft; and helicopters. Approximately 65% of the world's civil aircraft fleet is owned and operated in the U.S.

The vast majority of aircraft are in general aviation. The FAA estimates the U.S. general aviation fleet is approximately 176,000 aircraft, including piston, turboprop, turbojet rotorcraft, and experimental type aircraft. Approximately 50% of the general aviation fleet in the U.S. are piston-engined aircraft operated for personal use. Based on ICAO statistics, the general aviation fleet totals approximately 285,000 aircraft worldwide.

As a component of general aviation, the business aircraft fleet consists of approximately 16,000 turbine-powered aircraft worldwide, of which 10,100 aircraft are U.S. owned and operated. The U.S. business aircraft fleet includes some 5,300 jets and 4,800 turboprops.

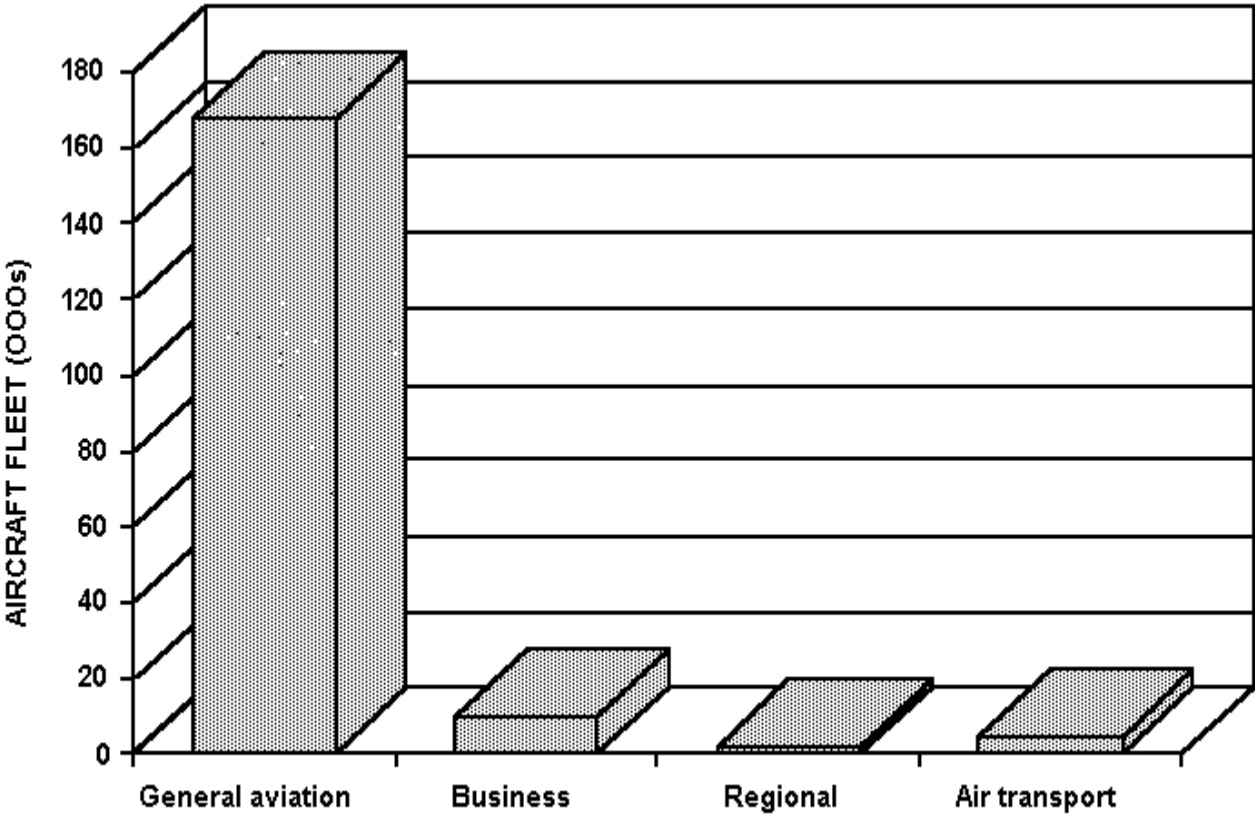
In 1994, the world fleet of large commercial air transports totaled 10,600 aircraft; approximately 4,400 of these aircraft were operated by U.S. air carriers. Dedicated all-cargo large jet freighters account for an additional 1,000 airplanes worldwide. The current inventory of regional aircraft exceeds 6,000 aircraft worldwide; in its 1995 annual report, the RAA estimates 2,170 aircraft are in scheduled service with U.S. regional carriers. The world helicopter fleet consists of some



19,000 helicopters, of which 40% are piston-engined and 60% turbine-powered.

**Figure 13.1** shows the number of aircraft by category in the U.S. fleet. Of the approximately 182,500 aircraft, general aviation accounts for 90%, business aviation, 6%; large commercial transports, 2%; and regional aircraft, 1%.

**Figure 13.1 U.S. Civil Aircraft Fleet**



Source: FAA, NBAA, RAA, Boeing, and HKS & A

The world air transport jet fleet will continue to expand in order to provide the necessary capacity to accommodate the growing number of commercial airline passengers. Over the next two decades, Boeing forecasts the large commercial transport fleet will grow world wide at an average annual rate of 3.4% through 2014, increasing in units from 10,600 aircraft to 20,680 aircraft, as shown in **Table 13.2**. The largest number of new aircraft added to the world fleet will be in the 121 to 170 seat category. The average number of seats per aircraft will increase from 193 seats in 1994 to 223 seats in 2014.

Table 13.2 Forecast For Commercial Air Transports Worldwide by Seat Size Category		
Seat Size	AAGR (%)*	
	1994-	1994-

Category	1994	1999	2004	2009	2014	2004	2014
50-90	586	828	1,273	1,497	1,626	8.1	5.2
91-120	2,501	2,247	2,288	2,534	2,731	0.9	0.4
121-170	3,799	4,374	5,092	5,840	6,627	3.0	2.8
171-240	1,408	1,707	2,216	2,889	3,649	4.6	4.9
241-350	1,285	1,427	1,577	1,797	2,108	2.1	2.5
>350	1,050	1,554	2,152	2,930	3,942	7.4	6.8
Total	10,629	12,137	14,598	17,487	20,683	3.2	3.4

The U.S. regional airline industry continues to experience growth that began with the airline industry deregulation more than 10 years ago. Code-sharing agreements play an essential role in the relationships of regional carriers with major carriers. As of June 1995, there were more than 40 code sharing agreements in existence, varying from complete ownership by the major carrier to marketing alliances. This practice of code-sharing will extend to other world markets with emerging regional airlines. Many of the regional airline carriers operate under their own management and organizational structure, independent of their partners. The U.S. regional aircraft fleet is projected to grow at 3.8% annually through 2004, as shown in **Table 13.3**. The forecast includes new generation aircraft up to 90-seat turboprops and jets. The fastest growing segments will be the 40 to 59 seat jets and the 60 to 90 seat turboprops.

<b>Table 13.3 Forecast For The U.S. Regional Aircraft Fleet</b>			
Aircraft Category	1994	2004	<b>AAGR (%)*</b> <b>1994-2004</b>
13-19 seat turboprops	820	680	-1.9
20-39 seat turboprops	667	1165	5.7
40-59 seat turboprops	183	366	7.2
40-59 seat jets	23	84	13.8
60-90 seat turboprops	57	221	14.5
60-90 seat jets	93	155	5.2
Total	1,843	2,671	3.8

The size of the U.S. general aviation fleet has been declining steadily since reaching its peak in 1979 when the production of piston-engined aircraft dropped dramatically from more than 16,000 shipments in 1979 to less than 1,000 in 1994. GAMA predicts that this slowdown will stabilize; the majority of future growth in this industry segment is attributed to business jets. **Table 13.4** presents the 10-year forecast for general aviation aircraft.

**Table 13.4 U.S. General Aviation Forecast**

Aircraft Category	1994	2004	AAGR (%)* 1994-2004
Single-engine piston	128,100	122,400	-0.5
Multi-engine piston	16,200	15,900	-0.2
Turboprop	4,500	5,700	2.4
Turbojets	4,000	5,200	2.7
Rotorcraft	4,600	5,500	1.8
Experimental	5,300	6,300	1.7
Other	11,100	13,000	1.6
Total	173,800	174,000	0.0

### **Aircraft Utilization**

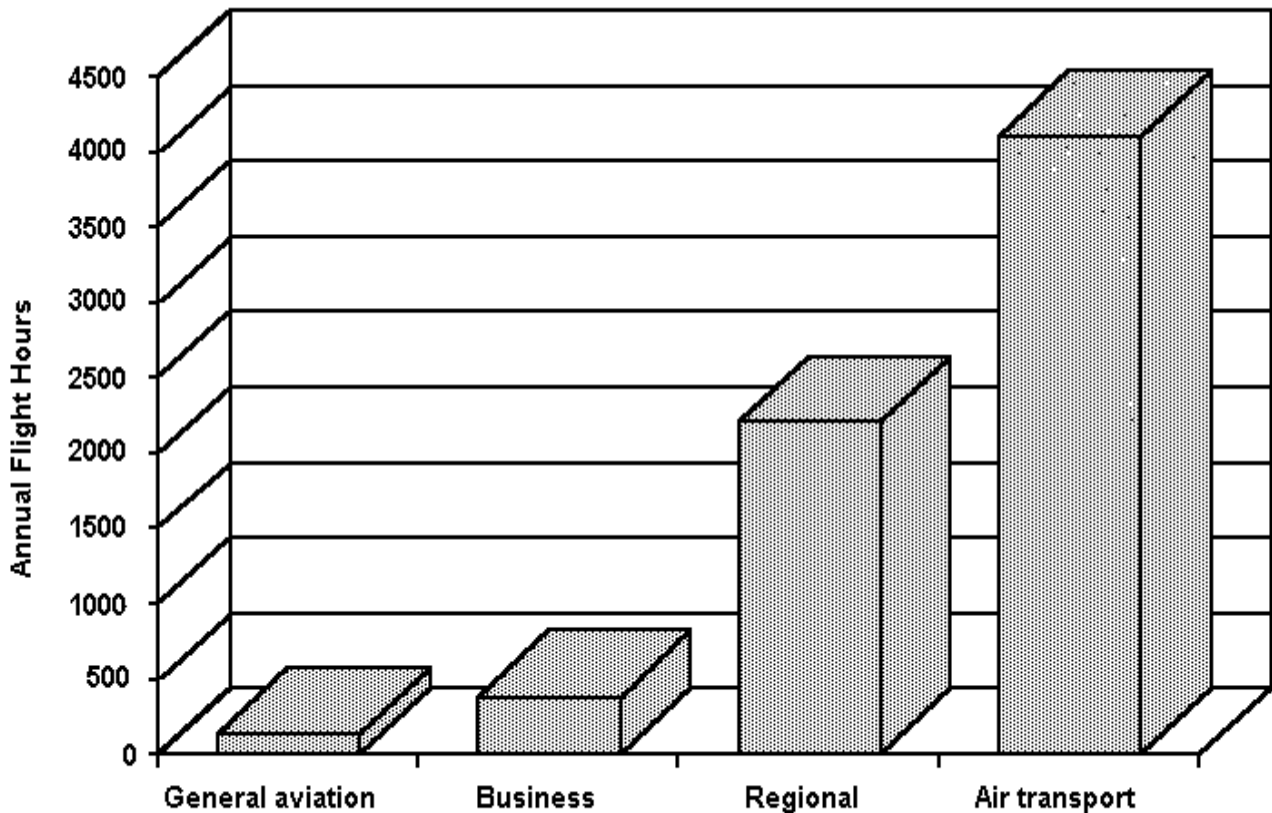
Hours of operation and cycles flown are among the primary determinants of aircraft maintenance activity. As expected, commercial air transports account for the highest number of hours flown annually. For the top 20 U.S. commercial air carriers operating approximately 4,200 aircraft, the average annual utilization per aircraft in 1994 was 3,485 hours. As an airplane ages, its utilization decreases; Boeing data indicates the average daily utilization for Stage 3 noise level aircraft in 1992 was 10 hours compared with 7 hours for Stage 2 noise level aircraft. A contributing factor to lower utilization of older aircraft is the increased amount of downtime for scheduled and unscheduled maintenance.

For regional aircraft, the average annual utilization per aircraft in 1994 was 2,102 hours, a 3.4% increase over the previous year. Since 1984, average hours flown per aircraft have steadily increased, averaging a 2.9% growth per year.

The average hours flown by general aviation aircraft are difficult to estimate due to the wide variety of operator uses. According to GAMA, the average annual flight time per aircraft for all general aviation aircraft was 138 hours. For business aircraft, utilization is considerably higher; NBAA reports the average utilization for its members is 435 hours for business jets, 411 hours for turboprops, 326 hours for piston aircraft, and 278 hours for helicopters. Excluding helicopters, the average is about 390 hours per year.

**Figure 13.2** shows the average annual utilization for large commercial transports, commuters, business aircraft, and general aviation. By aircraft type, the hours of operation are just the reverse of fleet size. Commercial air transport operations account for the highest utilization hours and the majority of required maintenance activity.

**Figure 13.2 Annual Average Utilization Hours, 1994**



Source: GAMA, NBAA, RAA, and ATA

Although aircraft hours of operation are substantially higher in the U.S. than in any other world region, international operations of commercial air transport and business aircraft are increasing. Growth in international activity reinforces the need to harmonize aircraft regulation to ensure safe operations in and out of U.S. airports. Some non U.S. international carriers are, in fact, not permitted to land at U.S. airports because their maintenance and operational skills do not meet FAA regulatory requirements and are considered unacceptable by the U.S. Department of Transportation (DOT).

While there are more general aviation aircraft, the utilization of aircraft is higher for commercial air transports. The amount of maintenance personnel, therefore, is significantly higher on air transport categories, excluding the obvious differences in aircraft size, because most maintenance is driven by utilization. With the growth forecast for large commercial fleets and the expansion of the regional airline industry, we can expect growing demand for maintenance workers. As this report describes, the technology in new aircraft simultaneously makes them more reliable and more complex. There probably will not be an increase in demand for AMTs and ARSs at the same ratio experienced today, but the increase will still be significant.

### 13.3.2 Aviation Maintenance Trends

Traditionally, U.S. independent certified repair stations provided only specialty conversion,

maintenance, or modification services to small carriers operating older or corporate/commuter aircraft. However, in the early 1990s the trend was for the major airlines to withdraw from performing maintenance on other fleets to concentrate on their own growing fleets. This resulted in substantial growth among the independent third-party maintenance providers. These companies filled the gap left by the major air carriers by moving into heavy maintenance of larger aircraft, as well as supplying comprehensive engineering/maintenance packages.

Recently some of the major carriers have reversed their position by either returning to or placing greater focus on their own third-party maintenance business. While the extent to which these carriers will dedicate staff and facilities to third-party work is unclear, reductions in the amount of work they send out is anticipated.

The top nine air transport carriers in 1994 outsourced an average of 27% of their maintenance expenditure. Outsourcing to third-party maintenance is one way for airlines to meet demand, particularly in the heavy maintenance requirements for older aircraft, while keeping capital expenditures low. We anticipate an increasing use of third-party maintenance as airlines continue to seek ways to reduce costs. For example, a Phoenix based carrier recently outsourced a majority of its heavy aircraft maintenance work to a third-party provider and reduced its maintenance personnel by 50%. For regional airlines without in-house maintenance capabilities, third-party maintenance providers may perform all heavy maintenance work.

A recent development at third-party repair stations relates to the contracting of temporary workers from manpower agencies (fourth-party) who specialize in providing aviation maintenance personnel. These agencies supply both certificated and noncertificated personnel for workload peaks or specific contracts. On the basis of interviews with industry representatives, an estimated 16 agencies in the U.S. currently supply up to 4,000 workers. This workforce consists of approximately 65% airframe and powerplant (A&P) certified mechanics and 35% structures specialists who hold no certification. The placement of contract workers tends to be seasonal, and depending on need, the number employed through manpower agencies ranges from 2,500 to 4,000 workers at any given time. All indications point to a growing demand for such fourth-party maintenance services. Industry-wide, the ratio of FAA certificated to non-certificated maintenance personnel is reduced as a result of the fourth-party trend.

The number of aircraft owned by leasing companies has dramatically increased. These aircraft move frequently between operators. Many of these aircraft are relocated internationally, thereby increasing the demand for foreign-certified repair stations and maintenance work performed offshore.

Technician certification in the repair station environment differs widely between regional and air transport maintenance organizations. In the Part 121 and Part 135 environment, the majority of workers are A&Ps or FAA certificated repairmen. In the Part 145 repair station environment, however, fewer workers are certificated with estimates ranging from 35% to 50% holding no certificate of any type. Based on recent studies by both government and industry, there is increasing evidence that the training, qualification, and certification in certain aviation maintenance skill areas is insufficient to meet future airworthiness needs. The low number of certificated persons indicates a greater focus needs to be made on standards.

An important and positive trend in the maintenance industry results from the team approach

taken by airframe and engine manufacturers, component suppliers, airline operators, maintenance personnel, and the FAA in new aircraft development from initial design phase to service entry. These partnerships can result in improved aircraft maintainability and reliability plus enhanced daily operational performance, as demonstrated by the Boeing 777 program.

### **13.3.3 Aviation Maintenance Workforce**

#### **Generalist and Specialist Categories**

Aviation operators need both generalists and specialists to maintain the full range of airframe, powerplant, systems, appliances, components, and parts repair tasks required to assure airworthiness.

Generalists are mechanics holding FAA A&P certificates (referred to in proposed Part 66 as AMT certificates) who work primarily on aircraft in maintenance hangars and line operations and who have the regulatory authority to return entire aircraft to service. Their signature verifies that an aircraft has been maintained and inspected in accordance with the required maintenance specifications. This task must be done by one who understands the maintenance requirements, the applicable FAA regulations, and is also familiar with the aircraft manufacturer's specifications. The AMT certificate training process prepares individuals to understand what they are qualified to do and to assure that the aircraft meets regulatory and airworthiness requirements. AMTs are also qualified to evaluate and approve the work of others.

Specialists, some whom hold repairman certificates, work in FAA certificated repair stations and airline maintenance facilities. They are not required to possess individual FAA certification and can only sign for completion of tasks for which they are qualified. Specialists possess knowledge and skill in specific disciplines. Their tasks are narrowly focused, may require special tooling and equipment, and may require continual practice to remain proficient.

In recent years, the differences between a generalist and specialist has widened with changes in technology and the aviation business climate. For example, an AMT checking an aircraft for release may accomplish troubleshooting using sophisticated onboard maintenance systems. These systems, when skillfully used, can direct the AMT to remove and replace line replaceable units or even a specific circuit board to correct a fault. AMT's possess competency in using proper procedures to remove and replace faulty units and circuit boards, but they may not have the equipment or knowledge to accomplish repairs on these individual units. The components are sent to shops where specialists repair them. This is where the specialist is important. Increasing complexity of aircraft systems makes it impossible for a single individual to have expertise in all areas of aircraft maintenance. As the need for specialized knowledge increases, it is not cost-effective to maintain the necessary equipment or personnel having particular specialized skills at all locations.

Special repair shops are located in large airline maintenance bases or at third-party repair stations. These facilities do not rely on AMT generalist skills, but rather use different specialists, depending on workload and shop specialization. To maximize utilization of personnel and equipment, these facilities often specialize in certain types of repair work, such as avionics, composite repair, airframe modification and overhaul, engine heavy maintenance, or component

refurbishment.

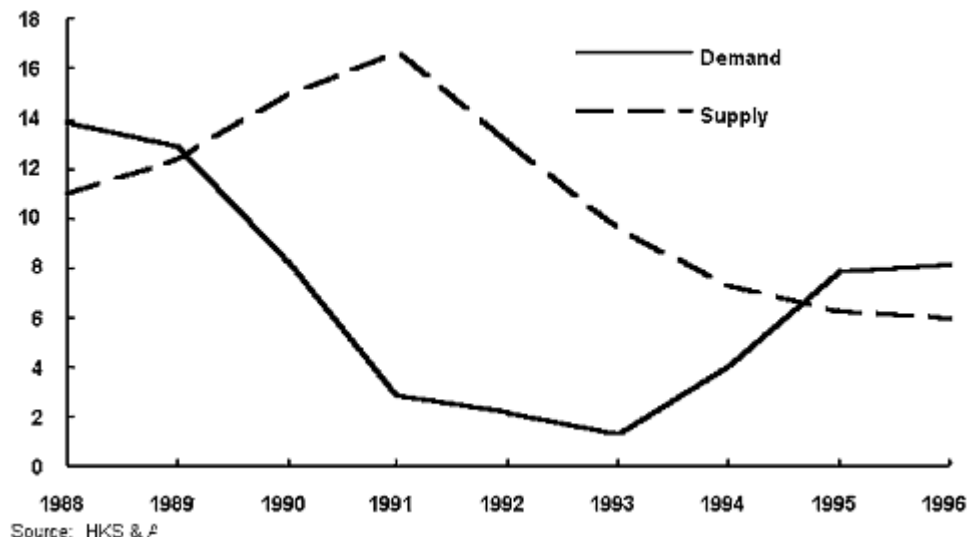
Presently, organizations holding a Part 145 Repair Station, Part 121, or Part 135 certificate can qualify their staff to complete maintenance tasks under the station's certification. Collectively, these organizations are informally referred to as approved maintenance organizations, or AMOs. Although qualified in an AMO, the specialist is not required to hold an individual certificate based on a national standard. There may be a degree of uniformity lacking for certain standards if individual specialists are performing maintenance and inspection on modern airframes, powerplants, aircraft systems, and components.

### Labor Supply and Demand

Historically, the supply and demand for qualified aviation maintenance personnel has experienced cyclical fluctuations. At least five cycles over the past 50 years can be identified whereby a rapid increase in demand for aviation maintenance personnel has occurred, followed by a short-term plateau, and then a significant decrease.

As the training cycle for AMT certification ranges from 15 months to 2 years, a corresponding lag exists in satisfying increased demand because of the time required in training individuals. The inverse is true, as well; as demand declines, a surplus of trained technicians emerges. **Figure 13.3** illustrates the supply and demand patterns for maintenance technicians since 1988.

**Figure 13.3 Supply And Demand For Aviation Maintenance Personnel**



During the current cycle and at peak demand for AMTs in late 1988, a shortage of technicians existed. One major airline, for example, hired more than 6,000 A&P mechanics between mid-1988 and late 1990. The pool of workers that had been affected by earlier reductions was exhausted, and strong competition existed for maintenance professionals who could meet minimum qualifications.

During this same period, Part 147 certified AMT schools reached capacity levels with 24,000 students enrolled in 1989 and nearly 27,000 students enrolled in 1991. By the end of the year in 1991, AMT schools produced as many as 11,700 graduates.



A severe economic downturn in the industry began in late 1990 lasting through 1994. As a result, AMT demand dropped dramatically from 1990 to 1993. Total school graduates dropped by 50% to 5,850 in the 1994 to 1995 period. **Table 13.5** shows enrollment versus number of graduates from AMT programs between 1989 and 1995.

<b>Table 13.5 Enrollment And Graduates at Amt Schools</b>				
	<b>1989</b>	<b>1990</b>	<b>1991</b>	<b>1994-95</b>
Enrollment	23,464	25,449	26,850	13,425
Graduates	9,542	10,536	11,682	5,846
*Estimate based on phone survey of ATEC members, 2nd quarter 1995. Source: ATEC				

The industry now appears to be in a moderate recovery, and airlines announced record profits in the 3rd quarter of 1995. Industry observers believe that demand for AMTs has reached its lowest point and is on the rise once again. A few AMT schools have reported higher placement numbers beginning in early 1995.

The current cycle had a significant impact on the AMT labor pool. Not only did AMT demand drop to very low levels, but many vocational schools eliminated AMT training programs altogether. According to the Aviation Technician Education Council (ATEC), the number of AMT schools declined to 193 in 1994 from 213 schools in 1991/1992. During the past year, they estimate another 10 programs were discontinued, bringing the total to at least 30 fewer schools in operation than in the early 1990s.

Moreover, other industries draw from the available pool of technically skilled people. Due to the low demand in aviation, many AMT graduates were hired into other industries, such as automotive and electronics manufacturing. Approximately 70% of students from certified AMT schools actually enter the field within one year of graduation, according to ATEC officials. This percentage rapidly diminishes after the first year. Future Aviation Professionals of America (FAPA) estimates that 50% of students become employed in aviation maintenance after one year from graduation and only 20% after two years. Professionals associated with AMT job placements doubt if many of these graduates who entered other fields will return to aviation maintenance, despite the growing demand.

Nationwide, we see a steady decline in quality vocational-technical programs in educational systems. Unless vocational-technical education experiences a resurgence, competition for AMT school graduates from other industries will continue. Moreover, the traditional supply of trained technicians from the military is diminishing as a result of cutbacks in the defense budget. On the positive side, industry standards for the training, qualification, and certification of specialists, would provide incentives for new programs with a focused course of study, particularly in proprietary schools.



## **Future Requirements**

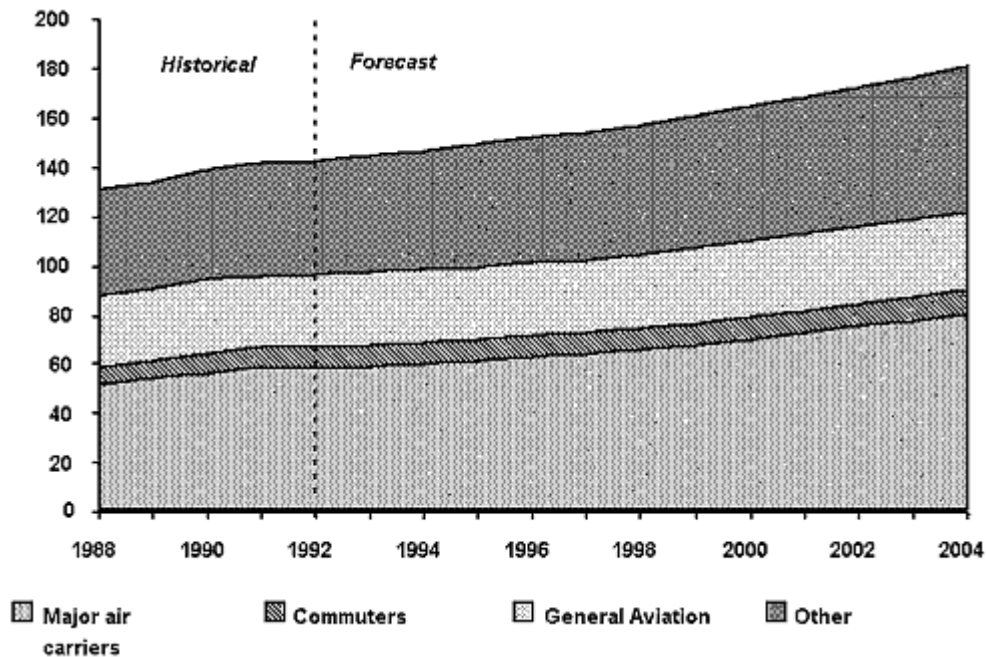
The Blue Ribbon Panel, an advisory council to the FAA, examined the anticipated supply and demand of pilots and AMTs for the next 20 years. In their 1993 report, *Pilots and Aviation Maintenance Technicians for the Twenty-First Century*, the committee provided estimates for near- and long-term AMT needs for the industry based on 1991 and 1992 industry factors and the FAA's annual forecast of aircraft fleet size.

The AMT forecast was developed for three aircraft operating groups: major air carriers, commuter air carriers, and general aviation. The number of AMTs required was calculated by first determining the number of technicians required to service an aircraft and then multiplying the factor by the number of aircraft in the fleet for each of the three aircraft groups. A fourth category of AMTs was included to account for federal technicians and technicians employed by manufacturers and repair stations. The following assumptions were used in the forecast:

- Major air carriers-14 technicians per aircraft
- Regional air carriers-4 technicians per aircraft
- General aviation-0.15 technicians per aircraft
- AMT new-hires is equal to AMT growth over the previous year plus an attrition factor (5% for major air carriers and 10% for commuters and general aviation).

Fleet size was derived from the FAA forecast. Results of the analysis indicate that approximately 170,900 AMT new-hires will be needed to satisfy aircraft demand between 1993 and 2004. This is an average of 14,240 workers per year. The total AMT demand in 1993 was 145,060 technicians compared with a projected 180,848 technicians in 2004. **Figure 13.4** shows the projected AMT demand, by aircraft category, to the year 2004. Major air carriers account for 44% of the AMT demand in 2004; regional air carriers, 5%; general aviation, 18%, and other categories, 33%. Details of the forecast are presented in **13.11.1 Appendix A**.

**Figure 13.4 Projected Amt Demand**



Source: Pilot and Aviation Maintenance Technician Blue Ribbon Panel Report, 1993

The AMT forecast is based on a linear growth and does not account for demand peaks and valleys. However, even if these projections are somewhat optimistic, a shortage of AMTs is likely if the emerging supply constraints are not quickly remedied. Several schools contacted in the recent ATEC survey indicated that current job offerings for students are going unfilled.

While the general consensus of Panel members is that a sufficient number of aviation maintenance workers exist to meet industry demand, a shortfall in qualified workers will occur. Moreover, current training programs may not adequately address industry needs. In the Executive Summary of the Blue Ribbon Panel Report, the committee states that:

*"The majority of new-hire AMTs come from FAA-certificated AMT schools, where they have received 15 to 18 months of structured training in a variety of technical subjects. Although the FAA recently revised the curriculum requirements for these schools, the new curriculum remains broad-based to fit a variety of technical disciplines, and it may not give AMTs the skills and competencies needed to maintain the increasingly sophisticated transport category aircraft. Therefore, new-hire AMTs working on newer aircraft will have to master skills that many AMT schools do not offer, if they are to become productive members of air transportation teams."*

*"A decreasing supply of qualified AMT's, combined with increasing skill and experience requirements, will yield a deficit not in the number of minimally qualified individuals but in the number with the necessary skills and*

*experience. This gap will have to be bridged by additional focused and specialized training. Europe and Asia are effectively addressing future skills shortages and becoming stronger competitors, causing dramatic increases in the amount of U.S. work done in foreign repair stations."*

A key point in the above statement of the Blue Ribbon Panel is that the gap in qualified AMTs will have to be bridged by additional focused and specialized training. The concept of ARS-I certification, based upon specifically focused skills standards, is a viable solution to addressing this problem.

## 13.4 U.S. REGULATORY ENVIRONMENT

The present maintenance regulatory system was not designed for rapid change. Changes due to new technology and the dynamics of the global business environment make it difficult for the rules regulating training, qualification, and certification to keep pace. Consequently, the FAA, in cooperation with the aviation maintenance industry, is exploring ways to restructure the regulatory process in the training, qualification, and certification of advanced skills (specialties). Methods are being sought to allow a more responsive regulatory system which will at the same time accommodate international harmonization.

This section reviews the FAA's effort to revise and update regulations pertaining to the training and certification of aircraft maintenance personnel and examines the industry's response to proposed rule changes. Relevant information from other studies, such as the Blue Ribbon Panel report, an informal Part 145 repair station survey, and Northwestern University's AMT Job Task Analysis (JTA) study is included.

### 13.4.1 Aviation Rulemaking Advisory Committee Process

#### Background

In 1989, a joint industry/FAA Part 65 review group was formed to evaluate and review certification requirements for mechanics and repairmen. The review group's primary purpose was to develop and present a unified position on recommended changes to Part 65, the regulation that governs the certification requirements of aviation maintenance personnel. The group, composed of representatives from several aviation associations, was chaired by the Professional Aviation Maintenance Association (PAMA). FAA interests were represented by the Aircraft Maintenance Division (AFS-300) of the FAA.

After conducting a series of panel discussions throughout the United States, the group published the *Industry/FAA Part 65 Review Group Working Paper* in January 1991. The paper highlighted the issues on which there was a general agreement and also identified those issues that the group believed would require further discussion.

During 1991, the FAA conducted both a historical review of Part 65, Subparts D and E and a survey of FAA regional offices on the certification of mechanics and repairmen. Results of the

review and survey showed support for a full evaluation and update of Part 65.

The ARAC was formally established in 1991 to assist the FAA in the rulemaking process by providing input from outside the federal government on major regulatory issues affecting aviation safety. The ARAC includes representatives from air carriers, manufacturers, general aviation, labor groups, academia, associations, airline passenger groups, and the general public. The formation of the ARAC gave the FAA an opportunity to solicit information directly from all elements of the industry.

There are several working groups organized under ARAC that meet to perform the task of reviewing and developing recommendations for revisions and changes to various CFR Parts. To ensure basic agreement on all aspects of their recommendations, the groups work under guidelines that require basic consensus before recommendations are released for further review and approval. One such group is the ARAC Working Group for Part 65 (ARAC-65).

In 1991, the joint industry/FAA Part 65 review group became the ARAC-65 working group. This working group is responsible for regulatory review and for recommending changes to Part 65 with specific emphasis on the portion regulating mechanics, mechanics holding inspection authorizations, and repairmen. Their efforts have yielded significant changes and modifications to Part 65 which are scheduled to be released as part of the Notice of Proposed Rulemaking (NPRM) in early 1996.

### **Proposed Rule Changes**

Substantive rule changes have been proposed to Part 65. They include the following revisions:

- Establish a separate CFR 14 part entitled, Certification: Aviation Maintenance Technicians and Aviation Repair Specialists, as Part 66 and remove Subparts D (mechanics) and E (repairmen) from the current Part 65
- Change the title airframe and powerplant mechanic to aviation maintenance technician (AMT), and the repairman designation is changed to three levels of aviation repair specialist (ARS)
- Establish AMT and aviation maintenance technician transport AMT(T) certificates
- Consolidate the current airframe and powerplant ratings into a single aircraft rating
- Establish an ARS-I certificate that may be issued independent of employment and based on meeting national standards, change the current repairman certificate to ARS-II, and issue the current repairman certificate granted to amateur aircraft builders as ARS-III
- Establish an aviation maintenance instructor rating for Part 147 schools
- Provide recurrent (refresher or requalification) training for AMTs who do not receive training from Part 121, 127, 135, and 145 operators or U.S. certificated repair

stations

- Provide for the registration (re-registration) of AMT and AMT(T) certificate holders
- Determine inspection authorization privileges based on the type of certificate held
- Require applicants for the inspection authorization to successfully complete an inspection authorization refresher course prior to certification
- Extend the duration of an inspection authorization from 1 year to 2 years
- Establish procedures for the FAA approval of AMT(T) training providers
- Provide for authorizations of certain aviation maintenance technician schools to test applicants for AMT and AMT(T) certification
- Establish a waiver procedure for the administrator to grant certificates to applicants who have not met certain English-language requirements of Part 66.

The proposed revisions by ARAC-65 are a result of extensive study and evaluation. Key objectives of the committee were to address the significant changes in the industry since the last revision and to develop rules that could meet future industry requirements. A consensus by working group participants was gained on virtually all elements of the revised rule.

If the rule making process remains on schedule, the new rule (consolidated as Part 66) will become effective by mid-1998. Since the first review in 1989, the process to evaluate and implement aviation regulatory changes will take approximately 9 years.

### **13.4.2 Advanced and Special Certification**

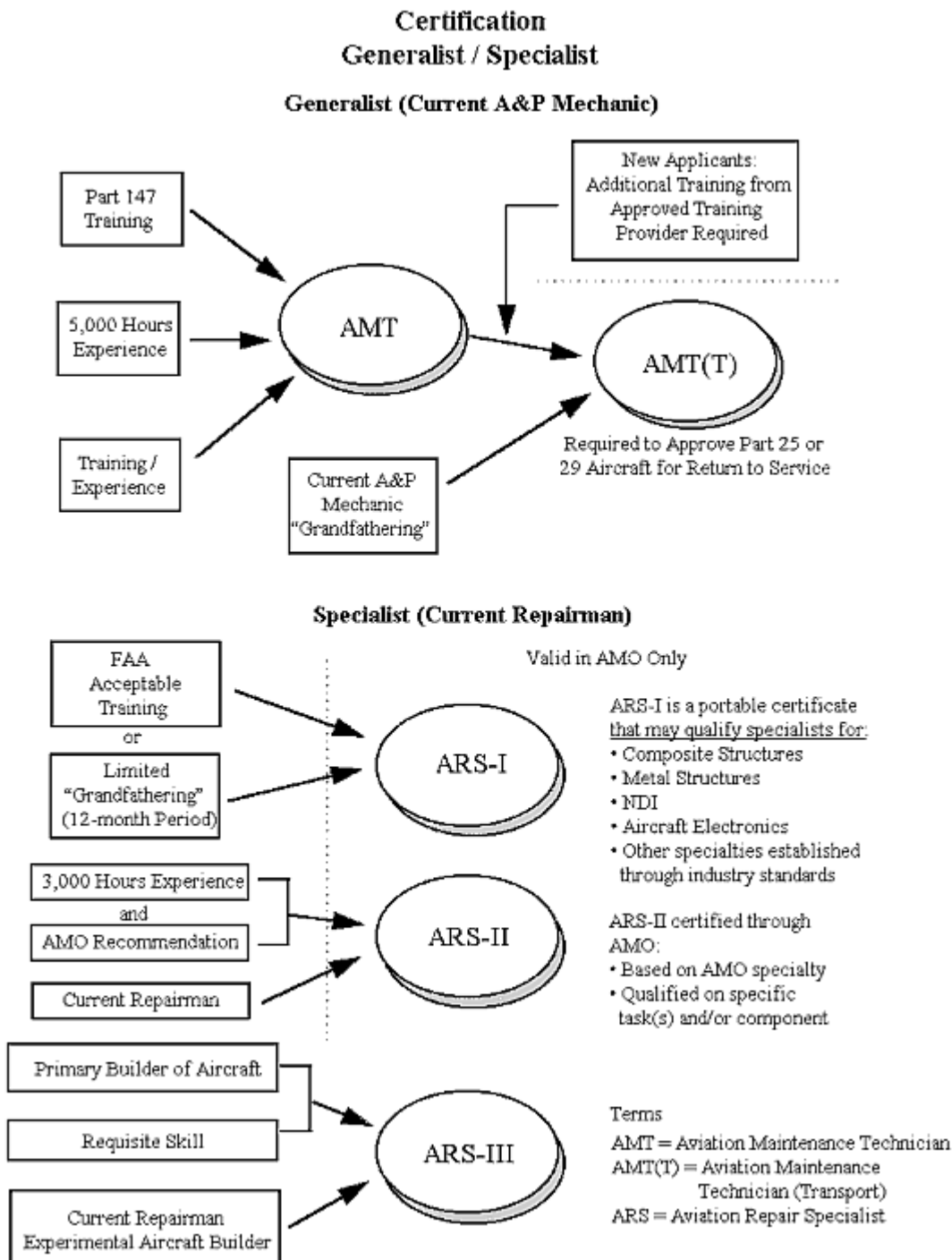
The ARAC-65 working group evaluated several issues relating to advanced certification and concluded that a new certification process should be developed. There was general agreement within the ARAC-65 working group that the aviation maintenance technician (AMT) and the aviation maintenance technician transport (AMT[T]) certification would have certification privileges for entire aircraft "return to service." It was also agreed that not all aviation maintenance workers need to meet these broad requirements and that areas of specialty, with corresponding certification, would be required.

The committee determined that individuals should be able to become FAA certificated in designated specialty areas. This certification would also create a positive impact on safety as workers would be better qualified in appropriate specialist maintenance procedures and practices. These specialists could, in all probability, become qualified and certificated in a shorter period of time than an AMT or AMT(T). This would create opportunity to develop workers more quickly in periods of high demand. It would also allow persons who could not afford the longer schooling required to obtain an AMT or AMT(T) certificate to gain employment opportunities in aviation maintenance. In addition, the certification would increase

professionalism within the workforce without economic impact on employers.

Under the new Part 66, an ARS certificate may be issued based on proficiency in designated specialty areas independent of employment. Currently, there is no national set of criteria for qualifying in certain specialist areas. **Figure 13.5** highlights the key elements of the new advanced and specialist certification.

**Figure 13.5: Advanced and Specialist Certification**



The current FAA repairman certificate, based on Part 65, may be issued to individual employees of AMOs who are qualified to accomplish specific aircraft maintenance tasks and appliance or component repair and overhaul for Part 121 or Part 135 operators under Subpart J and L, or Part 145 certified repair stations. These certificates are also issued by the FAA to individuals who are primary builders of experimental ("home built") aircraft for their own non commercial use. The repairman certificate process has been significantly revised under Part 66.

The following description of the ARS-I is from the general discussion of the Part 66 **NPRM** draft proposal. This description suggests how the process for specialty certification will proceed if the FAA adopts the ARAC proposal. Further discussion of the ARS certificate and its level ratings is provided in Chapter VI.

*"Currently, an applicant for a repairman certificate (with the exception of those issued to experimental aircraft builders) is required to possess the ability to perform the specific task for which he or she is employed and to obtain the recommendation of the certificated repair station, commercial operator, or air carrier by which that individual is employed. A repairman is not currently required to meet any uniform national standard for the specific discipline in which the individual performs work.."*

*"Extensive study by the Part 65 Working Group has indicated that the increasingly complex nature of aviation maintenance requires that an individual who performs work in certain specialized and highly technical areas should meet formal standardized qualifications. The ARAC concurred with the findings of the Part 65 working group in this matter and has made this recommendation to the FAA. The FAA accepts the ARAC recommendation and, therefore, proposes to issue an aviation repair specialist certificate based on proficiency in designated specialty areas. The qualifications for the issuance of this proposed certificate would be based on nationally and internationally recognized standards (developed by the aviation maintenance industry) that the FAA considers essential for the performance of work in a highly specialized area. The FAA currently proposes to issue aviation repair specialist certificates with ratings based on proficiency in the areas of nondestructive inspection (NDI), composite structure repair, metal structure repair, and aircraft electronics. Although the FAA has defined a number of specialty areas, additional specialty areas are also under consideration (such as glider and hot air balloon repair), and new and previously unknown disciplines may also emerge as specialty areas as technology advances. Additional certificates and ratings, issued by the Administrator, that recognize proficiency in these areas, therefore, may be*



*established later."*

### **13.4.3 Specialist Certificate Justification**

Several factors indicate a national standards based ARS system is needed. Findings from aviation interest groups and studies, such as the ARAC-65 review group, the FAA survey, the Blue Ribbon Panel report, and the FAA's *Aviation Safety Action Plan*, demonstrate the need for updating advanced certification standards. Moreover, international aviation authorities generally support the concept for a specialist qualification system.

One of the ten key issues identified by the joint industry/Part 65 review committee in 1989 was repairmen and specialist certification. When this committee became the ARAC-65 working group, the same ten issues, including repairmen and specialist certification, remained throughout the complete review of Part 65. The ARAC-65 working group has consistently supported the ARS concept. Other than minor clarification, no challenges to the validity and need for this rating were made by participants.

The 1991 FAA survey on the certification of mechanics, holders of inspection authorizations, and repairmen also supported and validated the issues brought forth earlier by the joint industry/Part 65 review committee.

Another major reason for review and revision of the aircraft mechanic and repairman regulation is based upon the level of professionalism in these career fields. The Blue Ribbon Panel report notes that the *U.S. Department of Labor Dictionary of Occupational Titles* lists aircraft mechanics and repairers as semi-skilled. The panel recommended that this be reviewed. The FAA believes it is necessary to increase the level of competency within these occupations and have AMT and ARS meet high standards of skill.

Recommendations from the Blue Ribbon Panel report address the need for advanced standards, as follows:

- Establish qualification, certification, and recurrent training requirements for instructors who teach in Part 147 approved AMT schools
- Conduct periodic re-registration of AMTs to provide vital information about U.S.-certificated maintenance personnel and to provide these personnel with safety and training information
- Support the FAA-developed Advanced Standards Initiative as a means of training AMTs to a higher level of expertise (beyond the AMT of today) and develop advanced AMTs with the skills necessary to maintain increasingly sophisticated aircraft fleets.

The advanced standards support recommendation will be met by the new ARS-I certification process. The Panel also supported industry participation in the regulatory review by stating that:



*"Industry cooperation and participation in the regulatory process is essential to providing meaningful, effective and up-to-date regulations. Information gleaned from the "work-a-day" world must be a consideration in determining the adequacy of rules. Ensure continued regulatory review of aviation issues that affect the quality of AMTs by supporting ARAC or similar review mechanisms. This support is essential to ensure that training and certification requirements remain up to date. "*

Further justification for updating rules and regulations governing aviation maintenance personnel comes from the FAA Aviation Safety Conference held in January 1995. At this conference, the Secretary of Transportation, Frederico Pena, remarked that, "...the responsibility of safety is a shared one" and FAA's Administrator, David Hinson, stated, "We can achieve zero accidents. We must achieve zero accidents." Based on output from the working sessions, an Aviation Safety Action Plan was developed that targets zero accidents as a primary objective. The plan focuses on the following six elements: crew training, air traffic control and weather, safety data collection and use, applications of new technology, aircraft maintenance procedures and inspection, and development of flight operating procedures.

The plan also recognizes that the rules and regulations for aviation maintenance personnel have lagged behind others. Two of the major themes discussed in the conference's Aircraft Maintenance Procedures and Inspection Workshop were:

- The qualification standards and training for aircraft maintenance personnel should receive the same focus and attention from industry and government as the standards and training for aircraft crew members.
- More effective procedures and processes should be identified that can be implemented to eliminate maintenance related discrepancies.

The above factors, combined with the FAA's policy of reviewing and upgrading regulations to ensure consistency with changes in the aviation environment, demonstrate industry and government support for an improved system. Development of a process to use industry standards for the training, qualification, and certification of ARS meets the needs expressed by several groups who have a stake in the industry.

Moreover, industry groups and regulatory agencies generally agree that a new specialist certification system would address concerns from the international aviation maintenance community who have specialization in their systems. The Canadians have moved from a complex certification system, with specific aircraft type ratings, to a system similar to the FAA's. TC has also implemented a specialist qualification system based on nationally developed and recognized standards. The ARS system is endorsed by Transport Canada (TC), who had representatives in the ARAC-65, and is viewed with favor by the European Joint Aviation Authorities. Industry and government observers believe an ARS system with established specialist standards, would place the U.S. in a more advantageous position to engage in worldwide aviation regulatory harmonization.

## 13.4.4 U.S. Industry Response

### Industry Support

Industry response has generally been positive to proposed changes in specialist certification and the addition of the ARS-I. Details outlining the new rule and its implications were presented to industry at various meetings, seminars, and conventions by the ARAC-65 working group, Galaxy Scientific Corporation, and the FAA. Many organizations participated in these discussions, including:

- Aircraft instrument Association
- Aircraft owners and Pilots Association
- ATA Maintenance Training Subcommittee
- Aviation Electronics Association
- Aviation Repair Station Association
- Aviation Technician Education Council
- Canada
- Commercial Aircraft Composite Repair Committee
- National Helicopter Association
- Professional Aviation Maint. Association.
- General Aviation Manufacturers Association
- Helicopter Association International
- International Association of Machinists
- Int'l. Maint. Symposium Attendees
- Joint Airworthiness Authority (Europe)
- National Business Aircraft Association
- Experimental Aircraft Association
- FAA's Hartford Maint.. Fest Attendees
- National Air Transportation Association
- Regional Airline Association

The presentations were based on information contained in a briefing summary document produced by the FAA Flight Standards Division (see **13.11.2 Appendix B**). In general, the response by attendees was favorable to the proposed rule changes. The most frequently asked questions at the presentations related to certification requirements, additional specialties beyond those currently selected for ARS-I, and "grandfathering" of existing certificate holders and specialists. The following comments by meeting participants reflect industry support:

- "It makes good sense to have a portable certificate based on industry standards."
- "We need to upgrade the professionalism of our industry."
- "Our company will be better served by technicians trained to industry standards."
- "Anything that improves the quality of today's employees can't hurt."
- "It will probably be a good thing for the industry."
- "It's great, as long as we don't disqualify anyone with experience who is currently working."
- "This will make many ICAO countries happy, they certify specialists based on regulations that are similar to those proposed."

- "It's good to hear that the FAA is planning to work more closely with industry."
- "Good idea; AMTs should not be doing specialist work."
- "This will encourage a lot more people to become certificated; there is an alternative to an A&P license."
- "Not everyone who works in aviation needs to be an AMT or an AMT(T)."
- "ARS-I will reduce movement of technicians from the shops to the ramp and line."
- "It will help ensure that some of these 4th. party temporary workers are qualified."
- "This will help us harmonize with Europe and the JARs."
- "We will be able to get workers quicker as the job market changes."
- "The public doesn't understand maintenance certification. The new system will be a lot better from an outsider's point of view."
- "The schools will have some standards applied to training of specialists that everyone has agreed upon."

Industry has consistently supported ARS-I certification through both the ARAC 65 working group and focus meetings. The general consensus of many is that AMOs will be better served by employees who have been trained, qualified, and certified based on industry developed standards. Having standards that are monitored and kept current by an independent industry organization has wide appeal. Several interest groups have commented that this will prevent the industry from falling behind as it has with the current certification system.

Supporters contend the ARS-I concept is vital in order to sustain professionalism within the industry. Concern arises from industry over current data indicating that at least one-third of the maintenance workforce employed at third-party repair stations or supplied by temporary agencies are not certificated. Current FAA repairman certificates are granted based on an AMO's operating certificate. Certification for these specialists are not always based on specific government or industry technical standards. The focus on professionalism and standardization of specialist skills qualification and certification is more apparent in other world regulatory systems.

Industry representatives involved with international harmonization issues indicate that the JAA countries and the ICAO tend to favor Part 65 rule changes. In ICAO and JAA regulations, the differences between generalist and specialist skills are more clearly defined, and in general, the international community places greater emphasis on specialist training and qualification. U.S. industry supporters believe action taken in support of ARS-I certification will enhance the overall harmonization process.

There is no aviation maintenance training that leads directly to FAA certification other than the

Part 147 curriculum currently available for A&P mechanic candidates. Certain schools that are not FAA regulated offer aviation focused electronics (avionics) programs. Some of these programs lead to the FCC general radio telephone licensing. A few noncertificated schools also offer aviation composite and metal structures repair courses, primarily for heavy maintenance and component repair station employment. Other than Part 147 certified schools offering A&P training, none offer programs based on nationally recognized aviation industry standards. With ARS-I, training providers will have the benefit of industry standards acceptable to the FAA that can be applied to the training of specialists.

Based on our telephone and in-person interviews, a majority of individuals believe the ARS-I process will encourage more people to become certificated. Since most agree the AMT certification is not necessary for all areas of aviation maintenance, an alternative certification is viable. Individuals inclined to be involved in a specialty have an opportunity to gain certification. Moreover, the time and cost associated with training for the various ARS-I specialties is expected to be about one-half the time and cost of an AMT program.

Aircraft maintenance workers who are AMT certificated generally have the flexibility to change job assignments frequently. Movement of AMTs from the a base to the line or line to shops is common. Since specialists are more focused in their training and qualification, an increase in the number of specialist certificated workers reduces the movement between jobs and provides the added benefit of reducing cost associated with retraining and qualification.

The ARS-I certification will provide a process for some fourth-party specialist temporary workers to obtain individual certification other than through AMT certification. This would not only increase the professionalism in these areas but also ensure that employers are hiring personnel who meet specific industry and FAA standards.

When the maintenance worker supply is limited, individuals can become trained, qualified, and certified more readily as ARS-I specialists than as AMTs. The ARS-I system can thus lead to improvements in both availability and utilization of qualified specialist workers.

### **Major Concerns**

Not everyone in the industry, however, is in full agreement over specialist certification based on the ARS-I concept. A majority of the concerns come from the large airline group. These concerns focus on the potential for increased regulation and additional costs.

**Mandatory Certification.** While those who expressed the concerns understand that the proposed system is not mandatory, they still fear the ARS-I certificate and its administration could eventually become mandatory. Considerable concern exists about the potential for increased cost while achieving no significant improvement in skill level. Some airline representatives maintain that a voluntary process may be sufficient if there is clarity and agreement about standards and competency evaluation. But, if the administration of such a system does not add value to the maintenance process, they do not want to incur additional costs.

**Ambiguity in Regulations.** The possibility of dual certification requirements was of considerable concern. While the regulation is clear that A&P (AMT or AMT [T]) certificates supersede the repairman requirement, the fact that this may be misinterpreted raises concern

among airlines.

**Procedures Already Exist.** Some meeting participants stated that there was no need for new standards and regulation. Information in FAA approved manuals provided by the aircraft, engine, and component manufacturers is sufficient to assure that the work is accurately specified. The FAA has oversight of the reference and procedures information at the time of airworthiness certification and the subsequent revision approval processes.

**Multiple Standards.** While there are several organizations that develop guidelines and standards for technical specialties, most do not have a system in place to determine competency by measurement of task performance. ATA's NDI Specification 105 was cited as an example of a standard that requires validation of competency in performing tasks. Other industry organizations have also developed multiple standards which may lead to confusion about competencies in a specific skill category. The lack of clarity about competing standards and their differences creates confusion and hesitancy to adopt one standard over another.

**FAA Certification Versus Qualification.** A consensus among industry participants indicates less interest in certification than in qualification. A new process would be beneficial if it assisted maintenance organizations in qualifying employees for specialist tasks. FAA Certification without qualification assurance is of no value. There is also a fear that FAA certification will spur a new training industry segment that makes the qualification process longer and more expensive than necessary. If the training and certification processes become too lengthy or expensive, the better option may be to acquire an AMT certificate. If the cost of ARS-I certification is high, workers will want to be compensated through higher wages.

**Limited Perceived Benefit.** Air carrier maintenance organizations indicated they would rather hire AMT and AMT(T) qualified people who are generalists in order to provide the organization with more flexibility. Only those organizations with sufficient volume in a particular specialty might benefit from the ARS-I certification. Otherwise, if reduction in the labor force becomes necessary, an operator might be left with the improper mix of people and skills to get the work done. Some contend that generalists provide a more flexible staff than specialists.

There is also the perception that the metal structures specialty is not necessary. Several operators felt that existing AMTs are already sufficiently knowledgeable and skilled in sheet metal and structures. There may not be a complete understanding about the level of metal structural work being considered for the ARS-I specialty as the perception remains that operators and maintenance organizations are currently capable of getting this work done.

**Certification Applicability.** Some industry representatives believe the ARS-I certificate should only apply to Part 145 operations and not to Part 121 and Part 135 operators. Furthermore, since the impact of ARS-I certification is relatively small, other parts of the rule making process recommendations are more important than the certification of specialists.

#### **13.4.5 Part 145 Repair Station Technician Survey**

FAA certified repair stations would be the most likely users of ARS-I certified specialists, according to a recent informal research survey conducted by a member of the Society of Automotive Engineers (SAE) Commercial Aircraft Composite Repair Committee (CACRC).

In April 1994, the survey examined 40 Part 145 repair stations performing heavy aircraft maintenance seeking information on the array of technicians employed. The survey targeted A & P certified mechanics and the four areas of specialization considered by the ARAC-65 working group. Twenty-three of the repair stations (56%) supplied information.

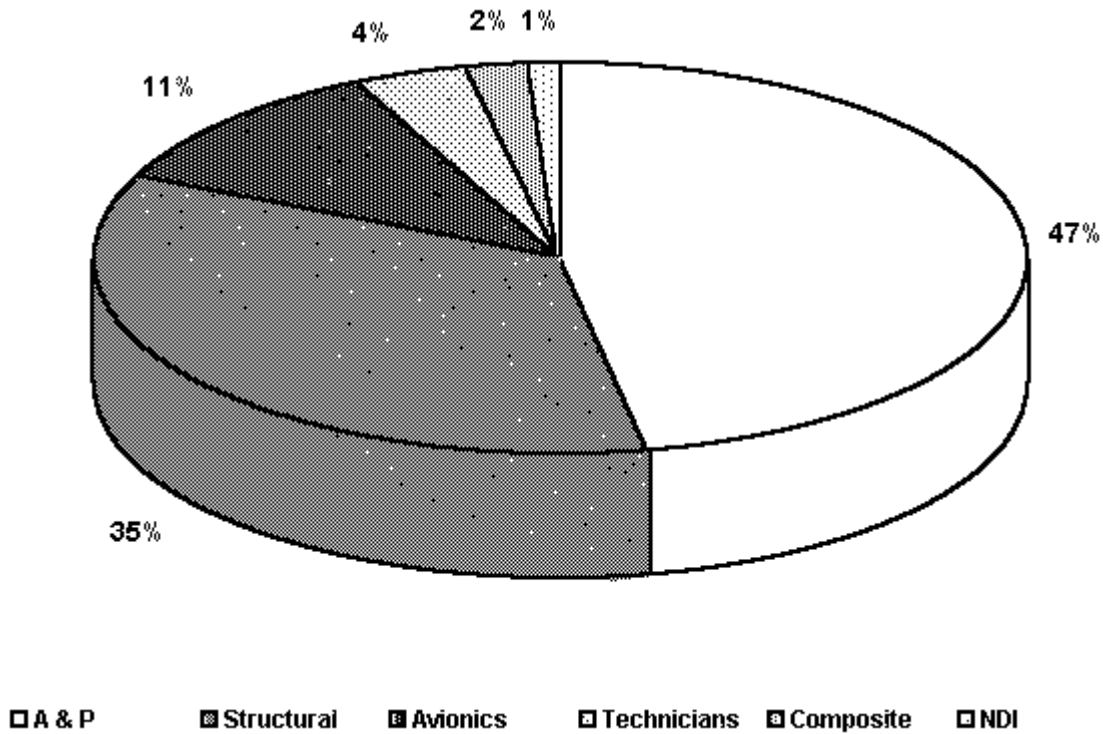
Repair stations selected to participate in the survey were chosen from the World Aviation Directory and specifically identified as performing work on large transport category aircraft. The survey was not intended to be formal or statistically valid. Nonetheless, the results provide useful information (and to our knowledge unavailable from any other source) on advanced certification for specific skill areas in certified repair stations. The survey requested the following information:

- Number of technicians employed
- Types of technicians and certification (specialist or A&P)
- In-house training
- Reaction to specialist proposal
- Support for avionics, NDI, composites, and structures specialty categories.

A total of 8,312 technicians were employed by survey respondents. Of these, 47% or 3,906 technicians were identified as certified A&Ps and 53% or 4,406 as noncertified technicians. Approximately 35% (2,909 employees) of the noncertificated technicians were structural and sheet metal workers. Avionics technicians represented 11% or 886 employees, and NDI and composite technicians accounted for 150 employees and 169 employees, respectively.

Unlike the major air carriers, where at least 90% of maintenance personnel hold A&P certificates, the Part 145 operators employ maintenance staff where less than 50% hold A&P certification. It was also interesting to note that only 61% of the respondents conduct training for technicians in the specialties surveyed. **Figure 13.6** shows the distribution of technician by skill area for the survey sample.

**Figure 13.6 Distribution Of Technician Skill Areas At Selected Part 145 Repair Stations**



The survey suggests a possible significant gap in competencies between the maintenance personnel employed by air carriers and third-party maintenance personnel who perform maintenance under contract to air carriers. The data indicated that there is less training conducted and a significantly lower proportion of FAA certificated technicians (47% Vs 90%) than at the airlines. The fact that several of the third-party organizations use temporary contract workers ("fourth part") was not part of, nor was it factored into, the survey results.

All respondents indicated that industry standards in the avionics, NDI, composites, and structures specialties would benefit their operations. The survey indicated a general interest for improvements in specialist training and qualification. Those responding were fully supportive of avionics and NDI standards, and there was a close to full support for standards for composite and metal structures repair.

### 13.4.6 ARS Internal Research Study

An informal, internal, research study was conducted focusing on ARS certification. Information was provided by members of the Aviation Electronics Association (AEA), including seventeen airlines from ATA and 56 repair stations associated with AEA. **Table 13.6** summarizes the information provided by the participants. As expected, interest in the ARS concept is greater among airline representatives than among repair station representatives.

Table 13.6 ARS Information Summary		
Information Topics	ATA -MTSC	AEA
1. What percentage of your maintenance work is performed by third-party		

contracts?	21%	13%
2. Will third-party maintenance increase, decrease, or stay the same?	69% Increase	12% Increase
3. Including shops and base maintenance, what percentage of your maintenance staff is not FAA certificated.	25%	26%
4. Taking maintenance as a whole, what percentage of your maintenance staff is not FAA certificated?	38%	39%
5. Is FAA ARS-I certification necessary, may be needed, can't hurt, or not needed?	6% Not needed 59% Necessary	28% Not needed 27% Necessary
6. Will ARS-I certification have any economic advantages for your operation?	65% Yes	29% Yes
7. In your opinion, will ARS-I raise the level of maintenance professionalism?	82% Yes	48% Yes
8. Do you feel all aircraft maintenance workers should be A&P (AMT) qualified?	53% No	73% No
Source: HKS & A		

Participants were asked to identify what other skill specialties may be ARS-I candidates in addition to avionics, composite structures, metal structures, and NDI. In order of preference, the following skill areas were identified: machinist, welding, avionics shop repairmen, engine testing, metal bonding, heat treatment, plating complex components (e.g., fuel controls; hydro-electro-mechanical, CSD), flame spray painting, and flight control rigging of fly-by-wire.

### 13.4.7 Job Task Analysis

A job task analysis (JTA) of the maintenance technician occupation is currently being conducted for the FAA by Northwestern University's Transportation Center. The objective of the Phase I research is to provide the FAA and the aviation industry with the background information necessary to revise regulations that prescribe the certification and training of AMTs and ARSs. Conclusions drawn from the report indicate:

*"Important similarities as well as significant differences between segments of the aviation industry with respect to task performance are being identified. To the extent that there are similarities, requirements should be applied to all AMTs and to all schools. To the extent that there are differences, opportunities for specialization should be considered, along with an emphasis on a common core or skills and background."*

*"It would appear to be desirable to develop a set of regulations that would encourage flexible and continuing change."*

Although the JTA study focuses primarily on AMT and AMT(T) tasks, data in the Phase I the findings to date generally support the ARS-I certification concept. The 23 tasks, selected to



validate their data gathering methods, were spread over a wide range of skill groups. Aviation maintenance personnel were asked to evaluate work-related tasks based upon six performance measures and to rate the tasks on a scale from 1 to 5 (with 5 being the highest). The performance measures were:

- Task frequency
- Task importance as measured by consequence of improper performance
- Level of industry training from basic familiarization to in-depth training
- Difficulty in learning a task
- Technical knowledge and ability required to perform the task
- Manipulative skill needed from routine to considerable experience.

The results of this analysis show specific tasks, such as repair of composite and laminated primary control surfaces and repair of electronic flight instrumentation systems, are perceived as requiring higher levels of training, knowledge, and manipulative skill. These tasks are directly related to the ARS-I specialist categories established in the new Part 66. **13.11.3 Appendix C** shows the performance measure composite scores (degree of overall difficulty). As more information is analyzed, we anticipate results of the study to support and validate the need for ARS-I certification. This work may also identify other specialist categories as candidates for certification.

The final JTA data acquisition is scheduled for completion in early 1996, with a final report expected at the end of 1996.

## 13.5 GLOBAL REGULATORY DIRECTIONS

The need for global aviation regulation has been discussed since aircraft began flying across national borders. There is potential for safety related issues as well as increased operational costs due to divergent national regulations. Despite the different national regulatory schemes and authorities, the aviation industry has, nevertheless, continued to work reasonably well as an international community.

As globalization in the world economy increases, common regulations for aviation operations become more desirable. The issues involved, however, are extremely complex. A significant amount of time and effort is required in order to build a common regulatory process consistent with national interests, historical regulation and operation methods, and cultural differences.

One of the factors common to aviation maintenance regulations is the concept of generalists and specialists. With few notable exceptions, most regulatory organizations in the world recognize these two categories in basically the same way: Licensed generalists have the privilege and authority of return to service of whole aircraft, and specialists are authorized (through either

certification or qualification) to perform work in specific skill or task areas. The concept of generalist or specialist can form a common basis, or at least a starting point, on which a global regulatory process can be established in the aviation maintenance community.

Many countries are working toward a harmonized aviation system in one way or another. Significant progress has been made in North America and, to a lesser extent, in the **EEC**. This chapter discusses the current state of global aviation maintenance regulation and near-term harmonization efforts.

### 13.5.1 International Civil Aviation Organization

ICAO was formed in 1947 to implement the Convention on International Civil Aviation. Agreed upon by 52 nations, the Convention set forth the guidelines for international aviation regulation. A major objective was to set minimum operating standards to help assure and promote safety in international aviation. ICAO now has over 180 members. The organization works by creating standards and recommendations for operational practices. ICAO's standards and recommended practices (SARPs) are wide in scope from flight crew licensing to search and rescue and terrorism control.

In 1987, **ICAO** began a review process of its aircraft maintenance technician licensing standards and **AMO** standards, which had not changed since 1972. The revision process for Annex I, Licensing of Aircraft Maintenance Engineers, is currently in the proposal stage. ICAO's effort to revise aircraft mechanics licensing standards has shown little progress since late 1991. Leadership in the harmonization of mechanic regulations appears to rest within the activities of the **JAA**, **FAA** and **TC**. When their positions become clear, ICAO may then move forward.

**ICAO** is also reviewing **SARPs** for **AMOs**. Again, their process for change moves at a slower pace than efforts undertaken by other international authorities. In general, it is difficult for ICAO to achieve consensus among its member states on complex issues. The current trend appears to be a "wait and see" pending outcome of the **JAA** process and harmonization efforts.

### 13.5.2 European Civil Aviation Conference

At the request of the Council of Europe, the European Civil Aviation Conference (ECAC) was established in 1955 by **ICAO** to develop coordination among its members. Its membership has grown from the original 19 countries to over 30 countries as a result of political and economic changes in Europe. ECAC has adopted **JAA** aviation regulations as the basis of aviation law in Europe. Although ECAC does not play a direct role in regulatory harmonization, its members are involved. The majority of ECAC member states have become, or are in the process of becoming, **JAA** members and participate in the **JAR** process.

### 13.5.3 Joint Aviation Authorities

The **JAA** was created in 1970 to develop rules for new aircraft certification. With regard to some aircraft design and operational requirements, the organization developed Joint Aviation Regulations (JARs) that were based on the equivalent U.S., German, and UK regulations. The

JAA is the **EEC**'s aviation regulatory body.

In 1987, the **JAA** began to develop standards for aircraft maintenance operations, including **AME** licensing. **ICAO** Annex 1 was one of the source documents for **JAR-145** and **JAR-65E**. Beginning in 1994, compliance with **JAR-145** and **JAR-65E** became mandatory for any company maintaining and repairing European-registered aircraft, engines, or components. In this regard, the **JAA** and the **FAA** have been actively working together for several years.

**JAR-65**, the **EEC** equivalent to Part 65, has been in the development process through seven revisions. It is being developed under the authority of the **JAA**. The rule is not scheduled to become fully implemented until July 1999. While harmonization with the Part 65 is under consideration, it was not placed on the 1995/1996 agenda of their working group meeting in March 1995.

The **JAR 65** approach is different from the U.S. in that all maintenance certification authority is vested in the **AMO**. As stated by A. S. Soulis of TC's Airworthiness Branch:

*"Clearly, the **JAA** is committed to a model which will rationalize differences by accommodating existing nation state divergence and variances. That is, recognize the supremacy of the **AMO** as the basis for total maintenance. In this manner, each regulatory agency can play whatever role they choose, within broadly based parameters, with the understanding that each **AMO** will establish criteria for acceptable trade standards."*

This statement suggests that the **AMO** will remain the basis for the total maintenance certification control program. It appears that the **JAA** executive and its member states are still some distance from reaching consensus on the proposed maintenance personnel certification rule.

Historically, many foreign flag carriers have become accustomed to near regulatory control within their own country. These carriers seem hesitant to give up this level of influence and control. The countries that have their own certification system may not always be comfortable with losing their independence to a system of **AMO** control.

Some countries place high value and specific requirements on structured formal training as part of certification, while others place emphasis on certification based on job training. In some cases, maintenance personnel are trained to a particular level of qualification with no regulatory licensing requirement.

#### **13.5.4 FAA and JAA Harmonization Program**

The **JAA** model of maintenance certification authority vested in the **AMO** is different from that of the U.S. and Canada. In North America the regulatory authorities have taken the approach of centralized technician certification control through regulating training, qualifications, and personnel certification. Since there is a strong agreement between the two countries and given the recent North American Free Trade Agreement (NAFTA), North American harmonization efforts are moving forward. The maintenance certification regulatory review work of the

Canadian Aviation Regulation Advisory Committee (CARAC) and the U.S. **ARAC** are in their final stages.

Harmonization between **JAA** and the **FAA** will not be an easy task, particularly in the area of maintenance technician certification. The differences that exist between the proposed JAA system and the U.S. and Canadian systems are not expected to reach resolution in 1996. However, there is some indication that JAA may be looking to developing a two-level generalist certificate, with return to service privileges. Given the recent changes to Canada's maintenance regulations and the apparent progress on harmonization with the FAA rule, JAA may move toward the North American model.

The **FAA** has attended all the **JAA** meetings on maintenance regulatory harmonization. The JAA is very aware of the work completed by the **ARAC** 65 working group. Moreover, comments received from the JAA on the new Part 66 were favorable. In general, JAA's view is that the Part 66 comes closer to meeting their directions than does Part 65.

From the U.S. standpoint, a major reason for harmonization is to clear the way for open skies agreements. Such issues are highly complex with requirements for multiple bilateral agreements. The impact of an open skies policy on economic operations of airlines and offshore third-party maintenance organizations is well known. The U.S. has already taken steps to expand its rules regulating offshore maintenance on U.S. registered aircraft. There is an ongoing country by country mutual inspection process designed to develop common standards and practices that will eventually become a worldwide model.

### **13.5.5 Federal Aviation Administration**

The **FAA**, as the U.S. government arm of the **DOT** that regulates the skies, equipment, and people involved in aviation operations over the U.S., has a keen interest in harmonization. The FAA is committed to cooperation with other authorities and regulatory bodies, but with the interest of U.S. operations as its primary focus.

As previously mentioned, harmonization efforts specifying maintenance personnel licensing with the **JAA** have been slow because of the many national interests involved. The **FAA**'s relationship with Canada has been much more successful since the U.S. and Canada have shared full participation in the rule making process at the advisory council level.

### **13.5.6 Transport Canada**

TC has moved from its European (basically British) heritage in aviation maintenance regulations to a system similar to the FAA. Since 1993, TC has been working with its industry group, the Canadian Aviation Regulation Advisory Committee (CARAC), on reviewing the licensing and training of aircraft maintenance technical personnel.

A CARAC Aircraft Maintenance Engineer (AME) Licensing Control Working Group was formed with similar objectives and industry representation to the U.S. ARAC Part 65 working group. In fact, the FAA has representation on the CARAC working group, and the TC is represented on the ARAC Part 65 working group.

The recommendations of **CARAC** are similar to those proposed by ARAC Part 65 working group. Their recommendations include the following:

- **AME** licensing standards to be consolidated into the Airworthiness Manual Chapter 566 (similar to the U.S. Part 66)
- M license category privileges (**TC**'s generalist certification for aircraft return to service) to be consolidated into two ratings, as follows:
  - M1-Include all fixed and rotary wing aircraft designed to AWM Chapter 523/527 design standards and less complex aircraft (similar to the **AMT**)
  - M2-Include all fixed and rotary wing aircraft designed to AWM Chapter 525/529 design standards and more complex aircraft (similar to the **AMT[T]**).

The **AME** E (electrical), S (structures), and P (powerplant) specialized licenses will be retained. While the ratings remain, there will be some consolidation of subparts into one rating for each specialty and changes to where privileges may be exercised. The recommendations of the **CARAC** and **TC** parallel those of the **ARAC** and **FAA** on **AMT** and **ARS** certification. Since the proposed rule changes of both countries were conducted in similar forums with cooperation between respective regulatory administrations, harmonization should proceed in a timely manner. In early 1996, Bilateral Aviation Safety Agreement (BASA) meetings are scheduled to formalize harmonization efforts between TC and the FAA.

### 13.5.7 Other Countries And Authorities

Other countries and authorities are basically waiting to see what the U.S., Canada, and **JAA** countries do relative to harmonization. Most other countries in the world operate primarily on either an **FAA**- or **ICAO**-based maintenance regulatory system.

The Australian and New Zealand maintenance regulators have been keeping close track of the progress being made in the U.S. and Canada. While their system of maintenance regulations are a mirror image of the UK system, the thrust seems to be toward regulations similar to those being developed in North America. At a recent industry meeting, attendees did not wholeheartedly support the **JAA** directions. Instead, they indicated a preference for changes in their system that would more closely resemble the **TC** and **FAA** models.

### 13.5.8 North American Free Trade Agreement

As discussed earlier, the NAFTA northern partners have been making significant progress. Phase II of the NAFTA maintenance technician licensing harmonization meetings began in November 1995. Chaired by **TC**, the working group is considering major differences in airworthiness requirements for engineering and maintenance. The working groups are focusing on developing

congruent civil aviation standards and producing a set of proposed requirements.

### 13.5.9 Summary

Clearly, the global aviation maintenance regulatory community has recognized the need to develop maintenance personnel certification regulations that are compatible internationally and, at the same time, meet the requirements of individual countries. The issues extend beyond regulatory compatibility and harmonization. Historical perspective, traditional labor and guild factors, national pride, flag carrier identity, and existing regulations contribute to the slow process.

The focus on the generalist and specialist concept of certification continues to gain momentum, as demonstrated by both the U.S. and Canadian systems. Having a U.S. system of aviation specialist certification categories based upon national industry standards should serve to both enhance professionalism and our international status. If adopted, this system could serve as a model for specialist certification in the rest of the world.

International regulatory authorities are exploring the various differences and similarities in approaches to training, qualification, and certification of maintenance personnel. Having a standards-based specialist certification system in place could be a valuable asset to the U.S. position in the international aviation maintenance community. Global harmonization may not be achieved by the end of the decade, but indications point toward continued forward progress over the next few years.

## 13.6 OTHER INDUSTRY STANDARDS

Examining the systems and processes developed by other industries for skill training, qualification, and licensing provides useful information in formulating the **ARS-I** system. Other industry standards can be used as guidelines; in addition, advice and insight on "lessons learned" can be gained from the experience of professional organizations. In general, there are two approaches to formal recognition of specific skill and knowledge:

- Government-imposed licensing, administered by governmental (e.g., federal, state, county, city, or district) agencies through rules and regulations.
- Self-imposed certification, based on standards designed to maintain specific levels of performance. In most cases, the development of these standards and the resulting training, qualification, and certification systems are under the auspices of nonprofit professional organizations.

Industry standards are usually put in place for the purpose of:

- Ensuring public and worker safety

- Preventing high costs associated with errors
- Elevating professional standing and/or perception of the profession.

It is in an industry's best interest to maintain an excellent safety record when public, worker, and plant safety are involved. Trade associations often provide the best guidance for appropriate safety practices. When significant public interest exists, governmental agencies are usually responsible for the guidance, regulation, and oversight. These agencies and associations closely track an industry's safety record.

Performance errors can be costly, and all industries are aware of the cost-benefits associated with comprehensive safety procedures and practices. Many industries have established their own safety standards and training programs for workers. In some cases, governmental agencies conduct inspections and have the authority to levy fines for practices or conditions that do not conform to established safety standards, rules, and regulations.

For some industry associations, the goal is to improve general perception of their professional status. An association gathers information from its members and interested parties to establish standards of knowledge, performance, and professional behavior. These associations conduct educational programs and certification examinations to demonstrate that members have reached certain levels of proficiency.

Various national organizations have developed training and certification standards for a wide range of skills that are in continuous use today. Each organization typically has a board of directors, governors, or standards committee consisting of recognized industry experts. Whereas the actual skills for training and certification may differ, the process to develop, apply, and maintain standards is similar.

This section describes successful training, qualification, and certification programs of several organizations that are applicable in establishing an ARS certification system. Our recommendations for ARS certification standards, presented in **Chapter VIII** of this report, take into account the processes implemented by other industries.

### **13.6.1 American Society for Nondestructive Testing (ASNT)**

The American Society for Nondestructive Testing (ASNT) provides an excellent example of what approved standards might include. The **FAA** considers the ASNT standards, in its present form, to be an acceptable model for current repairman and **ARS-I** certification for persons performing **NDI**.

**ASNT** prepares and publishes industry standards that apply to personnel whose specific tasks or jobs require appropriate knowledge of the technical principles underlying nondestructive inspection (NDI) methods. These specific tasks include performing, specifying, reviewing, monitoring, supervising, and evaluating NDI work. The standard specifies the procedures and minimum requirements for qualifying and ASNT certification of NDI personnel. ASNT standards were initially developed to address industry concerns of safety and reduction in errors.

**ASNT** standards are set forth in the document, *ASNT Standard for Qualification and*



*Certification of **NDI** Personnel* (ASNT-CP-189). (Certification in this section refers to that which is ASNT sponsored.) The basic premises of the standard are to:

- Establish the minimum requirements for the qualification and **ASNT** certification of **NDI** personnel
- Detail the minimum training, education, and experience requirements for **NDI** personnel and provides criteria for documenting qualifications and **ASNT** certification
- Require the employer to establish procedures for the qualification of **NDI** personnel
- Require that the employer incorporate any unique or additional requirements in the certification procedure.

Five levels of qualification are defined by **ASNT** in terms of the skills and knowledge base required to perform specified **NDI** activities. They include the following skills and knowledge:

- Trainee-not yet certified at any level
- Level I-perform specific calibrations and tests, and with written approval of a **NDI** Level III, perform specific interpretations and evaluations
- Level II-set up and calibrate equipment; conduct tests; and interpret, evaluate, and document results
- Level III-establish techniques; interpret codes, standards, and specifications; designate the particular technique to be used; and verify adequacy of procedures
- **NDI** Instructor-plan, organize, and present classroom and/or on-site job **NDI** instruction, training and education programs.

For each **NDI** method, **ASNT** standards identify the detailed curriculum objectives, the required hours of training, the minimum hours of experience in the **NDI** method, and the minimum hours of total **NDI** experience required for each level of certification.

All written and practical examinations are developed by the employer according to **ASNT** standards. The practical examinations are administered by a Level III qualified person in the **NDI** method being examined.

Employers administer an exam for Level III certification; upon successful completion, the certificate is valid for 5 years before requiring recertification. Each certificate indicates competency in one of the eight methods used for **NDI**-radiography, X-rays, magnetic particle,



ultrasonic, liquid penetrant, electromagnetic, neutron radiography, leak test, and acoustic emission.

Individual certification expires (1) when employment with the employer is terminated, (2) at the end of three years for **NDI** Levels I and II, or (3) after five years for Level III. The employer may revoke the certification if any individual fails to meet the physical or performance standards outlined by **ASNT**.

The employer is the key element in applying **ASNT** standards. Any organization may purchase the documents from ASNT that outline training requirements, curriculum development, and certification testing. The primary reason for employers to use the prescribed ASNT certification process is to encourage the development and training, and perhaps qualification, of their **NDI** employees. The use of ASNT standards by an employer provides a structured program for training, certifying, and evaluating their employees. There is no national oversight of the employer's application of ASNT standards.

### 13.6.2 National Institute for Automotive Service Excellence

There are significant parallels between aircraft and automotive technicians. The increasing complexity of technology and electronics requires that both aircraft and automotive technicians are highly trained and knowledgeable in their respective fields.

The National Institute for Automotive Service Excellence (ASE) provides a program of school and technician certification to help service organizations and consumers be assured that certified technicians are competent and up-to-date with their knowledge and skills.

In 1972, **ASE** was established by the National Auto Dealers Association (NADA) in response to questions of fraud in the service industry. NADA choose a self-policing approach as an industry protection against fraud. ASE, a nonprofit organization, is organized independent of NADA and funded entirely on fees paid by technicians for testing. The fees are modest ranging from \$15 to \$40 per test plus a \$20 registration fee; applicants may take more than one test with a single registration.

**ASE** certification is voluntary for technicians and schools seeking ASE approval. No other association provides a similar certification in this field. Benefits to certification holders in the form of job access and promotion are due to industry's respect for the ASE standards and certification process.

According to **ASE**, registration for certification has been steadily increasing. Approximately 370,000 automotive technicians are ASE certified in the United States. ASE offers three levels of certification tests, as follows:

- Regular level-Certification is offered in 22 categories, including automobile, medium/heavy truck, collision repair and refinish, engine machinist, and alternate fuels. The tests are constantly reviewed and revised to reflect today's technological advances, such as newer sophisticated electronics systems and light vehicles using compressed natural gas.

- Advanced level-This test is designed to address difficult driveability and emissions-related repairs. More than 12,000 technicians are now certified in the advanced certification category. In order to take the automobile advanced engine performance exam, one must be currently certified in the regular automobile engine performance specialization.
- Re-certification-Tests are given to ensure that **ASE** certified technicians are current with the new technology in their field.

### **NATEF Standards**

Since **ASE** is the evaluating body, it does not advise on program content and standards for schools. A sister organization, the National Automotive Technician Education Foundation (NATEF) conducts research and creates the curriculum standards and certification evaluation for schools. Combined, the ASE and the NATEF have developed a comprehensive standards program.

Organized in the early 1980s, **NATEF**'s original research was funded by the automotive industry. The organization created task lists, tools and equipment lists, and standards of performance. NATEF revises, as appropriate, industry standards in accordance with technological changes.

All 50 states have endorsed the certification standards and processes established by **NATEF**. The organization works directly with state officials of vocational/technical education programs. When a school seeks **ASE** certification, NATEF provides the appropriate materials and program guide. A school must first conduct a thorough self-assessment based on NATEF guidelines followed by NATEF staff review. If shortcomings occur, NATEF provides recommendations for corrective action and allows the applicant school one year to comply.

Once a school's self-evaluation is approved, **NATEF** conducts an on-site evaluation. When the team certifies compliance with the standard, the school is then recommended to **ASE** for certification.

Overall, **NATEF** has established a rigorous and respected process. The U.S. Department of Education granted NATEF funds to review and update its standards and to conduct a study to determine if certification makes a difference. NATEF representatives indicate that the study showed a clear difference between those technicians who completed a course of study with a certified school versus those who did not.

### **13.6.3 Nuclear Regulatory Commission**

The Nuclear Regulatory Commission (NRC) patterns its personnel certification standards along the lines used by the **FAA** for pilots and mechanics. Similar to the FAA, the NRC requires a significant amount of simulation training and testing for operators and requires medical and drug tests. The NRC also provides certain certifications for **NDI** radiographic qualified technicians who use isotopes as an X-ray source.

The **NRC**, a federal agency, establishes standards for safe operation of nuclear power generating plants. Each installation, however, is responsible for developing its own operational plan specific to the facility. Although there is no standardized curriculum or examination, the personnel training and certification programs among the different nuclear power plants are fairly similar.

The Institute for Nuclear Power Operations (INPO), a nonprofit organization, serves as an umbrella communications group representing all U.S. nuclear power generating facilities. INPO provides information and support to its member organizations, such as overview documents with information about how to develop a training curriculum and certification process to submit to the **NRC** for approval. INPO facilitates appropriate interchange of information among the facilities through meetings and conferences as well as individual support, as requested.

**NRC** certifies individuals as licensed operators with authority to make decisions on plant operations and approval for work performed by unlicensed maintenance and auxiliary operators. Training for all personnel (licensed and unlicensed) is conducted on-site and is the responsibility of the individual power generating site. Each site has its own unique systems and procedures for operational safety following guidelines and regulations set forth by the NRC and federal, state, and local governmental agencies. Periodic inspections of worker performance and safety procedures are conducted by the NRC.

To qualify a person as a licensed operator, an **NRC** evaluation team administers on-site examinations (both in written form and in simulated tests) and observes applicants in their specific work environment. Although maintenance and auxiliary operators are not licensed, they nevertheless must adhere to established procedures with respect to operational and maintenance tests, quality control, and administrative functions. Shut down plans and procedures for maintenance are approved by the licensed operator in charge. When the repair or maintenance is complete, the licensed operator supervises the appropriate tests for returning the system to operation.

The training, qualification, and certification for nuclear power operators is rigorous. Operating a nuclear power generating station is highly critical, and the consequence of an error can be extremely severe. Extensive personnel training is essential to avoid catastrophic mistakes and to enable flawless execution of procedures in both routine and unexpected situations.

#### **13.6.4 American Welding Society**

Currently, the **FAA** does not require additional certification for aircraft construction or repair welding beyond the FAA mechanic certificate. Based on the most recent revision of Part 147 for Aviation Maintenance Technician Schools, **A&P** mechanics must be able to differentiate between acceptable and unacceptable welds, but are not required to demonstrate welding proficiency to the standards required to repair primary aircraft structures. The industry, however, has progressed well beyond basic welding competencies. Many airlines and repair facilities now require welders, especially those performing critical welding tasks in component and engine repair shops, to be American Welding Society (AWS) certified.

The **AWS** was founded in 1919 to advance the science, technology and application of welding. It is a nonprofit organization that conducts welder, welding inspector, and welding educator

certification programs.

The Society's 42,000 members consist of educators, engineers, researchers, welders, inspectors, technicians, welding foremen, company officers, and supervisors. Disciplines include automatic, semi-automatic, and manual welding, as well as brazing, soldering, ceramics, robotics, thermal spraying, and lasers-disciplines also used in the aviation maintenance industry. **AWS** activities include initiatives in research, safety and health, education, training, business, and government liaison. Their standards are considered as benchmarks in the welding profession. AWS also maintains a system of accredited education and test facilities in the U.S. and overseas.

An example of the **AWS** system and the process that relates to **FAA** certification for the aviation maintenance industry is their certified welder program (different standards exist for welding inspector and welding educator qualification and certification) which ensures welder qualifications. The Society's certified welder program includes the following four key elements:

- Welder performance qualification standards
- Standard welding procedure specifications
- Accredited performance qualification test facilities
- **AWS** welder certification requirements.

The purpose of the standard for an **AWS** certified welders is to:

- Determine the ability of welders to deposit sound welds in accordance with standardized requirements
- Impose sufficient controls on the documentation and maintenance of certification to allow transfer between employers without requalification, where allowed by Standard of Contract documents.

Specific specialties for advanced certification include: chemical plant, petroleum refinery piping, and high-rise construction. Application for certification is extensive and includes verification of background, experience and education. **AWS** requires medical certification of acceptable visual acuity completed no earlier than six months prior to testing and certification.

The **AWS** standards are well-defined, voluntary-based standards developed in accordance with the rules of the American National Standards Institute (ANSI). They provide an excellent basis on which to pattern the development of standards for training, qualification, and certification of **ARS**.

### **13.6.5 Electronics Technicians Association International**

The Electronics Technicians Association (ETA) International provides a certification process for the commercial electronics industry, based on non-aviation standards.

Established in 1978, the **ETA** offers four levels of certification: associate, journeyman, senior, and master electronics technician. They also offer special certification for satellite installer and customer service specialist.

**ETA** certifies electronics technicians by examination only. An applicant may prepare for the tests in any way he or she chooses. ETA offers study materials, texts, videos, and practice tests to assist in a self-paced study program. Certification preparation workshops are also available through worldwide ETA chapters.

Only 25% of first-time applicants pass the exam. Should an applicant fail the examination, he or she may retake the test free of charge after 60 days, but no later than one year after the initial test. **ETA** offers a personal exam review to assist individuals in evaluating test results.

Any electronics technician may take the **ETA** certification exam. Typically, technicians interested in certification, work for an electronics retailer/distributor, for an independent service and support organization, or in self-employment.

An associate certificate is for a technician, electronics student, or electronics apprentice with less than four years of combined work and electronics training. The technician may apply to take the multiple-choice examination that is the basic portion of the journeyman certification examination. The examination covers basic electricity, electronics, math, AC and DC circuits, transistors, and basic troubleshooting skills. The associate level examination is a two-hour test, and the applicant must receive a score of 75% or better to pass. The successful associate receives a certificate and card valid for four years.

A technician with four or more years of combined work and electronics training may apply to take the journeyman certificate examination. To be a fully certified electronics technician, an entire certification examination must be passed, which consists of the associate level plus one of the specialized journeyman options. This examination deals with advanced practice and theory applicable to the electronics specialty selected. The journeyman level examination is a three-hour test, and similar to the associate exam, the applicant must receive a score of 75% or better to pass. A technician who has a valid associate certificate will only be required to take the journeyman specialty examination. A successful candidate receives a certificate and card valid for life. The journeyman specialty options are:

- Consumer electronics
- Video distribution
- Wireless communications
- Avionics
- Telecommunications
- Industrial

- Computer
- Bio-medical.

With eight or more years of combined work and electronics training, a technician may apply for the senior level examination. To be a senior certified electronics technician, an entire certification examination must be passed, which consists of the associate level exam, plus one of the specialized journeyman options.

### **13.6.6 Medical And Health-Related Technologists**

The system of training, qualification, and certification of radiological technologists is administered at the state level. The National Society of Radiological Technologists (NSRT) sets the standards pattern from which several state programs are based; however, the organization itself does not develop specific certification procedures. The following describes the California program which is typical of systems implemented for this discipline in other states.

California's program is administered by California Health Services, Radiological Health Branch. This organization sets the standards for training and curriculum for radiological technologists. It is generally a 2 to 3 year program conducted through the state's community college educational system. Successful completion of the program qualifies an individual to take the state examination. The examinations are conducted by the Comprehensive Personnel Services (CPS), a for-profit organization that conducts these, and similar tests, for governmental agencies. CPS only conducts tests; they provide no training or other related activities.

Individuals may also become certified as limited permit technicians. In this case, technicians are qualified with shorter duration, specific focus courses that are often taught by business schools or medical technician schools. These courses generally certify technicians to perform X-rays on specific parts of the body, such as podiatry, chest, etc. Individuals are qualified through on-the-job training and certified upon successfully passing a state-administered test. California State Board certified radiologists (i.e., physicians) automatically receive state certification. Other physicians may sit for and pass exams to gain certification.

Schools apply to the California Health Services Administration for approval of their programs by completing an extensive application showing their curriculum content. Oversight is conducted by inspectors from the California Health Services staff. Limited permit programs generally receive more scrutiny than do the programs conducted at the community colleges

Recertification for radiological technologists is required every 2 years. The recertification process is automatic if the application is timely. A continuing education requirement in California will become effective in July 1996.

Changes in the regulatory process are driven by the California State Legislature. There is current interest, for example, in a new advanced certification in mammography that would require additional training and examination.

At the national level, the **NSRT** and the Society of Nuclear Medicine conduct conferences that often include postgraduate programs, similar to the **FAA** Inspection Authorization renewal

conducted at **PAMA** conferences. These national associations provide industry research and information, but do not develop standards for training, qualification, and certification.

### **13.6.7 Emergency Medical Technicians**

Similar to radiological technologists, the training and certification programs for emergency medical technicians (EMT) and paramedics are based on national guidelines, but developed and administered at the state level. The U. S. Department of Transportation (DOT) issues national curriculum standards upon which states base their curriculum requirements. The DOT participates in state EMT programs primarily in an advisory role. The following discussion on EMT and paramedic certification applies to California, but is similar in most states.

#### **California EMT Certification**

In California, the Office of Emergency Medical Services Authority (EMSA) is the regulatory agency. EMSA administers three certification programs:

- **EMT 1**-Basic certification
- **EMT 2**-Intermediate certification
- **EMT 3**-Paramedic certification.

**EMT 1** and **2** certification is acquired through an approved training agency, usually the community colleges. EMTs are generally classified as highly qualified first-aid givers, but not as medical technologists. Required course work includes 110 hours of instruction in a 4 to 5 month program. Commercial schools may also be approved. EMT 1 and 2 are administered at the county level by appropriate agencies. Trainees are given written and practical tests; the county agencies can accept the final exam from an approved training program, or they may administer their own tests. The California State Fire Marshal and California Highway Patrol also administer EMT 1 programs. State certification is granted after passing the initial written and skill examination and is valid for two years. Continuing education credits, or a refresher class, is required to renew certification each subsequent 2-year period.

**EMT 2**, the paramedic certification, requires successful completion of EMT 1 & 2 qualification, plus 1,000 hours of required training, usually provided by a community college. Persons with this certification are considered medical technologists who can carry out specific medical practices. These include intravenous injections and operation of certain medical test and life support systems.

Paramedic certification is by initial written and practical skill demonstration examination and remains current for two years. Recertification is maintained by completing 48 hours of continuing education every two years, reported to the state board.

For schools to obtain certification, they must submit their curriculum and qualifications to the State for approval. This approval allows schools to be put on an approved list and authorizes their programs for instruction.







Maintain standards	4	4	4	4	4	4
Develop qualifications and curricula	4	4	4		4	
Develop competency testing	4	4	4		4	
Administer tests	4	4	4	4	4	4
Accredit learning institutions	4	4	4			
Certify individuals	4	4	4	4	4	4
Certify organizations	4	4	4	4		
Quality assurance	4	4	4	4		4
Source: HKS & A						

Any group or committee that is formed in the aviation maintenance industry to oversee the development, administration, and recommend approval of specialist standards to the **FAA** has several examples to draw upon. Using the experience and common guidelines of organizations described in this section should provide insight into the preparation of an **ARS-I** standards development process.

## 13.7 ADVANCED SKILL SPECIALISTS

Specialists have been working in the aviation maintenance industry from its inception. They focus on tasks that require specialized skills, training and qualification; complex operations requiring specific test equipment and tooling; or where continuing hands-on work is necessary to maintain proficiency. The Aircraft Electronics Association (AEA) estimates approximately 36,000 specialists are employed by the more than 3,780 Part 145 repair stations in the U.S. An additional 15,000 specialists are estimated to be working in other areas of the industry, according to data presented in the Blue Ribbon Panel report. The demand for specialists will continue to increase as technology advances, the industry grows, and competition builds for qualified, skilled workers.

Globalization of aviation maintenance also effects specialization. The generalist and specialist categories for maintenance personnel are recognized and used throughout the world. International rules and regulations being developed through harmonization efforts will recognize both categories. The **FAA**, based on discussions with international regulatory agencies and input provided through the **ARAC** process, is committed to broadening the scope of specialist training, qualification, and certification.

In this chapter, we will describe the **ARAC-65** working group's proposed specialty categories and training programs for the **ARS**.

## 13.7.1 ARS Classifications

The **ARAC-65** working group discussed several issues pertaining to specialist certification and concluded that a new certification process needs to be developed. Since the membership is composed of an industry cross-section, their views are representative of the industry's thinking on this subject.

In Chapter III, we described the proposed rule changes to Part 65 and the major elements of the generalist and specialist certificates (see **Figure 13.5**). The current repairman certificate, as previously noted, is based on Part 65 and issued by the **FAA** to individuals who are qualified to accomplish specific maintenance tasks for Part 121 and Part 135 operators and Part 145 certificated repair stations. The certificates are also issued to individuals constructing their own amateur-built aircraft.

The repairman certificate will have its title changed to Aviation Repair Specialist (ARS) and have three classification levels under the proposed Part 66. The new certification may grant specific maintenance and repair privileges to individuals in three classifications, as follows:

- **ARS-I**-May be issued by the **FAA** to an individual based upon his or her completion of an acceptable industry developed standards-based training curriculum which includes appropriate competency testing and/or validation. The individual who has earned the ARS-I certification may only exercise these privileges while employed by a Part 145 certificated repair station, Part 121 operator, or Part 135 operator. This provides portability for this level of certification. The ARS-I certification skill areas will be provided for in the new Part 66 and in subsequent FAA policy and advisory material. Additional skill areas may be defined through industry input to the FAA, the JTA study, or as part of the international regulatory harmonization effort.
- **ARS-II**-Duplicates the current repairman certificate and may be issued under regulations very similar to those currently found in Part 65, Subpart E, 65.101. Individuals receiving the ARS-II certificate will be qualified to perform maintenance on aircraft or components appropriate to the job for which they are employed. The ARS-II certification is through an **AMO**. The individual must be employed by an **FAA** certificated repair station, or an FAA certificated air carrier that has a continuing airworthiness program.
- **ARS-III**-Issued by the **FAA** to amateur aircraft builders as currently described in Part 65, Subpart E, 65.104. As in the past, ARS-III certificated holders would be the primary builders of amateur aircraft for their own non commercial use.

## 13.7.2 Proposed Specialty Categories

The **ARAC-65** working group proposed that **ARS-I** certification should be based on nationally and internationally recognized standards developed by the aviation maintenance industry. The working group proposed four skill areas for ARS-I certification. The four specialty categories are:

- Aircraft electronics (avionics)
- Composite structural repair
- Metal structures repair
- Nondestructive inspection.

Selection of the categories was validated in part by the **JTA** study completed last year. Data collected on 23 task elements that represent a cross-section of **AMT** job assignments served to verify four of the **ARS-I** categories selected. When compared with other tasks, those involving aircraft electronics, composite structural repair, and metal structures repair were rated as the most difficult to learn and required in-depth training, specific technical knowledge, and extensive experience and practice.

A significant amount of work has already been completed with respect to development of training, qualification, and certification standards in the categories selected. In some cases, existing standards of professional associations are applicable to **ARS-I** specialty categories. One or more of these standards may be approved for **ARS** certification-and, more than one standard may be approved in a specific category. Moreover, multiple organizations may provide standards for a category; for example, the **ATA** Specification 105 and the **ASNT-TC-1A**, MIL-STD-410 standard for **NDI** are possible candidates for this specialty category.

### **Aircraft Electronics**

In its broadest definition, aircraft electronics (i.e., avionics) encompasses all aircraft electrical and electronic systems and their components. The term avionics now goes well-beyond a definition that once included only communication, navigation and auto-flight systems.

One of the major changes in today's aircraft is the extensive use of digital electronic data processors, computers, electronic controls, and fly-by-wire technology. From a systems standpoint, aircraft have become fully integrated. While additional emphasis is placed on electronics in the proposed **AMT(T)** rating, industry support is also strong for an **ARS-I** certification in aircraft electronics. Maintenance, repair and alteration of electronic systems requires a highly specialized set of knowledge and skills beyond **AMT** and **AMT(T)** requirements.

The Association for Avionics Education (AAE), with the support of the Aircraft Electronics Association (AEA), is in the process of developing a training and qualification **ARS-I** standard for aviation electronics technicians. Their working documents were presented to **ARAC-65** on

two occasions for review and comment. The initial input was to develop a separate avionics rating to be issued in the same context as **AMT** or **AMT(T)** certification. The ARAC-65 group agreed that while there should not be a separate avionics rating on the AMT certificate, the licensing of avionics personnel could be done as an ARS-1 specialty category. They encouraged AAE to continue their standards development process, addressing aircraft electronics as an ARS-I certification.

There are other industry standards for electronic technicians, such as those developed by the Electronics Technicians Association International (ETA) and described in **Chapter V**. Under **FCC** regulations, there is a certification process governing the radio and telephone operators licenses. The FCC certification is presently used by many operators and repair stations as qualification for specialists who perform avionics maintenance, repair, and modification. Neither the ETA nor FCC certification regulations, however, are specific to aviation; these standards do not address the technology as it applies to aircraft or to any of the **FAA** regulations as they apply to maintenance and repair. For these reasons, the **ARAC-65** working group and the FAA conclude that the industry is better served with an **ARS-I** certification specifically designed for aircraft electronics.

### **Composite Structural Repair**

Composites are nonmetallic structures that include materials, such as fiberglass, carbon fiber, or graphite filament. They are usually chemically compounded or laminated with resins and bonded to metal or other composite support structures with adhesives to make light weight, non corroding, high-strength aircraft structural components. Composite parts are typically formed and cured under heat and vacuum. Special equipment and working environments are required to construct or repair composite structures, and specific skills are necessary for appropriate handling and repair techniques. Improper handling of materials can lead to extensive damage and environmental hazards.

In general, the use of composite materials in aircraft construction, particularly transport aircraft, is increasing. Some light aircraft have all composite airframes. Composite structural repair is a complex and highly specialized segment of aviation maintenance. The knowledge and skills necessary to undertake major composite repair and alterations activity could require expertise beyond **AMT** and **AMT(T)** training requirements.

The Commercial Aircraft Composite Repair Committee (CACRC) is an international organization and is sponsored by both industry and Society of Automotive Engineering (SAE). They are in process of developing a standard for an **ARS-I** composite structures repair specialty category. **ATA**'s Specification 105 for **NDI** is being used as a format model. Membership in the organization includes representatives from air carriers, airframe manufacturers, Part 145 repair stations, academia as well as from the European aviation maintenance community. CACRC has been developing their standards for more than three years. The group is also close to the release of drafts that will include additional standards for composite materials handling; preventive maintenance; inspection, repair, alteration, and fabrication; and application of protective coatings.

### **Metal Structures Repair**

Aircraft structure maintenance, repair, and modification are areas of increasing focus and concern. Several factors have caused change in both work content and personnel specialization within this segment of the industry. The need to reduce operating costs has caused air carriers to conduct business differently:

- Increasing amounts of modification and repair work (up to and including D check level) are being accomplished by second- and third-party maintenance providers.
- The number of aircraft classified as aging is increasing. By definition and structural status, these aircraft require extensive structural inspections, repairs, and modifications in order to remain operational.
- The size of the leased aircraft fleet is at an all time high, with continued growth forecast for the future. Leased aircraft move from operator to operator and are maintained by various **AMOs** around the world.
- Many airframe sheet metal specialists are not certificated. A majority of sheet metal specialists work in Part 145 certified repair stations performing heavy maintenance and modification.
- A high percentage of work done by second- and third-party maintenance providers is competitively bid; workload for these operations is cyclical with variable staffing demands. A significant number of temporary contract aircraft maintenance personnel agencies whose workers are assigned by contract to operators worldwide have entered the business. Temporary workers are transient, moving from company to company and place to place, as needed. Many are noncertificated structures specialists with training, qualifications, and backgrounds supported only by resumes and references. This could present a problem with the non-uniformity of skills.

An independent Structures Repair Committee (SRC) was formed by several participants involved in the **CACRC**. SRC is presently developing a standard for aircraft metal structures repair specialists. Their objective is to create a document describing the appropriate training, qualifications, and certification of an **ARS-I** aircraft metal structures repair. Final draft of the document is scheduled in 1996.

The Canadian Aviation Maintenance Council (CAMC) has developed an aviation structures repair specialist standard. It prescribes qualification standards for personnel performing aircraft structural repair, including composites. The CAMC standard is comprehensive and includes the basic curriculum, qualification, and certification elements necessary to qualify for review as a potential **ARS-I** certification standard. (A more detailed discussion of CAMC is presented in Chapter VII.)

## **Nondestructive Inspection**

NDI is a highly specialized skill area requiring the use of sophisticated tooling and diagnostic test equipment to detect defects and flaws. Technology ranges from magnetic particle and dye penetrant methods through x-ray, ultrasonic, eddy current and some currently emerging technologies. The technician is responsible for the setup and operation of these systems, in addition to the reading and interpretation of the results. Competency in NDI requires a high degree of both knowledge and skill, and proficiency requires a considerable amount of continuous hands-on practice and recurrent training.

The document for **ATA's** Specification 105, *Guidelines for Non Destructive Inspection*, includes training curricula for various **NDI** processes and associated inspection techniques. Qualification standards for NDI personnel are also included. The ATA Specification 105 document is highly respected; it was developed with input from all elements of the aviation manufacturing and maintenance industry.

**ASNT** standards have been in place for many years. They are kept current with state-of-the-art processes and emerging technology. These standards specify training, qualification, and industry certification in each of the **NDI** processes from dye penetrant to the most complex radiography. ASNT standards are recognized by several industries other than air transport and are considered as one of the best examples in standards development.

While there are two other standards also recognized in the **NDI** discipline, the aviation industry generally recognizes both the **ATA** Specification 105 and **ASNT** as the baseline. One or more of these could become standards accepted by the **FAA** for **ARS-I** certification.

## **Other Potential Skill Areas**

While the **ARAC-65** working group and the **FAA** may be considering the four **ARS-I** categories selected as representing primary areas of focus, other categories could be added in the future. The **JTA** final report may identify the need for additional ARS-I categories. Technological advances, industry experience, and the supply and demand of qualified technicians will be major determinants of future categories.

### **13.7.3 Qualification and Certification**

Qualification is a set of requirements on which a certification is based. Qualifications serve to affirm that an individual has met a set of knowledge and skill standards to an acceptable level. Certification, usually granted by a governmental regulatory agency, is a license conferring a privilege that confirms an individual's qualifications to practice or perform work.

Certifications granted by the **FAA** to operators and individuals who perform maintenance have specific qualification requirements. In situations where persons performing maintenance are not individually certificated and work under an operator's certificate, they are required to be qualified through internal, manufacturer, or other training acceptable to the FAA.

One of the elements of the **ARS-I** system is individual certification where privileges are granted through the **AMO** employer. Persons who are certified on an individual basis may share a

broader responsibility than persons who work only under an operator's certificate. This also increases the individual's level of accountability.

The most important of these two elements for aviation maintenance is qualifications. If for some reason the **ARS-I** system is not included in the final Part 66 rule, the process of qualification standards being developed by industry will remain. The concept of generalists and specialists is central to the **FAA's** aviation rule making policies. Even if individual certification under ARS-I is not adopted, the FAA will continue to promote **ARS** qualifications based on industry developed and maintained standards.

### 13.7.4 Training Curriculum

The training curriculum is the central element of standards describing the training, qualification, and certification of aviation specialists. The curriculum reflects the knowledge, skill, and experience requirements necessary to gain certification. Those standards currently used in the aviation industry encompass comprehensive curricula describing all elements and requirements for qualification and certification.

Curriculum development must be comprehensive to ensure that all knowledge and skill requirements are included. An excellent example of curriculum development was undertaken by the industry task team for the transport (T) element of the new Part 66 **AMT** certification.

**Table 13.8 AMT(T) Subjects: Electrical And Electronics**

Code	Subject	Hours	Preferred Teaching Method (1)	Objectives (2)
EE01	Built in test Equipment (BITE)	8	L/D, CBT, VDO	a,b,c,g,i,j,m
EE02	Analog, digital/discrete signals, logic gates	16	L/D, SHP	a,b,g,m
EE03	Electro-Static Devices (ESD)	4	L/D, CBT, VDO	a,b,c,d,g
EE04	LVDT's and RVDT's	8	L/D, CBT, SHP	a,c,d,k,m
EE05	Coax repairs, splices, and terminations	16	L/D, SHP	a,b,c,d,e,g,j
EE06	Wiring and schematic diagrams, ATA 20 Specification	20	L/D, CBT, SHP	b,c,g
EE07	Test equipment	24	L/D, SHP	a,g,I,j,k,m,
EE08	Wiring connectors, plug installation and repair	16	L/D, SHP	a,b,c,e,g
EE09	Synchro theory, differential resolvers, transolvers	8	L/D, SHP	a,j
EE10	Autopilot, flight directors, autoland, autothrottle	24	L/D, CBT, VDO	a,b,c,j,m
EE11	Inertial reference, navigation systems and GPS	24	L/D, CBT, VDO	a,c,d
EE12	<b>EICAS, EFIS</b> , EHSI	16	L/D, CBT, VDO	a,d,j,m
EE13	Gyros (Laser and conventional)	6	L/D, CBT, VDO	a,b,j,m
EE14	Flight Management Systems	8	L/D, CBT, VDO	a,c,
EE15	Instrument warning systems and comparators	4	L/D, CBT, VDO	a,b,c
EE16	Communication - VHF, HF, Satellite, Voice/Flt Recorder	16	L/D, CBT, SHP	a,b,c,d,m
EE17	Windshear	3	L/D, CBT, VDO	a,b
EE18	TCAS	3	L/D, CBT, VDO	a



EE19	ACARS	2	L/D, CBT	a,d,i,m
EE20	<b>ARINC</b> definitions and standards	3	L/D	a
<b>Total Manhours</b>		<b>229</b>		
<b>Powerplant Systems</b>				
<b>Code</b>	<b>Subject</b>	<b>Hours</b>	<b>Preferred Teaching Method (1)</b>	<b>Objectives (2)</b>
PP01	Electronic controls and thrust management systems	16	L/D, CBT, VDO	a,b,c,d,j
PP02	Blade damage assessment	8	L/D, VDO, SHP	a,c,e,g,h
PP03	Jet blast safety	2	L/D, CBT, VDO	a,b,d
PP04	APU systems and interface	16	L/D, CBT, VDO, SHP	a,b,c,d,e,f,g,l,m
PP05	Borescope	16	L/D, VDO, SHP	
<b>Total Manhours</b>		<b>58</b>		
<b>(1) Preferred Teaching Method</b>		<b>(3) Objectives</b>		
L/D = Lecture/Demonstration		a=Explain location and operation		
CBT = Computer Based Training		b=Explain hazards/warning/cautions		
VDO = Video		c=Locate information in manuals		
SHP = Shop Practical		d=Locate, identify, access components		
		e=Determine approved repair		
		f=service systems/components		
		g=Demonstrate task		
		j=Evaluate damage		
		i=Check system		
		j=Test system		
		k=Calibrate system		
		l=Operate and manage system		

The **ATA** Maintenance Training Subcommittee Part 65 task group consisted of air transport maintenance training and Part 147 **AMT** school leaders. Using course guidelines developed in the ATA Specification 104, the team set out to define the elements of knowledge and skill required for basic competency in air transport aircraft. After identifying all tasks required in air transport maintenance that were over and above basic AMT work, they developed a set of competencies and performance objectives for each task. The result was a set of tasks describing knowledge and skill requirements, including performance objectives, that clearly defined the **AMT(T)** training objectives.

**Table 13.9 AMT(T) SUBJECTS: Manuals and Publications**

<b>Code</b>	<b>Subject</b>	<b>Hours</b>	<b>Preferred Teaching Method (1)</b>	<b>Objectives (2)</b>
MP01	Illustrated Parts Catalog	8	L/D	a,c,g
MP02	Maintenance manuals	8	L/D	a,c
MP03	Fault Reporting and isolation Manual (FRM & FIM)	4	L/D, CBT	c,g



MP04	MEL/CDL/ <b>DDPG</b>	6	L/D	b,c
MP05	Structural Repair Manual (SRM)	16	L/D, CBT,VDO,SHP	a,c,e,g
MP06	General Maintenance Manuals	8	L/D,SHP	a,c
MP07	Cold weather operation manual	8	L/D,VDO	a,bn,c
MP08	Component overhaul manual	4	L/D,SHP	c
MP09	Weight and balance	3	L/D	b,c
MP10	Fueling	4	L/D,VDO	a,b,c
<b>Total Manhours</b>		<b>69</b>		
<b>Environmental/Aviation Safety/General</b>				
Code	Subject	Hours	Preferred Teaching Method (1)	Objectives (2)
EV01	MSDS Sheets	6	L/D,SHP	a,b,c
EV02	Aircraft Safety Practices	4	L/D,VDO,SHP	a,b,c,g
EV03	Hazardous material handling	8	L/D,VDO	a,b,c
EV04	Ramp and airport safety	4	L/D,VDO	b
EV05	Confined space entry	3	L/D,VDO,SHP	a,b,c,g
EV06	Parts handling and certification	8	L/D	b,c,g
EV07	Basic Troubleshooting Principles	24	L/D,CBT,SHP	b,c,g,I,j,m
EV08	<b>ETOPS</b>	4	L/D	a,c
EV09	<b>OSHA</b> Regulations	8	L/D	b,c
<b>Total Manhours</b>		<b>69</b>		
<b>(1) Preferred Teaching Method</b>		<b>(3) Objectives</b>		
L/D = Lecture/Demonstration		a=Explain location and operation		
CBT = Computer Based Training		b=Explain hazards/warning/cautions		
VDO = Video		c=Locate information in manuals		
SHP = Shop Practical		d=Locate, identify, access components		
		e=Determine approved repair		
		f=service systems/components		
		g=Demonstrate task		
		j=Evaluate damage		
		i=Check system		
		j=Test system		
		k=Calibrate system		
		l=Operate and manage system		

When this work was presented to the **ARAC-65** working group, the review and approval moved quickly. The curriculum for **AMT(T)** was adopted without change. While AMT(T) is not a stand-alone specialty, the standard on which it is based was developed through a rigorous process that can be applied to ARS-I. **Tables 13.8** through **13.10** show three examples of the six AMT(T) subjects and their related course of study. **Table 13.11** summarizes the estimated hours

and number of subjects required to master each of the six specific AMT(T) subjects.

<b>Table 13.10 AMT(T) SUBJECTS: Sheet Metal And Structural Repair</b>				
<b>Code</b>	<b>Subject</b>	<b>Hours</b>	<b>Preferred Teaching Method (1)</b>	<b>Objectives (2)</b>
SM01	Corrosion detection and treatment	6	L/D,VDO,SHP	a,b,c,e,g,h
SM02	Damage assessment	12	L/D,VDO,SHP	c,e,g,h
SM03	Fasteners and fastener substitution	8	L/D,SHP	a,b,c
SM04	Blueprint reading	8	L/D,SHP	c,g
SM05	Engineering Orders	4	L/D	a,g
SM06	Control surface balancing	4	L/D,SHP	b,c
SM07	Typical stringer splice and lap joint repair	16	L/D,VDO,SHP	a,c,e,g,h
SM08	Material specifications	4	L/D	c
SM09	Repair layout	16	L/D,SHP	a,c,e,g,h
SM10	Cold working, shot peening, roto peening, heat treating	8	L/D,SHP	b,c,e,g
<b>Total Manhours</b>		<b>86</b>		
<b>Composite Repair</b>				
<b>Code</b>	<b>Subject</b>	<b>Hours</b>	<b>Preferred Teaching Method (1)</b>	<b>Objectives (2)</b>
CR01	Damage assessment and Structural Repair Manual	12	L/D,VDO,SHP	a,b,c,e,g,h
CR02	Fasteners and fastener substitution	8	L/D,SHP	a,b,c
CR03	Adhesives, sealants, compounds	4	L/D,SHP	b,c,e,g
CR04	Overlay repairs	8	L/D,VDO,SHP	b,c,e,g,h
CR05	Hot bonding	16	L/D,VDO,SHP	b,c,e,g,h
CR06	Honeycomb	8	L/D,VDO,SHP	b,c,d,e,g,h
CR07	Composite materials	6	L/D,VDO,SHP	a,b,c,f,h
<b>Total Manhours</b>		<b>62</b>		
<b>(1) Preferred Teaching Method</b>		<b>(3) Objectives</b>		
L/D = Lecture/Demonstration		a=Explain location and operation		
CBT = Computer Based Training		b=Explain hazards/warning/cautions		
VDO = Video		c=Locate information in manuals		
SHP = Shop Practical		d=Locate, identify, access components		
		e=Determine approved repair		
		f=service systems/components		
		g=Demonstrate task		
		j=Evaluate damage		
		i=Check system		
		j=Test system		
		k=Calibrate system		
		l=Operate and manage system		

Other industry groups developing specialist standards are using similar techniques. As these

standards are complete, they will form the basis from which qualifications can be established and certification guidelines prepared for the specialist categories in the new Part 66.

<b>Table 13.11 Estimated Learning Time to Master Amt(T) Subjects</b>		
<b>Category</b>	<b>Number of Subjects</b>	<b>Total Hours</b>
Electrical and electronics	20	229
Powerplant systems	5	58
Sheet metal and structural repair	10	86
Composite repair	7	62
Manuals and publications	10	69
Environmental/ aviation safety/general	9	69
Total	61	573
Source: <b>ATA</b> Maintenance Training Subcommittee		

## 13.8 INDUSTRY ADVISORY COUNCIL

Industry standards for the training, qualification, and certification of **ARS-I**, or other specialist categories, will be developed by various industry organizations. It is possible that more than one standard may apply to a specific category-**NDI**, for example, has at least three standards that may qualify. The **FAA** does not wish to direct the process of industry standards development. Its role would be to consider standards that have been developed by industry and possibly apply them as a basis for ARS-I certification.

Currently, there is no professional organization, specific to the U.S. aviation maintenance industry, prepared to serve in a neutral capacity as the central clearing house for **ARS** standards. An organization of this kind was recently developed in Canada and includes several elements, both in its structure and function, applicable to a U.S. system.

This chapter first examines alternative approaches to establishing an **ARS** standards process and then reviews the process implemented in Canada. Finally, we discuss how an umbrella organization-or steering group-could be established, developed and operated in the U.S.

### 13.8.1 Alternative Approaches

Several options for the training, qualification, and certification of aviation specialists were explored. A combination of the options will likely emerge as the basis for a new certification system. Each option has its benefits and cost, and requires a different approach to the solution.

Government and industry are in agreement that: (1) individuals who work on aircraft must be qualified and competent in order to maintain a safe air transportation system and (2) a system ensuring individual competency must be in place.

**Status Quo.** One alternative is to leave the current system alone. Some in the industry propose this solution. They argue that what we have is working and that the proposed specialist certification should be voluntary. They claim little motivation exists for people to seek out ARS certification over current practices of certified repair stations.

The advantage of this option is no additional cost. The disadvantage arises from the fact that nothing changes or improves. If the goal of industry and government is to promote higher work standards than are currently met, as documented in recent studies, then changes in the system should be made.

**Establish New FAA Standards.** Another alternative is to establish **FAA** standards for the training, qualification, testing, and certification of specialists, comparable to the process currently used for **A & Ps**. This may require a new rule similar to Part 147 or inclusion of specialists in this rule. Considerable time would be required to establish the standards and implement the necessary regulatory changes. Moreover, a significant amount of administrative effort would be needed to create and maintain the appropriate records, standard setting, testing, and communications. The critical competencies related to the specialty under consideration are:

- Regulatory compliance
- Fundamental principles knowledge
- Basic skills
- Demonstrated proficiency.

Standards for applicable regulations must first be identified before curriculum standards can be determined. One of the problems with curriculum standards is that the specialty areas are all subject to rapidly changing technology. If the requirements are too specific, they will be difficult to revise. Another problem with specific curriculum content requirements is that some people from another industry can bring high levels of experience and knowledge to an aviation specialty. If such people have to take extensive training that is redundant to their level of skill developed in another industry, then they might be discouraged from joining the aviation workforce.

The certification process needs to provide a way to determine if the applicant has sufficient experience and knowledge to successfully demonstrate his or her skills. There must be evidence that the applicant understands the **FAA** regulations applicable to the specialty for which he or she is requesting certification. Furthermore, the applicant must demonstrate the capability to follow typical industry task instructions and use reference information.

For specialists, performance testing is important to the certification process. Since performance evaluations are time consuming to administer, such testing would likely be administered by the training organizations. This approach is consistent with current practices in both flight and

maintenance qualification training and adds no additional administrative burden or costs to the **FAA**. The advantage of testing to show competency by demonstration assures that individuals are qualified to accomplish specific tasks. The disadvantage is that competency validation tests are more complicated and time-consuming and could possibly incur higher costs. However the cost of this testing, as with other industries, may be charged as a fee to the individuals becoming certificated.

**Use Practices From Other Industries.** A third alternative is to use existing specialty standards from other associations or organizations under the oversight of an independent industry board. The various industry approaches to standards and certification, both regulated and nonregulated, are described in Section V. One of the more interesting approaches, and perhaps the most applicable to the **ARS-I**, is the National Institute for Automotive Service Excellence (ASE) standard process.

The **ASE** certification is voluntary for technicians and schools seeking ASE approval. The driving force behind the motivation for individual participation in the ASE program is the opportunity to become more employable. A technician without an ASE certification may have no evidence of his or her skills. Additionally, service organizations with a majority of ASE-rated technicians in their workforce can gain status among customers.

Since **ASE** is an evaluating body, it doesn't directly provide advice about program content and standards for schools. A sister organization, the National Automotive Technician Education Foundation (NATEF), conducts research and creates curriculum standards and certification evaluation of schools. Specialists in the industry along with the manufacturers provide the support to set standards. These standards are then used by the NATEF to examine schools for certification.

**ASE** and **NATEF** are effective organizations with processes in place to keep standards reasonably current with changing technology. Participation by industry experts and manufacturers is a key element to the success of ASE and NATEF. A similar approach may serve the air transportation industry's maintenance efforts.

**Create an Oversight ("Umbrella") Organization.** The formation of an aviation maintenance advisory council to help guide the regulation of specialists has been suggested. Such an organization would be made up of representatives of the **FAA**, industry experts, associations, and manufacturers. With advice from the council, the industry could use the standards of associations-either existing or being developed-as the principal guidelines for **ARS** standards. When combined with FAA certification and registration, including regulatory compliance, the best of both worlds could be achieved. Elements of an aviation maintenance advisory council are discussed later in this section.

## 13.8.2 Canadian Aviation Maintenance Council

Sponsored by Employment and Immigration Canada, the Canadian Aviation Maintenance Council (CAMC) was established in 1992 following the recommendations in the study, *Human Resources in the Canadian Aircraft Maintenance Industry*. The report expressed concern about the continuing availability of qualified workers for the Canadian aviation maintenance industry.

The **CAMC** was created as a professional organization dedicated to the development and management of a number of nationally recognized competency-based aviation specialist occupational standards. Its objectives, as stated in their introductory pamphlet, are as follows:

*The council was created to address challenges facing the industry. These challenges were identified in a comprehensive human resource study prepared for the industry that included:*

- *The need to overcome the lack of formal training programs available for non-licensed skilled trades persons*
- *The need to meet ever-rising requirements for the entry into skilled trades*
- *The need to establish criteria to recognize skills of the aircraft maintenance workers*
- *The need to increase retention of new recruits especially among smaller employers.*

*The **CAMC** is a decision-making body. It manages current business, sets specific objectives, policies and procedures, and coordinates the efforts of various committees. The committees cover topics such as occupational standard, training programs, communications and financing, among others. The Council supports and encourages initiatives to develop the overall strength and economic well being of the Canadian Aviation Maintenance Industry both locally and internationally.*

The **CAMC** also develops and establishes training programs, including human resources planning and the recruitment of new entrants into the industry. Their objectives are achieved with the participation, cooperation and support of the Canadian aviation maintenance industry.

The **CAMC** was funded on a declining federal government contribution for the first three years and achieved self-sufficiency through industry and membership support in late 1995. The Canadian government has invested more than CAN\$4 million in the CAMC and plans to invest an additional CAN\$3 million (plus industry matching funds) in ongoing specialist standards and curriculum development projects.

Membership of the group covers the industry spectrum and an equal number of employer and employee organizations are represented. These include:

- Air Transport Association of Canada
- Aerospace Industry Association of Canada

- Canadian Auto Workers
- International Association of Machinist and Aerospace Workers
- Canadian Federation of **AME** Associations.

The **CAMC** has identified 22 occupational areas and is currently developing occupational standards for the following 13 aviation maintenance skills:

- Aviation structural repair
- Aviation gas turbine repair & overhaul
- Aviation welding
- Aviation **NDI**
- Aviation machinist
- Aviation electronic and electrical component shop
- Aviation mechanical component shop
- Aircraft maintenance technician\*
- Avionics maintenance technician\*\*
- Aircraft interior refinishing
- Aviation special processes
- Aviation painters
- Aviation reciprocating engines and propellers
- Nine additional identified skills may be added

A technical committee, comprised of industry experts, has been established for each skill area (or trade). These individuals work in teams, facilitated by **CAMC** staff, to develop standards based on task analysis and experience. CAMC is supported by a full-time staff of seven and an additional person on loan from the armed forces. The activities of CAMC, as outlined in 10 initiatives, are summarized below:

- Initiative 1: Establish itself as a professional organization dedicated to the development and management of a national competency-based standard for aviation maintenance trades. These standards identify the scope of each occupation, the tasks and subtasks that must be accomplished by the specialists, and, finally, the required knowledge and skills the specialists must possess in order to proficiently, effectively and safely carry out their duties. The council has leveraged a small amount of public resources resulting in a national training commitment by the industry.
- Initiative 2: Administer a workforce registration program through a registration board composed of industry volunteers. This program will attest to specialist skill, knowledge, and ability to perform in certain key tasks, as defined in the occupational standard. The program includes the registration of new entrants to the workforce and the grandparenting of existing workers, both in the commercial and military sectors.
- Initiative 3: Direct the development of detailed curricula for each aviation maintenance occupation to be used by post-secondary training institutes and employer-based training departments. The documentation consists of details about how the content must be taught. This document accompanies the

curricula and facilitates compliance with the standard by the institutions, providing detailed course profile, course outlines, and instructor guides. The curricula is designed in modules to reduce the cross-training time as specialists are transferred to other occupations within a firm.

- Initiative 4: Develop detailed policies and procedures for the accreditation of programs that meet the curricula to be administered by industry volunteers. The graduates from these programs will be recognized through the implementation of a national examination program prior to the undertaking a structured on-the-job training phase. Programs delivered by community colleges, employer training departments, or other specialized training organizations will be eligible for accreditation if these programs meet, as a minimum, the **CAMC** published curricula.
- Initiative 5: Establish National Standing Trade Advisory committees, composed of industry practitioners or each occupation, responsible for maintaining and updating aviation maintenance standards. Recurrent training programs are developed for each trade in order to ensure that specialists remain current with technological developments.
- Initiatives 6 to 9: Address procedures for recruiting youth into the industry, communications, industry and education partnerships, and include procedures for industry-wide human resource planning and development.
- Initiative 10: Establish a process to become financially self-sufficient. The council was initially funded on a declining federal government contribution over three years. In order to achieve self-sufficiency status, the council established a number of revenue generating activities to fund the council. These include fees from corporate memberships, registration of practitioners in the workforce, sale of curriculums and program accreditation.

The Canadian aviation regulatory and certification system is the responsibility of Transport Canada (TC), their equivalent of the U.S. **FAA**. While similar to the U.S. system in many ways, the Canadian aviation maintenance industry is significantly smaller than in the USA. **Table 13.12** presents estimates of the current aviation maintenance workforce in the U.S. and Canada.

<b>Table 13.12 Aviation Maintenance Industry Workforce For The U.S. and Canada</b>	
<b>Canada</b>	<b>United States</b>
Licensed aviation maintenance	Certificated aviation maintenance



workers:	workers:
11,200	80,000 (estimate)
Nonlicensed production workers:	Noncertificated specialists:
23,000	68,000 (estimate)
Total workforce:	Total workforce:
34,200	148,000 (estimate)
Source: FAA, Transport Canada, and HKS & A	

**TC** recently revised its **AME** certification process, moving to a system similar to the **FAA** and away from British / **ICAO**'s standards and practices that were the primary guidelines for their previous system.

The Canadian Aviation Regulation Advisory Council (CARAC) has a working group on maintenance certification and control whose activities are similar to the **ARAC-65** working group. In general, the Canadians are moving toward broader **AME** licensing privileges and specialist privileges, and it appears their certification process will become even more similar than it currently is to that of the **FAA**. **CAMC** qualified specialists, however, will not be licensed and thus requires a highly structured environment for selecting specialists.

There are apprenticeship programs for individuals who wish to become aviation maintenance engineer (AME) certified. Individuals in the program are under the supervision of a qualified trades-person learning the principles, skills, tools, and materials of the trade while observing, practicing, and accomplishing work. They must also attend technical courses offered through colleges or technical institutes.

**CAMC** has no regulatory function nor does **TC** issue licenses based upon CAMC certification. Working in cooperation with TC in standards development, the certifications issued by CAMC are approved as qualifications to perform work in **AMOs**. TC regulations (as with the **FAA**'s) provide that specialists can only perform work; they do not have return to service privileges.

**TC** issues technical certification with an "E" license similar to the current **FAA** mechanic license with powerplant "P" privileges. There are three skill categories; avionics (aviation electronics), structures (includes composite), and propulsion (powerplant and propeller). These licenses provide the holder with the privilege of performing work in an **AMO**. The license also allows individuals to work on their own under the direction of an AMO. The Canadian generalist licenses are similar to FAA's, since all E license privileges are included in the **AME** certification; M1 is equivalent to the proposed **AMT**, and M2 is equivalent to the proposed **AMT(T)** (as previously described in section IV).

Since **TC** and the **FAA** share similar objectives relative to specialists, the relationship between TC and **CAMC** provides an excellent example of industry and government partnership in the training, qualification and certification of skilled specialists.

### 13.8.3 Elements of a U.S. Aviation Industry Maintenance Skills Organization

Currently, there is no independent impartial organization to oversee aviation maintenance skills standards for specialist certification in the U.S. As previously mentioned, several organizations have developed standards that may be applicable to certification, but none evaluate these standards and make recommendations to the **FAA** as to their content and applicability. A few organizations have specialist standards under development but without a system in place for their review and approval, other than the FAA. The FAA, wishing to maintain partnership with industry, believes industry should accept the role of standards review and approval recommendation.

The **FAA** may consider the **ARS** certification based on the individual's qualifications to an industry standard. In order for this to occur, an umbrella organization needs to be established. The purpose of this organization would be to review the training and qualification standards developed by industry groups and make approval recommendations to the FAA after standards have met acceptance requirements. The organization could possibly become an extension of an existing group with ties to specialties, such as **CACRC**, or developed as a new group.

Any U.S. system could not depend on government funding and would need to operate on internally generated funding and voluntary industry support. The current **ARAC** process is an example of how such an organization could be established.

**AIMSAC Concept.** For the purpose of this discussion, we name the proposed new organization "the Aviation Industry Maintenance Standards Advisory Council" (AIMSAC). AIMSAC's function would be to evaluate standards guidelines and the training curriculum for qualification and certification of **ARS-I** by skill category.

The purpose of **AIMSAC** would be to assure that various technical specialties have standards fostering high qualification of workers in the commercial air transport industry. The case has been made that changes in technology and business climate make it difficult to keep regulations current. A more flexible process of assuring and certifying specialists qualification is clearly needed. All segments of the industry that create the new technology and control maintenance business practices need to work together with the regulator to provide training, qualification, and certification standards. Representatives from industry, working through the various industry interest groups and professional organizations, would form the membership of the AIMSAC.

The **FAA** is ultimately responsible for assuring the traveling public of air transportation safety. The FAA does this through regulation, rules, and inspections. The public rule making processes are necessarily long-term and deliberate while the inventiveness of manufacturing, materials, and process developments are more rapid. It may be to the FAA's advantage to use industry's expertise to create training and certification standards relating to new materials, technology, and processes to stay current with changes.

An organization such as the **AIMSAC** would be in the best position to make recommendations to the **FAA** concerning the quality, suitability, and currency of skills standards. Industry typically seeks to use the most cost-efficient materials and processes. As such, they are often

highly motivated to take advantage of applicable technological developments. The best practice might be to base FAA certification on standards developed by those who are the most motivated to use current technology.

**AIMSAC Organization.** Representatives from **FAA**, air carrier, third-party maintenance organizations, and industry specialist standards associations, could make up the AIMSAC membership. These are subject matter experts who fully understand the aviation industry as well as the particular specialty they represent. Organization membership may include:

- Association for Avionics Education
- Aircraft Electronics Association
- Air Transport Association
- Aviation Repair Station Association
- Aviation Technician Education Council
- National Air Transport Association
- National Business Aircraft Association
- Professional Aviation Maintenance Association
- Regional Aircraft Association
- Society of Automotive Engineering.

**AIMSAC** would review development of training curricula, qualification, and certification standards submitted by each professional organization, including their plans to maintain the content and currency ("keeping the flame"). AIMSAC's mission would also be to review standards, recommend revisions (particularly in regard to meeting industry needs) and regulatory requirements, and recommend approval of accepted standards to the **FAA**.

Funding the **AIMSAC** process could come from membership organizations and in-kind contributions of individual's time and expertise. Professional associations could recover costs from accreditation and certification fees. The only added cost for the **FAA**, in addition to issuing certification to individuals qualifying to specialist standards, might be the expenditure of time to participate in AIMSAC and the standards approval process.

Given the amount of industry support to the **ARAC** process, it is reasonable to expect that an organization such as **AIMSAC** would also be supported. We believe it is in industry's best interest to extend the partnership with the **FAA** beyond rule making review and change. Details of the recommended process and structure of an AIMSAC type organization are discussed in Section VIII.

**Specialist Benefits.** **AIMSAC** would have no regulatory or enforcement authority with respect to **FAA** regulations. The current practice of FAA certifying airmen and **AMOs** would not change. What changes is the motivation of an individual to acquire training to qualify for a job in aviation maintenance.

Currently, a noncertificated person working in a repair facility can only produce a resume of his or her experience when seeking another job. Whether a potential employer values that experience depends upon the employer's perception of the last organization. If the perception is low, the applicant may not be hired, regardless of his or her real qualifications and capabilities. Similarly, a person new to aviation maintenance with no related experience may find it very difficult to get a start, regardless of his or her capabilities. A certificate of qualification indicating the successful completion of a standard curriculum and certification evaluation would make the holder much more employable.

This kind of approach to qualification would also reduce the cost of training to the **AMO** or air carrier. The employees would be highly motivated to become certificated since this would improve their chances for a job.

**Industry, Association, and Government Benefits.** The professional associations, e.g., **ASNT** have a stake in creating qualification and certification standards because they want to convince others of the skills and benefits of their organization. They band together for the good of their profession and to raise the stature of their skill area and those who practice it.

The **FAA's** role can be to add the perspective of the organization responsible for aviation industry safety and to assure that the standards include such areas as regulatory compliance. By leaving the existing certification processes in place, little additional FAA administrative effort or expense is required. Yet, the results will be better if the **AIMSAC** with the FAA's contributions reviews and recommends approving the standards of specialty schools, and administering qualification evaluations. The associations want comprehensive standards to enhance their profession so they will do their best to assure well-qualified graduates from specialist schools.

The industry will benefit because (1) individuals are motivated to acquire their own training and (2) higher qualifications help assure a higher level of safety. The **FAA** will benefit from this system because their end goal, a high level of safety through certification of **ARS**, is helped by the cooperative process. Moreover, the FAA would have approved industry standards to certify against.

## 13.9 CONCLUSIONS AND RECOMMENDATIONS

Our conclusions and recommendations reflect the course of action that will lead to the greatest improvement in the training, qualification, and certification of aviation specialists. Our recommendations introduce a process that can effectively carry out the changes proposed to current rules and regulations. We encourage a continued and strong interaction between the **FAA** and the aviation maintenance industry to ensure that the interests of all groups are met.

### 13.9.1 Industry Opinions and Preferences

The results of the **ARAC**-65 review confirmed industry support for specialist certification under Part 66. During our study, we found that a majority of the individuals interviewed were interested in the **ARS-I** certificate. These individuals, for the most part, also believed it was not necessary for all aviation maintenance personnel to hold **AMT** or **AMT (T)** certification.

Many individuals from the aviation maintenance industry also provided input about how the development and approval process of industry standards might be accomplished. The consensus opinion among those we interviewed was that the approval authority for any aviation maintenance standard belongs to the **FAA**. Most support the formation of an umbrella organization that would work in concert with the FAA to adopt and approve **ARS-1** standards. This group, comprised primarily of representatives from industry professional organizations, would serve as a clearing house and provide approval recommendations to the FAA.

### 13.9.2 Gaining Interest and Cooperation

An important element to the success of a certification system is to gain industry support and cooperation. We believe the development, approval, and continual update of professional standards for **ARS-1** will provide advantages for industry. Standards provide clear requirements for the training, qualification, and certification of the various specialty elements selected. The advantages that standards provide include professionalism, levels of proficiency, performance, and productivity of ARS-1 certificate holders.

Moving from today's system, where repairman certificates are dependent on employment experience at a particular **AMO**, to a system that has standards based on industry participation in development of standards will ensure:

- Uniform training and qualification requirements
- Meaningful competency testing and evaluation
- Higher professional standards for specialists
- Specific criteria for training providers and qualifying organizations
- Standards that remain in synchronization with current technology and industry practices
- Uniformity in specialist certification
- On-going partnership between industry and the **FAA**
- Higher number of certificated specialists

- Elevated stature of U.S. specialists in the global aviation community
- Higher level of compatibility to support global regulatory harmonization
- A supply of qualified specialists that meet industry requirements.

The introduction of a standards development process will need to highlight these advantages in order to gain necessary interest and support. Since any oversight or umbrella group members would serve on a volunteer basis, participation can only be achieved if industry sees benefits in supporting the effort.

### 13.9.3 Elements of an Advanced Skill Training, Qualification, and Certification process

Standards should be developed and kept current by those most interested in, and closest to, the specialty. Once a standard has been found acceptable by the **FAA**, it should be accessible by any institution or organization that wishes to apply it for certification purposes. The standards can be applied by organizations who want to be in the business of providing training for related skills, or **AMOs** that wish to create in-house training and certification programs.

**FAA** certification of a specialist indicates that the holder has met a specific set of industry standards and is qualified to perform work in a specific skill area. If the qualification processes are recognized by regulatory agencies and employers, the certificate holder will be better equipped for employment and career progression. Qualification must depend upon performance evaluations that provide solid evidence that the successful applicant possesses the knowledge and skills that lead to satisfactory job performance.

The critical part of using standards and industry certification to indicate qualification and ability to do a job is their acceptance by regulators and employers. There are several examples of how this is accomplished in other technical industries described in Section V.

While it is clear that the **FAA** is the only organization that may accept an **ARS-I** qualification standard for certification, the process leading up to approval may be accomplished in various ways. The approach that has the most merit within the industry is one where industry and the FAA work together in the development and operation of the standards review and approval processes. This points to the need for an umbrella organization that works with the FAA, manufacturers, employers, and professional associations to assure the most appropriate standards and certification methods are used.

**Table 13.13** lists the primary functions for the **FAA**, **AIMSAC** (see **Chapter VII**), and professional organizations in such a proposed integrated certification process.

<b>Table 13.13 Group Functions Of An Integrated Certification Process</b>		
<b>FAA</b>	<b>AIMSAC</b>	<b>Professional Associations</b>
• Accept AIMSAC	• Identify organizations	• Analyze specialty elements

recommended programs	qualified to develop and monitor standards	
<ul style="list-style-type: none"> <li>Issue individual <b>ARS-I</b> certificates</li> </ul>	<ul style="list-style-type: none"> <li>Identify new or potential future needs or qualification for other specialties</li> </ul>	<ul style="list-style-type: none"> <li>Determine experience requirements</li> </ul>
<ul style="list-style-type: none"> <li>Conduct regulatory surveillance applicable to ARS-I certificate holders</li> </ul>	<ul style="list-style-type: none"> <li>Evaluate and approve industry standards for the ARS</li> </ul>	<ul style="list-style-type: none"> <li>Establish training standard and core curriculum</li> </ul>
	<ul style="list-style-type: none"> <li>Recommend FAA acceptance of qualified organization's programs</li> </ul>	<ul style="list-style-type: none"> <li>Develop competency testing</li> </ul>
	<ul style="list-style-type: none"> <li>Implement communication programs</li> </ul>	<ul style="list-style-type: none"> <li>Conduct training provider accreditation</li> </ul>

### 13.9.4 Identify Organizations Qualified to Develop and Maintain Standards

Any organization should be allowed to submit **ARS-I** certification standards for evaluation by **AIMSAC**. As long as the standard submitted for approval meets the established criteria, and can be supported and maintained by the submitting organization, it may qualify for recommendation to the **FAA**. More than one organization's standard may qualify for approval in a particular specialty element. **NDI**, for example, may include **ASNT**, **ATA-105**, and **MIL-410** as approved standards for **ARS-I** certification.

#### Analyze Specialty Elements

Standards must be competency based within specific boundaries. There must be a clear understanding of the scope of the specialty. This can be accomplished only by conducting a thorough task analysis of the specialty. All tasks and subtasks must be identified and analyzed to determine the experience, knowledge, and skill required to accomplish each task.

Technical associations have been the most successful in completing such analyses; most have used similar processes based upon a team development approach. The team approach ensures balanced input and task credibility. Membership in such teams includes:

- A facilitator, usually a member of the standard sponsoring group
- Managers and supervisors who are active in the specialty
- Subject matter experts, actual practitioners who perform the specialty tasks
- A training or learning process specialist.

To identify the required tasks for successful specialty demonstration requires the effort to identify the scope of the specialist area. For some of the identified **ARS-I** specialties, this work is complete and for others, it is in progress. One of the tasks of any regulatory or advisory group concerned with assuring competency is that the analysis continues to be correct. Application by



any association to set the standards and curriculum must be evaluated against a required skills inventory identified for the aircraft maintenance industry.

Required knowledge and skills should be based on a careful matching of the required task knowledge and skills with the appropriate evaluation methods. If a basic skill is to demonstrate problem solving, the candidate must solve problems in order to satisfy that portion of the certification evaluation. This kind of a rigorous performance-based test also creates a criterion-based learning environment (where candidates can take credit for previous work experience) and shortens the time it takes to become qualified as an **ARS-I**. Particular care must be taken to assure that performance tasks are not simply evaluated through easy-to-score objective paper and pencil test but also through demonstrated competency-based tests.

### **13.9.5 Determine Experience Requirements**

Satisfactory completion of a training and qualification program and/or performance evaluations may not be sufficient for all **ARS-I** certification. Industry experience, in hours worked, and a recommendation from an employer in the industry may also be required. The appropriate experience would vary with the specialty and could be part of the certification approval process.

#### **Establish Training Standard and Core Curriculum**

The professional associations approved by **AIMSAC** as the "keepers of the flame" would create the standards for training content and curriculum based on industry input and review. The documentation of curriculum and curriculum materials may be provided by the professional association as a part of their services. Details on how the required knowledge and skills are to be learned can be included in course outlines and instructor guides. The guides and standards would clearly indicate which learning objectives are cognitive and which are psycho-motor. Specific instructions in the certification testing processes would help clarify how candidates must perform and, therefore how information should be presented. When the requirement is for the learner to do some specific task, a psycho-motor experience in the shop or laboratory is essential. The materials created can be represented as approved by **AIMSAC** when the professional association has received acceptance of their standards for the aircraft maintenance industry.

Prerequisite requirements (education, language, physical, drug-free, etc.) may be imposed by the **FAA**, other regulatory agencies, **AIMSAC**, and the professional associations. The objective would be to comply with all regulations and to assure a high industry perception of the particular **ARS-I** certification.

The **FAA** may also require proficiencies in regulatory compliance. **AIMSAC** working with the **FAA** could document those requirements that may apply to all specialty areas.

#### **Develop Competency Testing**

Since under this proposal the **FAA** would not be formally testing **ARS-I** applicants, it is important to assure that successful candidates can do more than pass written tests. In order to make this assurance, the tests must require that candidates for certification demonstrate competency in the basic requirements of the skills they will be using. Performance testing takes more time and equipment but ensures that an individual can perform the tasks satisfactorily



according to the defined standards. The guidelines for competency testing could be developed by the professional organizations.

Competency testing provides a benefit to those who seek certification from approved schools and organizations because they may be able to "test out" on some parts of a program. Those with related experience in another industry or military aircraft maintenance may not need the entire program to prepare for certification testing. If someone knows that they may be able to qualify in a matter of weeks rather than months, it may attract more highly experienced and qualified people to aircraft maintenance.

Competency-based curricula can be modularized in a way that allows people to pretest then take only those subjects they need. This assures that industry requirements such as regulatory compliance or standard safety practices will be assured for all certificate holders, regardless of their background. It also helps training providers be more flexible in the manner in which they provide the academic information and laboratory or shop experience.

### **Conduct Training Provider Accreditation**

There are advantages to **AIMSAC** recognition of a professional association's standards and curriculum because the association can then provide products and services to its members and other who wish to establish a school or approved training program. When a school or program is industry certified, it attracts more students since they know that industry certification will help them acquire a job or upgrade their current employment status.

It is the organization intending to deliver the training program that would request recognition from a professional association. The professional association would apply for and receive recognition from **AIMSAC** that its standards, curriculum, and learning materials are recognized by the aviation maintenance industry. AIMSAC recognition would also indicate that the organization applies the necessary regulations and rules. AIMSAC would provide detailed rules and procedures for approval. Subsequently, the professional association would have detailed processes to assure the certified organizations continuously comply with standards.

### **Evaluate and Approve Industry Standards**

The **AIMSAC** would convene to provide both evaluation of new standards and/or changes that are submitted by industry related to technological developments. By incorporating members from all phases of the industry from manufacturers to operators and the **FAA**, AIMSAC would provide good oversight of development. By providing communications to other segments of the industry, such as suppliers and to their professional associations, everyone could stay aware of rapid technological changes.

Regulatory agencies do not always closely track specific changes in an industry segment, so a tendency occurs to generalize standards and practices. Problems may arise because the work required to update aging standards may become more difficult the longer one waits to make the change. Current regulatory change processes are not conducive to rapid change. Therefore, by providing connections between those who are most aware of developments, e.g., professional associations, and the users such as manufacturers and, ultimately, the operators, advantage can be taken of each group's interests and expertise.

## **Issue Individual ARS-I Certificates**

The **FAA** currently receives requests from **AMOs** to certificate repairmen in a specialty area who have met the requirements of certification, experience, and recommendation. Under this proposal, the FAA may grant an **ARS-I** certification to the individual who could use that certification as evidence of competency for any FAA certificated employer in the aircraft maintenance industry. The FAA would require that the ARS-I certificate holder advise them of address changes and compliance with any recurrent training requirements.

## **Implement Communication Programs**

An additional function of **AIMSAC** would be to provide a forum for communications to the aircraft maintenance industry and the associated specialty interests. As the organization develops, there may be increasing communications functions to meet the needs of this dynamic industry.

In addition, there is a role to play in building interest on the part of potential certification candidates. This activity can help assure a supply of well-qualified candidates for employment.

**Industry and Education Partnerships.** There are many examples where manufacturers and operators have supported schools with donations of expertise, equipment, and materials. This practice will potentially apply to specialty training; other examples are cooperation between schools and employers in providing work-study arrangements for some students. It benefits employers as well as the rest of the industry to help assure that certificate holders are well qualified and require little additional training to become productive on the job.

**Resource Planning and Development.** A central organization can collect data from multiple sources to make predictions about future needs. By anticipating for the industry and providing the information to all facets of aircraft maintenance and training providers, the lags in the graduate supply can be reduced. It may also be beneficial to have one organization watching trends in other industries where the specialties are applied as changes may provide sources of experienced specialty practitioners.

Promotion of the career path in schools as early as junior high school may also help assure a supply of interested and qualified candidates. **AIMSAC** would be in a good position to coordinate efforts to reach school advisors and job counselors at all levels of education.

## **13.9.6 Review and Revision Process**

There is a system of checks and balances in this approach to specialty certification. The professional associations would keep track of current practices and technological developments. They would communicate to their members and the users of the specialty skills, such as manufacturers. The end users, manufacturers, and operators would be interested because they want to be able to have people who are qualified to do their jobs. Regulatory agencies would oversee the entire process and meet their responsibilities by inspecting the aircraft maintenance organizations. They would be supported by the other interested parties so that standards of qualification are reviewed and revised much more frequently than at present.

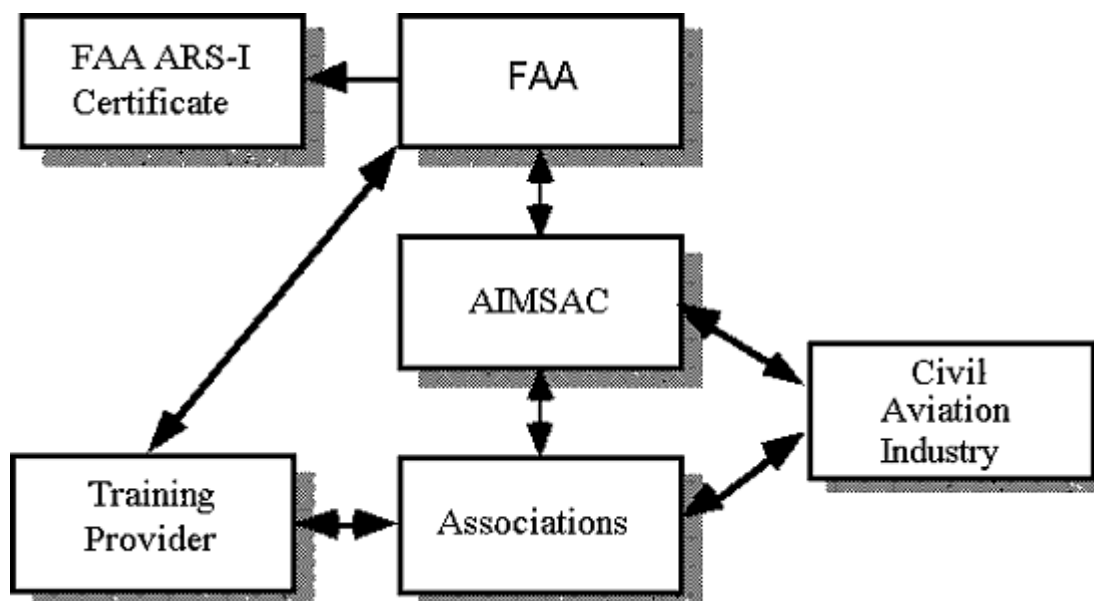
### 13.9.7 AIMSAC Funding

We propose that **AIMSAC** be self-funded through membership participation and in-kind contributions from participating organizations and perhaps from accreditation fees. It will need resources to accomplish the responsibilities defined in its goals and objectives. The industry should provide some initial support through direct or in-kind donations to help AIMSAC get started. The value of AIMSAC will guide the amounts industry would be willing to invest for the services provided.

### 13.9.8 Blue Print for AIMSAC

**Figure 13.8** portrays an organizational framework for an industry-controlled advanced specialist qualification system. The key feature of this plan is the interaction between **AIMSAC** and the **FAA**, professional organizations, manufacturers, training providers, and the individual seeking **ARS-I** certification.

**Figure 13.8 AIMSAC Integrated Plan**



The initial steps to formulate **AIMSAC** will need to be taken by the **FAA**. Based on an FAA published Advisory Circular for **ARS-I** standards, the FAA could call and facilitate a meeting of interested parties. It is important to assure by special invitation that all of the appropriate organizations are represented at the initial meeting.

The objective of the meeting would be to form an organization similar to the **AIMSAC** concept described herein and to outline its responsibilities. An initial list of participants will be determined and a temporary steering committee may be formed to help with initial set-up activities. Support will be required from the participating organizations. Once established AIMSAC would communicate its preparedness to consider standards from professional

associations such as **ASNT**, **AEA**, etc.

AIMSAC would develop criteria and a process for evaluating standards so that it may provide recommendations to the FAA. The criteria for an evaluation, selection of the evaluation committee, and the processes would be documented so that applicants would know what is expected.

Industry associations would create standards and curriculum for use by organizations (schools, companies, etc.) that want to help people become qualified to provide training in a defined aviation maintenance specialty. Associations may receive revenue from selling standards documents and curriculum materials. Associations could create additional training opportunities and refresher training as required to maintain currency with evolving standards.

As proposed, the **AIMSAC** would receive requests from organizations/associations for recognition as a standard for certain aviation maintenance specialties. With **FAA** and industry concurrence, standards proposals would be accepted and subsequent accreditation by an association would be based upon the standard. AIMSAC would send application materials and criterion to the requesting organization.

The associations would apply to the aviation industry umbrella organization (**AIMSAC**) for approval. AIMSAC would conduct an evaluation and consider recommendation to the **FAA**.

Schools would apply to the approved professional organization for the specialty desired. Their application would include documentation about their operation and plans to indicate compliance with the organization's standards, curriculum, and evaluation practices. If the paper review indicated compliance, the organization would conduct an on-site evaluation to assure facilities and faculty meets the criteria. When approved, the school or organization may conduct their program and certify the successful students as having met the requirements for the approved program. Suitable documents would be provided to the **ARS-I** candidates for submission to the **FAA**.

Association certified people may apply to the **FAA** for an **ARS-I** certificate in the defined specialty. The specialist may then be certificated ARS-I by the FAA and use his/her privileges in an **AMO**.

The **ARS-I** would commit the holder to exercise his or her privileges within the limitations imposed by the ARS-I certificate and to keep the **FAA** advised of current address. The FAA would have the administrative task of issuing and tracking ARS-I certificate holders.

**FAA** surveillance and enforcement regulations would apply to **ARS-I** certificate holders. Failure to operate within the regulations and guidelines would mean that the holder be appropriately penalized under the applicable rules.

### **13.9.9 Formation Of AIMSAC**

The basic elements of an **ARS-I** certification system would need to be developed into an operational process in the near future. Once the Part 66 **NPRM** activities have been concluded, and public comments addressed, steps to build the AIMSAC group and develop its required policies, terms of reference, operating guidelines, and procedures should begin. This will ensure

that when the new rule becomes effective, there will be a viable system in place that reviews and approves industry standards for ARS-I certification.

In the event of changes in industry thinking or **FAA** internal policy changes, and in order that **ARS-I** does not become an individually issued certification, the industry standards development and approval process should still be adopted. **AIMSAC** would simply take a role similar to that of **CAMC** where the group would approve industry standards and issue certification. Though not an FAA certification, it would ensure that holders are qualified to specific, recognized, and approved industry standards.

## 13.10 REFERENCES

**AEA** Technical Education & Training Standards Committee and the Association for Avionics Education. (1994). *Aviation Electronics Technical Specialist Qualification Standard 100*. Paper presented to m ARAC Part 65 Working Group.

Air Transport Association. (1995). *The Annual Report of the U.S. Scheduled Airline Industry*. Washington, D.C.

American West Outsources Heavy Maintenance (December 5, 1995). *Aviation Daily*.

The American Society for Nondestructive Testing, Inc. (1989). *ASNT Standard for Qualification and Certification of Nondestructive Testing Personnel*.

Boeing Commercial Airplane Group. (1995). *Current Market Outlook*. Seattle, WA.

**CARAC AME** Licensing Control Working Group Meeting. (1995). Draft final report on AME recommendations.

Canadian Aviation Maintenance Council. (1995). *Aircraft Nondestructive Inspection Technician*. Ottawa, Canada.

Czepiel, E. J., Krulee, G. K., Murray, G. C., Weishaar, S. K. (1994). *Job Task Analysis of the Aviation Maintenance Technician-Phase I*. (DOT/FAA/FS-94). Evanston, IL: The Transportation Center, Northwestern University.

Federal Aviation Administration. (1994). *Administrator's Fact Book*. (AFS-350).

Federal Aviation Administration. (1995). *Zero Accidents-A Shared Responsibility. Aviation Safety Action Plan*.

Federal Aviation Administration. (1995). *Aviation Maintenance Technician: Advanced Standards Initiative*. Presentation by the Flight Standards Services Branch on Regulatory

Review FAR Part 65.

Federal Aviation Administration (1995). *FAA Aviation Forecasts: Fiscal years 1995-2006*. (FAA-APO-95-1).

Federal Aviation Administration. (1995). *Draft Regulatory Evaluation, Initial Regulatory Flexibility Determination, and Trade Impact Assessment: Revision of Certification Requirements: Mechanics and Repairmen*. Notice of Proposed Rulemaking. (14 CFR 65, 66, 147). Washington, D.C.: Office of Aviation Policy, Plans and Management Analysis, Operations Regulatory Analysis Branch, APO-310.

Federal Aviation Administration. (1995). *Revision of Certification Requirements: Mechanics and Repairmen*. Notice of Proposed Rulemaking. (14 CFR 65, 66, 147). Docket no. 27863; Notice no. RIN: 2120. Washington, D.C.: Department of Transportation.

Fitzgerald, G. (1994). *The Future of Overhaul and Maintenance*. Global Aviation Repair Shop. *Aviation Week Group*.

Future Aviation Professionals of America. (1995). Faxed data on maintenance hiring and job report from Louis Smith, President of FAPA.

General Aviation Manufacturers Association. (1995). *Outlook & Agenda: Annual Industry Review*. Washington, D.C.

General Aviation Manufacturers Association. (1995). *Statistical Databook*. Washington, D.C.

Goldsby, R. (1994). *Training and Certification in the Aircraft Maintenance Industry*. Phase I. Redwood City, CA: HKS & A.

Gugliemino, A.S. (1994). *FAR 145 Repair Station Technician Survey*. Informal survey. Tucson, AZ: Aviation Technology Center, Pima County Community College District.

*Joint Aviation Requirements*. (1994). Draft report on JAR-147 Approved/Accepted Maintenance Training Organisations.

Ministry of Skills Development. (1990). *Aircraft Maintenance Engineer: Apprenticeship Training Standards*. Ontario, Canada

National Air Transportation Association. (1995). *Bilateral Aviation Safety Agreement (BASA)*. Conference on Quality in Commercial Aviation.

National Business Aircraft Association, Inc. (1995). *Business Aviation Fact Book*.

Pilot and Aviation Maintenance Technician Blue Ribbon Panel. (1993). *Pilots and Aviation*

*Maintenance Technicians for the Twenty-First Century.*

Price Waterhouse (1991). *Human Resources in the Canadian Aircraft Maintenance Industry.*  
Sponsored by the Employment and Immigration Canada.

Regional Airline Association. (1995). *Annual Report.*

Swierenga, D.A. (1994). *U.S. Air Carrier Industry Outlook.* Paper presented to the **ATA**  
Engineering, Maintenance & Material Forum, Atlanta, GA.

White, C.W. (1995). Paper presented to the Committee on Education and Training for Civilian  
Aviation Careers. Aviation Technician Education Council.

Whitehead, B. (personal communication, December 16, 1994).

## 13.11 APPENDICES

### 13.11.1 Appendix A - Amt Demand Forecast



**TABLE 3. PROJECTED AMT DEMAND**

YEAR	MAJOR AIR CARRIERS		COMMUTER AIR CARRIERS		GENERAL AVIATION		OTHER		TOTAL NEW HIRE
	Aircraft(1)	AMTs(2)	Aircraft(1)	AMTs(4)	Aircraft(1)	AMTs(6)	AMTs(8)	New Hire AMTs(9)	
1988	3,671	51,394	1,684	6,736	202,000	30,300	43,000	3,870	131,430
1989	3,870	54,180	1,782	7,128	195,500	29,325	43,860	3,930	134,493
1990	4,017	56,238	1,819	7,276	204,400	30,660	44,737	4,009	138,911
1991	4,252	59,528	1,896	7,584	197,400	29,610	45,631	4,088	142,353
1992	4,206	58,884	1,960	7,840	198,400	29,760	46,543	4,170	143,027
1993	4,265	59,710	2,018	8,072	198,700	29,805	47,473	4,253	145,060
1994	4,311	60,354	2,066	8,264	199,700	29,955	48,422	4,339	146,995
1995	4,367	61,418	2,116	8,464	200,800	30,120	49,390	4,425	149,392
1996	4,496	62,944	2,152	8,608	202,400	30,360	50,377	4,513	152,289
1997	4,553	63,742	2,171	8,684	203,600	30,540	51,394	4,604	154,350
1998	4,690	65,660	2,195	8,780	205,000	30,750	52,411	4,696	157,601
1999	4,843	67,602	2,225	8,900	206,400	30,960	53,459	4,790	161,121
2000	5,016	70,224	2,255	9,020	207,600	31,140	54,528	4,886	164,912
2001	5,180	72,520	2,287	9,148	208,900	31,335	55,618	4,983	168,621
2002	5,381	75,334	2,323	9,282	210,100	31,515	56,730	5,083	172,871
2003	5,566	77,924	2,359	9,436	211,200	31,680	57,864	5,184	176,904
2004	5,747	80,458	2,381	9,524	212,300	31,845	59,021	5,289	180,848
1993-2004 TOTALS		62,479		12,303		39,086		57,045	170,913



(1) Obtained from 1993 FAA Aviation Forecast data.  
 (2) The number of AMTs for the major air carriers is equal to the number of aircraft multiplied by the number of technicians per aircraft (14).  
 (3) The number of new-hire AMTs is equal to the growth over the previous year plus attrition (5 percent) per year.  
 (4) The number of AMTs for the commuter air carriers is equal to the number of aircraft multiplied by the number of technicians per aircraft (4).  
 (5) The number of new-hire AMTs is equal to the growth over the previous year plus attrition (10 percent) per year.  
 (6) The number of AMTs for general aviation is equal to the number of aircraft multiplied by the number of technicians per aircraft (15).  
 (7) The number of new-hire AMTs is equal to the growth over the previous year plus attrition (10 percent) per year.  
 (8) This includes federal technicians and technicians employed by manufacturers and repair stations. (Assumes 2 percent growth rate.)  
 (9) The number of new-hire AMTs is equal to the growth over the previous year plus attrition (7 percent) per year.

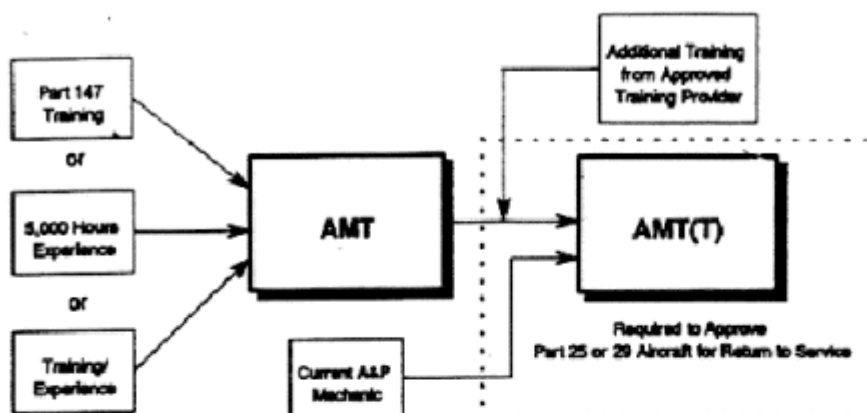


## 13.11.2 Appendix B - FAA Briefing Document For Part 65

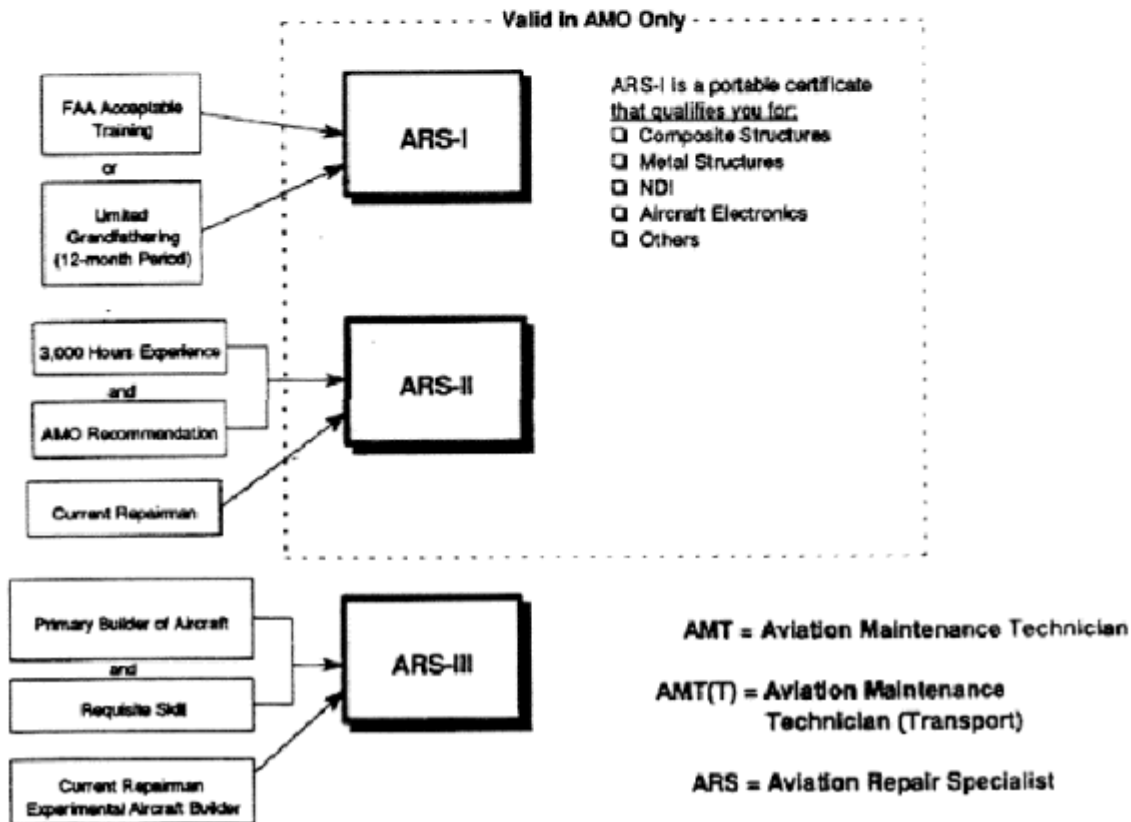


### Proposed Maintenance Personnel Certification System

#### Generalist (Current A&P Mechanic)



#### Specialist (Current Repairman)





## Aviation Rulemaking Advisory Committee (ARAC) Proposals for the Revision of Part 65

### The ARAC and the Part 65 Working Group

The ARAC was established to assist the FAA in the rulemaking process by providing input from outside the Federal Government on major regulatory issues affecting aviation safety. The ARAC includes representatives of air carriers, manufacturers, general aviation, labor groups, colleges, universities, associations, airline passenger groups, and the general public. The ARAC established the Part 65 Working Group in 1991 and tasked the group to conduct a review of the certification requirements for mechanics, mechanics holding inspection authorizations, and repairmen.

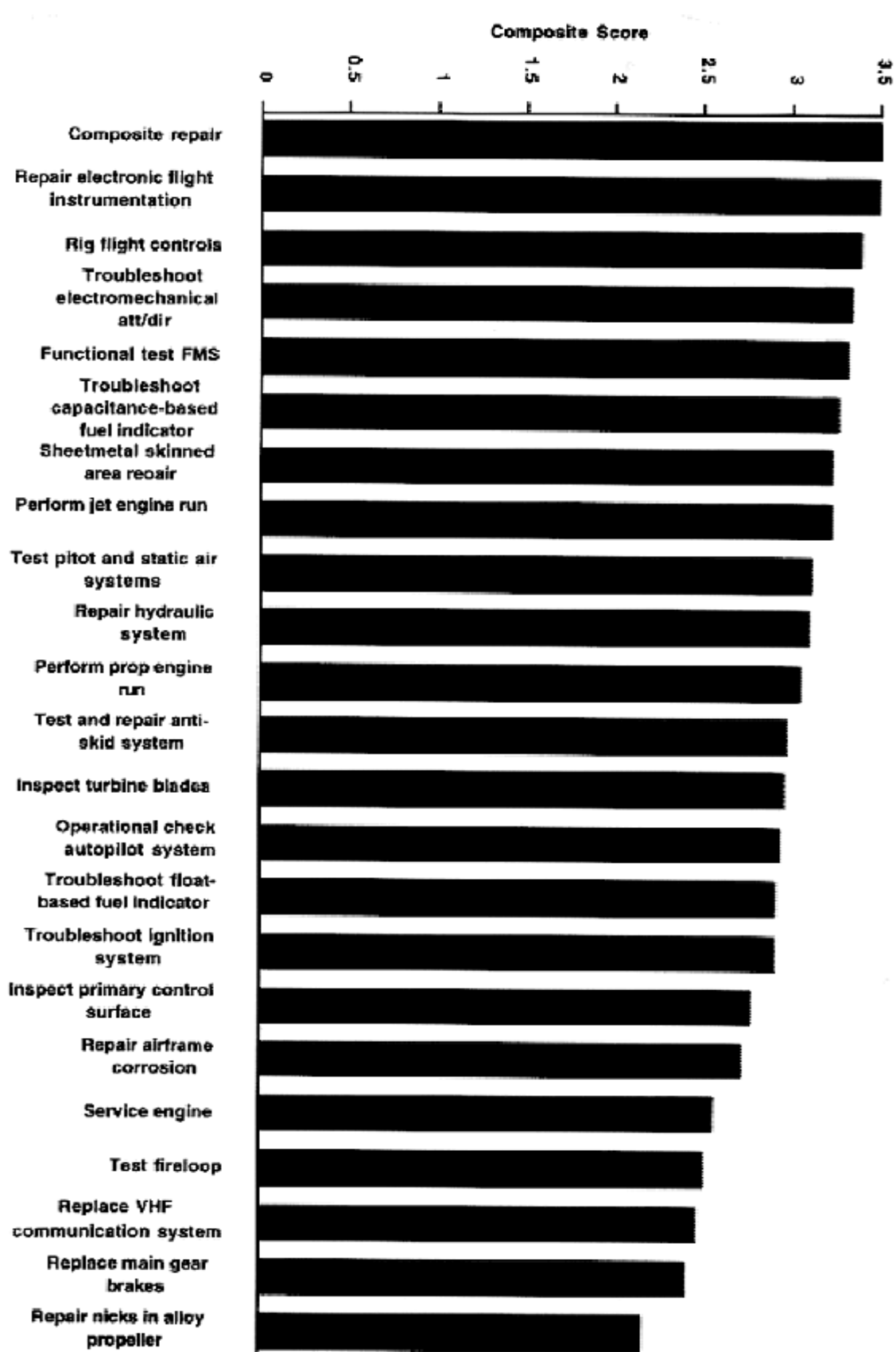
### Status of Regulatory Review and Proposed Rule Changes

On August 17, 1994, the FAA issued a Notice of Proposed Rulemaking (NPRM) (59 FR 42430), which set forth recommendations made after the completion of Phase I of the Part 65 Working Group's review. In April 1995, the working group completed Phase II of its review. The working group recommended that the FAA reconcile and consolidate the proposals made in the earlier NPRM with those proposals made at the completion of the second phase of the regulatory review. The FAA concurred with this recommendation and intends to withdraw the earlier NPRM upon publication of a subsequent consolidated NPRM. The FAA estimates that this NPRM will be published prior to the end of 1995 or shortly thereafter.

### Major Proposals

- Establish a separate part 66 in the FAR for aviation maintenance personnel. \*
- Change "mechanic" to "aviation maintenance technician" and "repairman" to "aviation repair specialist." \*
- Establish aviation maintenance technician (AMT) and aviation maintenance technician (transport) (AMT(T)) certificates. *(A mechanic with airframe and powerplant ratings would be considered equivalent to an AMT(T) with an aircraft rating and retain all current certificate privileges.)*
- Establish procedures for the FAA approval of AMT(T) training providers.
- Consolidate current airframe and powerplant ratings into a combined aircraft rating.
- Establish additional training requirements for individuals seeking the AMT(T) certificate with an aircraft rating. *(Not applicable to holders of current mechanic certificates with airframe and powerplant ratings. No retesting of A&P mechanics will be required.)*
- Establish recurrent training requirements for AMTs and AMT(T)s who desire to use their certificates for compensation or hire. \*
- Provide for the registration of holders of AMT and AMT(T) certificates.
- Establish an aviation maintenance instructor rating.
- Permit AMTs and AMT(T)s to perform maintenance on horizontal-card liquid-filled compasses.
- Extend the duration of an inspection authorization from 1 year to 2 years. \*
- Expand the renewal options available to the holder of an inspection authorization. \*
- Require inspection authorization applicants to successfully complete an inspection authorization refresher course prior to application.
- Establish a portable aviation repair specialist certificate (ARS-I), based on proficiency in designated specialty areas.
- Permit certain aviation maintenance technician schools to test applicants for the AMT certificate.
- Discontinue the certification of aviation maintenance personnel who are employed outside the United States and who are not proficient in the English language (subject to waiver). \*

\* An asterisk indicates changes that were proposed in the previous 1994 NPRM.



---