

SimplyGo User Manual



PHILIPS
RESPIRONICS

 **OXYGENConcentratorStore**
FROM AMERICAN MEDICAL SALES & RENTALS

1-877-774-9271 | www.oxygenconcentratorstore.com

Table of Contents

Introduction	1
Intended Use	1
Contraindications	1
Device and Accessories Description	1
SimplyGo System	2
Warnings and Cautions	3
Symbol Key	6
How to Contact Philips Respironics	6
Getting Started.....	7
Battery Duration Times.....	7
System Overview	8
Inserting and Removing the Batteries	10
Charging the Battery with the AC Power Supply.....	12
Operating the SimplyGo Device	13
Power Options	13
Device Warm-Up Breathing	14
Operating Modes.....	14
Operating the SimplyGo Device and Changing Device Settings.....	16
Alarm Indicators and Screen Symbols.....	19
Troubleshooting.....	26
Caring for your Battery	27
Battery Storage.....	27
Connecting the Optional Humidifier	28
Caring for your SimplyGo System	29
Cleaning the Device and Rechargeable Battery.....	29
Cleaning the Accessories	30
Device Storage	30
Device Disposal	30
SimplyGo Portable Oxygen Concentrator Mobility	31
SimplyGo Carrying Case.....	31
SimplyGo Accessory Bag.....	32
SimplyGo Mobile Cart	32
Traveling With Your System	32
By Motor Vehicle.....	33
By Bus or Train	33
On Arrival.....	33
Specifications.....	34
Standards Compliance	36
Classification.....	36
EMC Information.....	37
Limited Warranty.....	39

Introduction

Intended Use

The Philips Respironics SimplyGo Portable Oxygen Concentrator is for prescription use by patients requiring high concentrations of oxygen on a supplemental basis. It is small, portable, and is capable of continuous use in the home, institutional, and travel /mobile environments.

Contraindications

- This device is not intended to be life-sustaining or life-supporting.
- This device is not intended for newborn and infant use.

Device and Accessories Description

The SimplyGo Portable Oxygen Concentrator, its features, and its accessories are described in detail in this manual. Read and understand it completely before operating the device.

This manual applies to the following accessories:

- AC Power Supply
- AC Power Cord
- DC Power Supply
- Rechargeable Lithium Ion Battery
- Carrying Case
- Accessory Bag
- Mobile Cart
- Humidifier

This manual does not apply to the following accessory items sold separately:

- Standard Single Lumen Nasal Cannula
- SimplyGo Smart Battery Charger/Recalibrator

SimplyGo User Manual

SimplyGo System

The device comes with the following items. If any are missing, contact your equipment provider.

- SimplyGo Device in Carrying Case with Shoulder Strap



- This User Manual

- Rechargeable Battery

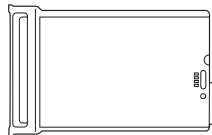

- AC Power Supply and Cord

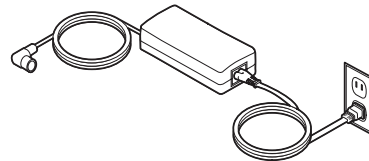

- DC Power Supply

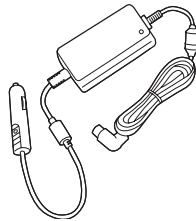

- Accessory Bag

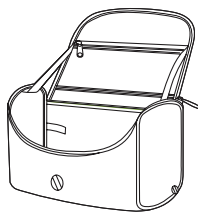

- Mobile Cart

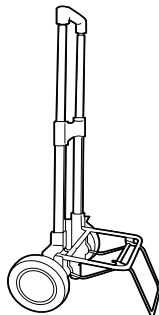

Warnings and Cautions

Warnings

A warning represents the possibility of harm to the operator or patient.

- The operator should read and understand this entire manual before using the device.
- The device is not intended for life support. Where the prescribing health care professional has determined that an interruption in the supply of oxygen, for any reason, may have serious consequences to the user, an alternate source of oxygen should be available for immediate use.
- Geriatric or any other patient unable to communicate discomfort, or hear or see the alarms while using this device, may require additional monitoring.
- Oxygen supports combustion. Oxygen should not be used while smoking or in the presence of an open flame.
- Do not use the device in the presence of a flammable anaesthetic mixture in combination with oxygen or air, or in the presence of nitrous oxide.
- Do not use oil or grease on the concentrator or its components as these substances, when combined with oxygen, can greatly increase the potential for a fire hazard and personal injury.
- If you notice any of the following, discontinue use and contact your home care provider:
 - unexplained changes in the performance of this device
 - unusual or harsh sounds
 - dropped or mishandled device or the power supply
 - water spilled into the enclosure
 - broken enclosure
- Use only with Philips Respironics SimplyGo AC power supply.
- Use only with Philips Respironics SimplyGo batteries.
- Use only approved SimplyGo accessories.

Warnings (continued)

- Repairs and adjustments must be performed by Philips Respironics authorized service personnel only. Unauthorized service could cause injury, invalidate the warranty, or result in costly damage.
- Periodically inspect electrical cords, cables, and the power supply for damage or signs of wear. Discontinue use and replace if damaged.
- To avoid electric shock, unplug the device and remove the batteries before cleaning the bag. DO NOT immerse the device in any fluids.
- Your home care provider is responsible for performing appropriate preventive maintenance at the intervals recommended by Philips Respironics.
- For proper operation, your device requires unobstructed ventilation. Always make sure any openings in the case are not obstructed by items which may impede ventilation. Do not place the device in a small closed space (such as a closet). The device should not be used adjacent to or stacked with other equipment. For more information, contact your home care provider.
- Do not use an extension cord.
- Device operation above or outside of the voltage, breath rate, temperature, humidity and/or altitude values specified may decrease oxygen concentration levels.
- Never drop or insert any object into any opening.
- Be aware that the electrical cord and/or tubing could present a tripping or strangulation hazard.
- Use only power cords supplied by Philips Respironics for this device. Use of power cords not supplied by Philips Respironics may cause overheating or damage to the device and may result in increased emissions or decreased immunity of the equipment or system.
- Do not operate without the battery installed and working. If primary power is lost with no battery in place, the device will stop operating without warning the user. If the device must be operated without the battery, the user should be aware that there is no backup power and no warning if primary power is lost.
- Medical Electrical Equipment needs special precautions regarding EMC and needs to be installed and put into service according to the EMC information provided in this manual.
- Place the device in a location so as to avoid pollutants and fumes.

- Portable and Mobile RF Communications Equipment can affect Medical Electrical Equipment. See the EMC section of this manual for distances to observe between RF Generators and the SimplyGo device to avoid interference.

Cautions















A caution represents the possibility of damage to the equipment.

- Do not immerse the device or allow any liquid to enter the enclosure.
- When the device is used in an automobile, disconnect it from the DC auto adapter outlet when the automobile is turned off. Do not operate the device in a non-running vehicle for an extended period of time, as this may deplete the vehicle's battery and prevent the vehicle from starting. Do not allow the device to be connected to the auto adapter outlet while starting the automobile normally or while you are starting the automobile with battery recharging cables. Wait until the automobile starts before connecting the device to the DC power outlet. Secure the device securely when used in any moving vehicle. (The same cautions apply if using the DC adapter outlet on a boat or recreational vehicle.)
- Turn off the device before removing the battery. The device should not be operated without the batteries installed. If the device is operated without the batteries installed, the standard shut-down routine will not be implemented when the power is disconnected prior to turning off the unit. This can result in damage to the device.
- Only use the supplied handle and shoulder strap to carry your device. With every use, verify that the case, shoulder strap and handle are in good condition.

Note: Additional warnings, cautions, and notes are located throughout the manual.

SimplyGo User Manual

Symbol Key

	Consult accompanying instructions for use		Model number
	No smoking		Serial number
	No oil or grease		Type BF Applied Part
	Keep away from open flames		Rechargeable Battery
	Do not disassemble		Drip proof equipment
	Class II (Double Insulated)		Separate collection for electrical and electronic equipment per EC Directive 2002/96/EC.
	DC power		AC Power

Note: Also see the section on alarm indicators and screen symbols.

How to Contact Philips Respironics

To have your device serviced, contact your home care provider. If you need to contact Philips Respironics directly, call the Customer Service department at 1-724-387-4000 or +49 8152 93060. You can also use one of the following addresses:

Respironics Inc.
1001 Murry Ridge Lane
Murrysville, PA 15668 USA

Respironics Deutschland
Gewerbestrasse 17
82211 Herrsching, Germany

Getting Started

Attach the shoulder strap to the carrying case.

Before using the SimplyGo device for the first time, the SimplyGo battery requires an initial uninterrupted charging time of 4 hours minimum. This can be accomplished by installing the battery and using the AC Power Cord, as described in the following pages.

Note: Philips Respironics does not recommend using DC power for this initial charging.

Caution: Use only Philips Respironics batteries in your SimplyGo device. Using other batteries could damage the device and will void the warranty. Remove the battery if the SimplyGo will not be used for an extended period of time.

Battery Duration Times

SimplyGo's battery times vary depending on which operating mode (Pulse or Continuous Flow) is being used and which setting is selected in the operating mode. SimplyGo is designed to allow easy access to the battery so that it is easy to swap out and utilize extra batteries (sold separately) as needed. Extra batteries fit easily into the zippered pouch of the carrying case or in the handy accessories bag. Additionally, extra batteries can be charged in the external battery charger (sold separately) or in the SimplyGo device (see the "Charging the Battery with the AC Power Supply" section), allowing maximum flexibility to meet your specific battery needs.

The following shows the approximate battery durations for Pulse flow settings at 20 BPM and Continuous Flow settings when the battery is fully charged. Your times may vary based on your activity level, the condition of the batteries, and the age of your SimplyGo device.

Pulse Dose Setting

2
3.5 hours

Continuous Flow Setting

2
.7 hours

System Overview

Begin by becoming familiar with your SimplyGo device.

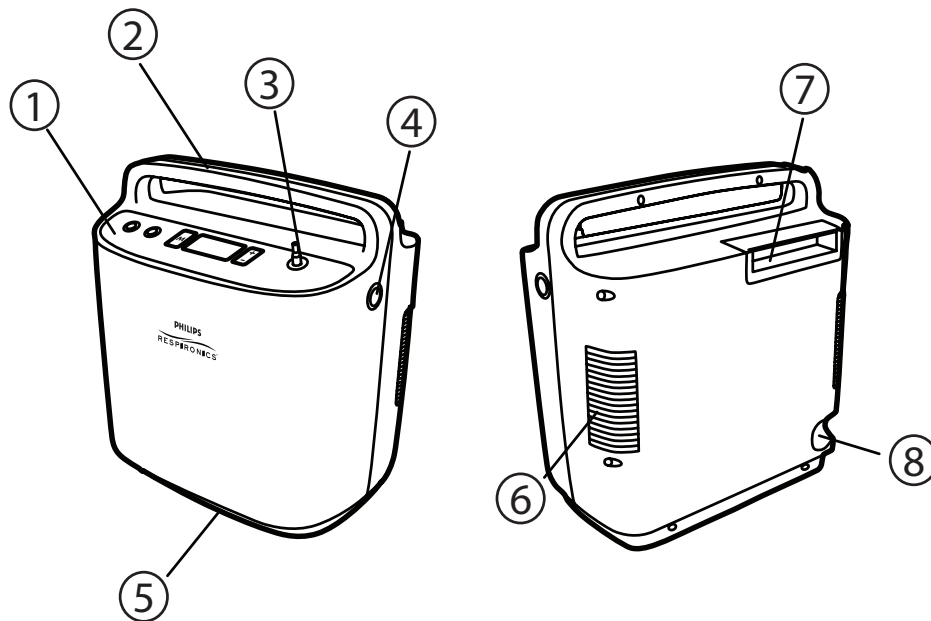

Item	Description	Function
1	Control Panel	Control switches and LCD display
2	Carrying Handle	Hand grip area for lifting and transporting the device
3	Patient Cannula Connector	Oxygen output and connection point for patient cannula
4	Power Input Connector	Connection point for Philips Respironics-provided external power supplies: AC line voltage, vehicle DC
5	Air Exhaust Vent	Air outlet for enclosure ventilation fan
6	Air Intake Vent	Air inlet for enclosure ventilation fan
7	Battery	Rechargeable lithium-ion battery with integrated handle used to remove and install battery pack
8	Data Port	Input-Output data communication with the device. Caution: For use by authorized service personnel only.

Control Panel

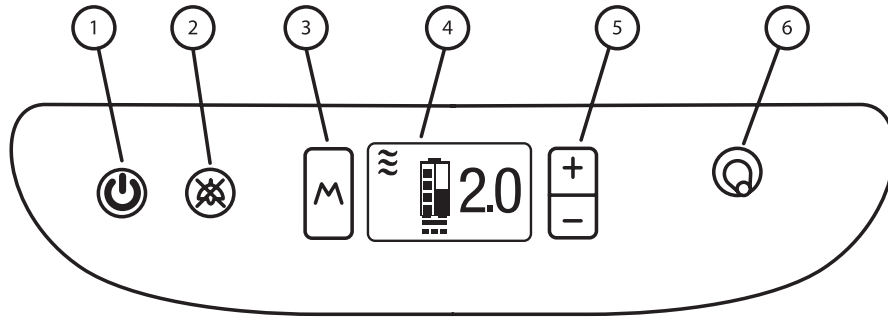

Item	Description	Function
1	Power	Turns the device On and Off
2	Alarm Silence	Turns the audible alarm off
3	Mode	Selects one of the three possible operating states of the device
4	Display Screen	Shows information about the operating status of the device
5	Plus (+)/Minus (-)	+ Increases the displayed setting; - Decreases the displayed setting
6	Patient Cannula Connector	Oxygen output and connection point for patient cannula

Run Time Screen Description

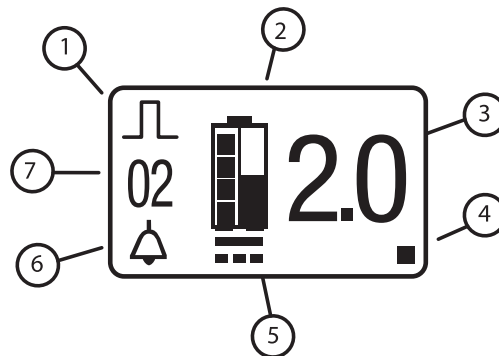

Item	Symbol Description	Function
1	Operating Mode	For detailed descriptions, refer to the "Alarm Indicator and Screen Symbols" section.
2	Battery Status	
3	Setting	
4	Breath Indicator	
5	External Power Status	
6	Audible Alarm Status	
7	Alarm Type	

Inserting and Removing the Batteries

Your SimplyGo device comes with one rechargeable lithium ion battery. To insert it correctly, follow these steps.

1. Place your device in a well ventilated location and make sure it is turned off.

Note: The SimplyGo device is shipped from the factory with the battery removed.

Caution: Only remove the battery when the SimplyGo is turned off. Never remove the battery while the device is operating.

2. To remove the battery, insert your fingers into the opening in the battery handle. Steadily pull upward on the handle until the battery is released from the enclosure. Continue to lift the battery until it is entirely removed from the battery compartment. If the device has been operating, the surfaces may be warm to the touch. This is normal.

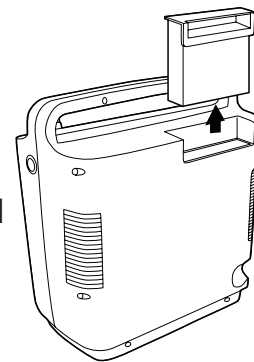

3. Check the battery gauge (shown below). To do so, press the white button (shown below) on the battery and watch how many LEDs light up. If the batteries are low, you can recharge them. See the Charging the Battery with AC Power Supply section.

No. of LEDs	Battery Charge
4 LEDs Light:	75% to 100% full
3 LEDs Light:	50% to 75% full
2 LEDs Light:	25% to 50% full
1 LED Lights:	10% to 25% full
1 LED Blinks 3 Times:	Battery is less than 10% full and needs to be recharged

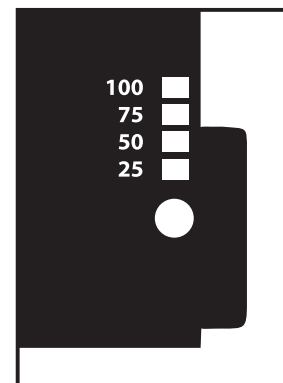

4. To insert the battery, insert your fingers into the opening in the battery handle and grip the handle between your fingers and thumb. Position the battery over the battery compartment in the top, rear corner of the SimplyGo enclosure with your fingers pointing toward the handle. The battery compartment is shaped so that there is only one way the battery can be inserted and this will align the battery correctly.

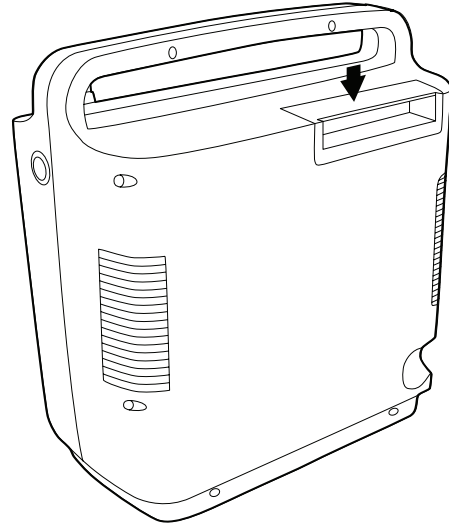

Lower the battery into its compartment until the handle contacts the equipment enclosure. Firmly push on the battery handle until it snaps into place in the enclosure top.

5. After the battery is inserted, check to make sure the battery handle is level with or slightly below the top of the plastic case.

6. Momentarily depress the Power key, and the following should occur:

- The LCD and the 5 Key backlights turn ON
- The screen shown here displays on the LCD

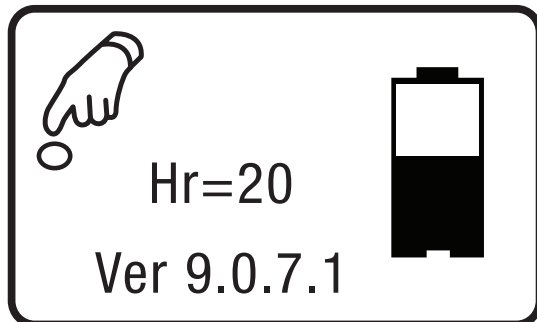

If you do not see the battery symbol or the device does not turn On, the battery is not installed correctly. Re-insert the battery and make sure it snaps in place.

Charging the Battery with the AC Power Supply

Important: The first time you charge the battery, be sure to charge it fully. Do not use the DC power cord to do so; instead use AC power.

Note: The battery will begin charging whenever you connect the device to an AC outlet, even if you're using it.

To charge the battery using the AC Power Cord provided with your system, follow these steps.

1. Connect the AC Power Supply's output cable to the SimplyGo power input connector.
2. Connect the AC Power Cord's connector into the AC power supply.
3. Connect the AC Power Cord's plug into an AC outlet installed to meet national or regional electrical code.

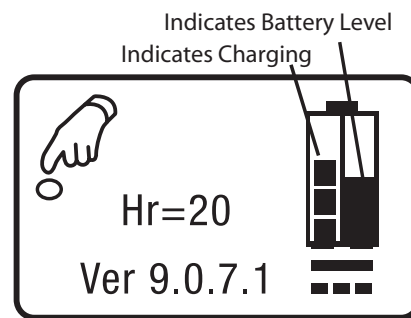
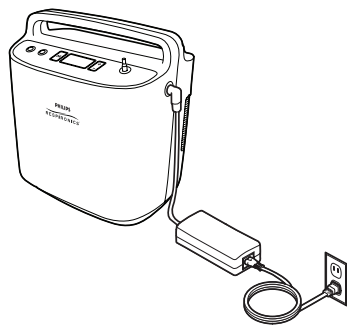

Note: As soon as you connect the device to an energized AC power source, the light on the AC Power Supply lights up and *the cooling fan turns on*. This is normal. The fan will run the entire time it is charging to keep the battery cool.

4. When charging is complete (this takes four hours or less), disconnect the AC Power Supply and store it with the AC Power Cord for future use.

Note: Replacement and spare batteries are available separately. For information, contact your home care provider.

Note: An optional SimplyGo Smart Battery Charger/Recalibrator (sold separately) is available for your system. For more information, contact your home care provider.

Operating the SimplyGo Device

Power Options

Warning: Do not use the device without the battery installed and operating.

- To run the device on battery power, make sure the battery is properly inserted and sufficiently charged. (The battery should be fully charged the first time you use it.)
- **To run the device using AC power**, first make sure you have a battery installed. Then, follow these steps:
 1. Connect the output cable of the AC Power Supply to the SimplyGo power input connector.
 2. Connect the AC Power Cord's connector into the AC power supply.
 3. Connect the AC Power Cord's plug into an AC outlet installed to meet national or regional electrical code.

Note: The AC Power Supply is equipped with a green light, which illuminates when it is connected to an energized AC power source.

- **To run the device using DC power** from an automobile or other motorized vehicle, make sure the battery is installed. Start the vehicle and connect one end of the DC Power Cord to the device's power inlet and the other end into the vehicle's DC electrical outlet.

Because the amount of current available in the vehicle electrical system is limited, the current available to charge the SimplyGo battery will be determined by the operating mode of the device. At high settings the time required to charge the battery will be much longer and at the highest settings, it may not charge at all.

Device Warm-Up Breathing

When you turn on your SimplyGo device, it will sense if you are breathing from it. If you are not yet breathing through the cannula, SimplyGo will begin to pulse automatically about once every five seconds. The only purpose of this “device warm-up breathing” is to help the device warm up faster. As soon as you begin breathing through the cannula, the device will begin delivering pulses based on your breathing. Device warm-up breathing occurs only when you first turn on the device. You may begin breathing from the SimplyGo at any time. If the device does not sense a breath after two minutes, a No Breath alarm will sound.

Operating Modes

This section describes additional operating screens on the SimplyGo device.

1. Pulse Mode Screen

When the device is in the Pulse operating mode, it detects when the user begins to take a breath and then delivers a pulsed volume of oxygen determined by the setting number, during inhalation. If no breath is detected for a period of time, the system automatically delivers the pulsed volume of oxygen determined by the setting number at a fixed rate of 12 breaths per minute. If no breath is detected for 2 minutes, the device signals an alarm and shuts down after 30 minutes.



2. Continuous Flow Mode Screen

In Continuous Flow operating mode, a constant flow of oxygen is supplied based on the setting number (in liters per minute):

- .5 LPM
- 1 LPM
- 1.5 LPM
- 2.0 LPM

Caution: When the SimplyGo device is connected to a CPAP device, you can only use the Continuous Flow operating mode.

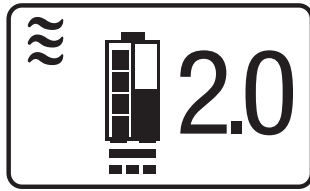

3. Sleep Mode Screen

The Sleep operating mode is similar to the Pulse Mode. The device detects when the user begins to take a breath using a more sensitive detection level. The SimplyGo then delivers a pulsed volume of oxygen determined by the setting number. During inhalation, a low amplitude and longer pulse duration is used to make sleeping more comfortable. If no breath is detected for a period of time, the system automatically delivers a continuous flow of oxygen at a rate of 2.0 LPM.

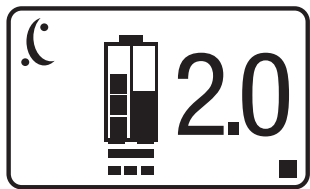

Selecting the Operating Modes

You can use the Mode button (M) to select the device operating mode.

To select your operating mode:

1. Press the Mode button.

Note: If the device is operating and the screen is dark, the first press turns on the screen backlight. In this case, press the button a second time to select the mode. The intensity of the backlighting can be either increased or decreased. Refer to the **Turning the SimplyGo Device Off** section of this manual for more information.

SimplyGo User Manual

2. Continue pressing the Mode button to scroll through the Pulse, Continuous Flow, or Sleep modes.
3. When your desired mode appears in the display, stop pressing the button and wait. The display will return to the run time screen of the mode you selected, and the device will operate in this mode.

Operating the SimplyGo Device and Changing Device Settings

You can change all device settings using the buttons on the control panel. This includes starting the device, stopping it, silencing an alarm, and changing oxygen flow.

To start your SimplyGo device, follow these steps.

1. Connect a nasal cannula to the patient cannula connector on top of the device, as shown. Ensure that the cannula is routed to prevent it from being pinched or kinked to avoid a disruption of oxygen flow.

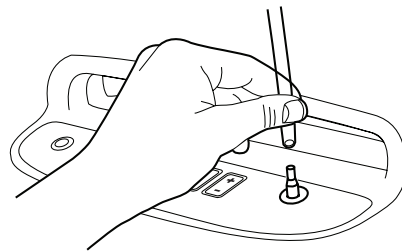

Note: A standard single lumen nasal cannula and tubing (not supplied) should be used to deliver oxygen from the SimplyGo device. The device works with cannula tubing up to 30 ft. (9 m).

2. To start the device, press the Power button. After the first press, the display screen and the 5 button backlights turn on and you will see a screen similar to the one shown below.

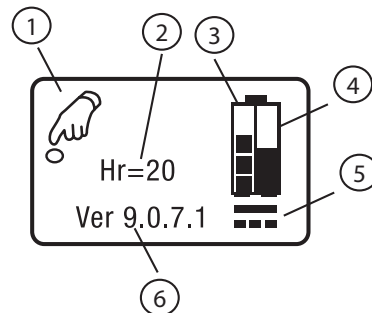

ITEM	DESCRIPTION
1	Push Power again to turn the device on.
2	Total number of operating hours for the device.
3	Indicates if the battery is being charged.

ITEM	DESCRIPTION
4	Amount of full charge currently in the battery.
5	External power is connected.
6	Software version in the device.

- Press the Power button a second time to place the device in operating mode. This second press helps prevent unwanted starts or inadvertent changes in oxygen flow. The Introductory screen momentarily appears, shown at left below, followed by the final operating mode screen, shown at right.

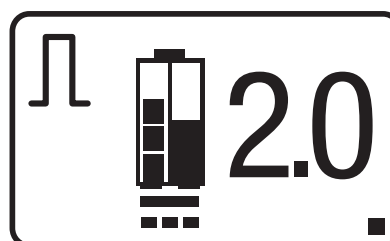

Every time it starts up, the device starts producing oxygen to meet the specified setting. It may take up to ten minutes to reach the specified purity levels for the setting. It is safe to begin breathing from the SimplyGo device immediately. Breathing from the device will cause it to reach oxygen purity levels faster than ten minutes.

The dot in the lower right corner of the LCD display is the pulse symbol. It appears whenever you take a breath and the device delivers a pulse of oxygen.

Note: When it is turned on, the device will automatically start at the flow rate setting used when the device was last turned off. As a precaution, each time you start the device, verify the flow setting.

- To set the device's flow setting, press either the + or – button.
To increase the flow setting, press the + button. To decrease the flow setting, press the – button.
The device can be set to 1, 1.5, 2, 2.5, 3, 3.5, 4, 4.5, 5, 5.5, and 6 in Pulse or Sleep Mode. It can be set to .5, 1, 1.5, and 2 in Continuous Flow Mode.

Warning: It is very important to set your device to your prescribed level of oxygen flow. Do not increase or decrease your flow rate from your prescribed level until you first consult with your physician.

SimplyGo User Manual

5. Position the nasal cannula on your face, as shown below, and breathe normally through your nose.



Turning the SimplyGo Device Off

1. When you are ready to turn your SimplyGo device off, press the Power button. The screen below appears.





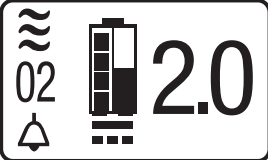

2. Press the Power button a second time and the SimplyGo device will turn off.
3. Rather than pressing the Power button a second time, the backlight intensity may be increased or decreased by repeatedly pressing the Plus (+) or Minus (-) key until the desired backlight intensity is achieved. The device may then be powered off using steps 1 and 2 above.

Alarm Indicators and Screen Symbols

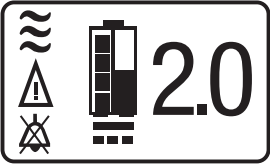

Visual, Audio Indicators	Description	What To Do
 <p data-bbox="331 814 501 972">3 short beeps + 1 long beep</p>	<p data-bbox="602 422 857 453">No Breath Alarm</p> <p data-bbox="602 474 946 1121">This alarm occurs when a breath is not detected for a period of 2 minutes or more. It can be silenced by pressing the Alarm symbol. This alarm becomes silent as soon as a breath is detected. If no breath is detected after approximately 30 minutes, the device shuts down to conserve power. (This alarm is inactive for ten minutes after startup.)</p>	<p data-bbox="1013 552 1325 993">Check the connection from the cannula to the device. Make sure the nasal cannula is properly positioned on your face and that you are breathing through your nose. Make sure the cannula tubing is not kinked or obstructed.</p>
 <p data-bbox="324 1430 508 1541">3 long beeps + 1 short beep</p>	<p data-bbox="602 1178 922 1251">Low Oxygen Concentration Alarm</p> <p data-bbox="602 1272 954 1541">This alarm occurs when the device is delivering a lower concentration of oxygen than specified. This alarm can be silenced by pressing the Alarm symbol.</p>	<p data-bbox="1013 1283 1308 1440">Change to another source of oxygen and contact your equipment provider.</p>

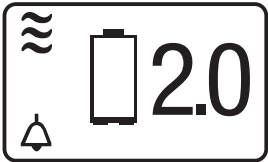
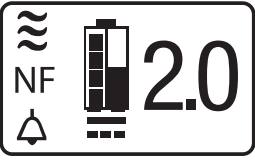

SimplyGo User Manual

Visual, Audio Indicators	Description	What To Do
 <p data-bbox="305 699 526 772">1 long beep after 2 minutes</p>	<p data-bbox="602 344 954 380">High Breath Rate Alarm</p> <p data-bbox="602 396 948 829">This alarm indicates that the user's breath rate is exceeding the capacity of the device. The device is still working properly and is still providing oxygen at the rate specified for the setting. The beeps can be silenced by pressing the Alarm symbol.</p>	<p data-bbox="1011 468 1328 705">The indicator resets itself when the breath rate is reduced. If this indicator regularly occurs, contact your home care provider.</p>
 <p data-bbox="321 1304 513 1419">3 short beeps + 3 long beeps</p>	<p data-bbox="602 884 932 919">Technical Fault Alarm</p> <p data-bbox="602 936 948 1255">This alarm occurs when: a) the battery runs out or b) the device has a general malfunction and the device is no longer operating properly.</p> <p data-bbox="602 1272 906 1430">The device may or may not shut down depending on the severity of the alarm.</p> <p data-bbox="602 1446 857 1608">This alarm can be silenced if the  symbol appears on-screen.</p>	<p data-bbox="1011 1062 1317 1178">Recharge the battery and try to restart the device.</p> <p data-bbox="1011 1194 1300 1430">If this alarm occurs again, change to another source of oxygen and contact your home care provider.</p>





Visual, Audio Indicators	Description	What To Do
 <p>1 short beep</p>	<p>Low Battery Alarm</p> <p>This alarm occurs when approximately 17 minutes of battery life remains. Remaining battery life is dependent on your device settings and your activity level. The empty battery symbol flashes on-screen.</p>	<p>Replace the battery or connect to a power source.</p> <p>(Press the Alarm symbol to silence the alarm.)</p>
 <p>3 long beeps + 1 short beep</p>	<p>No Flow Alarm</p> <p>This alarm occurs when the device detects there is no oxygen flowing in the patient cannula.</p>	<p>Check the cannula for kinks or other obstructions that are stopping oxygen flow through it.</p>
 <p>Alternating short and long beeps</p>	<p>Depleted Battery Alarm</p> <p>This alarm occurs when approximately two minutes of battery life remains. The battery symbol flashes on-screen.</p>	<p>Replace or recharge battery.</p> <p>(Press Alarm symbol to silence the alarm.)</p>
	<p>Alarm Silence Symbol</p> <p>This symbol appears when you press the Alarm Silence button to silence the audible alarm (beeps).</p>	<p>No further action is needed.</p>



SimplyGo User Manual

Visual, Audio Indicators	Description	What To Do
	<p>Attention</p> <p>This symbol appears when corrective action is required.</p>	<p>If the device is operating in the carrying case, make sure it has been placed correctly in the case so that the outlet vents are in the front. The vents should be visible through the slot at the bottom. See the <i>SimplyGo Carrying Case</i> section of this manual.</p> <p>Allow the device to warm up. If the alarm continues, contact your home care provider.</p>
	<p>Battery Charging While Almost Empty Symbol</p> <p>This battery symbol appears (with the charging bars scrolling on the left side) when the battery is almost depleted and recharging.</p>	<p>No action needed.</p>

Visual, Audio Indicators	Description	What To Do
	<p>Battery Charging While Partly Full Symbol</p> <p>When a battery symbol similar to this appears (with the charging bars scrolling on the left and at mid-height on the right), the battery is partly full and recharging.</p> <p>The left side of the symbol indicates charging, and the right side indicates the battery level.</p>	<p>No action needed.</p>
 <p>1 long beep</p>	<p>Battery Charge Complete Symbol</p> <p>This battery symbol appears when the battery is fully charged.</p>	<p>No action needed.</p>
	<p>Power Connection Symbol</p> <p>This symbol appears when the device is connected to an AC, DC, or airline power source.</p>	<p>No action needed.</p>
<p>(Power Connection Symbol Disappears)</p> <p>1 short beep</p>	<p>The Power Connection symbol disappears when the device is disconnected from the power source.</p>	<p>No action needed.</p>

SimplyGo User Manual

Visual, Audio Indicators	Description	What To Do
 <p>1st press of the Power button = 1 long beep.</p> <p>2nd press of the Power button to turn device OFF = 3 long beeps</p>	<p>On/Off Symbol</p> <p>This symbol appears when the device is powered on, or is ready to be turned on or off.</p>	<p>Press the Power button to turn the device on or off.</p> <p>Note: To prevent inadvertent starts and stops, the device requires two presses of the Power button to turn it on and off.</p>
	<p>Pulse Symbol</p> <p>The dot appears in the lower, right hand corner of the display screen when the device delivers a pulse, whenever you take a breath.</p>	<p>No action needed.</p>
	<p>Pulse Mode Indicator</p> <p>This symbol appears when the device is operating in Pulse mode.</p>	<p>If this is your Mode setting, no action is needed.</p> <p>If this is not your Mode setting, press the Mode button until your proper Mode setting appears.</p>
	<p>Sleep Mode Indicator</p> <p>This symbol appears when the device is operating in Sleep mode.</p>	<p>If this is your Mode setting, no action is needed.</p> <p>If this is not your Mode setting, press the Mode button until your proper Mode setting appears.</p>

Visual, Audio Indicators	Description	What To Do
	<p>Continuous Flow Mode Indicator</p> <p>This symbol appears when the device is operating in Continuous Flow Mode.</p>	<p>If this is your Mode setting, no action is needed.</p> <p>If this is not your Mode setting, press the Mode button until your proper Mode setting appears.</p>
<p style="font-size: 2em; text-align: center;">2.0</p> <p style="text-align: center;">1 short beep</p>	<p>Flow Control Setting</p> <p>The large number on the right side of the screen shows the oxygen flow setting. (In this example, it is 2.) This number can range from 1 to 6 in increments of one-half for Pulse and Sleep modes and from .5 to 2 for Continuous Flow mode.</p>	<p>If this is your flow setting, no action is needed.</p> <p>If this is not your flow setting, press the + button to increase this number or press the – button to decrease this number.</p>
	<p>AC Power Required Warning</p> <p>The screen appears when your device is in Sleep Mode and AC power has not been connected or has become disconnected.</p>	<p>Connect your device to an AC power source.</p>

Troubleshooting

The table below lists common problems and actions you can take. If you are unable to resolve a problem, please contact your home care provider.

Problem	Possible Cause	What You Should Do
Device Won't Turn On	Battery is depleted.	Use the AC or DC power cords to operate the device (with the battery inserted) to recharge the battery. If this does not resolve the problem, contact your home care provider.
	Battery is not installed correctly.	Remove the battery and re-install it correctly.
	Power button not pressed twice.	Press the power button twice.
Device Will Not Trigger A Pulse Of Oxygen	SimplyGo is not turned on.	Press the power button twice.
	Cannula tubing is kinked or twisted.	Make sure the tubing is connected properly to the oxygen outlet port and that it is free of any obstruction.
	Device malfunction.	Contact your home care provider.
Oxygen Not At Full Concentration	Device is warming up.	Wait 10 minutes for the device to deliver oxygen at the prescribed concentration. If the condition persists, contact your home care provider.
Alarm Occurs	The device needs your attention.	See the Alarm Indicators and Screen Symbols section for information about specific alarms and what you should do.

Caring for your Battery

Handle your battery with care.

- Do not allow the battery's terminals to touch together as this will cause it to fail.
- Do not immerse the battery in water.
- Do not disassemble or deform the battery.
- Do not expose to, or dispose of, the battery in fire.
- Avoid exposing the battery to excessive physical shock or vibration (dropping, etc.).
- Keep all batteries out of the reach of children.
- Do not use any battery that has been damaged in any way.
- Always charge the battery in accordance with the manufacturer's instructions, using specified chargers only.
- Do not use modified battery chargers.
- An optional, external charger/calibrator can be purchased to recalibrate the battery. Contact your home care provider for more information.

Battery Storage

Lithium ion batteries can be stored from -4° F (-20° C) to 140° F (+60° C) at up to 80% relative humidity. However, they are best stored below 70° F (21° C) in a cool, dry, well-ventilated facility free from corrosive gas or vapor.

Storage at temperatures above 113° F (45° C), such as in a hot car, may degrade battery performance and reduce battery life. Storage at low temperatures may affect initial battery performance.

Connecting the Optional Humidifier

Warnings

- Only use the humidifier connector tubing supplied with the SimplyGo Humidifier Connecting Tube kit (REF 1101172) or the SimplyGo Humidifier Pouch and Tube kit (REF 1101602).
- Do not overfill humidifier.
- Do not reverse the oxygen input and output connections. Water from the humidifier bottle will travel through the cannula back to the patient.
- Do not use the humidifier while the device is in Pulse mode.

Note: Only connect the humidifier if prescribed. Only use the humidifier if the device is in Continuous Flow mode.

To connect the humidifier:

1. Attach the humidifier accessory pouch to the mobile cart (see the instructions included with the pouch).
2. Remove the cap from the humidifier bottle.
3. Fill the humidifier with distilled water to the level indicated by the manufacturer.
4. Replace the cap and make sure it is tightened securely.
5. Attach the humidifier bottle adapter tube to the humidifier bottle by turning the wing nut on the bottle counterclockwise until it is fastened securely.
6. Place the humidifier bottle assembly in the accessory pouch (REF 1083699). Attach the accessory bag to the pull cart.
7. Rotate the bottle so the humidifier adapter hose is away from the body of the portable oxygen concentrator.
8. Attach the oxygen tubing from the humidifier bottle assembly to the oxygen outlet connector on the portable oxygen concentrator.
9. Attach the cannula tubing to the humidifier bottle outlet.
10. After assembly is complete, make sure the oxygen is flowing through the cannula.

Notes

- A bubble humidifier may be used with the SimplyGo.
- A Humidifier Accessory Pouch (REF 1083699) may be purchased to enable use of a bubble humidifier.

Caring for your SimplyGo System

Cleaning the Device and Rechargeable Battery

Warning: To avoid electrical shock, do not remove the SimplyGo covers. The covers should only be removed by authorized service personnel. Do not apply liquid directly to the covers. Do not use alcohol, solvents, polishes or any oily substances on the device, as they are flammable.

Caution: Do not allow liquids into any of the controls, the interior of the case, or the oxygen tubing connector. If this occurs, contact your home care provider for assistance.

The exterior covers of the device and rechargeable battery should be cleaned as needed:

1. Turn the device off and disconnect from the power source before cleaning.
2. If the battery is removed, wipe the battery bay and battery with a dry cloth.
3. Clean the device exterior using a damp cloth with a mild household cleaner and wipe it dry. Or, if you use medical disinfectants, be sure to follow the manufacturer's instructions. For disinfection, Philips Respironics recommends the following:
 - Discide Ultra Towelettes: Manufacture - Palmero, www.palmero-health.com (or equivalent)

If you are using a humidifier, clean your device according to your home care provider's or manufacturer's instructions.

Cleaning the Accessories

Follow the instructions below when cleaning the accessories.

Carrying Case and Mobile Cart

If necessary, the carrying case can be washed in a washing machine using a mild laundry detergent. Air dry.

To wash the carrying case and mobile cart by hand, use only warm water and a mild liquid dish detergent.

1. Remove the SimplyGo device from the carrying case or mobile cart.
2. Dampen a cloth in the detergent and water solution and wipe the outside surfaces of the case clean.

AC and DC Power Supplies/Power Cord

The AC and DC power supplies and power cord should be cleaned as needed.

1. Disconnect cords from device before cleaning.
2. Clean the cords using a cloth with a mild household cleaner and wipe dry.

Cannula and Tubing

Clean and replace the cannula and tubing as instructed by the manufacturer and your home care provider.

Device Storage

Store your device in a place where it will remain clean and dry.

Caution: Do not store your device or accessories in extreme temperatures, below -4° F (-20° C) or above 140° F (60° C).

Device Disposal

Separate collection for electrical and electronic equipment per EC Directive 2002/96/EC. Dispose of this device in accordance with local regulations.

SimplyGo Portable Oxygen Concentrator

Mobility

Your SimplyGo system has been designed to provide you with a source of oxygen that can be carried with you. To enable you to do so, your SimplyGo device has a carrying case bag, accessory bag, and a mobile cart for use with it.

SimplyGo Carrying Case

The SimplyGo carrying case allows you to take your supply of oxygen with you as you go about your normal, daily activities. It provides protection for your SimplyGo as well as a carrying strap to transport the device. To place the SimplyGo into its carrying bag:

1. Position the bag and the SimplyGo so that the front of the device corresponds with the surface of the bag that has a zippered accessory pouch. This will ensure that the inlet air vent on the rear of the device, the outlet air vent on the front, bottom of the device and the power input connect on the side of the device line up with their openings provided in the bag. If the SimplyGo is not placed in the bag properly the air vents will be blocked, and the device will overheat during operation and shut off.
2. Insert the device into the top of the bag and pull the snugly fitting bag up around the device. Check to ensure that the air vents and power input connector align with their openings in the case.
3. Wrap the handle cover around the carrying handle of the SimplyGo and secure it in place by pressing the two Velcro together.

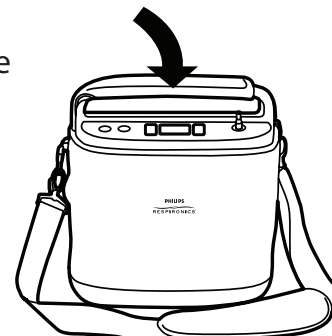
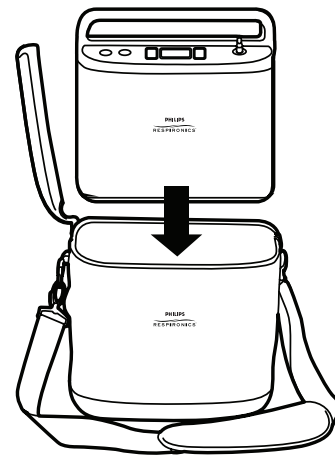
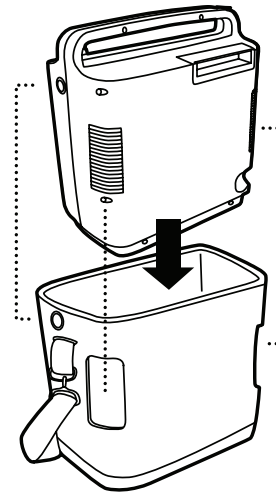

SimplyGo Accessory Bag

The accessory bag is a separate, zippered bag that provides extra space for storing and carrying items such as additional batteries, power supplies, connecting cables, nasal cannulas and personal items you need that cannot be accommodated by the storage pocket in the SimplyGo carrying case.

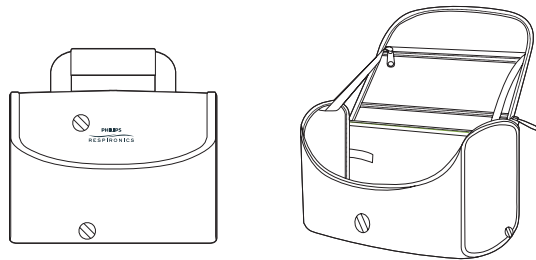

This bag can be attached to the mobile cart along with your SimplyGo device as described below.

SimplyGo Mobile Cart

The SimplyGo mobile cart provides you an alternative method to carrying the SimplyGo in its carrying case. The cart will accommodate both the SimplyGo in its carrying case and the accessory bag. Both can be placed on the mobile cart as shown in the instructions included with the mobile cart.

Traveling With Your System

With your SimplyGo system and proper advance planning, you can enjoy traveling within your community and beyond. Before you leave, make sure you pack the following:

- Fully charged battery (and extra batteries for a long trip).
- AC power supply and connector cord
- DC power supply
- Carrying bag
- Mobile cart

Also, be sure to take the telephone numbers of your home care provider and physician in case of an emergency.

By Motor Vehicle

Use the SimplyGo DC power supply to plug in your system using the vehicle's cigarette lighter or DC power input. Whenever the SimplyGo system is running from a DC power source, the battery installed in your device will begin recharging. You can also use the SimplyGo device while it is running from a DC power source.

Caution: Make sure the vehicle has been started before plugging in your DC power supply. If you operate the SimplyGo system using the DC power cord while the vehicle engine is turned off, you could inadvertently drain the vehicle's battery.

By Bus or Train

Most bus and train lines allow passengers to use portable oxygen concentrators, but you may need to notify them in advance. When you make your travel arrangements, contact your carrier well before your departure for permission to bring your system and use it on board.

Note: Bus and rail carriers outside the United States may have additional requirements for oxygen concentrators. Contact them several weeks before you leave to identify any requirements or specifications that may require your attention.

On Arrival

When you arrive at your destination, check the status of your system's battery. This is an excellent time to recharge all batteries, so they're ready to go when you need them. The charge level on your batteries can be checked by following the instructions in the *Inserting and Removing the Battery* section of this manual. If a battery requires charging, this can be done as described in the *Charging the Battery with the AC Power Supply* section of this manual.

If you have any questions or concerns about traveling with your SimplyGo system, contact your home care provider.

Specifications

Operating Conditions	Operational temperature: 41° F to 104° F (5° C to 40° C) Relative humidity: 15% to 95% Altitude: up to 10,000 ft. (3048 m.)
Storage and Transport Conditions	-4° F to 140° F (-20° C to 60° C) - unit only Relative humidity: up to 95%, non condensing

SimplyGo Oxygen Concentrator

Oxygen Concentration*	87%-96% at all settings
Flow Settings and Pulse Volumes	<p>Pulse Mode 1 = 12 ml; 1½ = 18 ml; 2 = 24 ml; 2½ = 30 ml; 3 = 36 ml; 3½ = 42 ml; 4 = 48 ml; 4½ = 54 ml; 5 = 60 ml; 5½ = 66 ml; and 6 = 72 ml; +/- 15% or 4 ml, whichever is greater (Average of 20 consecutive breaths) up to a max of 2000 ml/min +/- 200 ml</p> <p>Sleep Mode Variable pulse volumes, based on breath rate, to maintain a constant minute volume per setting. 1 = 250 ml; 1½ = 375 ml; 2 = 500 ml; 2½ = 625 ml; 3 = 750 ml; 3½ = 875 ml; 4 = 1000 ml; 4½ = 1125 ml; 5 = 1250 ml; 5½ = 1375 ml; and 6 = 1500 ml +/- 15% or 60 ml, whichever is greater (Average of 20 consecutive breaths)</p> <p>Continuous Mode ½ = 500 ml/min; 1 = 1000 ml/min; 1½ = 1500 ml/min; 2 = 2000 ml/min; +/- 10% or 100 ml/min, whichever is greater (3 minute running average)</p> <p>Note: Max recommended flow is 2 LPM (at nominal outlet pressures of 0 and 7 kPa).</p>

User Interface	Push buttons, back-lit liquid crystal display (LCD)
Dimensions	11.5 in x 10 in x 6 in (29.2 cm x 25.4 cm x 15.2 cm)
Weight	10.0 lbs (4.54 kg) with battery installed
Sound Level	43 dBA max. at Nominal Pulse Mode Setting of 2 and 20 BPM
Audio Alarm	50 decibels (nominal) at 39 in. (1 m)
Outlet Pressure	6.5 psig maximum
*Based on an atmospheric pressure of 14.7 psia (101 kPa) at 70° F (21° C)	

SimplyGo Battery

Chemistry	Lithium Ion 14.4 VDC (nominal)
Dimensions	0.9 in x 7.4 in x 4.6 in (2.3 cm x 18.8 cm x 11.7 cm)
Weight	1.5 lbs. (0.7 kg)
Charge Time (AC Power)	2-6 hours from fully discharged to fully charged, depending on the operating mode and device settings.

AC Power

Type	Philips Respironics 1068987
Input	100 to 240 VAC, 50/60 Hz, 2.0 A
Output	19 VDC, 7.9 A max
Power Consumption	150 W while charging 120 W while not charging

DC Power

Input:	13-19 VDC 7.9 A max
--------	---------------------

Standards Compliance

The device is designed to conform to the following standards

- IEC 60601-1, Medical Electrical Equipment, Part 1: General Requirement for Safety
- IEC 60601-1-2, 2nd edition, Medical Electrical Equipment, Part 1-2: General Requirement for Safety – Collateral Standard: Electromagnetic (EMC) Compatibility – Requirements and tests.
- RTCA/DO-160F section 21, category M; Emission of Radio Frequency Energy
- ISO 8359, Oxygen Concentrators for Medical use – Safety Requirements.

Classification

The SimplyGo is classified as:

- IEC Class II Internally Powered Equipment
- Type BF Applied Part
- IPX1: Drip Proof Equipment
- Not suitable for use in the presence of a flammable anesthetic mixture with air or with oxygen or nitrous oxide.
- Continuous Operation

EMC Information

Guidance and Manufacturer's Declaration – Electromagnetic Emissions		
SimplyGo is intended for use in the electromagnetic environment specified below. The user of SimplyGo should assure that it is used in such an environment.		
Emissions Test	Compliance	Electromagnetic Environment - Guidance
RF Emissions CISPR 11	Group 1	The Device uses RF energy only for its internal function. Therefore, its RF emissions are very low and are not likely to cause any interference in nearby electronic equipment.
RF Emissions CISPR 11	Class B	The Device is suitable for use in all establishments, including domestic establishments and those directly connected to the public low-voltage power supply network that supplies buildings used for domestic purposes.
Harmonic Emissions IEC 61000-3-2	Class A	
Voltage Fluctuations/Flicker Emissions IEC 61000-3-3	Complies	

Guidance and Manufacturer's Declaration – Electromagnetic Immunity			
SimplyGo is intended for use in the electromagnetic environment specified below. The user of SimplyGo should assure that it is used in such an environment.			
Immunity Test	IEC 60601 Test Level	Compliance Level	Electromagnetic Environment - Guidance
Electrostatic Discharge (ESD) IEC 61000-4-2	±6 kV Contact ±8 kV Air	±6 kV Contact ±8 kV Air	Floors should be wood, concrete or ceramic tile. If floors are covered with synthetic material, the relative humidity should be at least 30%.
Electrical Fast Transient/Burst IEC 61000-4-4	±2 kV for Power Supply Lines ±1 kV for Input/Output Lines	±2 kV for Power Supply Lines ±1 kV for Input/Output Lines	Mains power quality should be that of a typical home or hospital environment.
Surge IEC 61000-4-5	±1 kV Line to Line ±2 kV Line to Ground	±1 kV Line to Line ±2 kV Line to Ground	Mains power quality should be that of a typical home or hospital environment.
Voltage Dips, Short Interruptions and Voltage Variations on Power Supply Input Lines IEC 61000-4-11	<5% U_T (>95% Dip in U_T) for 0.5 Cycle 40% U_T (60% Dip in U_T) for 5 Cycles 70% U_T (30% Dip in U_T) for 25 Cycles <5% U_T (>95% Dip in U_T) for 5 Seconds	<5% U_T (>95% Dip in U_T) for 0.5 Cycle 40% U_T (60% Dip in U_T) for 5 Cycles 70% U_T (30% Dip in U_T) for 25 Cycles <5% U_T (>95% Dip in U_T) for 5 Seconds	Mains power quality should be that of a typical home or hospital environment. If the user of the Device required continued operation during power mains interruptions, it is recommended that the Device be powered from an uninterruptible power supply or battery.
Power Frequency (50/60 Hz) Magnetic Field IEC 61000-4-8	3 A/m	3 A/m	Power frequency magnetic fields should be at levels characteristic of a typical location in a typical home or hospital environment.
Note: U_T is the A.C. mains voltage prior to application of the test level.			

SimplyGo User Manual

Guidance and Manufacturer's Declaration – Electromagnetic Immunity			
SimplyGo is intended for use in the electromagnetic environment specified below. The user of SimplyGo should assure that it is used in such an environment.			
Immunity Test	IEC 60601 Test Level	Compliance Level	Electromagnetic Environment - Guidance
Conducted RF IEC 61000-4-6	3 Vrms 150 kHz to 80 MHz	3 V	Portable and mobile RF communications equipment should be used no closer to any part of the Device, including cables, than the recommended separation distance calculated from the equation applicable to the frequency of the transmitter. Recommended separation distance $d = 1.2\sqrt{P}$ 150 kHz to 80 MHz $d = 0.35\sqrt{P}$ 80 MHz to 800 MHz $d = 0.7\sqrt{P}$ 800 MHz to 2.5 GHz where P is the maximum output power rating of the transmitter in watts (W) according to the transmitter manufacturer and d is the recommended separation distance in meters (m). Field strengths from fixed RF transmitters, as determined by an electromagnetic site survey, ^a should be less than the compliance level in each frequency range. ^b Interference may occur in the vicinity of equipment marked with the following symbol: 
Radiated RF IEC 61000-4-3	3 V/m 80 MHz to 2.5 GHz	10 V/m ^c	
Note 1:	At 80 MHz and 800 MHz, the higher frequency range applies.		
Note 2:	These guidelines may not apply in all situations. Electromagnetic propagation is affected by absorption and reflection from structures, objects, and people.		
a	Field strength from fixed transmitters such as base stations for radio (cellular/cordless) telephones and land mobile radios, amateur radio, AM and FM radio broadcast and TV broadcast cannot be predicted theoretically with accuracy. To assess the electromagnetic environment due to fixed RF transmitters, an electromagnetic site survey should be considered. If the measured field strength in the location in which the Device is used exceeds the applicable RF compliance level above, the Device should be observed to verify normal operation. If abnormal performance is observed, additional measures may be necessary, such as re-orienting or relocating the Device.		
b	Over the frequency range 150 kHz to 80 MHz, field strengths should be less than 3 V/m.		
c	SimplyGo incorporates a robust design and conforms with Radiated RF Immunity Test up to 10 V/m between 80 MHz and 2.5 GHz while the test requirement is 3 V/m.		

Recommended Separation Distance Between Portable and Mobile RF Communication Equipment and the Device			
SimplyGo is intended for use in the electromagnetic environment in which radiated RF disturbances are controlled. The user of SimplyGo can help prevent electromagnetic interference by maintaining a minimum distance between portable and mobile RF communication equipment (transmitters) and SimplyGo as recommended below, according to the maximum output power of the communications equipment.			
Rated Maximum Output Power of Transmitter (Watts)	Separation Distance According to Frequency of Transmitter (meters)		
	150 kHz to 80 MHz $d = 1.2\sqrt{P}$	80 MHz to 800 MHz $d = 0.35\sqrt{P}$	800 MHz to 2.5 GHz $d = 0.7\sqrt{P}$
0.01	0.12	0.04	0.07
0.1	0.37	0.11	0.22
1	1.17	0.35	0.70
10	3.69	1.11	2.21
100	11.67	3.50	7.00
For transmitters rated at a maximum output power not listed above, the recommended separation distance d in meters (m) can be estimated using the equation applicable to the frequency of the transmitter, where P is the maximum output power rating of the transmitter in watts (W) according to the transmitter manufacturer.			
Note 1:	At 80 MHz and 800 MHz, the higher frequency range applies.		
Note 2:	These guidelines may not apply in all situations. Electromagnetic propagation is affected by absorption and reflection from structures, objects, and people.		

Limited Warranty

Respironics, Inc. (“Respironics”) warrants the SimplyGo Portable Oxygen Concentrator System (the “Product”) as set forth in the following paragraphs.

Limited Warranty

Respironics warrants that the Product, except as otherwise stated herein, is free from defects in materials and workmanship under normal and proper use and when correctly maintained in accordance with applicable instructions, for a period equal to the warranty period purchased with the device, or if not otherwise specified, for a period of two (2) years from the date of shipment.

Products Not Under Warranty

Accessories and replacement parts, including, but not limited to, filters and fuses, are not covered under this warranty. However, Respironics warrants that the battery in the Product will be free from defects in material and workmanship, under normal and proper use and when correctly maintained in accordance with applicable instructions, for a period of 90 days from the date of shipment by Respironics to the original purchaser. This warranty does not apply to batteries that are dropped, misused, altered or otherwise damaged after they are shipped.

Limitations

If any Product purchased from Respironics fails to conform to the warranties set forth herein during the Warranty Period, as determined by Respironics in its sole discretion, Respironics may discharge its warranty obligation by repairing or replacing the Product, in Respironics’ sole discretion. This may be accomplished by installing new or remanufactured assemblies or components, or by other repairs deemed appropriate in the sole discretion of Respironics. The choice of repair or replacement by Respironics shall be the sole and exclusive remedy of the original purchaser. Respironics reserves the right, in its sole discretion, to refund the purchase price in lieu of repair or replacement of the Product. In no event shall Respironics’ maximum liability under these warranties exceed the price paid to Respironics by the original purchaser for the Product.

Conditions

This warranty does not cover damage or injury whether to the Product or to personal property or persons caused by accident, misuse, abuse, negligence, failure to install in accordance with Respironics’ installation instructions, failure to operate under conditions of normal use and in accordance with the terms of the operating manual and instructions, failure to maintain in accordance with the applicable service manuals, or alteration or any defects not related to materials or workmanship of the Product. This warranty does not cover damage which may occur in shipment. This warranty does not apply to any Product or individual part of a Product that may have been repaired or altered by anyone other than Respironics or an authorized Respironics service center. This warranty does not apply to any Product which is not purchased new.

Exclusions of Warranties

EXCEPT AS SET FORTH IN THIS LIMITED WARRANTY, RESPIRONICS MAKES NO WARRANTIES, EXPRESSED OR IMPLIED, STATUTORY OR OTHERWISE, REGARDING THE PRODUCT, ITS QUALITY OR PERFORMANCE. RESPIRONICS SPECIFICALLY DISCLAIMS THE IMPLIED WARRANTY OF MERCHANTABILITY AND THE IMPLIED WARRANTY OF FITNESS FOR A PARTICULAR PURPOSE. IN NO EVENT SHALL RESPIRONICS BE LIABLE FOR THE COST OF PROCUREMENT OF SUBSTITUTE PRODUCTS OR FOR ANY INDIRECT, SPECIAL, CONSEQUENTIAL, PUNITIVE, EXEMPLARY OR INCIDENTAL DAMAGES (INCLUDING, BUT NOT LIMITED TO, COMMERCIAL LOSS OR LOST REVENUES), FOR ANY CAUSE OF ACTION, WHETHER IN CONTRACT OR TORT, AND WHETHER OR NOT RESPIRONICS WAS AWARE OR SHOULD HAVE BEEN AWARE OF THE POSSIBILITY OF THESE DAMAGES. EXCEPT FOR THE OBLIGATIONS UNDER THIS LIMITED WARRANTY, RESPIRONICS SHALL NOT HAVE ANY OBLIGATION OR LIABILITY FOR ANY OTHER LOSS, DAMAGE OR INJURY RESULTING DIRECTLY OR INDIRECTLY FROM THE PRODUCT. PURCHASER’S SOLE AND EXCLUSIVE REMEDY FOR BREACH OF THE WARRANTIES SET FORTH IN THIS DOCUMENT SHALL BE AS PROVIDED IN THE PARAGRAPH DESCRIBING LIMITATIONS.

Purchaser is cautioned that no person or entity is authorized to make any warranties on behalf of Respironics and any such alleged warranties are hereby disclaimed by Respironics.

Respironics Inc.
1001 Murry Ridge Lane
Murrysville, PA 15668 USA

Respironics Deutschland
Gewerbestr. 17
82211 Herrsching, Germany

