

PICTORIAL PARTS BOOK & PRICE LIST

Effective January 2020

RAZOR **RAZOR**^{HR-7}

HVWash
HIGH VELOCITY

REVV



WASHWORLD

2222 American Blvd. | DePere, WI 54115
920.338.9278 | 888.315.7253 | 920.338.0552 (fax)
www.washworldinc.com
email: parts@washworldinc.com

All prices are F.O.B. DePere, WI and are subject to change without notice.

Distributed By:



RETURNED MATERIALS AUTHORIZATION (RMA) POLICY

1. Contact Washworld or your local Washworld distributor and request a "Returned Materials Authorization" (RMA) number. Include the following information:
 - What failed?
 - Cause of failure?
 - Invoice number and the date of purchase.
2. A description of the failure must be written on the form along with the RMA number and returned with the defective component within 45 days **freight prepaid** to Washworld Inc. Components returned without an RMA number, incomplete information, or later than 45 days will be ineligible for credit.
3. Washworld Inc. will send a replacement component to the local Washworld distributor or customer and will invoice the distributor or customer for the replacement part after 45 days if we have not received the part back in satisfactory condition or if the part is not covered under warranty. **Any shipping charges other than UPS ground will be invoiced to the distributor or customer.**
4. Upon receipt of the defective part and RMA form, an examination will be conducted to determine cause of failure. Following the RMA examination, Washworld Inc. will determine if the returned component will be covered by the warrant

TERMS AND CONDITIONS

Telephone & Fax Orders

When calling, please provide the following information:

- Carwash or company name
- Shipping address
- Shipping method
- Credit card number (VISA, MasterCard, American Express, Discover)
- Item number, description, quantity
- P.O. number or name of individual authorizing purchase

Shipping Policy

- All orders are shipped ground UPS or common carrier unless special arrangements are requested.
- Shipping charges are the responsibility of the customer and will be added to all orders.
 1. A \$3.00 shipping and handling fee will be added to all orders shipped via UPS.
 2. An additional charge will be added when a common carrier is required due to crating and packaging.
- All orders are F.O.B. Washworld.

Prices

- All prices are subject to change without notice.
- Orders will be invoiced at the current price at the time of order (prices are subject to change without notice).

Warranty

All parts sold, excluding parts deemed "wear items", carry a 90 day Washworld warranty or an extended warranty designated by the OEM Manufacturer's warranty, whichever is longer. Warranty inquiries should be directed to the Washworld Technical Support Department at (888)315-7253.

NOTE: Components deemed "wear items" include, but are not limited to: nozzles, belts, hoses, injectors, fuses, tires, rollers, shear bolts, LED's, light bulbs, bearings, bumpers, etc. are not covered under this warranty.



RMA Request

Returned Materials Authorization

Customer: _____

Contact Person: _____

Address: _____

Telephone: _____

RMA Number: _____ (provided by Washworld)

Serial Number: # _____

Part #	Description
1.	
2.	
3.	
4.	

NOTE: Parts returned without an RMA number will not be credited and may be returned to the sender.

2020 PICTORIAL PARTS BOOK



TABLE OF CONTENTS



.....	Pages
.....	1-11
Carriage.....	1,2
Trolley.....	2,3
Vehicle Measuring (Treadle, Top and Side Sonar).....	3
Flags and Festoon.....	3
T-Bars and Triple Foam.....	4
Spray Arch.....	4
Overhead Assembly and Overhead Manifold.....	5
Pump Station.....	5-8
UCC (Ultimate Control Cabinet).....	8-9
Junction Boxes.....	9-10
Miscellaneous Parts.....	11
Wall Mount Brackets.....	11



.....	Pages
.....	12-31
Carriage.....	12-13
Trolley.....	13-15
Spray Arch.....	15-16
Triple Foam, Flex Pass®, Energy Chains.....	17
Flags, Belt Tensioners, Belts.....	18
Pump Station.....	19-22
Overhead Manifold.....	22-23
Ultimate Control Cabinet (UCC).....	23-25
Junction Boxes.....	25-26
RF Remote.....	26
Audio.....	27
Rear/Side Sonar Assemblies.....	27
Loading Eyes.....	27
Undercarriage, Power Tower Wheel Cleaner™.....	28
Y-Bars.....	28
Machine Covers.....	29
Foam 'n Flow®, HyperFlex™, SpectraRay™.....	29-31



.....	Pages
.....	32-33
Carriage, Trolley.....	32-33
Pump Station.....	33



.....	Page
.....	34
Carriage, Trolley, Arch.....	34

Interior / Exterior	Pages
Lighted Instructional.....	35-36
Signage	
24VAC LED Instructional Signage.....	35
12VDC LED Instructional Signage.....	36



.....	Page
.....	37
Dryer and Oscillator Parts.....	37

Washworld 2020	Page
Price List (Effective.....	38 to
Jan. 1, 2020)	End

GLOSSARY OF TERMS

Abbr.	Meaning	Abbr.	Meaning	Abbr.	Meaning
NP	Not Pictured	HP	Horsepower or High Pressure	PSI	Pounds per Square Inch
A	Amp	Hz	Hertz	PVC	Polyvinyl Chloride
B	Bottom	LP	Low Pressure	SST	Stainless Steel
BR	Brass	M	Meter	ST	Straight
DEG	Degree	NC	Normally Closed	T	Top
DS/LS	Driver Side (Domestic) / Left Side	NO	Normally Open	TF	Triple Foam
ENT	Entrance	NPT	National Pipe Thread	UB	Underbody
EX	Exit	OBD	On Board Dryer	VA	Virtual Attendant®
FTG	Fitting	OH	Overhead	VAC	Volts Alternating Current
FSF	Free Standing Frame	P	Pole	VDC	Volts Direct Current
GPM	Gallons Per Minute	PH	Phase	WM	Wall Mount
H	Hose	PS/RS	Passenger Side (Domestic) / Right Side		



2020 PICTORIAL PARTS BOOK



CARRIAGE

M578914	Grease line, Rear Black Roller
36902-T	1.3 HP Carriage/Trolley Motor
17940-R3	Gear Box 30:1 Carriage/Trolley
17942-R3	Gear Box 50:1 Carriage/ Trolley
M688936	Carriage Gear Box Key (Supplied with gearbox purchase)

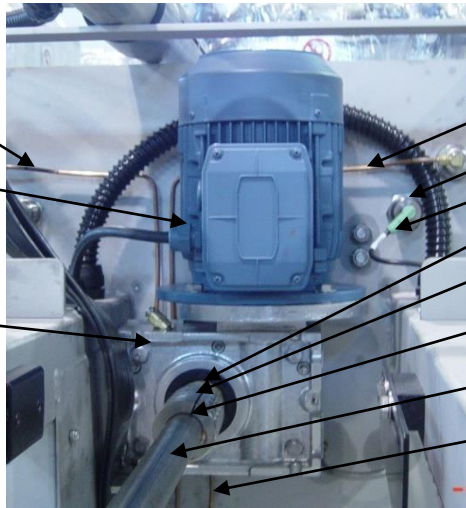

M578918	Grease Line, Front Black Roller
91915	Prox Switch 30mm
33259	Prox Cord, 90 deg
M598891	Drive Shaft PS/RS
12091	Drive Coupling, 1-3/16"
M688933	Drive Coupling Key, 1/4" x 1/4" (2 Each)
M598896	Drive Shaft, 1-3/16" x 120"
M578909	Grease Line, Side Flange Bearing

8906	Bearing, Pillow
12091	Drive Coupling 1-3/16"
66799-B	Coupling
77094	U-Bolt (T-Bar Clamp)
22910-FB	Comp. Fitting ST
10789	Manifold, Grease 4 Hole

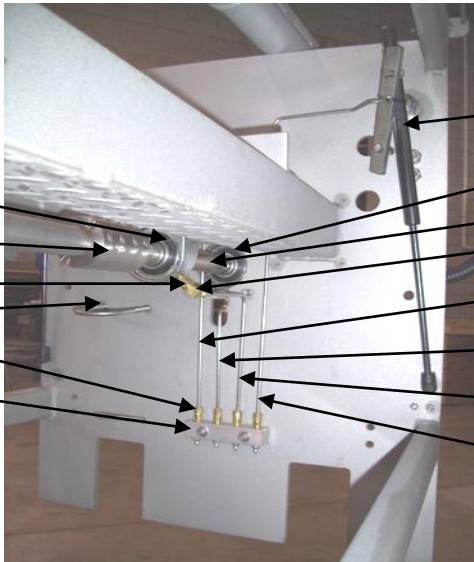

90989	Fiberglass shock (2 Each Side, 4 Total)
9106	Bearing, Flange 4 Bolt
M598892	Drive Shaft, DS/LS
23170-FB	Comp Fitting, 90 deg
M578916	Grease Line, Front White Roller
M578909	Grease Line, Side Flange Bearing
M578910	Grease Line, Pillow Block
M578915	Grease Line, Rear White Roller

M618939	Roller, Black (PS/RS) (2 per)
M618889	Roller, White (DS/LS) (2 per)
91915	Prox Switch, 30 mm (3 Each: Front, Mid, and Rear)
M518952	Plate
M499019	Safety Bracket
91039	Ball Stud
77891	Latch

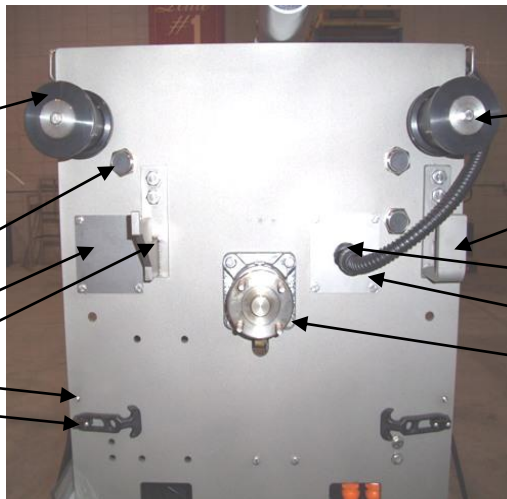

M638902	Washer
M598905	Roller Shaft, Carriage (4 Each - not shown)
M499018	Safety Bracket
34894-1/2	1/2" Conduit
34973	1/2" Conduit Conn. 90 deg
M518953	Plate w/Hole
9106	Bearing, Flange 4 Bolt



2020 PICTORIAL PARTS BOOK



M508902	Pulse Target Flag (Width Measure)
M328911-S	Flag, Left Limit HV (DS/LS)
M328908-S	Flag, Right Limit HV (PS/RS)

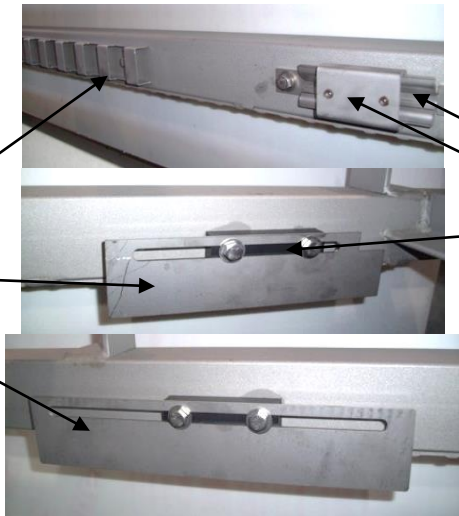

M498901	Home Target Bracket
M498900	Home Target
M658900	Block, Rail Flag
37791	Heat Strip, Trolley Rails (1 Per Rail)

91914	Prox Switch 30mm (3 Each: Left, Right, and Width Measure)
36902-T	1.3 H.P. Carriage/Trolley Motor
17940-R3	Gearbox 30:1 D80 (Carriage/Trolley)
17942-R3	Gearbox 50:1 D80 (Carriage/Trolley)

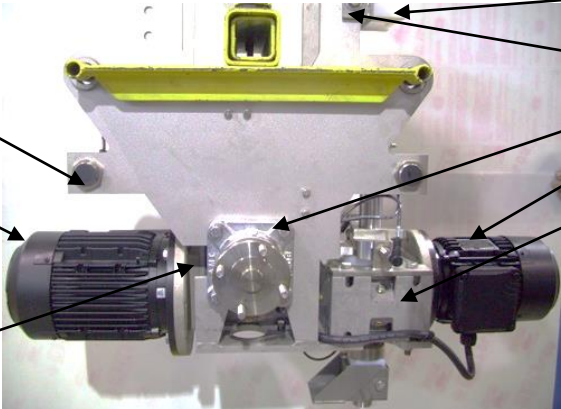

M658889	Bearing Block, UHMW
M309051	Bearing Block Bracket
9106	Bearing, Flange 4 Bolt (2 per Trolley)
36898-D	0.5 HP Motor, Arch
17941-R3	Gearbox 50:1 D71 Flange (Arch Only)

TIRES, TUBES, AND RIMS (4 per machine)	
15789	Tire, 4.10/350
15790	Tube, Inner
15791-S	Rim, 4 x 1 5/16" (2 Per Tire, 8 Total)

M598895	Shaft, Trolley Drive (2 Per Trolley)
91909	Prox Switch 12 mm (3 Each)
33259	Cord, Prox 90deg
M308938-S	Prox Bracket, Arch Single

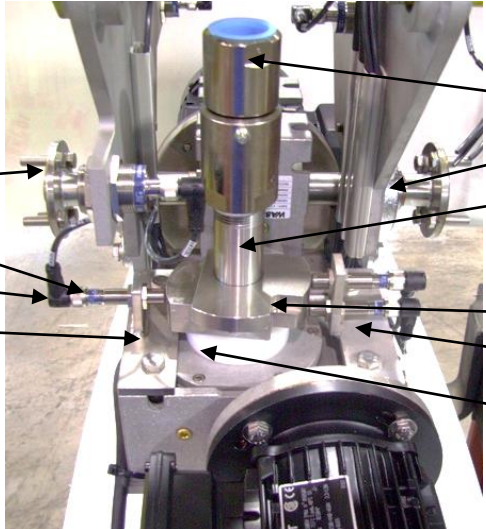

65389	Swivel, Straight 1"
9106	Bearing, Flange 4 Bolt
M598890	Shaft, Hollow Arch
11802-2S	Hol. Shaft Key (HV)
11802-1.90S	Hol. Shaft Key (Laser)
M638891	Index Cam, Arch SS
M308937-S	Prox Bracket, Arch Double
M638900	Washer, UHMW Arch



2020 PICTORIAL PARTS BOOK

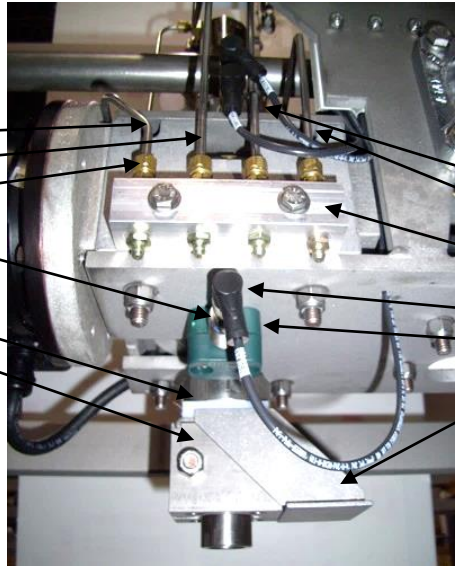

M578911	Grease Line, 1 SS
M578912	Grease Line, 2 SS
22910-FB	Comp Fitting, ST
91910	Prox Switch, 18mm (1 Each)
90899	Spring, Comp (NP)
M288916	Lift Block Assy.
M658891	Clamp Block
M688934	Clamp Block Key (NP)

M578917	Grease Line, 3 SS
M578919	Grease Line, 4 SS
10789	Manifold, Grease 4 Hole
33259	Cord, Prox 90 deg
73296	Clamp
M328896	Lift Plate

The following sonar is a direct replacement for the discontinued sonars listed on the right side of this page. This sonar does not require a transducer in the carriage box.

33530001	Sonar, P&F 30mm
33272	Cord, Sonar (P&F)
50480001	Sonar Update Kit (Contains above sonar, cap w/hole, and cord)
M688900	Cap 2 1/2"
M309098	Side Sonar Bracket (Retrofit Only)
M688901	Cap 2 1/2" w/hole
MISCELLANEOUS CORDS	
33264	Cord, Sonar (APG)
33260	Cord, Sonar (AB)

VEHICLE MEASURING

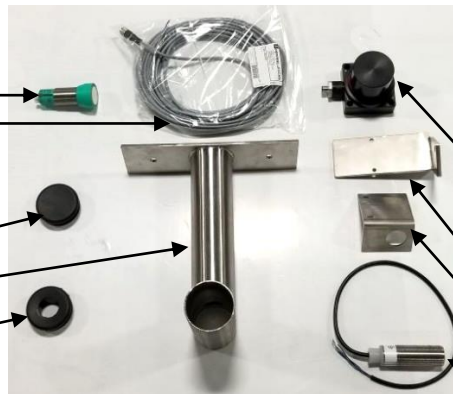

The following three parts (below) have been discontinued. Limited quantities are available.

91903	Sonar, Transducer (APG)
91902	Sonar, Electronics (APG)
91904	Sonar, Side (AB) (Blue)
Top Sonar	
91901	Sonar, Width Measure (Top)
33264	Cord, Sonar (NP)
Floor Treadle	
M308934-S	Bracket
M519379	Bracket
91990	Treadle Eye

37801	Heat Strip, Carriage Rail (1 Per Rail)
WW072	Festoon Kit (Complete)
Individual Festoon Cables	
Blue (J3 to J4)- 33295-192 BLU	
Red (J3 to J2)- 33295-429 RED	
Yellow (J3 to J2)- 33295-429 YEL	
Green (J4 to J2)- 33295-600 GRN	
33289-S	Festoon Connector Clamp
33294-S	Festoon Support Bracket
33292-S	Festoon Track SST 13' (not shown)

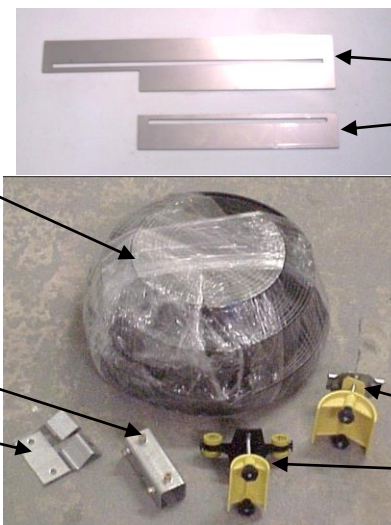

M330885-S	Flag, Home HV SS
M330889-S	Flag, Rail SS
Carriage Rail Flags for Front, Middle, and Rear Limits	
HV with Floor Treadle Requires (3) - M330889-S (Front, Mid, Rear)	
HV with VS2° or VS2° Enhanced (Top Sonar or Side Sonar, No Floor Treadle) Requires:	
(1) - M330885-S (Front/Home)	
(2) - M330889-S (Mid and Rear)	
33291	Festoon, Cable Clamp Stationary
33293	Festoon Roller



2020 PICTORIAL PARTS BOOK



T-BARS

M668889	T-Bar Mounting Bracket
34973	1/2" Conduit Conn. 90deg
34895-1/2	1/2" Conduit
M668889	T-Bar Mounting Bracket
91918	Actuator, T-Bar
91917	Read Switch, T-Bar
M228893-A	Plate with Heat Strip (2 per T-Bar)
M688898	T-Bar End Cap (2 Per T-Bar)

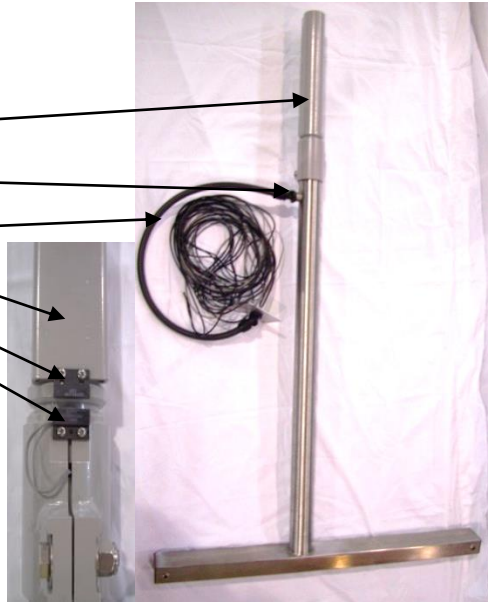

INFRARED SENSORS AND AMPLIFIERS	
TELCO	
92077-L	Amp, Telco Single Channel
92075-L	Transmitter, Telco 15m
92076-L	Receiver, Telco 15m
PANTRON	
92078	Amp, Pantron (single channel)
92075-15	Transmitter, Pantron
92076-15	Receiver, Pantron
CARLO GAVAZZI	
92084-24VAC	Amp, Carlo (single channel)
92073	Transmitter, Carlo
92074	Receiver, Carlo

TRIPLE FOAM

62046	Valve, Check 3/8" T (12 per)
41400001	Fitting, Tube Double 3/8" T x 1/2" npt (6 per)
M110067	Plate, Adapter HV TF (2 per)

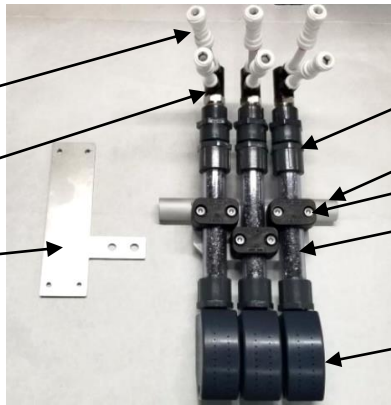

66576-P	Reducer, PVC 3/4" F x 1/2" F (6 per)
M508915	Bracket, Triple Foam Mount (2 per)
73905	Clamp, 1" (6 per)
43200001	Foamer Assy, SST w/material (6 per)
43210001	Foamer Material (NP) 6 per)
95100-A	Foamer Head, Dual Stream (6 per)

SPRAY ARCH

13976	Bumper, GBA-8
M658902	Washer 1/8"
M658901	Washer 1/4"
M358900	Manifold Weldment (VA)
M358890	Manifold Weldment, (NON-VA) (NP)
M358905	Manifold, Side Arch

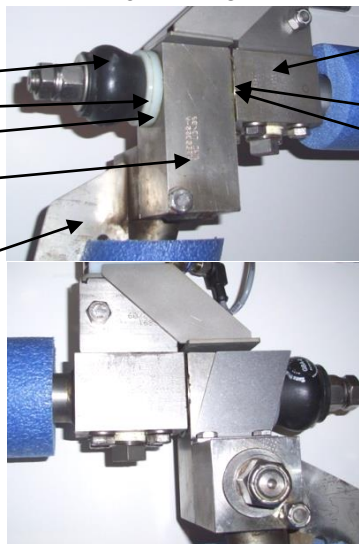

WW007	Arch O-Ring Kit (NP)
M358901	Manifold, Top Arch (VA)
M358891-7	Manifold, Top Arch (NON-VA) (NP)
10715-R	Retaining Ring (VA)
10715	Bearing, 3/8" (3 Each, VA)
10714	Bearing, 7/16" (4 Each, NON-VA) (NP)
M500889	Angle Clip
M688890	Shear Bolt

PROTECTIVE ARCH FOAM (BLUE)	
68893	Top Arch Foam (Blue)
68892	Side Arch Foam (Blue)

NOZZLE KITS	
WW010-7-HV	Noz. Kit, HV VS2° w/UB
WW010-7-HV-S	Noz. Kit, HV VS2° w/O UB
WW011-7	Noz. Kit, 7-hole w/UB



2020 PICTORIAL PARTS BOOK



OVERHEAD ASSEMBLY

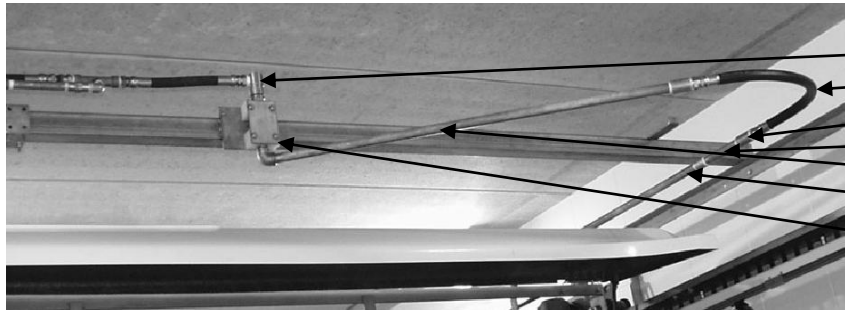

65391-P	Swivel, 90deg
42800	Hose, 1" x 43.5"
66689-8S	Coupling, 1" Full
65904-L6S	Nipple, 1" x 8" SS
M388898	Pipe, 90deg OH
M548896	Pipe, Bent
M658889	Bearing, UHMW (2 per)

OVERHEAD MANIFOLD

M519604	Bracket, L-Shaped (OH)
M518970	Plate, 4 1/2" 4 Holes (NP)
62071	Valve, Relief 150psi
M358986	Manifold, Foamer OH
65903-4S	3/4" Nipple Close
66382-4S	3/4" Elbow, Street
73916	Clamp, Tube
62030-F	3/4" Check Valve
65391-P	Swivel, 90 deg
42791	Hose, 1" x 18"

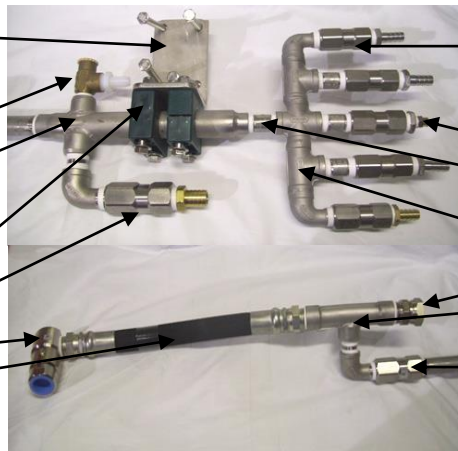

62031	1/2" Check Valve SS (5 Each)
67006-MS	1/2" Hose Barb, SS (3 Each)
22914-PB	Fitting, Tube 1/4"
M358920	Nipple, Foamer
90888	Mesh Material
M358951	Manifold, LP (OH)
43451	Swivel, Hyd. Ftg.
M358985	Manifold, Tee
65903-L4S	Nipple, 3/4" x 8"
62030-F	3/4" Check Valve

PUMP STATION

M358944	Manifold, TF
43442-S	Swivel, Hyd Ftg 3/8"
61930	Valve, Danfoss 3/8"
61929	Coil, Danfoss
61915	Valve, 3/8" Dema SS NC (replacement for 61929 and 61930)
BRASS INJECTORS	
62433	.083 Inj. BR
62344	.070 Inj. BR
STAINLESS INJECTORS	
62369	.057 Inj. SS
62375	.083 Inj. SS
62376	.086 Inj. SS
62377	.098 Inj. SS
62379	.083 Inj. SS (DUAL)
46130002	Valve, Pressure Relief LP Greaseable (62066 equivalent)

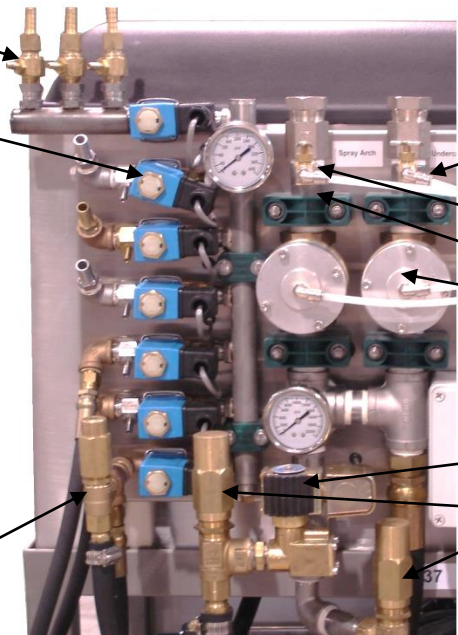

62062	Valve, Check 2000 psi 1/4"
62052	Valve, Needle 1/4"
M548930	Manifold, 1" x 4" 1 Hole (2 Per)
73916	Clamp
62157	Valve, Lex Air 1"
62157-KIT	Rebuild Kit, Lex Air
62158-KIT	Rebuild Kit, Lex Air 1" (Non-4 Bolt Pattern)
62196-24	Valve, Sol. 1/2" NC
46130001	Valve, Press. Reg. Greaseable (2 Each)



2020 PICTORIAL PARTS BOOK



23936	Gauge, 0-300psi
M358948	Manifold, 9 Hole (LP Man.)
23237-PB	Fitting, Tube 1/4" x 3/8" 90deg
M100007	Manifold, Tee w/Hole
24000	Gauge, Pressure 0-2000psi
33914	Enclosure (J1)

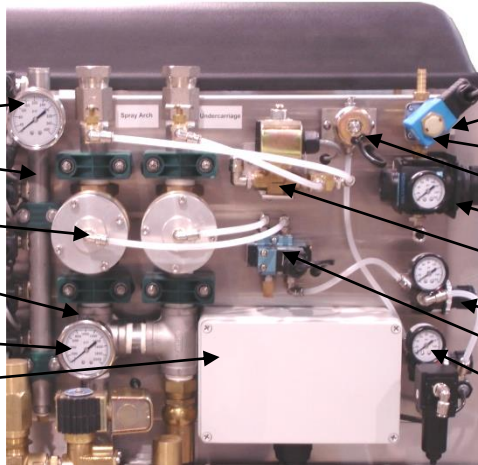

61930	Valve, Danfoss 3/8"
61929	Coil, Danfoss 24 VAC
61924	Valve, Skinner 1/8"
25050	Regulator, Air 3/8"
62192-24	Valve, Sol. NO 3/8" (Weep)
25049	Regulator, 1/4"
21004	Valve, Sol. 4 Way (Mac)
23920	Gauge, 0-160psi

61930	Valve, Danfoss 3/8"
61929	Coil, Danfoss
61915	Valve, 3/8" Dema SS NC (replacement for 61929 and 61930)
61931-C	Cord, DIN 2 Cond.
INJECTORS	
62369-X	.057 Inj. (RED)
62344-X	.070 Inj. (RED)
62375-X	.083 Inj. (GRAY)
62376-X	.086 Inj. (BLUE)
62379-X	.083 Inj. (DUAL PORT)
62304	Metering Tip Kit
46130002	Valve, Pressure Relief LP Greaseable (62066 equivalent)

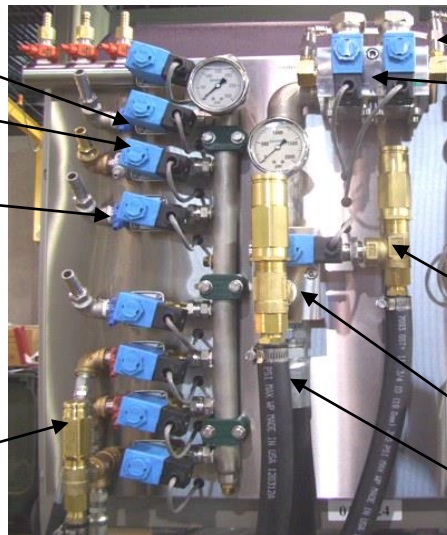

62062	Valve, Check 1/4" 2000 psi
61952	Valve, Sol 1" Dual Port NO/NC
61953	Stem, NO (61952 - 1 per)
61954	Stem, NC (61952 - 1 per)
61952-KIT	Rebuild Kit (For 61952 Valve)
46130001	Valve, Press. Reg. (2 EACH)
46260002	Rebuild Kit (46130001 and 46130002 valves)
61951	Valve, Res. Conservation HP Unloader
42790-22	Hose, 1" x 22"

23936	Gauge, 0-300psi
24000	Gauge, 0-2000psi
M548933	Manifold, 1" x 6" w/Hole

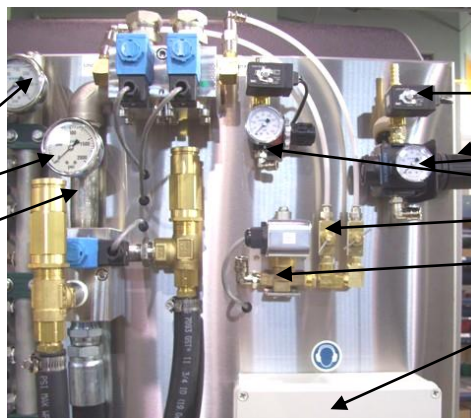

61915	Valve, Sol. 3/8" NC
25050	Regulator, Air 3/8"
23920	Gauge, 0-160psi
25049	Regulator, Air 1/4"
62052	Valve, Needle 1/4"
62192-24	Valve, 3/8" NO (Weep)
33914	Enclosure, J1



2020 PICTORIAL PARTS BOOK



MAIN TANK

STAINLESS TANK CONFIGURATION (DISCONTINUED)	
62163	Valve, Float 1"
62162	Valve, Float 3/4"

61941	Valve, Sol 3/4" NC PL Dema (NP)
61939-DF	Valve, Sol. 1" NC Danfoss
61929	Coil, Danfoss 24VAC
61939-C	Cord, Danfoss 53"

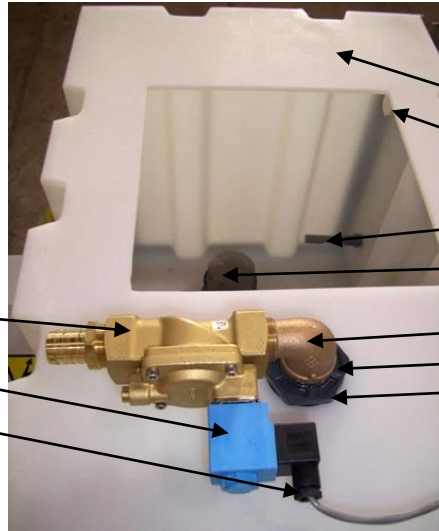

M348894	Tank, Poly
91992	Sensor, 24VDC, High Level Switch
29908	Low Level Float Switch, 1/4"
64991	Strainer, 2"
65907	Nipple, Close 2' PVC
66384-4B	Elbow, Street 1" BR
66904-4B	Nipple, Close 1"
66577-TT	Bulkhead, Ftg. 1"

42790-22	Hose, 1" x 22"
41938-28	Hose, 3/8" x 1/4" x 28"
41937-28	Hose, 3/8" x 3/8" x 28"
41938-30	Hose, 3/8" x 3/8" x 30"
61589	Pump, CAT 3535
36928	Motor, 25HP 50/60 Hz
36929	Motor, 25HP 575V (NP)
M538921	Belt Guard Inner
M538920	Belt Guard Outer (NP)

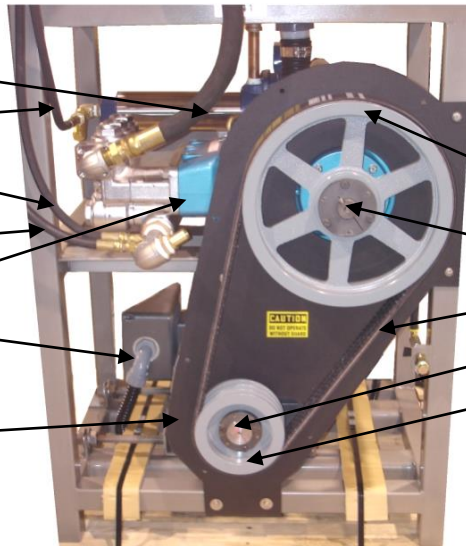

10932-3SK	Sheave, 3B13.6 SK Cat Pump
11408-SK	Bushing, Sheave 35mm SK
9956-3BX	Belt, 3V 67"
11421-SD	Bushing, Sheave 1- 7/8" SD
10917-3SD	Sheave, 3B6.2 SD

CAT PUMP OIL, 2.5 GAL - 43949			GENERAL PUMP OIL, 2.5 GAL - 43951		
CAT PUMP SEAL KIT (1 PER PUMP) – 61589-S-KIT			CAT PUMP VALVE KIT (2 PER PUMP) – 61589-V-KIT		
CAT PUMP (PART# 61589)					
Lower Sheave	Upper Sheave	Belt	Voltage	Upper Bushing	Lower Bushing
10917-3SD	10932-3SK	9956-3BX	208/230	11408-SK	11421-SD
10934-3SK	10932-3SK	9957-3BX	380/415	11408-SK	11421-SK
10917-3SD	10932-3SK	9956-3BX	575	11408-SK	11421-SD
GENERAL PUMP (PART# 61540)					
Lower Sheave	Upper Sheave	Belt	Voltage	Upper Bushing	Lower Bushing
10915-3SD	10932-3SK	9962-3BX	208/230	11409-SK	11421-SD
10934-3SK	10932-3SK	9962-3BX	380/415	11409-SK	11421-SD



LOW PRESSURE SOLUTION PUMPS

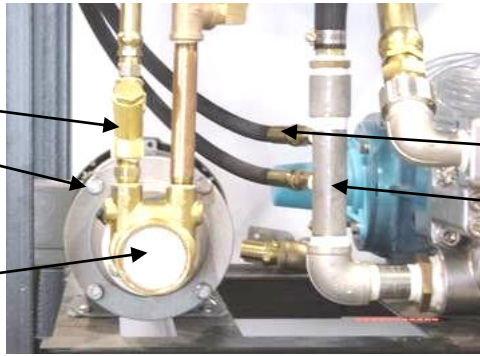

2P808	Y-Strainer, 1/2"
36904-I	Motor, 1- 1/2" HP, 3PH
36904-E	Motor, 1- 1/2" HP, 1PH
61037	Coupling, Drive
61048	Pump, Fluid-O-Tech

41939-41	Hose, HYD 3/8" x 41"
M548932	Manifold, 1" x 6" w/ 3 Holes

61050	Pump, Sta-Rite 1.5HP 3PH 60 Hz HP6FE (Solution Pump Only)
61060	Rebuild Kit, Sta-Rite (For HP6FE)
61050-50	Pump, Sta-Rite 1.5HP 50Hz (Intl. Solution Pump)



REPLACEMENT PUMPS	
61189	Pump, Sta-Rite 1HP 1PH (Spot Free Pump Only)
61190	Pump, Sta-Rite 1HP Noryl Impeller (Flex Pass® Pump Only)

UCC (ULTIMATE CONTROL CABINET)



PVP 400	Panel View Plus 400 (Washview)
83455	Decal, UCC

TEMPERATURE PROBES AND CORD (NP)	
91985	Temperature Probe
33255	Cord, Temp Probe 50'

30005	Switch, Sys. Stop (AB)
30004	Switch, Sys. Stop (Shamrock)
30098	Contact Block, NC (AB)
30099	Contact Block, NC (Shamrock)

UCC COMPONENTS

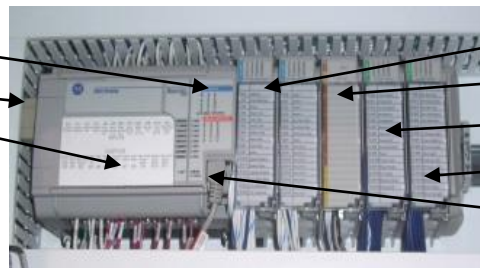

3629	PLC Base, 1764 24 BWA
98560	Cable, Modem
3632	PLC, 1764 LRP
3633	Battery, 1500 PLC (NP)
3637	Memory Module (Req. program)

3651	Input Card, 1769 IQ 16 (2 Each)
3650	Analog Card
3659	Output Card, 1769 OB16 (2 Each)
3645	End Cap, 1769
98561	Cable, Comm. Micrologic

2020 PICTORIAL PARTS BOOK



36556-MG	Circuit Brkr 6A 2P
36480-AB	Circuit Brkr 10-16A 3P
36477-MG	Circuit Brkr. 6A 3P



36428-MG	Circuit Brkr 10A 1P (110VAC Lights)
31580001	Circuit Brkr 4A
37403	Power Supply, 12VDC (Lights)

28894-AB	Contactor, 9A AB (5 Each)
29391-AB	Overload, 1.6A – 5A AB

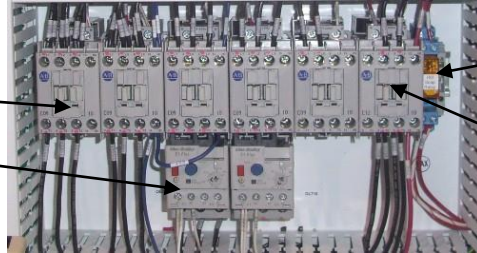

30995	Relay Base (Hot Soap Relay)
30907	Relay Cube 24VAC (Hot Soap Relay)
28916-24AB	Contactor, 12A AB
29408-AB	Overload, 3.7-12A AB

10040-FI	Relay and Socket 24VDC
10042-FI	Relay 24VDC (Blue cube)
10043-FI	Relay Base

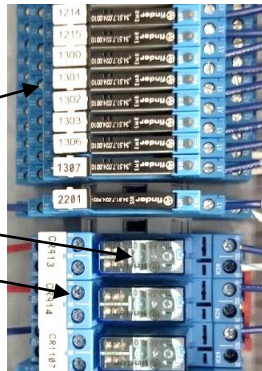

34130001	Strip, Jumper, 20W Blue (10040-FI compatible) (NP)
34130002	Strip, Jumper, 20W Red (10040-FI compatible) (NP)

37647	Drive, Variable Freq. 2HP 3PH (AB Powerflex)
37648	Drive, Variable Freq. 2HP 1PH (International – 50Hz)



HIGH SPEED COMMUNICATION (NP)	
33190001	Module, ENI RTA
98561	Cable, Communication

DIAL-UP COMMUNICATION	
92596	Filter, Phone Cable, Communication Modem
98560	Communication Modem
92595	Modem, USR 56K

J1A/ HP PUMP STARTER

29091	Contactor, 80A
29396	Overload, 63-80A

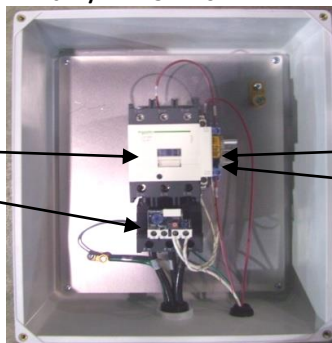

30907	Relay, Cube 10A 24VAC
30995	Relay Base



2020 PICTORIAL PARTS BOOK



J3 / CARRIAGE BOX

33939	Enclosure, Carriage/J3
33940	Panel, J3
10017-WG	Jumper, Strip (Wago)
10010-WG	Term. Block 3W (Wago)
10007-WG	Term. Block 2P (Wago)

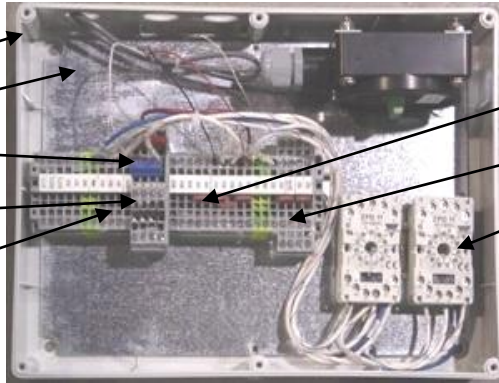

10015-WG	Jumper, Term. (Wago)
10008-WG	Term. Block 4P (Wago)
31019	Relay Socket 11 Pin (2 Each)
Refer to page 4 for infrared amplifier information	

J2 / BAY BOX

INFRARED AMPLIFIERS	
92078	Amp, Pantron 24VAC Self Diag (Shown)
92084-24VAC	Amp, Carlo Gav. 24VAC (NP)
92077-L	Amp, Telco 24VAC (NP)
10007-WG	Term. Block 2P (Wago)

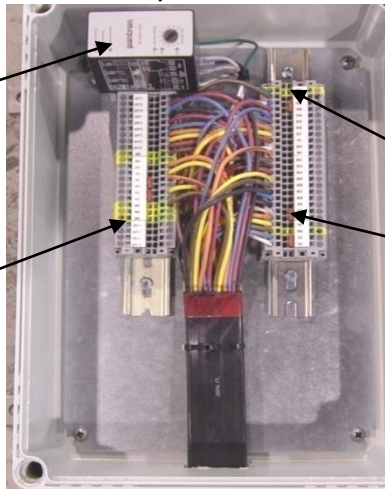

10009-WG	Term. Block 2P Ground (Wago)
10015-WG	Jumper, Term (Wago) (White)

J4 / TROLLEY BOX

33944	Enclosure, J4
10007-WG	Term. Block 2P (Wago)
10009-WG	Term. Block 2P Ground (Wago)
35291	Strain Relief (4 Each)

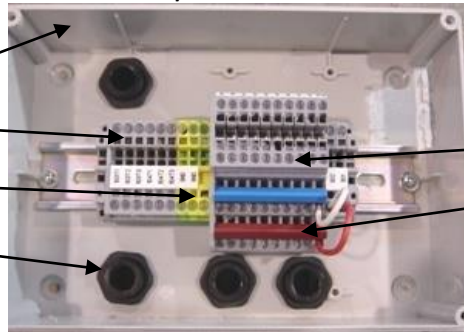

10010-WG	Term. Block 3W (Wago)
10017-WG	Jumper Strip (Wago)

J6 / JOYSTICK BOX

33959	Enclosure
30789	Operator, Joystick 4 Pos.
29994	Switch, Push Button
30094	Contact Block, NO (Arch Rotate and Key Switch)

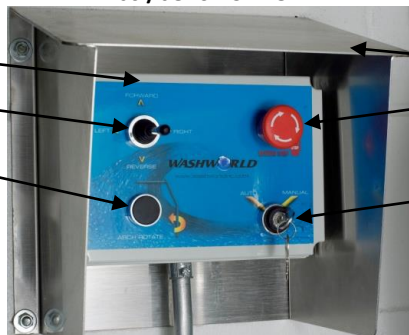

M379990	Shroud, Joystick
30004	Switch, Sys. Stop
30099	Contact Block NC (Sys. Stop)
29999-2POS	Key Switch, 2 Pos.
29999-3POS	Key Switch, 3 Pos.
30000	Key, Replacement



2020 PICTORIAL PARTS BOOK



MISCELLANEOUS PARTS (LASERWASH 4000 QUALITY OEM PARTS)

NOTE: *Laserwash is a trademark of PDQ Mfg. Not affiliated with PDQ Mfg.

ASSEMBLY OF PARTS REQUIRED IF USING WASHWORLD SHAFT FOR HIGH VELOCITY® ONBOARD OR LASERWASH 4000 DOCKING DRYER

8902-1	Bearing
8902-2	Seal
M638903	Spacer
M638902	Washer



M618948	Roller, Black
M618947	Roller, White
8902-1	Bearing
8902-2	Seal
M638903	Spacer
M598905	Shaft, Roller

ASSEMBLY OF PARTS REQUIRED FOR LASERWASH 4000 DOCKING DRYER IF LASERWASH SHAFT IS USED

8902-1	Bearing
8902-2	Seal
M638902	Washer



M618948	Roller, Black
M618947	Roller, White
8902-1	Bearing
8902-2	Seal

WALL MOUNTS

M389013-S (*)	Tie Rod, 3/4" x 14 5/8"
M389011-S (**)	Tie Rod, 3/4" x 16 3/4"
M389010-S (*)	Tie Rod, 3/4" x 24 3/4"
M389012-S (**)(***)	Tie Rod, 3/4" x 28 3/4"
M389018-S (***)	Tie Rod, 3/4" x 35 5/8"
M309077	Bracket, Rail Mount
M528919-S	Angle, 3/4" x .25 x 2" SS w/ Holes
(*) = 14' 1" to 16' 1" Wall Mt.	
(**) = 16' 1" to 16' 8" Wall Mt.	
(***) = 16' 9" to 18' Wall Mt.	



Tie rods, rail supports, angle wall mounts, and rail mount brackets are the same for High Velocity®, Razor®, and Revv® machines. Length of tie rods will be determined by bay width. Tie rods shown are for standard 14' 1" to 16' bay width.

M389013-S	Tie Rod, 3/4" x 14 5/8"
M308982-S	Bracket, Rail Support SS
M528918-S	Angle Wall Mount SS
M389010-S	Tie Rod, 3/4" x 24 3/4"

HIGH VELOCITY® UPGRADES

CALL WASHWORLD TECHNICAL SUPPORT (920-338-9278) FOR PRICING AND AVAILABILITY

- VS2® and Virtual Attendant® upgrades
 - Poly tank upgrades
 - Solution pump upgrades
- Inquire today!



2020 PICTORIAL PARTS BOOK



CARRIAGE (PASSENGER/RIGHT SIDE)

M688943-2	Key, 1/4" x 1 1/2"
M618939	Roller, Black
M618889	Roller, White
M598906	Shaft, Carriage Roller R3 (4 Per Machine)
M638902	Washer
M618951	Roller, Idler (4 Per Machine)
M598911	Shaft, Idler Roller
M638899	Washer
12389	Snap Ring (2 Per Roller)

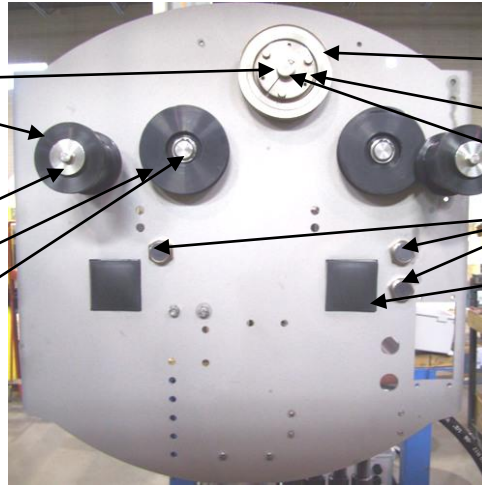

8950	Drive Gear Carr/Trolley (2 Each)
8953	Bushing, Carriage Drive (2 Each)
M598898	Shaft, Carr. Drive
91915	Prox Switch, 30mm (3 Each)
M688899	Cap, 3" x 3" (2 Per Side)
M500002	Bracket, Safety (Over Rail) (2 Per Side)
M500000	Bracket, Safety (Under Rail) (2 Per Machine)

M688943	Key, Drive Shaft. 1/4" x 9 3/8"
M508908	Flag, Carr. Pulse
M508900	Bracket, Carriage Pulse
91912	Prox Switch 18mm Short
M578937	Grease Line Idl. PS Ex
M578933	Grease Line, Carr. PS Ex
91915	Prox Switch 30mm (3 Per Machine)
33259	Cord, Prox

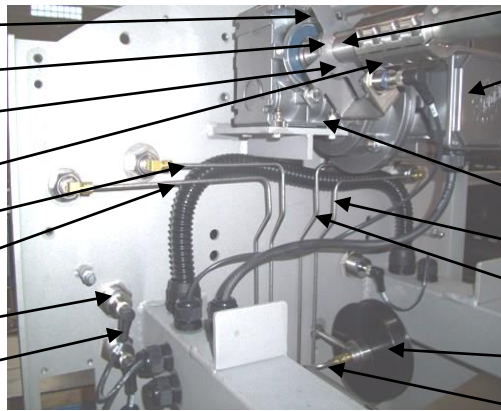

M598898	Shaft, Carriage Drive RZR
36905	Motor, Carriage / Trolley .37 Kw
36907	Motor, Carriage .75HP (On-Board Dryer Only - NP)
17948	Gearbox, Carriage / Trolley
M578934	Grease Line PS En
M578938	Grease Line Idl. PS Ent
M508904	Idler Pulley Assembly
M578940	Grease Line Idl. Bearing

CARRIAGE (DRIVER/LEFT SIDE)

M598899	Shaft, Drive 1" x 126"
12092	Coupling, 1"
36905	Motor, Carriage / Trolley .37Kw
17948	Gearbox, Carr / Trolley
8950	Drive Gear Carriage / Trolley
8952	Bushing, Trolley Drive
9970-K	Belt, Trolley

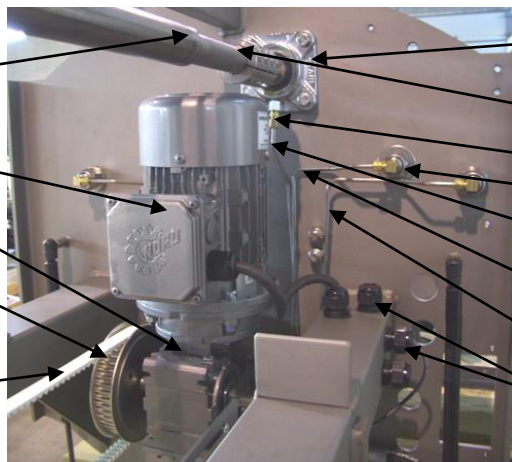

8907	Bearing, 4 Bolt 1"
M598888	Shaft, Drive 6 1/2"
M688943-4.5	Key, 1/4" x 1/4" x 4 5/8"
22910-FB	Fitting, Comp ST
23170-FB	Fitting, Comp 90deg
M578930	Grease Line, Carr. Drive Shaft
M578935	Grease Line, Idl. DS. EX
M578931	Grease Line, Carr. DS EX
35304	Strain Relief



2020 PICTORIAL PARTS BOOK



M578936	Grease Line, Idl. DS ENT
M578932	Grease Line, Carr. DS ENT
8950	Drive Gear Carriage / Trolley
8952	Bushing, Trolley Drive
90991	Cover Shock 60lbs. (2 Per Side)

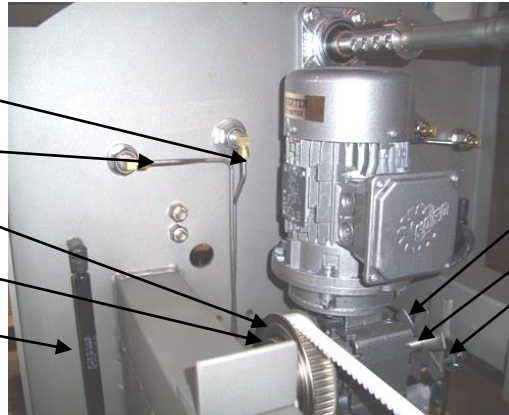

M508907	Flag, Trolley Pulse (6 Pattern)
M598902	Shaft, Trolley Drive
91910	Prox Switch 18mm

FLEX PASS® / SPRAY ARCH CHANGEOVER

61929	Coil, Danfoss 60Hz
61933	Coil, Danfoss 50Hz
61931-C	Term. Connector w/Cord DF
42811	Hose, 3/4" x 180" w/Wrap (To spray arch)
42812	Hose, 3/4" x 66 3/4" (To center Flex Pass® manifold)
M358930	Manifold, Flex Pass (NP)

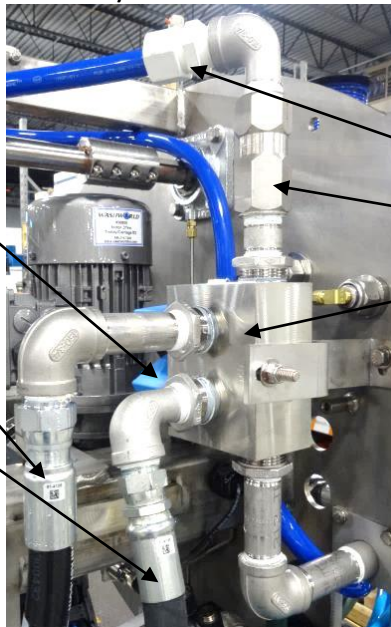

41410002	Comp. Fitting 3/4" npt x 3/4" tube
62030-F	Valve, Check 3/4"
61952	Valve, Sol. NO/NC Danfoss
61952-KIT	Repair Kit, Valve NO/NC (2 per - Contains one piston and spring)
61953	Stem, NO
61954	Stem, NC

TROLLEY

M618889	Roller, White (2 Per Trolley)
M618939	Roller, Black (2 Per Trolley) (NP)
M618950	Roller, Tension Trolley (4 Per Trolley)
17949	Gearbox, Arch 50:1 R3
36905	Motor, .37kw Car./Tr./Arch

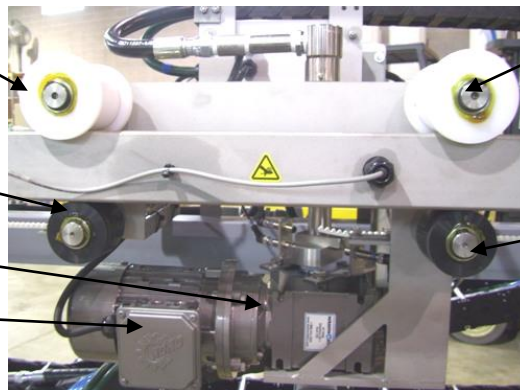

M598903	Shaft, Trolley Roller (4 Per)
M638899	Washer (1 per)
12389	Snap Ring 1" (2 Per Roller)

M598910	Shaft, Eccentric Trolley (4 Per Trolley)
M638899	Washer
12389	Snap Ring 1" (2 Per Roller)



2020 PICTORIAL PARTS BOOK

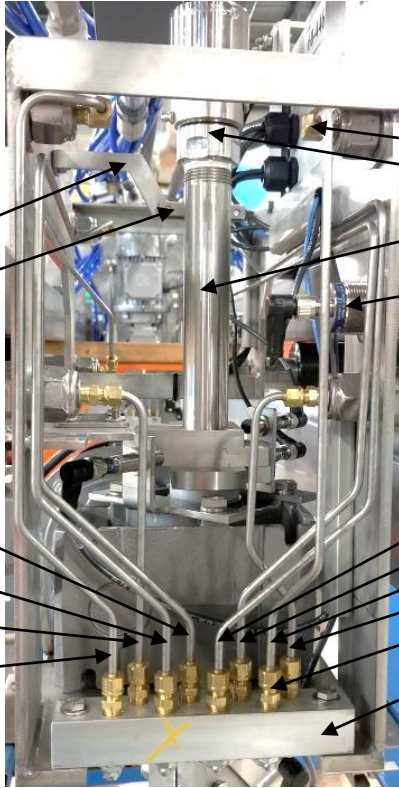

LumenArch™ Ground Strap Assembly	
21000016	Bracket, Ground Strap LumenArch™
21080010	Contact Pad, SST

23170-FB	Fitting, Comp 90 deg
65391-P	Swivel, 90 deg 1"
M598897	Shaft, Hollow R3
91914	Prox Switch, 30mm (2 Per Trolley Left/Right Limit)

M578947	Grease Line Tr. DS ENT B
M578945	Grease Line Tr. DS ENT T
M578948	Grease Line Tr. PS ENT B
M578946	Grease Line Tr. PS ENT T

M578942	Grease Line DS EX T
M578944	Grease Line DS EX B
M578941	Grease Line PS EX T
M578943	Grease Line PS EX B
22910-FB	Fitting, Comp ST
10793	Manifold, Grease 8 Hole

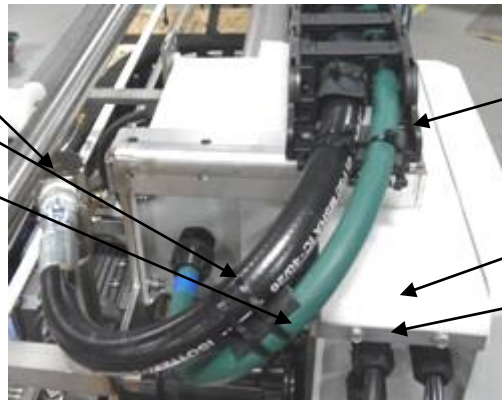

65391-P	Swivel, 90 deg 1"
42811	Hose, 3/4" x 180" w/wrap
33382	Cable, 18 Cond. Pre- cut 133"
40010008	E-Chain, Trolley PS/RS Feed (E-chain with cable and hose)
40010009	E-Chain, Trolley DS/LS Feed (E-chain with cable and hose)

34220003	End Mount, Link, E- Chain Trolley Female
33281-L	Link, E-Chain Trolley
M538923	Guide, Trolley E- Chain UHMW
M508958	Bracket, E-Chain Guide RH SST (NP)
M508959	Bracket, E-Chain Guide LH SST
WW6017	Trolley E-Chain Guide Retrofit

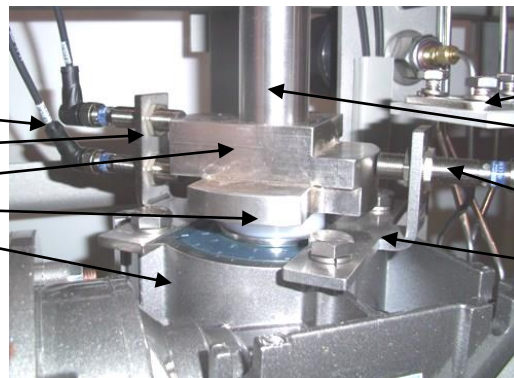

33259	Cord, Prox 90deg
M308940-S	Bracket, Arch Double
M638891	Index Cam SS
M658903	Washer UHMW RZR
17949	Gearbox, Arch 50:1

9973	Clamp, Belt (2 Per Trolley)
M598897	Shaft, Hollow R3
11802-2S	Key, Arch Gearbox
91909	Prox Switch, 12mm (3 Per Trolley)
M308941-S	Bracket, Arch Single R3



2020 PICTORIAL PARTS BOOK



SPRAY ARCH

The following configuration and displayed parts are for Razor® machines equipped with the LumenArch™ option.

21080021	Plate, Insul 0.6THK UHMW
21080003	Block, Mount, UHMW
21000015	Mounting Bracket
21080018	Contact Pad, SST
21080001	Lift Block Assy. w/Elec-Tab
93180001	Grease, Silver Cond. (NP)

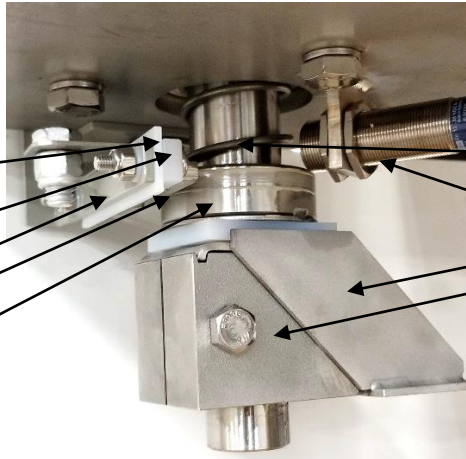

90899	Spring, Comp.
33259	Cord, Prox 90deg
91912	Prox Switch 18mm
M328896	Lift Plate, Spray Arch
M658891	Block, Clamp
M688934	Key, Block (NP)

The following configuration and displayed parts are for Razor® machines that are NOT equipped with the LumenArch™ option.

M328896	Lift Plate, Spray Arch
M658891	Block, Clamp
M688934	Key, Block (NP)

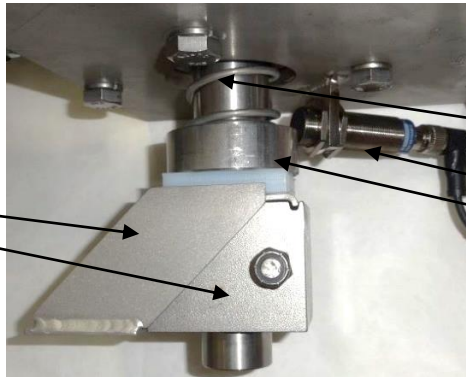

90899	Spring, Comp.
33259	Cord, Prox 90deg
91912	Prox Switch 18mm
M288916	Lift Block Assy

13976	Bumper, Comp
M658902	Washer 1/8"
M658901	Washer 1/4"
M358900	Weldment, Arch VA
M358905	Manifold, Side Arch (19 Nozzle Config)
M358906	Manifold, Side Arch (21 Nozzle Config) (NP)

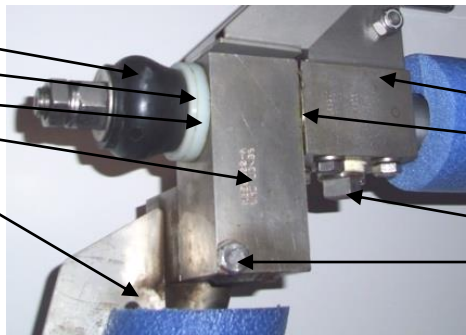

WW007	Arch O-Ring Kit (NP)
M358901	Manifold, Top Arch
10715-R	Retaining Ring
10715	Bearing, 3/8" (3 Each, VA) (NP)
66493-S	3/4" Plug SS
M688890	Shear Bolt

M358901	Manifold, Top Arch
---------	--------------------

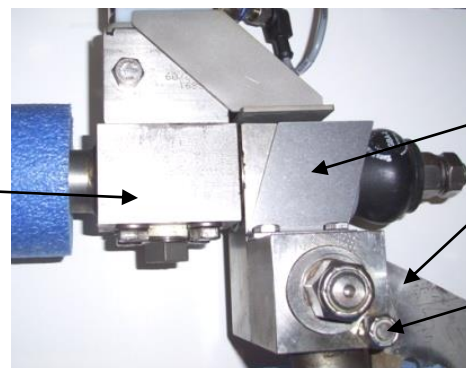

M500889	Angle Clip
M358905	Manifold, Side Arch (19 Nozzle Config)
M358906	Manifold, Side Arch (21 Nozzle Config) (NP)
M688890	Shear Bolt



2020 PICTORIAL PARTS BOOK



Washworld has greatly improved the customer experience with the LumenArch™ option! Impress your customers with a LumenArch™ retrofit package today! Available in three different packages for all Razor® machines.

50400001	Retrofit, LumenArch (Includes entire new spray arch manifold, covers, LED's, power supply, cables, and nozzle kit)
50400002	Retrofit, LumenArch w/existing parts (Includes new side spray arch, covers, LED's, power supply, cables, and nozzle kit)
50400003	Retrofit, LumenArch Covers only (For machines already equipped with the 21-nozzle arch – see below) (Includes new covers, LED's, power supply, and cables)

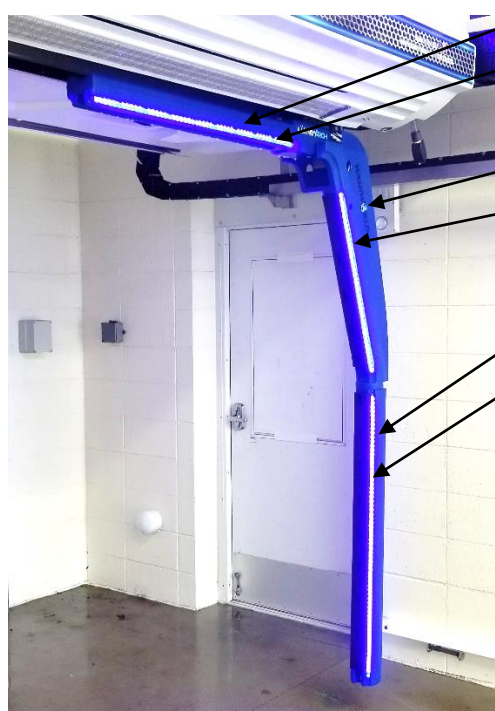

Spray arch parts for LumenArch™ option only	
M542001-B	Cover, Top Arch Blue
83925-35	LED Strip, 35.4", Blue (2 per)
M542050-35	Channel, LED, 35" (2 per) (NP)
M542006-B	Cover, Mid Side Arch
83925-28	LED Strip, 28", Blue (2 per)
M542050-27	Channel, LED, 27" (2 per) (NP)
M542011-B	Cover, Lower Side
83925-43	LED Strip, 43", Blue (2 per)
M542050-43	Channel, LED, 43" (2 per) (NP)
32070001	Power Supply, 12VDC (NP) (Located inside carriage enclosure)

Common Spray Arch Parts (21-nozzle configuration)	
68895-A	Foam Insert Assy. (Includes two foam inserts with backing for mid and lower side of spray arch)

Washworld's 21-nozzle configuration spray arch offers attractive blue covers with replaceable foam inserts and nozzle angles designed for improved cleaning on today's modern vehicles. Available for retrofit to any Razor®, Revv®, Razor® XR-7, or High Velocity® with Virtual Attendant®.

WW20022-21-R	Spray Arch, 21 Nozzle retrofit (Completely new arch, covers, foam, and nozzles) (No LED's)
WW20022-21-R-E	Spray Arch, 21 Nozzle retrofit with existing parts (contains new side arch manifold, covers, foam, and nozzles) (No LED's)



Spray arch parts for 21 nozzle configurations WITHOUT the LumenArch™ option.	
M542000-B	Cover, Top Arch Blue
M542005-B	Cover, Mid Side Arch Blue
M542010-B	Cover, Lower Side Arch Blue
REPLACEMENT NOZZLE KITS (21 nozzle arch configuration only)	
WW010-21	Nozzle Kit, 21 Noz. Config (Arch only)
WW010-21-UB	Nozzle Kit, 21 Noz. Config (Arch + UB Nozzles)
WW012-RZR	Nozzle Kit, Flex Pass® (Nozzles for Flex pass manifold and pods only)



2020 PICTORIAL PARTS BOOK



TRIPLE FOAM/FLEX PASS®

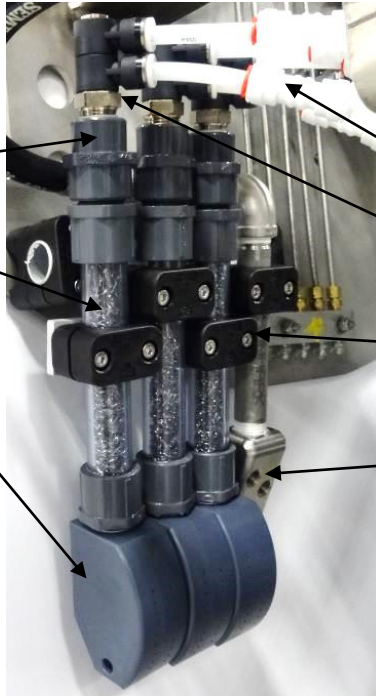

66756-P	Reducer, 3/4" X 1/2"
43200001	Foamer Tube Assy. (Includes SST material)
43210001	SST Foamer Material
95100-A	Foamer Head, Dual Stream

TRIPLE FOAM COLD CLIMATE (NP)	
95098-A	Foamer Head, Anodized
59015	Heater, 9W Cartridge

62046	Valve, Check 3/8" (6 per side)
41400001	Tube Fitting, Dual 3/8" T (3 per side)
42813-40	Hose, 1/2" x 40"
73905	Clamp, 1" I.D.
M508915-D	Bracket, TF DS
M508915-P	Bracket, TF PS
95095	Foamer Head, Flex Pass®

95003	Manifold, T-Block In-Bay
43200001	Foamer Tube Assy. (Includes SST material)

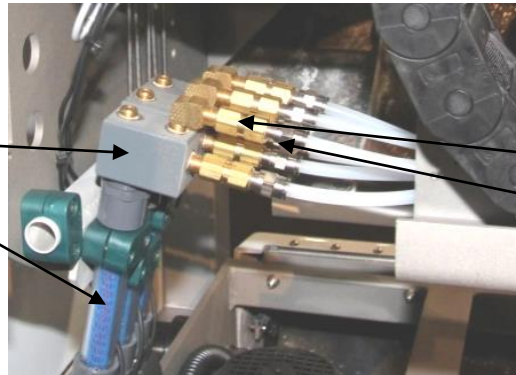

62025	Valve, Check 1/4" BR
22925-PB	Fitting, Tube 1/4" x 3/8 T

ENERGY CHAIN

42815	Hose, 3/4" x 211.5 w/Spiral Wrap
-------	----------------------------------

IGUS CARRIAGE E-CHAIN	
33283	E-Chain, Igus (No hoses or cables)
33283-P	Pivot, Igus
33283-L	Linkage, Igus
33283-C	Crosslink, Igus
33283-D	Divider, Igus

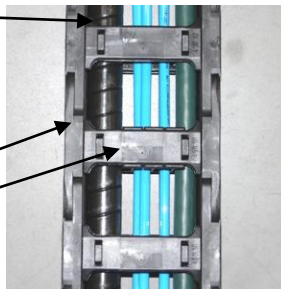

KABELSCHLEPP CARRIAGE E-CHAIN PARTS (NP)	
33287	Cross Member, KS
33285	Divider, KS
33276-SL	Link, KS No Slot
33276-L	Link, KS with Slot



2020 PICTORIAL PARTS BOOK



RAZOR® SENSOR FLAG CONFIGURATIONS		
Serial Number Range	Carriage Flags	Trolley Flags
Razor w/Ser. No. 60-0001 to 60-0300 (Standard Dryer)	Front Limit Flag: (Qty. 1) M330887-S *Middle Limit Flag: (Qty. 1) M330888-S Rear Limit (Qty. 1): M330889-S	Right Limit (Qty. 1) M330889-S Left Limit (Qty. 1) M330889-S
Razor w/Ser. No. 61-0001 to 61-0300 (On-Board Dryer equipped)	Front Limit: (Qty. 1) M330892-S *Middle Limit: (Qty. 1) M330888-S Rear Limit: (Qty. 1) M330893-S	Right Limit: (Qty. 1) M330889-S Left Limit: (Qty. 1) M330889-S
Razor w/Ser. No. 60-0300 to 60-2999 (Standard Dryer)	Front Limit: (Qty. 1) M330895-S Rear Limit: (Qty. 1) M330889-S	Right Limit: (Qty. 1) M330889-S Left Limit: (Qty. 1) M330889-S
Razor w/Ser. No. 61-0300 to 61-2999 (On-Board Dryer equipped)	Front Limit: (Qty. 1) M330897-S Rear Limit: (Qty. 1) M330893-S	Right Limit: (Qty. 1) M330889-S Left Limit: (Qty. 1) M330889-S
Razor w/Ser. No. 60/61-3000 and above (Standard and On-Board Dryer)	Front Limit: (Qty. 1) 21080004 Rear Limit: (Qty. 1) 21080004	Right Limit: (Qty. 1) M330898-S Left Limit: (Qty. 1) M330898-S
*NOTE: Each flag shown, excluding the carriage middle limits, requires one M658900 (Rail Flag Block) spacer per flag.		

RAZOR® HEAT STRIPS (COLD CLIMATE)		
Component(s)	Part Number	Description
Carriage Rails	37801	Heat Strip, 1" x 300", 450w (1 per rail, 2 total)
Trolley Rails	37791	Heat Strip, 1" x 123", 185w (1 per rail, 2 total)
Carriage Belt Shrouds	37793	Heat Strip, 1" x 22", 80w (1 per shroud, 2 total)
Side Sonars	37789	Heat Strip, 1" x 3", 7.5w (1 per housing, 2 total)
Loading Eye Housings	M388871-A	Heat Strip w/bracket, 7.5w (1 per eye, 4 total)
	37789	Heat Strip, 1" x 3", 7.5w (Heat strip only, no bracket)
Undercarriage Eye Housings	M388871-A	Heat Strip w/bracket, 7.5w (1 per eye, 2 total)
	37789	Heat Strip, 1" x 3", 7.5w (Heat strip only, no bracket)

CARRIAGE BELT TENSIONERS

21430003	Plate, Clamp (4 per machine)
21430004	Plate, Backer (4 per machine)
37801	Rail Heat Strip, Carriage (1 Per Rail) (NP)
37791	Rail Heat Strip Trolley (1 Per Rail) (NP)

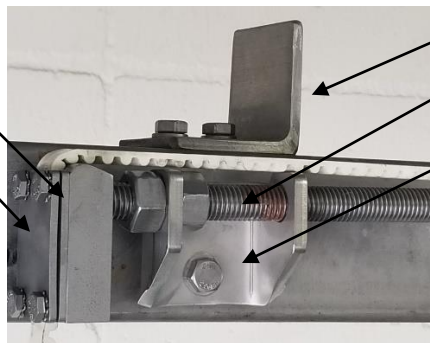

M100004	Bracket, Roller Stop
21430002	Slide, Belt Tens. (4 per machine)
21430001	Mount, Carr. Belt Tensioner (4 per machine)
50480002	Kit, Update Belt tensioners (Contains all parts shown minus carriage belts and stop brackets)
M688899	Cap, 3" x 3", UHMW

RAZOR® BELTS / ENERGY CHAIN ROLLERS

9969-K	Belt, 396" OBD (For 30' 4" rails – OBD)
9970-K	Belt, 268" Trolley (1 per – all types)
9971-K	Belt 15mm x 360" Carriage (2 per – NON-OBD)



10106-3A	Roller Assembly, E-Chain (STD FSF)
10106-2A	Roller Assembly, E-Chain (FSF OBD only) (NP)
10106-1A	Roller Assembly, E-Chain (Wall Mount)
21020004	Bracket, Extension E-Chain Roller (HyperFlex™ and OBD Only)



2020 PICTORIAL PARTS BOOK



PUMP STATION (Ser. No 60/61-3050 and above)

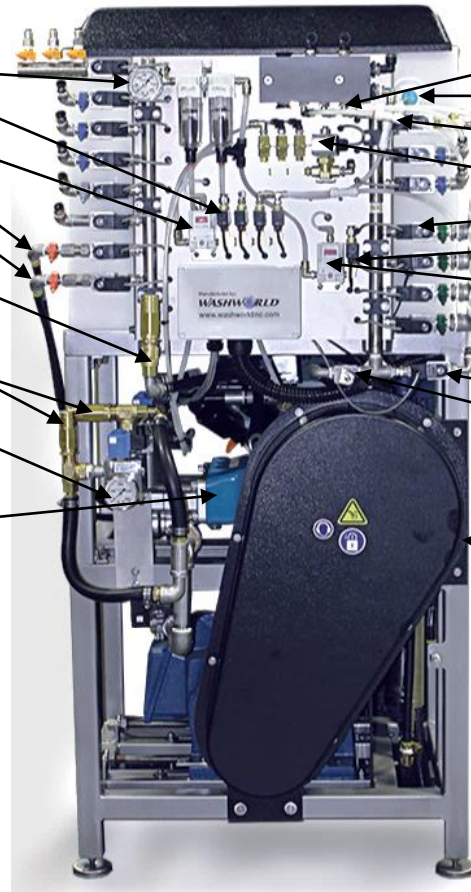

23936	Gauge, 0-300psi
46100001	Valve, Sol. 1/4" NC
25205	Regulator, Air, El-Pneumatic, 1/4"
41550001	Hose, 3/8" x 30.5"
41550002	Hose, 3/8" x 32.5"
46130002	Valve, Regulator, Greaseable, LP Spring
46130001	Valve, Regulator, Greaseable, HP Spring
24000	Gauge, 0-2000psi

21500003	Manifold, Mixing Foam 'N Flow®
91992	Switch, High Level
62192-24	Valve, Sol. NO 3/8" (Weep)
61915	Valve, 3/8" NC Dema
61939-C	Cord, Coil, 2-Cond.
46100001	Valve, Sol. 1/4" NC
25205	Regulator, Air, El-Pneumatic, 1/4"
33250	Cable, Air Regulator (NP)
46100002	Valve, Sol. NO 1/2"
61940	Valve, Sol. NC 1/2"

High Pressure Pump	
61589	Pump, CAT 3535
61589-S-KIT	Seal Kit, CAT 3535 (1 per pump)
61589-V-KIT	Valve Kit, CAT 3535 (2 per pump)
43949	Oil, CAT, 2.5 Gal.
61540	Pump, General HTCK40 (NP)
High Pressure Pump Motors	
36928	Motor, 25HP 208/230/460/380 VAC 50/60Hz
36929	Motor, 25HP, 575 VAC

High Pressure Pump Drive (208, 480, and 575 VAC Versions)	
M538920	Belt Guard, Outer
M538921	Belt Guard, Inner
10932-3SK	Sheave, Upper
11408-SK	Bushing, Upper
10917-3SD	Sheave, Lower
11421-SD	Bushing, Lower
9956-3BX	Belt, 67", 3V Banded
61590	Key, CAT Pump Shaft
380-415 VAC Versions (Same upper sheave and bushing as above)	
10934-3SK	Sheave, Lower
11421-SK	Bushing, Lower
9957-3BX	Belt, 68" 3V Banded

25035	Filter, Air, Hsg + Filter, 5 Micron
25036	Filter, Air, Hsg + Filter, 3 Micron
46360001	Filter, 5 Mic (NP)
46360002	Filter, 3 Mic (NP)
62035	Valve, Check 3/8"
33250	Cable, Air Regulator El-Pneu
25205	Regulator, Air, El-Pneumatic
46100001	Valve, Sol. 1/4" NC (5 shown)

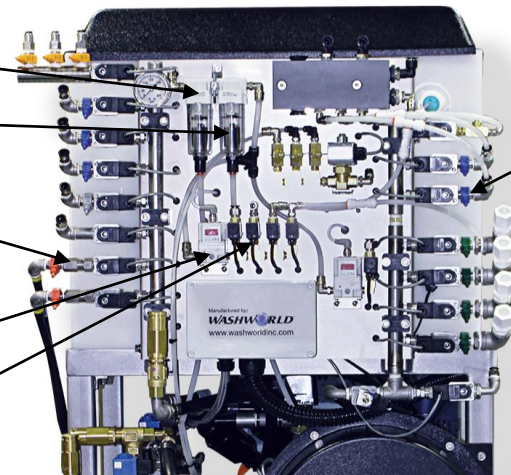

INJECTORS	
62369-X	.057 Inj. (RED)
62344-X	.070 Inj. (RED)
62375-X	.083 Inj. (GRAY)
62376-X	.086 Inj. (BLUE)
62379-X	.083 Inj. (DUAL PORT)
62304	Meter. Tip Kit



2020 PICTORIAL PARTS BOOK



62208	Valve, 3-Way, 3/4"
42010001	Pump, 2HP, 16ST, 208V, 60Hz
42010002	Pump, 2HP, 16ST, 380V, 50Hz (NP)
41550005	Hose, Corr. 2" x 16"



61929	Coil, Danfoss 60Hz
61933	Coil, Danfoss 50Hz
61952	Valve, Sol. 1" NO/NC
62063	Valve, Check 1/4"
2P801-1	Filter, 3/4" w/Screen (2 per)
62035	Valve, Check 3/8" (2 per)
21500004	Manifold, 1.5" x 8", w/2 Holes

PUMP STATION (Ser. No. 60-3049 and below)

23936	Gauge, 0-300psi
M358944	Manifold, TF
61915	Valve, 3/8" Dema SS NC (Includes coil) (9 shown)
61930	Valve, Danfoss 3/8" NC (NP)
61929	Coil, Danfoss (NP)
M358948	Manifold, 9 Hole (LP Manifold)



62062	Valve, Check 1/4" 2000 psi
61952	Valve, Sol 1" Dual Port NO/NC
61953	Stem, NO DF
61954	Stem, NC DF
61952-KIT	Rebuild Kit (For 61952 Valve)
46130001	Valve, Regulator, Greaseable, HP Spring
61951	Valve, HP Unloader
46130002	Valve, Regulator, Greaseable, LP Spring

INJECTORS	
62369-X	.057 Inj (RED)
62344-X	.070 Inj. (RED)
62375-X	.083 Inj. (GRAY)
62376-X	.086 Inj. (BLUE)
62379-X	.083 Inj. (DUAL PORT)
62304	Meter. Tip Kit

24000	Gauge, 0-2000psi
M548933	Manifold, 1" x 6" w/Hole



46100001	Valve, Sol. 1/4" NC (TF and Foam Air)
25050	Regulator, Air 3/8"
23920	Gauge, 0-160psi
25049	Regulator, Air 1/4"
62052	Valve, Needle 1/4" BR
62192-24	Valve, 3/8" NO (Weep)
33914	Enclosure, J1



2020 PICTORIAL PARTS BOOK



61930	Valve, Danfoss 3/8" NC BR (NP)
61929	Coil, Danfoss 24VAC (NP)
61915	Valve, 3/8" Dema SS (Includes coil)

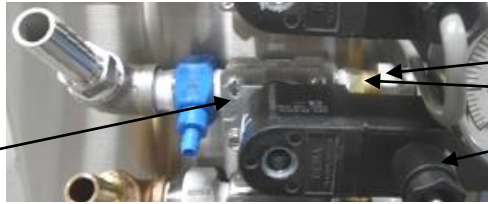

43442-S	Swivel, Ftg 3/8"
65944-4B	Nipple, Hex 3/8" BR
61939-C	Cord, Danfoss w/Conn.

42790-22	Hose, 1" x 22"
41938-28	Hose, 3/8" x 1/4" x 28"
41937-28	Hose, 3/8" x 3/8" x 28"
41938-30	Hose, 3/8" x 3/8" x 30"
61589	Pump, CAT 3535
36928	Motor, 25HP 208/230/460/380 VAC 50/60Hz
36929	Motor, 25HP, 575 VAC (NP)
M538921	Belt Guard Inner
M538920	Belt Guard Outer (NP)

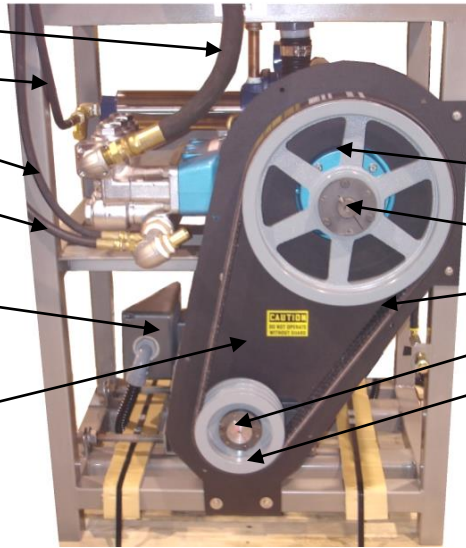

10932-3SK	Sheave, 3B13.6 SK Cat Pump
11408-SK	Bushing, Sheave 35mm SK
9956-3BX	Belt, 3V 67"
11421-SD	Bushing, Sheave 1-7/8" SD
10917-3SD	Sheave, 3B6.2 SD

SOLUTION PUMP (Ser. No. 60/61-3050 and below)

62208	Valve, 3 Way 3/4" 50/60Hz
2P808	Y-Strainer, 1/2"

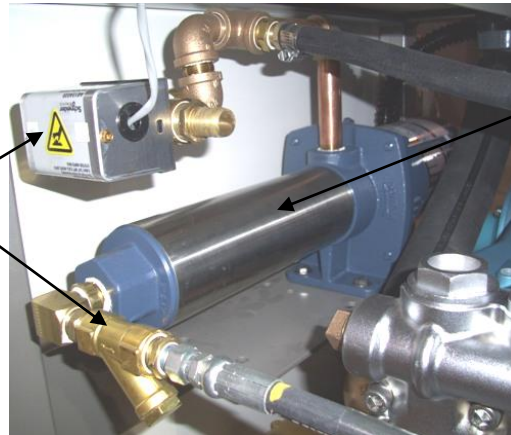

REPLACEMENT PUMPS	
61050	Pump, Sta-Rite 1.5HP 3PH 60 Hz HP6FE (Pump Only)
61060	Rebuild Kit, Sta-Rite (For HP6FE)
61050-50	Pump, Sta-Rite 1.5HP 50Hz (Intl. Sol. and Spot Free Pump)
61189	Pump, Sta-Rite 1HP 1PH Spot Free (Pump Only)



2020 PICTORIAL PARTS BOOK



MAIN TANK

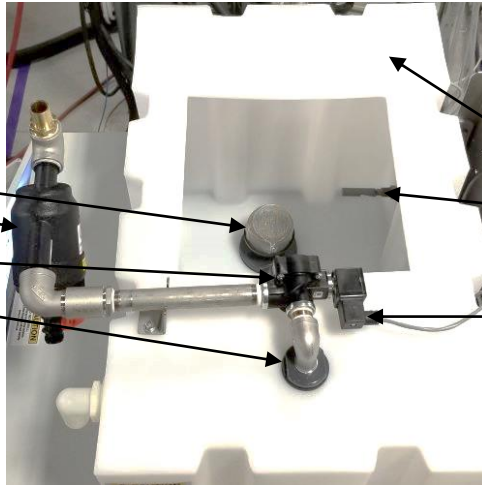

64991	Strainer, 2"
2P800	Filter, 1" w/screen
61941	Valve, Sol. 3/4" NC PL Dema
66576-TT	Bulkhead, 3/4" PVC

M348894	Tank, Poly
29908	Low Level Float Switch, 1/4"
91992	Sensor, 24VDC, High Level Switch (NP)
61939-C	Cord, DIN 53"

RECLAIM



61931-R	Cord, DIN 65"
62041	Valve, Ball Check 1" Union PVC
62496	Valve, Sol. 1" NC SS 24VAC (Includes coil)

RECLAIM PARTS INSIDE MAIN TANK (NP)	
65907	Nipple, Close 2" PVC (2 Per)
66387-4N	Elbow, Street 2" Nylon (2 Per)
64991	Strainer, 2"
62045	Valve, Check Ball 2" PVC Union

OVERHEAD MANIFOLD (Ser. No. 60/61-3050 and above)

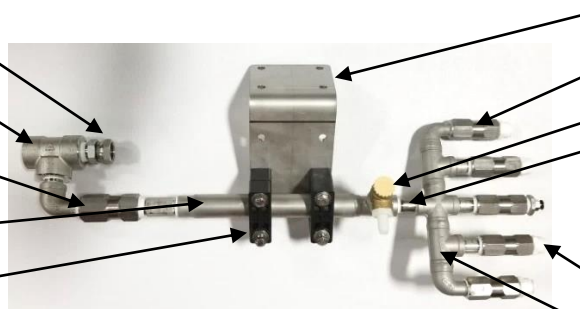

41430001	Fitting, Hyd. 3/4" x 3/4"
41050001	Tee, 3/4", SCH 80 SST
62030-F	Valve, Check 3/4" F x F
21500006	Manifold, OH Foamer
73916	Clamp, Tube 1" (2 shown)

21000009	Bracket, OHM Mount
62031	Valve, Check 1/2" F x F (5 shown)
62071	Valve, Relief, 150psi
M358920	Nipple, Foamer
43210003	Mixing Material SST (NP)
23242-PB	Fitting, Tube 1/2" NPT x 1/2" T (4 shown)
M358951	Manifold, OH



2020 PICTORIAL PARTS BOOK



OVERHEAD MANIFOLD (Ser. No. 60/61-3050 and below)

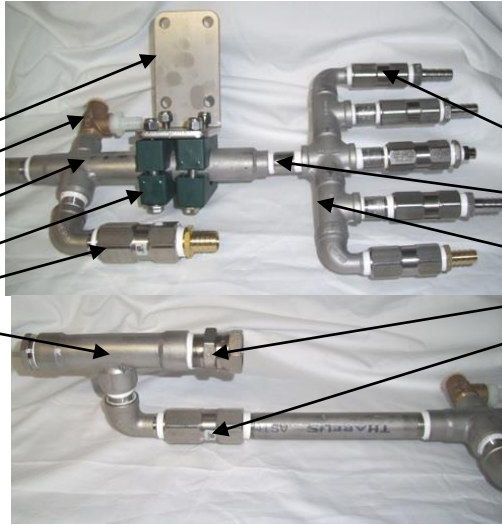

M519604	Bracket, OHM
62071	Valve, Relief 150 psi
M358986	Manifold, Foamer OH
73916	Clamp, Tube 1"
62030-F	Valve, Check 3/4"
M358985	Manifold, Tee

62031	1/2" Check Valve SS (5 Each)
M358920	Nipple, Foamer
90888	Mesh Material (NP)
M358951	Manifold, OH
43451	Swivel, Hyd. Ftg.
62030-F	3/4" Check Valve

ULTIMATE CONTROL CABINET (UCC)



WASHVIEW HMI RAZOR® W/SERIAL NUMBER 60/61-0300 OR LOWER (NP)	
PVP 400	Panel View Plus 400
WASHVIEW HMI (RAZOR® W/SERIAL NUMBER 60/61-0300 TO 60/61-1000 (NP)	
PVP 600	Panel View Plus 600
WASHVIEW HMI (RAZOR® W/SERIAL NUMBER 60/61-1000 OR HIGHER (SHOWN)	
3682	HMI Touch 5.7

FOR RAZOR® W/SER. NO. 60/61-2999 AND BELOW	
30005	Switch, Sys Stop Button (AB)
30098	Contact, NC (AB)
FOR RAZOR® W/SER. NO. 60/61-3000 AND ABOVE	
30007	Switch, Sys Stop Button (SQD)
30093	Contact, NC (SQD)

TEMPERATURE PROBES AND CORD (NP)	
91985	Temperature Probe
33255	Cord, Temperature 50'

UCC COMPONENTS



THIS PLC CONFIGURATION IS FOR RAZOR® WITH SERIAL NUMBERS 60/61-0300 OR LOWER	
3629	PLC Base, 1764
98560	Cable, Modem
3632	PLC, 1764
3637	Memory Module (NP)

3651	Input Card, 1769 IQ 16 (2 Each)
3650	Analog Card
3659	Output Card, 1769 OB16 (2 Each)
3645	End Cap, 1769
98561	Cable, Comm. Micrologic



2020 PICTORIAL PARTS BOOK



THIS PLC CONFIGURATION IS FOR RAZOR® WITH SERIAL NUMBERS 60/61-0300 TO 60/61-0999

3674	Memory Module
3672	PLC 1400

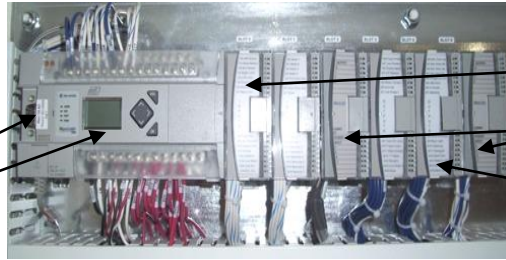

3676	Input Card, 1400 (2 Needed)
3680	Analog Card, 2 Needed
3678	Output Card, 1400 (2 Needed)

THIS PLC CONFIGURATION IS FOR RAZOR® WITH SERIAL NUMBERS 60/61-1000 to 60/61-2999

3674	Memory Module
3673	PLC

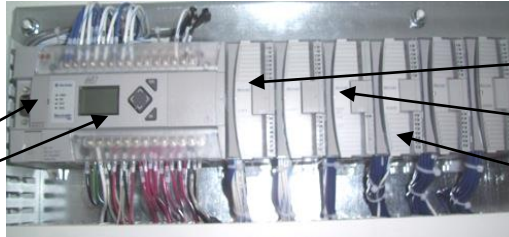

3676	Input Card, (2 Needed)
3610	Analog Card, (1 Needed)
3678	Output Card, (3 Needed)

THIS PLC CONFIGURATION IS FOR RAZOR® WITH SERIAL NUMBERS 60/61-3000 AND ABOVE

3705	PLC 1 (1 per)
3750	Memory Card (NP)

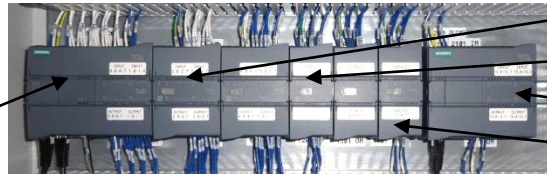

3720	Module, I/O (2 per)
3725	Module, Output (2 per)
3710	PLC 2 (1 per)
3730	Module, Analog (1 per)

THIS CONFIGURATION IS FOR RAZOR® W/SER. NO. 60/61-2999 AND BELOW

36435	Circuit Brkr. 3A 1P
10031-AB	Circuit Brkr. 1A 1P (2 Each)
10033-AB	Circuit Brkr. 7A
10032-AB	Circuit Brkr. 2A
10035-AB	Circuit Brkr. 15A
10034-AB	Circuit Brkr. 10A

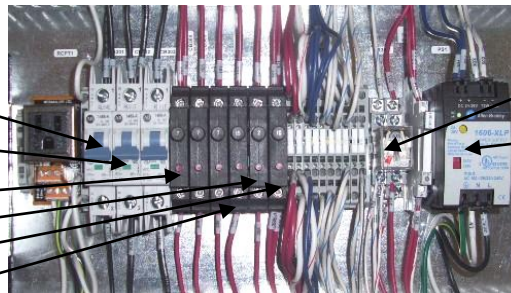

10047-AB	Relay Cube, System Stop (AB)
37402-AB	Power Supply, 24VDC (AB)
37403	Power Supply, 12VDC (Not Shown, 12VDC Lights)

THIS CONFIGURATION IS FOR RAZOR® WITH SERIAL NUMBERS 60/61-3000 AND ABOVE

10040-FI	Relay & Socket 24VDC
----------	----------------------

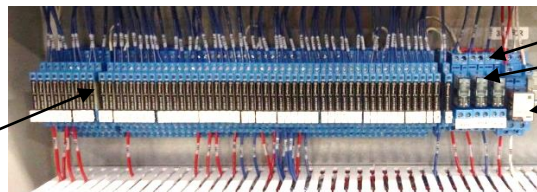

10043-FI	Relay, Base, 24VDC
10042-FI	Relay, Cube, 24VDC
30928	Relay, Cube, Sys. Stop 24VDC
30929	Relay, Sys. Stop, Base, 24VDC

THIS CONFIGURATION IS FOR RAZOR® W/SER. NO. 60/61-2999 AND BELOW

36556-AB	Circuit Brkr. 6A 2P (AB)
36480-AB	Circuit Brkr. 10-16A (3 Each)

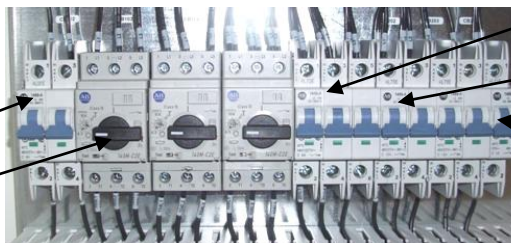

36477-MG	Circuit Brkr. 6A 3P (AB)
31660001	Circuit Brkr. 13A 2P (2 Each)
31590001	Circuit Brkr. 10A 1P (110 VAC Lights)
31590005	Circuit Brkr. 2A 1P (Optioned w/12VDC Lights)



2020 PICTORIAL PARTS BOOK



THIS CONFIGURATION IS FOR RAZOR® WITH SERIAL NUMBERS 60/61-3000 AND ABOVE

31640001	Circuit Brkr. 4A 2P
31650001	Circuit Brkr. 10A 2P
31660001	Circuit Brkr. 13A 2P
31590003	Circuit Brkr. 10A 1P

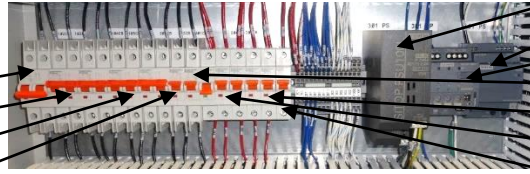

37450	Power Supply, 24V
37455	Power Supply, 12V
32050001	Module, 4-Chan, 24V
31580001	Circuit Brkr. 4A 1P
31590004	Circuit Brkr. 7A 1P
31590005	Circuit Brkr. 8A 1P
31590006	Circuit Brkr. 6A 1P

THIS CONFIGURATION IS FOR RAZOR® W/SER. NO. 60/61-2999 AND BELOW (Please specify phase requirement before ordering. Pre-programmed VFD's are available)

37649-3PH	VFD, 3PH, 1HP, Un-prog
37649	VFD, 1PH, 1HP, Un-prog.



28894-AB	Contactor 9A (3 Each) (AB)
28916-24AB	Contactor, 12A (Heat) (AB)
29408-AB	Overload, 3.7-12A AB (Sol. Pump)

THIS CONFIGURATION IS FOR RAZOR® W/SER. NO. 60/61-3000 AND ABOVE

31410001	VFD, 3/4HP, Siem (2 per)
31400001	VFD, 1/2HP, Siem



31200001	Contactor, 12A (Heat)
36440	Circuit Breaker, 9A-12.5A (2 per)
29097	Contactor, 9A (2 per)

J1A / HP MOTOR STARTER BOX

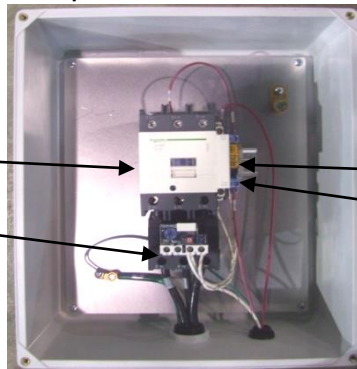

29091	Contactor, 80A (Tele)
29396	Overload, 63-80A (Tele)

30907	Relay, Cube 10A 24VAC
30995	Relay Base

BAY BOX

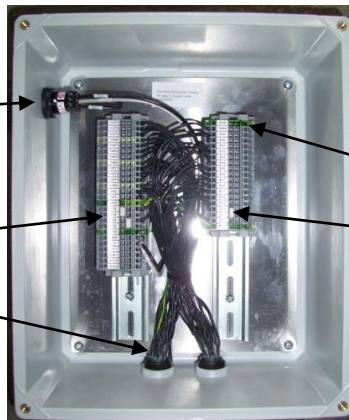

92085	Horn, 110VAC (Ser. No. 60/61-0999 and below only)
92086	Horn, 220VAC (International)
10007-WG	Term. Block 2P (Shown)
35306	Strain Relief (2 Each)

10009-WG	Term. Block 2P Ground
10015-WG	Jumper, 2P



2020 PICTORIAL PARTS BOOK



CARRIAGE BOX

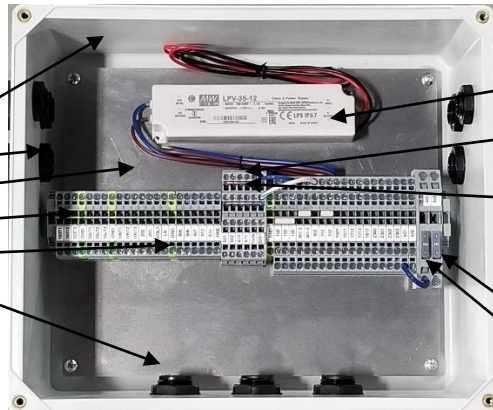

33802	Enclosure, Carriage
35304	Strain Relief (6 Each)
33803	Panel, Carriage
10007-WG	Term. Block 2P
10009-WG	Term. 2P Ground
35306	Strain Relief (3 Each)

32070001	Power Supply, 12VDC, IP67 (NP) (LumenArch™ Only)
10010-WG	Term. Block 3W
10014-WG	End Cap 3W
10017-WG	Jumper Strip (For 3W terminals)
10015-WG	Jumper, 2P
10008-WG	Term. Block 4P
10028-WG	Term. Fuse Holder
31760001	Fuse, 3A
35950-2	Fuse, 2A

TROLLEY BOX

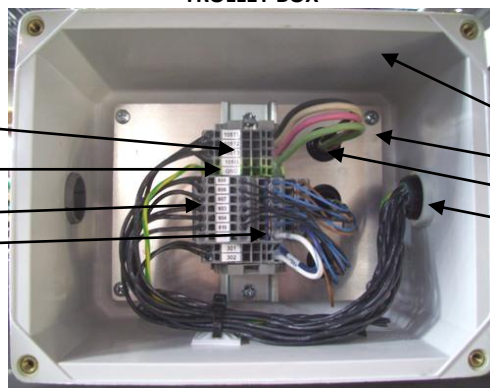

10007-WG	Term. Block 2P
10009-WG	Term. Block 2P Ground
10010-WG	Term. Block 3W
10017-WG	Jumper Strip

33800	Enclosure, Trolley
33801	Panel, Trolley
35304	Strain Relief (3 Each)
35306	Strain Relief (1 Each)

MACHINE CONTROL BOX

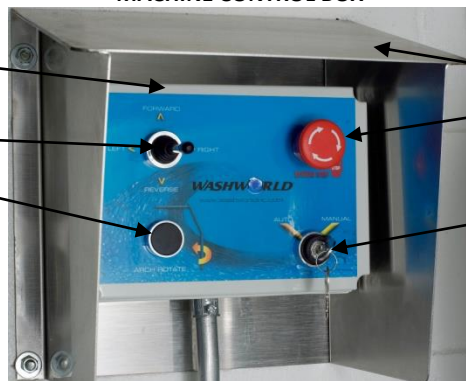

33800	Enclosure, Joystick
33801	Panel, Enclosure
30789	Operator, Joystick 4 Pos.
29994	Switch, Push Button
30094	Contact Block, NO (Arch Rotate and Key Switch) (NP)

M379990	Shroud, Joystick
30004	Switch, System Stop
30099	Contact Block NC (Sys. Stop)
29999-2POS	Key Switch, 2 Pos.
30000	Key, Replacement

RF REMOTE



NOTE: The RF remote is only available with serial number 60/61-1000 and above. Call with serial number before ordering.	
92010	Remote Transmitter

92011	Receiving Unit
-------	----------------



2020 PICTORIAL PARTS BOOK



AUDIO

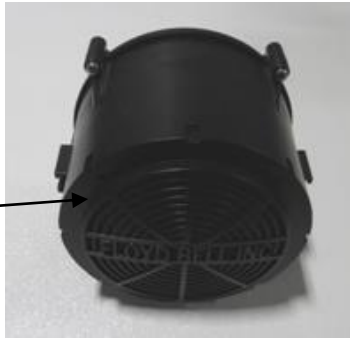

NOTE: Audio commands are only available with serial numbers 60/61-0300 or above.

92088	Speaker, Audible Alarms
-------	-------------------------

M519373-A	Mounting Bracket, Speaker (NP)
-----------	--------------------------------

SIDE/REAR SONARS

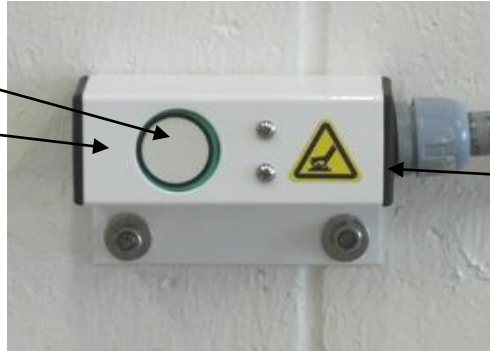

91900-SIDE	Sonar, L2 P&F (Side sonars only – 2 per)
M388885	Housing, L2 Sonar (2 per machine)
50420003	Kit, Update, Side Sonar Housings
50420004	Kit, Update, Side Sonar Housings w/Heat

37789	Heater, 24VAC 7.5W (if optional) (NP)
M688897	Cap, 2" x 2" black
33272	Cord, P&F Sonar 15m (NP)

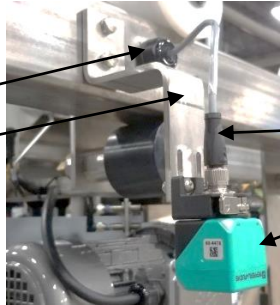

35306	Strain Relief 1/2"
M519369	Bracket, Rear Sonar Mount

33272	Cord, Sonar 15m
91900-REAR	Sonar, L2 P&F (Rear sonar only)

LOADING EYES



M388875	Housing, Loading Eyes (2 per)
92075-L	Transmitter, Telco
92076-L	Receiver, Telco
92079-L	Amp, Dual Chan. Telco (NP)

M388865	Bracket, Channel (2 per housing)
M688897	Cap, 2" x 2" (2 per housing)
50420005	Kit, Update, Ldg. Eye Housings
50420006	Kit, Update, Ldg. Eye Housings w/Heat

UNDERCARRIAGE EYES/HOUSINGS

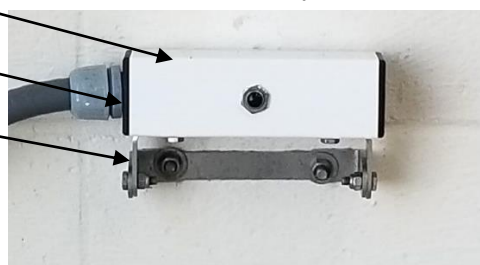

M388870	Housing, Photo-eye (2 per machine)
M688897	Cap, 2" x 2" (2 per housing)
M388865	Bracket, Channel (2 per housing)
50420001	Kit, Update, U/C Housings
50420002	Kit, Update, U/C Housings w/heat

92075-L	Transmitter, Telco
92076-L	Receiver, Telco
92077-L	Amp, Telco 24VAC (NP)



UNDERCARRIAGE MANIFOLD / POWER TOWER WHEEL CLEANER™

<p>NOTE: The center undercarriage manifold (M358927) is only available in a five-hole configuration. The outside manifold holes may be plugged with 1/4" NPT plugs.</p>	
M358927	Manifold, U/C, Center, 5-Hole (NP)
62009	Valve, Check 1" BR
M548911	Nipple, 1" x 8" w/ 2 Holes (Non-Power Tower only)
UNDERCARRIAGE NOZZLE KITS	
50720002	Kit, Nozzle, U/C w/6 nozzle Power Tower
50720003	Kit, Nozzle, U/C w/12 nozzle Power Tower

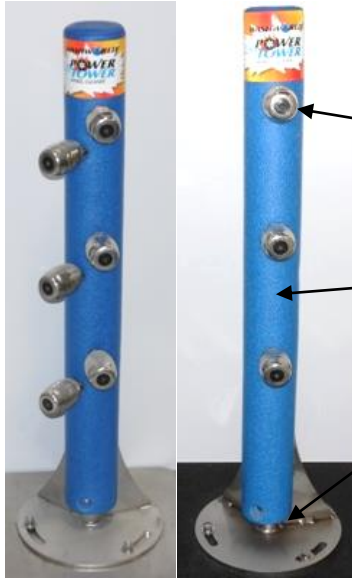

63527	Nozzle, Turbo 4 GPM
41937-28	Hose, 3/8" x 1/4" x 28" (NP)
68894	Foam, PT Cover (Blue) (Specify hole configuration when ordering – 3 or 6)
M548954	Manifold, Power Tower

Y-BARS (Ser. No. 60/61-0299 and below)

34895-1/2	Conduit 1/2"
34973	Conduit Conn. 1/2" 90 deg
M668887	Bracket, Y-Bar Breakaway
91918	Actuator
91917	Read Switch

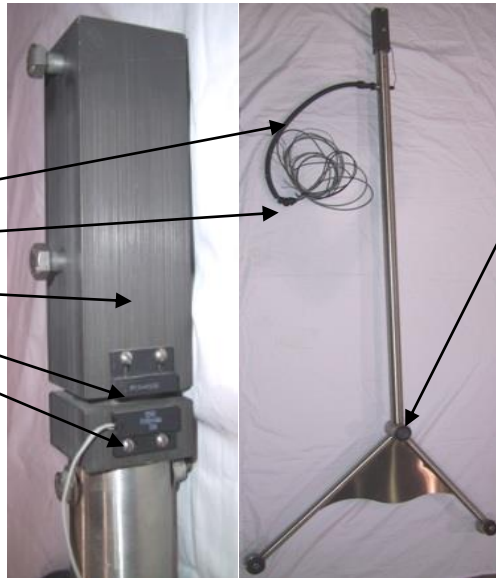

33530001	Sonar, P&F 30mm
50480001	Update Kit, Sonar P&F (Contains sonar, cap w/hole, and cord – Required when replacing APG sonar))
33272	Cord, Sonar P&F
92079-L	Amp, Telco Dual
92075-L	Trans. Eye, Telco
92076-L	Rec. Eye, Telco
M688900	Cap, 2 1/2"
M228889-A	Heater, Y-bar w/Bracket (NP)

2020 PICTORIAL PARTS BOOK



MACHINE COVERS



FRONT COVER	
M538926-S	Fiberglass Cover, w/Sonar(Front)

REAR COVERS	
M538926-H	Fiberglass Cover w/Flex holes (Rear)
M538926-H-F	Fiberglass Cover w/holes and FNF (Rear)
M538926	Fiberglass Cover (Rear OBD only)

HINGES AND MISCELLANEOUS	
83925	Blue LED, 73"
M499055	Hinge, Fiberglass
M519027	Retaining Bar, Hinge
90991	Cylinder, Gas (2 per)

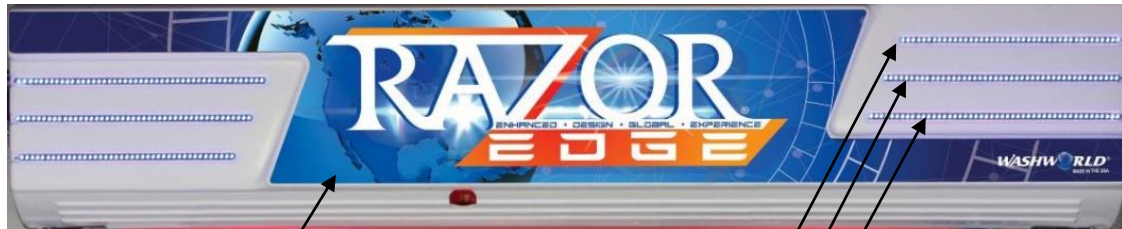

COVERS	
21280001	Cover, Front ABS
21280003	Cover, Rear ABS
M540150	Cover, Rear ABS (OBD Only)

LED LIGHTS	
83925-27	LED Strip, Blue 27.75" LG (2 per)
83925-29	LED Strip, Blue 29.75" LG (2 per)
83925-31	LED Strip, Blue 31.75 LG (2 per cover)

MISCELLANEOUS	
80020001	Decal, EDGE, F/R Cover (1 per cover)
M499055	Hinge, Fiberglass
M519027	Retaining Bar, Hinge
90991	Cylinder, Gas (2 per)

FOAM 'N FLOW®

M359015	Manifold, Foam 'n Flow
M519700	Bracket, Foam 'n Flow Manifold (4 per)
M538925	Foam Shield, SST



Carriage valves (Inside triple foam duct - NP)	
61915	Valve, Dema 3/8" SS (3 per)
61939-C	Cord, DIN 53"

21500003	Manifold, Mixing, Foam 'n Flow, PVC
62046	Valve, Check 3/8" push fit (3 per)

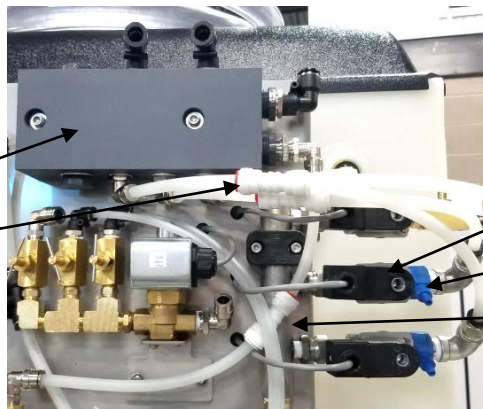

62052	Valve, Needle 1/4" BR (1 per)
61931-C	Cord, DIN 2 Cond 39"
61915	Valve, Sol. 3/8" NC (3 per) (Includes coil)
62376-X	Injector, .086 Blue (2 per)
21500001	Manifold, 3-Hole, Foam 'n Flow SST



2020 PICTORIAL PARTS BOOK



NOTE: Valve combination shown is a Razor® with Foam 'n Flow® and HyperFlex™ equipped. Razors equipped with either option singularly, will only contain (1) NO and (1) NC valve.

SPOT FREE CHANGEOVER (Foam 'n Flow® and HyperFlex™)

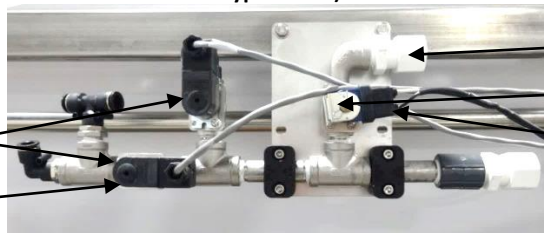

HYPERFLEX™

61940	Valve, Sol. 1/2" NC (2 shown)
34440002	Cord, DIN, 2 Cond. 10' (1 each NC valve)

41410003	Fitting, 3/4" Tube x 1/2" npt (2 shown)
46100002	Valve, Sol. 1/2" NO
34440001	Cord, Spade 2 cond. (NO valve only)

62035	Valve, Check 3/8" (2 per machine)
41030002	Nipple, 3/4" x 8" PVC (2 per machine)
21000002	Bracket, Side Pods, HF (2 per)
43030001	Foamer Head Single (2 per machine)

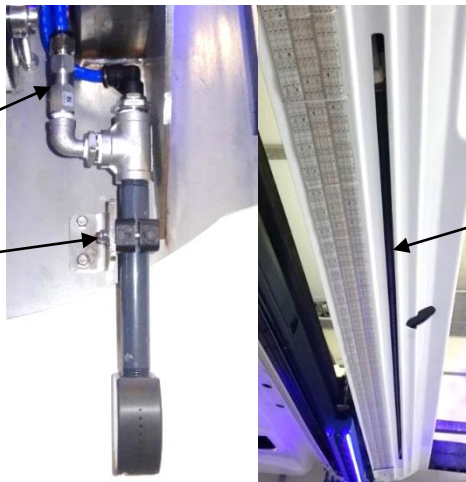

M359020	Manifold, HyperFlex
80020003	Decal, HyperFlex (NP)

62031	Valve, Check 1/2" (5 per)
43200001	Foamer Assembly, SST (2 per)

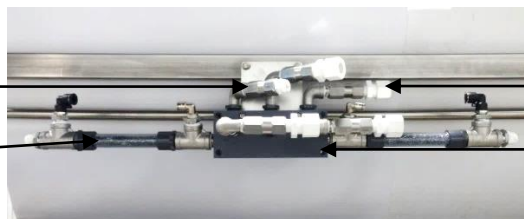

41410003	Fitting, 3/4" Tube x 1/2" npt (5 per)
21500005	Manifold, Mixing HyperFlex

33250	Cable, Air Reg. El-Pneu
46100001	Valve, Sol. 1/4" npt NC
25205	Regulator, Air, Elec. Pneu.

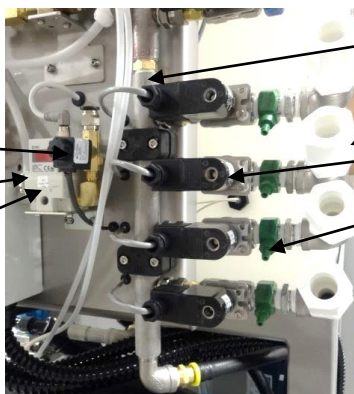

21500002	Manifold, 4-Hole, HyperFlex™ SST
41410003	Fitting, 3/4" Tube x 1/2" npt (4 per)
61915	Valve, Sol. 3/8" NC (Includes coil) (4 per)
62380-X	Injector, .125
HYPERFLEX™ INSTALLATION PARTS	
41570003	Poly Tubing, 3/4" OD 100 ft. spool
41570004	Poly Tubing, 3/4" OD 250 ft. spool
41410001	Fitting, Connector 3/4" T x 3/4" T



SPECTRARAY™



NOTE: The red LED strip is equipped with the SpectraRay™ or Foam 'n Flow® options.

34630001	LED Strip, Quad Row, Red
----------	--------------------------

21080006	Cap, End, LED (2 per strip)
21080012	Cover, LED Lens, Acrylic (3 per strip)
21080013	Mount, LED, PVC (2 per strip)
34630002	LED Strip, Quad Row, Green
34630003	LED Strip, Quad Row, Blue
34630004	LED Strip, Quad Row, Magenta



10028-WG	Term. Fuse Holder
31770001	Fuse, 7.5A, ATO

32050002	Power Supply, IP67, 24VDC
10041-FI	Relay & Socket, 24VDC, Solid State (3 per)

2020 PICTORIAL PARTS BOOK



CARRIAGE

CARRIAGE TRAVEL AND IDLER ROLLERS (NP)	
M618939	Roller, Black (2 per)
M618889	Roller, White (2 per)
M598906	Shaft, Carriage roller
M638902	Washer (1 per carriage roller)
M618951	Roller, Idler (4 per)
M598911	Shaft, Idler Roller (4 per)
M638899	Washer (1 per idler roller)
12389	Snap ring, 1" (2 per idler roller)

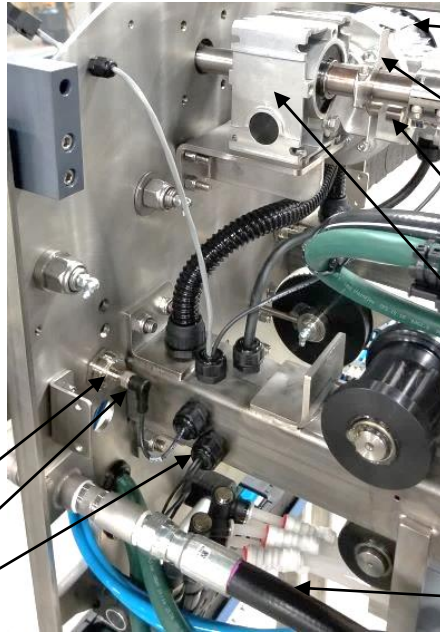

31010001	Motor, Carriage 1/2HP (Non-OBD)
36907	Motor, Carriage 3/4HP (OBD only - NP)
M508908	Flag, Carriage Pulse
M508900	Bracket, Carriage Pulse Prox
91921	Switch, Prox 18mm (Carriage/Trolley pulse - 2 total)
33259	Cord, Prox 5m 90deg
23010002	Gearbox, 25:1 Carr./Trly.

91922	Switch, Prox 30mm (Front/Rear limits - 2 total)
33259	Cord, Prox 5m
35304	Strain Relief 1/2"

42811	Hose, 3/4" x 180" w/wrap
-------	--------------------------

M598899	Shaft, Carriage 126"
12092	Coupling, 1" SST (2 per)
21080037	Strip, Wear UHMW (2 per)



21080032	Block, Cover Hinge (4 per)
8907	Bearing, 4 Bolt (2 per)
M598888	Shaft, Carriage Drive 6 1/2"
35304	Strain Relief, 1/2"

9970-K	Belt, Trolley
8950	Gear, Drive
8952	Bushing, Trolley Drive Gear
M598902	Shaft, Trolley Drive
M688932	Key, 3/16" x 3/16" x 1 1/4" (Bushing - NP)
M688943-4.68	Key, 1/4" x 1/4" x 4 11/16" (Gearbox - NP)
PK7-852852	Washer (2 per trolley shaft)
12389	Snap Ring, 1" (2 per)

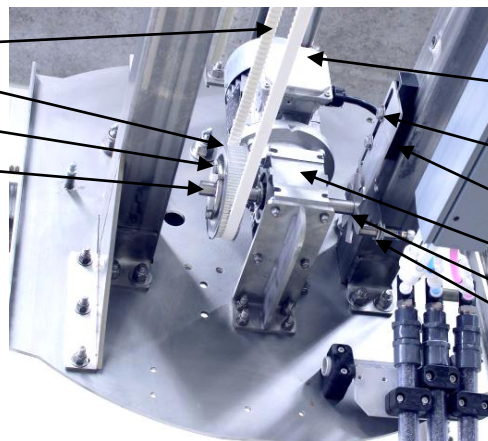

31010001	Motor, 1/2HP Carr./Trly.
M330898-S	Flag, Rail SST (Left/Right Limits - 2 per)
M658899	Block, Flag (2 per)
23010001	Gearbox, 25:1 Carr./Trly
M508907	Flag, Trolley Pulse
91921	Switch, Prox 18mm
33259	Cord, Prox 5m 90deg



2020 PICTORIAL PARTS BOOK



TROLLEY

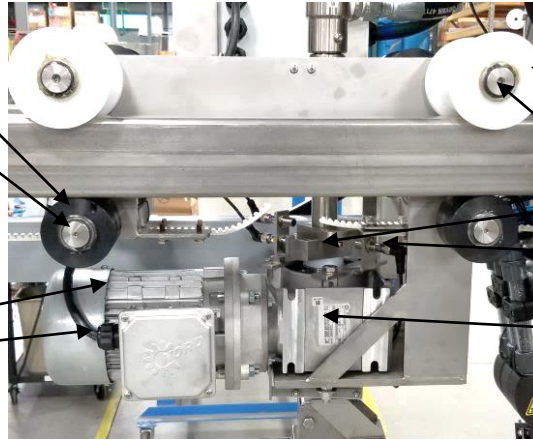

M618950	Roller, Eccentric
M598910	Shaft, Roller Eccentric
M638899	Washer (1 per roller)
12389	Snap Ring 1" (2 per roller)
31010001	Motor, Arch 1/2 HP
35295	Strain Relief M20

M618889	Roller, White
M618939	Roller, Black (NP)
M598903	Shaft, Trolley Roller (4 per)
M638891	Cam, Index
91919	Switch, Prox 12mm (3 total)
33259	Cord, Prox 5m
23010001	Gearbox, Arch 50:1

Razor® XR-7 Proximity Switch Listing			
Location	Part Number	Part Description	Razor® Equivalent
Front Limit	91922	Prox Switch 30mm Long	91915
Rear Limit	91922	Prox Switch 30mm Long	91915
Arch Position (3 Total)	91919	Prox Switch 12mm	91909
Left Limit (Trolley)	91923	Prox Switch 30mm Short	91914
Right Limit (Trolley)	91923	Prox Switch 30mm Short	91914
Carriage Pulse Counter	91921	Prox Switch 18mm Long	91910
Trolley Pulse Counter	91921	Prox Switch 18mm Long	91910
Impact Switch	91920	Prox Switch 18mm Short	91912

PUMP STATION



INJECTORS	
62369-X	.057 Inj. (RED)
62344-X	.070 Inj. (RED)
62375-X	.083 Inj. (GRAY)
62376-X	.086 Inj. (BLUE)
62304	Meter. Tip Kit
62035	Valve, Check 3/8"
61913	Valve Bank, 3 (ESD only - NP)
61914	Valve Bank, 4 (Standard and ESD-CC)
61912	Kit, Rebuild Sol. Valve Bank (1 per valve - for 61913 and 61914 - NP)
46130002	Regulator, LP
23936	Gauge, 0-300 psi
46130001	Regulator, HP
62196-24	Valve, Sol. 1/2" NC
24000	Gauge, 0-2000 psi

46100001	Valve, NC 1/4" NPT
25050	Regulator, Air 3/8"
23920	Gauge, 0-160 psi
62192-24	Valve, NO 3/8" (Weep)
25049	Regulator, Air 1/4"
23920	Gauge, 0-160 psi
46100001	Valve, NC 1/4" NPT

Pumps (NP)	
61050	Pump, Solution 1.5HP 3PH
61540	Pump, General HTCK4050
61589	Pump, CAT 3535

MOTORS AND BELT DRIVE	
36928	Motor, 25HP 208/460/380, 50/60Hz
9955-3BX	Belt, 66" 3V (General Pump only)
9956-3BX	Belt, 67" 3V (CAT 3535 only)



CARRIAGE

Parts pictured in this section address discontinued Revv™ gearboxes and motors. Most other parts associated with the Revv™ machine will match the Razor®. Contact Washworld Technical Support for any questions concerning compatibility.

DISCONTINUED	
17951	Gearbox 26:1 Carr. / Trolley
36909	Motor, .5HP Leeson Carriage / Trolley

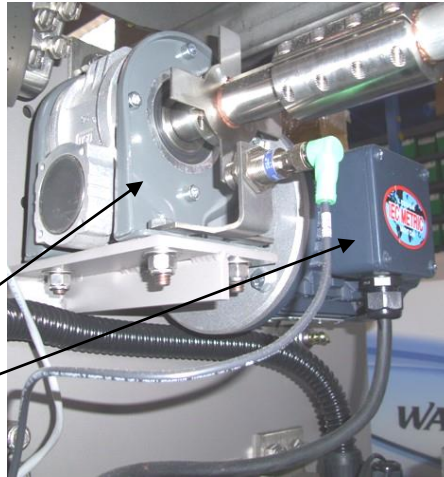

REVV™ CARRIAGE MOTOR AND GEARBOX RELACEMENT – TWO OPTIONS	
23010002	Gearbox, 25:1
31010001	Motor, 1/2HP
21080015	Plate, Adapter Revv Carriage/Trolley
OR	
17948	Gearbox, 25:1
36905	Motor, .37KW
21080015	Plate, Adapter Revv Carriage/Trolley
50400006	Update, Revv Carriage/Trolley (Contains one each of 23010002, 31010001, and 21080015)

TROLLEY

DISCONTINUED	
36909	Motor, .5HP Leeson Carriage / Trolley
17951	Gearbox 26:1 Carr. / Trolley

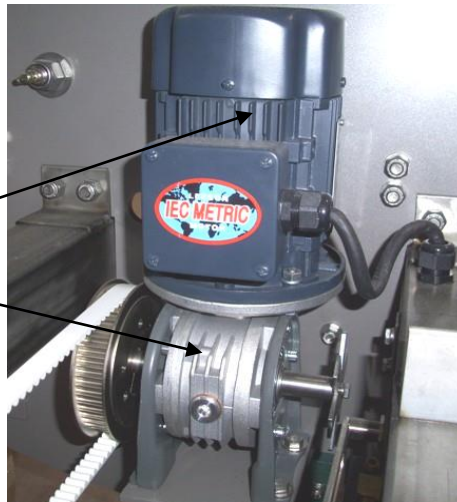

REVV™ TROLLEY MOTOR AND GEARBOX RELACEMENT – TWO OPTIONS	
23010002	Gearbox, 25:1
31010001	Motor, 1/2HP
21080015	Plate, Adapter Revv Carriage/Trolley
OR	
17948	Gearbox, 25:1
36905	Motor, .37KW
21080015	Plate, Adapter Revv Carriage/Trolley
50400006	Update, Revv Carriage/Trolley (Contains one each of 23010002, 31010001, and 21080015)

ARCH

DISCONTINUED	
17952	Gearbox, Arch Revv
36908	Motor, .35HP Leeson (Arch Only)



REVV™ ARCH MOTOR AND GEARBOX RELACEMENT	
23010001	Gearbox, 50:1
31010001	Motor, 1/2HP
60400004	Fastener Kit, Revv Arch Gearbox Replc.
M308940-S	Bracket, Double Prox (Required when replacing gearbox)
50400007	Update, Revv Arch Gearbox (Contains one each of 23010001, 31010001, 60400004, and M308940.)

2020 PICTORIAL PARTS BOOK



24 VAC LED SIGNAGE

24VAC EXTERIOR LED WAIT/GO SIGN (Part # WW20030-LED)	
83903	LED Strip, Green 14 Light (4 Per assembly)
83904	LED Strip, Red 14 Light (2 per assembly)

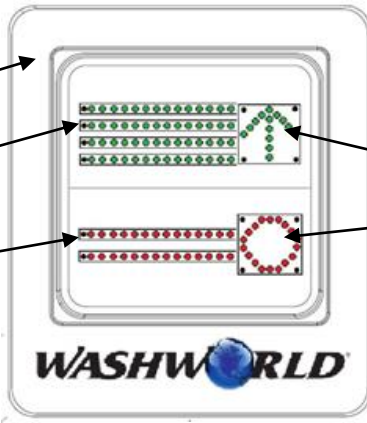

83880	LED Arrow, Green
83886	LED Stop, Red

24VAC DRYER LED COUNTDOWN TIMER W/STAND (Part #WW20012-LED)	
24VAC COUNTDOWN TIMER WITHOUT STAND (Part #WW20012-LED-NS)	

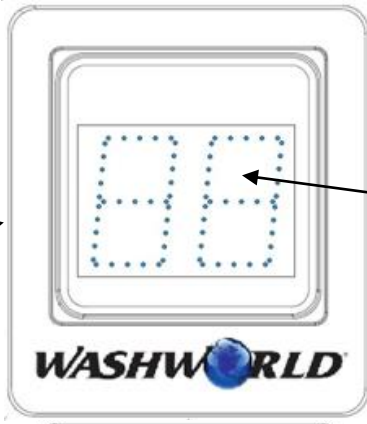

83878	LED Countdown Timer Board, Blue
-------	---------------------------------

24VAC INTERIOR LED INSTRUCTIONAL SIGN (Part # WW20008-LED)	
83894	LED Strip, Green (Drive Forward) (4 per assembly)
83890	LED Strip, Red (Stop) (3 per assembly)
83892	LED Strip, Amber (Back Up) (2 per assembly)
83896	LED Strip, Blue (2 per row)
84917	LED Face Kit (Used to reseal sign. Contains silicone caulk, gasket material, replacement screws, and instructions)

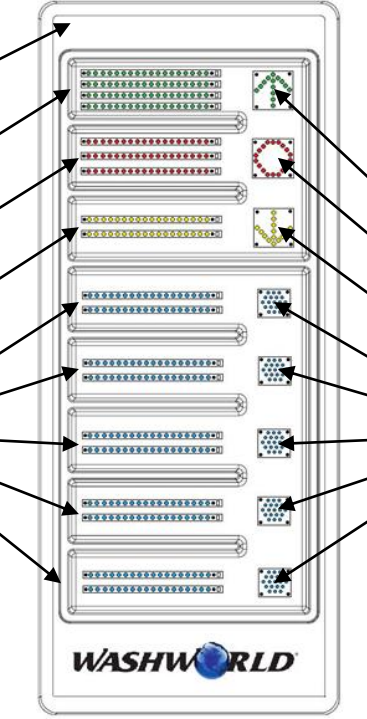

83880	LED Arrow, Green (Drive Forward)
83886	LED Stop, Red (Stop)
83882	LED Arrow, Amber (Back Up)
83888	LED Globe, Blue



12 VDC LED SIGNAGE

12VDC INTERIOR LED INSTRUCTIONAL SIGN (Part # WW20008-12V)	
WW20008-12VTF	12VDC LED Instructional Sign w/TF (NP)
82874	Decal, In-Bay 8 Panel STD
82874-TF	Decal, In-Bay 8 Panel w/TF (NP)



83894-3	LED Strip, 3 Light Green (Drive Forward) (2 per assembly)
83890-3	LED Strip, 3 Light Red (Stop) (2 per assembly)
83892-3	LED Strip, 3 Light Amber (Back Up) (2 per assembly)
83896-3	LED Strip, 3 Light Blue
33904	Enclosure, 3" x 3" x 2.6 Poly (NP)

LED, 12VDC EXTERIOR WAIT/GO SIGN (Part # WW20030-12V)	
WW20030-12VWP	12VDC LED Exterior Wait/Go sign with Wash Progress (NP)



82870	Decal, Wait/Go STD
82871	Decal, Wait/Go w/ Wash Progress (NP)

INTERNAL PICTURE OF 12VDC EXTERIOR WAIT/GO SIGN (Shown with Wash Progress option)	
83899	LED Module, 2 Light Blue (Wash progress only) (8 per assembly)

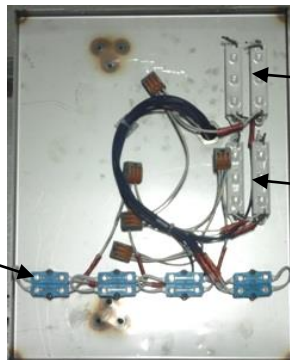

83894-3	LED Strip, 3 Light Green (Drive Forward) (2 per assembly)
83890-3	LED Strip, 3 Light Red (Stop) (2 per assembly)
33904	Enclosure, 3" x 3" x 2.6 Poly (NP)

DRYERS

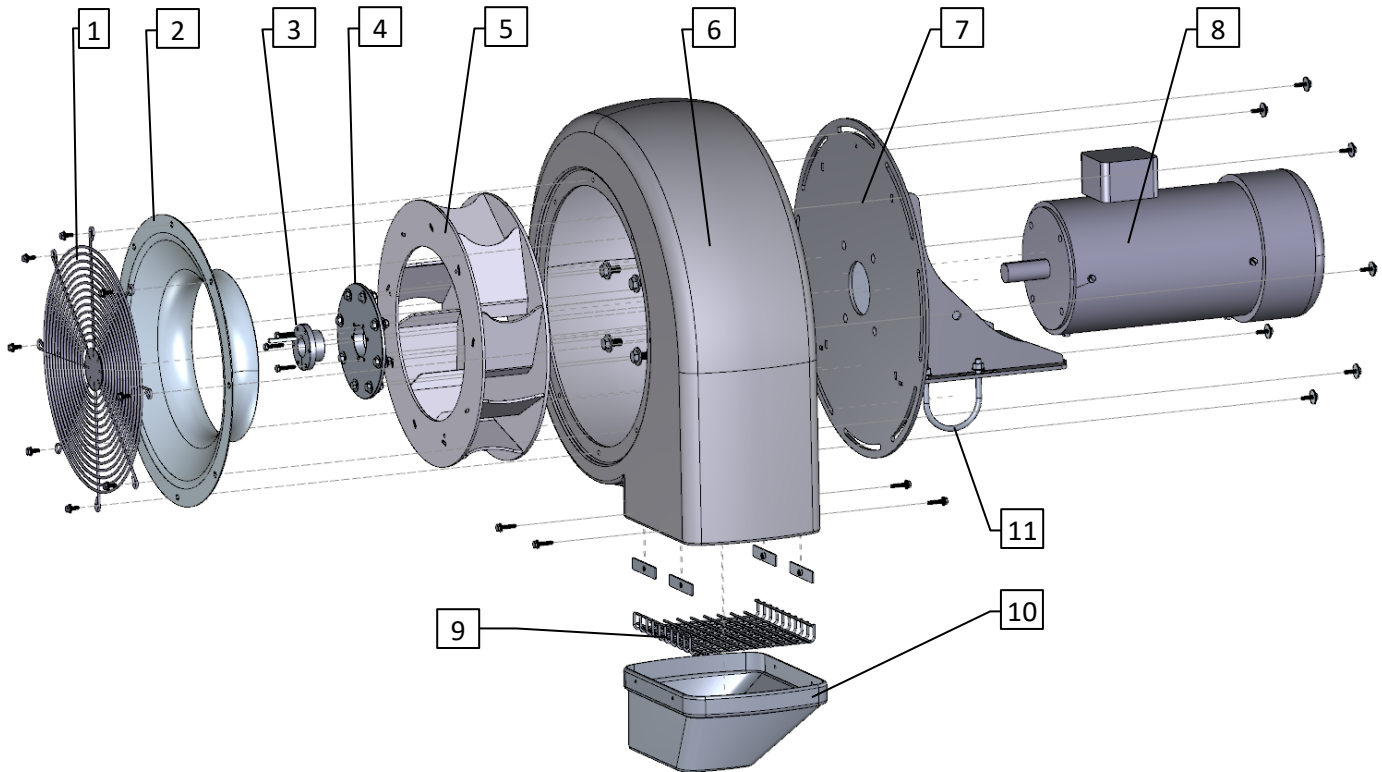

Ref. #	Part Number	Part Description	Ref. #	Part Number	Part Description
1	109	Inlet Screen SST	8a.	36910	Motor, 10HP Dryer (208/480V)
2	110	Inlet Cone	8b.	36911	Motor, 15HP Dryer (208/480V)
3	125	Bushing 1 3/8" SST (Includes key)	8c.	31060001	Motor, 7.5HP Dryer (208/480V)
4	330	Hub	9	126	Outlet Screen
5a.	124R	Impeller RH	10a.	130	Outlet Nozzle (RH)
5b.	124L	Impeller LH (NP)	10c.	120	Outlet Nozzle (Dual center) (NP)
6a.	112	Housing, Plastic RH	11a.	104	U-Bolt (Round 4")
6b.	111	Housing, Plastic LH (NP)	11b.	77098	U-Bolt (5" x 3" square) (NP)
7	101	Back Plate Assembly			

DRYER OSCILLATORS (CENTER)

NOTE: Previous versions of oscillating motor have been discontinued. The dryer oscillating motors are now three-phase powered instead of single phase. The following kits are required if changing the oscillating motor (* - 50/60Hz applications).

Part Number	Part Description	Req. Parts
36896	Motor, Oscillator, 1/8HP, 1PH (DISCONTINUED)	
31090001	Motor, Oscillator 1/8HP, 3PH, 60Hz	
50190011	Adapter Kit, 1PH to 3PH Conversion (New motor, gearbox, adapter plate and linkage)	*
50190013	Upgrade Kit, Dryer Starter Panel (3PH contactor and overload)	*



2020 PICTORIAL PARTS BOOK



Item Number	Item Description	Page Reference	Price (\$)
10005-WG	Terminal Block 4-pole Ground-Wago		\$8.75
10007-WG	Terminal Block 2-pole - Wago	10, 25-26	\$1.70
10008-WG	Terminal Block 4-pole - Wago	10, 26	\$2.75
10009-WG	Terminal Block 2-pole Ground-Wago	10, 25-26	\$5.50
10010-WG	Terminal Block 3W - Wago	10, 26	\$5.50
10011	Terminal Block End Stop		\$1.85
10012-WG	Terminal Block 2P End Cap Wago		\$1.25
10013-WG	Terminal Block 4P End Cap Wago		\$1.50
10014-WG	Terminal Block 3W End Cap Wago	26	\$0.80
10015-WG	Jumper - Wago	10, 25-26	\$1.00
10017-WG	Terminal Block 3W Jumper, Wago	10, 26	\$12.50
10020-WG	Terminal 2-pole 6GA - Wago		\$4.85
10021-WG	Terminal 2-pole GND 6GA wago		\$10.50
10025	Jumper Strip, Gray - AB Relays		\$8.75
10026-WG	Terminal, Double Deck Wago		\$4.16
10027-WG	Terminal, Quad Deck Motor Wago		\$12.83
10028-WG	Terminal, Fuse Holder Wago	26, 31	\$9.18
10031-AB	Circuit Breaker 1A - AB	24	\$153.75
10032-AB	Circuit Breaker 2A - AB	24	\$170.00
10033-AB	Circuit Breaker 7A - AB	24	\$170.00
10034-AB	Circuit Breaker 10A - AB	24	\$170.00
10035-AB	Circuit Breaker 15A - AB	24	\$170.25
10040-FI	Relay & Socket 24VDC Finder	9, 24	\$16.39
10041-FI	Relay & Socket 24VDC Solid State	31	\$37.20
10042-FI	Relay, 24VDC 8 Pin Finder	9, 24	\$6.62
10043-FI	Relay Base, 8 Pin Finder	9, 24	\$6.36
10080	Resistor, 500 ohm		\$1.00
101	Dryer Motor Mount Back Plate	37	\$645.00
10106-1A	Roller Assembly, E-Chain	18	\$211.25
10106-2A	Roller Assy, E-Chain FSF OBD	18	\$202.75
10106-3A	Roller Assy., E-Chain FSF	18	\$202.75
1024L	10hp Left Wheel		\$524.00
1024R	10hp Right Wheel		\$524.00
104	U-Bolt, 3.5", SST, Round	37	\$21.00
106	Stainless Square 4" U Bolt	37	\$12.00
10714	Ball 7/16 440 SS (Spray Arch)	4	\$0.00
10715	Ball 3/8" 440 SS (VA Spray Arch)	4, 15	\$1.05
10715-R	Virtual Attendant Retainer	4, 15	\$8.35
10789	Manifold Grease 4-hole	1, 3	\$41.80
10790	Manifold Grease 5-hole		\$19.00
10793	Manifold Grease Block 8-hole	14	\$43.00
10809	Breather, 1/8" NPT		\$1.75
109	Stainless Steel Inlet Screen	37	\$94.00
10917-3SD	Sheave 3B 6.2 3 Groove Type SD	7, 19, 21	\$80.00
10921-2SK	Sheave, 2B 11.0 SK		\$117.00
10932-3SK	Sheave 3B 13.6 3 Groove SK	7, 19, 21	\$169.00
10934-3SK	Sheave, 7.4x3B-SK	19	\$81.75
110	Inlet Cone	37	\$115.00
110B	Oscillating Inlet Cone		\$110.00
111	Left Composite Housing	37	\$515.00
112	Right Composite Housing	37	\$515.00



2020 PICTORIAL PARTS BOOK



Item Number	Item Description	Page Reference	Price (\$)
113	Dryer Silencer Cone		\$155.00
11407-SK	Bushing, Sheave 30mm SK		\$28.75
11408-SK	Bushing Sheave 35mm Type SK	7, 19, 21	\$28.75
11409-SK	Bushing Sheave 40mm Type SK		\$25.25
11417-SDS	Bushing, Sheave 1-5/8" SDS		\$19.00
11421-SD	Bushing Sheave 1-7/8 Type SD	7, 19, 21	\$22.75
11421-SK	Bushing Sheave 1-7/8 Type SK	19	\$28.75
11802-1.90S	Key 5/16 x .19 x 2.0L SS	2	\$15.84
11802-2S	Key 5/16 x .25 x 2.0L SS	2, 14	\$17.25
120	Dual Nozzle, Housing	37	\$230.00
12091	Drive Coupling 1-3/16 x 1-3/16	1	\$114.40
12092	Drive Coupling 1"	12, 32	\$101.20
12389	Snap Ring 1"	12-13, 32-33	\$0.50
124L	15hp Left Wheel	37	\$535.00
124R	15hp Right Wheel	37	\$535.00
125	Standard Bushing 1 3/8"		\$19.50
126	Discharge Screen		\$41.00
130	Composite Discharge Nozzle		\$125.00
130E	Composite Dryer Discharge Nozzle		\$110.00
130R	Composite Discharge Nozzle, Round		\$125.00
13906	Bumper Compression GBR-7		\$33.05
13940-S	Leveling Pad, SS 1/2"-13 thd		\$19.00
13976	Bumper Compression GBA-8	4, 15	\$44.53
15789	Tire 410/3.50-4 4-ply Tube Type	2	\$17.00
15790	Tube Inner 410-4	2	\$5.53
15791-S	Tire Rim 4 x 1-5/16 Stainless	2	\$10.47
17940-R3	Gear Box 30:1 D80 Flange	1, 2	\$813.00
17941-R3	Gear Box 50:1 D71 Flange-R3	2	\$813.00
17942-R3	Gear Box 50:1 D80 Flange-R3	1, 2	\$813.00
17948	Gear Box 25:1 Trolley/Carriage R3		\$556.25
17949	Gear Box 50:1 Arch R3		\$766.25
209-130	Plastic Wago Tool		\$6.10
21000002	BRACKET,SIDEPOD-MNT,1.75X2.5",	30	\$13.50
21000003	BRACKET,MNT,ARCH-LED-XMTR,SST		\$91.30
21000009	BRACKET,MNT,OHD-MANF,SST	22	\$36.75
21000010	BRACKET,MNT,WIRE-TENSION,SST		\$25.50
21000011	BRACKET,MNT,CARR,SF-CHGOV,SST		\$42.75
21000012	BRACKET,DVRTR-VALVE,GEN-HTCK40		\$64.25
21000013	BRACKET,7.00X4.75",304SST,RZR		\$26.00
21000014	BRACKET,MNT,OBDBTM-CVRS,1.5X2		\$78.00
21000015	BRACKET,MNT,LUMENARCH-LED-XMTR	15	\$23.50
21000016	BRACKET,MNT,LUMENARCH-LED-GND	14	\$18.00
21000017	BRACKET,MNT,DRYER-SONAR,.25THK		\$92.00
21000018	BRACKET,MNT,TUBE,DRYER-SONAR		\$58.00
21000019	BRACKET,MOUNT,LED,PRO-CVR,PVC		\$58.00
21000020	BRACKET,MNT,OBDFG-BTM-CVR,SST		\$66.00
21000023	BRACKET,LED-MNT-ATTACH,FNF,PRO		\$11.00
21000024	BRACKET,MNT,CARR-CVR,PS-ENT/DS		\$112.50
21000025	BRACKET,MNT,CARR-CVR,DS-ENT/PS		\$112.50
21000026	BRACKET,MNT,LATCH,CARR-CVR,SST		\$14.25
21004	Valve Sol 4-way 1/4npt 24vac		\$115.75



2020 PICTORIAL PARTS BOOK



Item Number	Item Description	Page Reference	Price (\$)
21006	Valve Sol 4-way 1/4" Long Body		\$202.09
21010	Valve, Directional Air 1/4"npt		\$94.48
21020004	BRACKET,SUPP,E-CHAIN-RLR,OBD	18	\$18.00
21020008	BRACKET,SPRT,CVR-PROP-ROD,7GA		\$63.25
21080001	BLOCK,LIFT-ASSY,W/ELEC-TAB	15	\$126.50
21080002	PAD,ARCH-CONT,.25X.25X2.5"LG		\$63.00
21080003	ANGLE,ARCH-CONT,90DEG,SST		\$91.28
21080004	FLAG,CARR,F/R,2.75X11.25"LG		\$14.25
21080006	COVER,LED,END-PTCT,3W,SST	31	\$11.00
21080009	COVER,LED,END-PTCT,1W,SST		\$8.75
21080010	PAD,ARCH-CONT,.25X.25X2.5"LG	14	\$21.25
21080011	TUBE,SONAR,2X2X6"LG,16GA,SST		\$38.25
21080012	COVER,LED-LENS,SR,ACRYLIC,CLR	31	\$7.50
21080013	MOUNT,LED-TRAY,EXIRN,PVC,WHT	31	\$51.00
21080014	CAP,END,LED-RTNR,SST	18	\$8.50
21080015	PLATE,ADPTR,GRBX,CARR-TRLY,REVV	34	\$77.00
21080016	SHROUD,CARR,BELT-HTR,CC,SST		\$225.00
21080018	PAD,ARCH-CONT,.25X.38XX2.5LG	15	\$35.00
21080020	BLOCK,MTG,CONTACT-PAD,.25"THK,		\$8.25
21080021	PLATE,INSULATOR,.06"THK,UHMW	15	\$5.25
21080022	ANGLE,ANODE-TAB,16GA,316SST		\$14.75
21080027	COVER,LED-LENS,R/G,ACRYLIC,CLR		\$3.50
21080029	ROD,PROP,CVR-SPRT,SST		\$121.00
21080032	BLOCK,HINGE,CARR-CVR,PVC,GREY	32	\$28.00
21080037	STRIP,WEAR,TRLY-E-CHAIN,PVC,GR	32	\$14.00
21220001	PEDESTAL,WLDMT,1"TUBEX38"LG,SST		\$132.75
21220002	PEDESTAL,WLDMT,1"TUBEX8"LG,SST		\$67.00
21280001	COVER,CARR,FR,W/SPECTRARAY-LED	29	\$1,004.00
21280003	COVER,CARR,REAR,W/FNF-LED-MNT	29	\$1,004.00
21280007	COVER,CARR,OBD-BTM,FRMD,ABS,WHT		\$650.00
21280009	COVER,CARR,F/R,ABS,FRMD,XR-7		\$624.00
21430001	MOUNT,CARR-RAIL,BELT-TENS,SST	18	\$14.75
21430002	SLIDE,CARR-BELT-TENS,SST	18	\$57.75
21430003	PLATE,CLAMP,CARR-BELT-TENS,SST	18	\$8.00
21430004	PLATE,BACKER,CARR-BELT-TENS,SST	18	\$7.50
21500001	MANIFOLD,3-HOLE,FNF,PUMP-ST,SST	29	\$73.50
21500002	MANIFOLD,4-HOLE,HYPRFLX,PUMP-STN	30	\$85.14
21500003	MANIFOLD,MXG,FNF,PUMP-ST,PVC	19, 29	\$252.50
21500004	MANIFOLD,1.5DIAx8"LG,W/2HOLE	20	\$55.00
21500005	MANIFOLD,MXG,HYPRFLX,CARR,RZR	30	\$346.50
21500006	MANIFOLD,W/FOAMER-PINS,1",SST	22	\$132.50
22060001	CAP,1x1",PLSTC,BLK		\$0.75
22910-FB	Compression Fitting, Straight	1, 3, 12, 14	\$2.00
22914-PB	Tube Fit Male 1/4T x 1/4npt	5	\$6.25
22925-PB	Tube Fit 3/8T x 1/4npt	17	\$5.25
22927-PB	Tube Fit 3/8 x 3/8npt		\$10.25
22928-PB	Tube Fit 3/8T x 1/4npt w/BV		\$15.00
22929-PB	Tube Fit 3/8T x 3/8fnpt		\$5.00
22930-NY	Tube Fit 3/8" Tee nylon		\$6.50
23060-PB	Tube Fit Union 1/2" Composite		\$0.00
23170-FB	Compression Fitting, Elbow	1, 12, 14	\$3.50



2020 PICTORIAL PARTS BOOK



Item Number	Item Description	Page Reference	Price (\$)
23237-PB	Tube Fit Swivel 3/8Tx1/4mpt	6	\$7.25
23239-PB	Tube Fit Male Swvl 3/8Tx3/8npt		\$15.75
23010001	GEARBOX,50:1,1-5/16"SS-BORE,NO-PNT	32-34	\$750.25
23010002	GEARBOX,25:1,1"SS-BORE,NO-PNT	32, 34	\$516.75
23240001	GUARD,SPLASH,PMP-STN,1/4"THK		\$32.00
23242-PB	Tube Fitting 1/2Tx1/2npt nylon	22	\$5.75
23245-PB	Tube Fit Elbow 1/2T x 1/2npt		\$14.50
23246-PB	Tube Fit 1/2T x 3/8npt		\$11.50
23920	Gauge 0-160psi 1/8cbm 1-1/2		\$6.64
23936	Pressure Gauge, 0-300psi R.O.		\$12.58
24000	Gauge 0-2000psi 1/4cbm Liq.		\$15.69
25035	FILTER,AIR,5 MICRON,1/4NPT		\$52.90
25036	FILTER,AIR,3 MICRON,1/4NPT		\$84.85
25037	BRACKET,FILTER,MODULAR/JOINER		\$9.80
25049	Regulator 1/4 Mini 125psi		\$50.50
25050	Regulator 3/8"		\$83.50
25199	Bracket Regular Mini		\$8.50
25200	Bracket Regulator 3/8"		\$15.50
25205	REGULATOR,AIR,EL-PNEU,4-20MA		\$364.25
25210	BRACKET,REGULATOR,AIR,EL-PNEU		\$16.75
280-120	Wago Screw Driver, Metal		\$10.75
28894	Contactora 9A 24vac (Tele)		\$88.75
28894-AB	Contactora 9A 24vac AB	9, 25	\$193.25
28916-24AB	Contactora 12A 24vac - AB	9, 25	\$249.25
28994	Contactora 32A 24v 50/60Hz Coil		\$156.30
29091	Contactora 80A 24vac (Tele)		\$316.29
29097	Contactora, 9A 24VAC Siemens		\$67.00
29391-AB	Overload Relay 1-5A - AB	9	\$135.75
29396	Overload Relay 63-80A		\$106.75
29402	Overload Relay 23-32 A- LC1D32		\$68.00
29408-AB	Overload 3.2-16A AB	9, 25	\$135.75
29412	Overload Relay 16-24A (Tele)		\$55.00
29908	Switch Float 1/4 Bung		\$40.00
29994	Switch Push Button 22mm, Black		\$4.97
29999-2POS	Switch Selector Key 7/8 2pos	10, 26	\$21.75
29999-3POS	Switch Selector Key 7/8 3pos	10	\$22.81
2P800	Filter Hsg w/Valve & 1"Screen	22	\$94.50
2P801-1	Filter Hsg w/SS Screen 3/4"	20	\$37.75
2P808	1/2" 80 Mesh Y-Strainer	8, 21	\$45.00
30000	Key, Square D Key Switch		\$19.50
30004	Switch, Push/Pull E-Stop		\$17.25
30005	Switch, Push/Pull E-Stop (AB)		\$76.25
30007	Switch, Push/Pull Black SQD		\$27.50
30010001	ENCL,ASSY,PMP-STN,FR-PNL		\$290.50
30010002	ENCL,ASSY,CARR,12X10",RZR		\$405.25
30010003	ENCL,ASSY,TRLY,6X8",RZR		\$250.75
30010004	ENCL,ASSY,BAY,12x10",RZR		\$317.75
30010005	ENCL,ASSY,PWR-SPLY,SR,RZR		\$439.75
30010006	ENCL,ASSY,HYPER-FLEX-OPT,RZR		\$287.00
30030001	KIT,ASSY,PC,RASP-PI,UCC		\$278.50
30093	Contact Block, N.C. - SQD		\$10.50



2020 PICTORIAL PARTS BOOK



Item Number	Item Description	Page Reference	Price (\$)
30093-BASE	Base, Contact Block - SQD		\$4.25
30094	Contact Block, 1 NO		\$8.25
30098	Contact Block, 1 NC - AB		\$32.75
30099	Contact Block, 1 NC		\$8.25
30300001	KIT,UCC,HSPD, ETHERNET-ASSY		\$253.90
30789	Joystick Operator, 4-pos		\$173.00
30907	Relay SPDT 10A 24vac Coil	25	\$7.49
30913	Relay SPDT 10A 24vdc Coil		\$6.00
30927	Relay DPDT 10A 24vac Coil		\$21.00
30928	Relay, SPDT 24vac 8 BL Siemens	24	\$14.00
30929	Relay Base, SPDT 24vac Siemens	24	\$7.25
30995	Relay Socket 5 BL	9, 25	\$6.75
31000	Relay Socket 14 BL		\$0.00
31010001	MOTOR,1/2HP,208/230VAC	32-34	\$274.25
31019	Relay Socket 11-pin Carlo	19	\$9.00
31030001	MOTOR,1HP,208-230/460,3PH,1745RPM	19, 30	\$404.25
31060001	MOTOR,7.5HP,208-230,3PH,60HZ	37	\$1,650.00
31090001	MOTOR,1/8HP,230/460,3PH,60HZ	37	\$1,089.00
31200001	CONTACTOR,12A,24VAC,NO-SPRG	25	\$81.50
31250001	CONTACTOR,600V,6A,3P,50/60HZ		\$58.00
31400001	DRIVE,VAR-FREQ,1/2HP/0.37KW,1PH	25	\$277.25
31410001	DRIVE,VAR,3/4HP & 1HP,SIEMENS	25	\$316.25
31520001	OVERLOAD,250VAC,0.8-12A,3P		\$60.25
31580001	CIR-BRKR,4A,1P,C-TRIP,L9-4/1/C	9, 25	\$27.25
31590001	CIR-BRKR,10A,1P,C-TRIP,SS	24	\$19.75
31590002	CIR-BRKR,6A,1P,C-TRIP,L9-6/1/C		\$27.25
31590003	CIR-BRKR,10A,1P,C-TRIP, L9-10/1/C		\$27.25
31590004	CIR-BRKR,7A,1P,C-TRIP, L8-7/1/C	25	\$19.75
31590005	CIR-BRKR,2A,1P,C-TRIP, L8-2/1/C	24-25	\$19.75
31590006	CIR-BRKR,6A,1P,C-TRIP, L8-6/1/C	25	\$19.75
31600001	CIR-BRKR,15A,1P,C-TRIP,L9-15/1/C		\$27.25
31640001	CIR-BRKR,4A,2P,D-TRIP,L9-4/2/D	25	\$84.50
31650001	CIR-BRKR,,10A,2P,C-TRIP, L9-10/2/C	25	\$54.25
31660001	CIR-BRKR,13A,2P,D-TRIP, L9-13/2/D	24, 25	\$62.50
31730001	PROTECTOR,CIRCUIT,4.5-6.3A,3P		\$127.75
31760001	FUSE,3A,ATO-3	26	\$1.00
31770001	FUSE,7.5A,ATO-75	31	\$1.00
32010001	XFMR,75VA,120/240VAC-24VAC,1PH		\$112.50
32050001	MODULE,PWR-SPLY,4-CHAN,24VDC	25	\$188.75
32050002	PWR-SPLY,24VDC,151.2W,IP67,CL2	31	\$90.00
32050003	PWR-SPLY,24VDC,151W,47-63HZ,IP67		\$77.00
32070001	PWR-SPLY,12VDC,35W,IP67,CL2	16, 26	\$44.50
32710001	CONTACT,BLOCK,NO,SQD	16, 26	\$9.25
33190001	MODULE,ENI,REM-ACCESS,RTA	9	\$1,420.00
33190002	SWITCH,ETHERNET,5-PORT,18-30V		\$148.75
33225-A	Cable, 5 Cond. Audio Preassembled		\$31.00
33240001	CARD,MEMORY,SD,24MB,SIMATIC		\$444.25
33250	CABLE,REGULATOR,AIR,EL PNEU		\$80.25
33255	Cord Temperature Probe 50'	23	\$67.00
33259	Cord Prox 12mm 90deg 2m	1-3, 12, 14-15, 32-	\$11.00
33260	Cord Prox 12mm 5m	3	\$18.00



2020 PICTORIAL PARTS BOOK



Item Number	Item Description	Page Reference	Price (\$)
33263	Cord Prox 90deg 5m		\$12.45
33264	Cord, 5m Shielded, Sonar	3	\$76.25
33270001	ROUTER,REM-ACCESS,EXP,EWON,FLEXY		\$1,291.50
33272	Cord, P&F Sonar 15m	3, 27-28	\$39.60
33276-L	E-Chain Linkage KR190 KS	17	\$10.00
33276-SL	E-Chain Linkg w/Slot KR190 KS	17	\$10.00
33277-C	Crosslink, KS KR130	17	\$8.25
33281	E-Chain Trolley 96.25" Igus		\$340.00
33281-A	E-Chain Assy Trlly Preassembled		\$770.00
33281-C	E-Chain Crosslink Igus 275.07		\$4.00
33281-D	E-Chain Divider Igus 260		\$2.00
33281-L	E-Chain Linkage Igus 27.07.200	14	\$10.00
33283	E-Chain Igus - Carriage	17	\$1,045.00
33283-A	E-Chain Assy, Carr. Preassmbld		\$2,185.00
33283-C	E-Chain Crosslink Igus 450.10	17	\$4.00
33283-D	E-Chain Divider Igus 401	17	\$2.00
33283-E	E-Chain End		\$105.00
33283-L	E-Chain Linkage Igus E4.56.01	17	\$15.00
33283-P	E-Chain Pivot Igus E4.56.02.20	17	\$15.00
33284-C	E-Chain Crosslink, Igus 450.25.20		\$7.25
33284-L	E-Chain Link, Igus E4.56.02.20		\$12.00
33284-P	E-Chain Pivot, Igus E4.56.01 P		\$12.00
33285	E-Chain Divider KS	17	\$0.75
33287	E-Chain Crosslink 5.22" KS	17	\$4.00
33289-S	Festoon Connector Clamp SS	3	\$44.25
33290	Festoon Cap Track		\$1.65
33290001	DRIVE,FLASH,USB-3.0,16GB		\$13.50
33291	Festoon Cable Clamp Stationary	3	\$18.00
33292-S	Festoon Track Rail SS 13'.124	3	\$210.00
33293	Festoon Roller f/Rail	3	\$22.00
33294-S	Festoon Support Bracket SS	3	\$32.00
33295-192 BLU	Cable, Flat 12con16awg 192"	3	\$87.75
33295-429 RED	Cable, Flat 12con-16awg 429"	3	\$167.75
33295-429 YEL	Cable, Flat 12con-16awg 429"	3	\$167.75
33295-600 GRN	Cable, Flat 12con-16awg 600"	3	\$228.50
33381	CABLE,18-COND,378"LG,CARR		\$217.25
33382	CABLE,18-COND,133"LG,TRLY,PS/RS		\$76.75
33420001	BUZZER,AUDIO,POS-PROMPT,24VDC		\$15.00
33530001	SENSOR,ULTRSN,30MM,ANLG-4-20M	3, 28	\$456.00
33800	Enclosure 6 x 8	26	\$74.50
33801	Panel 6 x 8	26	\$11.25
33802	Enclosure 12 x 10	26	\$99.00
33803	Panel 12 x 10	26	\$16.00
33904	Enclosure 3 x3 x2.6 Poly w/Cvr	36	\$43.00
33914	Enclosure 5.5x9 Poly w/1" Cvr	6, 20	\$97.00
33939	Enclosure 220x300x150 pvc	10	\$122.75
33940	Panel, J3 Enclosure	10	\$24.00
33944	Enclosure 220x170x80 J4	10	\$92.50
33959	Enclosure Poly 10 x 7 J6	10	\$105.75
33961	Window Kit Poly f/IB Washview		\$259.00
34130001	JUMPER,STRIP,20W,36A,250V,BLUE	9	\$2.75



2020 PICTORIAL PARTS BOOK



Item Number	Item Description	Page Reference	Price (\$)
34130002	JUMPER,STRIP,20W,36A,250V,RED	9	\$2.75
34150001	CAP,END,FUSE-TERM,WAGO		\$1.25
34160001	TERMINAL,PYRAMID,32-CONN		\$1.25
34160002	CAP,END,TERM,32-CONN		\$27.75
34220001	LINK,E-CHAIN,INS-PIVOT,E4.56.0		\$34.00
34220002	LINK,E-CHAIN,END-MNT,CARR,MALE		\$12.50
34220003	LINK,E-CHAIN,END-MNT,TRLY,FEMALE	14	\$12.50
34440001	CONN,WIRE,SOL-VLV,2-COND,54"LG	30	\$5.00
34440002	CONN,DIN,2-COND,18GA,10' 6"LG	30	\$24.25
34450001	RELIEF,STRAIN,25MM-THD,9-16MM		\$7.25
34630001	LED,STRIP,QUAD-ROW,RED,24VDC	31	\$372.50
34630002	LED,STRIP,QUAD-ROW,GREEN,24VDC	31	\$372.50
34630003	LED,STRIP,QUAD-ROW,BLUE,24VDC	31	\$372.50
34630004	LED,STRIP,QUAD-ROW,PINK,24VDC	31	\$372.50
34894-1/2	Conduit, 1/2" Flexible Non-Met	1	\$1.50
34895-3/4	Conduit, 3/4" Flexible Non-Met	4, 28	\$2.75
34896-1	Conduit, 1" Flexible Non-Met		\$2.75
34969	Conduit Connector 1/2" Str.		\$3.50
34970	Conduit Connector 3/4" Str.		\$5.25
34971	Conduit Connector 3/4" Adj.		\$12.52
34972	Conduit Connector 1" Str.		\$8.25
34973	Conduit Connector 1/2" Adjust	1, 4, 28	\$6.00
34977	Conduit Connector 1" 90 deg.		\$6.75
35042	Locknut 1/2"		\$0.35
35044	Locknut 1"		\$0.75
35061	Knockout Adaptor 1 x 3/4		\$0.75
35062	Knockout Adaptor 1-1/2 x 1		\$1.75
35287	Strain Relief 1/4npt w/Nut		\$2.25
35290	Strain Relief PG11 w/Nut		\$2.16
35291	Strain Relief PG13 w/Nut	10	\$3.61
35295	Strain Relief M20 x1.5 w/Seal	33	\$3.00
35304	Strain Relief 1/2 .31-.56 Cord	12, 26, 32	\$2.83
35306	Strain Relief .512 - .709	25-27	\$10.96
35950-2	Fuse, 2A Littlefuse ATO-2	26	\$1.30
3610	Analog Input 4 pt. 1762-IF4		\$700.00
3629	PLC Base 1764 24 BWA	8, 23	\$1,061.00
3632	PLC 1764 LRP	8, 23	\$702.25
3633	Battery PLC 1500 AB	8	\$255.75
3637	Memory Module 1764 MM2RTC	8, 23	\$473.50
36429-SM	Circuit Breaker, 2A 1P Siemens		\$44.00
36432-SM	Circuit Breaker, 4A 1P C Trip		\$39.00
36435	Circuit Breaker 3A 1-pole	24	\$156.00
36436-MG	Circuit Breaker 6A 1P D Curve		\$153.75
36440	Circuit Breaker, 9A-12.5A Siemens	25	\$149.00
36441	Circuit Breaker, 2.8A-4A Siemens		\$123.00
36444-MG	Circuit Breaker 13A 1P D Curve		\$153.75
3645	Module End Cap 1769	8, 23	\$66.00
36475-MG	Circuit Breaker 4A 3P D-Trip		\$407.75
36477-MG	Circuit Breaker 6A 3P D-Trip	9, 24	\$407.75
36480-AB	Circuit Breaker 10-16A 3P	9, 24	\$452.25
36482-AB	Circuit Breaker 16A 2-pole		\$289.00



2020 PICTORIAL PARTS BOOK



Item Number	Item Description	Page Reference	Price (\$)
3650	AnalogCard 17691F4XOF2	8, 23	\$1,137.00
3651	InputCard 16pt 1769 IQ16	8, 23	\$467.00
36556-MG	Circuit Breaker 6A 2P - AB	9	\$295.50
36556-SM	Circuit Breaker, 6A 2P D Trip		\$87.00
3659	Output Card 16pt 1769 OB16	8, 23	\$607.50
3671	Cisco Router RV 180 4-port		\$280.00
3672	PLC 1400 DC In Relay Out (RZR2)	24	\$1,590.00
3673	PLC ML1400 L32BWAA (RZR3)	24	\$1,980.00
3674	Memory Module 1400	24	\$382.00
3676	Input Card 1400 16pt	24	\$417.50
3678	Output Module 1400 16pt	24	\$507.75
3680	Analog Module 1400	24	\$1,210.00
3682	HMI Touch Panel 5.7" Color	23	\$1,103.25
3682-B	HMI, Back Module, No Screen		\$648.91
3682-F	HMI, Face Only		\$668.00
36898-D	Motor 0.5hp B5 1800rpm	1, 2	\$378.01
36902-T	Motor 1.3hp 1800rpm Trolley		\$497.57
36905	Motor .37kW, 1/2hp Carr/Trlly	12-13, 34	\$288.00
36907	Motor .75hp Carrg/OBD w/Cplg	12, 32	\$691.25
36910	Motor 10hp TEFC Dryer	37	\$1,850.00
36911	Motor 15hp TEFC Dryer	37	\$2,000.00
36928	MOTOR,25HP,208/460/380,50/60Hz	7, 19, 21, 23	Call for price
36929	MOTOR,25HP,575V,60Hz,WEG	7, 19, 21	Call for price
3705	PLC, Siem. CPU 1215	24	\$957.00
3710	PLC, Siem. CPU 1214	24	\$649.00
3720	I/O Module, SM1223	24	\$491.00
3725	Card, Siem. Output SM1222	24	\$301.00
3730	Card, Siem. Analog SM 1231	24	\$646.00
3735	Card, Eth. Comm. CSM 1277		\$217.25
37402-AB	Power Supply AB-24vdc 2.1A	24	\$216.00
37403	Power Supply 12vdc, 40W		\$87.00
37409	Transformer, 208/24V HV/Razor		\$171.50
37412	Transformer, Buck Boost 750VA		\$321.25
37450	Power Supply, 24VDC/5A Siemens	25	\$233.53
37455	Power Supply, 12VDC/4.5A Siemens	25	\$151.03
3750	Card, Memory SD Flash 4MB SIMATIC	24	\$98.00
3755	Parameter Loader, Sinamics V20		\$211.50
37620	Drive, VFD 1HP 1PH SIMATIC		\$350.00
37622	Drive, VFD 3/4HP 1PH SIMATIC		\$296.17
37624	Drive, VFD 1/2HP 1PH SIMATIC		\$271.96
37628	PLATE,MOUNT,V20 A/B,SINAMICS		\$12.75
37647	Drive Variable Freq 2hp 3ph AB		\$1,215.00
37648	Drive Variable Freq 2hp 1ph AB		\$1,290.00
37649-3PH	Drive Var Freq 1hp 3ph	25	\$963.00
37789	Heater Strip 1x 3" 24vac 7.5w		\$26.78
37791	Heater Strip 1x 123" 120v 185w		\$164.50
37792	Heater Strip 1x 3" 24vac 20w		\$24.50
37793	Heater Strip 1x 22" 24vac 80w		\$43.25
37801	Heater Strip 1x 300" 220v 450w	18	\$370.00
38498	Junction Box Outdoor 2 x 4		\$5.87
38502	Cover Plate Weatherproof Blank		\$2.09



2020 PICTORIAL PARTS BOOK



Item Number	Item Description	Page Reference	Price (\$)
40010001	E-CHAIN,ASSY,PS/RS,CARR,BASE,RZR	14	\$2,215.50
40010002	E-CHAIN,ASSY,DS/LS,CARR,BASE,RZR	14	\$2,215.50
40010003	KIT,E-CHAIN,CARR,SPOT-FREE,RZR		\$127.00
40010004	KIT,E-CHAIN,CARR,TRI-FOAM,RZR		\$111.00
40010005	KIT,E-CHAIN,CARR,FNF,RZR		\$146.00
40010008	E-CHAIN,ASSY,PS/RS,TRLY,RZR		\$769.00
40010009	E-CHAIN,ASSY,DS/LS,TRLY,RZR		\$769.00
40010010	E-CHAIN,ASSY,HYPRFLX,RZR		\$1,647.00
40010011	TUBE,FILL,ASSY,MAIN-TANK,SCH40		\$7.00
40010012	TUBE,FILL,ASSY,W/TEE,MAIN-TANK		\$9.50
40010013	TUBE,FILL,ASSY,RECLAIM,MAIN-TANK		\$7.00
40150001	KIT,DIRECT-VENT,TANKLESS-WTR-HTR		\$400.00
41000001	ELBOW,PIPE,1-1/2"NPT,BR		\$35.75
41030002	NIPPLE,3/4NPTX8"LG,SCH80,PVC	30	\$3.75
41030003	NIPPLE,3/4NPT,CLOSE,SCH80,SST		\$12.00
41050001	TEE,3/4NPT,SCH80,FGD,SST	22	\$30.25
41070001	HOSEBARB,1/2"HX3/4NPT,BR		\$12.00
41110001	COUPLING,FULL,1-1/2NPT,SST		\$12.50
41150001	FITTING,TUBE,2-WAY-DIVDR,3/8"		\$2.75
41300001	PLUG,HEX,#6-SAE,W/O-RING,SST		\$6.00
41400001	FITTING,TUBE,90DEG,DBL-3/8TX1/2"	4, 17	\$23.50
41400002	ADAPTER,RDCR,HEX,3/4NPTX1/2NPT		\$5.25
41410001	CONNECTOR,STR,3/4"T,PLSTC	30	\$9.25
41410002	FITTING,COMP,3/4"TX3/4NPT,WHIT	13	\$6.25
41410003	FITTING,COMP,3/4TX1/2NPT,WHITE	30	\$6.05
41430001	FITTING,HYD,ADAPT,3/4FMX3/4NPT	22	\$12.10
41550001	HOSE,ASSY,3/8"X30.50"LG,300PSI	19	\$26.00
41550002	HOSE,ASSY,3/8"X32.50"LG,300PSI	19	\$27.00
41550003	HOSE,ASSY,1/2"X41"LG,300PSI		\$31.00
41550004	HOSE,ASSY,1/2"X56"LG,300PSI		\$34.00
41550005	HOSE,CORR,2"DIAX16.13"LG,BLK	20	\$16.50
41550006	TUBING,VINYL,3/4"IDX1"ODX10"LG		\$35.90
41550007	HOSE,ASSY,3/8",300PSI,3/8"MNPT		\$31.00
41550008	HOSE,ASSY,3/8",300PSI,3/8"MNPT		\$32.00
41570002	TUBING,POLY,3/4"OD,NAVY-BLU(Per foot)		\$3.75
41570003	TUBING,POLY,3/4"OD,BLU,100FT-SPOOL	30	\$352.00
41570004	TUBING,POLY,3/4"OD,BLU,250FT-SPOOL	30	\$880.00
41937-28	Hose Assy, 3/8 x 1/4 x 28 L	7, 21, 28	\$22.50
41937-67	Hose Assy, 3/8 x 1/4 x 67 L		\$28.50
41938-24	Hose Assy, 3/8 x 1/4 x 24 L		\$17.25
41938-28	Hose Assy, 3/8 x 3/8 x 28 L	7, 21	\$20.25
41938-30	Hose Assy, 3/8 x 1/4 x 30 L	7, 21	\$23.25
41939-30	Hose Assy, 3/8" x 30" OAL		\$21.25
41939-41	Hose Assy, 3/8" x 41" OAL	8	\$22.25
41939-48	Hose Assy, 3/8" x 48" OAL		\$24.75
41940-40.5	Hose Assy, 3/8Fx1/4Mx40.5 OAL		\$37.25
42010001	PUMP,2HP,208-230/460,3PH,60HZ,	20	\$956.50
42010002	PUMP,2HP,380V,3PH,50HZ,15ST	20	\$1,034.00
42200001	KIT,REBUILD,SEALS,CAT-2530,REQ		\$345.75
42200002	KIT,REBUILD,VALVE,CAT-2530,REQ		\$294.25
42789	Hose Assy, 1"x 27" OAL Swvl		\$65.25



2020 PICTORIAL PARTS BOOK



Item Number	Item Description	Page Reference	Price (\$)
42790-19.5	Hose, 1"x 19.5" OAL 2000psi GP		\$75.25
42790-22	Hose Assy, 1"x 22" OAL	6, 7, 21	\$57.25
42790-24.5	Hose Assy, 1"x 24.5" OAL		\$98.65
42790.19.5	Hose, Assy 1"x 20.25" 2000psi		\$63.25
42791	Hose Assy, 1"x 18" OAL 2000psi	5	\$60.25
42800	Hose Assy, 1"x 43.5" OAL Swvl	5	\$138.85
42811	Hose Assy, 3/4"x 180" 2000psi	13, 14, 32	\$261.00
42812	Hose Assy 3/4x 69.5 JIC x mnpt	13	\$50.25
42813	Hose Assy, 1/2"x 53"	17	\$28.25
42813-40	Hose Assy, 1/2"x 40.5"		\$26.25
42815	Hose Assy, 3/4x211.5 2000psi	17	\$454.36
42830	Hose Assy. 1/2"x 50" male swvl		\$42.25
42832	Hose Assy. 1/2"x 98" male swvl		\$54.25
42834	Hose Assy 1/2"x108.5" male swv		\$60.25
42836	Hose Assy. 1/2 x 1/2 x 15.75 OAL		\$34.25
42840	Hose Assy., 1/2" x 21" OAL PWD		\$38.25
42841	Hose, 1/2" x 1/2" x 38.5 OAL		\$36.25
42845	Hose Assy. 3/8" x 17" OAL		\$41.25
42846	Hose Assy. 3/8" x 98" OAL		\$59.25
42847	Hose Assy. 3/8" x 50" OAL		\$62.25
42848	Hose Assy. 3/8" x 38.5" OAL		\$56.25
42849	Hose Assy. 3/8" x 60" OAL		\$60.25
42903	Spiral Wrap, 3/4"		\$4.75
43030001	NOZZLE,FOAMING,SINGLE-STREAM	30	\$108.00
43200001	FOAMER,ASSY,SST-MXR,PVC-HSG,3/4"	4, 17, 30	\$32.00
43210001	PAD,SCRUB,MXG-MATL,1/4PAD,SST	4, 17	\$2.00
43210003	PAD,SCRUB,MXG-MATL,.33,SST	22	\$2.75
43442-S	Hyd Ftg Fem Swvl 3/8x1/4npt	5, 21	\$21.50
43444	Adapter 1/2mnpt x 1/2 FJIC		\$4.50
43445	Adapter 1/2mnpt x 1/2 MJIC		\$1.75
43446	Adapter, JIC 3/4"M x 1/2"M		\$4.65
43448	Fitting, JIC 1/2" M x F		\$12.75
43451	Hyd Ftg Adpt 1fm x 1mpt	5, 23	\$14.75
43933	Oil Quart SHC626 50:1 Gearbox		\$25.00
43949	Oil 2.5gal Cat Pump	7, 19	\$121.00
43951	Oil 2.5gal General Pump	7	\$100.00
43959	Grease Cartridge Arctic		\$15.00
43975	Lubricant,Silicone, 1cc		\$29.00
46100001	VALVE,SOL,NC,24VAC,1/4NPT	19, 30, 31	\$37.00
46100002	VALVE,SOL,NO,24VAC,1/2NPT,3-15		\$139.00
46130001	VALVE,REG,3/4NPTX1/NPT,HP-SPRING	5-6, 19, 20, 33	\$175.00
46130002	VALVE,REG,3/4NPTX1/NPT,LP-SPRING	6, 33	\$175.00
46260001	KIT,ORIFICE,VDHT,HP-RCS,DF		\$166.39
46260002	KIT,REPAIR,CWR4525-REGULATOR	6	\$45.00
46360001	FILTER,ELEMENT,REPL,5-MRCN	19	\$5.25
46360002	FILTER,ELEMENT,REPL,3-MRCN	19	\$19.75
46520001	ELEMENT,HTR,ELEC,208V,3PH,COPPER		\$200.00
46520002	ELEMENT,HTR,ELEC,575V,3PH,COPPER		\$200.00
46520003	ELEMENT,HTR,ELEC,480V,3PH,COPPER		\$200.00
46520004	ELEMENT,HTR,ELEC,415V,3PH,COPPER		\$200.00
46520005	ELEMENT,HTR,ELEC,240V,3PH,COPPER		\$200.00



2020 PICTORIAL PARTS BOOK



Item Number	Item Description	Page Reference	Price (\$)
50190011	ADAPTER,KIT,DRYER-OSC,1/8HP,1PH	37	\$1,179.25
50190013	UPGRADE,KIT,DRYER-S/P,3PH-OSC	37	\$120.44
50310001	KIT,SPARE-PTS,CUST,RZR4		\$2,950.00
50310002	KIT,SPARE-PTS,CUST,XR-7		\$2,950.00
50400001	RETROFIT,SP-ARCH,LUMENARCH,21-NOZ	16	\$3,412.85
50400002	RETROFIT,SP-ARCH,LUMENARCH,21-NOZ	16	\$2,195.00
50400003	RETROFIT,SP-ARCH,LUMENARCH,21-NOZ	16	\$1,495.00
50400006	RETROFIT,GRBX-RPLCMNT,CARR-TRLY	34	\$867.52
50400007	RETROFIT,GRBX-RPLCMNT,ARCH,REV	34	\$1,028.08
50420001	UPDATE,RZR4,UB-EYE-HSGS,CMPLT	27	\$400.00
50420002	UPDATE,RZR4,UB-EYE-HSGS,CMPLT	27	\$457.50
50420003	UPDATE,RZR4,SNR-HSGS,CMPLT	27	\$1,045.68
50420004	UPDATE,RZR4,SNR-HSGS,W/HEAT,CMPLT	27	\$1,145.10
50420005	UPDATE,RZR4,LDG-EYE-HSGS,CMPLT	27	\$553.50
50420006	UPDATE,RZR4,LDG-EYE-HSGS,W/HEAT	27	\$667.20
50480001	UPDATE,HV+RZR1,SIDE-SONAR,30MM	3, 28	\$486.71
50480002	UPDATE,CARR-BELT-TENS,PRO-RZR	18	\$366.00
50720001	KIT,NOZZLE,UC,RCKR-BLSTR,RZR		\$79.38
50720002	KIT,NOZZLE,UC,PWR-TWR,6-NZL,RZR		\$42.94
50720003	KIT,NOZZLE,UC,PWR-TWR,12-NZL,RZR		\$21.65
59015	Heater Cartridge Style 9W	17	\$28.00
59914-32	Hose 2" ID Blk Corrug Suct 32"		\$34.50
59959-10	Hose 1-1/4" Drain f/Main Tank		\$24.75
61037	Drive Coupling 25-2600 Series	8	\$35.00
61048	Pump Fluid-O-Tech 800F 4.1-158	8	\$180.40
61050	Pump Sta-Rite 1.5hp 3ph	8, 21, 33	\$797.00
61050-50	Pump Sta-Rite 1hp 50Hz 3ph	8, 21	\$1,287.00
61051	Pump Sta-Rite 1.5 TEFC		\$1,100.00
61055	Pump Gould 1.5hp 3ph 15stage		\$786.00
61057	Pump, Gould 3HP 3PH 14 Stage		\$925.50
61058	Pump, Gould 3HP 21 Stage (3PH,		\$1,482.30
61060	Rebuild Kit StaRite Pump HP6F3	8, 21	\$528.75
61188	Pump 3/4hp 60Hz 115/230 1ph		\$679.00
61189	Pump Sta-Rite 1hp	8, 21	\$701.75
61190	Sta-Rite 1hp - Noryl Impeller	8	\$785.00
61205	Pump, 1HP 1PH F&W (2400GPD)		\$844.00
61540	Pump, General (Emperor) HTCK40		Call for price
61584	Adapter, 1/2" BPSS x 1/4" FMPT		\$25.25
61588	Drain Kit, CAT Pump		\$62.00
61589	Cat Pump 3535		Call for price
61589-S-KIT	Seal Kit, Cat (1 per pump)	7, 19	\$571.00
61589-VKIT	Valve Kit, Cat (2 per pump)	7, 19	\$463.32
61590	Key (M10x8x70)	19	\$10.25
61700	Submersible Pump		\$224.00
61912	KIT,REBUILD,SOL-VLV-BANK	33	\$10.25
61913	Valve Bank Assy. 3-port	33	\$266.75
61914	Valve Bank Assy. 4-port	33	\$346.75
61915	Valve, Dema 3/8" SS	5-6, 19-21, 29-30	\$88.00
61924	Valve Sol 1/8 90psi 24vac	6	\$104.50
61929	Coil Danfoss 24vac 60Hz	5-7, 13, 20-21	\$22.24
61930	Valve Danfoss 3/8 Water	5-6, 13, 20-21	\$56.90



2020 PICTORIAL PARTS BOOK



Item Number	Item Description	Page Reference	Price (\$)
61930-S	Valve Danfoss 3/8 SS Seat		\$99.95
61931-C	Plug Connector w/39" Cord	6, 13, 29	\$17.75
61931-R	Terminal Cord, DIN 63" Reclaim	22	\$85.00
61933	Coil Danfoss 24vac 50Hz	13, 20	\$26.80
61934	Repair Kit 3/8" Danfoss Valve		\$29.25
61936-50	Valve Sol 1/2 NC 50/60Hz 24vac		\$110.00
61937-50	Valve Sol 1/2 NO 50/60Hz 24vac		\$144.75
61939-C	Terminal Cord, DIN, 51"LG	7, 19, 21-22, 29	\$18.75
61939-DF	Valve, Solenoid 1" NC 24/60	7	\$153.00
61939-DF-KIT	Rebuild Kit Valve Sol 1" NC		\$50.00
61940	Valve, Dema 1/2" NC SS 24VAC	19, 30	\$89.50
61941	Valve, Dema 3/4" NC PL 24VAC	7, 22	\$144.00
61951	Valve Sol RCS-HP Unloaders	6, 20	\$425.70
61952	Valve Sol 1" DP NO/NC ver2	6, 13, 20	\$880.00
61952-KIT	Repair Kit, 1" DP NO/NC Valve	6, 13, 20	\$170.00
61952-S-KIT	Seal Kit, VDHT Valve		\$107.20
61953	Stem, N.O. 1" HP Danfoss Valve	6, 13, 20	\$232.80
61954	Stem, N.C. 1" HP Danfoss Valve		\$175.14
62009	Valve Check 1" 200psi w/10#	28	\$66.25
62015	Valve, Ball 1" PVC		\$68.00
62016	Valve, Ball 2" PVC		\$148.75
62023	Foot Valve w/Strainer		\$6.50
62025	Valve Check 1/4" fnpt brass		\$15.00
62026	Valve Check 3/8 Female 1500psi		\$18.00
62028	Valve, Check 3/4" Female 3500psi		\$80.00
62029	Valve Check 3/4 Female 3000psi		\$243.75
62030-F	Valve Check 3/4, Viton Female	5, 13, 22-23	\$52.50
62031	Valve Check 1/2 FM x FM 3200	5, 22, 23, 30	\$52.45
62035	VALVE,CHECK,3/8NPT,Fx,F,SST	19, 20, 30, 33	\$35.00
62041	Valve Ball Check 1" Union pvc	22	\$58.96
62045	Valve Check, 2" Union pvc	22	\$130.00
62046	Valve Check, 3/8" tube fitt	4, 17, 29	\$15.00
62047	Valve Check, 1/2" tube fitt		\$17.25
62048	Valve, Check 1/4" Push fit		\$13.25
62052	Valve Needle 1/4 Fem. 150psi	5, 6, 20, 29	\$14.75
62062	Valve Check 1/4 MxM 5000psi	5, 6, 20	\$31.50
62063	Valve Check 1/4 FxF 3000psi	5	\$23.89
62071	Valve Relief 1/2"150psi br 451	5, 22, 23	\$20.75
62077	Valve Pressure Relief 3/4x1/2		\$182.00
62077-KIT	Rebuild Kit f/ 62077 and 62080		\$39.60
62080	Valve, Press. Relief 3/4 x 1/2		\$182.00
62080-SP	Spring, Press. Relief Valve		\$22.00
62157	Valve Lex Air 1" brass LG	7	\$563.75
62157-KIT	Repair Kit, Lex Air	5	\$180.50
62158-KIT	Repair Kit, Lex Air (321316)	5	\$115.75
62162	Valve Float 3/4" 90 degree	7	\$66.25
62163	Valve Float 1" 90 degree	7	\$108.00
62192-24	Valve Sol 3/8 NO L/P 041	6, 19-20, 33	\$122.75
62192-KIT	Rebuilt Kit Dema Valve 0412		\$14.37
62196-24	Valve Sol 1/2 NC HP 454P	5, 33	\$186.12
62208	Valve 3-way 3/4" npt 50/60Hz	20, 21	\$188.50



2020 PICTORIAL PARTS BOOK



Item Number	Item Description	Page Reference	Price (\$)
62303	Metering Tip Kit Ultra Lean		\$6.50
62304	Metering Tip Kit #8-32 thd	6, 19, 20, 33	\$11.25
62344	Injector .070 x 8deg fixed brs	5	\$25.19
62344-X	Injector .070 w/XFO Ring-ORANGE	6, 19-20, 33	\$47.25
62369	Injector .057 x 8 deg SS	5	\$43.22
62369-X	Injector .057 w/XFO Ring RED	6, 19-20, 33	\$47.25
62375	Injector .083 x 8 deg SS	5	\$43.22
62375-X	Injector .083 w/XFO-GRAY	6, 19-20, 33	\$47.25
62376	Injector .086 x 8 deg SS	5	\$43.22
62376-X	Injector .086 w/XFO-BLUE	6, 19-20, 33	\$47.25
62377	Injector .098 x 8 deg SS	5	\$43.22
62377-X	Injector .098 w/XFO-GREEN		\$47.25
62379	Injector .083 Dual Port SS	5	\$90.00
62379-X	Injector .083 Dual Port w/XFO-GRAY	6, 19-20	\$66.50
62380-X	INJECTOR, .125, W/XFO	30	\$50.00
62433	Injector .083 x 8 deg brass	5	\$27.00
62496	Valve Water Sol 1" NC SS 24vac	22	\$275.00
62966-8M	Nozzle,0508 1/8" I-Meg		\$5.75
62970-4M	Nozzle,1503 1/4" I-Meg		\$7.25
62971-4M	Nozzle 1504 1/4" I-Meg		\$7.25
62973-4M	Nozzle 1505 1/4" I-Meg		\$7.50
62977-4M	Nozzle 1508 1/4" I-Meg		\$7.25
62980-4M	Nozzle 2504 1/4" I-Meg		\$7.25
63005-4M	Nozzle 2503 1/4" I-Meg		\$7.25
63041-4M	Nozzle 4003 1/4" I-Meg		\$7.25
63045-4M	Nozzle 4004 1/4" I-Meg		\$7.25
63047-4M	Nozzle 4006 1/4" I-Meg		\$7.25
63060-4M	Nozzle 4020 1/4" I-Meg		\$7.00
63300-4M	Nozzle 6510 1/4" I-Meg		\$7.00
63525-4M	Nozzle 8003 1/4" I-Meg		\$7.25
63526-4M	Nozzle 8006 1/4" I-Meg		\$6.75
63527	Nozzle, Blastec 4.0 gpm	28	\$106.50
63528	Nozzle Adapter, Blastec 1/4"		\$7.25
63529-4M	Nozzle 8010 1/4" I-Meg		\$10.00
64991	Strainer, 2" Suction Line, Nylon	7, 22	\$23.50
65389	Swivel Straight 1" HP SS	2	\$190.00
65391-P	Swivel 90 degree 1" F x F	5, 14	\$155.50
66576-TT	Bulkhead Fitting, 3/4"	22	\$49.82
66577-TT	Bulkhead Fitting 1"	7	\$34.25
66578-TT	Bulkhead Fitting 1-1/4 pvc thd		\$50.18
66579-TT	Bulkhead Fitting 1-1/2 pvc thd		\$53.30
66580-TT	Bulkhead Fitting 2 pvc thd		\$72.75
68892	Side Arch Foam (Large)	4	\$235.00
68893	Top Arch Foam (Small)	4	\$200.00
68894	Power Tower Foam, Blue, Each	28	\$145.00
68895-A	Foam Insert Assembly, Side Arch	16	\$109.00
73296	Clamp 18mm Tube GR	3	\$1.50
73298	Clamp Pipe 21.3mm		\$1.75
73905	Clamp Tube 1" Diameter	4, 17	\$1.55
73916	Clamp Tube 1" Pipe Group 5S PR	5, 22, 23	\$5.15
77094	U-Bolt 3/8-16 x 2" Pipe SS	1	\$10.25



2020 PICTORIAL PARTS BOOK



Item Number	Item Description	Page Reference	Price (\$)
77096	U-Bolt, 3/8 x 3-1/2" SS		\$23.00
77097	U-Bolt, 3/8 x 6 x 4 x 4 SS		\$17.40
77098	U-Bolt, 3" x 5" Square	37	\$18.00
77099	U-Bolt, 5" x 3" Square		\$18.00
77891	Latch Flexible Draw		\$16.50
77893	Latch Snap Lock 2 pcs.		\$21.25
78495	Knob, 1/4-20 Female DK-184		\$3.75
82870	Decal: Wait/Go 12v LED	36	\$67.00
82871	Decal: WashStatus 12v LED	36	\$47.50
82872	Decal: In-Bay 3-panel 12v LED		\$85.00
82874	Decal: In-Bay 8-panel 12v LED	36	\$107.00
82874-C	Decal: In-Bay 8-panel - custom		\$200.00
82874-TF	Decal: In-Bay 8-panel w/TF	36	\$107.00
82881	Decal, Countdown Timer Outer Blue		\$47.95
83455	Decal: UCC High Velocity	8	\$91.50
83735-B	Decal, X-Hatch Bottom Razor Co		\$145.75
83735-C	Decal, X-Hatch Center Razor Co		\$103.75
83735-T	Decal, X-Hatch Top Razor Cover		\$145.75
83878	LED Board Countdown Timer 24vac	35	\$528.00
83880	LED Light, Green ARROW 24vac	36	\$97.25
83882	LED Light, Amber ARROW 24vac	36	\$97.25
83886	LED Light, Red STOP 24vac	36	\$97.25
83888	LED Light, Blue GLOBE 24vac	36	\$97.25
83890	LED Light Strip, RED 12vdc	36	\$80.50
83890-3	LED Strip, 3 Light RED 12vdc	36	\$5.50
83892	LED Light Strip, AMBER 12vdc	35	\$80.50
83892-3	LED Strip, 3 Light AMBER 12vdc	36	\$5.50
83894	LED Light Strip, GREEN 12vdc	35	\$80.50
83894-3	LED Strip, 3 Light GREEN 12vdc	36	\$5.50
83896	LED Light Strip, BLUE 12vdc	35	\$80.50
83896-3	LED Strip, 3 Light BLUE 12vdc	36	\$5.50
83899	LED Module, 2 Light BLUE 12vdc	36	\$3.50
83903	LED Light Strip, Green 14 light	35	\$77.00
83904	LED Light Strip, Red 14 Light	35	\$77.00
83925	LED Strip, RZR Cover	29	\$88.00
83925-27	LED STRIP,BLUE,27.75" LG, RZR	29	\$56.26
83925-28	LED STRIP,BLUE,28.00 28.LG,ARCH	16	\$84.75
83925-29	LED Strip, Blue 29.75" LG, Razor	29	\$61.00
83925-31	LED Strip, Blue 31.75 LG, Razor	29	\$57.75
83925-35	LED STRIP,BLUE, 35.4"LG,ARCH	16	\$68.00
83925-43	LED STRIP,BLUE,43.3LG,ARCH	16	\$75.00
83925-5	LED Strip, Blue 5m		\$175.60
84917	LED Face Kit	35	\$40.75
8902-2	Seal for Bearing 8902-I	11	\$17.50
8902-I	Bearing Insert 1IDx2ODx9/16	11	\$5.25
8906	Bearing Pillow Blk 1-3/16"	1	\$67.00
8907	Bearing Flange 4 Bolt 1" ID	12, 32	\$45.61
8950	Drive Gear, Trolley/Carriage	12, 13, 32	\$94.60
8952	Bushing, Trolley Drive Gear	12, 13, 32	\$33.30
8953	Bushing, Carriage Drive Gear	12	\$33.30
90888	Mesh Plastic	5, 23	\$1.50



2020 PICTORIAL PARTS BOOK



Item Number	Item Description	Page Reference	Price (\$)
90890	Mesh Plastic, Ultra Foam		\$4.75
90899	Spring, Comp. Spray Arch		\$8.14
90989	Cylinder Gas 90 lb (752916)		\$27.50
90991	Cylinder Gas 60lb (75908)		\$20.25
91039	Ball Stud 10mm 5/16 - 18 thd		\$0.80
9106	Bearing Flange 4 Bolt 1-3/16	1, 2	\$67.00
91899-REAR	Sonar, P&F Programmed Rear/Dryer		\$472.45
91899-SIDE	Sonar, P&F Programmed Side		\$472.45
91900-REAR	Sonar, P&F L2 Series Programmed	27	\$439.12
91900-SIDE	Sonar, P&F L2 Series Programmed	27	\$439.12
91901	Sonar Width Measure, Black	3	\$602.25
91909	Prox Switch 12mm Shielded	2, 14, 33	\$46.75
91910	Prox Switch 18mm Shielded	3, 13, 33	\$59.50
91914	Prox Switch 30mm f/Trolley	2, 14, 33	\$66.50
91915	Prox Switch 30mm f/Carriage	1, 12	\$69.00
91917	Sensor Prox T-Bar Breakaway	4, 28	\$44.00
91918	Actuator T-Bar Sensor	4, 28	\$6.73
91919	Prox Switch 12mm	33	\$40.25
91920	Prox Switch 18mm Short	33	\$62.25
91921	Prox Switch 18mm Long	32, 33	\$36.25
91922	Prox Switch 30mm Long	33	\$42.50
91923	Prox Switch 30mm Short	33	\$55.50
91985	Temperature Probe		\$255.00
91990	Photo Eye 30mm Retro/Cutler	3	\$354.08
91992	Sensor 24vdc Main Tank Fill	7, 19, 22	\$107.00
92009	Lanyard, 3/4" Washworld Blue		\$6.20
92010	Manual Remote Transmitter Unit	26	\$181.00
92011	Manual Remote Receiver Unit	26	\$572.00
92073	Photo Eye Trans. 14mm Carlo	4	\$109.25
92074	Photo Eye Receiver 14mm Carlo	4	\$99.25
92075	Transmitter Infrared 35m Cable		\$76.62
92075-15	Transmitter Infrared 15m Cable	4	\$51.70
92075-L	Transmitter Infrared 15m Telco	4, 27-28	\$46.25
92076	Receiver Infrared 35m Cable		\$98.25
92076-15	Receiver Infrared 15m Cable	4	\$78.38
92076-L	Receiver Infrared 15m Telco	4, 27-28	\$70.46
92077-L	Amp, 24vac Telco	4, 10, 27	\$122.00
92078	Amp, Self Diag. 24vac Pantron	4, 10	\$0.00
92079	Amp, Dual Channel - Pantron		\$213.15
92079-L	Amp, Dual Channel 24vac Telco	27-28	\$222.00
92084-24VAC	Photo Amp 24vac, 11pin Carlo	4, 10	\$197.25
92085	Horn, Panel Mount 855P	25	\$188.00
92086	Horn, Panel Mount 240v Int'l	25	\$187.50
92088	Speaker, Audible Alarm SP1114B		\$433.50
9209	Bearing Flange 2 Bolt 1-5/16		\$78.00
92595	Modem, USR 56K		\$219.50
92965	Tape Reflective 3" x 31"		\$28.78
93180001	GREASE,CNDCT,SILVER,.23OZ	15	\$90.00
95095	Foamer Head, Flex Pass	17	\$231.00
95098-A	Foamer Head, Anodized Rev.	17	\$106.70
95099	Foamer Head, Single Stream		\$77.00



2020 PICTORIAL PARTS BOOK



Item Number	Item Description	Page Reference	Price (\$)
95100-A	Foamer Head, Dual Stream Razor	4, 17	\$80.00
98550	Modem Adapter		\$24.75
98560	Cable, Modem	8, 9, 23	\$9.25
98561	Cable, AB PLC - PVP/Direct Con	8, 9, 23	\$151.50
9955-3BX	Belt 66" B Sect Banded 3V	33	\$109.45
9956-3BX	Belt 67" B Sect Banded 3V	7, 19, 21, 33	\$76.75
9957-3BX	Belt 68" B Sect Banded 3V	19	\$70.00
9969-K	Belt 15mm x 396" (1258t) OBD	18	\$235.30
9970-K	Belt 15mm x 276" (7.2m) Trolley	18	\$158.60
9971-K	Belt 15mm x 360" (1143t) Carriage	18	\$213.85
9973	Clamp Drive Belt Carr/Trolley	14	\$11.50
M100004	On-Board Dryer Roller Stop	18	\$12.41
M100007	Tee Pipe 1" SS w/hole	6	\$51.00
M110067	Tri-Foam Pod Adaptor Brkt HV	4	\$55.75
M228800	Foam Insert		\$3.75
M228810	Foam Insulating Plug		\$18.50
M228814	FOAM,INSULATION,2x2x8"LG		\$5.00
M228889-A	Plate, w/Heater HV		\$27.75
M228893-A	Plate, w/Heater U/C and TBar		\$35.00
M228899	Heater w/Bracket, Loading Eyes		\$37.00
M228900	Heater w/Bracket, Loading Eyes		\$37.00
M228905	Plate, Adapter PVP to HMI RZR		\$27.25
M288916	Lift Block Assy. w/Ring	3, 15	\$37.50
M307821-S	Bracket Mount Spot Free		\$42.00
M308908	Support Cable Carrier SS		\$46.20
M308931	Bracket Weep Valve		\$15.25
M308934-S	Bracket Trolley Sensor SS	3	\$65.50
M308937-S	Bracket, Prox. Double SS	2	\$34.00
M308938-S	Bracket, Prox. Single SS	2	\$32.45
M308939	Bracket, Festoon Carrier		\$75.00
M308940-S	Bracket, Prox. Double R3	14, 34	\$20.58
M308941-S	Bracket, Prox Single R3	14	\$16.59
M308942	Bracket, E-Chain to Carriage		\$133.77
M308982-S	Bracket Rail Support SS	11	\$89.00
M309030	Bracket Heater Tank Wall Mount		\$36.00
M309051	Bracket Bearing Block HV	2	\$71.40
M309055	Bracket Float Valve		\$31.00
M309077	Bracket Rail Wall Mount 3/4"	11	\$28.60
M309098	Bracket, Side Sonar T-Bar	3	\$352.00
M328896	Lift Plate Spray Arch	3, 15	\$65.85
M328908-S	Flag, Trolley Right Limit SS	2	\$21.00
M328911-S	Flag, Trolley Left Limit SS	2	\$10.00
M328912	Flag, Entrance/ Exit Limit		\$108.00
M328921-S	Plate 3x3x1/4 w 9/16 hole SS		\$7.66
M328922-S	Plate 4x4x1/4 for 1/2 Rod SS		\$11.35
M328923	Clamp Festoon Cable		\$6.60
M328924-S	Plate 4x4x1/4 for 3/4 Rod SS		\$11.26
M330885-S	Flag, Home HV SS rev2	3	\$28.00
M330887-S	Flag, Home Razor	18	\$38.02
M330888-S	Flag, Middle Razor		\$46.68
M330889-S	Flag, Rail SS	3, 18	\$15.25



2020 PICTORIAL PARTS BOOK



Item Number	Item Description	Page Reference	Price (\$)
M330892-S	Flag, Home Razor OBD		\$66.75
M330893-S	Flag, Rear Razor OBD		\$46.50
M330895-S	Flag, Home Razor rev2		\$24.00
M330897-S	Flag, Home Razor2/3 OBD		\$31.00
M330898-S	Flag, PWD Home Limit	32	\$11.00
M348894	Tank Poly w/2" hole 20x30.5	7, 22	\$365.00
M358890	Manifold Weldment Spray Arch	4	\$385.00
M358891-7	Manifold Top Spray Arch 7-hole	4	\$540.00
M358900	Manifold Weldment Virtual Attendant	4, 15	\$429.00
M358901	Manifold Top Arch Virtual Attendant	4, 15	\$539.00
M358905	Manifold Side Spray Arch	4, 15	\$555.00
M358906	Manifold, Side Spray Arch 14 Nozzle	15	\$656.90
M358920	Nipple Foamer Retaining	5, 22-23	\$22.00
M358927	Manifold, Underbody 5-hole	28	\$279.50
M358930	Manifold, Flexpass 1/2 x 72 SS	13	\$178.50
M358931	Manifold, Flexpass 1/2 x 44 SS		\$109.20
M358944	Manifold Hi-Foam SS 3-hole 3/8"	5, 20	\$92.40
M358948	Manifold Solution 9-port	6, 20	\$106.00
M358951	Manifold Weldment L.P. OH	5, 22-23	\$92.40
M358985	Manifold Tee Weldment 1" OHD	5, 23	\$101.20
M359015	Manifold, Foam Flow	29	\$175.00
M359020	MANIFOLD,HYPERFLEX,3/4 x 84"L	30	\$243.75
M379990	Shroud Joystick	10, 26	\$99.00
M388865	BRKT, CHANNEL, 1.0 X 6.0" X 11	27	\$7.51
M388870	HOUSING, PHOTO-EYE, 2x2 SQR	27	\$22.75
M388871-A	BRACKET,W/HTR-STRIP,7.5W,STR	18	\$31.85
M388875	TUBE,LOADING-EYES,2x2x24"LG	27	\$53.00
M388880	Plate, Sonar Deflector		\$58.75
M388884	Support Bracket 8 & 24 Housing		\$9.50
M388885	TUBE,SONAR,2x2x6.0"LG,16GA,SST	27	\$35.75
M388886	Housing, Sonar 8", White		\$49.00
M388888	Housing Loading Eyes 24" White		\$80.00
M388898	Pipe Weldment OverHead 90deg	5	\$182.60
M388909-18	Threaded Rod 1/2" x 18" SST		\$15.00
M388909-S	Threaded Rod 1/2" x 14" SST		\$10.94
M388910-S	Threaded Rod, 3/4" x 24" SST	11	\$57.47
M389010-S	Tie Rod 3/4 thd x 24-3/4 SST	11	\$53.68
M389011-S	Tie Rod 3/4 thd x 16-3/4 SST	11	\$52.93
M389012-S	Tie Rod 3/4 thd x 28-3/4 SST	11	\$78.69
M389013-S	Tie Rod 3/4 thd x 14-5/8 SST	11	\$46.90
M389015-S	Tie Rod, 3/4"thd x 10", SST		\$24.25
M389018-S	Tie Rod 3/4 thd x 35-5/8 SST	11	\$80.10
M389019	Tie Rod, OB Dryer Wall Mount		\$84.00
M389020	Angle, Tie Rod OBD Wall Mt		\$14.85
M498900	Target, SS	2	\$48.40
M498901	Bracket Mount Target	2	\$29.10
M498970	Bracket, Rear Belt Guard Support		\$185.00
M498972-S	Bracket Cable Carrier SS		\$47.75
M498975-S	Bracket Carrier Free Standing		\$23.75
M499018	Bracket Safety Catch Exit SST	1	\$40.75
M499019	Bracket Safety Catch Enter SST	1	\$81.50



2020 PICTORIAL PARTS BOOK



Item Number	Item Description	Page Reference	Price (\$)
M499055	Hinge Fiberglass	29	\$28.56
M500000	Bracket, Safety Catch - R3	12	\$49.06
M500002	Bracket, Overrail Safety Catch	12	\$21.34
M500889	Angle Clip 12GAx2.38x2.75 SS	4, 15	\$11.50
M508900	Bracket, Carriage Encoder Prox	12, 32	\$26.40
M508902	Pulse Target 2"x37" Carriage	2	\$90.20
M508904	Weldment, Trly Idler Tens Assy	12	\$275.00
M508907	Encoder Flag, Trolley 6 ct. SS	13, 32	\$11.00
M508908	Encoder Flag, Carriage 4 ct.	12, 32	\$122.98
M508915	Bracket, Tri-Foam R3	4	\$100.98
M508915-D	Bracket, Tri-Foam/Flex Pass DS	17	\$102.74
M508915-P	Bracket, Tri-Foam/Flex Pass PS	17	\$102.74
M508958	Bracket, E-Chain Guide RZR RH	14	\$11.25
M508959	Bracket, E-Chain Guide RZR LH	14	\$11.25
M518897-S	Plate Bearing Retaining SS		\$28.60
M518914	Plate Festoon Cable Holder		\$11.42
M518952	Plate Cover 4 x 4-3/8 x 1/8	1	\$15.50
M518953	Plate Cover 4x4-3/8x1/8 w/hole	1	\$15.84
M518970	Plate, 1/4x 3x4-1/2, 4-hole	5	\$19.45
M519027	Hinge Retaining Bar 1/4x1x6.75	29	\$11.00
M519369	Bracket, Rear Sonar Mount L2	27	\$15.20
M519373-A	Bracket, Spkr Aud. Alarm Rev2	27	\$12.00
M519379	Bracket Mount Measure Eye SS	3	\$20.50
M519604	Bracket L-Shape (Overhead)	5, 23	\$35.20
M519700	Bracket, Foam Flow Manifold	29	\$16.25
M519800	Bracket, Changeover Valve		\$22.00
M528918-S	Angle Wall Mount SS 14' to 16'	11	\$42.24
M528919-S	Angle,3x4x.25x2,SST,w/holes	11	\$20.59
M528931-S	Angle Wall Mount 16'-9" to 18'		\$80.26
M538919	Tank Cover 20-1/4x30-3/4 Black		\$59.64
M538920	Belt Guard 16" x 3.5" x 4.5"	7, 19, 21	\$82.00
M538921	Belt Guard Back Flat Plate	7, 19, 21	\$37.00
M538923	Guide, Trolley E-Chain RZR/Revv	14	\$21.00
M538925	Foam Shield, SST Razor	29	\$120.00
M542000-B	Cover, RZR Top Arch, PLSTC BLU	16	\$49.00
M542001-B	COVER,TOP ARCH,LED,PLSTC,BLU	16	\$55.00
M542005-B	Cover, RZR Mid SIDE Arch, PLST	16	\$56.00
M542006-B	COVER,MID ARCH,LED,PLSTC,BLU	16	\$65.00
M542010-B	Cover, RZR LOWER Side Arch, PLST	16	\$50.25
M542011-B	COVER,LOWER ARCH,LED,PLSTC,BLU	16	\$56.00
M542050-27	CHANNEL,LED,27.625"LG,RIGID-PVC	16	\$9.50
M542050-35	CHANNEL,LED,34.75"LG,RIGID-PVC	16	\$15.50
M542050-43	CHANNEL,LED,43.375"LG,RIGID-PVC	16	\$16.25
M548896	Pipe Bent Overhead f/ Bushing	5	\$140.00
M548897	Pipe Bent Overhead Turned	5	\$152.38
M548931	Manifold, 1 x 5, 2-hole		\$22.50
M548932	Manifold, 1 x 6, 3-hole SS	8	\$144.50
M548933	Manifold, 1 x 6, 1-hole SS	6, 20	\$31.50
M548937	Manifold, 1 x 6, 2-hole		\$47.50
M548950	Manifold pvc 9-port TF weep		\$93.00
M548951	Manifold pvc 4-port 3X Weep		\$112.86



2020 PICTORIAL PARTS BOOK



Item Number	Item Description	Page Reference	Price (\$)
M548953	Manifold, 6-port 3/8"		\$33.00
M548954	Manifold, 7-port, Power Tower	28	\$201.50
M578901-S	Sleeve Mount Wall 16'1" to 18'		\$25.96
M578909	Grease Line Side Flange Bearing SST		\$12.00
M578910	Grease Line Pillow Block SST	1	\$17.05
M578911	Grease Line 2 Black Trolley Roller SST	3	\$13.75
M578912	Grease Line 1 White Trol Roller SST	3	\$16.00
M578914	Grease Line Rear Black Roller SST	1	\$17.55
M578915	Grease Line Rear White Roller SST	1	\$17.90
M578916	Grease Line Front White Roller SST	1	\$18.05
M578917	Grease Line 3 SST	3	\$20.05
M578918	Grease Line Front Black Roller SST	1	\$19.65
M578919	Grease Line 4 SST	3	\$24.25
M578930	Grease Line Carrg Drv Shaft	12	\$16.75
M578931	Grease Line Carrg DS Exit - R3	12	\$20.25
M578932	Grease Line Carrg DS Ent - R3	13	\$18.00
M578933	Grease Line Carrg PS Exit - R3	12	\$21.25
M578934	Grease Line Carrg PS Ent - R3	12	\$17.25
M578935	Grease Line Carrg DS Exit Idler	12	\$18.00
M578936	Grease Line Carrg DS Ent Idler	13	\$17.25
M578937	Grease Line Carrg PS Exit Idler	12	\$18.25
M578938	Grease Line Carrg PS Ent Idler	12	\$16.50
M578940	Grease Line Trolley Idler Bear	12	\$13.75
M578941	Grease Line Trolley PS Exit Top	14	\$17.25
M578942	Grease Line Trolley DS Exit Top	14	\$24.75
M578943	Grease Line Trolley PS Exit Bot	14	\$11.25
M578944	Grease Line Trolley DS Exit Bot	14	\$21.25
M578945	Grease Line Trolley DS Ent Top	14	\$23.50
M578946	Grease Line Trolley PS Ent Top	14	\$16.85
M578947	Grease Line Trolley DS Ent Bot	14	\$20.75
M578948	Grease Line Trolley PS Ent Bot	14	\$11.25
M598870	Shaft, Hollow 1-3/16 x 19-1/2		\$401.75
M598888	Shaft, Carriage 1 x 6.5	12, 32	\$73.48
M598889	Shaft, Carriage Drive Idle 1"		\$75.24
M598890	Hollow shaft HV Arch	2	\$255.20
M598891	Axle, Carriage P/S	1	\$261.80
M598892	Axle, Carriage D/S	1	\$247.00
M598893	Shaft, Trolley Roller		\$135.00
M598895	Axle, Trolley Shaft	2	\$197.40
M598896	Shaft, 1-3/16" x 120" SS	1	\$490.00
M598897	Shaft, Hollow Razor 3	14	\$279.40
M598898	Shaft, Carr. Drive 1" x 12" RZR	12	\$92.50
M598899	Shaft, Carr. Drive 126" - R3	12, 32	\$503.80
M598902	Shaft, Trolley Gearbox R3	13, 32	\$145.25
M598903	Shaft, Trolley Roller R3	13, 33	\$121.00
M598905	Shaft, Carriage Roller	1, 11	\$129.80
M598906	Shaft, Carriage Roller R3	12, 32	\$116.60
M598910	Shaft, Eccentric, Trolley Roller	13, 33	\$134.20
M598911	Shaft, Idler Roller, Carriage	12, 32	\$90.50
M618889	Roller White UHMW	1, 12-13, 32-33	\$36.00
M618939	Roller Black UHMW	1, 12-13, 32-33	\$34.00



2020 PICTORIAL PARTS BOOK



Item Number	Item Description	Page Reference	Price (\$)
M618947	Roller White, Docking Dryer	11	\$39.38
M618948	Roller Black, Docking Dryer	11	\$39.50
M618950	Roller, Tension, Trolley	13, 33	\$50.60
M618951	Idler Pulley, Carriage	12, 32	\$63.80
M638891	Cam Index, SST	2, 14, 33	\$201.60
M638899	Washer 1/8 x 1ID x 1-3/8OD	12-13, 32-33	\$4.56
M638900	Washer UHMW 1-3/16 ID x3.50 OD	2	\$20.79
M638902	Washer 1/4 x 5/16 ID x1-3/4 OD	1, 11-12, 32	\$8.30
M638903	Spacer f/PDQ DD w/WW Shaft	11	\$7.92
M658889	Bearing Block 1-3/16 UHMW		\$26.65
M658891	Block Clamp Spray Arch		\$145.50
M658899	Block Rail Flag	2, 5	\$10.70
M658900	Block Carriage Flag 1/4x 1x 4	2, 18	\$10.50
M658901	Spacer, Arch 1/4" thick UHMW	4, 15	\$5.28
M658902	Spacer, Arch 1/8" thick UHMW	4, 15	\$5.06
M658903	Washer UHMW 1.328"IDx2"OD	14	\$20.42
M668887	Y-Bar Mounting Bracket	28	\$301.50
M668889	T-Bar Mounting Bracket	4	\$211.20
M688888	Cap 1-1/2 x 3 Tube		\$8.40
M688889	Cap 1-1/2 x 2 Tube		\$2.74
M688890	Shear Bolt, 4 1/2" SS	4, 15	\$6.60
M688897	Cap, 2" x 2" Black PLSTC	27	\$3.75
M688898	Cap, UHMW 2x3x.120 Tube	4	\$5.25
M688899	Cap, UHMW 3"x 3"	27	\$1.75
M688900	Cap, 2-1/2" - Sonar	3, 28	\$4.25
M688901	Cap, 2-1/2" w/1-1/8" hole	3	\$2.02
M688904	Sonar Insert		\$31.02
M688905	Well Sensor Main Tank 1-1/4"		\$37.40
M98901-CE	Junction Box J18 CE		\$110.00
PVP 400	Panel View Plus 400	8, 23	\$1,756.50
PVP 600	PV 600 24vdc Color Touch Screen	23	\$5,169.00
WW007	O-Ring Kit, Spray Arch	4, 15	\$6.70
WW010-21	Kit Nozzle, Arch 21 Nozzle Con	16	\$156.25
WW010-21-PT-12	Kit Nozzle, 21 Nozzle Arch + 12 PT		\$178.00
WW010-21-PT-6	Kit Nozzle, 21 Nozzle Arch + 6 PT		\$186.50
WW010-21-UB	Kit Nozzle, 21 Nozzle Config w/UB	16	\$238.00
WW010-6	Nozzle Kit, Laser w\Under		\$235.00
WW010-7	Nozzle Kit, Laser w\UB or HV	16	\$242.00
WW010-7-HV	Nozzle Kit, HV VS2 w/UB	4	\$242.00
WW010-7-HV-S	Nozzle Kit, HV VS2 w/o UB	4	\$192.00
WW010-RZR	Nozzle Kit HP/FP Manifolds		\$156.50
WW011-6	Nozzle Kit 6-hole Arch Only		\$153.00
WW011-7	Nozzle Kit 7-hole Arch Non VS2	4	\$160.25
WW011-7-VS2	Nozzle Kit 7-hole Arch w/VS2		\$160.25
WW012-RZR	Nozzle Kit HP/FP Manifolds R2	16	\$150.00
WW072	Festoon Cable Kit	3	\$648.50
WW076	Festoon Kit HV OBD		\$1,111.75
WW077	On-Board Dryer Festoon Kit		\$960.00
WW6017	Trolley E-Chain Guide Retrofit		\$40.00





Credit Cards Accepted:



All prices are F.O.B. DePere, WI and are subject to change without notice.

High Velocity® section includes Laserwash® 4000 spare parts
Laserwash is a trademark of PDQ Mfg.
Not affiliated with PDQ Mfg.

©Copyright 2020 Washworld, Inc.®