

Piezoelectric Accelerometers

Theory and Application



Manfred Weber

Metra Mess- und Frequenztechnik in Radebeul e.K.

Published by:

Manfred Weber

Metra Mess- und Frequenztechnik in Radebeul e.K.

Meißner Str. 58

D-01445 Radebeul / Germany

Phone +49-351-836 2191

Fax +49-351-836 2940

Email Info@MMF.de

Internet www.MMF.de

Authors: Johannes Wagner (1993)

Jan Burgemeister (1997-2021)

7th revised edition

© 2021 Metra Mess- und Frequenztechnik Radebeul

Contents

1. Introduction.....	1
1.1 Why Do We Need Accelerometers?.....	1
1.2 The Advantages of Piezoelectric Sensors.....	1
1.3 Instrumentation.....	2
2. Operation and Designs.....	3
2.1 Piezoelectric Principle.....	3
2.2 Accelerometer Designs.....	6
2.3 IEPE Compatible Sensor Electronics.....	8
3. Characteristics.....	13
3.1 Calibration Chart.....	13
3.2 Sensitivity.....	14
3.3 Frequency Response.....	15
3.4 Transverse Sensitivity.....	16
3.5 Maximum Acceleration.....	16
3.6 Linearity.....	17
3.7 Non-Vibration Characteristics.....	17
3.7.1 Temperature.....	17
3.7.1.1 Operating Temperature Range.....	17
3.7.1.2 Temperature Coefficients.....	18
3.7.1.3 Temperature Transients.....	19
3.7.2 Base Strain.....	19
3.7.3 Magnetic Fields.....	20
3.7.4 Acoustic Noise.....	20
3.7.5 Inner Capacitance.....	20
3.7.6 Intrinsic Noise and Resolution.....	20
4. Application Information.....	24
4.1 Instrumentation.....	24
4.1.1 Accelerometers With Charge Output.....	24
4.1.1.1 Charge Amplifiers.....	24
4.1.1.2 High Impedance Voltage Amplifiers.....	26

4.1.2 IEPE Accelerometers.....	27
4.2 Electronic Data Sheet to IEEE 1451.4 (TEDS).....	30
4.2.1 Introduction.....	30
4.2.2 Sensor Data in TEDS Memory.....	32
4.2.2.1 Basic TEDS.....	32
4.2.2.2 Template No. 25.....	32
4.3 Preparing the Measurement.....	34
4.3.1 Mounting Location.....	34
4.3.2 Choosing the Accelerometer.....	35
4.3.3 Mounting Methods.....	36
4.3.4 Cabling.....	43
4.3.5 Avoiding Ground Loops.....	45
4.4 Calibration.....	47
4.5 Evaluation of Measuring Errors.....	48
5. Standards.....	50

1. Introduction

1.1 Why Do We Need Accelerometers?

Vibration and shock are present in all areas of our daily lives. They may be generated and transmitted by motors, turbines, machine-tools, bridges, towers, and even by the human body.

While some vibrations are desirable, others may be disturbing or even destructive. Consequently, there is often a need to understand the causes of vibrations and to develop methods to measure and prevent them. The sensors we manufacture serve as a link between vibrating structures and electronic measurement equipment.

1.2 The Advantages of Piezoelectric Sensors

The accelerometers Metra has been manufacturing for over 60 years utilize the phenomenon of piezo electricity. “Piezo” is from the Greek word *πιέζειν* meaning to squeeze. When a piezoelectric material is stressed it produces electrical charge. Combined with a seismic mass it can generate an electric charge signal proportional to vibration acceleration.

The active element of Metra’s accelerometers consists of a carefully selected ceramic material with excellent piezoelectric properties called Lead-Zirconate Titanate (PZT). Specially formulated PZT provides stable performance and long-term stability. High stability similar to quartz accelerometers is achieved by means of an artificial aging process of the piezoceramic sensing element. The sensitivity of ceramics compared to quartz materials is about 100 times higher. Therefore, piezoceramic accelerometers are the better choice at low frequencies and low acceleration.

Piezoelectric accelerometers are widely accepted as the best choice for measuring absolute vibration. Compared to the other types of sensors, piezoelectric accelerometers have important advantages:

- Extremely wide dynamic range, almost free of noise, suitable for shock measurement as well as for almost imperceptible vibration
- Excellent linearity over their dynamic range
- Wide frequency range, very high frequencies can be measured
- Compact yet highly sensitive
- No moving parts, no wear

- Self-generating, no external power required
- Great variety of models available for nearly any purpose
- Integration of the output signal provides velocity and displacement

The following table shows advantages and disadvantages of other common types of vibration sensors compared to piezoelectric accelerometers:

Sensor Type	Advantage	Disadvantage
Piezoresistive	Measures static acceleration	Limited resolution because of resistive noise Only for low and medium frequencies Supply voltage required
Electrodynamic (Geophone)	Cheap manufacturing	Only for low frequencies
Capacitive	Measures static acceleration Cheap manufacturing with semiconductor technology	Low resolution Fragile

1.3 Instrumentation

The piezoelectric principle requires no external energy.

Only alternating acceleration can be measured. The piezoelectric type of accelerometer is not capable of a true DC response, e.g. gravitation acceleration.

The high impedance sensor output needs to be converted into a low impedance signal first. In the case of IEPE compatible transducers this is the task of the built-in electronics. The electronic circuit is powered from the connected instrument. This can be a simple supply unit, for instance Metra's M29, or signal conditioners like M33, M72 and M208. For sensors with charge output, a charge amplifier is needed, for instance Metra's M72 or IEPE100.

For processing the sensor signal, a variety of methods can be used, such as:

- Time domain calculations, like RMS and peak value, single or double integration, high pass and low pass filtering
- Frequency domain calculations, such as FFT or cross-correlation

However, the capability of such instruments would be wasted without accurate sensor signals. In many cases the accelerometer is the most critical link in the measurement chain. To obtain precise vibration signals some basic knowledge about piezoelectric accelerometers is crucial.

2. Operation and Designs

2.1 Piezoelectric Principle

The active element of an accelerometer is a piezoelectric material. Figure 1 illustrates the piezoelectric effect with the help of a compression disk. A compression disk looks like a capacitor with the piezoceramic material sandwiched between two electrodes. A force applied perpendicular to the disk causes a charge production and a voltage at the electrodes.

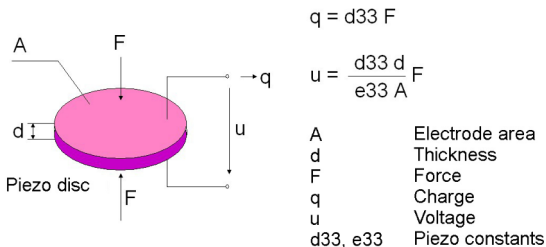

Figure 1: Piezoelectric effect, basic calculations

The sensing element of a piezoelectric accelerometer consists of two basic components:

- Piezoceramic material
- Seismic mass

One side of the piezoelectric material is connected to a rigid post at the sensor base. A so-called seismic mass is attached to the other side. When the ac-

celerometer is subjected to vibration, an inertial force is generated which acts on the piezoelectric element (compare Figure 2). According to Newton's Law this force is equal to the product of the acceleration and the seismic mass. By the piezoelectric effect a charge output proportional to the applied force is generated. Since the seismic mass is constant the charge output signal is proportional to the acceleration of the mass.

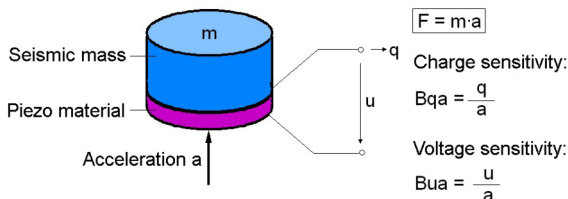

Figure 2: Principle of a piezoelectric accelerometer

Over a wide frequency range both sensor base and seismic mass are exposed to the same acceleration magnitude. Hence, the sensor measures the acceleration of the test object.

The piezoelectric element is connected to the sensor socket via a pair of electrodes. Some accelerometers feature an integrated electronic circuit which converts the high impedance charge output into a low impedance voltage signal (see section 2.3).

Within the usable operating frequency range the sensitivity is independent of frequency, apart from certain limitations mentioned later (see section 3.2).

A piezoelectric accelerometer can be regarded as a mechanical low-pass with resonance peak. The seismic mass and the piezo material (plus other "flexible" components) form a spring mass system. It shows the typical resonance behavior and defines the upper frequency limit of an accelerometer. In order to achieve a wider operating frequency range the resonance frequency must be increased. This is usually done by reducing the seismic mass. However, the lower the seismic mass, the lower the sensitivity. Therefore, an accelerometer with high resonance frequency, for example a shock accelerometer, will be less sensitive whereas a seismic accelerometer with high sensitivity has a low resonance frequency.

Figure 3 shows a typical frequency response curve of an accelerometer when it is excited by a constant acceleration.

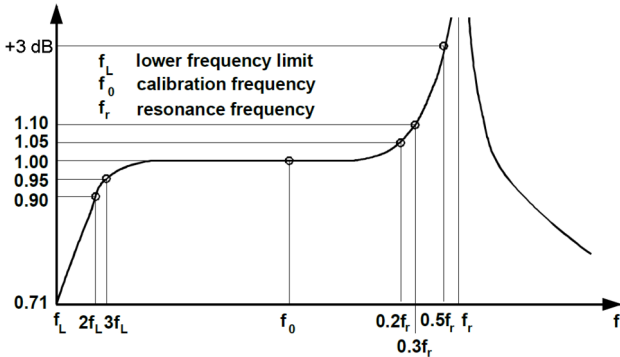

Figure 3: Frequency response curve

Some practical frequency ranges can be derived from this curve:

- At approximately 1/5 the resonance frequency the response of the sensor is 1.05. This means that the measured error compared to the reference frequency f_0 is 5 %.
- At approximately 1/3 the resonance frequency the error is 10 %. The “linear” frequency range is often considered to end at 1/3 the resonance frequency.
- The 3 dB limit is obtained at approximately half the resonance frequency.

These are typical characteristics which may vary in practice.

For the measurement of single shock pulses there is a rule of thumb that the resonant frequency of the accelerometer shall be at least 10 times the inverse pulse duration.

The lower frequency limit mainly depends on the chosen signal conditioning. Often it can be adjusted. With voltage amplifiers the low frequency limit is a function of the RC time constant formed by accelerometer, cable, and amplifier input capacitance together with the amplifier input resistance (see section 4.3.4.)

2.2 Accelerometer Designs

Metra employs three mechanical construction designs:

- Shear system (“KS” types)
- Compression system (“KD” types)
- Bending or flexure system (“KB” types)

The reason for using different piezoelectric systems are their individual properties for various measuring purposes and their different sensitivity to environmental influences. The following table shows advantages and drawbacks of the three designs:

	Shear	Compression	Bending
Advantage	Low temperature transient sensitivity Low base strain sensitivity	High sensitivity-to-mass ratio Robustness Technological advantages	Best sensitivity-to-mass ratio
Drawback	Lower sensitivity-to-mass ratio	High temperature transient sensitivity High base strain sensitivity	Fragile Higher temperature transient sensitivity

Shear design is applied in the majority of modern accelerometers because of its superior performance. However, compression and bending type sensors are still used in many applications,.

The main components of the 3 accelerometer designs are shown in the following illustrations:

Shear Design:

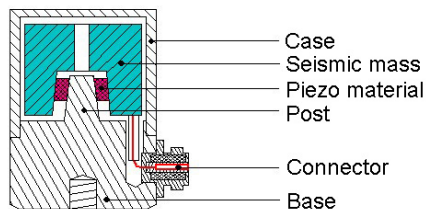

Compression Design:

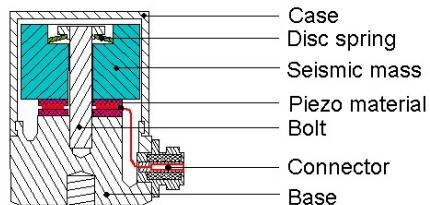
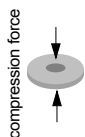

Bending Design:

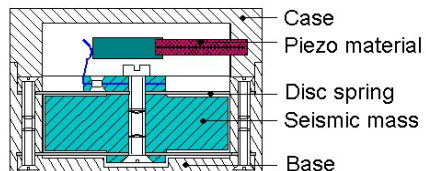
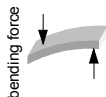

2.3 IEPE Compatible Sensor Electronics

Metra manufactures many accelerometers featuring a built-in preamplifier. It transforms the high impedance charge output of the piezo-ceramics into a low impedance voltage signal which can be transmitted over longer distances. Metra uses the well-established IEPE standard for electronic accelerometers ensuring compatibility with equipment of other manufacturers. The abbreviation IEPE means “Integrated Electronics Piezo Electric”. Other proprietary names for the same principle are ICP[®], CCLD, Isotron[®], Delta-tron[®], Piezotron[®] etc. The built-in circuit is powered by a constant current source (Figure 4). This constant current source may be part of an instrument or a separate unit. The vibration signal is transmitted back to the supply as a modulated bias voltage. Both supply current and voltage output are transmitted via the same coaxial cable which can be as long as several hundred meters. The capacitor C_c removes the sensor bias voltage from the instrument input providing a zero-based AC signal. Since the output impedance of the IEPE signal is typically 100 to 300 Ω , special low-noise sensor cable is not required. Standard low-cost coaxial cables are sufficient.

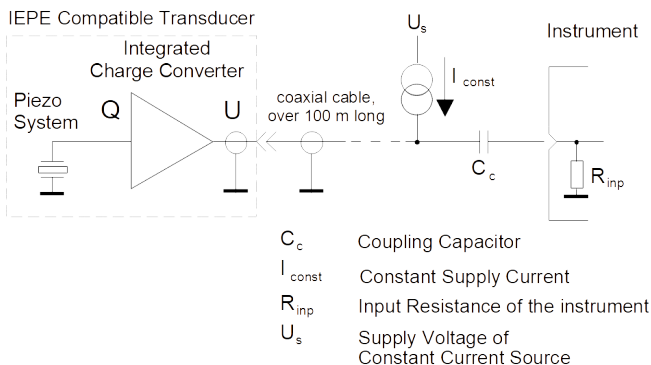

Figure 4: IEPE principle

The constant current may vary between 2 and 20 mA (not to be confused with the 4 to 20 mA standard). The lower the constant current the higher the output impedance and, therefore, the susceptibility to EMI. A constant current value of 4 mA is a good compromise in most cases.

The bias voltage, i.e. the DC output voltage of the sensor without excitation, is between 8 and 12 V. It varies slightly with supply current and temperature. The output signal of the sensor oscillates around this bias voltage. It can never become negative. The upper limit is set by the supply voltage (U_s) of the constant current source. This supply voltage should be between 24 and 30 V. The lower limit is the saturation voltage of the built-in amplifier. Metra guarantees an output span of $> \pm 5$ to 6 V for its sensors. 5 illustrates the dynamic range of an IEPE compatible sensor.

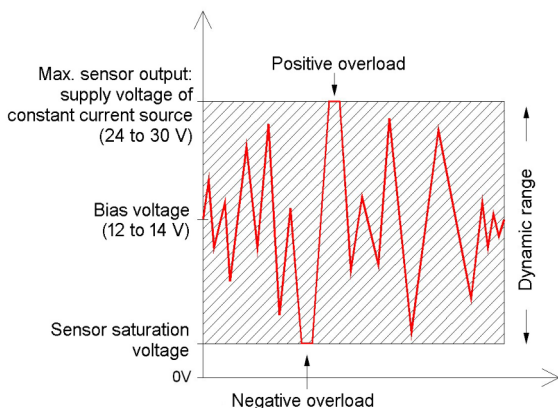

Figure 5: Dynamic range of IEPE compatible transducers

In addition to standard IEPE transducers Metra offers a low power version. These types are marked with “L“. They are particularly suited for battery operated applications like hand-held meters or telemetry systems. Their bias voltage is only 5 to 7 V at a constant supply current of 0.1 to 6 mA. Due to the lower bias voltage the maximum output is limited to ± 2 V.

The lower frequency limit of Metra's transducers with integrated electronics is 0.1 to 0.3 Hz for most shear and bender accelerometers and 3 Hz for compression sensors. The upper frequency limit mainly depends on the mechanical properties of the sensor. In case of longer cables, their capacitance should be considered. Typical coaxial cables supplied by Metra have a capacitance of approximately 100 pF/m.

The nomogram in Figure 6 shows the maximum output span of an IEPE compatible transducer over the frequency range as function of cable capacitance and supply current. With increasing cable capacitance the output span becomes lower. The reason for this is the reduced slew rate of the amplifier at higher load capacitance. With very long cables the full output span of ± 6 V can only be reached at frequencies up to a few hundred Hertz. Higher constant current may compensate cable influence.

For a cable capacitance up to 10 nF (100 m standard coaxial cable) and 4 mA supply current the reduction of the output span can be neglected.

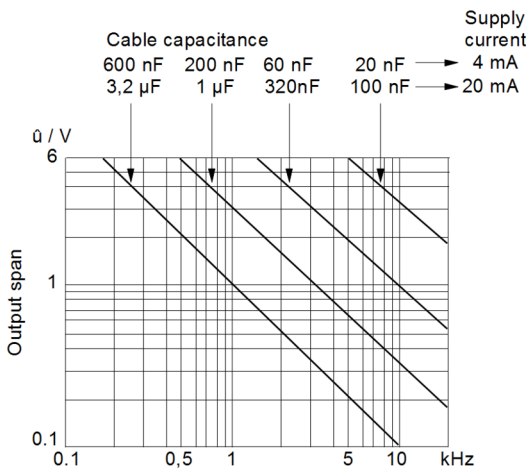

Figure 6: Output span of IEPE compatible accelerometers as function of cable capacitance and supply current

Figure 7 shows the frequency response of the sensor electronics as function of cable capacitance and supply current. At higher capacitance the upper frequency limit drops due to the low pass filter formed by the output resistance and the cable capacitance. At 4 mA the cable capacitance can be up to 50 nF (500 m standard coaxial cable) without relevant reduction of the upper frequency limit.

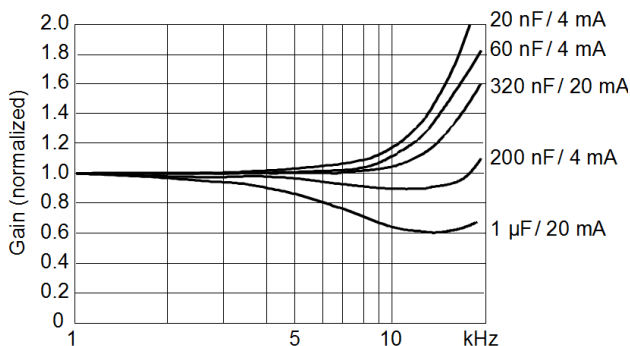

Figure 7: Frequency response of IEPE compatible accelerometers as function of cable capacitance and supply current

Today in most applications IEPE compatible accelerometers are preferred. However, charge mode accelerometers can be superior in some cases. The following table shows advantages and drawbacks of both sensor types.

	IEPE Compatible Sensors	Charge Mode Sensors
Advantage	<p>Fixed sensitivity regardless of cable length and cable quality</p> <p>Low-impedance output can be transmitted over long cables in harsh environments</p> <p>Inexpensive signal conditioners and cables</p> <p>Intrinsic self-test function</p> <p>Better withstands harsh conditions like dirt and humidity</p>	<p>No power supply required, ideal for battery powered equipment</p> <p>No noise, highest resolution</p> <p>Wide dynamic range</p> <p>Higher operating temperatures</p> <p>Smaller sensors possible</p>
Drawback	<p>Constant current excitation required (reduces battery operating hours)</p> <p>Inherent noise source</p> <p>Max. operating temperature limited to <120 °C</p>	<p>Limited cable length (< 10 m)</p> <p>Special low noise cable required</p> <p>Charge amplifier required</p>

Further details on IEPE compatible accelerometers can be found in section 4.1.2 on page 27.

3. Characteristics

3.1 Calibration Chart

Metra utilizes for factory calibration a modern PC based calibration system. Accredited calibrations to ISO 17025 and factory calibrations are offered.

Metra sensors, with few exceptions, are supplied with an individual calibration chart (Figure 8). It shows all individually measured data like sensitivity, transverse sensitivity, IEPE bias voltage and frequency response curve. Additionally, typical characteristics for the transducer are listed.

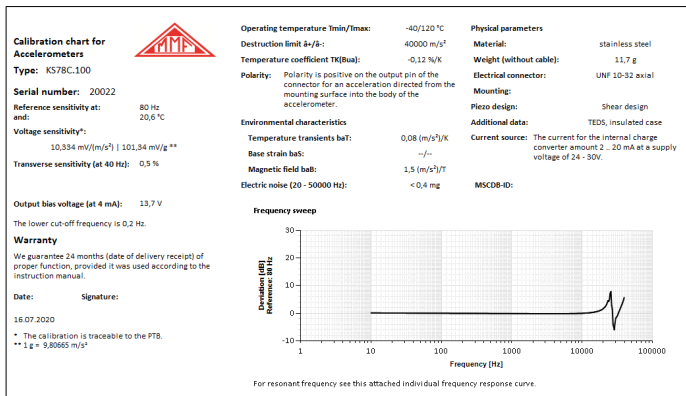

Figure 8: Individual calibration chart of Metra accelerometers

The following sections explain the parameters used in the individual calibration sheets.

3.2 Sensitivity

A piezoelectric accelerometer with charge output can be regarded as either a charge source or a voltage source with very high impedance. Consequently, charge sensitivity or voltage sensitivity are used to describe the relationship between acceleration and electrical output. In the individual characteristics sheet Metra states the sensitivity at 80 Hz (16 Hz for some high-sensitivity types) and room temperature in millivolts per m/s^2 for IEPE sensors or picocoulomb per m/s^2 for charge sensors. Sensitivities are also indicated per g with $1 \text{ g} = 9,80665 \text{ m/s}^2$.

For charge mode sensors additionally the inner capacitance and the insulation resistance of the output are measured.

The total accuracy of this calibration is 0.7 % at reference conditions.

The calibration can be performed with other conditions on demand.

The stated accuracy should not be confused with the tolerance of nominal sensitivity which is specified for some accelerometers. Model KS80D, for example, has $\pm 5 \%$ nominal sensitivity tolerance. The standard tolerance window for sensitivity, if not stated otherwise, is $\pm 20 \%$. Hence the exact sensitivity of production accelerometers may vary from the nominal sensitivity within the specified tolerance range.

Charge sensitivity decreases slightly with increasing frequency. It drops approximately 2 % per decade. For precise measurements at frequencies differing very much from 80 Hz a recalibration in the desired frequency range should be considered.

Before leaving the factory each accelerometer undergoes a thorough artificial aging process. Nevertheless, further natural aging can not be avoided completely. For a high degree of accuracy recalibration should be performed in certain intervals (see section 4.3.5).

3.3 Frequency Response

The measurement of frequency response requires mechanical excitation of the transducer. Metra uses a high-frequency calibration shaker which is driven by a sine wave generator. The acceleration is kept nearly constant over the entire frequency range by means of a feedback signal from a reference accelerometer. Most accelerometers are supplied with an individual frequency response curve. It shows the deviation of sensitivity in decibel referred to the reference frequency. For example the upper 3 dB limit can be derived from this curve. The 3 dB limit is often used in scientific specifications. It marks the frequency where the measuring error becomes 30 %. It is usually at about 50 % of the resonance frequency (compare Figure 3). The 1 dB limit marks an error of approximately 10 %. It can be found in the range of 1/3 the resonance frequency. The mounted resonance frequency, which is the largest mechanical resonance, can also be identified from this curve. Usually there are sub-resonances present at lower frequencies.

Metra performs frequency response measurements under optimum operating conditions with the best possible contact between accelerometer and vibration source. In practice, mounting conditions will be less than ideal in many cases and often a lower resonance frequency will be obtained.

The resonance frequency indicated in the calibration chart is for coupled condition. The free resonance of the same sensor would be higher.

The frequency response of IEPE compatible transducers can be altered by long cables (see section 2.3, page 8).

The lower frequency limit of IEPE accelerometers can be found in the calibration chart. For accelerometers with charge output no lower frequency limit is indicated since it is mainly determined by the external electronics.

3.4 Transverse Sensitivity

An accelerometer is designed to measure only in one direction which is its main sensitivity axis. However, practical accelerometers will have a certain sensitivity in other directions, too.

Transverse sensitivity is the ratio of the output due to acceleration applied perpendicular to the main sensitive axis divided by the basic sensitivity in the main sensitive axis. Transverse sensitivity is angle-dependent and has a figure-eight characteristic.

Transverse sensitivity is individually measured for some sensor types, for example triaxial accelerometers. It is determined at 40 Hz sine excitation rotating the sensor around its vertical axis. Transverse sensitivity follows a figure-eight curve. The maximum amplitude is used for transverse sensitivity calculation. Typical are <5 % for shear accelerometers and <10 % for compression and bender models. Maximum limits can be found in the data sheets.

3.5 Maximum Acceleration

Usually the following limits are specified:

- \hat{a}_+ Maximum acceleration for positive output direction, the test object moves towards the sensor base
- \hat{a}_- Maximum acceleration for negative output direction, the test object moves away from the sensor base
- \hat{a}_q Maximum acceleration for transverse direction

For charge mode accelerometers these limits are given by the mechanical design of the sensor. After a short overload, for example by dropping, the sensor will usually continue to work. However, a recalibration is strongly recommended.

To avoid wear continuous acceleration should not exceed 25 % of the limits. When highest accuracy is required, acceleration should not be higher than 10 % of the limits.

For IEPE accelerometers, the limits \hat{a}_+ and \hat{a}_- are usually determined by the output voltage span of the amplifier (see section 2.3).

Sensors with very high maximum acceleration are called shock accelerometers. They feature a particularly rugged design and a low sensitivity.

The data sheets additionally indicate a destruction limit at which the sensor may be damaged irreversibly, for example due to detachment of the sensing element or breaking piezo material.

3.6 Linearity

The mechanical sensing elements of piezoelectric accelerometers have very low linearity errors. Within the indicated measuring range the linearity error will be usually less than 1 %.

Another issue is the linearity of IEPE transducers. The sensor electronics will contribute additional errors, particularly at higher output voltages. Typically the linearity error will be less than 1 % at within 70 % of the maximum output voltage.

3.7 Non-Vibration Characteristics

3.7.1 Temperature

3.7.1.1 Operating Temperature Range

The maximum operating temperature of a charge transducer is limited by the piezoelectric material. Above a specified temperature, the so-called Curie point, the piezoelectric element will begin to depolarize causing a permanent loss in sensitivity. For the Lead Circonium Titanate piezo material applied by Metra the Curie point is at approx. 350 °C. Permanent changes already occur below the Curie temperature. The specified maximum operating temperature is the limit at which the permanent change of sensitivity exceeds 3 %.

Other components may also limit the operating temperature, for example, adhesives, resins or built-in electronics. Typical temperature ranges extend from -40 to 250 °C for charge mode sensors and -40 to 120 °C for IEPE sensors.

For applications above 120 °C Metra offers the remote charge converter IEPE100.

3.7.1.2 Temperature Coefficients

Apart from permanent changes, some characteristics vary over the operating temperature range. Temperature coefficients are specified in the data sheets for charge sensitivity ($TK(B_{qa})$) and inner capacitance ($TK(C_i)$). These temperature coefficients are valid with a 1.5 m sensor cable having 150 pF inner capacitance.

For sensors with built-in electronics only the temperature coefficient of voltage sensitivity $TK(B_{ua})$ is given.

9 shows an example how sensitivity changes within the temperature range. In some cases data sheets indicate temperature coefficients for several temperature intervals.

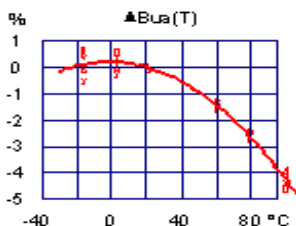

Figure 9: Example of a temperature coefficient of an IEPE accelerometer

There is a simple way to reduce the temperature coefficient of charge mode accelerometers. Since the temperature coefficients of B_{qa} , B_{ua} and C_i are different, the temperature behavior can be compensated by a serial capacitor at charge amplification or a parallel capacitor in case of high impedance voltage amplification. This capacitor is calculated to:

$$C = C_i \frac{TK(C_i) - TK(B_{qa})}{TK(B_{qa})}$$

It be a useful at very changeable temperatures. This method is also applied in Metra's IEPE accelerometers.

It should be noted that the total sensitivity will become lower by this measure.

3.7.1.3 Temperature Transients

In addition to the temperature characteristics mentioned above, accelerometers exhibit a slowly varying output when subjected to temperature transients, caused by so-called pyroelectric effect.

For shear-type sensors this influence is about 100 times lower than for compression type sensors. In shear type sensors the effects of thermal expansion are dominating.

The data sheets indicate temperature transient sensitivity b_{aT} . The sensor is attached to an aluminum cube weighing 200 g and exposed to a temperature step from 20 to 50 °C and its electrical output measured with a 1 Hz high pass.

Temperature transients produce frequencies below 10 Hz. Where low frequencies are measured this effect must be considered. To minimize problems, shear type accelerometers should be preferred for low frequency measurements. Bender systems are midway between shear and compression type in terms of sensitivity to temperature transients.

For very sensitive measurements even slight air draft may cause errors. In such cases it is recommended to thermally isolate the sensor, for example by using a polystyrene foam cover.

3.7.2 Base Strain

When an accelerometer is mounted on a structure which is subjected to strain variations, an unwanted output may be generated as a result of strain transmitted to the piezoelectric material. This effect can be described as base strain sensitivity b_{as} . The stated values are measured by means of a bending beam oscillating at 8 or 15 Hz.

Base strain errors mainly occur at frequencies below 500 Hz. Such effects are difficult to distinguish from vibration.

Shear type accelerometers have extremely low base strain sensitivities and should be preferred for strain-critical applications.

3.7.3 Magnetic Fields

Strong magnetic fields often occur around electric machines and frequency converters. Magnetic field sensitivity b_{ab} has been measured at $B=0.01$ T and 50 Hz for some accelerometers.

Generally, accelerometers with stainless steel cases provide better protection against magnetic fields than accelerometers with aluminum cases.

Magnetic field sensitivity is very low and can be ignored under most conditions.

Stray signal pickup can be avoided by proper cable shielding. This is of particular importance for sensors with charge output.

Adequate isolation must be provided against ground loops. They can occur when a measuring system is grounded at several points, particularly when the distance between these grounding points is long. Ground loops can be avoided using accelerometers with insulated bases (for instance Models KS74C, KS78B and KS80D) or insulating mounting studs. More information on ground loops can be found in section 4.3.5).

3.7.4 Acoustic Noise

If an accelerometer is exposed to a very high noise level, a deformation of the sensor case may occur which can be measured as an output. Acoustic noise sensitivity b_{ap} as stated for some models is measured at an SPL of 154 dB which is beyond the pain barrier of the human ear.

Acoustic noise sensitivity can be neglected in most cases. Usually the dominating influence is via sound pressure induced motion of the structure on which the sensor is mounted.

3.7.5 Inner Capacitance

Inner capacitance is stated in the individual calibration sheet only for accelerometers with charge output. It can be relevant if the transducer is used with a high impedance voltage amplifier (compare section 4.1.1.2 on page 26). The capacitance of the supplied sensor cable is also given in the calibration sheet.

3.7.6 Intrinsic Noise and Resolution

A piezoelectric sensing element can be regarded as purely capacitive source. The sensor itself is practically free of intrinsic noise. The only noise is contributed by the temperature motion of electrons in the built-in the IEPE com-

patible charge converter. Consequently, a noise specification is only useful for IEPE sensors.

Below about 100 Hz the intrinsic noise has the typical 1/f characteristics. Above 100 Hz the noise level is nearly independent of the frequency. 10 shows a typical noise spectrum of an IEPE accelerometer:

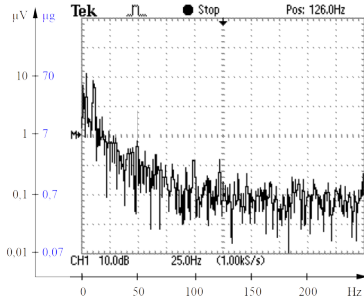

Figure 10: Typical noise spectrum of an IEPE accelerometer

It is useful to indicate the noise of an accelerometer as equivalent acceleration level. For this purpose, the noise voltage (u_n) is divided by transducer sensitivity (B_{ua}) yielding the equivalent noise acceleration (a_n):

$$a_n = \frac{u_n}{B_{ua}}$$

While u_n only depends on the electronic circuit which is similar for all sensor types, the sensitivity of the piezoelectric sensing element will directly influence the equivalent noise acceleration. It can be seen that a transducer with a very sensitive piezo system provides a better resolution.

The characteristics of most accelerometers show wide band noise (RMS) and noise density values for several frequency ranges.

Example of a noise statement (KS48C):

Wide band noise: $a_{n\text{ wb}} < 14 \mu\text{g}$ (0.5 to 1000 Hz; ± 3 dB)

Noise density at $f_1 = 0,1$ Hz: $a_{n1} = 3 \mu\text{g}/\sqrt{\text{Hz}}$

Noise density at $f_2 = 1$ Hz: $a_{n2} = 1 \mu\text{g}/\sqrt{\text{Hz}}$

Noise density at $f_3 = 10$ Hz: $a_{n3} = 0,3 \mu\text{g}/\sqrt{\text{Hz}}$

Noise density at $f_4 = 100$ Hz: $a_{n4} = 0,1 \mu\text{g}/\sqrt{\text{Hz}}$

Wide-band noise is the RMS of noise acceleration measured over the usable frequency range of the sensor.

Noise densities show the noise performance at specific frequencies which is of particular interest at low frequencies. To obtain the actual noise acceleration within a certain frequency range, the following formula can be used:

$$a_n(f_{\min} \dots f_{\max}) = \sum_{i=j}^k a_{ni} \sqrt{(f_{i+1} - f_i)}$$

with the noise densities a_{ni} which are included in the desired frequency range.

The indices j and k meet the conditions: $f_j \leq f_{\min}$
 $f_k < f_{\max}$

Example: Calculation of the intrinsic noise of Model KS48C with the noise data shown above for a frequency range from 0.1 Hz to 100 Hz:

$$\begin{aligned} a_n &= \sum_{i=1}^3 a_{ni} \sqrt{(f_{i+1} - f_i)} \\ a_n &= 3 \frac{\mu\text{g}}{\sqrt{\text{Hz}}} \sqrt{(1 \text{ Hz} - 0,1 \text{ Hz})} \\ &+ 1 \frac{\mu\text{g}}{\sqrt{\text{Hz}}} \sqrt{(10 \text{ Hz} - 1 \text{ Hz})} \\ &+ 0,3 \frac{\mu\text{g}}{\sqrt{\text{Hz}}} \sqrt{(100 \text{ Hz} - 10 \text{ Hz})} \\ a_n &= 8,7 \mu\text{g} \end{aligned}$$

For the evaluation of the intrinsic noise of an entire measuring chain the noise of all components including signal conditioners and other instruments must be considered.

The intrinsic noise of a sensor or a measuring chain determines the resolution. Signals below noise level cannot be detected.

The **lower detection** limit to DIN 45661 is the RMS value being twice as high as the RMS noise value.

Signal-to-noise ratio is a measure for the error caused by noise. It is defined as the ratio of the power of a signal to the power of background noise. It is often expressed in decibels:

$$S_n = 10 \log \frac{a^2}{a_n^2} = 20 \log \frac{a}{a_n}$$

4. Application Information

4.1 Instrumentation

4.1.1 Accelerometers With Charge Output

4.1.1.1 Charge Amplifiers

Accelerometers with charge output generate an output signal in the range of some picocoulomb with a very high impedance. To process this signal by standard AC measuring equipment, it needs to be transformed into a low impedance voltage signal.

Preferably, charge amplifiers are used for this purpose. Their input stage usually consists of a differential amplifier with capacitive feedback. The charge input signal at the input is compensated by the feedback charge. The voltage at the output is proportional to the input charge. Figure 11 shows a typical charge input stage.

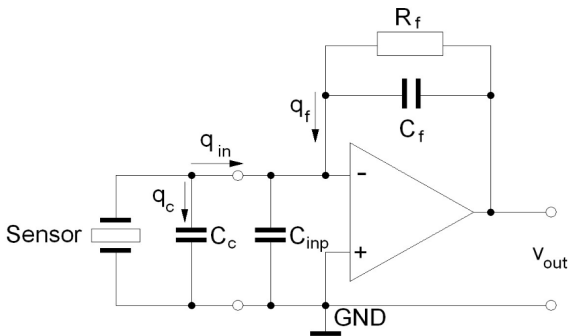

Figure 11: Charge amplifier

The input charge q_{in} flows into the summing point at the inverting input of the differential amplifier. It is distributed to the cable capacitance C_c , the amplifier input capacitance C_{inp} and the feedback capacitor C_f . The node equation of the input is therefore:

$$q_{in} = q_c + q_{inp} + q_f$$

Using the electrostatic equation:

$$q = u \cdot C$$

and substituting q_c , q_{inp} and q_f :

$$q_{in} = u_{inp} \cdot (C_c + C_{inp}) + u_f \cdot C_f$$

Since the voltage difference between the inverting and the non-inverting input of a differential amplifier becomes zero under normal operating conditions, we can assume that the input voltage of the charge amplifier u_{inp} will be equal to ground potential (GND). With $u_{inp} = 0$ the equation can be simplified:

$$q_{in} = u_f \cdot C_f$$

and solved for the output voltage u_{out} :

$$u_{out} = u_f = \frac{q_{in}}{C_f}$$

The result shows clearly that the output voltage of a charge amplifier depends only on the charge input and the feedback capacitance. Input and cable capacitance have no influence on the output signal. This is a significant advantage when measuring with cables of different lengths and types.

Referring to Figure 11, the feedback resistor R_f has the function to provide DC stability to the circuit and to define the lower frequency limit of the amplifier.

The circuit in Figure 11 represents only the input stage of a charge amplifier. Other parts like voltage amplifiers, filters and integrators are not shown.

Examples for charge amplifiers are the M72 series Signal Conditioners and the IEPE100 series Remote Charge Converters made by Metra.

4.1.1.2 High Impedance Voltage Amplifiers

Instead of charge amplifiers, high impedance voltage amplifiers can be used with charge mode transducers. In this case, however, the capacitance of sensor, cable and amplifier input must be considered (Figure 12).

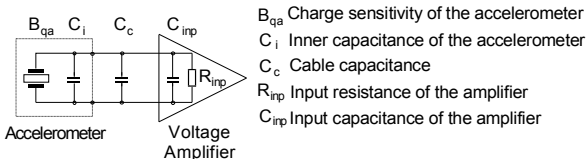

Figure 12: Charge accelerometer at high impedance voltage input

The voltage sensitivity of an accelerometer with known charge sensitivity B_{qa} and inner capacitance C_i is calculated to:

$$B_{ua} = \frac{B_{qa}}{C_i}$$

B_{qa} and C_i can be found in the sensor data sheet.

Taking into account the capacitance of the sensor cable C_c and the input capacitance C_{inp} of the voltage amplifier, the resulting voltage sensitivity B'_{ua} will become lower than B_{ua} :

$$B'_{ua} = B_{ua} \frac{C_i}{C_i + C_c + C_{inp}}$$

A typical 1.5 m low noise cable Model 009 has a capacitance of 135 pF.

The lower frequency limit f_l will also be influenced by C_c , C_{inp} and R_{inp} :

$$f_l = \frac{1}{2 \pi R_{inp} (C_i + C_c + C_{inp})}$$

The lower frequency limit increases with decreasing input resistance.

Example: A charge mode accelerometer Model KS93 with an inner capacitance of $C_i = 400$ pF is connected to a typical scope input with $R_{inp} = 10$ M Ω and $C_{inp} = 20$ pF. The sensor cable type 009-SUB-BNC-1,5 has a capacitance of 135 pF.

Result: The lower frequency limit will be at approximately 30 Hz.

4.1.2 IEPE Accelerometers

A special feature of the IEPE sensor circuit is that power supply and measuring signal are transmitted via the same cable. So, an IEPE transducer needs, like a transducer with charge output, only one single-ended shielded cable.

Figure 13 explains the IEPE principle.

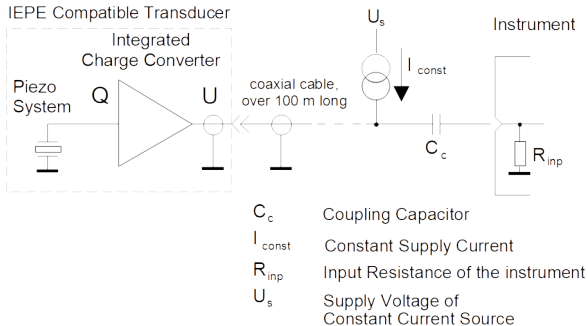

Figure 13: IEPE principle

The integrated sensor electronics is powered with constant current in the range between 2 and 20 mA. A typical value is 4 mA.

The constant current I_{const} is fed into the signal cable of the sensor. The supply current and the length of the cable may influence the upper frequency limit (compare section 2.3 on page 8).

The de-coupling capacitor C_c keeps DC components away from the signal conditioner input. The combination of C_c and R_{inp} acts as a high pass filter. Its time constant should be sufficiently high to let all relevant low frequency components of the sensor signal pass.

For battery powered applications Metra has developed a low-power version of the IEPE standard, which is applied in the accelerometers KS72L, KS94L, KS943L and in the vibration meters VM2x and VM31. Low Power IEPE accelerometers usually have a bias voltage of 4 to 6 V. So a supply voltage (U_s) of 9 to 12 V is sufficient. The constant current supply may be as low as 0.1 mA, depending on the transducer model. This can reduce the power consumption of the transducer by up to 99 %.

- A voltage source without constant current regulation must never be connected to an IEPE compatible transducer.
False polarization of the sensor cable may also destroy the built-in electronics.

In 14 can be seen that IEPE compatible transducers provide an intrinsic self-test feature.

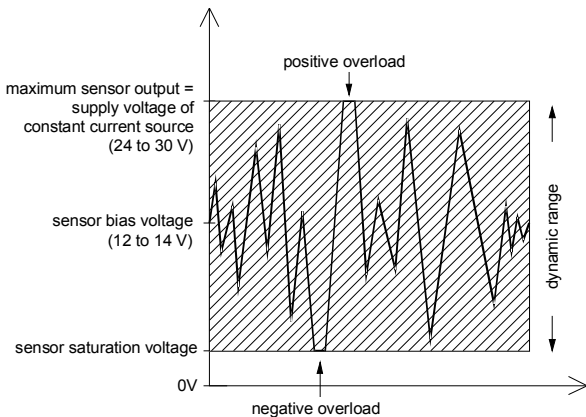

Figure 14: Dynamic range of IEPE compatible transducers

By means of the bias voltage at the input of the instrument the following operating conditions can be detected:

- $U_{\text{BIAS}} < \approx 1 \text{ V}$: short-circuit or negative overload
- $1 \text{ V} < U_{\text{BIAS}} < \approx 18 \text{ V}$: OK, output within the proper range
- $U_{\text{BIAS}} > \approx 18 \text{ V}$: positive overload or input open (cable broken or not connected)

IEPE transducers have an internal time constant which resembles a first order RC filter. When a step signal is applied to the input the output will be an exponentially decreasing voltage (see 15).

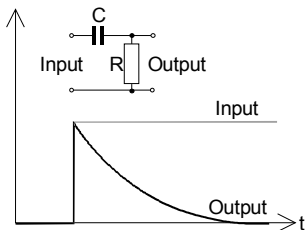

Figure 15: Step response of IEPE transducers

Step input signals occur when connecting the sensor to the IEPE current source or by shock acceleration. The decay time can reach up to one minute, depending on the lower frequency limit of the sensor. This should be considered, especially when low frequencies are to be measured.

A variety of instruments are equipped with a constant current sensor supply. Examples from Metra are the Signal Conditioners of M72 series, M208 and M33, the Vibration Monitors M12 and M14, the Vibration Meters VM2x VM31 or the Vibration Calibration System VC120. The constant current source may also be a separate unit, for example Model M29.

4.2 Electronic Data Sheet to IEEE 1451.4 (TEDS)

4.2.1 Introduction

The standard IEEE 1451 complies with the increasing importance of digital data acquisition systems. IEEE 1451 mainly defines the protocol and network structure for sensors with fully digital output. Part IEEE 1451.4, however, deals with “Mixed Mode Sensors”, which have a conventional IEPE compatible output and additionally include a digital memory for an “Electronic Data Sheet”. This data storage is named “TEDS” (Transducer Electronic Data Sheet). The non-volatile EEPROM memory of 64 + 256 bit (1024 bit in newer versions) contains relevant technical data which are of interest for the user. Due to the restrictions of memory size the data is packed in special coding formats.

The Transducer Electronic Data Sheet offers several advantages:

- When measuring at many measuring points it will be easier to identify the different sensors as belonging to a particular input. It is not necessary to mark and track the cable, which takes up a great deal of time.
- The measuring system reads the calibration data automatically. Before it was necessary to have a data base with the technical specification of the used transducers, like serial number, measured quantity, sensitivity etc.
- The sensor self-identification allows to change a transducer with a minimum of time and work (“Plug & Play”).
- The data sheet of a transducer is a document which often gets lost. The so called TEDS sensor contains all necessary technical specification. Therefore, you are able to execute the measurement, even if the data sheet is just not at hand.

The standard IEEE 1451.4 is based on the IEPE standard. Therefore, TEDS transducers can be used like common IEPE transducers. 16 shows the principle of TEDS.

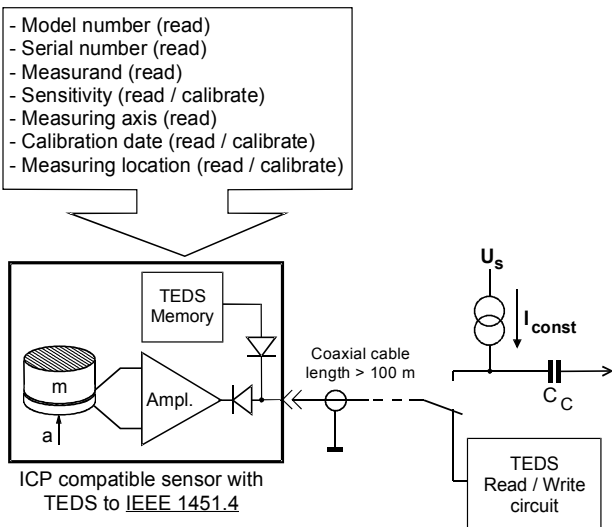

Figure 16: TEDS principle

When a constant current source is applied, the sensor will act like a normal IEPE compatible sensor. Programming and reading the built-in non-volatile 64 + 256 bit memory DS2430 or the 1024 bit DS2431 is also done via the sensor cable. The communication uses Maxim's 1-Wire® protocol. For data exchange TTL level with negative polarity is used. This makes it possible to separate analog and digital signals inside the sensor by two simple diodes.

Metra's 8-channel IEPE signal conditioners M72 and M208A provide full TEDS support with automatic transducer sensitivity normalization. TEDS circuitry is also included in the vibration meters VM31 and VM100.

4.2.2 Sensor Data in TEDS Memory

4.2.2.1 Basic TEDS

A 64 bit portion of the memory device DS2430A is called application register. It includes the so-called Basic TEDS with general information to identify the sensor:

- Model and version number: Metra stores in this location a coded model number. The actual model number, for example "KS78.100", can be decoded by means of a *.xdl file to IEEE 1451.4 standard, the so-called "Manufacturer Model Enumeration File" which can be found in the download section of our web pages.
- Serial number: This is the actual serial number of the sensor which can be found on its case.
- Manufacturer code: A manufacturer-specific number assigned by IEEE. Metra's manufacturer number is 61. A complete list of manufacturer codes can be found here:
<http://standards.ieee.org/develop/regauth/manid/public.html>

Basic TEDS can exclusively be modified and stored by the sensor manufacturer.

Newer sensors include the 1024 bit device DS2431. They do not have an application register. Basic TEDS data is arranged at the beginning of the 1024 bit memory.

4.2.2.2 Template No. 25

Calibration data is stored in a 256 byte section in the DS2430A or after basic TEDS in the DS2431. The arrangement of data is defined in TEDS templates. For accelerometers in most cases the standard template no. 25 will be applied. Some switch bits determine whether the memory includes a transfer function or not. Metra stores, if no other format is demanded, the version with transfer function including data like resonance or lower frequency limit. Template no. 25 includes the following data:

- Sensitivity in $V/m/s^2$: Sensitivity value at reference conditions according to the supplied calibration chart
- Calibration frequency of sensitivity in Hz
- Lower frequency limit in Hz: Typical value according to sensor data sheet
- Measuring direction: Relevant for triaxial accelerometers (0 = X; 1 = Y; 2 = Z; 3 = no data)
- Sensor weight in grams
- Polarity of output signal for positive acceleration: 0 = positive, 1 = negative
- Low pass frequency in Hz (if the sensor includes a low pass)
- Resonance frequency in Hz: Typical value according to sensor data sheet
- Amplitude slope in percent per decade
- Temperature coefficient in percent per Kelvin: Typical value according to sensor data sheet
- Calibration date (DD.MM.YY)
- Initials of calibrating person (3 capital letters)
- Calibration interval in days: Recommended time until next calibration

This data can be modified by the calibration lab of the manufacturer or later by other calibration labs.

In addition, the TEDS memory provides some bytes for application specific data which may be entered by the user:

- Measurement point ID (1 to 2046)
- User text: 13 characters

→ In the download section of its web site

http://www.new.mmf.de/software_download.htm

Metra offers a TEDS editor for reading and modifying the contents of the TEDS memory. The necessary hardware interface can be ordered from Metra.

4.3 Preparing the Measurement

4.3.1 Mounting Location

In order to achieve optimum measurement conditions, the following questions should be answered:

- Can you make at the selected location unadulterated measurements of the vibration and derive the needed information?
- Does the selected location provide a short and rigid path to the vibration source?
- Is it allowable (considering warranty restrictions) and possible in technical respects to prepare a flat, smooth, and clean surface with mounting thread for the accelerometer?
- Can the accelerometer be mounted without altering the vibration characteristics of the test object?
- Can there be an electrical potential between the measuring point and the instrument or along the earthing system?
- Which environmental influences (heat, humidity, oil, dust, EMI, bending etc.) may occur?

4.3.2 Choosing the Accelerometer

The following chart shows a summary of the most important criteria for selecting an accelerometer:

Criteria	Accelerometer Properties
Amplitude and frequency range	Choose appropriate sensitivity, max. acceleration and resonance frequency, shock accelerometers for extreme magnitudes, seismic accelerometers for lowest vibration
Weight of test object	Weight of accelerometer <1/10 the weight of test object, choose miniature accelerometers
Temperature transients, strain, magnetic fields, extreme acoustic noise	Assess influence, choose sensor according to characteristics, choose shear type accelerometers when temperature transients or base strain may occur, stainless steel versions for strong magnetic fields
Humidity, oil and dust	Use industrial accelerometers with IP67/68 protection grade
Measurement of vibration velocity and displacement	Single and double integration (M33, M72, M208, M12, M14)
Mounting	
Quick spot measurement below 1000 Hz	Use accelerometer probe ¹
Temporary measurement without alteration of test object	Use clamping magnet, wax or adhesive
Long-term measurement	Use mounting stud or screw
Grounding problems	Use insulated accelerometer or insulating flange
Long distance between sensor and instrument	Use accelerometer with built-in electronics (IEPE compatible)

¹ Metra offers the probe accelerometer Model KST94 with a movable tip which is mechanically isolated from the sensor case.

4.3.3 Mounting Methods

Choosing the optimum mounting arrangement will significantly improve the accuracy.

→ For best performance, particularly at high frequencies, the accelerometer base and the test object shall have clean, flat, smooth, unscratched, and burr-free surfaces.

A scratched accelerometer base can be applied to a lapping plate for restoration of flatness. If lapping is not possible, other machining processes such as grinding, spotfacing, milling, turning, etc., can produce acceptably flat mounting surfaces.

The transmission of higher frequencies can be improved by a thin layer of silicon grease at the coupling surface.

It is also important to provide a stiff mechanical connection between the sensor and the source of vibration. Sheet metal or plastic parts and other thin and flexible components are unsuited for accelerometer mounting.

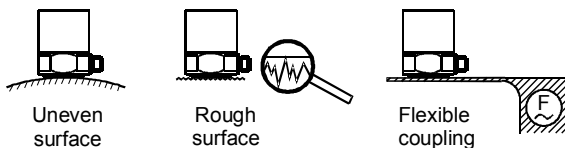

Figure 17: Typical reasons of coupling errors

Errors due to unwanted sensor vibrations can be reduced by symmetric mounting. The weight of the sensor including all mounting components should be low compared to the weight of the test object. As a rule the sensor should not weigh more than 10 % of the test object.

Misalignment of the sensor axis and the measuring directions should be kept as low as possible, particularly if transverse vibration of high magnitude occurs. When using screw mounting, make sure that the screw is not longer than the threaded hole. There must be no gap under the sensor.

The following mounting methods are used for accelerometers:

- Stud mounting with stud bolt, insulating flange or adhesive pads
- Magnetic base
- Adhesive by bees wax, cyanoacrylate, epoxy glue or thin double-sided adhesive tape
- Probe by hand pressure
- Automated coupling by a spring loaded tip (19)

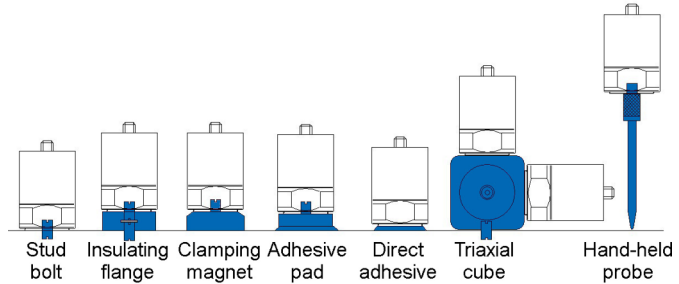

Figure 18: Mounting methods for accelerometers

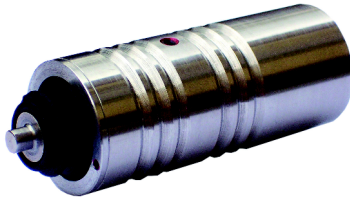

Figure 19: Probe accelerometer KST94 with movable tip

20 compares some typical mounting techniques for piezoelectric accelerometers with regard to different criteria.

The idealized frequency response curves were measured with an accelerometer weighing 25 grams. It is obvious that stud bolt mounting and cyanoacrylate provide the best coupling conditions.

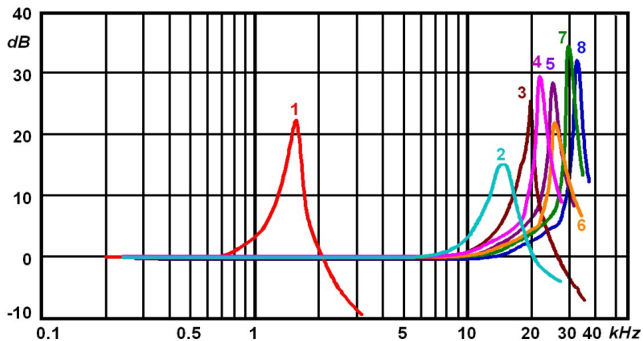

Figure 20: Resonance frequencies with different couplings

Key

- 1: Hand-held probe
- 2: Thin double-sided adhesive tape with flange
- 3: Bees wax with flange
- 4: Cyanoacrylate glue with flange
- 5: Bees wax, direct
- 6: Thin double-sided adhesive tape, direct
- 7: Cyanoacrylate glue, direct
- 8: Stud bolt

The higher the frequencies to be measured, the more important is the quality of coupling.

The following table compares common coupling methods in terms of different criteria.

	Resonant frequency	Temperature	Sensor weight and coupling stiffness	Resonance peak (Q)	Relevance of surface quality
Stud mounting	●	●	●	●	●
Cyanoacrylate glue	●	●	●	●	◐
Epoxy glue	●	◐	●	●	○
Bees wax	◐	○	◐	●	●
Double sided adhesive tape	○	◐	○	○	●
Magnetic base	◐	●	○	○	●
Probe	○	○	○	○	○
● high		◐ medium		○ low	

Metra accelerometers have the mounting thread sizes M3, M5 and M8. Some Models have integral M4, M6 or M10 mounting studs or screws.

For adhesive attachment it is crucial to choose adhesives with high stiffness in hardened condition. Well suited are Cyanoacrylate Epoxy or hot-melt adhesive. For the attachment on rough surfaces, for example cast iron, semi-fluid Cyanoacrylate types or Epoxy with fillers can be used.

Cyanoacrylate can be removed using acetone.



Not suitable are adhesives containing solvents which tend to stay soft inside.

Only a thin layer of adhesive shall be applied.

Thin double-sided tape can be useful for temporary measurements.

Many transducers are available with an accessory kit (ordering option “/01”) containing all suitable mounting parts.

The following list shows the mounting accessories offered by Metra:

<p>Mounting Studs</p> <p>021 (M3) 003 (M5) 043 (M8) 022 (M3 to M5) 044 (M5 to M8) 045 (M5 to 10-32) 046 (M5 to 1/4"-28)</p>	<p>→ For best performance, good for permanent mounting.</p> <p>Mounting thread required in the test object. A thin layer of silicon grease between mating surfaces aids in the fidelity of vibration transmission.</p> <p>Recommended torque: 1 Nm.</p> <p>Make sure that the mounting stud is not too long resulting in a gap between sensor and test object.</p> 
<p>Insulating Studs</p> <p>106 (2 x M3) 006 (2 x M5) 206 (2 x M8) 129 (M3, adhes.) 029 (M5, adhes.)</p>	<p>→ Avoids grounding problems.</p> <p>Reduced performance at high frequencies.</p> <p>Model 006 not to be used above 100 °C.</p> <p>Models 029 and 129 for adhesive attachment using cyanoacrylate (e.g. the gel-like Loctite 454), or epoxy glue.</p> 
<p>Non-Insulating Mounting Pads</p> <p>229 (M8)</p>	<p>→ Provides optimum coupling conditions on test objects without flat and smooth surfaces. For adhesive attachment using cyanoacrylate (e.g. the gel-like Loctite 454), epoxy glue or.</p> 

Mounting Cubes

130 (M3)
030 (M5)
230 (M8)
330 (M10)

➔ For triaxial arrangements of uniaxial accelerometers.

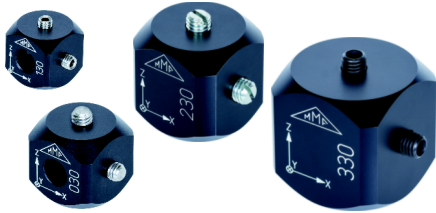

Handle Adapters

140 (M3)
141 (M5)

➔ For the attachment of uniaxial or triaxial accelerometers with M3 thread on curved surfaces, for instance at machine tool handles.





Han-held Adapters

142 (M3)
143 (M5)

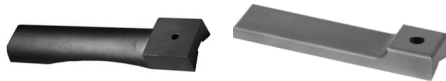
➔ For measurements with uniaxial or triaxial accelerometers with M3 thread on curved surfaces by hand pressure, for instance at machine tool handles.



<p>Rare-Earth Clamping Magnets</p> <p>108 (small, M3) 308 (large, M3) 408 (M4 hole) 008 (M5 stud) 208 (M8 stud) 608 (2 x M5)</p>	<p>→ Very strong magnets for rapid attachment with limited high frequency performance, max. 120 °C</p> <p>Ferromagnetic object with smooth and flat surface required (no rocking). If not available, weld or epoxy a steel disk to the test surface.</p> <p>Caution: Do not drop the magnet onto the test object to protect the sensor from shock acceleration. Gently slide the sensor with the magnet to the place. Do not use magnets for seismic accelerometers.</p>  <p>Model 608 for tubes etc.</p>
<p>Probe</p> <p>001 (M5)</p>	<p>→ For estimating and trending measurements above 5 Hz and below 1000 Hz.</p> <p>Attach the accelerometer via the M5 thread. Press onto the test object perpendicularly. Drilling a countersink will increase repeatability.</p> 
<p>Adhesive Wax</p> <p>002</p>	<p>→ For quick mounting of light sensors at room temperature and low acceleration.</p> <p>Soften the wax with the fingers. Apply thinly onto the test surface. Press sensor onto the wax.</p>

4.3.4 Cabling

Cables and connectors are often the weakest part of a measuring system. In our sensor data sheets and catalogs you find recommendations for suitable cables for each accelerometer.

Choosing the right sensor cable is of particular importance for accelerometers with charge output. When a coaxial cable is subjected to bending or tension, this may generate local changes in capacitance. They will cause a charge transport which may be visible in the measuring signal. This can be troublesome when measuring low vibration with charge transducers. Therefore Metra supplies all charge transducers with a special low noise cable. This cable type has a particular dielectric with noise reduction treatment. However, it is recommended to clamp the cable to the test object.

→ The connectors of low noise cables for charge transducers should be kept absolutely clean. Dirt or humidity inside the plug may reduce insulation resistance and will thereby increase the lower frequency limit of the sensor.

→ As a rule, the cable length of sensors with charge output should not exceed 10 m.

IEPE compatible transducers do not require special low noise cables. They can be connected with any standard coaxial cable.

Strong electromagnetic fields can induce error signals, particularly when charge transducers are used. Therefore it is recommended to route the sensor cable as far away as possible from electromagnetic sources, like generators, AC converters or motors. Do not route the cable along power lines and cross them right-angled.

Relative cable motion (cable whip) at the sensor body can cause erroneous sensor outputs. Miniature accelerometers and compression designs (i.e. Metra's "KD" models) are particularly susceptible to this. The problem can be avoided by proper cable tie-down. Metra offers the cable clamps 004 and 020 for this purpose. Adhesive cable clamps or "O"-Rings are also suited as shown in Figure 21.

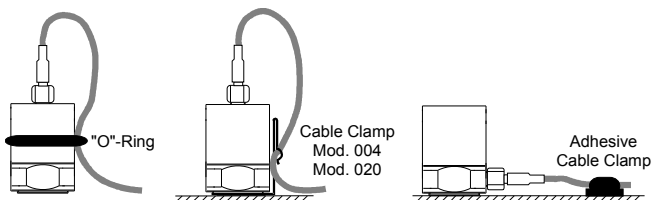

Figure 21: Methods of cable tie-down

When securing the cable, leave enough slack to allow free movement of the sensor.

Before starting the measurement, make sure that all connectors are carefully tightened. Loose connector nuts are a typical source of measuring errors. Do not use tools. Hand tightening is sufficient. A small amount of thread-locking compound can be applied on the male thread. Avoid contamination of the insulator.

Metra's standard accelerometer cables may have the following connectors:

- *Microdot*: coaxial connector with UNF 10-32 thread
- *Subminiature*: coaxial connector with M3 thread
- *TNC*: coaxial connector with UNF7/16-28 thread and IP44
- *BNC*: coaxial connector with bayonet closure
- *Binder 707*: circular 4 pin connector with M5 thread and IP67
- *Binder 711*: circular 4 pin connector with M8 thread
- *Binder 713*: circular 4 pin connector with M12 thread and IP67
- *Binder 718*: circular 4 pin connector with M8 thread and IP67
- 1/4-28 UNF: circular 4 pin connector

4.3.5 Avoiding Ground Loops

The most typical source of errors in connection with sensors and AC measuring instruments are ground loops. They are a result of unwanted potential differences in the electric circuit between the sensor and the instrument. Such problems usually occur along ground or earth cables. Possible reasons are:

- Long distance between sensor and instrument
- Voltage drop over insufficient cable cross-sections in the grounding network
- Measurement close to powerful electric engines which may cause considerable current transients in the grounding system.

These potential differences may cause balancing currents through the shield of the sensor cable. The result are voltage drops which will be added as an error component to the sensor signal at the input of the instrument. Typically these error signals have strong frequency components at 50 or 100 Hz or, in the presence of pulsed drives, also at higher frequencies.

For this reason the current path between the sensor mounting location and the instrument should be interrupted.

The following practical method usually helps to avoid ground loops:

The entire measuring chain is grounded at only one point, if grounding cannot be avoided completely. The transducer, a preamplifier (if required) and the cable shield are insulated from ground / earth potential. The only connection to ground / earth potential is made at the input of the instrument, if necessary.

A central grounding point is of particular importance in multichannel measuring systems.

We recommend the use of accelerometers with insulated base to avoid grounding problems, for example Models KS74C, KS78B, KS80D, KS81B and KS813B. The insulating flanges 006, 106, 206, 029, 129 and 329 are also suited.

Poor grounding circuit:

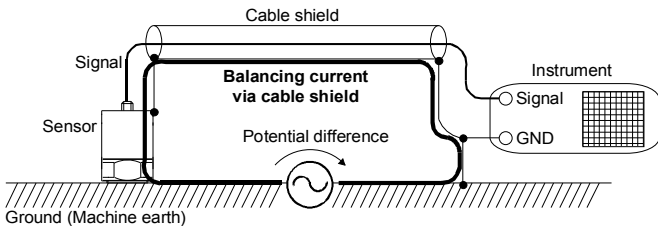

Figure 22: Sensor mounting without insulation causes ground loop

Better:

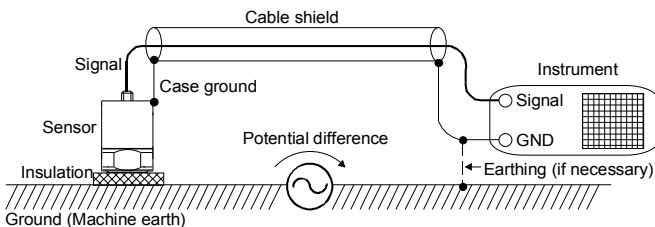

Figure 23: Insulated sensor mounting avoids ground loops

4.4 Calibration

Under normal conditions, piezoelectric sensors are extremely stable and their calibrated performance characteristics do not change over time. However, often sensors are exposed to harsh environmental conditions, like mechanical shock, temperature changes, humidity etc. Therefore it is recommended to establish a recalibration cycle. For applications where high accuracy is required, we recommend to recalibrate the accelerometer every time after use under severe conditions or at least every 2 years. In some less critical applications, for example in machine monitoring, recalibration may be unnecessary.

For factory recalibration service, please send the transducer to Metra. Metra also offers accredited calibration to ISO 17025.

Many companies choose to purchase own equipment to perform check accuracy themselves. This may save calibration cost, particularly if a larger number of transducers is in use. It may also be desirable to check the vibration sensor including all measuring instruments as a complete chain by means of a constant vibration signal. This can be performed using a Vibration Calibrator of Metra's VC2x series. The VC20 calibrator supplies a constant vibration of 10 m/s² acceleration, 10 mm/s velocity, and 10 µm displacement at 159.2 Hz controlled by an internal quartz generator. Model VC21 has 7 frequencies of 15.92, 40, 80, 159.2, 320, 640 and 1280 Hz with up to 5 magnitudes between 1 and 20 m/s².

The VC120 Vibration Calibrating System has an adjustable vibration frequency between 70 and 10,000 Hz at 1 m/s² vibration level. It can be controlled by a PC software. An LCD display shows the sensitivity of the sensor to be calibrated. The VC120 is also suitable for measuring frequency sweeps.

If no calibrator is at hand, a measuring chain can be calibrated electrically either by

- Adjusting the amplifier gain to the accelerometer sensitivity stated in the data sheet.
- Typing in the stated sensitivity when using a PC based data acquisition system.
- Replacing the accelerometer by a generator signal and measuring the equivalent magnitude.

Please understand the limitations of transducer calibration. Do not expect the uncertainty of calibration to be better than $\pm 1\%$.

4.5 Evaluation of Measuring Errors

For the evaluation of measuring results it is very important to assess the measuring errors. The following three groups of errors occur with piezoelectric accelerometers:

- **Sensitivity Errors:**
calibration errors, linearity errors, frequency and phase response errors, aging errors, temperature coefficients
- **Coupling Errors:**
influence of transducer weight, quality of the coupling surfaces, transverse sensitivity
- **Noise and Environmental Influences:**
noise, base strain, magnetic fields, temperature transients, intensive sound pressure, cable motion, electromagnetic interference in cables, triboelectric effect in cables

Systematical errors can be corrected arithmetically if their process of formation is known. The effect of these errors has been diminished and well described by the manufacturer.

Most of the systematical errors can be neglected if the measuring results are compared with another measurement under similar environmental conditions. This is of particular importance for unknown and undefined systematical errors.

Most errors, however, will occur accidentally in an unpredictable manner. They cannot be compensated by a simple mathematical model since their amount and their process of formation is unknown.

For practical measurements, systematical errors and accidental errors are combined in one quantity called measuring uncertainty.

The following example illustrates the contribution of several error components and their typical amounts:

- Accelerometer:

Basic error	1 %
Frequency error (band limits at 5 % deviation)	5 %
Linearity error	2 %
External influences	5 %

- Instrument with RMS calculation:

Basic error	1 %
Frequency error (band limits at 5 % deviation)	5 %
Linearity error	1 %
Waveform error	1 %

The addition of the squared error components yields for this example an uncertainty of $u = 9 \%$.

Please note that an uncertainty below 10 % will only be reached if all relevant errors are considered and if the used measuring equipment is of good quality.

5. Standards

Selection of standards concerning piezoelectric accelerometers:

- **ISO 2041:** Vibration and shock – Vocabulary
- **ISO2954:** Mechanical vibration of rotating and reciprocating machinery - Requirements for instruments for measuring vibration severity
- **ISO 5347:** Methods of the calibration of vibration and shock pick-ups
- **ISO 5348:** Mechanical vibration and shock - Mechanical mounting of accelerometers
- **ISO 8041:** Human response to vibration - Measuring instrumentation
- **ISO 8042:** Shock and vibration measurements - Characteristics to be specified for seismic pick-ups
- **ISO 10816:** Mechanical vibration - Evaluation of machine vibration by measurements on non-rotating parts
- **ISO 15242:** Rolling bearings - Measuring methods for vibration
- **ISO 16063:** Methods for the calibration of vibration and shock transducers
- **DIN 4150:** Vibration in buildings
- **DIN 5426:** Rolling bearings - Rolling bearing vibration and noise
- **DIN 45661:** Vibration measuring instrumentation - Vocabulary
- **DIN 45662:** Vibration measuring instrumentation - Fundamental requirements and verification
- **DIN 45669:** Measurement of vibration immission - Part 1: Vibration meters - Requirements and tests

NEW:

KSI84: Vibration Sensors with 4-20-mA Loop Output

- More than 250 types available
- Velocity or Acceleration
- RMS and Peak outputs
- Many High Pass and Low Pass options



NEW:

Vibration Analyzer VM100

- 9 IEPE inputs
- Touchscreen operation
- Frequency analysis
- Overall value measurement with plotter
- Balancing
- Bearing diagnosis
- Machine monitoring
- Human vibration



