

October 2020

PIPE AND FITTING PRICE LIST

EXCLUDING VAT

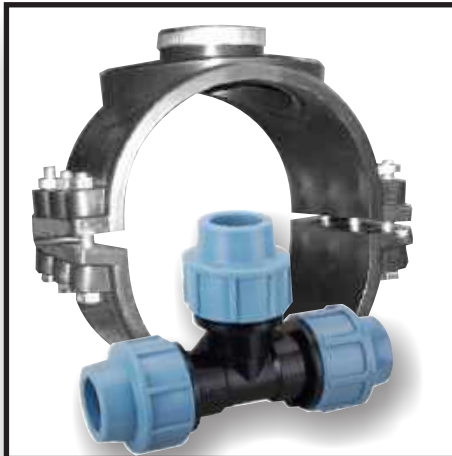

Natal Plastic Supplies

Durban.
Tel: 031 205 9215
logan@effast.co.za

PE PLASTICS

Port Elizabeth
Tel: 041 451 2360
Kobus@effast.co.za

SANSPAR

Johannesburg
Tel 011 397 6889
brendan@sanspar.co.za



EFFAST

Cape Town
Tel: 021 946 1980
sales@effast.co.za

website: www.effast.co.za

B. GENERAL PROPERTIES

1. USE

EFFAST uPVC pressure fittings are suitable for irrigation, potable water supply, chemical installation, water treatment, swimming pools, foodstuff industries. EFFAST uPVC pressure fittings can be used with any make of pipe made to the same international standards.

The uPVC compound used is fit for contact with **alimentary fluids** in accordance with regulations in force in Italy, France, Germany, Holland, U.K. and Scandinavian countries.

2. MATERIALS

Fittings : uPVC (unplastified polyvinyl chloride);

Gaskets : EPDM (ethylene - polypropylene rubber);

3. STANDARDS

All EFFAST fittings are manufactured according to international standards as ISO 727, DIN 8063, UNI 7442/75, NFT 54/028 - Now with ISO 9002.

4. PRESSURE - TEMPERATURE RELATIONSHIP

The maximum working pressure is 16kg/cm² (227,6 PSI) from - 20°C to 25°C.

Above + 25°C the working pressure decreases in a linear way down to 4kg/cm² (56,9 PS) at + 60°C.

5. Please note that the supplier and / or any of its employees cannot be held responsible for any negligent misrepresentations made to the customer. It is the responsibility of the customer to determine that the products ordered are suitable for the purposes of intended use.

For more information relating to technical matters with regard to fittings, contact your local office for assistance. Prices are dependent on exchange rates which may fluctuate. Please check prices before quoting.

GENERAL PROPERTIES OF uPVC FITTINGS

EFFAST uPVC pressure fittings are made of stabilised unplastified poly vinyl chloride suitable for potable water according to E.E.C regulations.

Gaskets are in EPDM (DUTRALQ)

Working temperature: Max 60°C

Nominal pressure:

Series	Dimensions	PN
Solvent Jointing	from D 16 to D 160	16
Solvent Jointing	from D 200 to D 315	10
Threaded	from G 1/2" to G 4"	up to 16
Adaptor set	from D 16 to D 110	up to 16

MAXIMUM WORKING PRESSURE

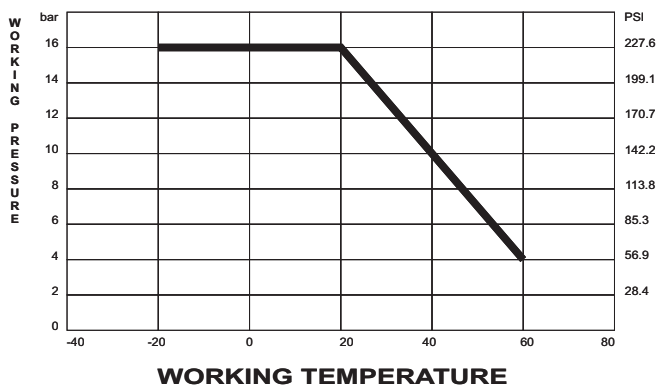

Valves

Double Union Ball Valves

BVD - Solvent



Size	Price
20	165.40
25	186.20
32	245.00
40	328.70
50	376.60
63	574.00
75	1911.00
90	2502.00
110	2940.00

BVE - Female Thread



Size	Price
1/2"	174.50
3/4"	183.10
1"	260.45
1 1/4"	334.80
1 1/2"	382.10
2"	601.40
2 1/2"	1961.50
3"	2608.00
4"	3437.50

Single Union Ball Valves

SVD - Solvent



Size	Price
20	140.70
25	140.70
32	156.70
40	209.00
50	282.60
63	470.00
75	1110.60
90	1285.00
110	2270.30

SVE - Female Thread



Size	Price
1/2"	148.70
3/4"	148.70
1"	176.90
1 1/4"	231.60
1 1/2"	332.35
2"	500.00
2 1/2"	1287.50
3"	1572.50
4"	2455.80

3 Way Ball Valves

BV3WD-Three Way
Solvent "T" port



Size	Price
20	490.00
25	602.00
32	728.00
40	938.00
50	1154.00
63	1386.00

BV3WD-Three Way
Solvent "L" port



Size	Price
20	590.00
25	712.00
32	854.00
40	1072.00
50	1361.00
63	1770.00

Compact Ball Valves

CHD - Solvent



Size	Price
20	17.00
25	21.00
32	32.00
40	48.00
50	73.00
63	97.00
75	236.00
90	340.00
110	701.00

CHE - Female Thread



Size	Price
1/2"	17.00
3/4"	21.00
1"	32.00
1 1/4"	48.00
1 1/2"	73.00
2"	97.00
2 1/2"	236.00
3"	340.00
4"	701.00

There is no guarantee on Chinese compact valves as they are intended for low pressure applications only.

Industrial Ball Valves

BKD

- Double Union - Solvent



Size	Price
20	467.90
25	572.00
32	679.00
40	871.70
50	1114.25
63	1382.10
75	3500.00
90	4165.00
110	5880.00

EPDM rings

BKDVITON

- Double Union - Solvent



Size	Price
20	615.00
25	736.00
32	894.50
40	1146.80
50	1457.65
63	1818.20
75	4269.00
90	5366.00
110	7282.00

FPM (Viton) rings

Actuator Bracket

BKDKIT

To convert BKD to actuated valves



Size	Price
20	715.00
25	731.00
32	744.00
40	755.00
50	779.00
63	789.00
75/90	1183.00
110	1210.00

Actuators available

Please enquire

Diaphragm Valves

DFV - Double Union Solvent



Size	Price
20	1239.00
25	1345.00
32	1680.00
40	2030.00
50	2576.00
63	3220.00

Butterfly Valves

FVD



Size	Price
63	1533.00
75	1582.00
90	1820.00
110	1960.00
125/140	2240.00
160	2730.00
200	3850.00
250	8587.00
315	P.O.A.

Non Return Valves

VRIV - Double union
-Spring Loaded
-Solvent



Size	Price
20	252.00
25	300.00
32	322.00
40	378.00
50	546.00
63	693.00
75	1635.00
90	2100.00
110	3260.00

VRIE - Double Union
- Spring Loaded
- Threaded



Size	Price
1/2"	266.00
3/4"	315.00
1"	336.00
1 1/4"	406.00
1 1/2"	574.00
2"	728.00

VRIS - Single union
-Spring Loaded
-Solvent



Size	Price
20	168.00
25	206.00
32	224.00
40	266.00
50	378.00
63	539.00

VRISE - Single union
-Spring Loaded
-Threaded



Size	Price
1/2"	17900
3/4"	216.00
1"	237.00
1 1/4"	282.00
1 1/2"	396.00
2"	565.00

VRIVFLAP

- Flap Type



Size	Price
50	451.00
63	553.00
75	616.00
90	735.00
110	910.00
125	966.00
140	1036.00
160	1274.00
200	1512.00
250	3360.00
315	3640.00

VRIVCLEAR

- Double union
-Spring Loaded
-Clear Solvent



Size	Price
50	770.00

Z.VRIVCLEAR

- Double union
-Swing
-Clear Solvent



Size	Price
50	680.00

FOOT VALVE

- Double union
-Spring Loaded
-Solvent



Size	Price
20	338.00
25	398.00
32	440.50
40	516.50
50	752.50
63	940.00
75	1985.00
90	2475.00
110	3635.00

Larger Sizes on Request

Knife Valves

Z.KNIFE - Solvent



Size	Price
50	330.00
63	520.00
75	770.00
90	1162.00
110	1640.00
160	5756.00
200	POA
250	POA

Strainers

RVIT - Clear Solvent Spigot/ solvent ex Europe



Size	Price
20	1500.00
25	1800.00
32	2184.00
40	2200.00
50	2380.00
63	3128.00
75	4158.00
90	4410.00
110	10500.00

RUVIT- Clear Solvent Union Ends ex China



Size	Price
20	300.00
25	420.00
32	680.00
40	1000.00
50	1150.00
63	1450.00

Air Release Valves U/ARV



Size	Price
1" Kinetic	350.00
1" Automatic & Kinetic	630.00
2" Kinetic	700.00
2" Automatic & Kinetic	1680.00

ZVD- Converts check valve to foot valve.



Size	Price
20	86.00
25	98.00
32	118.50
40	138.50
50	206.50
63	247.00
75/90	350.00
110	375.00

Flow Control Valves

IRR:F/C/V



Size	Price
13	80.00
15	85.50
20	90.50

Taps

FIG512



Size	Price
1/2"	30.00
3/4"	44.00

Insert Clear Filter

IRR:FILT



Size	Price
13	190.00
15	200.00
20	225.00

Plastic Water Meter

FIG601



Size	Price
20	780.00

Rotameters FLU

Pipe Size	Length	Flowrate	Price
20	185	50 - 500l/h	1050.00
25	226	100 - 1000l/h	1170.00
32	226	160 - 1600l/h	1250.00
32	226	250 - 2500l/h	1400.00
50	288	0.4 - 4m ³ /h (= 400 - 4000l/h)	1500.00
50	288	0.6 - 6m ³ /h (= 600 - 6000l/h)	1600.00
63	341	1.0 - 10m ³ /h (= 1000 - 10 000l/h)	2000.00



Other sizes available to order.

Solvent Weld PVC Fittings

GOD 90° Elbow



Size	Price
16	7.80
20	7.80
25	10.45
32	11.70
40	22.75
50	30.10
63	42.40
75	106.90
90	145.60
110	223.60
125	511.70
140	610.60
160	921.00
200	1503.00
250	3960.00
315	6813.00
400*	P.O.A.

GYD 45° Elbow



Size	Price
16	12.00
20	16.00
25	19.70
32	20.90
40	27.70
50	37.50
63	48.60
75	116.10
90	157.90
110	340.30
125	474.20
140	645.60
160	754.30
200	1063.00
250	3168.00
315	6020.00
400*	P.O.A.

TID 90° Tee

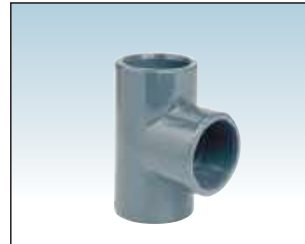

Size	Price
16	11.70
20	11.70
25	14.30
32	20.90
40	33.80
50	39.40
63	60.20
75	137.00
90	191.10
110	323.10
125	616.80
140	843.40
160	1028.90
200	1482.30
250	4277.35
315	7920.00
400*	P.O.A.

MAD Socket

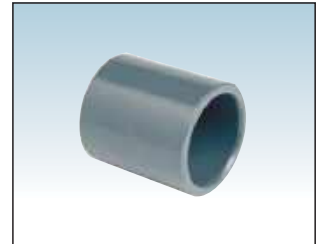

Size	Price
16	9.75
20	10.44
25	10.44
32	10.44
40	17.20
50	20.90
63	30.10
75	72.50
90	113.00
110	158.50
125	269.05
140	251.40
160	419.00
200	900.00
250	2080.00
315	3010.00
400*	P.O.A.

*= 4 bar

CUD 90° Bend



Size	Price
20	44.00
25	52.00
32	68.00
40	86.50
50	128.00
63	176.00
75	359.00
90	452.00
110	750.00

TYD 45° Tee



Size	Price
20	39.00
25	42.00
32	49.50
40	78.00
50	85.00
63	125.00
75	420.00
90	632.00
110	1287.00
160	1980.00

CRD Cross



Size	Price
20	41.60
25	50.00
32	52.00
40	78.00
50	107.00
63	148.00
75	428.00
90	565.00
110	813.00

BOD Union with O-Ring



Size	Price
16	44.20
20	41.80
25	48.00
32	51.00
40	77.50
50	99.80
63	132.10
75	415.85
90	487.80
110	564.50

RCD Reducing bush



Size	Price
20 x 16	10.45
25 x 16	11.10
25 x 20	11.10
32 x 16	15.40
32 x 20	15.40
32 x 25	14.75
40 x 20	16.60
40 x 25	16.60
40 x 32	16.60
50 x 25	19.70
50 x 32	19.70
50 x 40	19.70
63 x 32	27.10
63 x 40	27.10
63 x 50	27.10
75 x 40	44.85
75 x 50	44.85
75 x 63	44.85
90 x 50	73.10
90 x 63	73.10
90 x 75	73.10
110 x 63	100.75
110 x 75	100.75
110 x 90	100.75
125 x 75	213.80
125 x 90	213.80
125 x 110	213.80
140 x 90	308.40
140 x 110	308.40
140 x 125	308.40
160 x 90	334.15
160 x 110	334.15
160 x 125	334.15
160 x 140	334.15
200 x 160	375.00
250 x 160	1472.00
250 x 200	1473.00
315 x 200	2297.00
315 x 250	2297.00
400 x 315	P.O.A.

TRD 90° Tee reduced



Size	Price
40 x 20	36.40
40 x 25	36.40
40 x 32	36.40
50 x 25	45.70
50 x 32	45.70
50 x 40	45.70
63 x 32	70.80
63 x 40	70.80
63 x 50	70.80
75 x 40	131.30
75 x 50	131.30
75 x 63	131.30
90 x 50	191.50
90 x 63	191.50
90 x 75	191.50
110 x 63	297.30
110 x 75	297.30
110 x 90	297.30
125 x 75	745.82
125 x 90	745.82
125 x 110	745.82
160 x 90	1089.45
160 x 110	1089.45
160 x 125	1089.45
160 x 140	1089.45

CAD Cap



Size	Price
16	10.30
20	9.90
25	10.45
32	12.30
40	17.20
50	22.15
63	29.50
75	80.50
90	111.80
110	157.90
125	321.50
140	339.50
160	458.60
200	586.00
250	2130.00
315	3267.00

QRD Stub serrated



Size	Price
20	14.75
25	16.60
32	17.20
40	25.20
50	38.70
63	62.10
75	76.80
90	92.75
110	121.70
125	262.30
140	285.00
160	315.10
200	552.50
250	1072.50
315	1950.00
400	P.O.A.

PGD Hose adaptor



Size	Price
16	13.00
20	15.60
25	18.20
32	23.40
40	27.30
50	30.00
63	49.50

RLD Red. Socket - M.F.



Size	Price
25 x 32 x 20	15.50
32 x 40 x 25	18.00
40 x 50 x 32	23.00
50 x 63 x 40	37.50
63 x 75 x 50	52.00
75 x 90 x 63	78.00
90 x 110 x 75	117.00
110 x 125 x 90	162.85
125 x 140 x 110	258.10
200 x 160	1998.00

Flanges

FLD Loose flange PN 10-16



Size	Price
20	37.70
25	37.70
32	45.50
40	55.90
50	63.75
63	73.40
75	98.90
90	113.30
110	134.50
125	177.00
140	207.60
160	253.60
200	494.00
250	983.00
315	1584.30
400	P.O.A.
500	P.O.A.

FFD Fixed flange PN 10-16



Size	Price
25	54.60
32	67.60
40	80.60
50	97.00
63	124.80
75	156.00
90	179.50
110	244.40
125	344.92
140	418.70
160	548.20
200	764.50
250	2616.20

FCD Blank flange PN 10 - 16



Size	Price
32	78.00
40	101.00
50	107.00
63	133.00
75	156.00
90	187.00
110	247.00
125	351.00
140	403.00
160	533.00
200	890.00

FFE Threaded Flange



Size	Price
$\frac{3}{4}$ "	65.65
1"	69.00
$1\frac{1}{4}$ "	105.00
$1\frac{1}{2}$ "	141.60
2"	172.50
$2\frac{1}{2}$ "	234.25
3"	287.00
4"	354.00

Adaptor Fittings

AMG Adaptor male threaded



Size	Price
16 x 20 x 3/8"	11.70
16 x 20 x 1/2"	14.20
20 x 25 x 1/2"	13.00
20 x 25 x 3/4"	13.00
25 x 32 x 1/2"	14.85
25 x 32 x 3/4"	14.85
25 x 32 x 1"	14.85
32 x 40 x 3/4"	17.85
32 x 40 x 1"	17.85
32 x 40 x 1 1/4"	20.90
40 x 50 x 1"	26.00
40 x 50 x 1 1/4"	26.00
40 x 50 x 1 1/2"	30.10
50 x 63 x 1 1/4"	39.40
50 x 63 x 1 1/2"	39.40
50 x 63 x 2"	39.40
63 x 75 x 1 1/2"	52.30
63 x 75 x 2"	52.30
63 x 75 x 2 1/2"	52.30
75 x 90 x 2"	108.00
75 x 90 x 2 1/2"	121.00
75 x 90 x 3"	134.00
90 x 110 x 2 1/2"	147.00
90 x 110 x 3"	147.00
90 x 110 x 4"	171.00
110 x 125 x 3"	226.00
110 x 125 x 4"	226.00

BMG Union



Size	Price
50 x 1 1/2"	96.00
50 x 2"	96.00
63 x 2"	140.00

AFG Adaptor female threaded

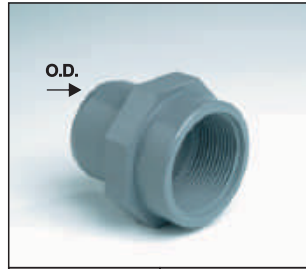

Size	Price
16 x 3/8"	24.60
20 x 1/2"	27.70
20 x 3/4"	30.75
25 x 1/2"	30.75
25 x 3/4"	32.00
25 x 1"	33.80
32 x 3/4"	33.80
32 x 1"	38.10
40 x 1"	40.60
40 x 1 1/4"	42.20
50 x 1 1/4"	51.00
50 x 1 1/2"	51.00
50 x 2"	52.00
63 x 2"	87.90
75 x 2"	103.00
75 x 2 1/2"	111.00
75 x 3"	112.00
90 x 2 1/2"	153.20
90 x 3"	163.80
90 x 4"	187.20
110 x 3"	206.70
110 x 4"	215.00

RCG Adaptor Bush



Size	Price
25 x 1/2"	22.20
32 x 3/4"	24.60
40 x 1"	33.20
50 x 1 1/4"	38.10
63 x 1 1/2"	55.90
75 x 2"	129.70
90 x 2 1/2"	162.20
110 x 3"	251.90

MAG Solvent x Female Socket

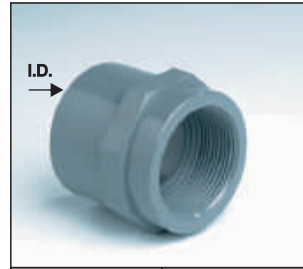

Size	Price
16 x 3/8"	19.05
20 x 1/2"	19.05
25 x 3/4"	20.30
32 x 1"	22.75
40 x 1 1/4"	28.90
50 x 1 1/2"	43.00
63 x 2"	65.15
75 x 2 1/2"	192.30
90 x 3"	209.50
110 x 4"	305.90

TIG Fem.Thread Center off-take



Size	Price
16 x 3/8"	19.80
20 x 1/2"	26.50
25 x 3/4"	28.90
32 x 1"	43.00
40 x 1 1/4"	48.00
50 x 1 1/2"	71.90
63 x 2"	127.80
75 x 2 1/2"	259.50
90 x 3"	359.40
110 x 4"	587.85

GOG Solvent x Female 90° Elbow



Size	Price
16 x 3/8"	19.70
20 x 1/2"	21.50
25 x 3/4"	25.20
32 x 1"	28.90
40 x 1 1/4"	40.00
50 x 1 1/2"	78.65
63 x 2"	108.15
75 x 2 1/2"	226.70
90 x 3"	331.10
110 x 4"	511.10

BOG Solvent x Female Union



Size	Price
20 x 1/2"	62.70
25 x 3/4"	71.90
32 x 1"	94.00
40 x 1 1/4"	111.80
50 x 1 1/2"	154.20
63 x 2"	197.20
75 x 2 1/2"	568.20
90 x 3"	664.00
110 x 4"	767.20

B.S.P. Threaded Fittings

GOE 90° Elbow



Size	Price
1/2"	19.05
3/4"	24.00
1"	29.50
1 1/4"	42.40
1 1/2"	62.10
2"	89.10
2 1/2"	229.75
3"	347.70
4"	567.60

MAE Socket



Size	Price
1/2"	19.70
3/4"	21.50
1"	25.80
1 1/4"	33.80
1 1/2"	43.65
2"	57.20
2 1/2"	197.20
3"	235.90
4"	340.30

TIE 90° Tee



Size	Price
1/2"	21.90
3/4"	23.90
1"	29.60
1 1/4"	46.86
1 1/2"	63.10
2"	92.70
2 1/2"	231.70
3"	308.00
4"	602.60

BOE Union



Size	Price
1/2"	62.65
3/4"	74.95
1"	84.20
1 1/4"	104.50
1 1/2"	143.80
2"	197.80
2 1/2"	463.00
3"	530.00
4"	614.00

CAE Thr. end cap



Size	Price
1/2"	16.60
3/4"	18.50
1"	20.30
1 1/4"	30.75
1 1/2"	35.65
2"	48.60
2 1/2"	135.00
3"	184.30
4"	257.70

TAE Plug



Size	Price
1/2"	10.30
3/4"	12.35
1"	15.60
1 1/4"	23.20
1 1/2"	27.05
2"	35.40
2 1/2"	125.50
3"	146.10
4"	251.00

NUE Backnut



Size	Price
1/2"	19.05
3/4"	21.50
1"	29.50
1 1/4"	43.00
1 1/2"	52.00
2"	72.50
2 1/2"	99.00
3"	110.00
4"	132.10

PGE Hose adaptor threaded



Size	Price
12 x 1/4"	11.30
16 x 3/8"	11.30
20 x 1/2"	18.20
25 x 3/4"	20.80
32 x 1"	23.40
40 x 1 1/4"	33.80
50 x 1 1/2"	44.20
63 x 2"	62.40

RIE Red. male-female



Size	Price
1/2" x 3/8"	14.00
3/4" x 3/8"	14.60
3/4" x 1/2"	14.60
1" x 3/8"	18.05
1" x 1/2"	18.05
1" x 3/4"	18.05
1 1/4" x 1/2"	25.10
1 1/4" x 3/4"	25.10
1 1/4" x 1"	25.10
1 1/2" x 3/4"	32.82
1 1/2" x 1"	32.82
1 1/2" x 1 1/4"	32.82
2" x 1"	44.40
2" x 1 1/4"	44.40
2" x 1 1/2"	44.40
2 1/2" x 1 1/4"	90.73
2 1/2" x 1 1/2"	90.73
2 1/2" x 2"	90.73
3" x 1 1/2"	153.40
3" x 2"	153.40
3" x 2 1/2"	153.40
4" x 2"	269.00
4" x 2 1/2"	269.00
4" x 3"	269.00

RCE Reducing bush



Size	Price
1/2" x 1/4"	16.90
3/4" x 1/2"	18.20
1" x 3/4"	20.90
1 1/4" x 1"	32.00
1 1/2" x 1 1/4"	41.80
2" x 1 1/2"	55.30
2 1/2" x 2"	135.75
3" x 2 1/2"	192.90
4" x 3"	307.15

NIE Nipple



Size	Price
3/8"	12.90
1/2"	14.15
3/4"	16.60
1"	20.30
1 1/4"	26.50
1 1/2"	31.35
2"	41.80
2 1/2"	113.65
3"	156.05
4"	247.60

NRE Reducing nipple



Size	Price
3/4" x 1/2"	24.60
1" x 3/4"	30.10
1 1/4" x 1"	40.00
1 1/2" x 1 1/4"	51.00
2" x 1 1/2"	71.90
2 1/2" x 2"	132.00
3" x 2 1/2"	170.20
4" x 3"	260.45

MRE Reducing socket



Size	Price
1/2" x 3/8"	33.80
3/4" x 1/2"	33.80
1" x 3/4"	36.25
1 1/4" x 1"	44.85
1 1/2" x 1 1/4"	65.75
2" x 1 1/2"	90.30
2 1/2" x 2"	198.40
3" x 2 1/2"	237.10
4" x 3"	340.30

MGE Red. female - male



Size	Price
1/2" x 3/8"	29.50
3/4" x 1/2"	34.40
1" x 3/4"	36.24
1 1/4" x 1"	40.00
1 1/2" x 1 1/4"	46.10
2" x 1 1/2"	59.60
2 1/2" x 2"	121.10
3" x 2 1/2"	162.20
4" x 3"	272.75

ATESP Tank connector



Size	Price
2x1 1/2"	130.00

ATE Tank connector



Size	Price
1/2"	43.70
3/4"	48.40
1"	52.00
1 1/4"	69.00
1 1/2"	75.40
2"	106.60
2 1/2"	234.00
3"	288.00
4"	850.00

ATEPVC PVC Tank connector



Size	Price
25 x 25 x 1"	83.00
50 x 50 x 2"	134.00
75 x 75 x 3"	390.00

ATS Tank adaptor



Size	Price
63x1 1/2"	143.00
63x2"	248.00
75x2"	400.00

Pvc-u Manifold Systems PN 10

W.002. **Elbow 1"**
Female X Female 90°



103.00

W.003. **Socket 1"**
Female X Male



68.00

W.004. **Male Elbow 1"**
Female X Male 90°



81.00

W.005. **Tee 1"**
Female X Female X Male



108.00

W.006. **Socket 1"**
Female X Female



91.00

W.007. **Cross 1"**
Female X Female X Female X Male



159.00

W.008. **Two outlet manifold 1"**
Female X Male



186.00

W.009. **Three outlet manifold 1"**
Female X Male



328.00

W.010. **Four outlet manifold 1"**
Female X Male



385.00

W.011. **Nipple 1"**
Male X Male



30.50

W.012. **Reducing Nipple**
Male X Male $\frac{3}{4}$ X 1"



30.50

W.013. **Cap 1"**
Female



25.00

W.032. **Plug 1"**
Male



20.00

uPVC Pressure Pipe

Price Per Metre

Outside Diameter(mm)	Class 4	Class 6	Class 9	Class 12	Class 16
20					16.00
25					20.00
32			21.00	25.00	32.00
40		24.00	41.00	44.00	50.00
50	40.00	42.00	50.00	63.00	82.00
63	44.00	53.00	74.50	96.00	124.00
75	54.00	72.00	112.00	136.00	180.00
90	75.00	107.00	146.00	193.50	247.00
110	110.00	127.00	182.50	240.00	306.00
125	144.00	174.00	240.50	309.00	397.00
140	173.00	208.00	298.00	388.50	497.00
160	227.00	267.00	386.00	500.00	643.00
200	352.50	402.00	593.00	768.00	1003.00
250	546.00	646.00	927.00	1214.00	1550.00
315	875.50	1032.00	1464.00	1888.60	2450.00

PVC pipe Wall thickness and mass per 6m length.

Outside Diameter(mm)	Class 4		Class 6		Class 9		Class 12		Class 16	
	mm	kg	mm	kg	mm	kg	mm	kg	mm	kg
20									1.5	0.81
25							1.5	1.03	1.9	1.29
32					1.5	1.34	1.8	1.59	2.4	2.08
40			1.5	1.70	1.8	2.02	2.3	2.53	3.0	3.25
50	1.5	2.17	1.8	2.58	2.2	3.13	2.8	3.96	3.7	5.04
63	1.5	2.76	1.9	3.42	2.7	4.87	3.6	6.30	4.7	8.04
75	1.5	3.30	2.2	4.78	3.2	6.87	4.3	8.94	5.6	11.34
90	1.8	4.74	2.7	6.96	3.9	9.84	5.1	12.72	6.7	16.32
110	2.2	7.08	2.6	8.22	3.9	12.12	5.1	15.72	6.7	20.22
125	2.5	9.06	3.0	10.80	4.4	15.60	5.8	20.22	7.6	26.04
140	2.8	11.49	3.3	13.32	4.9	19.32	6.5	25.38	8.5	32.64
160	3.2	14.82	3.8	17.40	5.6	25.32	7.4	33.30	9.7	42.54
200	3.9	22.68	4.7	26.88	7.0	49.54	9.2	51.30	12.1	66.36
250	4.9	35.34	5.9	42.12	8.7	61.26	11.5	79.98	15.1	103.38
315	6.2	56.10	7.4	66.60	11.0	97.50	14.5	127.02	19.0	163.86
400	7.8	89.90	9.4	107.28	14.0	157.74	18.4	204.84	24.1	263.82

Weights and thicknesses may vary depending on manufacturer

L.D.P.E. Poly Pipe

Utility Grade - Non - SABS

(For use with polypropylene and nylon fittings)

Price per 100 meter coil

Inside Diameter	15	20	25	32	40	50
Class 3	560.00	760.00	954.00	1300.00	1800.00	2950.00
Class 6	590.00	910.00	1560.00	2480.00	3480.00	5600.00

Pipe

H.D.P.E. Pipe

Type IV. SABS 533 Price Per Metre

Outside Diameter(mm)	Class 8	Class 10	Class 12	Class 16
20		9.30	9.30	10.70
25		10.90	13.70	15.60
32		17.90	21.50	25.80
40	22.70	27.00	33.20	39.81
50	34.15	41.90	50.80	61.85
63	53.40	66.70	81.15	98.00
75	76.40	94.00	115.20	137.00
90	109.50	135.40	164.90	198.20
110	171.00	201.90	244.15	294.80

Available in 50 or 100m Coils or 6m Lengths,

Polypropylene Pressure Pipes

Price Per Metre

Outside Diameter(mm)	PN 10 SDR 11
20	29.00
25	45.00
32	65.00
40	84.00
50	132.00
63	200.00
75	280.00
90	400.00
110	594.00
125	770.00
140	958.00
160	1246.00

Standard = 5m length

Non SABS Pipe

16	Blue / White	8.80
20	Blue / White	9.00
25	Blue / White	12.00
32	Blue / White	18.00
40	White	20.00
50	White	40.00
50	Black	60.00

Accessories

Galv. Backing Rings

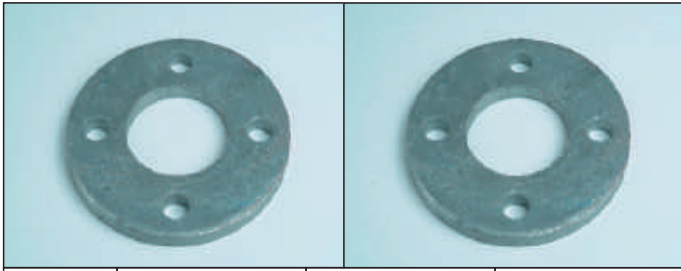

Size	Table D	Table 16 (pvc)	Table 16 (hdpe)
32	91.00		
40	105.00		
50	124.00	150.00	150.00
63	143.00	165.00	165.00
75	149.00	185.00	185.00
90	165.00	205.00	205.00
110	216.00	240.00	240.00
125	286.00	354.00	354.00
140	286.00	354.00	354.00
160	362.00	398.00	398.00
200	479.00	567.00	567.00
250	848.00	1064.00	1064.00
315	1285.00	1435.00	1435.00

Other drilling and sizes on request

Bolts & Nuts for GBR



Bolts & Nuts are Electro Galv. Mild Steel NB check length.

For Flange	Size	Qty for Flange	Price
50 / 63 / 75 / 90	M16 X 60mm	4	22.00
110 / 125 / 140	M16 X 70mm	8	25.00
160 / 200	M16 X 80mm	8	30.00
250	M20 X 115mm	8	52.00
315	M20 X 125mm	8	56.00

Nail-in-Anchor



Sizes are a Guide Only

PTA / PTD Size	Anchor Size	Price for Nail and Plug
20 / 25 / 32	6 X 45	2.00
40 / 50 / 63	6 X 55	2.50
75 / 90 / 110	6 X 70	3.00
110	8 X 75	4.60

Gaskets

(For QRD)

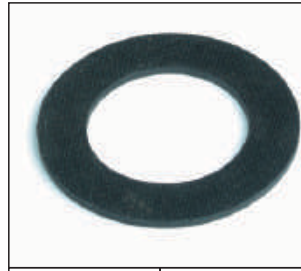

Size	Price
50	7.80
63	12.00
75	15.00
90	18.00
110	24.00
125	29.00
140	39.00
160	48.00
200	64.00
250	77.00
315	94.00

Gaskets

(Full face T10)



Size	Price
50	14.60
63	22.00
75	22.00
90	22.00
110	29.50
125	29.50
140	48.00
160	48.00
200	64.00
250	120.00
315	128.00

Pipeclip

Pipeclip no Clip



Size	Price
20	4.20
25	5.00
32	6.50
40	7.30

Pipeclip

Pipeclip With Clip



Size	Price
50	17.00
63	22.00
75	31.00
90	37.00
110	44.00
125	104.00
140	104.00
160	120.00
200	137.00

Thread Tape



Size	Price
Thick	4.00
Very Thick	12.00

Adhesives

unecol Adhesive



125ml	52.00
250 ml	140.00
500 ml	212.00
1L	364.00
250 ml Instant	160.00

PVC Cleaner



250 ml	64.00
500 ml	100.00



Oatey

HEAVY DUTY 473 ML	240.00
HEAVY DUTY 237 ML	141.00
BLUE LAVA 473ML	278.80

Hemp and Paste



Paste 150gr pot	120.00
Paste 400gr pot	210.00
Hemp 80gr dispenser	80.00

Tangit



100 ml	110.00
250 ml	214.50
500 ml	357.60
1l	616.00

Rhino Joining Compound



500g	200.00
------	--------

Extend-o-Cord



	150.00
--	--------

Stag



500g	470.00
------	--------

Compression Fittings

Materials: Body and nut are in pp, o-rings in nbr 70 shore, clinching rings in acetalic resin.

All materials are suitable for alimentary fluids.

Maximum Temperature: 80°C

Maximum Pressure: PN 16 (At 20°C) up to Diam 63, PN 10 above.

310 Coupling



Size	Price
20	26.70
25	36.00
32	47.70
40	82.50
50	120.90
63	195.00
75	297.00
90	438.00
110	805.00

311 Reducing Coupling



Size	Price
25 x 16	33.00
25 x 20	33.60
32 x 20	44.10
32 x 25	44.10
40 x 25	71.40
40 x 32	71.40
50 x 25	101.70
50 x 32	101.70
50 x 40	101.70
63 x 25	161.40
63 x 32	161.40
63 x 40	161.40
63 x 50	161.40
75 x 50	280.80
75 x 63	280.80
90 x 63	420.00
90 x 75	420.00
110 x 75	735.00
110 x 90	735.00

320 Male Adaptor



Size	Price
20 x 1/2"	16.00
20 x 3/4"	16.00
20 x 1"	16.00
25 x 1/2"	21.00
25 x 3/4"	21.00
25 x 1"	21.00
32 x 1/2"	29.40
32 x 3/4"	29.40
32 x 1"	29.40
32 x 1 1/4"	29.40
40 x 1"	47.70
40 x 1 1/4"	47.70
40 x 1 1/2"	47.70
40 x 2"	53.00
50 x 1 1/4"	71.10
50 x 1 1/2"	71.10
50 x 2"	71.10
63 x 1 1/4"	117.90
63 x 1 1/2"	117.90
63 x 2"	117.90
63 x 2 1/2"	117.90
75 x 2"	183.60
75 x 2 1/2"	183.60
75 x 3"	183.60
90 x 2"	276.00
90 x 2 1/2"	276.00
90 x 3"	276.00
90 x 4"	280.00
110 x 2"	478.00
110 x 3"	478.00
110 x 4"	478.00

330 Female Adaptor



Size	Price
20 x 1/2"	19.00
20 x 3/4"	19.00
20 x 1"	19.00
25 x 1/2"	27.00
25 x 3/4"	27.00
25 x 1"	27.00
32 x 1/2"	34.00
32 x 3/4"	34.00
32 x 1"	34.00
32 x 1 1/4"	34.00
40 x 1"	58.50
40 x 1 1/4"	58.50
40 x 1 1/2"	58.50
50 x 1 1/4"	75.00
50 x 1 1/2"	75.00
50 x 2"	75.00
63 x 1 1/4"	115.00
63 x 1 1/2"	115.00
63 x 2"	115.00
75 x 2"	195.00
75 x 2 1/2"	195.00
75 x 3"	195.00
90 x 2"	297.00
90 x 2 1/2"	297.00
90 x 3"	297.00
90 x 4"	380.00
110 x 3"	609.00
110 x 4"	609.00

312 End Cap



Size	Price
20	18.00
25	23.70
32	31.20
40	49.20
50	73.50
63	114.30
75	204.60
90	295.80
110	561.00

370 Spanner



Size	Price
16 x 75	63.00
50 x 110 local	410.00

350 90° Elbow



Size	Price
16	25.00
20	27.90
25	38.40
32	51.60
40	89.40
50	134.40
63	217.50
75	327.00
90	480.00
110	873.00

351 90° Elbow with thr. male offtake.



Size	Price
16 x 1/2"	20.40
20 x 1/2"	20.40
20 x 3/4"	20.40
25 x 1/2"	26.40
25 x 3/4"	26.40
25 x 1"	26.40
32 x 1/2"	35.70
32 x 3/4"	35.70
32 x 1"	35.70
32 x 1 1/4"	35.70
40 x 1"	58.20
40 x 1 1/4"	58.20
40 x 1 1/2"	58.20
50 x 1 1/4"	91.20
50 x 1 1/2"	91.20
50 x 2"	95.00
63 x 1 1/2"	150.90
63 x 2"	150.90
63 x 2 1/2"	150.90
75 x 2"	265.50
75 x 2 1/2"	265.50
75 x 3"	290.00
90 x 3"	384.00
110 x 3"	735.00
110 x 4"	735.00

352 90° Elbow with thr. female offtake



Size	Price
20 x 1/2"	20.70
20 x 3/4"	20.70
25 x 1/2"	28.20
25 x 3/4"	28.20
25 x 1"	28.20
32 x 1/2"	35.70
32 x 3/4"	35.70
32 x 1"	35.70
32 x 1 1/4"	50.00
40 x 3/4"	73.50
40 x 1"	73.50
40 x 1 1/4"	73.50
40 x 1 1/2"	75.00
50 x 1 1/4"	115.80
50 x 1 1/2"	115.80
50 x 2"	138.00
63 x 1 1/2"	191.40
63 x 2"	191.40
63 x 2 1/2"	209.70
75 x 2 1/2"	297.00
90 x 3"	501.00
110 x 4"	876.00

360 Flange Adaptor



Size	Price
50 x 1 1/2"	351.00
50 x 2"	351.00
63 x 2"	381.00
63 x 2 1/2"	381.00
75 x 2 1/2"	561.00
75 x 3"	561.00
90 x 3"	666.00
110 x 4"	876.00

H.D.P.E. Pipe

Type IV. SABS 533 Price Per Metre

Outside Diameter(mm)	Class 8	Class 10	Class 12	Class 16
20		9.30	9.30	10.70
25		10.90	13.70	15.60
32		17.90	21.50	25.80
40	22.70	27.00	33.20	39.81
50	34.15	41.90	50.80	61.85
63	53.40	66.70	81.15	98.00
75	76.40	94.00	115.20	137.00
90	109.50	135.40	164.90	198.20
110	171.00	201.90	244.15	294.80

Available in 50 or 100m Coils or 6m Lengths,

340 90° Tee



Size	Price
16	30.00
20	40.00
25	56.10
32	75.00
40	133.20
50	198.30
63	318.00
75	498.00
90	702.00
110	1293.00

345 90° Increasing Tee



Size	Price
20 x 25 x 20	70.00
25 x 32 x 25	86.00

343 Reducing 90° Tee



Size	Price
25 x 20	52.50
32 x 20	70.20
32 x 25	70.20
40 x 25	116.70
40 x 32	116.70
50 x 25	188.10
50 x 32	188.10
50 x 40	188.10
63 x 25	297.00
63 x 32	297.00
63 x 40	297.00
63 x 50	297.00
75 x 50	489.00
75 x 63	489.00
90 x 63	729.00
90 x 75	729.00
110 x 63	1263.00
110 x 75	1263.00
110 x 90	1263.00

341 90° Tee with thr. male offtake



Size	Price
16 x 1/2"	30.00
16 x 3/4"	30.00
20 x 1/2"	31.50
20 x 3/4"	31.50
20 x 1"	31.50
25 x 1/2"	44.70
25 x 3/4"	44.70
25 x 1"	44.70
32 x 1/2"	59.70
32 x 3/4"	59.70
32 x 1"	59.70
32 x 1 1/4"	59.70
40 x 1"	107.10
40 x 1 1/4"	107.10
40 x 1 1/2"	107.10
50 x 1 1/4"	162.90
50 x 1 1/2"	162.90
50 x 2"	162.90
63 x 1 1/2"	290.70
63 x 2"	290.70
63 x 2 1/2"	290.70
75 x 2"	450.00
75 x 2 1/2"	450.00
75 x 3"	450.00
90 x 3"	585.00
90 x 4"	585.00
110 x 4"	1158.00

342 90° Tee with thr. female offtake



Size	Price
16 x 1/2"	30.00
16 x 3/4"	30.00
20 x 1/2"	35.10
20 x 3/4"	35.10
25 x 1/2"	45.60
25 x 3/4"	45.60
25 x 1"	45.60
32 x 1/2"	61.50
32 x 3/4"	61.50
32 x 1"	61.50
32 x 1 1/4"	61.50
40 x 1"	110.70
40 x 1 1/4"	110.70
50 x 1 1/4"	162.00
50 x 1 1/2"	162.00
50 x 2"	170.00
63 x 1 1/2"	258.90
63 x 2"	258.90
63 x 2 1/2"	258.90
75 x 2"	420.00
75 x 2 1/2"	420.00
75 x 3"	450.00
90 x 3"	657.00
110 x 4"	1077.00

Saddles



Material: Body U.V. Stabilised Polyprop.
Bolts - Galv. Steel. S/S on request
O'-Ring - NBR

Working Pressure: Unreinforced 20 - 160mm = 6 Bar
Reinforced 20 - 160mm=10 Bar
200 - 315mm = 6 Bar

Reinforcing Rings available on request.

Sizes 2.1/2", 3" and 4" have Reinforcing Rings as standard

d x d	Un-reinforced	Reinforced	16 bar
20 x 1/2"	18.80		
25 x 1/2" 25 x 3/4"	18.80	27.00	31.00
32 x 1/2" 32 x 3/4" 32 x 1"	21.10	32.60	43.00
40 x 1/2" 40 x 3/4" 40 x 1"	23.25	34.50	58.00
50 x 1/2" 50 x 3/4" 50 x 1"	28.00	39.00	65.00
50 x 1 1/4"	45.00	45.00	163.00
63 x 1/2" 63 x 3/4" 63 x 1" 63 x 1 1/4" 63 x 1 1/2"	48.00	62.00	93.00
75 x 1/2" 75 x 3/4" 75 x 1" 75 x 1 1/4" 75 x 1 1/2" 75 x 2"	59.00	83.00	109.00 215.00
90 x 1/2" 90 x 3/4" 90 x 1" 90 x 1 1/4" 90 x 1 1/2" 90 x 2"	66.00	90.00	115.00 260.00
110 x 1/2" 110 x 3/4" 110 x 1" 110 x 1 1/4" 110 x 1 1/2" 110 x 2"	77.00	102.00	148.00 226.00
110 x 2 1/2"		170.00	
110 x 3"		209.00	
125 x 3/4" 125 x 1" 125 x 1 1/4" 125 x 1 1/2" 125 x 2"	198.00	221.00	

125 x 2 1/2"			
125 x 3"		288.00	
125 x 4"			
140 x 3/4" 140 x 1" 140 x 1 1/4" 140 x 1 1/2" 140 x 2"	235.50	245.00	
140 x 2 1/2" 140 x 3" 140 x 4"		293.00	
160 x 1" 160 x 1 1/4" 160 x 1 1/2" 160 x 2"	235.50	248.00	390.00
160 x 2 1/2" 160 x 3" 160 x 4"		299.00	
200 x 1" 200 x 1 1/4" 200 x 1 1/2" 200 x 2" 200 x 3" 200 x 4"		1287.00	1300.00
250 x 2" 250 x 3" 250 x 4"		2026.00	
315 x 2" 315 x 3" 315 x 4"		2518.00	

Double Saddle



75 x 3/4"	74.00
90 x 3/4"	94.00
110 x 3/4"	110.00
125 x 3/4"	326.50

Reinforcing Rings

1/2"	6.50
3/4"	8.50
1"	11.00
1 1/4"	15.00
1 1/2"	20.00
2"	25.00

PVC Fabricated Fittings



Pipe Size	50mm	63mm	75mm	90mm	110mm	125mm	140mm	160mm	200mm	250mm	315mm
-----------	------	------	------	------	-------	-------	-------	-------	-------	-------	-------

Class 9 Solvent Weld

Adaptor Sleeve PVC/AC C.O.D	22.00	25.00	57.00	37.00	42.00	135.00	140.00	153.00	318.00	588.00	
Socket -Adaptors PVC/BSP Male	24.00	25.00	40.00	67.00	103.00	175.00	183.00	250.00			
Socket -Faucet PVC/BSP Female	21.00	25.00	40.00	67.00	103.00	175.00	183.00	250.00			
Bends 90°, 45°, 22½°, 11¼°	36.50	53.00	78.00	111.80	172.50	272.00	401.00	462.50	835.00	1644.00	4394.00
End Caps	11.40	20.20	27.30	45.00	69.30	96.00	120.00	151.00	263.00	335.00	632.00
Reducers Socket/* Spigot 1 step	18.00	25.00	38.00	60.00	90.00	145.00	198.00	255.00	390.00	990.00	1490.00
Reducers Socket/* Spigot 2 step	27.00	29.00	49.00	65.00	103.00	170.00	220.00	272.00	704.00	1281.00	1590.00
Sockets	12.90	18.30	26.50	39.70	60.00	107.00	145.00	190.50	320.00	517.00	930.00

RubberRing (Z-Lok)

Repair coupling class 9 Standard	98.00	128.00	136.00	163.00	194.00	280.00	340.00	395.00	667.00	1094.00	1811.00
Repair coupling class 9 500mm long	150.00	230.00	290.00	290.00	351.00	460.00	612.00	654.00	817.00	1121.00	
Repair coupling class 9 750mm long	191.00	290.00	381.00	394.00	485.00	502.00	670.00	724.00	841.00		
Repair coupling class 16	129.00	166.00	190.00	204.00	290.00	405.00	528.00	621.00	953.00	1517.00	

Wide Range Couplings

Nominal Bore (mm)	Pipe O.D. Range (mm)	Price
40	48 - 60	590.00
50	59 - 72	930.00
80	88 - 103	790.00
110	108 - 128	900.00
125	138 - 153	1205.00
150	159 - 182	1360.00
175	192 - 210	1810.00
200	218 - 235	2070.00
225	227 - 267	2280.00
250	272 - 289	2540.00
300	315 - 332	2980.00



Ultra Clamps

S.A.B.S.1808-45 and JASWIC Compliant.



Code	Description	Band Width	Application	Price
CASC-033-037	Snap Ultra Clamp 33-35mm	75mm	STEEL	190.00
CASC-040-043	Snap Ultra Clamp 42-43mm	75mm	STEEL	240.00
CASC-047-050	Snap Ultra Clamp 48-49mm	75mm	STEEL	240.00
CASC-045-055	Ultra Clamp 45-55mm	150mm	PVC	630.00
CASC-059-067	Ultra Clamp 59-67mm	150mm	PVC	630.00
CASC-069-076	Ultra Clamp 69-76mm	150mm	PVC/AC/STEEL	660.00
CASC-087-093	Ultra Clamp 87-93mm	150mm	PVC/STEEL	740.00
CASC-095-104	Ultra Clamp 95-104mm	200mm	AC	893.00
CASC-104-113	Ultra Clamp 104-113mm	200mm	PVC	1136.00
CASC-121-130	Ultra Clamp 121-130mm	200mm	PVC/AC	1150.00
CASC-136-142	Ultra Clamp 136-142mm	200mm	PVC/STEEL	1180.00
CASC-150-161	Ultra Clamp 150-161mm	200mm	PVC	1246.00
CASC-165-176	Ultra Clamp 165-176mm	200mm	STEEL/AC	1300.00
CASC-174-183	Ultra Clamp 174-183mm	200mm	AC	1320.00
CASC-195-205	Ultra Clamp 195-205mm	200mm	PVC/AC	1340.00
CASC-229-238	Ultra Clamp 229-238mm	200mm	AC	1420.00
CASC-248-257	Ultra Clamp 248-257mm	300mm	PVC/AC	2470.00
CASC-258-288	Ultra Clamp 258-288mm	300mm	AC	2600.00
CASC-310-320	Ultra Clamp 310-320mm	300mm	PVC	2900.00

PVC Repair Couplings

(Moulded)

Code	Price
515COUP0630	160.00
515COUP0750	386.00
515COUP0900	420.00
515COUP1100	450.00
515COUP1600	980.00



E-Fusion Fittings

All Fittings in Pe100 SDR11 (PN 16)

Gas and water

Socket - 2110



Size	Price
25	110.00
32	116.00
40	125.00
50	170.00
63	205.00
75	300.00
90	350.00
110	450.00
125	590.00
140	750.00
160	824.00
200	1350.00
250	2800.00
315	4100.00



90° Elbow - 2111



Size	Price
25	240.00
32	260.00
40	326.00
50	390.00
63	460.00
75	625.00
90	825.00
110	1010.00
160	2550.00
200	4560.00
250	P.O.A
315	P.O.A

45° Elbow - 2116



Size	Price
40	290.00
50	340.00
63	430.00
75	640.00
90	840.00
110	1196.00
160	2340.00
200	P.O.A

Reducing Tee- 2122



Size	Price
25 x 20	294.00
32 x 25	294.00
40 x 25	333.00
40 x 32	333.00
50 x 32	442.00
50 x 40	442.00
63 x 32	490.00
63 x 40	490.00
63 x 50	490.00
75 x 50	660.00
75 x 63	660.00
90 x 40	914.00
90 x 50	914.00
90 x 63	914.00
90 x 75	914.00
110 x 40	1240.00
110 x 50	1240.00
110 x 63	1240.00
110 x 90	1240.00
160 x 63	2920.00
160 x 90	2920.00
160 x 110	2920.00
200 x 63	4990.00
200 x 90	4990.00
200 x 110	4990.00

Reducer - 2151



Size	Price
32 x 25	200.00
40 x 32	225.00
50 x 32	290.00
50 x 40	320.00
63 x 32	340.00
63 x 40	350.00
63 x 50	370.00
75 x 63	490.00
90 x 63	560.00
90 x 75	590.00
110 x 63	840.00
110 x 75	860.00
110 x 90	890.00
125 x 90	1220.00
160 x 90	1560.00
160 x 110	1590.00

End Cap - 2135



Size	Price
50	374.00
63	410.00
75	628.00
90	924.00
110	1180.00
160	2020.00
200	P.O.A

Tee - 2121



Size	Price
25	294.00
32	305.00
40	333.00
50	442.00
63	490.00
75	660.00
90	915.00
110	1240.00
160	2920.00
200	P.O.A

Butt Weld Fittings

All Fittings in SDR 17 Pe100 (PN 10)

Large Bore on Request

SDR 11 PE 100 PN 16 on Request

90° Elbow - 2010



Size	Price
50	92.00
63	134.00
75	204.00
90	266.00
110	446.00
125	654.00
140	911.00
160	1195.00
200	2100.00
250	3888.00
315	10000.00

45° Elbow - 2015



Size	Price
50	100.00
63	150.00
75	225.00
90	340.00
110	500.00
125	900.00
140	1000.00
160	1340.00
200	2100.00
250	3800.00
315	7200.00

Tee - 2020



Size	Price
50	125.00
63	250.00
75	360.00
90	510.00
110	790.00
125	1090.00
140	1835.00
160	2000.00
200	4100.00
225	5400.00
250	7150.00
280	12400.00
315	14150.00

Reducer



Size	Price
63 x 32	150.00
63 x 40	150.00
63 x 50	150.00
75 x 50	150.00
75 x 63	150.00
90 x 50	200.00
90 x 63	200.00
90 x 75	200.00
110 x 50	250.00
110 x 63	275.00
110 x 75	290.00
110 x 90	300.00
125 x 63	400.00
125 x 75	410.00
125 x 90	430.00
125 x 110	475.00
160 x 63	840.00
160 x 90	860.00
160 x 110	890.00
160 x 125	925.00
160 x 140	950.00
200 x 110	1340.00
200 x 125	1360.00
200 x 160	1390.00
225 x 160	1710.00
250 x 160	2140.00
250 x 200	2310.00
315 x 200	4940.00
315 x 250	4990.00

Reducing Tees also available

End Cap



Size	Price
50	60.00
63	64.00
75	72.00
90	120.00
110	210.00
125	314.00
140	450.00
160	590.00
200	1100.00
250	1600.00

Stub



Size	Price
50	72.00
63	75.00
75	94.00
90	100.00
110	124.00
125	128.00
140	166.00
160	200.00
200	260.00
225	280.00
250	394.00
280	476.00
315	655.00

Galv. Back.Ring



Size	HDPE /T.16
50	150.00
63	165.00
75	185.00
90	205.00
110	240.00
125	354.00
140	354.00
160	398.00
200	567.00
250	1064.00
315	1435.00

Male Adapter



Size	Price
50 x 1 1/2"	227.00
63 x 2"	264.00
75 x 2 1/2"	372.00
90 x 3"	480.00
110 x 4"	696.00

Polypropylene Socket Fusion

GOH 90° Elbow



Size	Price
20	50.00
25	60.00
32	72.00
40	93.00
50	160.00
63	200.00

MAH Socket



Size	Price
20	37.00
25	39.00
32	50.00
40	60.00
50	94.00
63	130.00

CAH Cap



Size	Price
20	44.00
25	45.00
32	53.00
40	64.00
50	84.00
63	115.00

QRH Stub serrated



Size	Price
20	50.00
25	54.00
32	64.00
40	72.00
50	85.00
63	108.00

GYH 45° Elbow



Size	Price
20	59.00
25	66.00
32	72.00
40	99.00
50	137.00
63	172.00

TIH 90° Tee



Size	Price
20	60.00
25	68.00
32	76.00
40	105.00
50	156.00
63	230.00

RCH Reducer double



Size	Price
25 x 20	47.00
32 x 20	58.00
32 x 25	58.00
40 x 25	70.00
40 x 32	70.00
50 x 32	86.00
50 x 40	86.00
63 x 32	110.00
63 x 40	110.00
63 x 50	110.00

FLH Loose flange
BS 4504



Size	Price
32	195.00
40	245.00
50	288.00
63	332.00
75	405.00
90	480.00
110	568.00
125	568.00
140	880.00
160	1000.00

BOH Union with O-ring



Size	Price
20	238.00
25	302.00
32	405.00
40	460.00
50	650.00
63	880.00

(Larger sizes in Butt Weld Available on Request)

General Properties:

Material : Homopolymer polypropylene (PP-H)
 Max. operating temperature : 100°
 Max. operating pressure : 10 bar at 20° (with water)
 Range (socket fusion) : 20 - 63 (110) mm; 1/4" - 2"

Adaptor Fittings

BOT Union F/F With stainless steel ring



Size	Price
20 x 1/2"	290.00
25 x 3/4"	320.00
32 x 1"	336.00
40 x 1 1/4"	525.00
50 x 1 1/2"	645.00
63 x 2"	878.00

MAT Socket F/F With stainless steel ring



Size	Price
20 x 1/2"	136.00
25 x 3/4"	152.00
32 x 1"	188.00
40 x 1 1/4"	220.00
50 x 1 1/2"	345.00
63 x 2"	430.00

NIEH Nipple



Size	Price
1/2"	64.00
3/4"	70.00
1"	98.00
1 1/4"	208.00
1 1/2"	230.00
2"	320.00

Check Valves

CVH Double union, metric socket fusion



Size	Price
20	690.00
25	768.00
32	834.00
40	1130.00
50	1224.00
63	1728.00

Industrial Ball Valves

BKH Double union, metricSocket fusion EPDM O-rings



Size	Price
20	690.00
25	820.00
32	994.00
40	1238.00
50	1612.00
63	1584.00

BKEH Double union, BSP threaded - EPDM O-rings



Size	Price
1/2"	750.00
3/4"	907.00
1"	1080.00
1 1/4"	1412.00
1 1/2"	1730.00
2"	2088.00

Polypropylene Pressure Pipes



Size	Price
20	29.00
25	45.00
32	65.00
40	84.00
50	132.00
63	200.00
75	280.00
90	400.00
110	594.00
125	770.00
140	958.00
160	1246.00

Valves can be fitted with electric or pneumatic actuators. Enquire for prices.

Standard = 5m length
PN 10 SDR 11

Other sizes and classes are available- please enquire



Please contact our sales staff about our range of welding machines.

Cam Lock Couplings



Suitable for couplings MIL-C-27487 Stainless Steel locking levers for maximum mechanical strength and corrosion resistance.
 Material used, (fiberglass-reinforced polypropylene), ensures excellent mechanical strength and good resistance against chemical agents.
 A tapered seat for the O'ring seal is fitted in the female threaded BSP versions.
 BSP threads. (NPT on request)
 Maximum working pressure: 1/2" to 2" = 9 bar. 3" = 5 bar.
 EPDM gaskets as standard. (Viton® and NBR on request)

Type	1/2"	Ø mm	3/4"	Ø mm	1"	Ø mm	1 1/4"	Ø mm	1 1/2"	Ø mm	2"	Ø mm	3"	Ø mm
A	181 03 A2		181 03 A		181 04 A		181 05 A		181 06 A		181 07 A		181 09 A	
B	181 03 B2		181 03 B		181 04 B		181 05 B		181 06 B		181 07 B		181 09 B	
C	181 03 C2	13	181 03 C	19	181 04 C	25	181 05 C	32	181 06 C	40	181 07 C	50	181 09 C	75
D	181 03 D2		181 03 D		181 04 D		181 05 D		181 06 D		181 07 D		181 09 D	
E	181 03 E2	13	181 03 E	19	181 04 E	25	181 05 E	32	181 06 E	40	181 07 E	50	181 09 E	75
F	181 03 F2		181 03 F		181 04 F		181 05 F		181 06 F		181 07 F		181 09 F	
G	—		181 03 G		181 04 G		181 05 G		181 06 G		181 07 G		181 09 G	
H	—		181 03 H		181 04 H		181 05 H		181 06 H		181 07 H		181 09 H	

A



**Male Adaptor
- Female Thread**

Size	Price
1/2"	19.00
3/4"	20.00
1"	22.00
1 1/4"	32.00
1 1/2"	35.00
2"	66.00
3"	99.00
4"	290.00

B



**Female Coupler
- Male Thread**

Size	Price
1/2"	85.00
3/4"	86.00
1"	100.00
1 1/4"	156.00
1 1/2"	160.00
2"	190.00
3"	266.00
4"	588.00

C



**Female Coupler
- Hose Fitting**

Size	Price
1/2"	85.00
3/4"	86.00
1"	100.00
1 1/4"	156.00
1 1/2"	160.00
2"	190.00
3"	266.00
4"	588.00

D



**Female Coupler
- Female Thread**

Size	Price
1/2"	85.00
3/4"	86.00
1"	100.00
1 1/4"	156.00
1 1/2"	160.00
2"	190.00
3"	266.00
4"	588.00

E



**Male Coupler
- Hose Fitting**

Size	Price
1/2"	19.00
3/4"	20.00
1"	22.00
1 1/4"	36.00
1 1/2"	37.00
2"	66.00
3"	103.00
4"	290.00

F



**Male Coupler
- Male Thread**

Size	Price
1/2"	19.00
3/4"	20.00
1"	22.00
1 1/4"	36.00
1 1/2"	37.00
2"	66.00
3"	103.00
4"	290.00

G



**Plug for
- Female Coupler**

Size	Price
3/4"	15.00
1"	18.00
1 1/4"	29.00
1 1/2"	30.00
2"	48.00
3"	66.00
4"	144.00

H



**Cap for
- Male Coupler**

Size	Price
3/4"	68.00
1"	85.00
1 1/4"	127.00
1 1/2"	140.00
2"	156.00
3"	190.00
4"	372.00

ARAG Filters

Specifications

Size	Filter Body	Cartridge Only	Body and Cartridge
3/4"	161.00	153.00	314.00
1"	175.00	173.00	348.00
1 1/4"	236.00	288.00	524.00
1 1/2"	348.00	288.00	636.00
2"	1545.00	485.00	2030.00
3"	2680.00	950.00	3630.40

For an easier choice of the most suitable filtering element, refer to the following table showing the different characteristics and the relevant colour code.

- Mesh = wire / inch (25.4mm)
- A = mesh opening
- ∅ = wire diameter
- S = percentage ratio between mesh opening surface and mesh total surface

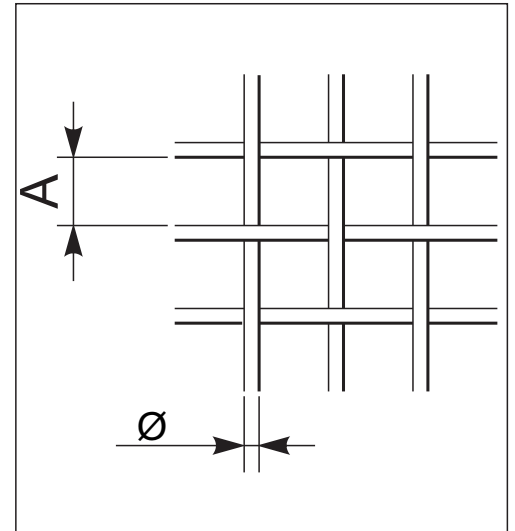

Mesh	A (microns)	S (%)	∅ (microns)	Material	Colour
50	365	50.8	140	Stainless	Blue
80	209	46.3	100	Stainless	Yellow
100	173	46.4	80	Stainless	Green
120	134	43	70	Polyester/Stainless	Grey

3/4" In - Line Filter, Series 323

Pressure line polypropylene filter external thread.

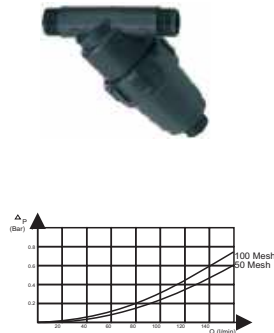
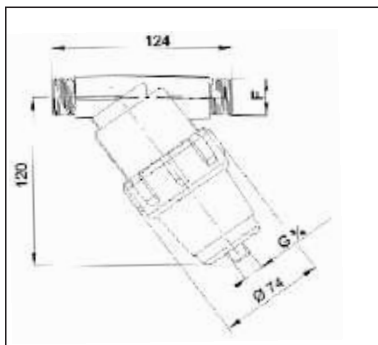

Code	Screen	Effective area	
		cm ²	sq. in.
323 333	Stainless 50 mesh	37	5.8
323 334	Stainless 100 mesh	34	5.3
323 335	Polyamm. 120 mesh	33	5.1

Max. Working pressure		12 bar
Cartridge (100 mesh)	Diameter	38mm
	Length	125mm
	Area	73cm ²
	Effective Area	34cm ²

1" In - Line Filter, Series 325

Pressure line polypropylene filter external thread.

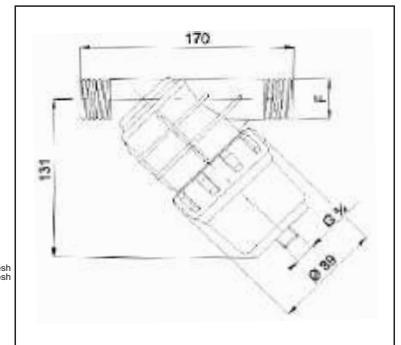
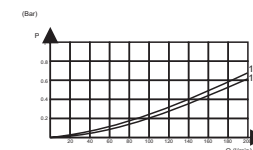

Code	Screen	Effective area	
		cm ²	sq. in.
325 143	Stainless 50 mesh	57	8.9
325 1435	Stainless 80 mesh	63	9.8
325 144	Stainless 100 mesh	52	8.1
325 145	Polyamm. 120 mesh	51	8.0

Max. Working pressure		10 bar
Cartridge (100 mesh)	Diameter	50mm
	Length	150mm
	Area	113cm ²
	Effective Area	52.5cm ²

1.1/4" In - Line Filter, Series 327

Pressure line polypropylene filter external thread.

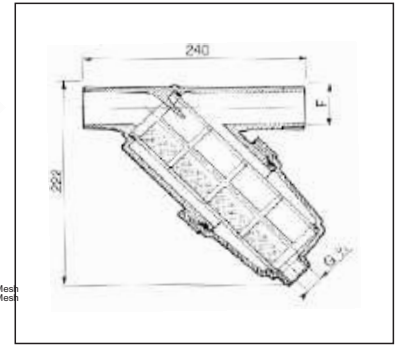
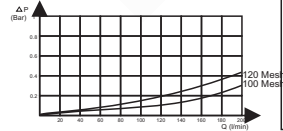
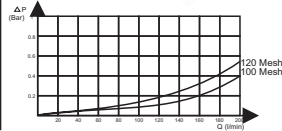
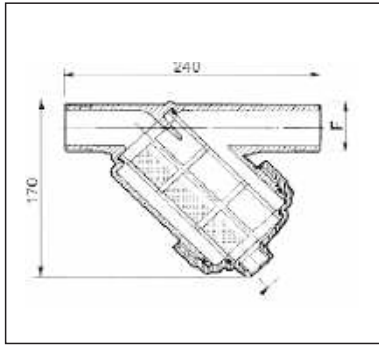

Code	Screen	Effective area	
		cm ²	sq. in.
327 053	Stainless 50 mesh	100	15.4
327 0535	Stainless 80 mesh	109	16.9
327 054	Stainless 100 mesh	91	14.1
327 055	Polyamm. 120 mesh	89	13.8

Code	Screen	Effective area	
		cm ²	sq. in.
329 063	Stainless 50 mesh	148	22.9
329 0635	Stainless 80 mesh	162	25.1
329 064	Stainless 100 mesh	135	20.9
329 065	Polyamm. 120 mesh	132	20.5

Max. Working pressure		10 bar
Cartridge (100 mesh)	Diameter	70mm
	Length	148mm
	Area	196cm ²
	Effective Area	91cm ²

Max. Working pressure		10 bar
Cartridge (100 mesh)	Diameter	70mm
	Length	220mm
	Area	291cm ²
	Effective Area	135cm ²

2" In - Line Filter, Series 333

In - line 800 l/min high rate filter used for irrigation, spraying and weeding.

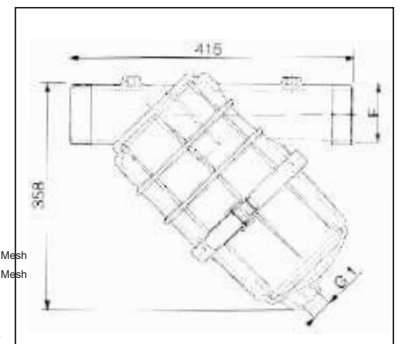
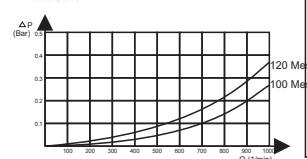
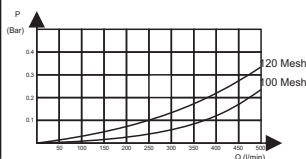
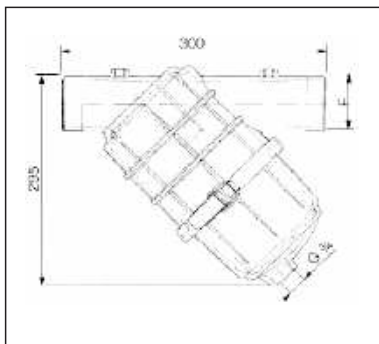

Code	Screen	Effective area	
		cm ²	sq. in.
333 073	Stainless 50 mesh	270	41.8
333 0735	Stainless 80 mesh	296	45.8
333 074	Stainless 100 mesh	246	38.2
333 175	Polyamm. 120 mesh	318	49.0

Code	Screen	Effective area	
		cm ²	sq. in.
335 093	Stainless 50 mesh	464	71.6
335 0935	Stainless 80 mesh	509	78.8
335 094	Stainless 100 mesh	424	65.7
335 195	Polyamm. 120 mesh	516	80.3

Max. Working pressure		8 bar
Cartridge (100 mesh)	Diameter	107mm
	Length	286mm
	Area	531cm ²
	Effective Area	247cm ²

Max. Working pressure		8 bar
Cartridge (100 mesh)	Diameter	145mm
	Length	320mm
	Area	913cm ²
	Effective Area	247cm ²

ARAG

1/2" In - Line Filter Series 324

- 1/2" BSP threads
- Filtering capacity 55 l/min to 0.5 bar
- Extractable and washable cartridge
- Fibreglass reinforced polypropylene body
- EPDM gaskets
- Max. working pressure 10 bar
- Stainless steel cartridge 0 27x69mm

R290.00



Code	F (BSP)	Opening		Effective area	
		Type	micron	cm ²	sq. in.
324 004	G1/2"	Mesh	100	21.5	3.3

Disk Filter 1" Series 325

- 1" BSP threads
- Filtering capacity 90 l/min
- Extractable and washable cartridge
- Polypropylene body. EPDM gaskets
- Max working pressure 10 bar
- Suitable for filtering inorganic impurities and for irrigation systems

R445.00

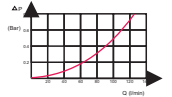

Code	F (BSP)	Opening		Effective area	
		Type	micron	cm ²	sq. in.
325 545	G1	Disc	130	204	31.6

Disk Filter 2" Series 334

- Reinforced fibreglass Nylon body
- Filtering capacity 48m³/hour
- EPDM Seals
- Threaded drain 1.1/4" female BSP
- Threaded plug 1.1/4" male BSP
- Twin connections for pressure gauge 1/4" female BSP
- Stainless Steel clamp
- Maximum working pressure 10 bar

4695.00

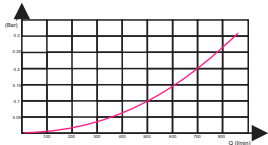

Code	F (BSP)	Opening		Effective area	
		Type	micron	cm ²	sq. in.
334 575	G2	Disc	130	2090	232.8

Disk Filter 3" Series 334

- Reinforced fibreglass Nylon body
- Filtering capacity 60m³/hour
- EPDM Seals
- Threaded drain 1.1/4" female BSP
- Threaded plug 1.1/4" male BSP
- Twin connections for pressure gauge 1/4" female BSP
- Stainless Steel clamp
- Maximum working pressure 10 bar

R6335.00

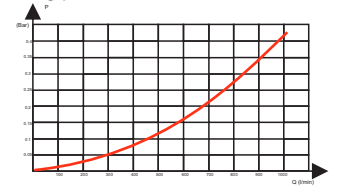

Code	F (BSP)	Opening		Effective area	
		Type	micron	cm ²	sq. in.
334 595	G3	Disc	130	2090	232.8

VALVE BOXES



Size	Price
6"	140.00
10"	310.00
12"	865.00
JUMBO	P.O.A.

3 PIECE FILTER HOUSING



- To fit Standard 10" cartridges
- 3/4" brass female connection
- Maximum working pressure 6 bar
- Minimum temperature -7 C
- Maximum temperature 35 C
- Maximum working pressure 6 bar

R330.00

micron	Standard filter cartridges	Price
20 micron	Wound thread filtering cartridge	70.00
20 micron	Cartridge with washable net	120.00
	With active coal	80.00
	Carbon Block	60.00

Pressure Gauges

	Ø = 63mm	F = 1/4	Price
	910 003	0 - 2.5 bar	230.00
	910 004	0 - 4 bar	230.00
	910 006	0 - 6 bar	230.00
	910 010	0 - 10 bar	230.00
	910 016	0 - 16 bar	230.00
	910 025	0 - 25 bar	230.00

Riser Pipes

Threaded

Length	15mm-1/2"	20mm-3/4"	25mm-1"
200mm	4.40	5.20	7.40
250mm	5.20	6.10	8.70
300mm	5.80	7.10	10.10
400mm	7.10	8.80	12.80
450mm	8.90	9.60	14.30
500mm	9.30	10.60	15.60
600mm	10.75	12.20	18.40
750mm	12.30	15.00	22.60
1000mm	15.10	19.10	30.00

Flexible Hose

I.D.	Thick Wall-Clear / Metre	Reinforced / Metre
12	30.00	35.00
16	32.00	46.00
20	42.00	63.00
25	60.00	102.00
32	99.00	162.00

Float Valves

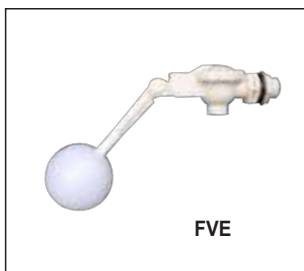

Size	Price
1/2"	160.00
3/4"	170.00
1"	239.00
1 1/4"	252.00
1 1/2"	480.00
2"	536.00

Wormdrive Hose Clamps



Stainless Steel - Band Housing and Screw

Code	Size	Price
4s	6 x 17	11.50
6s	10 x 22	19.20
8s	14 x 27	21.00
12s	14 x 32	21.50
16s	17 x 38	22.00
20s	19 x 44	23.10
24s	25 x 51	24.50
28s	32 x 57	25.80
32s	38 x 63	27.20
36s	44 x 70	28.40
40s	51 x 76	29.30



Composite - Galv. Band Housing and Screw

Code	Size	Price
4c	6 x 17	5.00
6c	10 x 22	5.60
8c	14 x 27	9.90
12c	14 x 32	10.25
16c	17 x 38	10.80
20c	19 x 44	11.80
24c	25 x 51	12.20
28c	32 x 57	13.40
32c	38 x 63	13.80
36c	44 x 70	14.25
40c	51 x 76	14.90

Layflat Hose

40mm - R40.00 per metre
50mm - R50.00 per metre

Offset Bends 40mm

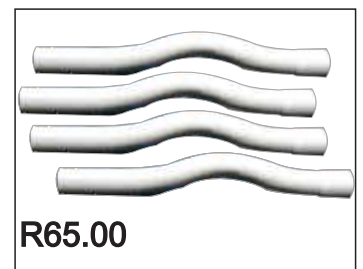

Polypropylene Fittings for L.D.P.E. Pipe

431/BC/pp

Insert coupling



Size	Pack	Price
12	100	1.40
15	100	1.80
20	50	3.00
25	50	3.30
32	25	6.80
40	20	7.20
50	10	9.85
65	5	25.30
80	5	31.50

432/BA/pp

Insert male adaptor



Size	Pack	Price
15	100	2.30
20	100	3.60
25	50	4.90
32	25	8.30
40	20	11.70
50	10	16.30
65	10	34.10
80	5	42.40

400/BN/pp

Barrel nipple

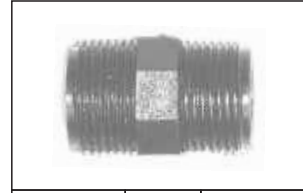

Size	Pack	Price
15	100	3.20
20	100	6.20
25	50	9.10
32	25	14.00
40	20	18.60
50	10	25.90

402/BN/pp

Socket

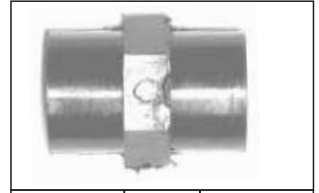

Size	Pack	Price
15	100	6.80
20	50	9.30
25	50	13.90
32	10	31.80
40	10	36.80
50	10	45.10

435/BR/pp

Insert reducing coupling



Size	Pack	Price
15 x 12	100	1.80
20 x 15	100	3.10
25 x 15	50	3.90
25 x 20	50	5.30
32 x 15	25	7.20
32 x 20	25	7.60
32 x 25	25	7.60
40 x 15	25	8.30
40 x 20	25	9.00
40 x 25	25	9.00
40 x 32	25	9.00
50 x 15	20	11.10
50 x 20	20	11.10
50 x 25	20	13.20
50 x 32	20	13.20
50 x 40	20	13.20
65 x 50	10	25.40
80 x 50	5	34.30
80 x 65	5	34.30

406/BA/pp

Male adaptor-reduced insert



Size	Pack	Price
15 x 12	100	1.80
20 x 12	100	4.50
20 x 15	50	4.50
25 x 20	25	5.20
32 x 25	20	8.40
40 x 32	10	16.30
50 x 40	10	23.30

Male adaptor-reduced thread

40 x 50	10	30.20
---------	----	-------

409/BJ/BAF/pp

Female adaptor



Size	Pack	Price
15	100	5.70
20	100	6.80
25	100	13.20
32	20	16.70
40	20	20.40
15L	100	8.70
20L	100	11.70

401/BN/pp

Reducing barrel nipple



Size	Pack	Price
20 x 15	100	5.90
25 x 15	50	8.90
25 x 20	50	9.50
32 x 25	25	14.60
40 x 32	10	19.90
50 x 40	10	26.80

408/BN/pp

Reducing Socket



Size	Pack	Price
20 x 15	100	9.20
25 x 15	50	12.10
25 x 20	50	12.40

FBN BLACK ABS

Acid Resisting Backnut



Size	Price
1/2"	23.00
3/4"	24.65
1"	33.00
1 1/4"	54.90
1 1/2"	61.15
2"	66.70

LRN BLACK ABS

120mm Running Nipple

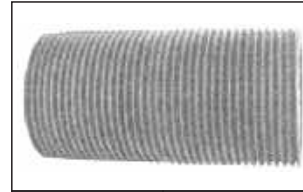

Size	Price
1/2"	29.90
3/4"	33.55
1"	43.00
1 1/4"	58.50
1 1/2"	64.35
2"	74.15

Gaskets

Size	Price
1/2"	4.90
3/4"	5.30
1"	5.60
1 1/4"	6.40
1 1/2"	6.80
2"	7.90

434/BE/pp

Insert elbow

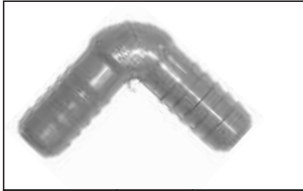

Size	Pack	Price
12	100	1.90
15	100	3.15
20	50	3.90
25	50	5.90
32	25	11.50
40	20	15.20
50	10	16.90
65	5	35.00
80	5	52.40

443/BM/pp

Insert male elbow



Size	Pack	Price
15	100	3.70
20	50	4.70
25	50	6.70
32	25	13.70
40	20	15.30
50	5	22.20

467/BM/pp

Insert male reducing elbow



Size	Pack	Price
15X20	50	7.10
15X25	50	11.00
20X25	50	11.00
40X50	10	25.90

436/BF/pp

Insert female elbow



Size	Pack	Price
15	100	7.50
20	50	7.60
25	20	11.20
32	20	21.60
40	20	25.60
50	10	32.50

447/BF/pp

Insert female reducing elbow



Size	Pack	Price
15X20	50	12.20
20X25	25	17.50
40X50	10	38.50

Wormdrive Hose Clamps**Stainless Steel - Band Housing and Screw**

Code	Size	Price
4s	6 x 17	11.50
6s	10 x 22	19.20
8s	14 x 27	21.00
12s	14 x 32	21.50
16s	17 x 38	22.00
20s	19 x 44	23.10
24s	25 x 51	24.50
28s	32 x 57	25.80
32s	38 x 63	27.20
36s	44 x 70	28.40
40s	51 x 76	29.30

BN 21/pp

Threaded male/female elbow



Size	Pack	Price
15	100	13.80
20	100	15.60
25	50	24.00

442/pp/GOE

Threaded elbow



Size	Pack	Price
15	10	16.50
20	10	19.80
25	5	23.10
32	5	39.60
40	5	80.30

441/BP/pp

Insert plug



Size	Pack	Price
15	100	1.50
20	100	1.90
25	50	2.70
32	50	3.50
40	25	5.70
50	20	8.10
65	10	16.20
80	5	22.20

BN 35

Female threaded cap



Size	Pack	Price
15	100	4.20
20	50	11.20
25	20	14.10
50	50	25.30

465/BS/pp

Threaded plug



Size	Pack	Price
15	100	2.10
20	100	3.10
25	50	3.90
32	25	7.40
40	20	11.40
50	10	11.70

433/BT/pp

Insert tee



Size	Pack	Price
12	50	3.20
15	50	4.50
20	25	6.70
25	25	8.10
32	20	18.70
40	10	21.85
50	10	28.40
65	5	46.30
80	5	58.30

444/BB/pp

Insert male tee



Size	Pack	Price
15	50	5.00
20	50	8.70
25	20	11.70
32	20	18.20
40	10	24.20
50	10	32.90

437/BV/pp

Insert female tee



Size	Pack	Price
15	50	7.60
20	50	8.80
25	20	12.40
32	20	23.50
40	10	29.20
50	10	37.60

439/pp/TIE

Female threaded tee



Size	Pack	Price
15	10	20.20
20	10	25.30
25	10	29.70
32	1	48.20
40	1	96.20
50	1	103.40

445/BB/pp

Insert male reducing tee



Size	Pack	Price
20 x 15	25	7.05
25 x 15	25	12.40
25 x 20	25	12.40
32 x 15	20	18.40
32 x 20	20	18.40
32 x 25	20	18.40
40 x 15	10	24.60
40 x 20	10	24.60
40 x 25	10	24.60
40 x 32	10	24.60
50 x 15	10	31.80
50 x 20	10	31.80
50 x 25	10	31.80
50 x 32	10	31.80
50 x 40	10	31.80

438/BV/pp

Insert female reducing tee



Size	Pack	Price
20 x 15	25	9.80
25 x 15	25	11.90
25 x 20	25	15.50
32 x 20	20	21.70
32 x 25	20	22.20
40 x 20	10	27.90
40 x 25	10	27.90
40 x 32	10	27.90
50 x 20	10	37.60
50 x 25	10	37.60
50 x 32	10	39.40
50 x 40	10	39.40

464/BN/pp

Reducing bush



Size	Pack	Price
20 x 15	100	5.10
25 x 15	50	7.20
25 x 20	50	7.90
32 x 15	25	11.20
32 x 20	25	11.20
32 x 25	25	11.20
40 x 15	20	15.40
40 x 20	20	16.40
40 x 25	20	17.50
40 x 32	20	17.50
50 x 15	20	22.80
50 x 20	20	22.80
50 x 25	20	22.80
50 x 32	20	22.80
50 x 40	20	22.80

439/BT/pp

Insert reducing tee



Size	Pack	Price
15 x 12	50	4.00
20 x 15	50	7.50
25 x 15	25	8.80
25 x 20	25	9.60
32 x 15	20	18.40
32 x 20	20	18.40
32 x 25	20	18.40
40 x 15	10	25.60
40 x 20	10	25.60
40 x 25	10	25.60
40 x 32	10	25.60
50 x 15	10	29.60
50 x 20	10	29.60
50 x 25	10	29.60
50 x 32	10	30.10
50 x 40	10	30.10

Dripper Fittings

403/pp

Drip Insert Coupling



Size	Pack	Price
12	50	1.40
16	50	1.80

404/pp

Drip Insert Tee



Size	Pack	Price
12	50	4.00
16	50	4.30

Nylomatic



Size	Price
1"	83.40

411/pp

Drip Reduced Insert Coupling



Size	Pack	Price
12/16	50	2.40

405/pp

Drip Enlarging Insert Tee



Size	Pack	Price
16x12x16	50	4.30

Nylomatic

Female Threaded Piplet



Size	Price
$\frac{3}{4}$ "	67.00

410/BDS/pp

Drip Irrigation Saddle



Size	Pack	Price
16 / 12	50	4.00
20 / 16	50	5.60

Nylomatic

Male Piplet



Size	Price
20	67.00

L.D.P.E. Poly Pipe

Utility Grade - Non - SABS

(For use with polypropylene and nylon fittings)

Price per 100 meter coil

Inside Diameter	15	20	25	32	40	50
Class 3	560.00	760.00	954.00	1130.00	1800.00	2950.00
Class 6	590.00	910.00	1560.00	2480.00	3480.00	5600.00

Pool, Spa & Koi Pumps

Porpoise Pumps



Pumps	Price
0.45kw - porpoise 10	4890.00
0.75kw - porpoise 16	5640.00
1.10kw - porpoise 22	6900.00

Badu Eco Touch

Power saving pump



Pumps	Price
0.75kw Speck Eco	16160.00

Speck Galaxy



Pumps	Price
0.75kw - galaxy 16	7150.00
1.1kw - galaxy 19	8150.00
1.5kw - galaxy 23	12190.00

Badu Spa Pumps



Pumps	Price
0.45kw - badu 45/11	4380.00
0.75kw - badu 45/16	4710.00
1.10kw - badu 45/20	5675.00

Speck Magic



Pumps	Price
0.25kw - badu magic 6	3995.00
0.45kw - badu magic 8	4584.00

Badu Resort



Pumps	Price
30.3~ Y/D 400/230 1.5kW	34200.00
40.3~ Y/D 400/230 2.2kW	42460.00
45.3~ Y/D 400/230 2.6kW	42830.00
50.3~ Y/D 400/230 3.0kW	45350.00
55.3~ Y/D 690/400 4.0kW	62100.00
60.3~ Y/D 400/230 2.6kW	43200.00
70.3~ Y/D 400/230 2.6kW	42000.00
80.3~ Y/D 690/400 4.0kW	57080.00
110 .3~ Y/D 690/400 5.5kW	64870.00

Speck Picco



Pumps	Price
0.2kw Speck Picco	3940.00

Pro Pump



GFCP

Pool Pumps	Price
0.37kw GFCP-370s	3000.00
0.55 kw GFCP-550s	3500.00
0.75kw GFCP-60s	5000.00
1.10 kw GFCP-70s	6000.00
1.50kw GFCP-80s	8500.00



GAUTO

Booster Pumps	Price
0.75kw Gauto 100-s	4800.00



GJS100

Jet Pumps	Price
0.75kw GJS-100	4500.00



GWQD S

Drainage Pumps	Price
0.37kw GWQD2-5	3900.00
0.37kw GWQD3-5	3870.00
0.60kw GWQD6-7	5000.00
0.60kw GWQD7-8	5500.00
1.00kw GWQD13-9	6000.00
1.20kw GWQD15-7	7500.00
2.00kw GWQD15-10	8500.00



GPM

Peripheral Pumps	Price
0.37kw GPM-60	3000.00



GCP

Centrifugal Pumps	Price
0.75kw GCP-158	3900.00
1.10kw GCP-180	7000.00
1.50kw GCP-200	8400.00

Submersible Pumps & Pond Equipment

B.I.C.S.A

Submersible Pumps



Model	Q. Max	H.max	Price
Sub.Pump 400	400 litre / hour	0.8m	475.00
Sub.Pump 600	600 litre / hour	1.0m	528.00
Sub.Pump 1000	1000 litre / hour	1.6m	795.00
Sub.Pump 1400	1400 litre / hour	2.0m	1062.00
Sub.Pump 2000	1400 litre / hour	1.8m	1062.00
Sub.Pump 2500	2000 litre / hour	2.5m	1395.00
Sub.Pump 3500	3000 litre / hour	3.5m	2185.00
Sub.Pump 4500	4500 litre / hour	4.5m	2888.00
Sub.Pump 5500	6800 litre / hour	5.5m	3890.00



Model	Kw	Q. Max	H.max	Price
LP 20	17w	22 litre / hour	2.2m	2600.00
LP 40	35w	50 litre / hour	2.8m	4100.00
LP 60	50w	70 litre / hour	3.5m	4600.00
LP 100	100w	140 litre / hour	4.0m	6500.00



Model	Q. Max	H.max	Price
WFB-200	2000 litre / hour	0.9m	990.00



Model	Q. Max	Price
WFK- FOAM	S/S Foam Nozzle	12m ³ /4" 2000.00

Waterfall

Submersible Pumps



SP mini's

Model	Kw	Q. Max	H.max	Price
WSP -600	5w	260 litre / hour	0.5m	280.00
WSP-650	5w	300 litre / hour	0.8m	300.00



FLOW PUMP

Model	Kw	Q. Max	H.max	Price
WF 400	5w	400 litre / hour	0.9m	395.00
WF 700	10w	700 litre / hour	1.2m	1250.00
WF 1000	17w	1000 litre / hour	1.8m	1620.00
WF 1500	20w	1500 litre / hour	2.0m	2950.00
WF 2400	35w	2400 litre / hour	2.3m	2450.00
WF 4000	70w	4000 litre / hour	2.8m	2990.00
WF 6000	130w	6000 litre / hour	3.8m	4120.00
WF 8500	230w	8500 litre / hour	5.0m	5880.00



PG SEA-LION

Model	Kw	Q. Max	H.max	Price
PG 8000	200w	8000 litre / hour	7.0m	4290.00
PG 10000	250w	10000 litre / hour	9.0m	5400.00
PG 12000	160w	12000 litre / hour	4.5m	5500.00
PG 15000	200w	15000 litre / hour	5.0m	5700.00
PG 18000	250w	18000 litre / hour	6.0m	6000.00



FOUNTAIN KIT

Model	Q. Max	Price
WF-KIT-1	1500 litre / hour	200.00
WF-KIT-2	6000 litre / hour	400.00

Pool, Spa & Koi Filters

Speck Roto Filters

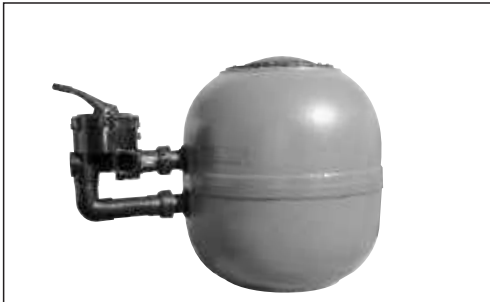

S.F.	Side Mount Roto Filters	Price
2B Aqua	Speck 2 bag	5100.00
3B Aqua	Speck 3 bag	5400.00
4B Aqua	Speck 4 bag	5900.00
7B Aqua	7 bag jumbo	17500.00
S.F.	Koi Roto Filters	Price
1B Koi	1 bag	4085.00
2B Koi	2 bag	5580.00
3B Koi	3 bag	6010.00
4B Koi	4 bag	6200.00
S.F.	Top Mount Roto Filters	Price
B/Tec 1B	1 bag	3680.00

Filter Medium

SFM		Price
Sand Egga	Pool Filter Sand	200.00
Koi Sand	Koi Filter Sand	200.00
Anthracite	Anthracite [various grades]	POA
Eco Glass	Recycled Glass Media	POA

Please note: the prices for sand and salt are fetch and carry only. Please speak to sales department about charges on bulk deliveries

Badu Eco Wise Filter



S.F.	Badu Eco Wise Filter	Price
	BADU Eco Wise 1	2740.00
	BADU Eco Wise 2	2970.00
	BADU Eco Wise 3	3515.00
	BADU Eco Wise 4	4100.00

Cartridge	Price
BADU Eco Wise 1 refill	887.00
BADU Eco Wise 2 refill	955.00
BADU Eco Wise 3 refill	1065.00
BADU Eco Wise 4 refill	1280.00

Pool & Spa Fittings

90° Elbow



Code 13

Size	Price
50	7.20
32	5.00
25	4.40
20	4.00

Straight Con.



Code 15

Size	Price
50	6.00
32	4.30
25	3.70
20	2.50

Tee



Code 18

Size	Price
50	11.70
32	6.60
25	5.30
20	4.80

45° Elbow



Code 14

Size	Price
50	11.00
32	5.00

Adaptor

O.D. 50mm x 2" Male Th.code 17
I.D. 50mm x 2" Male Th.code 27



Code 27

Code 17

Size	Price
50 OD x 2"	11.80
50 ID x 2"	11.80

End Cap



Code 25

Size	Price
50	7.20
32	4.80

Union



Size	Price
50 x 1 1/2"	49.00
50 x 2"	49.00

Multi Step Hose Tail



Z.HOSE TAIL

Size	Price
50 to 16mm	48.00

Adaptor

O.D. 50mm x 1 1/2" Male Th.code 16
I.D. 50mm x 1 1/2" Male Th.code 26



Code 16

Code 26

Size	Price
50 OD x 1 1/2"	11.80
50 ID x 1 1/2"	11.80

Adaptor

I.D. 50mm x 1 1/2" Female Thread



Code 29

Size	Price
50 ID x 1 1/2"	11.80

Hose Adaptor

ID. 50mm PVC to 50mm poly code 22
ID. 50mm PVC to 40mm poly code 23



Code 22

Code 23

Size	Price
50 x 50	11.80
50 x 40	11.80

Standard Weir

S. Weir	Weirs	Price
Gun. Wit	Gunite Weir - White	884.00
Gun. Blk	Gunite Weir - Black	884.00
Liner Wit	Liner Weir - White	1040.00
Liner Blk	Liner Weir - Black	1040.00



Aimflo



S.AIM

Size	Price
Black	85.00
White	85.00

Spa Jets



SP.SPAJET

Size	Price
50x32	198.00

Spa Bottom Drain

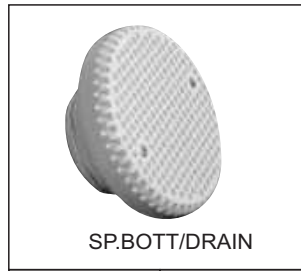

SP.BOTT/DRAIN

Size	Price
50	60.00

Bottom Drain



S.B/D

	Price
with Hydrostatic Valve	950.00
no Hydrostatic Valve	872.00

Pool Valve

Compact-Solvent weld
- 50mm Code.CHD



CHD0500

Size	Price
50	73.00

Flapper Check Valve



UNI.FLAP

	Price
50	30.00

Pool Non Return Valve

Single Union-Solvent weld 50mm



VRIS0500

Size	Price
50	378.00

Pool Valve

Single Union-Solvent weld 50mm



SVD050/10

Size	Price
50	190.00

Led Lights



	Complete	Retro Fit	Vinyl comp.
Spektralight Aqua 400	7760.00	7420.00	7760.00
Spektralight Aqua 150	3200.00	2620.00	3250.00
Spektralight Aqua 50 blue	1450.00	1222.00	1480.00
Spektralight Aimflow Blue	736.00	456.00	
Spektralight Aimflow Colour	760.00	520.00	
Spektralight Control Box & Switch	800.00		
Remote Control	860.00		
Bellows Switch	120.00		

Z.VRIVCLEAR



Size	Price
50	680.00

Standard Light



S.Light	Lights	Price
Eco.Gun. Wit	Gunite light - White - LED	1160.00
Eco.Gun. Blk	Gunite light - Black - LED	1160.00
Eco.Liner Wit	Liner light - White - LED	1230.00
Eco.Liner Blk	Liner light - Black - LED	1230.00

Non SABS Pipe

16	Blue / White	8.80
20	Blue / White	9.00
25	Blue / White	12.00
32	Blue / White	18.00
40	White	20.00
50	White	40.00
50	Black	60.00

450 Curved

	130.00
--	--------

Stainless Steel Brush

	145.00
---	--------

Leaf Skimmer

	Aluminium	160.00
	Plastic	175.00

Leaf Rake

	Aluminium	195.00
	Plastic	225.00

Vacuum Brush

	270.00
---	--------

8 Wheel Sweeper

	305.00
---	--------

Multiport Valves

	MPV Complete	930.00
	MPV Top Only	495.00

Automatic Pool Cleaners



Simple Vacuum Head

	120.00
--	--------

Vacuum Cleaner spas, ponds

	165.00
--	--------

S.K.K.	Kreepy Krauly	Price
Combi PA	Kreepy Krauly Kombi Pack	4500.00
Rep Mach	Kreepy Krauly Machine Only	3020.00
	Replacement Hose 1.2m	190.00

Telescopic Poles

SC Tel/Ple		Price
0.2	Telescopic Poles 1.0 to 2.0m	250.00
0.3	Telescopic Poles 1.3 to 3.0m	330.00
0.4	Telescopic Poles 2.0 to 4.0m	420.00

S.K.K.	Speck	Price
	Badu PAC including hoses	1800.00

Distribution Box

Dist Box Ext	External Distribution Box with extra plug	2285.00
--------------	---	---------

Solar Panels



S.Solar	1.2 x 3 meters	1350.00
---------	----------------	---------



Salt Water Chlorinator

S.S / Chlo	BADU Logic	Price
BADU 50	50kl self cleaning	12750.00
BADU 75	75kl self cleaning	14900.00
BADU 100	100kl self cleaning	15400.00
BADU 150	150kl self cleaning	17500.00
	Salt 25kg	110.00

Coverbox



		Price
S. Coverbox	Filter & Pump Cover 0.9m	3665.00
S. Coverbox	Filter & Pump Cover 1.1m	5920.00

Koi Food

Aquamaster

Small = 3mm Large = 6mm

1	Growth	Small	1kg	155.00
2	Growth	Small	5kg	665.00
3	Growth	Small	10kg	1162.00
4	Growth	Large	1kg	155.00
5	Growth	Large	5kg	665.00
6	Growth	Large	10kg	1162.00
7	Staple	Small	1kg	118.00
8	Staple	Small	5kg	535.00
9	Staple	Small	10kg	940.00
10	Staple	Large	1kg	118.00
11	Staple	Large	5kg	535.00
12	Staple	Large	10kg	940.00
13	Wheat Germ	Small	1kg	162.00
14	Wheat Germ	Small	5kg	730.00
15	Wheat Germ	Small	10kg	1325.00
16	Wheat Germ	Large	1kg	162.00
17	Wheat Germ	Large	5kg	730.00
18	Wheat Germ	Large	10kg	1325.00
20	Premium Blend	Small	5kg	806.00
23	Premium Blend	Large	5kg	806.00

A 5kg Premium Blend bucket consist of 1 kg of Colour Enhancer, 1 kg Growth Enhancer, 1kg Staple, 1kg Wheat Germ plus 1kg of either Staple or Wheat Germ

25	Colour Enhancer	Small	1kg	184.00
26	Colour Enhancer	Small	5kg	855.00
27	Colour Enhancer	Small	10kg	1580.00
28	Colour Enhancer	Large	1kg	184.00
29	Colour Enhancer	Large	5kg	855.00
30	Colour Enhancer	Large	10kg	1580.00

Koi Life

Medium = 3-4mm Large = 8mm

Staple	Med/Large	1kg	120.00
Staple	Med/Large	2kg	225.00
Staple	Med/Large	5kg	560.00
Staple	Med/Large	20kg	2180.00
Growth	Medium / Large	1kg	187.00
Growth	Medium / Large	2kg	337.00
Growth	Medium / Large	5kg	788.00
Growth	Medium / Large	20kg	3000.00
Wheat Germ	Medium / Large	1kg	160.00
Wheat Germ	Medium / Large	2kg	292.00
Wheat Germ	Medium / Large	5kg	660.00
Wheat Germ	Medium / Large	20kg	2280.00

Pond Chemicals

Algae Control -Koi Life	200g / 20 000lt	132.00
Algae Control -Koi Life	1kg / 100 000lt	600.00
Bio Boost -Koi Life	250g / 50 000lt	56.00
Bio Boost -Koi Life	2kg / 200 000lt	270.00



UV Clarifiers

Go to www.ultrazap.co.za for more information



Low Pressure u.v. Clarifiers for Ponds

Z.UV	Pond Clarifiers	Price
CLAR - 8w	8 Watt - 6000lt	1440.00
CLAR - 15w	15 Watt - 15000lt	1650.00
CLAR - 30w	30 Watt - 30000lt	1860.00
CLAR - 55w	55 Watt - 50000lt	2460.00

Professional u.v. with Quartz Sleeve

Z.UV	Pond Clarifiers	Price
CLAR-P-8w	8 Watt	1950.00
CLAR-P-15w	15 Watt	2310.00
CLAR-P-30w	30 Watt	2940.00
CLAR-P-55w	55 Watt	3330.00
CLAR-P-55w	55 Watt Stainless Steel	12300.00

Replacement Tubes

Z.UV		Price
TUBE 8w	8 Watt tubes	435.00
TUBE 15w	15 Watt tubes	525.00
TUBE 30w	30 Watt tubes	675.00
TUBE 55w	55 Watt tubes	915.00

Gravity Filters



Gravity Feed Filters, Complete with Bio Balls, Foam Set & UV Light

Z.Filt	Filters	Price
+ UV - 15L	8 Watt / 15 Litre for 1200L pond	2760.00
+ UV - 25L	8 Watt / 25 Litre for 4000L pond	3420.00

Gravity Feed Filters with Bio Balls, Foam Set, without UV Light

Z.Filt		Price
- UV - 15L	15 Litre for 1200L pond	1905.00
- UV - 25L	25 Litre for 4000L pond	2865.00



Bottom Drains



Z.B/D		Price
Gully 50	Gunite 50mm outlet	630.00
Gully Lin	Liner 50mm outlet	930.00
Comp 250	Gunite 110mm outlet	840.00
250 Liner	Liner 110mm outlet	1125.00
Dome 250	250mm Dome only	215.00
Conver	Gully Drain Conversion	540.00
B/D DIFFUSER	B/D Diffuser 110mm	3270.00

Bio Filters



Bio Filters (excludes media)

Z Filt		Price
BIO 5L	5 Litre - (75 Bio Balls) 2500L	1155.00
BIO 10L	10 Litre - (125 Bio Balls) 5000L	1275.00
BIO 15L	15 Litre - (175 Bio Balls) 7000L	1785.00
BIO 25L	25 Litre - (335 Bio Balls) 12000L	1905.00
BIO 50L	50 Litre - (670 Bio Balls) 24000L	2430.00
BIO BALL	Bio Balls	5.70

Combo Filters (excludes media)

Z Filt		Price
Combo 5L	8 Watt / 5L Combo- 2500L	2640.00
Combo 10L	15 Watt / 10 L Combo- 5000L	2970.00
Combo 25L	15 Watt / 25L Combo -12000L	3600.00

Brushes



Z.Filt	Filter Brushes	Price
Brush 1	400 x 200	165.00
Brush 2	800 x 200	345.00
Brush 3	1200 x 200	525.00
	Spawning Brush	
Spawning	600 x 150	216.00
Spawning	2000 x 150	600.00

Vacuum

Z.Vacuum	Pond Vacuum-Manual	Price
		1290.00

Air Stones

Z.Air Stone	50mm	Price
		85.00

Hose Tails

Z.HoseTail	50mm	Price
		48.00

Spares

Z.Filt	Replacement foam	Price
Rep-Foam	25mm yellow foam	21.00
Rep-Foam	50mm yellow foam	43.50
Rep-Whit	White gauze	21.00

Z.Filt	Filter Lids	Price
	Bio Filter lid	225.00
	Bio Filter Lid O'Ring	66.00
	Gravity Filter Lid	150.00

Z.UV	Complete Electrics for uv light	Price
	8, & 15 watt	630.00
	30 watt	675.00
	55 watt	900.00

Protein Skimmer

		Price
	Foam fractionator 250mm w/o pump	5120.00
	Foam fractionator 400mm with pump	P.O.A.

Venturi



Z.Ven		Price
25mm	25mm	290.00
50mm	50mm	300.00

Nets



Z.Net	Pond Nets	Price
R. Small	Small Round-500mm	675.00
R. Large	Large Round-750mm	945.00
O. Small	Small Oval-600x300mm	675.00
O. Large	Large Oval-800x500mm	945.00
	1 meter Diameter Round	1200.00
Sock	Sock Net	645.00
Drag	Drag Net 6 x 2m	6900.00
Handle 1M	1 metre handle	150.00
Handle 2M	2 metre handle	300.00

Bubble Bead Filter

	Bubble Bead	Price
	2 bag c/w blower + media	18750.00
	3-4 bag c/w blower + media	19200.00
	25kg Bag Beads	2850.00

Leaf Traps and Primers

		Price
Leaf Trap	50mm in line Leaf Trap	1155.00
	63mm in line Leaf Trap	1155.00
	50mm Primer	1425.00
	63mm Primer	1425.00
	50mm in-line 250dia Leaf Trap	2376.00
	63mm in-line 250dia Leaf Trap	2376.00
	110mm in-line 250dia Leaf Trap	3630.00

GENERAL CONDITIONS OF SALE

1. TERMS AND CONDITIONS

- 1.1 Subject to the conditions of 1.2 below, **EFFAST**; ("the seller"), conducts business only upon and subject to the terms and conditions printed below which shall be deemed to have been accepted by the PURCHASER and to be incorporated in any order received or accepted by the SELLER to the exclusion of all other terms.
- 1.2 Where the PURCHASER orders or confirms an order for goods from the SELLER on an order form which such PURCHASER'S standard conditions of purchase apply and particularly stipulates that such standard conditions of purchase shall apply as between the SELLER and the PURCHASER then and only in such event the contracts shall be governed both by the PURCHASER'S standard conditions of purchase and by these conditions of sale on the basis in the event of any conflict between the two provision of these standard conditions of sale shall prevail.

2. TIME FOR DELIVERY

- 2.1 Any time or date stipulated by the SELLER for delivery is intended as an estimate only and the SELLER shall not be liable in any way whatsoever for any loss or damage whatsoever which may result from non-delivery of the goods by the time or date so stipulated nor shall any such delay confer upon the PURCHASER any right to rescind the contract or any right to refuse to accept the goods ordered.
- 2.2 If any of the SELLER'S obligations in terms of this contract shall be prevented, hindered or interfered with by any reason of any industrial dispute or by reason of any cause whatsoever beyond the SELLER'S reasonable contract, the SELLER shall have the right to suspend or cancel the contract without prejudice to the SELLER'S right to recover all monies owing to the SELLER as at date of suspension or cancellation.
- 2.3 Without prejudice to the generality of the foregoing where the SELLER is unable to make delivery of goods ordered in the quantities ordered, whether through unavailability of stock or otherwise, the balance shall, subject to the PURCHASER'S approval, be placed on back order for later delivery. Thereafter no such back order may be cancelled or varied by the PURCHASER without the SELLER'S prior approval.
- 2.4 Where the goods have been ordered but have not yet been delivered, the PURCHASER may not cancel the order for any reason whatsoever except with the SELLER'S prior written approval, which may be given on such terms and conditions as the SELLER may deem fit. Such conditions may include but shall not be limited to the PURCHASER paying in full any expenses incurred by the SELLER in procuring the goods, including but not limited to freight and clearance charges, import duties and railage and/or, where the goods are not normally stocked by the SELLER, the cost of returning such goods to the point of original supply.

3. DELIVERY RISK AND OWNERSHIP

- 3.1 Where the order stipulates that the goods are to be delivered to the PURCHASER:
 - 3.1.1 the price quoted by the SELLER shall include delivery of the goods by the SELLER to such address as may be stipulated by the PURCHASER in the order, provided always that such delivery address is within the SELLER'S free delivery area of, Durban and Cape Town. In all other cases goods shall be despatched F.O.R., Durban or Cape Town at the SELLER'S discretion.
 - 3.1.2 risk in the goods shall pass to the PURCHASER forthwith upon delivery of the goods to the PURCHASER in terms of clause 3.1.1 above; and
 - 3.1.3 where payment in full in respect of the goods has been received by the SELLER on or prior to delivery, ownership of the goods shall pass on delivery. In all other cases ownership in the goods shall not pass to the PURCHASER until the SELLER receives payment in full for the goods.
- 3.2 Where the contract stipulates that the goods are to be despatched to the PURCHASER on an F.O.R basis:
 - 3.2.1 the price quoted by the SELLER shall not include delivery and all arrangements in respect of delivery should be made by the PURCHASER.
 - 3.2.2 the risk in the goods shall pass to the PURCHASER when the goods are handed to the first carrier for delivery to the PURCHASER;
 - 3.2.3 where payment in full in respect of the goods has been made by the PURCHASER on or prior to delivery to the first carrier as aforesaid ownership in such goods shall pass to the PURCHASER at such time. In all other cases ownership in the goods shall not pass to the PURCHASER until the SELLER receives payment in full for such goods.
- 3.3 Unless otherwise specified, prices quoted are on an F.O.R basis and clause 3.2 shall apply.
- 3.4 All demurrage charges will be for the PURCHASER'S account.
- 3.5 Except for goods not correctly supplied to the PURCHASER in terms of the order (otherwise than as contemplated in 2.3) goods may not be returned to the SELLER for any reason whatsoever except with the SELLER'S prior written approval and goods accepted for return by the SELLER will be subject to an administration charge of R10.00 (Ten Rand) or 15% (fifteen percent) of the purchase price of such goods, whichever is the greater, such charge to be paid by the PURCHASER to the SELLER forthwith on demand.

4. DAMAGE, SHORTAGE OR LOSS IN TRANSIT

- 4.1 The SELLER shall not be liable for any discrepancies in the order unless the PURCHASER shall have given to the SELLER written notice thereof within 7 (seven) days of receipt of the goods and shall thereafter afford the SELLER a reasonable opportunity of inspecting the goods before they have been used, processed or sold by the PURCHASER.
- 4.2 Where the delivery is on an F.O.R. basis the SELLER accepts no responsibility whatsoever for any damage, shortage or loss in transit.
- 4.3 Where the contract provides for delivery to the PURCHASER the SELLER does not accept responsibility for any damage, shortage or loss in transit unless such goods are inspected by the PURCHASER at the time of delivery and any damage, shortage or loss brought to the attention of the SELLER'S delivery man and the delivery note is suitably endorsed. No claims for damage, shortage or loss will be accepted by the SELLER when the PURCHASER has accepted the goods but has endorsed the delivery note "NOT CHECKED" or similarly indicated that goods may be checked at a later date.

5. DEFECTS AND EXCLUSION OF CONSEQUENTIAL LOSS

- 5.1 The SELLER will take all reasonable care to ensure that the goods sold are of good quality and workmanship but the SELLER does not guarantee the suitability of such goods for any particular purpose and the PURCHASER must satisfy himself as to the suitability of the goods for the purpose of which he requires them.
- 5.2 Any goods which are returned to the SELLER within one month from the date of despatch of such goods by the SELLER and which are admitted by the SELLER to be defective in workmanship or materials will at the SELLER'S option be replaced free of charge or credited at invoice value.
- 5.3 Save as provided in 5.2 above, the SELLER shall have no liability whatsoever in respect of any defect in the goods whether of workmanship or material or otherwise and in particular and notwithstanding anything to the contrary herein contained the SELLER shall not be liable for any damages whether arising directly from any defects in the goods sold nor shall the SELLER be liable in any way whatsoever for loss of profits or consequential damage.

6. PRICE VARIATION

Unless otherwise stated in writing, prices, charges and discounts allowed will be those ruling at the time of despatch of the goods. The SELLER reserves the right at any time to raise the price quoted without notice in the event of any alteration taking place between the date of quotation and the date of delivery of goods in respect of costs of materials, labour, energy, carriage, currency exchange parities, customs duty, taxes or any other costs having a bearing on the price.

7. PAYMENT

Unless otherwise specifically agreed to in writing, all accounts are payable within 30 (thirty) days after date of statement and prices are nett with no deductions or discounts. Any sum not paid on the due date will at the SELLER'S option bear interest from day to day at BANK Prime Rate until paid.

8. TERMINATION OF CONTRACT

The SELLER shall be entitled, without prejudice to any other rights or remedies available in law or otherwise, either to terminate the contract wholly or in part or to suspend any further deliveries under the contract or under any other contract between the SELLER and the PURCHASER in any of the following events:

- 8.1 if any monies due and payable by the PURCHASER to the SELLER remains unpaid for 30 days calculated from due date of payment; or
- 8.2 if the PURCHASER has failed to provide within the time specified by the SELLER any letter of credit, bills of exchange or other security required by the SELLER in terms of the contract; or,
- 8.3 if the PURCHASER has failed to take delivery of any goods under the contract otherwise than in accordance with the PURCHASER'S contractual rights and obligations; or
- 8.4 if the PURCHASER becomes insolvent or in the case of a body corporate a resolution is passed for its winding up or an order of the court for its winding up is made or a judicial manager or receiver is appointed or in the case of an individual partnership such individual or any partner is adjudicated bankrupt or payment of such person's debts is suspended in whole or in part or such person convenes a meeting or enters into any composition or arrangement with his creditors.

9. LEGAL JURISDICTION

The PURCHASER consents to the SELLER having the right to institute any legal proceedings which may arise out of or in connection with this contract in any Magistrate's Court in the Republic of South Africa having jurisdiction in respect of the PURCHASER notwithstanding that the claim or the value of the matter in dispute may otherwise exceed the jurisdiction of such Court.

10. APPLICABLE LAW

This contract shall in all respects be construed in accordance with the LAW of the Republic of South Africa.

11. REPRESENTATIONS AND WARRANTIES

Subject to the provisions of clause 1.2 above the order as read with these conditions constitutes the whole of the contract between the parties and the SELLER shall not be bound by any statements or representations on the part of the SELLER or any of the SELLER'S employees or agents otherwise than as are set out in the contract.