

Planning Guide: Designing a Compliant Centralized Mailbox Installation

Course Number EX407
Saturday, April 29, 2017; 9:15 – 10:15a
Learning Units 1.00 LU

A'17 AIA Conference on Architecture 2017
April 27–29, Orlando

Today's Presenter: Donna Logback, Florence Corporation



Ms. Logback has been a centralized mailbox and delivery products expert for over 10 years. Working to provide online tools which make it easier for architects to include this Section 10 specialty in their designs, she also develops materials to help navigate the often confusing postal and accessibility specifications. Ms. Logback enjoys researching industry trends and interviewing design and construction professionals to incorporate discovered insights into the next generation production solutions.

A'17 AIA Conference on Architecture 2017
April 27–29, Orlando

2

Planning Guide: Designing a Compliant Centralized Mailbox Installation

Credit earned on completion of this course will be reported to **AIA CES** for AIA members. Certificates of Completion are available upon request.

This course is registered with **AIA CES** for continuing professional education. As such, it does not include content that may be deemed or construed to constitute approval, sponsorship, or endorsement by the AIA of any method, product, service, enterprise or organization. The statements expressed by speakers and other participants reflect their own views and do not necessarily reflect the views or positions of The American Institute of Architects, or of AIA components, or those of their respective officers, directors, members, employees, or other organizations, groups or individuals associated with them.

Questions related to specific products and services may be addressed at the conclusion of this presentation.

Copyright

This presentation is protected by US and International Copyright laws. Reproduction, distribution, display and use of the presentation without written permission of the speaker is prohibited.

© Florence Corporation 2017



Learner Outcomes

At the end of this course, participants will be able to:

- 1) State the mailbox installation specification differences between the U.S. Postal Service (USPS), American with Disabilities Act (ADA) and Fair Housing Act (FHA).
- 2) Specify the correct centralized mail delivery equipment to meet mailbox and parcel locker requirements as it relates to USPS specifications and accessibility requirements.
- 3) Identify the components within a centralized mailbox installation that must meet ADA, FHA/ANSI and USPS accessible design standards.
- 4) Outline at least one design strategy based on accessibility standards for residential centralized mail delivery equipment.

Course Content

• Introduction to Centralized Mail Delivery	8
• Centralized Mail Delivery Equipment	17
• 4C Mailbox Installation Specifications	38
• Meeting ADA	30
• The Role FHA Plays	37
• Intersection of Compliance	47
• Package Locker Compliance	57
• Other Space Considerations	69
• Summary	74
• Q & A	76

Disclaimer

Before we get started. . .

- This course covers just the basics. It is not intended to be comprehensive. The only way you are going to get a comprehensive understanding of accessibility for multi-family housing is to read the actual documents in their entirety and apply them to your projects.
- We are not experts in the field of accessibility. Learning all the applicable detailed accessibility regulations takes ongoing study and experience; but we do know mailboxes and how to find the answers to obtain appropriate approvals.
- What we hope you will gain today is a broad working knowledge of accessibility requirements for multi-family and where to go for the more detailed information when you need it.

Let's begin!

7



INTRODUCTION TO CENTRALIZED MAIL DELIVERY

8

Centralized Mail Delivery

Mail and package delivery can be traced back to its system founder and first Postmaster, Benjamin Franklin.

Since that time, the amount of new delivery points for mail and packages has steadily increased from year to year with a 5-year average of ~1 million new delivery points a year.



As the mail delivery system and the type of mail being delivered have evolved, so too have the residential requirements for efficient boxes that meet the growing delivery demand.



9

Centralized Mail Delivery

Centralized mail delivery provides delivery and collection services to a number of residences from a centrally located installation.

The U.S. Postal Service now specifies centralized mail delivery in nearly all new construction for both single and multifamily residential, and in commercial and institutional properties because it is the most efficient method of providing the best service.



10

Centralized Mail Delivery

Centralized mail delivery equipment can be in the form of any "clustered" type mailbox – including the free-standing, pedestal-mounted cluster box unit (CBU), or other cluster mailboxes mounted on or in a wall.



Equipment wasn't always standardized, nor as secure, so being aware of current specifications and requirements is vital.



The USPS governs the equipment specifications and dictates the current equipment rating, referred to as a Standard (STD) that must be used.

11

Centralized Mail Delivery

The USPS created guidelines to dictate that wall-mounted vertical or horizontal wall-type boxes are to be specified in multi-family settings.

To represent the various levels of "approval" by the USPS, these wall-mounted mailboxes have been "rated".

Former approval standards were considered STD-4B+ and related to specific form factors and security levels of the mailbox.



12

Centralized Mail Delivery



Current USPS specifications related to wall-mounted, clustered type of mailboxes were introduced in 2004.

These were the first changes to “apartment style” mailboxes in more than 30 years.

This specification, referred to as STD-4C, replaces all previous specifications for centralized mailboxes, which were previously approved under STD-4B and STD-4B+.

13

Centralized Mail Delivery

The USPS STD-4C specification enhances security requirements for the entire mailbox receptacle.

It requires:

- heavier metal materials for construction
- improved tenant lock design, and
- larger compartment form factor:
Min size of 12”w × 15”d × 3”h
to accommodate today’s larger mail types and sizes



The new specification also eliminates the vertical form factor design.

14

Centralized Mail Delivery

- All manufacturers build to the same USPS specifications for the minimum on their product, but some take the specifications a step further.
- Enhancing the cam on the specified lock to be heavier-duty to reduce break-ins is a prime example of improving on the base specification.



Consider these factors when specifying “or equal” in your projects.

15

Centralized Mail Delivery

- Finding manufacturers who have met all the rigorous standards and testing to achieve “USPS Approved” status is essential.
- The USPS publishes the approved mail receptacles and approved manufactures list annually as the list does change from time to time.
- List is available every May from the *Postal Bulletin*.



16



CENTRALIZED MAIL DELIVERY EQUIPMENT

17

Design Benefits of STD-4C



19 mailboxes



15 mailboxes-1 parcel



4 mailboxes-1 parcel



9 mailboxes



2 parcels

The modular design of STD-4C mailbox systems makes it easier to create wall-mounted layouts that fit your project.

Outgoing mail slots are required in each 4C module - this means they can be used as stand-alone mailbox units or in multi-module layouts.

18

Standard 4C Mailboxes are Versatile

- Modules available in varying heights to maximize available space
- Modular design accommodates 3-29 mail compartments per unit
- Standalone collection boxes, parcel lockers and trash/recycling bin modules also available



19

Standard 4C Mailboxes – Compartment Options

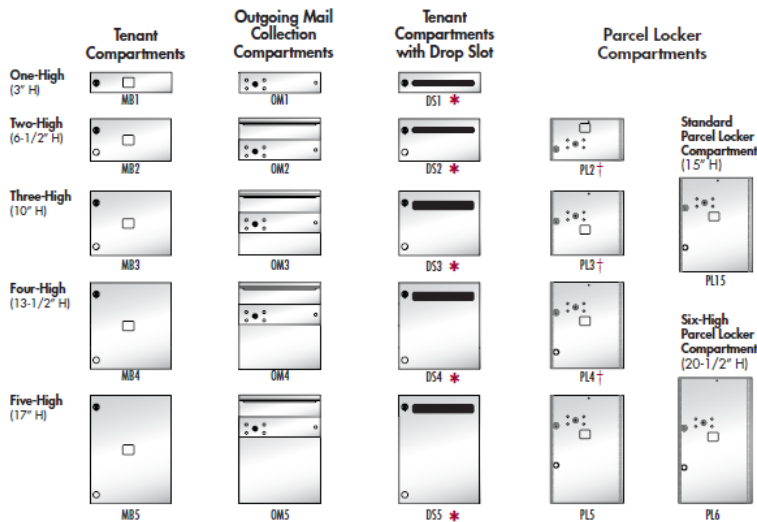

* For Private Delivery, Not USPS Approved
Slot Dimensions: 1/2" H or 1" H x 9-5/8" W

† For Private Delivery, unless parcel locker ratio exceeds requirement - see below for full details

20



4C MAILBOX INSTALLATION SPECIFICATIONS

21

Mailbox Installation Heights

Mailrooms must comply with

- United States Postal Service 4C guidelines (STD-4C)
- Postal Operations Manual (POM)
- Americans with Disability Act (ADA)
- Fair Housing Act (FHA), ANSI 117.1
- International Building Code (IBS)
- Local Amendments



22

USPS Guidance re: Location of Mailboxes

- Must be the safest and most efficient locations for equipment, so the following factors come into play:
 - Carriers' line of travel
 - Customer and carrier safety
 - Equipment security
 - Customer accessibility, including sufficient turnaround space and access for customers with disabilities
- Indoor mailboxes should be installed close to entrances
 - Carriers must be able to access the mailboxes without interference from swinging doors
- Outdoor mailboxes may not be installed directly on the street or a public sidewalk
 - Wherever possible, there should be protection from the weather and adequate nighttime lighting

Postal Operations Manual, Section 632.6

23

USPS Min/Max Installed Height Requirements

1. At least one customer compartment shall be positioned less than 48 inches above the finished floor.
2. No patron (tenant) lock shall be located more than 67 inches above the finished floor.
3. The USPS Arrow lock shall be located between 36 and 48 inches above the finished floor.

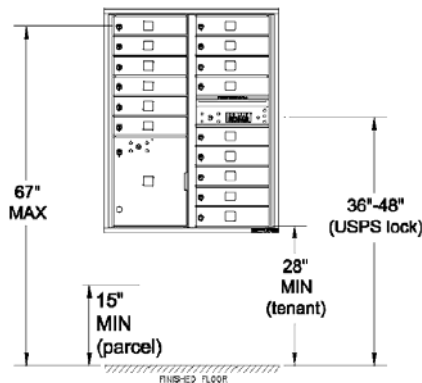

Lock height is measured to the center of the lock for reach ranges.

Installation/Layout Instructions Specified in USPS STD-4C – pages 53821-53832 of the referenced USPS 4C Standard "Notes" section

24

USPS Min/Max Installed Height Requirements

4. No parcel locker compartment (interior bottom shelf) shall be positioned less than 15 inches from the finished floor.
5. No customer compartment (interior bottom shelf) shall be positioned less than 28 inches from the finished floor.

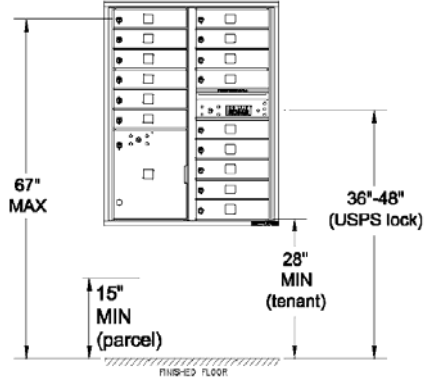

Installed height is not measured from the outside trim, but the bottom of the lowest door (compartment shelf).

Installation/Layout Instructions Specified in USPS STD-4C – pages 53821-53832 of the referenced USPS 4C Standard "Notes" section

25

USPS Min/Max Installed Height Requirements

Bottom compartment type in unit determines mounting height

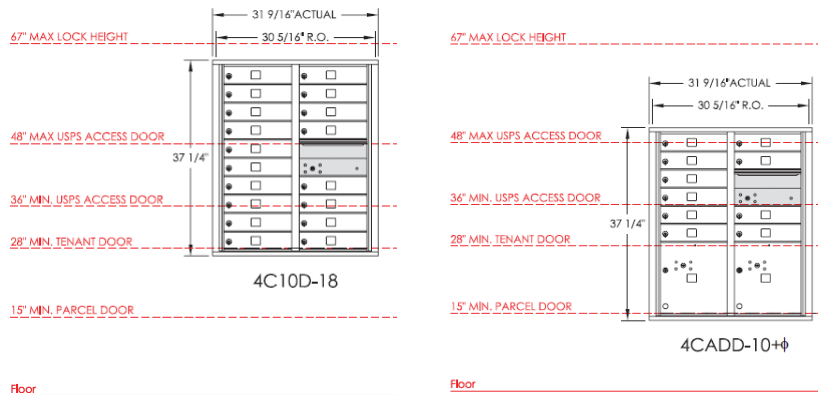

26

USPS Min/Max Installed Height Requirements

At what minimum height can each of these modules be installed and still comply with USPS specifications?



15" or 28" above
the finished floor?



15" or 28" above
the finished floor?



15" or 28" above
the finished floor?

27

USPS Min/Max Installed Height Requirements

At what minimum height can each of these modules be installed and still comply with USPS specifications?



28"



28"



15"

28

USPS Min/Max Installed Height Requirements

Summary of USPS Compliance for Postal Specialties

- Installation heights 15"– 67" for all units with Parcel Lockers on lowest row
- Installation heights 28"- 67" for units with mail compartments on lowest row
- At least one customer compartment must fall below 48"



29



MEETING ADA

30

About **2 in 10** adults live with a **disability**



How Common are Specific Disabilities?

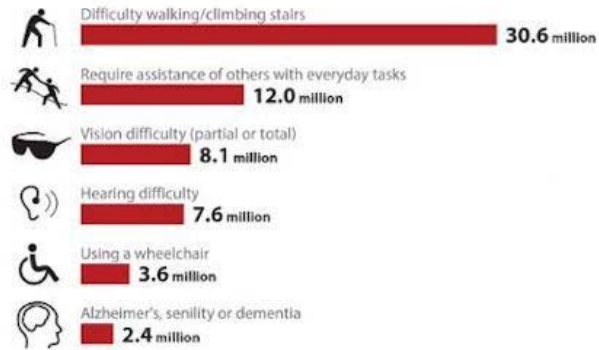

United States
Census
Bureau

U.S. Department of Commerce
Economics and Statistics Administration
U.S. Census Bureau
census.gov

Source: Americans with Disabilities:
2010, from Survey of Income and
Program Participation

31

US Census Disability Stats

Nearly 40M people,
or 12.6% of population,
have a disability

Accessibility – ADA

For interior mailrooms, the ADA specifies that at least 5% of the mailboxes must meet accessibility guidelines.

Local regulations may override this percentage and require 100% compliance.

Typically, it is the local jurisdiction codes office/inspector that will designate if an installation must meet only the min ADA requirement of 5% or if it should be 100% compliant.



ADA Standards, Section 228.2

32

Accessibility – ADA

Current practice is to use sequential numbering on the mailboxes, rather than matching identification to the apartment numbers.



This improves security and privacy, but also allows greater flexibility in providing accessible mailbox compartments to meet the 5% specification.

33

Accessibility – ADA

Mailboxes must comply with Section 309 specifications governing a location's clear floor space, equipment height, and operation.

Forward reach range:
An accessible mailbox must be no lower than 15" and no higher than 48" from the finished floor

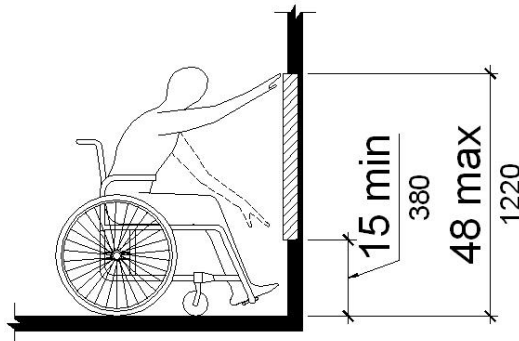

ADA Standards, Chapter 3, 309, Reach Ranges; (Note: These ranges differ from USPS regulations)

34

Accessibility – ADA

Mailboxes must comply with Section 309 specifications governing a location's clear floor space, equipment height, and operation.

Side reach range:

An accessible mailbox must be no lower than 15" and no higher than 48" from the finished floor as measured from a clearance of 10" from the installation wall

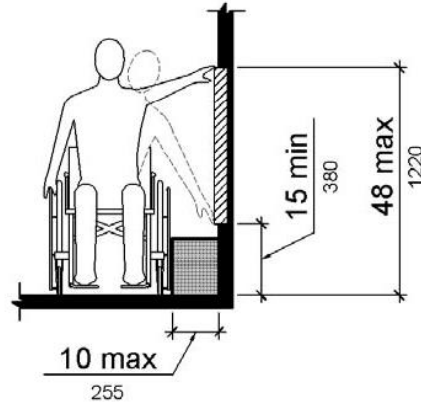

ADA Standards, Chapter 3, 309, Reach Ranges; (Note: These ranges differ from USPS regulations)

35

Accessibility – ADA

Summary of ADA Compliance for Postal Specialties:

- Installation heights 15" – 48" for 5% of all mailboxes
- Local city inspectors could require 100%



36



THE ROLE FHA PLAYS

37

FHA vs. ADA



The purpose of the Fair Housing Act (FHA) is to provide certain classes of people with equal access to housing and to the facilities and services associated with housing.

The FHA also governs private communities and, therefore, affects the operation of *all* community associations.

Although both ADA and FHA are federal Civil Rights Acts that were created to provide protected classes with equal access to public and private housing and public accommodations, there are fundamental differences between them.

Whiteford Taylor Preston, LLP: Understanding and Contrasting the ADA and FHA

38

FHA vs. ADA

- The FHA was enacted in 1968 to outlaw discrimination in public and private housing and related facilities and services based on race, color, religion, sex, and national origin. It was amended in 1988 to include familial status and disability.
- The ADA was adopted in 1990 to ensure equal opportunity for individuals with disabilities, and protect them in part from discrimination in the use and enjoyment of places identified as public accommodations.



Windsor Compliance: A Multifamily Perspective on the Americans with Disabilities Act (ADA) & Fair Housing Act (FHA) 39

Fair Housing Act (FHA)

The Fair Housing Act design and construction requirements apply to “covered multifamily dwellings” designed and constructed “for first occupancy” after March 13, 1991.



- Covered multifamily dwellings are:
 - All dwelling units in buildings containing four or more dwelling units if the buildings have one or more elevators AND
 - All ground floor units in other buildings containing four or more units, without an elevator.
- It also includes condominiums and apartment buildings, time-shares, dormitories, transitional housing, homeless shelters that are used as a residence, student housing, assisted living housing, and others like structures.

Fair Housing Accessibility FIRST, a training and technical guidance program created by the U.S. Department of Housing and Urban Development (HUD) by The BearingPoint Team.

40

Fair Housing Act (FHA)

The original construction guidelines are called the Fair Housing Accessibility Guidelines and contain seven requirements. An update was published in 1998 and includes the following:

- Requirement 1 – Accessible building entrance on an accessible route
- Requirement 2 – Accessible and usable public and common use areas
- Requirement 3 – Usable doors
- Requirement 4 – Accessible route into and within the dwelling unit
- Requirement 5 – Light switches, electrical outlets, thermostats and other environmental controls in accessible locations
- Requirement 6 – Reinforced walls for grab bars
- Requirement 7 – Usable kitchens and bathrooms

41

Fair Housing Act (FHA) and ANSI

Requirement 2 – *Accessible and usable public and common use areas* cover all parts of the housing outside the individual living units.

They include: building-wide fire alarms, parking lots, storage areas, indoor and outdoor recreational areas, lobbies, **mailrooms and mailboxes**, and laundry areas.



The Guidelines establish ANSI as a minimum standard of compliance when designing Public and Common Use areas.

Fair Housing Accessibility FIRST, a training and technical guidance program created by the U.S. Department of Housing and Urban Development (HUD) by The BearingPoint Team.

42

Fair Housing Act (FHA) and ANSI

Since ANSI does not provide a standard specifically for mailboxes, designers must consult the related human factors and performance specifications to design the accessible features.

Sections of such specifications in ANSI include:

- 4.2 - Space allowances and reach ranges
- 4.3 - Accessible route
- 4.4 - Protruding objects



43



Accessibility – Fair Housing Act (FHA) and ANSI

For mailboxes to be compliant with FHA Requirement #2, they must be within the reach ranges specified by ANSI:

- Forward approach: 48” maximum, 15” minimum (same as ADA)
- Side approach: 54” maximum, 9” minimum (differs from ADA and USPS)

44

Fair Housing Act (FHA) and ANSI

Requirement #1 – Accessible Routes for ANSI 4.4, Protruding Objects, also provides specifications for protruding objects located along walks, corridors, and other passageways. Examples of wall hung objects that must not protrude more than 4” when located between 27” and 80” above finish floor include:

- Fire extinguisher cabinets
- Mail boxes
- Large, ornate picture frames
- Light fixtures
- Wall mounted water fountains
- Wall mounted telephones

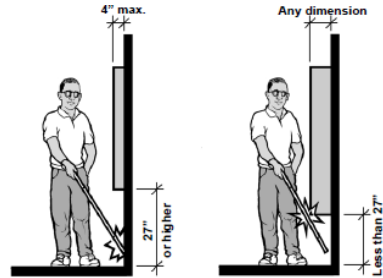

Objects mounted lower than 27” above finish floor may protrude any amount as long as the minimum clear width of an accessible route is maintained.

Fair Housing Accessibility FIRST, a training and technical guidance program created by the U.S. Department of Housing and Urban Development (HUD) by The BearingPoint Team.

45

Fair Housing Act (FHA) and ANSI

Summary of FHA (ANSI) Compliance for Postal Specialties:

- Installation heights 15” – 54” for all mailboxes
- May be surface mounted only if units have Parcel Lockers







46



INTERSECTION OF COMPLIANCE

47

FHA vs. ADA

ISSUE DISTINCTION	FHA	ADA
 Who is protected?	The FHA protects a broader class of individuals from discrimination based on race, sex, religion and other class attributes.	The ADA prohibits discrimination only for individuals with disabilities in employment, public accommodations, transportation, state and local government services, and telecommunications.
 Private Housing vs. Public Accommodations	The FHA affects both public and private housing for protected classes.	The ADA is limited in scope to public accommodations, and does not cover a property's dwelling units.
 Accessibility	The FHA requires certain accessibility features but does not require retrofitting for properties constructed prior to March 13, 1991.	The ADA requires certain accessibility features, and ongoing updates and modifications when readily achievable.
 Enforcement	The Department of Justice, city and county human rights commissions, state and local fair housing boards, and the Department of Housing and Urban Development all enforce FHA compliance.	Only the Department of Justice enforces ADA compliance.

Windsor Compliance: A Multifamily Perspective on the Americans with Disabilities Act (ADA) & Fair Housing Act (FHA) 48

Meeting Both FHA and ADA

- In those cases where a development is subject to the accessibility requirements of more than one federal law, the accessibility requirements of each law must be met.
 - There are certain residential properties, or portions of other residential properties, that are covered by both the Fair Housing Act and the ADA. These properties must be designed and built in accordance with the accessibility requirements of both the Fair Housing Act (ANSI) *and* the ADA.
- To the extent that the requirements of different federal laws apply to the same feature, the requirements of the law imposing greater accessibility requirements must be met, in terms of both scoping and technical requirements.

Joint Statement Of The Department Of Housing And Urban Development And The Department Of Justice Accessibility (Design And Construction) Requirements For Covered Multifamily Dwellings Under The Fair Housing Act 49

Min / Max Reach Requirements Overview

Agency	Forward Min	Side Min	Forward Max	Side Max
USPS Mailbox	28"	28"	67"	67"
USPS Parcel Locker	15"	15"	67"	67"
ADA	15"	15"	48"	48"
FHA	15"	9"	48"	54"

- To meet all installation specifications, plan for mailbox modules that fit between 28" – 48" from finished floor
- Modules with both mailboxes and parcel lockers can be installed between 15" – 48" from finished floor

50

Meeting Local Codes

Accessibility regulations and local building codes may vary.

ALWAYS consult local building code authorities and USPS personnel for applicable codes and installation specifications related to your project, PRIOR to final mailbox specification, selection and installation.



51

Selecting 48" Max Height Compliant Mailboxes

- Many STD-4C modules may be USPS Approved even though they do not meet all ADA and FHA regulations.
- All STD-4C modules offer compartments within the module that will meet all the necessary regulations.
- Be sure to double check each module selected against the regulation you are working with to ensure your project is compliant.



52

Selecting 48" Max Height Compliant Mailboxes

- Most manufacturers have a line of module heights that maximize all three agency regulations; but smaller heights modules will also work.
- Due to limitations on STD-4C heights - designs may require additional wall width to accommodate the necessary number of mailbox openings.



53

Selecting 48" Max Height Compliant Mailboxes

Partial Compliance vs. 100% Compliant with 48" Max Height
 Space Needed for 63 Mailbox Compartments



54

Selecting 48" Max Height Compliant Mailboxes

Not all heights are considered equal...

- Dimensionally, the mailbox modules may be the same height
- Placement of the postal lock may make the installation different

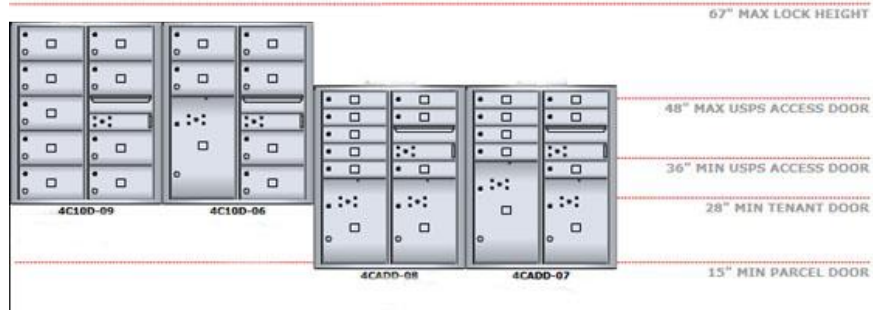

55

Selecting 48" Max Height Compliant Mailboxes

Summary of 100% Compliance for Postal Specialties:

- Installation heights 15" – 48" for all mailboxes
- May be surface mounted only if units have Parcel Lockers



56



PACKAGE LOCKER COMPLIANCE

57

Standard 4C Mailboxes – Parcel Lockers

To address the growing package delivery volumes while reducing the number of re-delivery attempts, the USPS began specifying built-in parcel lockers for all centralized mail delivery equipment in 2006.



58

Parcel Lockers Add Convenience

These oversized parcel compartments allow USPS carriers to actually deliver larger packages instead of leaving a delivery attempt notice, saving residents trips to the Post Office®.



59

Parcel Lockers Add Convenience

Parcel lockers are extremely convenient for the residents as they can:

- Receive their mail and packages in one secure location 24/7
- Handle 95% of USPS Priority Mail package sizes so the resident doesn't have to go to the Post Office to retrieve their packages



60

USPS Parcel Locker Options

USPS Parcel Lockers can be either conveniently built into the mailbox module. . .

. . .or installed as standalone modules



61

Secure Shared USPS Parcel Lockers Maximize Space

The unique feature of these parcel lockers is the special key trapping lock which ensures

- the package is only retrieved by the person it is meant for, and
- makes delivery easy and efficient for the postal carrier, whose keys won't get lost or stolen.



62

STD-4C Regulation Parcel Locker Requirements

When the USPS established the current STD-4C mailbox requirements in 2006, they included a *minimum* of one (1) 15" parcel locker for every 10 individual mailboxes installed (1:10 ratio).



63

Selecting Approved Parcel Lockers

- To satisfy the USPS STD-4C 1:10 parcel locker to mailbox ratio requirement, parcel lockers (PL) must meet a minimum compartment height of 15".
- If the total number of PL in the mailbox installation exceeds the 1:10 requirement, smaller PL may also be included.
- Be sure to note PL height when utilizing only one 4C module type in your entire installation as not all built-in lockers are 15" and may require the addition of parcel only modules just to meet the 1:10 requirements.

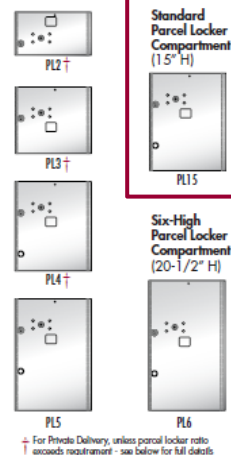

64

Update Recommendations to Accommodate Growth

Since the USPS STD-4C parcel locker requirements were established in 2006, online sales have more than doubled, making it vital that planning for package delivery using parcel lockers take this growth into consideration.

Online Sales (\$ Billions)

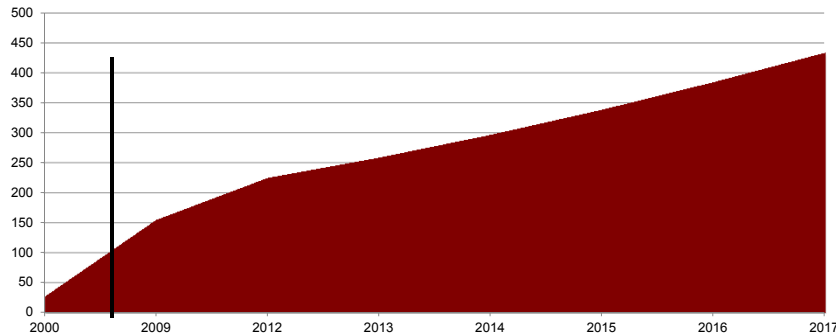

Source: Forrester Research

65

Packages & Apartment Communities

The numbers for multifamily alone are staggering:

An average sized apartment community of 250 units can receive up to 20,000 packages per year...

...or over 50 packages per day!



¹ Sources: 2014 NMHC study on package management

66

Modernized Package Receptacle Recommendations

Based on the 100% increase in package volumes since the STD-4C was established, a 1:6 ratio of parcel lockers to mailboxes is more in line with current package volume trends.



67

Modernized Package Receptacle Recommendations

Increasing the 1:10 ratio to 1:6 could be as easy as adding some standalone parcel lockers.



1:10
36 MB, 4PL = 5' 3-1/8"



1:6
36 MB, 7PL = 6' 8-5/8"

68



OTHER SPACE CONSIDERATIONS

69

Mail and Package Delivery Equipment Space

- The size of multifamily mail and package delivery areas have not kept up with the increase in package quantities being delivered or changes to equipment size.
- The National Multifamily Housing Council (NMHC) states the current average space necessary for a *package holding area (only)* is 77 square feet.



70

Mail and Package Delivery Equipment Space

When planning a mail and package delivery area, be sure to include sufficient space for:

- Equipment
- Accessibility/turn-around
- Carrier carts
- Open module doors with multiple residents in area



71

Mail and Package Delivery Equipment Space

Be sure to include consideration for any commercial areas that might need larger mail compartments and/or an oversized collection box.



72

Mail and Package Delivery Equipment Space Planning

Manufacturers have BIM objects and online configurators available to take the guesswork out of designing a mail and package delivery area by providing you space requirements.

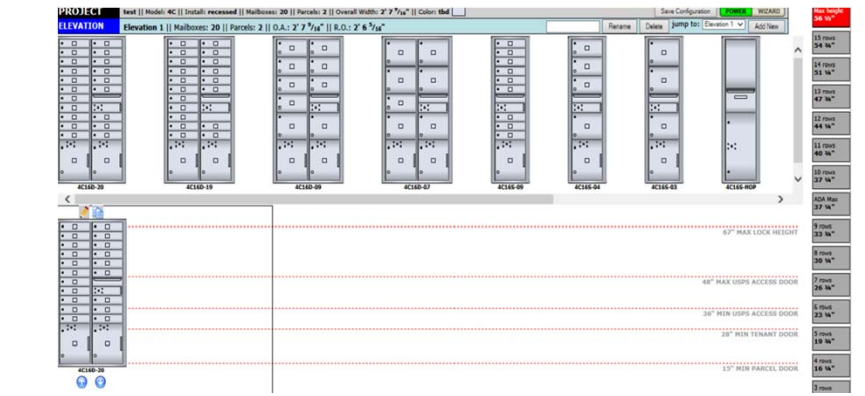

73

Summary

Keep in mind the following tips to plan early for a successful mail and package room design:

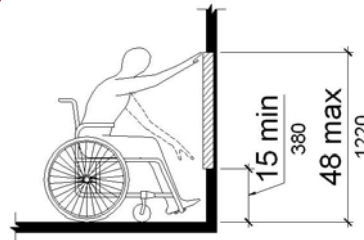

- Centralized mail delivery is now required in all new construction.
- Centralized 4C mailboxes take more space than older mailboxes.
- USPS specifications include mailbox installation between 15" – 67".
- ADA calls for 5% compliance for reach ranges between 15" – 48".
- FHA/ANSI has reach ranges between 9" – 54" and applies to properties with more than four dwellings or with an elevator.
- When designing for all three, use the most stringent rules 15" – 48".

74

Summary. . .Continued

- Consider mail/package room location and layout to maximize resident convenience and carrier efficiency.
- Provide ample space for equipment used for package management including room for package handling.
- USPS requires 1:10 parcel locker/mailbox ratio, but current trends suggest 1:6 is more practical.
- Package lockers must be a min of 15" tall; once 1:10 ratio is met can include smaller lockers.
- Package lockers may be installed 15" above the finished floor while units with compartments in the bottom are installed at 28".



75

Questions?

*This concludes The American Institute of Architects
Continuing Education Systems Course*

Donna Logback
Florence Corporation
dlogback@florencecorporation.com
785-323-4539



Thank you for your time today!