



PLASTIC BELT CONVEYOR

SECTION CONTENT

Straight

Curve

Optional Equipment and Devices

PBC PLASTIC BELT CONVEYOR



WHY PBC?

- No belt tracking required
- Modular belting is easily replaceable for one section or an entire belt
- Many belt styles and designs to choose from for your application
- Backed by the support of Intralox®, the largest plastic belt supplier worldwide
- Common types of belt include flat top, friction flat top, inline roller top, transverse roller top and flush grid
- Common applications include transportation, washdown, accumulation and many other applications due to the versatility of the product line

PLASTIC BELT CONVEYOR - STRAIGHT

END DRIVE

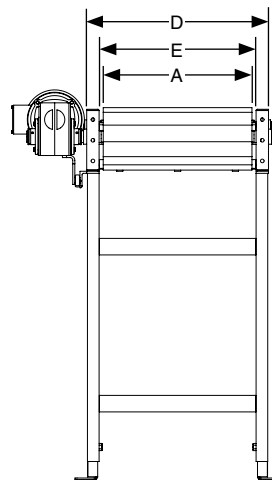
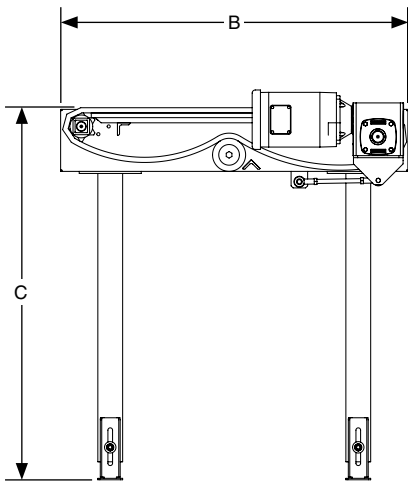

A	2" - 144"
B	3' - 100'
C	8" - 60"
D	A + 5"
E	A + 2"

A = Belt Width (BW) (1" Increments)
 B = Overall Length (OAL) (Any Increment)
 C = Top of Belt (TOB)
 D = Bed Width
 E = Between Frame (BF)

Additional widths, lengths and heights available per application

CENTER DRIVE

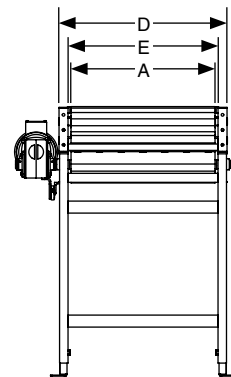
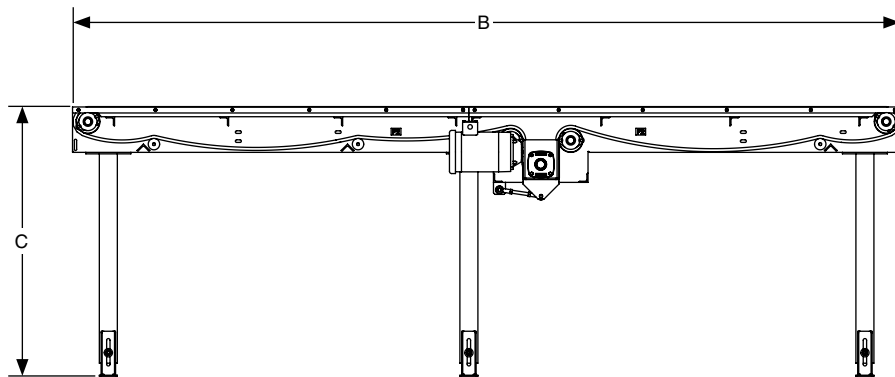

STANDARD SPECIFICATIONS

BELT - Flat top, friction flat top, inline roller top, transverse roller top and flush grid

FRAME - 7 1/2" high x 1 1/2" flange x 10 ga. steel formed channel

BED DESIGN - Evenly spaced vertical steel bars with UHMW wearstrips

CONSTRUCTION - Welded frames and spreaders

BELT WIDTH - 2" to 144" in 1" increments

OVERALL LENGTH - 3' to 100' in any increment

DRIVE STYLE - Shaft mount end drive

SPEED - Up to 300 FPM

MOTOR - 1/2 HP through 5 HP, 1750 RPM, C-face, 208-230-460V/3PH/60Hz, TEFC inverter duty motor

Expanded product parameters available

REDUCER - Sealed, worm gear, C-face

DRIVE SPROCKETS - 6" nominal dia., with square shafting

TAIL SPROCKETS - 4" nominal dia., with square shafting

MOUNTED BEARINGS - Precision, sealed, pre-lubricated, self-aligning, flange mount ball bearing units with cast iron housing

RETURN ROLLERS - 1.9" dia. x .145" wall mild steel tubes, 7/16" spring retained hex axle, non-precision grease packed bearings

TAKE-UP - Screw type take-up assembly

SUPPORTS - Structural or formed channel H-style, welded 8" to 60" from floor to top of belt. Supports are shipped loose.

FINISHES - Powder coat finish standard. Wet spray available.

PLASTIC BELT CONVEYOR - CURVE



A	6" - 24"
B	A x 2.2" Minimum
C	8" - 60"
D	30°, 45°, 60°, 90°, 180° and Special Degree Curves in 1° Increments
E	A x 2

A = Belt Width (1" Increments)
 B = Inside Radius (Application Dependent)
 C = Top of Belt (TOB)
 D = Degree
 E = Tangent

Tangents required, length based on application
 Additional widths and heights available per application

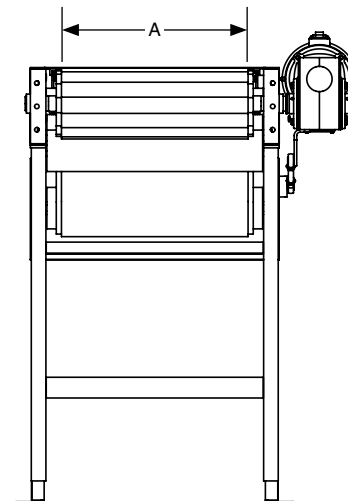
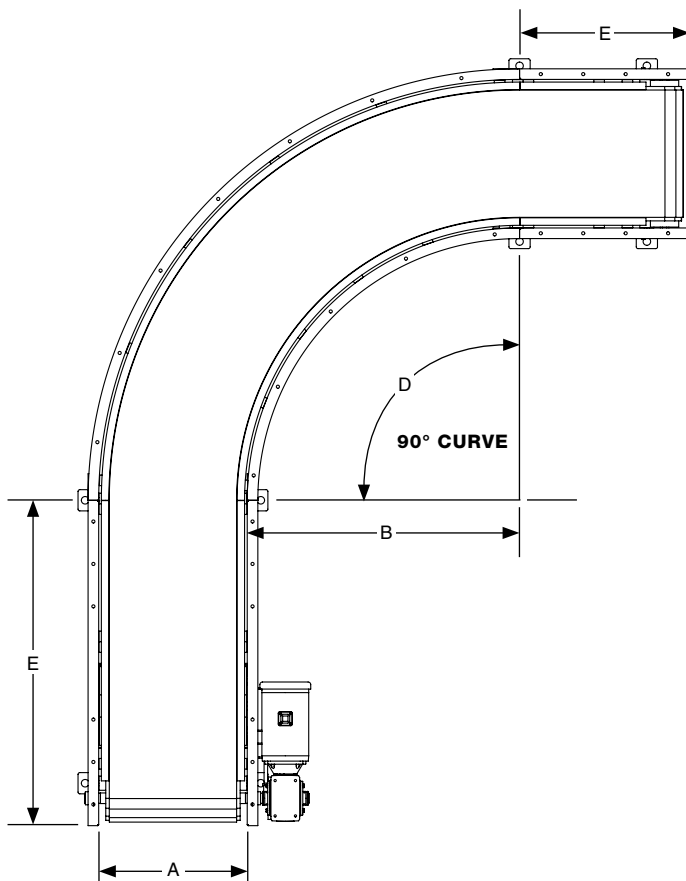

BELT OPTIONS

FLAT TOP

SERIES 400

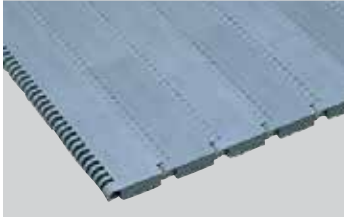

SERIES 400

- Medium pressure accumulation
- Varied product foot print
- Durable belt carcass

SERIES 1000

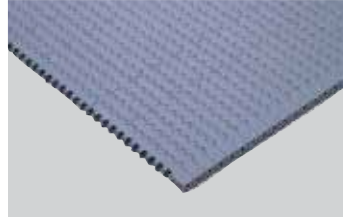

SERIES 1000

- Capable of transfer over 3/4" nosebar
- Superior mini-pitch belt strength
- Medium pressure accumulation

SERIES 900



SERIES 900

- Medium pressure accumulation
- Varied product foot print
- Durable belt carcass

SERIES 1400

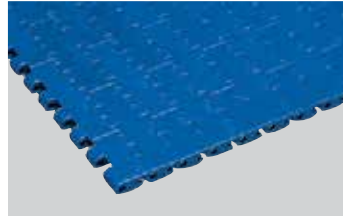

SERIES 1400

- Medium pressure accumulation
- Great for glass applications
- Ideal for container handling applications

FRICTION FLAT TOP

SERIES 900

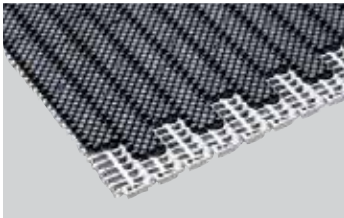

SERIES 900

- Inclines and declines
- Helps maintain product orientation
- Increased grip on product

SERIES 1400

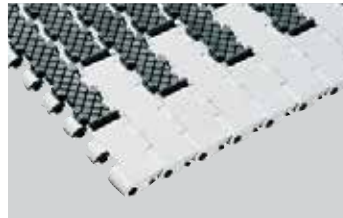

SERIES 1400

- Provides improved product grip
- Permits steeper inclines and declines
- Ideal for heavy duty applications needing additional product grip

FLUSH GRID

SERIES 900

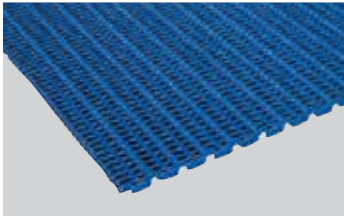

SERIES 900

- Meat and poultry transportation
- Fruit and vegetable transportation
- Washdown applications

SERIES 1400

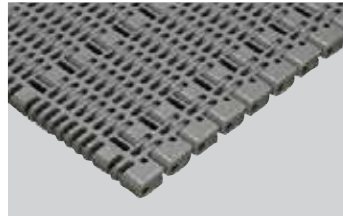

SERIES 1400

- Ideal for carrying medium to heavy loads
- Open design allows for water or small debris to fall through the belt

INLINE ROLLER TOP

SERIES 400



SERIES 400

- Low pressure accumulation
- Available in 2" increments only

TRANSVERSE ROLLER TOP

SERIES 400

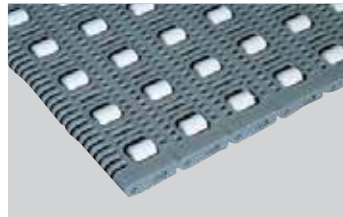

SERIES 400

- 90 degree product transfer
- Tire or package merging
- Available in 2" increments only

RADIUS FLUSH GRID

SERIES 2200



SERIES 2200

- Utilized on curves
- Lightweight, relatively strong belt with smooth surface grid
- Belt openings pass straight through belt, making it easy to clean

SERIES 2400

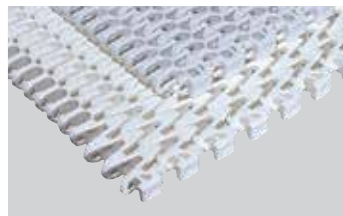

SERIES 2400

- Utilized on curves
- Belt openings pass straight through belt, making it easy to clean
- Sprocket drive system is designed to minimize wear and requires very low return side tension

Other belt types available upon request

OPTIONAL EQUIPMENT AND DEVICES

SIDE GUIDES - Available in fixed or adjustable with multiple contact surfaces. Allows product to be guided and kept in place within the conveying surface. Side guides are bolted to the conveyor frame.

Fixed Angle Side Guides - Standard 2" high or 6" high, 12 ga. formed angle

Adjustable Angle Side Guides - Angle guides typically formed angle, width adjustable

UHMW Lined Fixed Angle Side Guides - Replaceable UHMW face provides wear protection for angle guides

Adjustable Rail UHMW Side Guides - Replaceable UHMW face provides wear protection on rails, width and height adjustable

Skatewheel Side Guides - Vertically mounted skatewheels

Bead Rail Side Guides - Vertically mounted, tightly spaced small wheels supported by axles and a metal channel

Roller Side Guides - Vertically mounted rollers

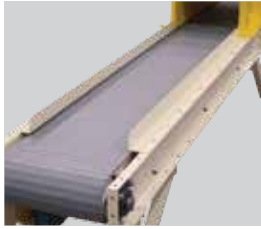

FIXED ANGLE SIDE GUIDES



ADJUSTABLE ANGLE SIDE GUIDES

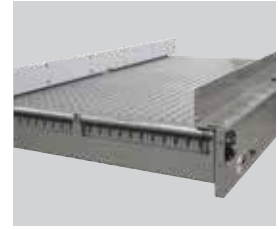

UHMW LINED FIXED ANGLE SIDE GUIDES

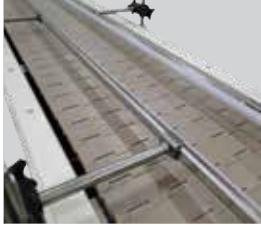

ADJUSTABLE RAIL UHMW SIDE GUIDES

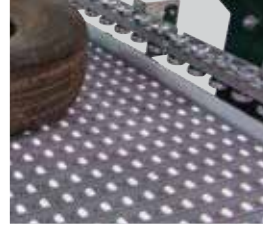

SKATEWHEEL SIDE GUIDES

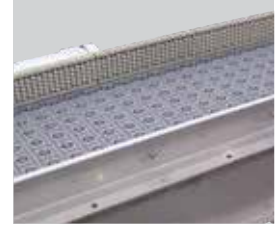

BEAD RAIL SIDE GUIDES

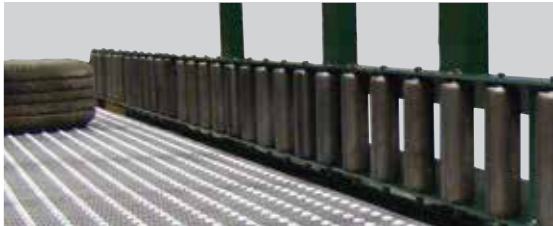

ROLLER SIDE GUIDES

SUPPORTS - Available in single or multi-tier and with caster options for portability. Supports are designed to be bolted to the conveyor frame. Supports are shipped loose.

Multi-Tier Supports

Knee Brace Supports

Portable H-Stands

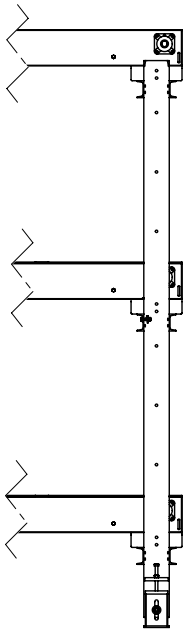

MULTI-TIER SUPPORTS

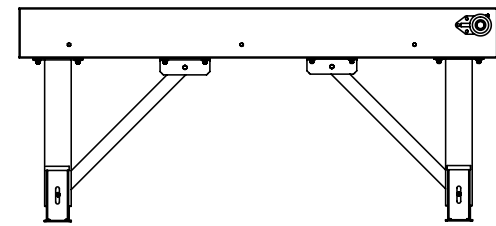

KNEE BRACE SUPPORTS

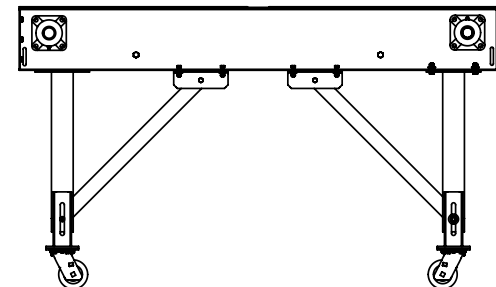

PORTABLE H-STANDS

OPTIONAL EQUIPMENT AND DEVICES

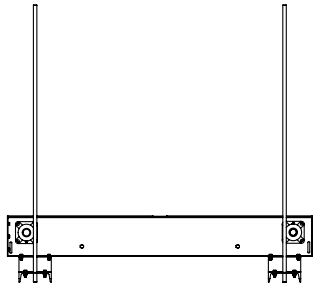

SIDE VIEW

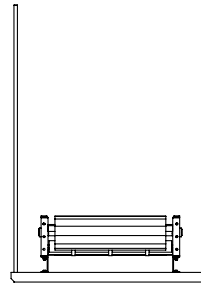

END VIEW

CEILING HANGERS

CEILING HANGERS - Allows conveyor to be suspended from the ceiling. Threaded rod is attached to support steel under the conveyor frame. Ceiling attachments to threaded rod by others. Rods not included.

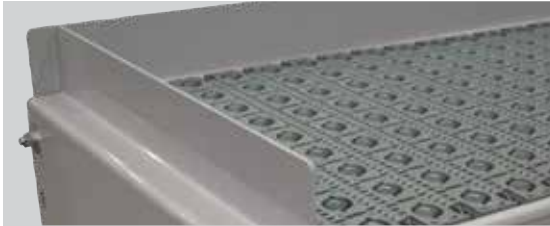

FIXED END STOPS



ADJUSTABLE END STOPS
END STOPS

END STOPS - Allows product to stop at the end of a conveyor line. Fixed and adjustable end stops are available.

Fixed End Stops- Formed or structural steel bolted or welded to end of conveyor with optional structural angle reinforcement. Fixed stops can include fork cut outs for unloading.

Adjustable End Stops - Formed steel adjustable end stop bolted to conveyor frame with manually adjusted stop position. Height is not adjustable.

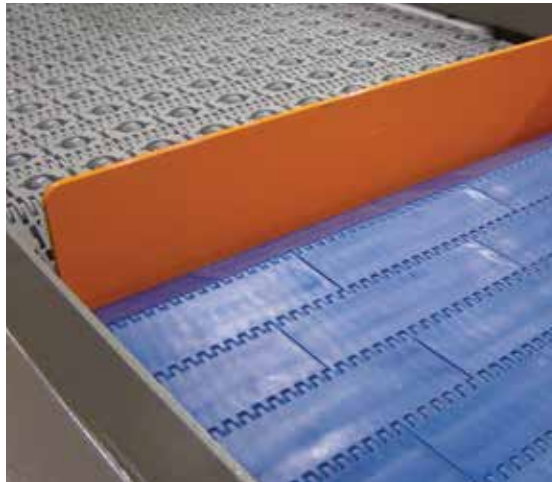

POP-UP BLADE STOPS

POP-UP BLADE STOPS - Pneumatically or manually operated blade stop that pops up between belts in order to accumulate product



CLEATS

CLEATS - Available on horizontal, incline and decline plastic belt conveyor. Available in multiple heights and styles.

STAINLESS STEEL - Conveyors are available in stainless steel materials for washdown applications or harsh environments